

UNIVERSITY OF TORONTO

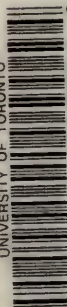

3 1761 01340990 9





Digitized by the Internet Archive
in 2007 with funding from
Microsoft Corporation

THE
CYCLOPÆDIA
OF
ANATOMY AND PHYSIOLOGY.

VOL. III.

LONDON :

MARCHANT SINGER AND CO., PRINTERS, INGRAM-COURT, FENCHURCH-STREET.

THE
CYCLOPÆDIA
OF
ANATOMY AND PHYSIOLOGY.

EDITED BY
ROBERT B. TODD, M. D. F.R.S.

FELLOW OF THE ROYAL COLLEGE OF PHYSICIANS;
PHYSICIAN TO KING'S COLLEGE HOSPITAL; AND
PROFESSOR OF PHYSIOLOGY AND OF GENERAL AND MORBID ANATOMY IN KING'S COLLEGE,
LONDON, ETC. ETC.



VOL. III.
I N S — P L A.

LONDON:
SHERWOOD, GILBERT, AND PIPER,
PATERNOSTER-RROW.

1847.

29/11/06
67800

CONTRIBUTORS.

- ROBERT ADAMS, Esq.**
Surgeon to the Richmond Hospital, and Lecturer on Anatomy and Surgery, Dublin.
- B. ALCOCK, M.B.** Dublin.
- W. P. ALISON, M.D. F.R.S.E.**
Prof. of the Pract. of Med. in the Univ. of Edin. &c.
- JOHN ANDERSON, Esq. M.E.S.** Richmond.
- J. APJOHN, M.D. M.R.I.A.**
Prof. of Chem. to the Royal Coll. of Surgeons, Ireland.
- VICTOR AUDOUIN, M.D. Paris.**
Professeur-Administrateur au Musée d'Histoire Naturelle.
- B. G. BABINGTON, M.D. F.R.S.**
Physician to Guy's Hospital.
- THOMAS BELL, F.R.S.**
Professor of Zoology in King's College, London.
- CHARLES BENSON, M.D. M.R.I.A.**
Prof. of Med. to the Royal Col. of Surgeons, Ireland.
- J. BISHOP, F.R.S.** London.
- JOHN BOSTOCK, M.D. V.P.R.S.** London.
- W. BOWMAN, F.R.S.**
Assistant-Surgeon to the King's College Hospital and the Royal Ophthalmic Hospital, Moorfields, and Demonstrator of Anatomy, King's College, London.
- J. E. BOWMAN, Esq.**
Demonstrator of Chemistry in King's College, London.
- W. T. BRANDE, F.R.S.**
Professor of Chemistry to the Royal Institution, &c.
- J. E. BRENNAN, M.D.**
- G. BRESCHET, M.D.**
Surgeon to the Hotel-Dieu, Paris.
- W. BRINTON, Esq.**
Demonstrator of Anatomy in King's College, London.
- W. B. CARPENTER, M.D. F.R.S.**
Lect. on Physiology at the London Hospital, &c.
- JOHN COLDSTREAM, M.D.** Leith.
Memb. of the Wernerian Nat. Hist. Soc. of Edinb. &c.
- DAVID CRAIGIE, M.D. F.R.S.E.**
Fellow of the Royal College of Physicians, Edinburgh, &c.
- T. BLIZARD CURLING, Esq.**
Lect. on Surg. and Assist. Surg. to the Lond. Hospital.
- G. P. DESHAYES, M.D. Paris.**
- A. T. S. DODD, Esq.**
- H. DUTROCHET, M.D.**
- W. F. EDWARDS, M.D. F.R.S.**
- H. MILNE EDWARDS, M.D.**
Prof. of Nat. History to the College of Henry IV., and to the Central School of Arts and Manufactures, Paris.
- ARTHUR FARRE, M.D. F.R.S.**
Professor of Midwifery in King's College and Physician Accoucheur to King's College Hospital.
- R. D. GRAINGER, F.R.S.**
Lect. on Anat. and Phys. at St. Thomas's Hospital.
- R. E. GRANT, M.D. F.R.S. L. & E.**
Fell. of the Roy. Coll. of Physicians, Edinb. and Prof. of Comp. Anatomy and Zoology in Univ. College, &c. &c.
- W. A. GUY, M.D.**
Prof. For. Med. King's College, London, and Physician to King's College Hospital.
- M. HALL, M.D. F.R.S. L. & E.** London.
- HENRY HANCOCK, Esq.**
Lect. on Anat. and Physiology at, and Surgeon to the Charing-Cross Hospital.
- ROBERT HARRISON, M.D. M.R.I.A.**
Prof. of Anat. and Surg. in the Univ. of Dublin.
- JOHN HART, M.D. M.R.I.A.**
Prof. of Anat. in the Royal Coll. of Surg. Dublin.
- A. HIGGINSON, Esq.** Liverpool.
- ARTHUR JACOB, M.D. M.R.I.A.**
Professor of Anatomy and Physiology to the Royal College of Surgeons in Ireland.
- GEORGE JOHNSON, M.D.**
Assistant Physician to King's College Hospital, and resident Medical Tutor in King's College, London.
- T. RYMER JONES, F.R.S.**
Prof. of Comp. Anat., in King's College, London.
- T. WHARTON JONES, F.R.S.** London.
- T. WILKINSON KING, Esq.**
- SAMUEL LANE, Esq.**
Lecturer on Anatomy, St. George's Hospital, London.
- F. T. MACDOUGALL, Esq.**
- JOHN MALYN, Esq.**
- C. MATTEUCCI.**
Professor of Physics in the University of Pisa.
- ROBERT MAYNE, M.D.**
Lect. on Anat. & Phys. Richmond Hospital, Dublin.
- W. A. MILLER, M.D. F.R.S.**
Professor of Chemistry in King's College, London.
- W. F. MONTGOMERY, M.D. M.R.I.A.**
Fellow of and Professor of Midwifery to the King and Queen's College of Physicians in Ireland.
- GEORGE NEWPORT, F.R.S.**
Vice-Pres. of the Entomological Society of London.
- R. OWEN, F.R.S. F.G.S.**
Hunterian Professor of Comparative Anatomy and Physiology to the Royal College of Surgeons in London.
- JAMES PAGET, Esq.**
Lect. on Anat. & Phys. St. Bartholomew's Hospital.
- RICHARD PARTRIDGE, F.R.S.**
Prof. of Descrip. and Surg. Anat. in King's Coll. Lond.
- BENJAMIN PHILLIPS, F.R.S.** London.
Surgeon to the Westminster Hospital.
- SIMON ROD PITTARD, Esq.** London.
- W. H. PORTER, Esq.**
Prof. of Surgery to the Royal Coll. of Surg. in Ireland.
- J. C. PRICHARD, M.D. F.R.S.**
Corresponding Member of the Institute of France, Member of the Royal Academy of Medicine of Paris.
- G. O. REES, M.D. F.R.S.**
Assistant Physician to Guy's Hospital.
- J. REID, M.D.**
Prof. of Medicine in the University of St. Andrews.
- EDWARD RIGBY, M.D. F.L.S.**
Lect. on Midwifery at St. Bartholomew's Hospital.
- J. FORBES ROYLE, M.D. F.R.S. F.G.S.**
Professor of Materia Medica in King's College, London.
- HENRY SEARLE, Esq.** London.
- W. SHARPEY, M.D. F.R.S.**
Prof. of Anat. and Physiol. in Univ. Coll. London.
- JOHN SIMON, F.R.S.**
Lecturer on Pathology, St. Thomas's Hospital.
- J. Y. SIMPSON, M.D.**
Fellow of the Royal College of Physicians, and Professor of Midwifery in the University of Edinburgh.
- SAMUEL SOLLY, F.R.S.**
Assistant Surgeon to St. Thomas's Hospital.
- GABRIEL STOKES, M.D.**
- J. A. SYMONDS, M.D.**
Physician to the Bristol General Hospital, and Lecturer on the Theory and Practice of Medicine at the Bristol Medical School.
- ALLEN THOMSON, M.D.**
Fellow of the Royal College of Surgeons, and Professor of the Institutes of Medicine in the University of Edinburgh.
- JOHN TOMES, Esq.**
Surgeon-Dentist to the Middlesex Hospital.
- WM. TREW, Esq.**
- W. VROLIK,**
Prof. Anat. and Phys. at the Athenæum of Amsterdam.
- RUDOLPH WAGNER, M.D.**
Prof. of Med. & of Comp. Anat. in the Roy. Uni. Erlangen.
- W. H. WALSHE, M.D.**
Physician to University College Hospital.
- R. WILLIS, M.D.**
- W. J. ERASMUS WILSON, F.R.S.**
Consulting Surgeon to the St. Pancras Infirmary.

CONTENTS OF THE THIRD VOLUME.

	Page		Page
Instinct	1	Muscular System, } Comp. Anatomy	530
Irritability	29	Myriapoda	545
Knee-Joint, Normal } Anatomy	44	Neck, Muscles and } Regions of the..	561
Knee-Joint, Abnormal } Anatomy of the ..	48	Nervous System ..	585
Lacrymal Organs	78	Nerve	591
Larynx, Normal Ana- } tomy	100	Nervous System, } Comp. Anatomy	601
Larynx, Abnormal } Anatomy	114	Nervous Centres, } Normal Anatomy	626
Leg, Regions of.....	126	Nervous Centres, } Abnormal Anat.	712
Leg, Muscles of	137	Nervous System, } Physiology of the	720
Life	141	Ninth Pair of Nerves	721
Liver	160	Nose	723
Luminousness, Animal	197	Nutrition.....	741
Lymphatic & Lacteal } System	205	Oesophagus.....	758
Lymphatic System, } Abnormal Anatomy	232	Optic Nerves	762
Mammalia	234	Orbit	782
Mammary Glands....	245	Organic Analysis ..	792
Marsupialia	257	Osseous System, } Comp. Anatomy	820
Membrane	331	Osseous Tissue	847
Meninges	331	Pachydermata	858
Microscope.....	331	Pacinian Bodies ..	876
Milk	358	Par Vagum.....	881
Mollusca.....	363	Parotid Region	902
Monotremata	366	Parturition.....	904
Motion, Animal, in- } cluding Locomotion	407	Penis	909
Mucus.....	481	Perineum	919
Mucous Membrane ..	484	Peritoneum	935
Muscle	506	Pharynx	945
Muscular Motion	519	Pisces	955

ERRATA IN VOLUME THE THIRD.

- Page 684, col. 2, line 44, *after* "medulla oblongata," *insert* "and the cerebrum."
700, col. 2, line 19, *for* "testes," *read* "nates."
line 20, *for* "nates," *read* "testes."
line 36, *for* "thalami," *read* "thalamus."
708, col. 1, line 10, *for* "distend," *read* "exist."
711, col. 1, line 59, *for* "optic thalami," *read* "hemispheres."
712, col. 2, line 40, *for* "Seinruch," *read* "Steinruch."
line 41, *for* "Hermann, Nasse," *read* "Hermann Nasse."
At page 902, see a list of Errata in the article *PAR VAGUM*.

THE
CYCLOPÆDIA

OF

ANATOMY AND PHYSIOLOGY.

INSTINCT.—This word is often applied to the mental acts of the lower animals, as if it were truly applicable to the whole of these acts; but a little consideration will shew, *first*, that this word, in its more approved and correct acceptation, is applicable only to a *part* of the mental operations, which may be inferred from the observation of the actions and habits of animals; and *secondly*, that in this restricted sense, the term is applicable to a part of the operations of the human mind itself; and that the subject of instinct cannot be thoroughly understood, unless information regarding it is sought in the consciousness of our own minds, as well as in the observation of other living beings. The study of this subject is therefore equally important as a part of natural history, of mental philosophy, and of human physiology; and is a good illustration of the necessity of this latter science being based on the observation and generalization of the laws and conditions of vital action throughout the whole extent of the animal creation.

It is obvious, indeed, that various mental acts, of which we are conscious in ourselves, may be inferred, with perfect confidence, to take place throughout the whole range of the animal kingdom, and even that some of them must be performed with greater energy and precision in some of the lower tribes than in man. The different external senses attain their highest perfection in different animals; that of smell, for example, probably in the predaceous mammalia, that of touch in the antennæ of insects, and that of sight in the predaceous birds; it is not likely that any one is enjoyed in its highest perfection by man; and what have been accurately distinguished from mere

sensations as the *perceptions* of external things, i. e. the notions as to the qualities of these, which naturally present themselves to our minds in consequence of sensations being felt, would seem in various instances to follow the sensations more quickly and more surely in other animals than in us; for it is generally allowed that what appear to be *acquired* perceptions of the eye to us, i. e. the notions of the distance, size, and form of visible objects, are instantaneously made known to many of the lower animals the very first time that those objects make impressions on their retina; the faculty of *Intuition*, which we must admit as part of the source of our own knowledge, appears to exist in greater perfection in other animals, and the notions of external things which they thus acquire are amply sufficient to regulate their muscular motions.

It is equally plain that many of the strictly mental acts, of which our complex trains of thought are composed, are habitually performed by animals; that they have a perfect *recollection* of past sensations, implying the exercise of the powers of memory and of conception; that the *emotions* of fear, of joy, of affection, of anger, even of jealousy, are as distinctly indicated by their actions as by those of man; that under the influence of these emotions their mental operations are excited or depressed, and their attention fixed or distracted, and their volition excited, as in our own case; and that their actions are habitually guided by a clear perception, or rather, we should say, by continual correct applications, of a first principle of belief, which is generally admitted to be an ultimate fact in the constitution of the human mind, and on which much stress has been

laid by our ablest metaphysicians, "the belief of the permanence of the order of nature," or the conviction, "that what has been as an antecedent, will be followed by what has been as a consequent;" otherwise the lessons of experience would be lost upon them, and no change could be effected in their habits by education. Under the influence of this mental law, it is certain that their recollections of past sensations excite in them various desires, and afford motives to action, which prompt many of their movements exactly on the same principle by which the greater number of what are strictly called *voluntary* human actions are determined; the object in view, in both cases, being simply to procure known pleasure or to avoid known pain, and the same metaphysical question presenting itself to the speculative inquirer as to both, viz. the question whether the voluntary power is really to will what we please, or is only to do what we will. Further, the various muscular movements required for any such actions, and the sensations and emotions which excite them, are gradually linked together by the mental principle of the association of ideas, so as to become obedient to the law of Habit in animals equally as in man.

It has been generally admitted, since the time of Locke, that the essential inferiority of the intellect of animals, as compared with that of man, lies in their very limited enjoyment of the faculty of *abstraction*, by which the mind is enabled to single out the different qualities or relations of the individual objects of sense, and make them the subject of *abstract thought*, and thereby form *general notions*, which are at once perceived to be equally applicable to many individual cases; and by help of which it continually elevates itself above the contemplation of individuals, and classifies and methodizes its knowledge, and fits it for useful application,—for the deduction of inferences in reasoning, for the formation of fancied scenes in works of imagination, and for the adaptation of means to ends in practice.

It is obvious, also, that none of those still more general or abstract notions which continually suggest themselves to the human mind in the course of the operations that are excited by the senses, such, for example, as space, time, number, power, &c. are indicated by any manifestations that we see of the mental acts of the lower animals; and it may be stated, in general, that the limitation of their minds to particulars, and the want of the power of raising the thoughts to general ideas, and dwelling on the contemplation of these, is the grand obstacle to their adapting means to ends, drawing inferences from premises, or enjoying the use of language. The objections that have been started to this doctrine do not appear of much weight. Darwin, while he set aside the statement of Locke, endeavoured to distinguish instincts as "actions excited by sensations," employed about the *possession* of pleasurable objects, or the avoiding of painful ones, already in our power, while voluntary (i. e. rational) actions are employed "about the means to acquire such objects." But this distinction appears,

on reflection, to be substantially the same. The two noblest and most characteristic of the faculties of the human mind, as defined by logicians, those of Reasoning and of Imagination, (the latter of which is truly applicable to every kind of *contrivance* or adaptation of means to ends, of which we are capable,) evidently imply the existence of a mental power of forming and dwelling on general ideas, which are equally applicable to many individual cases; and if animals possessed this latter power, we might confidently expect to see them exhibit indications of the two former.

Why is it, for example, that the monkeys, who have been observed to assemble about the fires which savages have made in the forests, and been gratified by the warmth, have never been seen to gather sticks, and rekindle them when expiring? Not, certainly, because they are incapable of understanding that the fire which warmed them formerly will do so again, but because they are incapable of abstracting and reflecting on that *quality* of wood, and that *relation* of wood to fires already existing, which must be comprehended, in order that the action of renewing the fire may be suggested by what is properly called an effort of Reason. Or why is it, that the different classes of predaceous animals, although surrounded by the materials out of which the human race has manufactured so many implements of warfare, have never been able to avail themselves of any of them in aid of the instruments of destruction with which nature has furnished them? Apparently, because they are incapable of forming such general notions of the qualities and relations of external things, as are essential to the processes of imagination and reasoning, by which men are led to the contrivance, and guided in the use, of artificial weapons.

Again, although many of them are susceptible of the emotions of joy, and to a certain degree of gratitude and attachment, founded on the sense and recollection of benefits, none of them seem capable of forming the slightest notion of that Divine Power, which has suggested itself to the human intellect in all ages, and even in the rudest conditions of human existence; we should regard any act of praise or prayer as an infallible indication of a mental capacity of the same rank as our own.

Exceptions to this principle, to a certain extent, must be admitted, as will afterwards appear, and the explanation of some of them is certainly obscure; but the general fact undoubtedly is, that those operations of the human intellect which imply the formation of general or abstract notions, or in the language of Dr. Brown, the suggestion of relations, are beyond the power of the lower animals. Indeed reflection on the nature of language, on the small number of words (only substantive nouns, and only part of these) which apply to individual objects, and on the necessity of the power of forming some kind of abstract or general notion, as indispensable to the use of every other kind of word, is sufficient to establish, and is perhaps the simplest way of distinctly conceiving, the essential difference be-

tween the constitution of the mind of man and of that of the dumb animals.

But it has nevertheless been long observed, that while animals are thus incapable of comprehending the importance or devising means for the attainment of objects which we perceive to be within their reach, and clearly and immediately important to them, they habitually perform many actions which are admirably adapted to the attainment of *certain ends*, and these often remote and obscure, and known to us only by means of repeated observation and reflection, and strictly inductive reasoning. No animals, for example, are capable of such observation and comprehension of the laws of nature, as to procure for themselves at pleasure artificial heat or regular and uniform supplies of food; but many are seen to form nests or burrows, and lay up magazines of provisions, early in the autumn, which are to protect them against cold and famine during the winter; while others, even while the temperature is still mild, undertake long and painful aerial voyages, whereby they escape from the rigours of a northern climate, and enjoy the warmth and abundance of the tropical regions. Such provisions for future contingencies are within the power of man, but in him they are clearly dependent on the power of forming and applying general notions; and if the lower animals possessed that power, we can see nothing to hinder their enjoying the use of language, and might confidently expect to see many indications of *varied* contrivance for their own immediate convenience, which never present themselves to any observer of their habits. The utter absence of intelligence in the *other* actions of animals, corresponding to that which appears manifestly to regulate *certain* actions which accomplish certain definite purposes, is our first reason for believing that, while nature has vouchsafed to man alone the enjoyment of what we call Reason,—the power of comprehending her laws, and so adapting means to ends as to turn these laws to his own advantage,—she has provided for the maintenance of other animals, not only by the circumstances in which she has placed them in the world, but also by imparting to them, on certain occasions, a peculiar mental impulse, urging them to the performance of certain actions which are useful to themselves or to their kind, but the use of which they do not themselves perceive, and their performance of which is a necessary consequence of their being placed in certain circumstances, and often, more particularly, of their feeling certain sensations. And this is the general notion which we attach to the term Instinct.

The term, it must be remembered, stands in opposition, not to the *will*, but to the *reason* of man. The most correct expression of the difference between an action prompted by instinct and one prompted by reason is, that in the first case the will acts in obedience to an impulse which is directly consequent on certain sensations or emotions, felt or remembered; in the last it acts in obedience to an impulse which results from acts of

reasoning and imagination. It is incorrect to say, that all the actions of animals differ from those of man in being performed without anticipation of their effects. Many of the most familiar actions of animals are guided by a perfectly correct anticipation of their consequences, (otherwise they would not be susceptible of training); but it is such an anticipation as implies the exercise only of the faculty of memory. The term Reason is properly applied to the anticipation of those consequences of actions, of which we can be informed only by processes of reasoning and imagination, implying the exercise of the faculty of abstraction, and the formation of general notions or ideas.

In some instances, the instinctive impulse, consequent on a particular sensation or succession of sensations being felt, acts immediately on certain nerves and muscles; and no experience is necessary, in order that the action required, although a complex and difficult one, may be performed with perfect precision, as in the case of the winking of the eye, or shrinking of the arm from injury, or of suction and deglutition following certain impressions on the mouth and throat. These actions seem to be very nearly if not precisely on the same footing as those which have been described by Whytt and others as the natural effects of sensation, and by Dr. Marshall Hall as indications of what he terms the reflex function of the spinal cord,—such as the actions of breathing, coughing, sneezing, vomiting, &c.; and in which the intervention of sensation, although strongly indicated, is not universally admitted.

But in the greater number of cases, the instinctive determination appears to act not directly on the nerves and muscles, but on the train of mental changes which serves as the motive to the exertion of the will; it extends to a long succession of actions, performed by individuals or by societies, each of which takes place under the influence of a mental determination of a permanent character, and is often effected by a succession of voluntary efforts, which may require some habit and experience in order that they may be performed with precision. Thus many animals require some length of experience before they acquire the use of their limbs or of their wings; but having acquired that power, they are taught by instinct to use them for the purpose of flight immediately on feeling certain sensations and emotions. In all such cases the actions are strictly voluntary, although the will acts, as we believe, in obedience to instinct, not to reason; and this seems to be the proper view to be taken of such long-continued and admirably combined actions as we see in the formation of the nests of birds, or of the houses of beavers, or in other instances to be afterwards mentioned. The sensations of these animals, at particular seasons, excite a variety of mental operations, but these operations are all controlled and directed by the desire or propensity to the performance of certain definite actions, whether by the individual alone or in concert with others. In the performance of these ac-

tions, the sensations, the voluntary powers, the memory and instinct of the animals are all brought into play; but we have no reason to believe that the animals performing them are capable of anticipating their ultimate result.

In all cases, those actions which are entitled to the appellation of Instinctive are generally understood to be characterized by two marks, quite sufficient to distinguish them from the effects of voluntary power guided by reason: 1. That, although in many cases experience is required to give the will command over the muscles concerned in them, yet the will, when under the influence of the instinctive determination, acts equally well the first time as the last; no experience or education is required, in order that the different voluntary efforts requisite for these actions may follow one another with unerring precision; and 2. That they are always performed by the same species of animal nearly, if not exactly, in the same manner; presenting no such variation of the means applied to the object in view, and admitting of no such improvements in the progress of life or in the succession of ages, as we observe in the habits of individual men, or in the manners and customs of nations, adapted to the attainment of any particular ends by those voluntary efforts which are guided by Reason. "The manufactures of animals," says Dr. Reid, "differ from those of men in many striking particulars. No animal of the species can claim the invention. No animal ever introduced any new improvement, or variation from the former practice. Every one has equal skill from the beginning, without teaching, without experience or habits. Every one has its art by a kind of inspiration, i. e. the ability and inclination of working in it without any knowledge of its principles." A third distinctive mark, naturally resulting from the last, is at least equally characteristic, although much less generally observable,—that these instinctive actions are seen to be performed in circumstances which reason informs us to be such as to render them nugatory for the ends which are usually accomplished by them, and for which they are obviously designed. The efforts made by migratory birds, even when confined, at their usual period of migration,—the mistake of the flesh-fly who deposits her eggs on the carrion-plant instead of a piece of meat,* or of the hen who sits on a pebble instead of an egg, or of the mule which remains immovably fixed by terror instead of escaping from the flood which threatens to overwhelm it, (as exemplified in the inundation of the valley of Luisnes in Savoy in 1818,) or of the bee which gathers and stores up honey even in a climate where there is no winter,† are so many proofs, that an instinctive action is prompted by an impulse, which results merely from a particular sensation or emotion being felt, not by anticipation of the effect which the action will produce.

* Kirby.

† See Kirby and Spence, Introduction to Entomology, vol. ii. p. 469.

But, in order to have demonstrative proof of the essential difference between instinct and reason, and of the correctness of the view which we take of the nature of that mental impulse which prompts what we call the instinctive actions of animals, it is only necessary to reflect on what passes within ourselves on occasion of certain actions of the very same class being performed by us. It is difficult, indeed, in adult age, to distinguish those actions which we perform instinctively from those which we have learnt by repeated efforts to perform habitually; but in the case of infants we see complex actions, useful or necessary to the system, performed with perfect precision at a time when we are certain that the human intellect is quite incompetent to comprehend their importance or anticipate their effects; yet we cannot doubt that it is by a mental impulse that they are excited, because we perform the same actions in the same circumstances in adult age, and are then conscious of the impulse which prompts them. "It is an instinct," says Bichat, "which I do not understand, and of which I cannot give the smallest account, which makes the infant, at the moment of birth, draw together its lips to commence the action of sucking," to be followed by the still more complex act of deglutition. "This cannot be ascribed to the mere novelty of the sensations which it experiences from external objects, for the general effect of such sensations is to determine various agitations or irregular movements indeed, but not an uniform movement, directed to a determinate end. If we examine different animals at the moment of birth, we shall see that the special instinct of each directs the execution of peculiar movements. Young quadrupeds seek the mammae of their mothers, birds of the order Gallinacæ seize immediately the grain which is their appropriate nourishment, while the young of the Carnivorous birds merely open their mouths to receive the food which their parents bring to their nests. In general, it is very important to distinguish the irregular or varied movements which, at the moment of birth, are produced simply by the new sensations and excitements which the body receives, from those definite actions which are the effect of instinct, a cause of which we can give no further explanation."

In fact, when we attend to the simple action of deglutition,* as performed in our mature years, we may be conscious that it results from the same instinctive impulse which guided it with unerring precision in the new-born infant, long before the voluntary power of simply raising the hand to the mouth had been acquired. If we were to consult only the gratification of our sensations, we should keep any grateful food in the mouth; for when it is swallowed the gratification immediately resulting from it is at an end, and there is no peculiar pleasure attached, in other circumstances, to the mere act of deglutition; but all we can

* [I. e. that part of the act which is dependent on the voluntary movement of the tongue to pass on the food to the isthmus faucium.—ED.]

observe by attention to our own feelings on such occasions is, that while we feel the sensations of hunger and thirst, we feel also a propensity, all but irresistible, to swallow whatever grateful food or drink is in the mouth. This propensity is not only prior to reason, but stronger than reason, and prompts us to action more surely and more energetically than the mere recollection of the effects previously resulting from food or drink taken into the stomach could have done.

If we reflect further, we shall find that there are various other sensations, with which we can feel, in our own persons, that an instinctive impulse is naturally linked. The term Appetite does not express the whole of these, although it is only by referring to the action which it uniformly prompts that an appetite can be distinguished from another sensation. Sympathetic movements, such as breathing, coughing, sneezing, vomiting, &c. are ascribed by Whytt and others to sensations; and laughter, weeping, the expression of feeling in the countenance and features, &c. are strictly referable to emotions of mind, and in the performance of all these actions, a propensity which may be called strictly instinctive, because prior to experience, and independent of reasoning, may be frequently and distinctly felt, and is from the first equally effectual in exciting very complex muscular movements, as the impulse to swallow food in the mouth. We may specify several other kinds or modes of action, which we are all conscious of frequently performing, and which we perform on many occasions in obedience, not to any effort of reason, but to a truly instinctive impulse, naturally consequent on certain sensations or emotions, and felt even in adult age to be independent of, as they are in the infant prior to, any anticipation of remote consequences,—viz.

1. those which are prompted by the instinct of self-preservation, (as the winking of the eyelids when the eyes are threatened with injury, the shrinking of any limb or part of the body which is struck, the projection of the arms when we are about to fall forwards on the face,* the act of crying from pain or from fear);
2. those which are prompted by the instinct of shame, as when the saliva escapes from the mouth, when the sphincters fail in their office, or the sense of modesty is outraged;
3. those which are prompted by the instinct of imitation, existing more or less in the early stage of all human existence, and whereby we are all led to fashion our language, manners, and habits, on the model of those around us, and particularly of those persons with whom we have either the most frequent intercourse, or the intercourse which is most fitted to make an impression on our minds;
4. those which are prompted by the emotions of affec-

tion and pity, or still more decidedly by the impulse of maternal love, on witnessing the helpless condition of young infants.* We do not enter into details on these subjects at present, but merely mention them as examples, in which we may safely and legitimately avail ourselves of the evidence of consciousness to assure ourselves of the essential peculiarity, and of the paramount authority, of the *instinctive impulse*, as distinguished from the *voluntary effort*, which results from a train of reasoning.

It has been often said that the nature of instinct is absolutely mysterious and inscrutable; but if what has now been stated be correct, this can be said of instinct only in the same sense in which it may be said of all mental acts without exception; the essence of mind, like that of matter, being wholly inscrutable. The *characters* of the instinctive impulse may be distinguished as clearly as those of any other mental act, in the only way in which any such act can be distinguished, viz. by attention to our own consciousness; although we never could have anticipated *à priori* that this kind of mental impulse could have extended to so long continued and complex actions, and to the concerted operations of so many individuals, as the operations of some animals indicate.

Having satisfied ourselves of the existence of certain instinctive impulses, both in the lower animals and in ourselves, essentially distinct from those voluntary efforts which are guided by reason, we need not be perplexed at finding that there is much difficulty in some individual instances, in determining to which class of mental acts particular actions ought to be referred. However difficult it may be in any individual instance, to decide whether an action, of man or of animals, is the effect of a blind instinct, or of reason, anticipating and desiring its consequences, there can be no doubt or difficulty as to the fact, that these two distinct kinds of mental determination to the performance of actions exist.

Neither do we consider it of any importance to enter on the metaphysical speculations which ingenious men have hazarded at different times as to the nature of the agent, by which the instinctive actions may be supposed to be immediately excited. Some philosophers have been so strongly impressed with the admirable adaptation of means to ends which these phenomena present, in animals manifestly devoid of reason, that they have believed them to be in all cases the immediate offspring of the divine intelligence, and have expressed their theory in the form of an axiom, "*Deus anima brutorum*," which, it is humbly conceived, is admissible only in the same sense in which we assent to the more general assertion, "*Deus anima mundi*."

Mr. Kirby, in his very learned and elaborate Bridgewater Treatise on the History, Habits, and Instincts of Animals, seems to favour the

* Let any one try the experiment of attempting to fall forward on his face, with his arms extended at his sides, and he will be immediately conscious of the instinctive impulse which urges him to throw forward his arms; and which he feels distinctly and resists with difficulty, even when he knows that he is about to fall only on soft matter which cannot injure him.

[* The greater number of the actions enumerated may, however, be accounted for on the principle of reflex nervous action, now so generally admitted by physiologists.—ED.]

idea which other philosophers have maintained, of *intermediate agents* between the Divine will and the living beings on earth, by which the actions of the latter are guided;* but in prosecuting this idea he is disposed to regard the proximate cause of instinct, as he expresses it, not as metaphysical, but merely as physical, and to suppose that "light, heat, and air, or any modification of them" may be the intermediate agents "employed by the Deity to excite and direct animals, when their intellect cannot, in their instinctive operations;" and that "the organization of the brain and nervous system may be so varied and formed by the Creator as to respond in the way that he wills, to pulses upon them from the physical powers of nature."†

On this it may be observed that this last sentence expresses no more than the truth, whatever opinion we may form as to the mode, in which the response of the nervous system of an animal to the impressions made on it by physical agents takes place; but if it be meant by the expression, that the proximate cause of instinct is probably not metaphysical but physical, to exclude all mental operation, and all consciousness of effort, from the instinctive actions of animals, we can regard the theory only as a denial of all mental acts or affections in any of the lower animals, and as easily contradicted by the whole analogies of their structure, by observation of their habits, and by the evidence of our own consciousness in the performance of those precisely similar instinctive actions which have been noticed above.

It seems quite unreasonable to doubt that the immediate cause of all the actions that we call instinctive, is a strictly *mental effort*, but the occurrence of that effort in every case when it is required must in all probability be always held as an *ultimate fact* in the animal economy; and all speculations as to its intimate nature or proximate cause may be regarded as mere conjectures, on a subject which is beyond the reach of the human faculties. Nor would any thing be gained, in the inference as to final causes, from establishing any one of these conjectures; for the mental constitution of man himself, and of the whole lower animals, is equally a part of the contrivance of the Divine Artificer of the world, as the laws of motion or the properties of light. He who could make man after his own image could assuredly impart such mental propensities to other beings, as well as to man, as were necessary for the ends for which the creation was designed. And when we attempt, in all humility, but at the same time in confident reliance on the mental powers which He has vouchsafed to us, to draw inferences as to His existence and attributes from the study of created things, we do so, not by vainly attempting to comprehend the *nature* of the energy by which any of the changes (physical or mental) occurring around us are effected, but simply by observing the *adaptation of means to ends* in those regular and uniform laws which we are

enabled to infer from the observation of such changes,—which we ascribe to His authority, and beyond which we feel that it is not yet given us, by any exercise of our minds, to ascend. In enabling us to draw those inferences, the instincts of animals, as we shall afterwards state, are of peculiar importance; but the inferences are the same, whatever opinion we may adopt as to the mode in which the Divine Intelligence so indicated rules the wills of the animal creation.

Having said so much of the characteristics of this class of phenomena, and endeavoured to set them in the proper point of view, we shall next offer a very rapid sketch of the varied instincts exhibited in the different tribes of animals, arranging them simply according to the purposes which they seem destined to serve, and shall conclude with a few general reflections.

It may be premised that it certainly seems reasonable *à priori* to suppose, that the structure of the nervous system, and especially of the brain, of different animals, will bear some relation to the kind of instinctive propensities which they exhibit. In the size of the sensitive and motor *nerves*, and portions of the cerebro-spinal axis whence these originate, particularly the spinal cord, medulla oblongata, and optic lobes (or corpora quadrigemina), in the higher animals, this relation may be distinctly perceived; and it has been further confidently stated by some phrenologists, that strong evidence of certain of their peculiar doctrines may be deduced from observation of the size and form of the brains of animals, as compared with their instincts; but this last speculation certainly cannot be carried further than the vertebrated animals, which form but a small part of the living beings that are continually guided and ruled by the laws of instinct; and even in them no such relation of the size and form of the brain, or of any part of the brain, to the general intelligence of an animal, or to any particular instinct, has been fully ascertained. Indeed, until some such essential difference shall be observed between the habits and instincts of the dolphin, or other cetaceous animals, and the predaceous fishes, as may correspond to the extraordinary difference of the size and structure of their brains, (that of the former being much larger in proportion to the spinal cord than the human brain, and of complex structure, while that of the latter is not larger than the optic lobes or corpora quadrigemina of the same animal, and of very simple structure,) such speculations may be safely distrusted.*

Mr. Kirby has stated that the principal instincts of animals may be referred to three heads; those relating to their food, those relating to their propagation and the care of their offspring, and those relating to their hibernation. But this enumeration is certainly defective, and indeed will hardly include several which

* We cannot suppose this difference to be connected with the difference in the mode of respiration of these animals, because we know that the only part of the central masses of the nervous system of either, concerned in that function, is the medulla oblongata.

* See vol. ii. p. 243-4.

† Vol. ii. p. 255-6.

he has himself accurately described. The following appears a more comprehensive enumeration. Three great classes of instinctive actions may be distinguished; the first designed for the preservation of individuals; the second for the propagation and support of their offspring; and the third for various purposes important either to the race of animals exhibiting them, or to other animals, but not distinctly referable to either of the former heads.

Each of these classes admits of obvious subdivisions.

I. *Of instincts designed for the preservation of the individuals exhibiting them, we may enumerate the following:—*

1. All animals are endowed with instincts prompting them to some means of escaping or repelling injury or violence, but these are exceedingly various, both as to the kind and as to the degree of complexity of the actions which they excite; from the simple retraction of the tentacula of the infusory *Vorticella*, or of the *Medusa*, *Polype*, or *Actinia*, up to the active and formidable resistance of the elephant or the tiger. The most common instinct of self-preservation excited by the emotion of fear, is that which prompts to flight, an instinct so obviously existing in the human species, that the effort by which it is resisted has in all ages been regarded with respect; and another very common propensity in animals is that which prompts to concealment. This is often combined with flight, as in most of the Carnivorous Mammalia, the Rodentia, the Cæteacea, the diving birds, reptiles, insects, &c.; but some of the higher animals, and many of the Mollusca and insects, and others of the lower tribes, remain quite motionless and counterfeit death when under the influence of fear;* and it is remarkable that when the circumstances of the animals render this mode of defence the most effectual, it is that adopted, in preference to flight, even by single species of families, the other members of which shew no such instinct, as in the case of the ptarmigan, which so frequently covers among the grey lichen, or the snow on the mountain-tops, instead of taking wing like the moor fowl, or in that of the hedge-hog, which on occasion of any imminent danger makes no effort but that of coiling itself into a ball.

In many instances the instinct either of flight or concealment is aided by very various special contrivances, equally instinctive, fitted either to deceive, or to alarm, or injure an assailant. Some even of the Mollusca, and some of the reptiles, as the toad, squirt water on him; many reptiles and some lower animals, as the scorpion, bee, wasp, &c., even some of the gelatinous radiata,† have the power of emit-

ting irritating matter of greater or less intensity; the electrical animals, as the gymnotus and torpedo, use their appointed weapons; the hedge-hog and porcupine oppose their sharp thorns to any one who attempts to molest them; many insects and some reptiles protect themselves by emitting peculiarly fetid effluvia; the cuttle-fish tribe have the remarkable power of emitting an inky fluid which darkens the water and hides them; and on the other hand there is reason to believe that the phosphorescent light which so many marine animals exhibit, may be suddenly augmented on occasion of any threatening of injury, and serve as a means of defence.* (See LUMINOUSNESS.) The means of defence, and the instincts guiding them, in the case, not only of the higher Carnivorous animals, but many of the stronger of the Herbivorous classes, the elephant, the hog, the horse, the buffalo, the deer, &c. require no illustration.

The instinct which prompts many animals to utter cries when injured or threatened, (as well as on other occasions and for other purposes,) deserves notice as a means of protection, particularly on this account, that as it is one of the instincts which most clearly extends to the human race, so we may perceive in man, as well as in some of the lower animals, that its use is not merely to frighten assailants, but especially to procure assistance and protection for the young animal from its parents.

2. The most conspicuous and most remarkably varied of the instincts under this head are those by which the food of different animals is procured. With the exception of the sponges, and some others of the lowest Zoophyta, in which the nourishment is supplied by currents, all animals have organs corresponding to a mouth and stomach, into which aliments are taken by a process of deglutition, implying sensations and instinctive efforts consequent on these; and in the Articulata and Mollusca, the most important central organ of the nervous system seems to be the nervous collar surrounding the œsophagus, which in the vertebrated animals seems to be developed and subdivided into the first, fifth, and part of the eighth pairs of nerves, with the corresponding portions of the cerebro-spinal axis, by which the sensation of hunger is felt, the suitable nourishment discriminated, and the instinctive effort, whether of deglutition only, or of mastication more or less powerful according to the food, is excited.

In some instances subsidiary instincts are also implanted in certain animals, which are essential to their digestion and nutrition. The art of cookery, as universally practised by the human race, may be said to be the result of experience; but this cannot be said of the propensity of many animals to swallow salt, still less of the swallowing of gravel or pebbles by the graminivorous birds, or of the copious draughts of water, sufficient to store the numerous and peculiar cells of their first and second stomachs, which are taken by the camel

* "In this situation, spiders will suffer themselves to be pierced with pins and torn to pieces, without discovering the smallest sign of pain. This simulation of death has been ascribed to a strong convulsion or stupor occasioned by terror; but this solution of the phenomenon is erroneous. If the object of terror is removed, in a few seconds the animal runs off with great rapidity."—*Duncan on Instinct.*

† Kirby, vol. i. p. 198.

* *Ibid*, vol. i. p. 178.

or llama before they enter on the deserts, and which enable them subsequently to subsist without water for many days.

But the instincts by which animals are enabled to search for and obtain food may be easily supposed to be much more numerous and varied than those by which they merely seize and swallow it, and in fact furnish the conditions by which the varieties of the whole structure of animals are chiefly determined. Probably the greatest number of animals are nourished by the vegetable world in the living or dead state, and are continually guided by sensations, to which instinctive efforts are attached,—i. e. by appetites,—in the selection of food, which may in general be found and seized without much difficulty. But throughout the whole animal kingdom, from the microscopic animalcules up to the largest of the Mammalia, a very great number of carnivorous animals are found, who subsist on, and continually repress the numbers of, the herbivorous tribes; and it may easily be supposed that the instincts implanted in these animals, which oppose and counteract the varying efforts at self-preservation already mentioned, will be more varied, and bear more marks of contrivance and ingenuity. Accordingly, from the numerous Vorticellæ, or other animalcules, of the order Rotatoria, which excite currents in the water around them, and so attract into their stomachs many of the smaller animalcules, up to the lion, the whale, or the eagle, we find an infinite number of contrivances and instinctive propensities, served by organs, by which the predaceous animals, of all the orders, are enabled to prey on the others. The Polype, Echinus, and Actinia, for example, among the Zoophyta, seize their prey, as it is brought to them by the waves, with their numerous tentacula; the Entozoa, and the leech and other of the Annelides, have the faculty and the necessary instinct of attaching themselves to the larger animals in the situations which suit them, as the Cirrhipedes or barnacles do to vegetable substances. The cuttle-fish and other predaceous Mollusca have legs furnished with admirably constructed suckers and powerful jaws, and most of the Crustacea have claws and mandibles, sufficient to enable them to seize and destroy marine animals of very considerable size; and it is unnecessary to enlarge on the powerful means of destruction, or on the instincts guiding their use, which are seen in many genera of each of the classes of vertebrated animals. There is often a peculiar instinct guiding each of the Carnivorous Mammalia to the part of the body of its victim where it can most easily inflict a mortal wound, to the throat in the case of a large animal, to the head in that of a small one, of which the cranium may be pierced. In the greater number of them, however, the instinctive actions by which their prey is obtained are distinguished only by power and violence; and although much contrivance is employed for adapting the different parts of the structure to the habits and destination of the animals, there is little apparent

ingenuity in the modes in which the animals perform their office in creation. The attitude and gesture of the cat, the pointer, or the tiger, “slow stealing with crouched shoulders on his prey,” is an example of instinctive contrivance preliminary to the act of violence. The aspect and expression of many carnivorous animals,—not only of the Mammalia and birds, but of the shark, the cuttle-fish, the scorpion, the tiger-beetle, &c., are so adapted to the feelings and instincts of the animals on which they feed, as often to deprive them of the power of flight or resistance; and it is maintained by many, that some of the predaceous animals have the power of fascinating their prey by merely fixing their eyes on them. Many have ascribed this power to the serpent; and Mr. Kirby asserts it with confidence of the fox.* A few only of the predaceous animals, as the dog and wolf, have the instinct of associating together for procuring their prey. It has been stated that the pelican and the dog-fish have a similar instinct.†

But the more striking indications of contrivance in the actions prompted by this instinct are to be found in some of the less powerful of the carnivorous tribes. The *Lophius Piscatorius* or fishing-frog, although a large fish, having no strength or speed, obtains its prey by stratagem, plunging itself in mud, or covering itself with sea-weed: “it lets no part of it be perceived except the extremity of the filaments that fringe its body, which it agitates in different directions, so as to make them appear like worms. The fishes, attracted by this apparent prey, approach and are seized by a single movement of the fishing-frog, and swallowed by his enormous throat, and retained by the innumerable teeth by which it is armed.”‡ A still more singular art is practised by the *Chætodon rostratus*, which feeds on flies, and, as Sir Charles Bell states, actually takes aim at them, and shoots them with a drop of water.§ The instinct of the myrmecophaga or ant-eater, which protrudes the tongue to allure flies to settle on it, and then suddenly retracts it to devour them, also deserves notice. A more complex art is practised by the ant-lion, which digs a pitfall in the track usually followed by ants, and conceals itself in the bottom of it, waiting for its prey. But of all contrivances in the animal creation for procuring food, the most complex and artificial are those of the different genera of spiders, equally curious on account of the peculiar organs by which they spin their webs, as of the peculiar and varied instincts by which they are guided in using them.|| For example, “any common black and white spider (*Salticus Scenicus*), which may always be seen in summer on sunny rails, &c., when it spies a fly at a distance, approaches softly, step by step, and seems to measure his distance from it by the eye; then if he judges that he is within reach, first fixing

* Vol. ii. p. 269.

† See Darwin's *Zoon*. vol. i. p. 229, 249.

‡ See Kirby, vol. ii. p. 406, and pl. xiii.

§ *Bridgewater Treatise*, p. 200.

|| See Kirby, vol. ii. p. 184 and 286.

a thread to the spot on which he is stationed, by means of his fore feet, which are much larger and longer than the others, he darts on his victim with such rapidity, and so true an aim, that he seldom misses it. He is prevented from falling by the thread just mentioned, which acts as a kind of anchor, and enables him to recover his station."* Again, the kind of spider that has received the name of Geometric, "having laid the foundation of her net, and drawn the skeleton of it, by spinning a number of rays, converging to a centre, next proceeds, setting out from that point, to spin a spiral line of unadhesive web, like that of the rays, which it intersects, and after numerous circumvolutions finishes this at the circumference. This line, in conjunction with the rays, serves as a scaffolding for her to walk over, and also keeps the rays properly stretched. Her next labour is to spin a spiral or labyrinthiform line from the circumference towards the centre, but which stops somewhat short of it; this line is the most important part of the snare. It consists of a fine thread, studded with minute viscid globules, like dew, which by their viscid quality retain the insects which fly into the net. The snare being thus finished, the little geometrician selects a concealed spot in the vicinity, where she constructs a cell, in which she may hide herself and watch for game; of the capture of which she is informed by the vibrations of a line of communication, drawn between her cell and the centre of her snare."†

3. Many animals are guided by instinct to form habitations for themselves, of very various kinds, for protection against injury and against cold, from the simple contrivance of the earth-worm, which closes the orifice of its hole with leaves or straw, up to the elaborate structures of the bee, the ant, or the beaver. Here we observe a singular but easily understood difference between the inhabitants of water and air. The greater number of the more delicate animals that inhabit the sea, chiefly of the Mollusca and Crustacea, are provided by nature with shells, or very firm integuments, evidently for protection against the violence of the waves, in the formation of which instinct has little or no share; but there are some of the Annelides inhabiting water, as the Sabella and Terebella, and the larvæ of some moths, which have a singular instinct enabling them to form habitations sufficient for their own protection, "by collecting grains of sand and fragments of decayed shells, &c. which they agglutinate together by means of a viscid exudation, so as to form a firm defensive covering, like a coat of mail." This may be stated as the intermediate link between the habitations given to the Mollusca and Crustacea by nature, and those which many land animals have organs and instincts enabling them to form for themselves.

"The manœuvres of the terebella are best observed by taking it out of its tube and placing

it under water upon sand. It is then seen to unfold all the coils of its body, to extend its tentacula in every direction, often to a length exceeding an inch and a half, and to catch, by their means, small fragments of shells and the larger particles of sand. These it drags towards its head, carrying them behind the scales which project from the anterior and lower part of the head, where they are immediately cemented by the glutinous matter which exudes from that part of the surface. Bending the head alternately from side to side, while it continues to apply the materials of its tube, the terebella has very soon formed a complete collar, which it sedulously employs itself to lengthen at every part of the circumference with an activity and perseverance highly interesting. For the purpose of fixing the different fragments compactly, it presses them into their places with the erected scales, at the same time retracting the body. Hence the fragments, being raised by the scales, are generally fixed by their posterior edges, and thus, overlaying each other, often give the tube an imbricated appearance.

"Having formed a tube of half an inch or an inch in length, the terebella proceeds to burrow; for which purpose it directs its head against the sand, and contracting some of the posterior rings, effects a slight extension of the head, which thus slowly makes its way through the mass before it, availing itself of the materials which it meets with in its course, and so continues to advance till the whole tube is completed. After this has been accomplished, the animal turns itself within the tube, so that its head is next the surface, ready to receive the water which brings it food, and is instrumental in its respiration. In summer the whole task is completed in four or five hours; but in cold weather, when the worm is more sluggish, and the gluten is secreted more scantily, its progress is considerably slower."*

The habitation formed by the water-spider, which is not exposed to the violence of the sea, shews much greater delicacy of workmanship, as well as greater variety of instinct.

"The insects that frequent the waters," says Kirby, "require, as well as those that inhabit the earth, predaceous animals to keep them within due limits, and the water-spider is one of the most remarkable on whom that office is imposed by the Creator. To this end her instinct instructs her to fabricate a kind of *diving-bell*, for which purpose she usually selects still waters. Her house is an oval cocoon filled with air, and lined with silk, from which threads issue in every direction, and are fastened to the surrounding plants; in this cocoon, which is open below, she watches for her prey, and even appears to pass the winter, when she closes the opening. It is most commonly entirely under water, but its inhabitant has filled it with air for respiration, by which she is enabled to live in it. She conveys the air in the following manner: she usually swims upon her back, when her abdomen is enveloped in a

* Kirby, vol. ii. p. 298.

† Ibid. p. 295. See also Darwin's Zoon, vol. i. p. 253.

* Roget's Bridgewater Treatise, vol. i. p. 279.

bubble of air, and appears like a globe of quicksilver; with this she enters her cocoon, and displacing an equal mass of water, again ascends for a second lading, till she has sufficiently filled her house with it, so as to expel all the water. The males construct similar habitations by the same manœuvres. How these little animals can envelope their abdomen with an air-bubble, and retain it till they enter their cells, is still one of Nature's mysteries that have not been explained."

We need say nothing of the habitations formed by solitary animals of the higher tribes, chiefly by burrowing under ground, for their own protection and comfort; but the most curious of such solitary habitations on the earth's surface are also furnished by the tribe of spiders.

"Some species of spiders, M. Audouin remarks, are gifted with a particular talent for building: they hollow out dens; they bore galleries; they elevate vaults; they build, as it were, subterranean bridges; they construct also entrances to their habitations, and adapt doors to them, which want nothing but bolts, for without any exaggeration, they work upon a hinge and are fitted to a frame. The interior of these habitations is not less remarkable for the extreme neatness which reigns there; whatever be the humidity of the soil in which they are constructed, water never penetrates them; the walls are nicely covered with a tapestry of silk, having usually the lustre of satin, and almost always of a dazzling whiteness.

"The habitations of the species in question are found in an argillaceous kind of red earth, in which they bore tubes about three inches in depth and ten lines in width. The walls of these tubes are not left just as they are bored, but are covered with a kind of mortar, sufficiently solid to be easily separated from the mass that surrounds it." "The door that closes the apartment is still more remarkable in its structure. If the well were always open, the spider would sometimes be subject to the intrusion of dangerous guests. Providence has therefore instructed her to fabricate a very secure trap-door which closes the mouth of it. To judge of this door by its outward appearance, it appears to be formed of a mass of earth coarsely worked, and covered internally by a solid web, which would be sufficiently wonderful for an animal that seems to have no special organ for constructing it; but when divided vertically, it is found to be a much more complicated fabric than its outward appearance indicates, it being formed of more than thirty alternate layers of earth and web embossed, as it were, in each other, like a set of weights for small scales.

"If these layers of web are examined, it will be seen that they all terminate in the hinge, so that the greater the volume of the door the more powerful is the hinge. The frame in which the tube terminates above, and to which the door is adapted, is thick, arising from the number of layers of which it consists, and which seem to correspond with those of the door; hence

the formation of the door, the hinge, and the frame, seem to be a simultaneous operation; except that in fabricating the first, the animal has to knead the earth as well as to spin the layers of web. By this admirable arrangement these parts always correspond with each other, and the strength of the hinge and the thickness of the frame will always be proportioned to the weight of the door.

"The interior surface of the cover to the tube is not rough and uneven like its exterior, but perfectly smooth and even like the walls of the tube, being covered with a coating of white silk, but more firm, and resembling parchment, and remarkable for a series of minute orifices placed in the side opposite the hinge, and arranged in a semicircle; there are about thirty of these orifices, the object of which, M. Audouin conjectures, is to enable the animal to hold her door down in any case of emergency against external force, by the insertion of her claws into some of them."*

But the most extraordinary habitations formed by the instincts of animals are those which are the joint result of the labours of communities; and here we observe the same difference as has been already noticed, between the inhabitants of the air and of the ocean. Many of the animals that inhabit the latter are formed by nature, as Mr. Kirby expresses it, (and evidently with a view to the rude shocks to which they are exposed,) "into a body politic, consisting of many individuals, separate and distinct as inhabiting different cells, but still possessing a body in common, and many of them receiving benefit from the systole and diastole of a common organ; thus by a natural union is symbolized what in terrestrial animal communities results from numerous wills uniting to effect a common object. The land, as far as I recollect, exhibits no instance of an aggregate animal, nor the ocean of one which, like the beaver, lemming, bee, wasp, &c. forms associations to build and inhabit a common house."†

And there is a curious family, named *Salpa*, in which the individuals are attached to each other almost like bees in their cells at birth, and are afterwards separated when they have acquired strength; thus forming the link between the aggregated sea animals (such as *Corals*, *Madrepores*, *Sertularia*, *Flustra*, &c.) and the associated land animals.

The habitations that are formed by animals of the latter description, although in very different parts of the scale of beings, afford equally curious evidence of skill and contrivance, and of the wills of numerous individuals, bound together by a common instinct, as surely as the materials of which the aggregate animals are composed. Take, for example, the houses of beavers.

"Beavers set about building some time in the month of August: those that erect their habitations in small rivers or creeks in which the water is liable to be drained off, with wonderful sagacity provide against that evil by

* Kirby, vol. ii. p. 287, et seq.

† Kirby, vol. i. p. 222.

forming a dike across the stream, almost straight where the current is weak, but where it is more rapid, curving more or less, with the convex side opposed to the stream. They construct these dikes or dams of the same materials as they do their lodges, viz. of pieces of wood of any kind, of stones, mud, and sand. These causeways oppose a sufficient barrier to the force both of water and ice; and as the willows, poplars, &c. &c. employed in constructing them often strike root in it, it becomes in time a green hedge in which the birds build their nests.

“By means of these erections the water is kept at a sufficient height, for it is absolutely necessary that there should be at least three feet of water above the extremity of the entry into their lodges, without which, in the hard frosts, it would be entirely closed. This entry is not on the land side, because such an opening might let in wild animals, but towards the water.

“They begin to excavate under water at the base of the bank, which they enlarge upwards gradually, and so as to form a declivity, till they reach the surface; and of the earth which comes out of this cavity they form a hillock, with which they mix small pieces of wood and even stones; they give this hillock the form of a dome from four to seven feet high, from ten to twelve long, and from eight to nine wide. As they proceed in heightening, they hollow it out below, so as to form the lodge which is to receive the family. At the anterior part of this dwelling, they form a gentle declivity terminating at the water, so that they enter and go out under water.

“The interior forms only a single chamber resembling an oven. At a little distance is the magazine for provisions. Here they keep in store the roots of the yellow water-lily, and the branches of the black spruce, the aspin, and the birch, which they are careful to plant in the mud. These form their subsistence. Their magazines sometimes contain a cart-load of these articles, and the beavers are so industrious that they are always adding to their store.”*

The nests so admirably constructed by what have been called the perfect societies of insects, the white ants or termites, the ants or formicæ, the bees, wasps, and humble bees, are well known, and have been often described. The materials used by the two first genera are chiefly clay, with bits of straw or wood, cemented by animal secretions; the bees manufacture wax for the purpose.

“The wasps and hornets are remarkable for the well-known curious papier-maché edifices, in the construction of which they employ filaments of wood, scraped from posts and rails with their own jaws, mixed with saliva, of which the hexagonal cells in which they rear their young are formed, and often their combs are separated and supported by pillars of the same material; and the external walls of their nests are formed by foliaceous layers of their ligneous paper.”†

“The tree-ants, again, are remarkable for forming their nests on the boughs of trees of different kinds; and their construction is singular, both for the material and the architecture, and is indicative of admirable foresight and contrivance; in shape they vary from globular to oblong, the longest diameter being about ten inches, and the shortest eight. The nests consist of a multitude of thin leaves of *cow-dung*, imbricated like tiles upon a house, the upper leaf formed of one unbroken sheet covering the summit like a skull-cap. The leaves are placed one upon another in a wavy or scalloped manner, so that numerous little arched entrances are left, and yet the interior is perfectly secured from rain. They are usually attached near the extremity of a branch, and some of the twigs pass through the nest. A vertical section presents a number of irregular cells, formed by the same process as the exterior. Towards the interior the cells are more capacious than those removed from the centre, and an occasional dried leaf is taken advantage of to assist in their formation. The nurseries for the young broods in different stages of development are in different parts of the nest.”*

What is most peculiar in the habitations of all these “perfect societies of insects,” is the formation, by the same working members of these societies, of cells of different size and form, suited for the different classes or ranks of individuals which, as we shall afterwards state, each of these associations comprises; and the occasional alteration of the size and form of the cells, when circumstances occur, which will be afterwards mentioned, to make an alteration of their destination advisable.

There are other examples among insects, of imperfect societies or associations, found temporarily and during the larva state only, which unite in forming tents under which they feed, and which shelter them from sun and rain. This is done by the larvæ of several species of butterfly and moth.†

4. The next instincts which may be noticed under this head are those connected with the *hibernation* of animals; for in almost every case in which this faculty (which is found so generally in the lower tribes, particularly reptiles and insects, as well as in the order Cheiroptera and several others of the higher animals,) exists, there is attached to it some instinctive propensity, prompting the animal, even although it be not one of those which form houses for themselves, at least to search for some suitable residence in which it may be sheltered during the winter, whether under ground, under stones or timber, under the bark of trees, &c.; and it is very remarkable that their hiding places are often found, or formed, long before the weather has become very cold. “I am led to believe from my own observation,” says Mr. Spence, “that the days which the majority of coleopterous insects select for retiring to their hybernacula are some of the warmest days of autumn, when

* Kirby, vol. ii, p. 510.

† Kirby, loc. cit. p. 335.

* Ibid. p. 340.

† Spence and Kirby, vol. ii. p. 21.

they may be seen in great numbers alighting on walls, rails, path-ways, &c.* Some insects, and many larvæ (as the silk-worm) approaching to the state of pupæ, form a covering for themselves by exudations from their own bodies, likewise at some distance of time before the frosts set in. Many hibernating animals exhibit so little of any vital action as to require little or no nourishment during the winter, excepting the product of absorption of their own fat; but it is also well known that many of different orders (as the beaver, the hedgehog, the squirrel, the dormouse, the bee, which are seldom or never quite torpid,) are guided by instinct to lay up stores of provisions, on which they subsist during the winter. Some of these, as the lemming, have been observed to spread out their stores to dry in fine weather. Some of the most curious of the provisions of this kind are the following:—

“There is an animal, the *rat-hare*, which is gifted by its Creator with a very singular instinct, on account of which it ought rather to be called the *hay-maker*, since man may or might have learned that part of the business of the agriculturist, which consists in providing a store of winter provender for his cattle, from this industrious animal. Professor Pallas was the first who described the quadruped exercising this remarkable function, and gave an account of it. The Tungusians, who inhabit the country beyond the lake of Baikal, call it *Pika*, which has been adopted as its trivial name.

“About the middle of the month of August these little animals collect their winter’s provender, formed of select herbs, which they bring near their habitations and spread out to dry like hay. In September they form heaps or stacks of the fodder they have collected under places sheltered from rain or snow. Where many of them have laboured together, their stacks are sometimes as high as a man, and more than eight feet in diameter. A subterranean gallery leads from the burrow below the mass of hay, so that neither frost nor snow can intercept their communication with it. Pallas had the patience to examine their provision of hay piece by piece, and found it to consist chiefly of the choicest grasses and the sweetest herbs, all cut when most vigorous, and dried so slowly as to form a green and succulent fodder; he found in it scarcely any ears or blossoms, or hard and woody stems, but some mixture of bitter herbs, probably useful to render the rest more wholesome.”†

“Although,” says Kirby, “ants during the cold winters in this country remain in a state of torpidity, and have no need of food, yet in warmer regions during the rainy seasons, when they are probably confined to their nests, a store of provisions may be necessary for them. Now although the rainy season, at least in America, is a season in which insects are full of life, yet the observation that ants may store up provisions in warm countries is confirmed by an account sent me by Colonel Sykes, with respect

to another species which appears to belong to the same genus as the celebrated *ants of visitation*, by which the houses of the inhabitants of Surinam were said to be cleared periodically of their cock-roaches, mice, and even rats. The present species has been named by Mr. Hope the *provident ant*. These ants, after long-continued rains during the monsoon, were found to bring up and lay upon the earth on a fine day, their stores of grass seeds and grains of Guinea corn, for the purpose of drying them. Many scores of these hoards were frequently observable on the extensive parade at Poona.”‡

The great and important instinct of migration is another means by which the lives of many animals are preserved during winter. The number of species of birds, which pass the summer to bring forth their young in this country, but disappear from it in autumn, and are known to spend the winter in the south of Europe or Africa, has been stated at not less than five-sixths of the whole number resident here during the summer, and these are replaced by many other species, chiefly aquatic birds and waders, but likewise the fieldfares, redwings, starlings, &c. which have brought forth their young in the colder climates, and return here for the winter. There are others, as the crane and stork, which perform similar migrations, but are rarely seen in this country. The migrations of the larger birds from the northern regions are chiefly performed in large bodies, forming angular lines, very high in the air; those of the smaller birds of passage, swallows, singing birds, &c. that go southwards from hence, seem to take place less regularly, and have been less accurately observed. There are also many annual migrations from one part of this country to another, in spring and autumn, as of the plovers and lapwings, curlews, ring ouzels, &c. It is still doubtful with what sensations the propensity to perform these periodical migrations is chiefly connected, whether with changes of temperature, or deficiency of food, or with the changes of the sexual desire, (as maintained by Jenner.†) But it is certain that the migrations take place while the temperature is still such as is well borne by the animals; indeed of most of the species of birds of passage some individuals are frequently observed not to migrate;‡ and it is equally certain that most of the birds of passage do not gradually withdraw, as if following the gradual changes of the food on which they live, but go off suddenly, and perform their voyages, particularly in autumn, so rapidly, as to be much exhausted and emaciated at the end of them; so that it is certainly not under the influence of sensations gradually changing and tending to partial and successive changes of place, but under that of a strong determination, overcoming the motives to action which are usually predominant, and commanding strenuous and painful exertion at a time when no great inconvenience is felt, that these voyages are per-

* Introduction to Entomology, vol. ii. p. 438.

† Ib. p. 507.

‡ Vol. ii. p. 344.

† Phil. Trans. 1824.

‡ See Darwin, Zoonomia, sect. xvi. 12.

formed. And if, with Darwin and some others, we doubt of the existence of a blind instinctive propensity as the cause of these movements, we have no resource but to ascribe them to a very high degree of intelligence, combined with much mental resolution, and extending to all or almost all the individuals of the species, enabling them to foresee evils that are still remote, and determining them to undergo labour, fatigue, and danger in order to avoid them. It has also been repeatedly ascertained that the same individuals return after their six months of absence and long voyages, to the very spots where they had been brought forth, implying a power of discernment and recollection which appear to us quite inconceivable. Of such high qualities of mind we see no indications in the other actions of these birds, excepting only in their preparations for the nurture of their young; and if they really possessed these qualities, we might expect with perfect confidence to see them devise many contrivances for their comfort and convenience, and to witness variations and improvements in habits, which we know from the writings of the ancient naturalists to have been perfectly uniform and stationary at least since the time of Aristotle.

There are some of the Mammalia, chiefly of the order Ruminantia, which likewise perform periodical migrations in the natural state, as has been particularly noticed in America, of the bison, the musk-ox, and rein-deer. A similar instinct has been observed in the quaggas in Africa; and a singular observation, as shewing a variation of instinct according to varying circumstances, was made by Dr. Richardson, that the American black bear, when lean, and from that cause unfitted for hybernation, migrates in severe winters from the northward into the United States.

The periodical migrations of fishes appear to be designed for the benefit of their offspring, not for their own preservation; and there are other migrations, in immense numbers, of various kinds of animals which are not periodical, and of which the object is still obscure, but which do not fall under the present head.

II. *Of instincts for the propagation and support of offspring.*—Of the very curiously varied instincts of animals connected with the propagation and support of their offspring, we need not dwell on those which must necessarily attend the very various kinds of organs (so well arranged and described by Cuvier), by which the impregnation of the ova in the different tribes of animals is effected—the instincts, e. g. which prompt most male fishes to impregnate eggs already laid, and many reptiles to impregnate them at the moment of their emission from the body of the female, or which guide the different warm-blooded animals in the different modes of their sexual intercourse. The instincts which enable animals to anticipate and provide for the wants of their young are still more varied, and imply mental processes of greater complexity. The most important of these may be referred to the following heads.

1. This is probably one object of the migra-

tions of birds above-mentioned, and certainly the main object of the migrations of great swarms of fishes, both in the sea, and of those which ascend the rivers; to which the same observations, as to the return to the same spot whence they had formerly departed, and as to the labours and hazard which the instinct impels them to incur, are in many instances applicable.

“The *cod-fish* makes for the coast at spawning time, going northward; this takes place towards the end of winter, or the beginning of spring.

“The *mackerel* hybernates in the Arctic, Antarctic, and Mediterranean Seas, where it is stated to select certain depths of the sea called by the natives *Barachouas*, which are so landlocked, that the water is as calm at all times as in the most sheltered pools.

“It is in these that the mackerel, directed by instinct, pass the winter. In the spring they emerge in infinite shoals from their hiding places, and proceed southward for the purposes of depositing their eggs in more genial seas.

“What the mackerel is to the north of Europe, the *thunny* is to the south. It deposits its eggs in May and June, when it enters the Mediterranean, seeking the shores in shoals arranged in the form of a parallelogram, or as some say, a triangle, and making a great noise and stir.

“The *herring* may be said to inhabit the arctic seas of Europe, Asia, and America, from whence they annually migrate at different times in search of food, and to deposit their spawn. Their shoals consist of millions of myriads, and are many leagues in width, many fathoms in thickness, and so dense that the fishes touch each other.” “The largest and strongest are said to lead the shoals, which seem to move in a certain order, and to divide into bands as they proceed, visiting the shores of various islands and countries, and enriching their inhabitants.” “They seek places for spawning where stones and marine plants abound, against which they rub themselves alternately on each side, all the while moving their fins with great rapidity.”

“In temperate climates the *salmon* quits the sea early in the spring, when the waves are driven by a strong wind against the river currents.” “They leave the sea in numerous bands formed with great regularity. The largest individual, which is usually a female, takes the lead, and is followed by others of the same sex, two and two, each pair being at the distance of from three to six feet from the preceding one; next come the old, and after them the young males in the same order.” “They employ only three months in ascending to the sources of the *Maraguon*, the current of which is remarkably rapid, which is at the rate of nearly forty miles a day; in a smooth stream or lake their progress would increase in a four-fold ratio. Their tail is a very powerful organ, and its muscles have wonderful energy; by placing it in their mouth, they make of it a very elastic spring, for, letting it go with violence, they raise themselves in the air to the

height of from twelve to fifteen feet, and so clear the cataract that impedes their course; if they fail in their first attempt, they continue their efforts till they have accomplished it. The female is stated to hollow out a long and deep excavation in the gravelly bed of the river to receive her spawn."*

A similar periodical emigration has been observed in other animals, particularly in some of the Crustacea.

"Several of the crabs forsake the waters for a time, and return to them to cast their spawn; but the most celebrated of all is that known by the name of *land-crab*, and alluded to by Dr. Paley as the violet-crab, and which is called by the French the *tourlourou*. They are natives of the West Indies and South America. In the rainy season, in May and June, their instinct impels them to seek the sea, that they may fulfil the great law of their Creator, and cast their spawn. They descend the mountains, which are their usual abode, in such numbers that the roads and woods are covered with them." "They are said to halt twice every day, and to travel chiefly in the night. Arrived at the sea-shore, they are there reported to bathe three or four times, when retiring to the neighbouring plains or woods, they repose for some time, and then the females return to the water, and commit their eggs to the waves. This business dispatched, they endeavour to regain, in the same order, the country they had left, and by the same route, but only the most vigorous can reach the mountains."†

The object of all these migrations is, that the female animals may have an opportunity of depositing their eggs where they will be in circumstances suited to their development, particularly as to the essential requisites, exposure to heat and to air.

2. The same object, the choice of a suitable place for depositing their eggs, is accomplished in other instances by very different instincts implanted in female animals. "Reptiles," says Kirby, "and Fishes do not feel the instinctive love for their young, after birth, which is exhibited by quadrupeds and birds, but are invariably instructed by the Creator to select a place in which their eggs can be hatched either by artificial or solar heat." Many of them likewise, as the salmon, dig holes before depositing them, for their protection. Those of the serpents which are not ovo-viviparous, bury their eggs in sand, or in heaps of fermenting matter. The Saurians also select a proper place for their eggs, the crocodile, e.g. the sands beside rivers; "one species of salamander commits a single egg to a leaf of *Pescicaria*, protects it by carefully doubling the leaf, and then proceeding to another, repeats the manœuvre till her oviposition is finished. Toads and frogs lay their eggs in water, surrounded by a gelatinous envelope which forms the first nourishment of the embryo," corresponding to the albumen of the bird's egg.

In like manner every insect is directed by nature to place its eggs in situations where its

young, when disclosed, will find its appropriate nourishment; some burrowing in the earth for this purpose; many flies in dead animal matter about to putrefy; many in different parts of living vegetables;* bees and ants in the cells where they are to be fed by the working members of their hives, &c. A species of the ichneumon fly and some of the wasps have been observed to bury caterpillars along with their eggs, on which their larvæ are to feed, and another fly to deposit its eggs on the back of a caterpillar, when the larvæ feed on the secretion by which the covering of the pupa is to be formed.†

3. The instincts called into action in the *nidification*, particularly of birds, are so numerous, varied, and admirably adapted to their purpose, as to have called forth admiration in all ages. The pairing of the parent birds at the beginning of spring, when the labour is to begin; the choice of a place suited to the habits of the species, on the ground, under ground, in rocks, on the edge of lakes or of the sea, in marshes, in bushes, on trees, on buildings of all descriptions; the choice of the materials, and the labour exerted for completing the work; some using clay, some sand, some moss, some leaves, some straw or twigs, some moss or lichen; many forming a rough outside of materials hardly to be distinguished from the surrounding objects, while the inside is warm and smooth; some building in very peculiar forms to impede the access to their young; the tailor-bird sewing leaves together with distinct stitches, and the Java swallows forming their gelatinous nests, as the bees manufacture their waxen cells, from the contents and secretions of their own stomachs;—all furnish proofs of contrivance too obvious and too nearly adjusted to varying circumstances, to have escaped the attention even of careless observers. Many of the Mammalia make some kind of provision, although less artificial, for the reception of their progeny. "Cats search about inquisitively for a concealed situation; burrowing animals retire to the bottom of their burrows, and several of the Rodentia make beds of their own hair to receive their young;" all beasts of prey, whose progeny come into the world blind and helpless, have some kind of retreat in which they supply them at once with warmth and nourishment. Many insects, also, besides those which associate in hives, use various precautions for the covering and protection of their eggs.

4. The instinct of *incubation*, which forms the next part of the provisions for the reproduction of birds, the extraordinary change then effected in the habits of the female bird, particularly when attended and cheered; as happens in so many cases, by the equally temporary instinct of song of the male bird,—is another natural phenomenon too striking and interesting to have escaped observation; and the object of

* In this choice insects seem to be guided by the sense of smell, at least in the case where the food of the larvæ to be brought forth is different from that of the parent.

† Darwin.

* Kirby, vol. i.

† Ibid.

this provision of nature has been fully elucidated by the observations of Reaumur and many others as to the efficacy of artificial heat in procuring the development of the chick.

5. The instincts of many parent animals are likewise the means adopted by nature for procuring *nourishment* for the young. This is observed as to those of the lower orders whose young are brought forth in circumstances rendering it impossible for them to procure their own food (as the bee and wasp), and also as to the carnivorous tribes, both of birds and quadrupeds; the exertion requisite for procuring their prey being beyond the power of the young animal, the instinct of the parent supplies the defect. In most cases fresh supplies of food are daily or even hourly brought to the young animals, but in some instances stores of nourishment are provided for the young of the higher animals, equally as for those of the bee or ant; the pelican brings a large supply in his pouch from a single fishing; and according to the observations of an author in the Magazine of Natural History, some of the carnivorous animals have the curious instinct of storing up with this view animals not dead, but stupified by injury of the brain. "I dug out," says he, "five young pole-cats, comfortably imbedded in dry withered grass; and in a side hole, of proper dimensions for such a larder, I poked out forty large frogs and two toads, all alive, but merely capable of sprawling a little. On examination I found that the whole number, toads and all, had been purposely and dextrously bitten through the brain."*

Lastly, the young of all warm-blooded animals being unable for some time after they come into the world to maintain their own temperature, would soon perish of cold, even if capable of procuring their own food, but for the *protection* they receive from their parents. This seems to be the most general final cause of the *στροφή* or maternal affection so strongly implanted in all these animals, and to which so much of the first period of the existence of their offspring is intrusted, but of which there is little trace in the lower tribes. As, however, the dangers to which these young animals are exposed are numerous and varied, so nature has provided against them, not by a propensity to the performance of one kind of action only, but by a vigilant and permanent feeling which controls all the habits of the parent animal, and prompts many actions, some of which are strictly instinctive, while others ought rather to be called voluntary, but are quite at variance with the ordinary habits of the animals. Every one must be aware of the increased ferocity given to the female carnivorous animals during the time that they are occupied with the care of their young, and of the resolution with which birds, at other seasons pacific and even timid, will resent any intrusion on their nests or young broods; of the provident care of the cat or the lioness, which carries her young in her mouth, and of almost all female warm-blooded animals, which gather them

close to their bodies for protection from cold; of the anxiety of the hen which has sat on duck's eggs, when the ducklings take to the water; of the resolution and ingenuity with which the lapwing fixes on herself the attention of passengers who may come near her nest, &c. But what most distinctly indicates that all this care and anxiety are unconnected with any such anticipation of the results as would be acquired by a process of reasoning, is the absolute indifference which succeeds, when the parent animal at length sees her offspring independent of her assistance—

"And once rejoicing, never knows them more."

III. Various instinctive propensities may be observed in animals, the object of which is the advantage of the race or of the animal creation generally, rather than of the individual or his progeny, and some the object of which is still obscure. Some of these are, like the maternal affection last mentioned, obviously partaken by the human race, or even chiefly perceptible in those animals which have much connexion with man. The instinctive attachments not only of dogs but various domestic animals to their masters or attendants, of cats to houses, of sheep to particular hills or pastures, might be illustrated by many curious anecdotes, and seem to be very similar to the feelings which, after being fully developed in the human race, and strengthened and extended by the reflective powers of the human mind, obtain the names of family affection, of local attachment, of patriotism, &c. If the instinct of modesty exists in hardly any animals, the desire of cleanliness may be observed in many. The instinct of imitation, formerly noticed, and which is of so essential importance to all human enterprises in which the cooperation of numbers is required, is perhaps more distinctly observable in individual monkeys than in any other animals, although it is probable that a similar feeling may be part of the bond of association by which many animals are congregated together in the mode to be presently noticed. The intuitive perception of the signs of emotion or passion in the countenance and gestures which precedes and excites the tendency to imitation in man, is obviously common to us with many other animals.

In fact, although we rigidly maintain the essential superiority of the *intellect* of man over that of all other animals, we have already stated that the greater number of the *active* powers of the human mind which furnish the chief motives to action are on the same footing with those which operate on the lower animals. Not only are our appetites similar to theirs, but the greater number of the desires of which we are conscious are either shared with us by them, or at least would seem to belong to the same class as their instincts. Thus the desire of approbation is quite obvious at least in some of the domestic animals, and the desire of society, as observed by Stewart, seems to act very generally, although variously, in the animal creation. The desire of power may be thought to be more peculiar to man, and we

* Magazine, &c. vol. vi. p. 206.

have every reason to believe that no other animal can reflect on the possession of power in the abstract, or indulge in the imagination of scenes in which it is to be exerted, or rejoice in the acquisition of wealth of any kind, as the means of exercising power and procuring pleasure, independently of the actual enjoyment of them; but many of the practical exemplifications of this desire come into direct comparison with, and probably involve feelings very similar to, the instincts of animals. Thus the pleasure which men feel in exerting power over the elements around them may be seen, in the case of children, to be prior to the experience of any practical advantage from the arts of architecture, of mechanics, or of navigation; and it may be confidently asserted, that but for this pleasure attending the exercise of those arts (and which may be supposed to be very similar to that which animates the beaver, the bird, or the ant in their respective labours,) they could never have been prosecuted with success. So also the pleasure which man in all ages has felt both in hunting and destroying animals, and also in acquiring dominion over them and subjecting them to his power, is clearly quite different from the anticipation of the useful purposes to which, whether dead or living, they may be applied, and appears precisely similar, both in its nature and in its object or final cause, to some of the instincts of animals.

Indeed, in conformity to what has been already said of the essential peculiarities of the human intellect, it is only those motives to action which imply the previous formation of general notions or abstract ideas, that we can regard as peculiar to man; and we may accordingly state that the desire of knowledge (we may even say more specifically, of scientific knowledge, 'rerum cognoscere causas') and the sense of *obligation* religious and moral, are the motives to action which we believe to be truly peculiar to the human race.

The most important instinct of animals referable to this head, clearly and strongly felt likewise by man, (although combined in his case with many other feelings,) is the instinct of *congregation*. More or less of the desire of society is seen in a great majority of animals; but we may refer to this head many actions of animals, wherein many individuals of the same species cooperate, of which the object is in many instances still obscure, but to which the animals are impelled with an energy, and frequently a self-devotion, attesting the strength of the mental feeling, and completely superseding their usual habits. Messrs. Spence and Kirby enumerate not less than five kinds of association of insects to form what they term imperfect societies.

"The first of these associations (for the sake of company only) consists chiefly of insects in their perfect state. The little beetles called whirlwigs,—which may be seen clustering in groups under warm banks in every river and every pool, wheeling round and round with great velocity, at your approach dispersing and diving under water, but as soon as you retire resuming their accustomed movements,—

seem to be under the influence of the social principle, and to form their assemblies for no other purpose than to enjoy together in the sun-beam the mazy dance. Impelled by the same feeling, in the very depth of winter, even when the earth is covered with snow, the tribes of *Tipulidæ* (usually but improperly called gnats) assemble in sheltered situations at mid-day where the sun shines, and form themselves into choirs that alternately rise and fall with rapid evolutions.

"Another association is that of males during the season of pairing. Of this nature seems to be that of the cockchafer and fernchafer, which, at certain periods of the year and hours of the day, hover over the summits of the trees and hedges like swarms of bees.

"The males of another root-devouring beetle (*Hoplia argentea*, F.) assemble by myriads before noon in the meadows, when in these infinite hosts you will not find a single female.

"The next description of insect associations is of those that congregate for the purpose of travelling or emigrating together. De Geer has given an account of the larvæ of certain gnats (*Tipula*, L.) which assemble in considerable numbers for this purpose, so as to form a band of a finger's breadth, and of one or two yards in length. And what is remarkable, while upon their march, which is very slow, they adhere to each other by a kind of glutinous secretion.

"Kuhn mentions another of the *Tipulidæ*, the larvæ of which live in society and emigrate in files.

"But of insect emigrants none are more celebrated than the locusts, which, when arrived at their perfect state, assemble in such numbers as in their flight to intercept the sun-beams and to darken whole countries, passing from one region to another, and laying waste kingdom after kingdom.

"The same tendency to shift their quarters has been observed in our little indigenous devourers, the Aphides.

"It is the general opinion in Norfolk, Mr. Marshall informs us, that the saw-fly (*Tenthredo*) comes from over sea. A farmer declared he saw them arrive in clouds so as to darken the air; the fishermen asserted that they had repeatedly seen flights of them pass over their heads when they were at a distance from land, and on the beach and cliffs they were in such quantities that they might have been taken up by shovels full. Three miles inland they were described as resembling swarms of bees.

"It is remarkable that of the emigrating insects here enumerated, the majority, for instance the Libellulæ, the Coccinellæ, Carabi, Cicadæ, &c. are not usually social insects, but seem to congregate, like swallows, merely for the purpose of emigration.

"The next order of imperfect associations is that of those insects which feed together.

"Two populous tribes, the great devastators of the vegetable world, the one in warm and the other in cold climates, to which I have already alluded under the head of emigrations,

—I mean *Aphides* and *Locusts*,—are the best examples of this order.

“So much as the world has suffered from these animals, it is extraordinary that so few observations have been made upon their history, economy, and mode of proceeding.

“The eggs of the locusts were no sooner hatched in June,” says Dr. Shaw, “than each of the broods collected itself into a compact body, of a furlong or more in square, and then marching directly forwards towards the sea, they let nothing escape them; *they kept their ranks like men of war*, climbing over as they advanced every tree or wall that was in their way; nay, they entered into our very houses and bed-chambers like so many thieves. A day or two after one of these hordes was in motion, others were already hatched to march and glean after them. Having lived near a month in this manner they arrived at their full growth, and threw off their *nympha state* by casting their outward skin.” “The transformation was performed in seven or eight minutes, after which they lay for a short time in a torpid and seemingly languishing condition; but as soon as the sun and the air had hardened their wings by drying up the moisture that remained on them after casting their sloughs, they re-assumed their former voracity with an addition of strength and agility.”

“According to Jackson they have a government amongst themselves similar to that of the bees and ants; and when the king of the locusts rises, the whole body follow him, not one solitary straggler being left behind. But that locusts have leaders like the bees or ants, distinguished from the rest by the size and splendour of their wings, is a circumstance that has not yet been established by any satisfactory evidence; indeed, very strong reasons may be urged against it.”

“The last order of imperfect associations approaches nearer to perfect societies, and is that of those insects which the social principle urges to unite in some common work for the benefit of the community.

“Many larvæ of *Lepidoptera* associate with this view, some of which are social only during part of their existence, and others during the whole of it.

“A still more singular and pleasing spectacle when their regiments march out to forage, is exhibited by the *Processionary Bombyx*. This moth, which is a native of France and has not yet been found in this country, inhabits the oak. Each family consists of from 600 to 800 individuals. When young, they have no fixed habitation, but encamp sometimes in one place and sometimes in another under the shelter of their web; but when they have attained two-thirds of their growth, they weave for themselves a common tent. About sun-set the regiment leaves its quarters; or, to make the metaphor harmonize with the trivial name of the animal, the monks their cœnobium. At their head is a chief, by whose movements their procession is regulated. When he stops all stop, and proceed when he proceeds; three or four of his immediate followers succeed in the same line,

the head of the second touching the tail of the first; then comes an equal series of pairs, next of threes, and so on as far as fifteen or twenty. The whole procession moves regularly on with an even pace, each file treading on the steps of those that precede it. If the leader, arriving at a particular point, pursues a different direction, all march to that point before they turn.”*

Examples of occasional associations, more or less resembling all these, and of which the object is in many instances still obscure, may be found in all the classes of the higher animals, as is obvious, when we consider to how many tribes of animals the term *gregarious* is usually applied, e. g. to almost all the Ruminantia, some of the Pachydermata, and a few of the Rodentia. Some of the genus *Muridæ* (rats and mice) have been long known to migrate, occasionally, in a manner resembling the locusts. “The general residence of the lemming,” says Pallas, “is in the mountainous parts of Lapland and Norway, from which tracts at uncertain periods it descends in immense troops, and by its incredible numbers becomes a temporary scourge to the country, devouring the grain and herbage, and committing devastations equal to those of an army of locusts.” “It is observable that their chief emigrations are made in the autumns of such years as are followed by severe winters.” “The ground over which they have passed appears at a distance as if it had been ploughed, the grass being devoured to the roots in numerous stripes or parallel paths, of one or two spans broad, and at the distance of some yards from each other.” “The army moves chiefly at night, or early in the morning. No obstacles that they meet in their way have any effect in altering their route, neither fires, nor deep ravines, nor torrents, nor marshes, nor lakes; they proceed obstinately in a straight line, and hence many thousands perish in the waters.” “If disturbed, in swimming over a lake, by oars or poles, they will not recede, but keep swimming directly on, and soon get into regular order again.” “In their passage over land, if attacked by men, they will raise themselves up, uttering a kind of barking sound, and fly at the legs of their invaders, and will fasten so fiercely on the end of a stick, as to suffer themselves to be swung about without quitting their hold, and are with great difficulty put to flight.” “The major part of these hosts is destroyed by various enemies, as owls, hawks, weasels, exclusively of the number that perish in the waters, so that but a small part survive to return, as they are sometimes observed to do, to their native mountains.” The campagnol, or short-tailed rat, has been known to commit similar ravages in France. It is obvious here, that under the influence of this instinct, and of the excitement of numbers (in which, as in our own race, the principle of imitation is probably much concerned) the usual motives to action of these animals are superseded, and their usual habits changed.

We are still uncertain as to the use, or final

* Introduction to Entomology, letter xvi.

cause, of the various congregations of birds that we daily witness, and of the varying habits which they then exhibit—crows, e. g. herons, and many water birds, roosting and bringing forth their young in large irregular societies; the crows, besides, assembling at particular hours of the day, at all seasons; some of the genus *Parus*, particularly the great and long-tailed titmouse, feeding in small flocks at all seasons;—plovers and lapwings keeping separate during the season of hatching and rearing their offspring, but assembling in flocks after their young have attained maturity;—most of the birds of this country in the depth of winter associating in flocks much greater than can be necessary for the sake of warmth;—the hen chaffinches, and perhaps the females of other birds, congregating separately;—many of these flocks consisting of multitudes moving quite irregularly, but all of them having apparently some means of intercommunication or agreement;—some of them, as the starlings, performing very singular evolutions in concert; and many, as wild geese and other water-birds, always showing the disposition to fly in regular lines.

The greatest of all the congregations of birds are those of the migrating pigeons in America, described by Audubon, as forming clouds which pass over the whole extent of a town for several hours together, and as settling on extensive districts of the woods in such multitudes as to cause much devastation among the branches.

But the most extraordinary of all the associations of animals are those which have received the title of the perfect societies of insects,—the bees, wasps, hornets and ants in the order of Hymenoptera, and the white ants or termites, in that of Neuroptera. The most important facts as to them seem to have been ascertained, partly by numerous former observers, but chiefly by the Hubers, Latreille, and others in the present age.

The essential peculiarity of these associations of insects appears to be the complete separation of the males and females, on whom the propagation of the species depends, from the working members of the communities, by whom the habitations are constructed, and who procure food both for the young and for the more perfect insects. In the case of the bees, the only prolific female is the queen-bee; the males are the drones; the working bees, constituting the mass of the community, are sterile females, and the larvæ and pupæ are confined to the cells and helpless; the ants appear to differ from these only in the perfect females being much more numerous (only a few, however, being retained in each ant-hill); but the termites differ, in the larvæ and even the pupæ being working members, the males and females, when brought to perfection, always wandering abroad, and one of each sex in the perfect state only existing in each nest, being in fact forcibly detained there.

Among these animals there is also a separate class, believed to be analogous to the working bees, i. e. to be sterile females, larger than the

labourers, and which are thought to act exclusively as the soldiers of the community,—the smaller working ants (larvæ) always disappearing, and these larger and fiercer animals shewing themselves, when any of the works are attacked.*

These associations differ from all others existing among animals, in the extraordinary instinct of respect and devotion shewn by the working members to the impregnated female,—single in each swarm of bees, and in each nest of termites, and few in number in each nest of ants,—and with this instinct most of their other peculiarities seem to be connected.

But it is justly observed by Mr. Spence, that if we suppose all the labours of the bees and the ants to be guided by instincts, we must necessarily attribute to these animals a much greater number and variety of instinctive propensities, and more extraordinary modifications of them to suit varying circumstances of their condition, than to any of what are usually called the higher animals.

“In the common duck, one instinct leads it at its birth from the egg to rush to the water; another to seek its proper food; a third to pair with its mate; a fourth to form a nest; a fifth to sit upon its eggs till hatched; a sixth to assist the young ducklings in extricating themselves from the shell; and a seventh to defend them when in danger until able to provide for themselves: and it would not be easy as far as my knowledge extends, to add many more instinctive actions to the enumeration, or to adduce many specimens of the superior classes of animals endowed with a greater number.

“But how vastly more manifold are the instincts of the majority of insects!

“As the most striking example of the whole, I shall select the hive-bee,—begging you to bear in mind that I do not mean to include those exhibited by the queen, the drones, or even those of the workers, termed by Huber *cirières* (wax-makers); but only to enumerate those presented by that portion of the workers, termed by Huber *nourrices* or *petites abeilles*, upon whom, with the exception of making wax, laying the foundation of the cells, and collecting honey for being stored, the principal labours of the hive devolve.

“By one instinct bees are directed to send out scouts previously to their swarming in search of a suitable abode; and by another to rush out of the hive after the queen that leads forth the swarm, and follow wherever she bends her course. Having taken possession of their new abode, whether of their own selection or prepared for them by the hand of man, a third instinct teaches them to cleanse it from all impurities; a fourth to collect propolis, and with it to stop up every crevice except the entrance: a fifth to ventilate the hive for preserving the purity of the air; and a sixth to keep a constant guard at the door.

“In constructing the houses and streets of their new city, or the cells and combs, there are probably several distinct instincts exercised;

* See Spence and Kirby, vol. ii. p. 39.

but not to leave room for objection, I shall regard them as the result of one only: yet the operations of polishing the interior of the cells, and soldering their angles and orifices with propolis, which are sometimes not undertaken for weeks after the cells are built; and the obscure but still more curious one of varnishing them with the yellow tinge observable in old combs, seem clearly referable to at least two distinct instincts.

"In their out-of-door operations several distinct instincts are concerned. By one they are led to extract honey from the nectaries of flowers; by another to collect pollen after a process involving very complicated manipulations, and requiring a singular apparatus of brushes and baskets; and that must surely be considered a third which so remarkably and beneficially restricts each gathering to the same plant. It is clearly a distinct instinct which inspires bees with such dread of rain, that even if a cloud pass before the sun, they return to the hive in the greatest haste.

"Several distinct instincts, again, are called into action in the important business of feeding the young brood. One teaches them to swallow pollen, not to satisfy the calls of hunger, but that it may undergo in their stomach an elaboration fitting it for the food of the grubs; and another to regurgitate it when duly concocted, and to administer it to their charge, proportioning the supply to the age and condition of the recipients. A third informs them when the young grubs have attained their full growth, and directs them to cover their cells with a waxen lid, convex in the male cells, but nearly flat in those of workers, and by a fourth, as soon as the young bees have burst into day, they are impelled to clean out the deserted tenements and make them ready for new occupants.

"Numerous as are the instincts already mentioned, the list must yet include those connected with that mysterious principle which binds the working bees of a hive to their queen—the singular imprisonment in which they retain the young queens that are to lead off a swarm, until their wings be sufficiently expanded to enable them to fly the moment they are at liberty, gradually paring away the waxen wall that confines them to an extreme thinness, and only suffering it to be broken down at the precise moment required;—the attention with which in these circumstances they feed the imprisoned queen by frequently putting honey on her proboscis, protruded from a small orifice in the lid of her cell;—the watchfulness with which, when at the period of swarming more queens than one are required, they place a guard over the cells of those undisclosed, to preserve them from the jealous fury of their excluded rivals;—the exquisite calculation with which they invariably release the *oldest* queens the first from their confinement;—the singular love of monarchical dominion, by which, when two queens in other circumstances are produced, they are led to impel them to combat until one is destroyed;—the ardent devotion which binds

them to the fate and fortune of the survivor;—the distraction which they manifest at her loss, and their resolute determination not to accept of any stranger until an interval has elapsed sufficiently long to allow of no chance of the return of their rightful sovereign;—and (to omit a further enumeration) the obedience which in the utmost noise and confusion they shew to her well-known hum.

"I have now instanced at least thirty distinct instincts with which every individual of the nurses amongst the working-bees is endowed; and if to the account be added their care to carry from the hive the dead bodies of any of the community; their pertinacity in their battles, in directing their sting at those parts only of the bodies of their adversaries which are penetrable by it; their annual autumnal murder of the drones, &c. &c.—it is certain that this number might be very considerably increased, perhaps doubled.*"

To these instincts, in the case of some species of ants we shall certainly have to add those by which they are guided in carrying on a regular system of warfare, either with other hives of the same species or with other species, in subjugating and bringing up as workers or slaves those that they have subdued, and likewise in subjecting to their dominion tribes of Aphides.†

But all this becomes still more surprising, because more at variance with the usual instincts of animals, when we consider the power of adapting their operations to changes in their circumstances, which such associations of insects possess.

"It is," says Mr. Spence, "in the *deviations* of the instincts of insects and their *accommodation* to *circumstances*, that the exquisitesness of these faculties is most decidedly manifested. The instincts of the larger animals seem capable of but slight modification. They are either exercised in their full extent or not at all. A bird, when its nest is pulled out of a bush, though it should be laid uninjured close by, never attempts to replace it in its situation; it contents itself with building another. But insects in similar contingencies often exhibit the most ingenious resources, their instincts surprisingly accommodating themselves to the new circumstances in which they are placed, in a manner more wonderful and incomprehensible than the existence of the faculties themselves."

This observation we support by various instances taken from the history of different insects; but the most extraordinary are from the societies of insects of which we now speak; and of these the following are only a specimen.

"The combs of bees are always at an uniform distance from each other, namely, about one-third of an inch, which is just wide enough to allow them to pass easily, and have access to the young brood. On the approach of winter, when their honey-cells are not sufficient in number to contain all the stock, they *elongate* them considerably, and thus increase their capa-

* Introduction to Entomology, vol. ii. p. 498 et seq.

† Introd. to Entomology, letter xviii.

city. By this extension the intervals between the combs are unavoidably contracted; but in winter well-stored magazines are essential, while from their state of comparative inactivity spacious communications are less necessary. On the return of spring, however, when the cells are wanted for the reception of eggs, the bees contract the elongated cells to their former dimensions, and thus re-establish the just distances between the combs which the care of their brood requires. But this is not all. Not only do they elongate the cells of the old combs when there is an extraordinary harvest of honey, but they actually give to the new cells which they construct on this emergency, a much greater *diameter* as well as a greater depth.

"The queen-bee, in ordinary circumstances, places each egg in the centre of the pyramidal bottom of the cell, where it remains fixed by its natural gluten: but in an experiment of Huber, one whose fecundation had been retarded, had the first segments of her abdomen so swelled that she was unable to reach the bottom of the cells. She therefore attached her eggs (which were those of males) to their lower side, two lines from the mouth. As the larvæ always pass that state in the place where they are deposited, those hatched from the eggs in question remained in the situation assigned them. But the working bees, as if aware that in these circumstances the cells would be too short to contain the larvæ when fully grown, *extended their length*, even before the eggs were hatched.

"The working bees, in closing up the cells containing larvæ, invariably give a convex lid to the large cells of drones, and one nearly flat to the smaller cells of workers; but in an experiment instituted by Huber to ascertain the influence of the size of the cells on that of the included larvæ, he transferred the larvæ of workers to the cells of drones. What was the result? Did the bees still continue blindly to exercise their ordinary instinct? On the contrary, they now placed a nearly *flat* lid upon these large cells, as if well aware of their being occupied by a different race of inhabitants."

But the most extraordinary of all these variations of the operations of bees are seen in two cases which have been often produced for the sake of experiment, and of which the result appears to have been repeatedly and carefully observed.

"If a hive be in possession of a queen duly fertilized, and consequently sure, the next season, of a succession of males, all the drones, towards the approach of winter, are massacred by the workers with the most unrelenting ferocity. This would seem to be an impulse as naturally connected with the organization and very existence of the workers, as that which leads them to build cells or store up honey. But however certain the doom of the drones if the hive be furnished with a duly fertilized queen, their undisturbed existence through the winter is equally certain if the hive has lost its sovereign, or if her impregnation has been so retarded as to make a succession of males in the spring doubtful; in such a hive the workers

do not destroy a single drone, though the hottest persecution rages in all the hives around them."

Again, "in a hive which no untoward event has deprived of its queen, the workers take no other active steps in the education of her successors,—those of which one is to occupy her place when she has flown off at the head of a new swarm in spring,—than to prepare a certain number of cells of extraordinary capacity for their reception while in the egg, and to feed them when become grubs with a peculiar food until they have attained maturity. This, therefore, is their ordinary instinct; and it may happen that the workers of a hive may have no necessity, for a long series of successive generations, to exercise any other. But suppose them to lose their queen. Far from sinking into that inactive despair which was formerly attributed to them, after the commotion which the rapidly-circulated news of their calamity gave birth to has subsided, they betake themselves with an alacrity from which man, when under misfortune, might deign to take a lesson, to the reparation of their loss. Several ordinary cells are without delay pulled down and converted into a variable number of royal cells, capacious enough for the education of one or more queen-grubs selected out of the unhoused working grubs—which in this pressing emergency are mercilessly sacrificed—and fed with the appropriate royal food to maturity. Thus sure of once more acquiring a head, the hive return to their ordinary labours, and in about sixteen days one or more queens are produced, one of which steps into day and assumes the reins of state."

There can be no doubt that the perfect order and regularity seen in all the operations of these societies of insects could not be maintained without some mode of communication among the different individuals concerned in these operations; and it appears distinctly that such means of communication exist, and that it is in consequence of their being exercised, for example, that a swarm of bees, when it leaves a hive, takes the direction to a spot previously fixed on, and carefully examined, by a small number of scouts, as observed by Mr. Knight.*

When such facts are duly considered, we cannot be surprised to find so intelligent a naturalist as Mr. Spence acknowledging that he had at one time arranged them as indications of reason in these animals. But on further consideration, we shall probably see cause to acquiesce in his later and more matured judgment, which ascribes them to strictly instinctive, although singularly varying propensities; chiefly on two grounds, which exactly correspond to what was stated in the beginning of this paper as the most distinctive characters of instinct: 1. that although various contrivances are fallen on by *all* bees to enable them to continue their usual operations under varying external circumstances, yet there is no such variety observed either in the conduct of individuals

* Phil. Trans. 1807.

of the species or in the conduct of different communities, as we cannot doubt must occur if the inhabitants of every hive were guided, on such unusual occasions, by processes of reasoning, by observation of the laws of nature, by experience, and anticipation of the effects of their actions. If such mental processes were their guide, we should certainly observe a difference in the conduct of experienced workers, and of those just emerged from their pupæ; and we should observe some variety in the expedients adopted in different hives for meeting such accidents or difficulties. 2. While the varying operations of these animals for one particular end, the preservation of their own lives and the perpetuation of their species, are planned and combined in such a manner as to indicate consummate intelligence as to what is essential for that purpose, all these indications of instinct are limited to that object, and we see no evidence of the exercise of their senses suggesting to them any other trains of thought, or exciting them to the prosecution of other objects, such as a number of human intellects capable of planning and executing such works would certainly, sooner or later, attempt to accomplish. The degree of uniformity seen in their operations, and the limitation of the objects on which their faculties are exerted, are therefore our reason for thinking (although we do not wish to express ourselves with absolute confidence on the subject) that the mental processes concerned, even in those the most elaborate and artificial of the works of animals, belong to the same class as those notions of man which are prompted by his instinctive propensities as distinguished from his reason.

At the same time it ought to be stated, that there are many acts of individual animals, or of particular communities, in which we must admit that, although instinct is concerned, it must be guided by mental operations, in which short processes of reasoning, involving certain general ideas, must have been concerned. Several instances, quoted by Mr. Spence, seem hardly to admit of any other interpretation, e. g. the following from Huber. The bees of some of his neighbours protected themselves against the attacks of the death's-head moth, (*Sphinx atropos*), by so closing the entrance of the hive with walls, arcades, &c. built of a mixture of wax and propolis, that these marauders could no longer intrude themselves. Pure instinct would have taught "the bees to fortify themselves on the *first* attack; if the occupants of a hive had been taken unawares by these gigantic aggressors one night, on the second at least the entrance should have been barricaded. But it appears clear, from the statement of Huber, that it was not until the hives had been *repeatedly* attacked, and robbed of nearly their whole stock of honey, that the bees betook themselves to the plan so successfully adopted for the security of their remaining treasures; so that reason, taught by experience, seems to have called into action their dormant instinct."

Again, "a German artist, a man of strict veracity, states that in his journey through Italy he

was an eye-witness to the following occurrence. He observed a species of *Scarabæus* busily engaged in making, for the reception of its egg, a pellet of dung, which when finished it rolled to the summit of a small hillock, and repeatedly suffered to tumble down its side, apparently for the sake of consolidating it by the earth which each time adhered to it. During this process the pellet unluckily fell into an adjoining hole, out of which all the efforts of the beetle to extricate it were in vain. After several ineffectual trials, the insect repaired to an adjoining heap of dung, and soon returned with three of his companions. All four now applied their united strength to the pellet, and at length succeeded in pushing it out; which being done, the three assistant beetles left the spot and returned to their own quarters."*

A number of other instances have been collected by Mr. Duncan.

"Professor Fischer has published an account of a hen, which hen made use of the artificial heat of a hotbed to hatch her eggs."

"A fact is stated by Reaumur of some ants, which, finding they could derive heat from a bee-hive, contrived to avail themselves of it by placing their larvæ between the hive and an exterior covering."

"Dr. Darwin observed a wasp with a large fly nearly as big as itself; finding it too heavy, it cut off the head and the abdomen, and then carried off the remainder, with the wings attached to it, into the air: but again finding the breeze act on the wings, and impede its progress, it descended, and deliberately cut off the wings. Instinct might have taught it to cut off the wings of all insects previous to flying away with them; but here it attempted to fly with the wings on, was impeded by a certain cause, discovered what that cause was, and alighted to remove it. Is not this a comparison of ideas, and deducing consequences from premises?"

"M. de la Loubière, in his relation of Siam, says, that in a part of that kingdom which lies open to great inundations, all the ants make their settlements on trees; no ants' nests are to be seen any where else. Whereas in our country the ground is their only habitation."

"We sometimes kill a cockroach," says Ligon in his history of Barbadoes, quoted by Spence, "and throw him on the ground, and mark what the ants will do with him; his body is bigger than a hundred of them, and yet they will find the means to lay hold of him and lift him up; and having him above ground, away they carry him; and some go by as ready assistants if any be weary, and some are officers that lead and shew the way; and if the van-couriers perceive that the body of the cockroach lies across, and will not pass through the hole or arch through which they mean to carry him, order is given, and the body turned endways, and this is done a foot before they come to the hole, and without stop or stay."†

* Introd. to Entomology, vol. ii. p. 525.

† History of Barbadoes, p. 63.

Colonel Sykes communicated to Mr. Kirby a singular anecdote of some of the black ants in India, which had been prevented, for some time, from getting to some sweatmeats, by having the legs of the table on which they stood immersed in basins filled with water, and besides painted with turpentine. After a time, however, the ants again reached the sweatmeats; and it was found that they did so by letting themselves drop from the wall, above the table, on the cloth which covered it.*

"In Senegal, where the heat is great, the ostrich neglects her eggs during the day, but sits on them at night. At the Cape of Good Hope, however, where the degree of heat is less, the ostrich, like other birds, sits upon her eggs both day and night."

"Rabbits dig holes in the ground for warmth and protection; but after continuing long in a domestic state, that resource being unnecessary, they seldom burrow."

"A dog in a monastery, perceiving that the monks received their meals by rapping at a buttery-door, contrived to do so likewise, and when the allowance was pushed through, and the door shut, ran off with it. This was repeated till the theft was detected."

"A dog belonging to Mr. Taylor, a clergyman, who lived at Colton, near Wolsley Bridge, was accused of killing many sheep. Complaints were made to his master, who asserted that the thing was impossible, because he was muzzled every night. The neighbours persisting in the charge, the dog one night was watched, and he was seen to draw his neck out of the muzzle, then to go into a field, and eat as much of a sheep as satisfied his appetite. He next went into the river to wash his mouth, and returned afterwards to his kennel, put his head into the muzzle again, and lay very quietly down to sleep."

"I observed," says the Rev. J. Hall in his *Travels in Scotland*, "two magpies hopping round a gooseberry bush, in a small garden near a poor-looking house, in a peculiar manner, and flying in and out of the bush. I stepped aside to see what they were doing, and found from the poor man and his wife, that as there are no trees all around, these magpies several succeeding years had built their nest, and brought up their young, in this bush; and that foxes, cats, hawks, &c. might not interrupt them, they had barricaded not only their nest, but had encircled the bush with briars and thorns in a formidable manner; nay, so completely, that it would have cost even a fox, cunning as he is, some days' labour to get into that nest."

"The materials in the inside of the nest were soft, warm, and comfortable; but all on the outside, so rough, so strong, and firmly entwined with the bush, that without a hedge-knife, hatch-bill, or something of the kind, even a man could not, without much pain and trouble, get at their young; as from the outside to the inside of the nest extended as long as my arm."

"These magpies had been faithful to one another for several summers, and drove off their young, as well as every one else who attempted to take possession of their nest. This they carefully repaired and fortified in the spring with strong rough prickly sticks, that they sometimes brought to it by uniting their force, one at each end, pulling it along, when they were not able to lift it from the ground."*

Such examples leave no reasonable ground for doubt, that on certain subjects at least some animals are capable of short and simple processes of reasoning or of imagination, which appear to imply the perception of general truths, and the formation of certain general ideas, and that the difference, formerly stated between the operations of their minds and ours, in that respect, is one of degree only, not absolutely of kind. But this admission, it must be remembered, does by no means diminish the force of the considerations formerly adduced to establish the essential distinction between the instinctive determinations prompting the usual actions of animals, and some of those of men, and those volitions, whether in animals or men, which are consequent on the exercise of reason, and on such anticipation of their consequences as a process of reasoning only can afford.

It is worth while to mention that in some instances animals have been thought to be possessed of a faculty resembling reason, on account of actions, very wonderful indeed, but which the possession of reason would not have enabled them to perform. Thus there are many instances of animals finding their way to their usual place of residence, after being removed from it in such a way as to prevent the mere act of recollection guiding them back. Mr. Duncan† mentions having seen a pigeon, which had been brought from London, let loose on Magdalen Bridge, in Oxford. "It flew first towards the north, but after several gyrations in the air, it flew directly east, and reached London within the appointed time, which was, I believe, three hours." And Mr. Spence gives an anecdote, well authenticated, of an ass from Gibraltar, thrown overboard from a vessel at a distance of 200 miles, which swam ashore, and in a few days afterwards presented himself for admission when the gate of the fortress was opened in the morning. Two instances, equally extraordinary, have been stated on unexceptionable authority to the present writer; one of a pointer which had been sent from Durham to the neighbourhood of Edinburgh by sea, and made his way back in a few days by land, to his master's house in the former county;—the other of a kitten, which had been brought in a carriage a distance of above forty miles, to Edinburgh, and made its way back in a few days to its place of nativity in Stirlingshire, in doing which it must have crossed several bridges. Similar facts have been ascertained in several instances as to sheep; and the cases of the swallow and of the

* *Bridgewater Treatise*, vol. ii. p. 342.

† *Duncan's Lectures on Instinct*.
† *Ibid*.

salmon, returning to the spots where they were bred after their long migrations, are clearly analogous.

But in such cases it is obvious that the possession of reason could not have enabled these animals, alone and unassisted, to find their way; neither was the result properly referable to instinct, this term being properly applicable only to the feeling of attachment which prompted the return home, not to the knowledge which the animals somehow acquired where their home was to be found. The only term properly applicable to the acquisition of this knowledge is *intuition*, and they should be added to other facts, which shew that in various instances animals acquire, by the exercise of their senses, information as to external things, more obviously distinct from the sensations themselves, than those perceptions which Dr. Reid has so clearly shewn to be strictly intuitive inferences, drawn by the human intellect from the intimations of the senses.

There is yet another fact well ascertained of late years regarding the instincts of animals, which we must not omit to state, because it is the only one which gives plausibility to the notion of Darwin, that sensations and experience would explain the whole phenomena of instinct. This is the fact, which seems well ascertained as to certain animals at least,—which is very probably true of man, and susceptible of important practical application in his case,—that the acquired habits of one generation may become instinctive propensities in the next. Thus it has been often observed that the progeny of well-trained pointers learn to point with very little instruction. It is stated by Darwin that dogs in the wild state, both in Africa and America, have been observed not to bark, that they gradually acquire that note from European dogs; and that the latter, when turned loose, retain it for three or four generations, and gradually lose it; and it has been ascertained that in South America, when horses which had been taught to amble had been allowed to run wild, their progeny for two or three generations continued to practice that pace, and then lost it.* Of the existence of such *acquired* instincts, therefore, there can be no doubt; but it need hardly be said that it is quite incompetent to explain the perfect uniformity and the skilful contrivance observed in the instincts of animals; both because its operation seems too limited, and because that supposition would only remove the difficulty as to the continuance of the instinctive operations from the present to the early generations of animals.

In reviewing the varied phenomena of which we have given this hasty sketch, it is impossible not to be struck with the very important share which they occupy in the provisions by which the earth's surface is made a scene of continual activity and change. It is interesting to reflect on the different powers, to the

operation of which we can trace the unceasing changes continually taking place around us, and particularly on the gradation, and very gradual transition that may be observed, from those by which inanimate matter is continually moved and changed, up to those which emanate from the intellect of man. By the original impulse given to the world, and by the laws of gravitation and of motion impressed on all matter, the greater and more striking movements of the inanimate world around us are continually determined; and by the laws of chemistry, these movements are made subservient to constant changes in the composition of the inanimate world. Again, by the laws which were impressed on the lower class of living beings at the time of their introduction into the world, and by the consequently incessant reproduction of vital affinities, which it is in vain to attempt to resolve into the chemistry of dead matter, a constant succession of living vegetable structures is determined, merely by the agency of air and water, heat and light, on those already existing. By the peculiar chemical operation of these living structures, the air, the water, and all the materials of the earth's surface are subjected to peculiar and continual changes, implying slow but incessant movements, which seem clearly to indicate attractions and repulsions, peculiar to the state of vitality. It is still perhaps doubtful whether in the case of vegetables a property of vital contraction is to be added to the active powers of nature. In immediate but still obscure connection with the lowest of the vegetable creation are the lowest of the animals, where we see the first and slightest indications of sensations, and the feeblest motions consequent on sensations, which we judge to be similar to those that we ourselves experience and excite; and here also the vital power of contraction, on which the whole life and activity of animals essentially depends, first clearly manifests itself. Then tracing the animal creation upwards, we find that the world contains an infinite number and variety of sentient beings, the provisions for whose enjoyment we may well believe to have been the main object of Providence in all the arrangements on the surface of the earth; and to which are granted, in a pretty uniform gradation, more and more of the sensations and mental faculties by which nature is made known, and of the powers by which she may be controlled, until we arrive at the intellect and the capacity of Man.

It appears farther that the maintenance, and reproduction, and the very existence of these animal structures are entrusted in part to the sensations of which they are made susceptible, and to the voluntary powers with which they are invested; but that the introduction of these spontaneous powers into the regulation of their economy is so very gradual, that it is hardly possible to say where the movements which result only from physical (although vital) causes terminate, and those which are excited by mental acts begin;—hardly possible, for example, to say, at least as to many animals,

* This principle has been lately investigated and illustrated by Mr. Knight, in a paper read before the Royal Society of London.

whether the reflex function of Dr. Marshall Hall, on which respiration, deglutition, the evacuation of the bowels and bladder, &c. depend, is to be regarded as the result of a merely *physical* impression on the nerves and spinal cord, like the impression of blood on the heart; or whether the *sensations* which naturally accompany these actions are, in the natural state, part of the cause which excites them. But that even when the voluntary powers of animals are certainly the means employed for the ends of their creation, they are still very generally guided by the superior intelligence which has framed both their physical and mental constitution, and which rules the mental but instinctive efforts consequent on the sensations that are felt, as surely as the laws of muscular contraction rule the movements of the heart; and it is into the hands of man alone that the reins of voluntary power are absolutely resigned.

And when we thus pass in review the sensorial and voluntary powers of animals, we are naturally led to the question, whether there is really in our own case so great an exception to those laws of nature which regulate all the other members of the animal creation; whether, admitting the essential superiority of the intellect or reason of man, the different desires and motives to action, which are implanted in him, are not equally subject to the control of the power that gives them, and whether their consequences are not as exactly ruled by laws and as fully anticipated, as those of the instincts of animals.

Without entering fully on this abstruse question, we would take the liberty of remarking, in the view of placing it in its simplest form before our readers, that as the intimations of our own consciousness are the ultimate foundation of all the knowledge that we have or can have of our own minds, and as *certain* of the intuitive principles of belief which our minds naturally suggest to us *must* be trusted, if we are to inquire into the subject at all; so the only question that can be reasonably proposed on this point is, whether there is any good reason for suspecting that the belief of our own free-will, which naturally attends certain of the operations of our minds, is a deception; and that the analogy of other animals is only applicable to the subject in so far as it can throw light on that question.

Now, we find that the works of man, which we ascribe to his reason, and in the execution of which the consciousness of his free-will intervenes, are *essentially different* from those which we ascribe to the blind instincts of animals, in the total absence (already noticed) of that *uniformity* which is so leading a characteristic of the effects of the latter; and we may reasonably assert that this is just the difference to be expected between the works of man and of other animals, on the supposition that the power concerned in the former is not subject to the direct influence and control of that higher intellect, by which the laws and limits of that concerned in the latter are irrevocably set; and therefore, that there exists no such

analogy between the works of man and of other animals as need induce us to suspect, that the evidence of his consciousness on the point in question is not to be trusted.

At the same time it ought to be observed, and perhaps has not been duly remarked, not only that the desires which are the principal motives to human action, are analogous to, sometimes identical with, the instincts of animals, (many of them having been evidently given him with the same intention, and with a clear perception of their *general* result on his condition,)—but also that the constitution of the human mind appears from the intimations of our own consciousness to be such, as to allow of interposition of a superior power, controlling in a certain degree the will of man, without making itself obvious to his mind. For it is admitted by the soundest metaphysicians, that the only truly voluntary power which we are conscious of possessing over the train of thought in our minds, and therefore ultimately over many of our actions, operates only *indirectly*.^{*} We have no power of determining the thoughts that succeed one another or regulating the order of their succession; and although various laws of association have been laid down, by which many of the component parts of the train appear to be connected, yet it will hardly appear to any one who reflects on the operations of his mind, that *all* the thoughts which succeed one another can be ascertained to have such bonds of connection with one another. At all events, the only strictly voluntary power which we are conscious that we possess, is that of singling out and detaining any particular portion of the train, whereby it may be made to predominate in the mind, and to produce practical results which might not otherwise have followed; and even this kind of influence over the train of thought is not exercised exclusively by volition, but is produced in a great measure also by other causes, physical and moral. Now if this be so, how can we deny the possibility of a superior intelligence retaining a power of controlling the acts of any individual human mind, or of any number of minds, either by suggesting particular thoughts, or by causing the mind to dwell upon particular thoughts in preference to others, without its sense of its own voluntary power being interrupted or withdrawn,—nay, without the spontaneous voluntary power being really suspended, the only difference being in the *degree* of influence which it exerts over the train of thought and consequent volitions?

It has been said that the expression in Pope's Universal Prayer—

* “So completely is the current of thoughts in the mind,” says Stewart, “subjected to physical laws, that it has been justly observed by Lord Kames that we cannot, by an effort of our will, call up any one thought, and that the train of our ideas depends on causes which operate in a manner inexplicable by us. This observation, although it has been censured as paradoxical, is almost self-evident; for to call up any particular thought supposes it to be already in the mind.”—*Elements, &c.* ch. v. sect. 3.

“ And binding nature fast in fate,
Left free the human will,”

is inconsistent with a striking passage in the Essay on Man :—

“ Who knows but He whose hand the lightning forms,
Who heaves old ocean, and who wings the storms,
Pours fierce ambition in a Cæsar’s mind,
Or turns young Ammon loose to scourge mankind ?”

But if the foregoing statement of the mode of action of the only voluntary power which we are conscious of possessing over the train of our thoughts is correct, it does not appear possible to deny that ambition or any other passion may be infused into any human mind, without destroying the consciousness, or suspending the action of that voluntary power. And if we reflect on the characteristics of many nations that have appeared on the earth’s surface—on the taste and genius of the Greeks, the military spirit of the Romans, the restless energy of the northern nations, the maritime adventure and commercial enterprise of Britain and America—and contrast these with the stationary civilization of China, or the languid, if not retrograde condition of Italy, Spain, or Greece—is it unreasonable to suppose that the designs of Providence as to the progress of the human race are sometimes carried into effect by an occasional infusion into many individuals of our species, of feelings and desires, of the ultimate object of which they have as little perception as animals have of the purposes of their instincts? But to prosecute this speculation farther would be foreign to the object of this paper.

It is still to be remarked, in regard to instincts, that they have been long and justly regarded as among the most important phenomena in nature, in reference to the doctrine of final causes, or the inferences of design, and of the adaptation of means to ends in the arrangement of the universe; and it is important to set in as clear a view as possible the proper use to be made of them in that enquiry.

In fact, the whole plan of the construction of all the different classes of animals bears reference to the instincts with which they are endowed, and would be useless without them. If the fangs and claws of the lion, the jaws and stomachs of the ox or the camel, or the bill and gizzard of the turkey, are admirably adapted for the prehension and subdivision of their respective aliments, as well as their organs of digestion for the assimilation of their food, all these provisions would have been useless, but for the instincts which nature has implanted in these animals, by which their proper nourishment is sought, and the first part of the process of its assimilation is directed.

The mutual adaptation of instincts to structure, of structure to instincts, and of both to the ends of their creation throughout every part and function of an animal, and throughout every grade of the animal creation, has been illustrated by many authors, but perhaps most efficiently by Paley, as the most satisfactory of all the indications of the adaptation of means

to ends which the study of the universe presents.

It is indeed so clearly the fact that all the arrangements of the structure of an animal are subordinate to the instincts with which it is endowed, that the whole study of Comparative Anatomy, and the whole classification of animals in so far as it is founded on their varieties of structure, require to be regulated by this consideration. The general principle by which the details of these sciences are held together may be stated to be this :—that while nature has observed a certain unity of plan in the construction, certainly of all the vertebrated, perhaps to a certain degree of all, animals, she has likewise introduced in all parts of the scale just such modifications of that plan as the situation in which each animal is placed, and the office it has to perform, or as the French express it, as the conditions of its existence, demand; and then has implanted in it precisely such instincts as are required to enable it to maintain itself—to turn those provisions to account—to enjoy its allotted portion of sensitive pleasure, and to fulfil the other objects of its creation, under those conditions.

The study of the instincts of animals may be said, therefore, to hold a necessary intermediate place between the study of their structure, and that of the ends or objects of their creation—the structure being subordinate to the instincts, as these are subordinate to the objects of existence; and it is by attending to them that the immense extent and infinite variety of the adaptation of means to ends in the animal creation is perhaps most distinctly perceived.

It is stated by Mr. Whewell, that although the study of Final Causes has been often rejected from the science of Physiology, yet it has been found impossible to keep them separate. “The assumption of final causes in this branch of science is so far from being sterile, that it has had a large share in every discovery which is included in the existing mass of knowledge. The doctrine of the circulation of the blood was clearly and professedly due to the persuasion of a *purpose* in the circulatory apparatus.”* But there appears to be some ambiguity in this statement. The term physiology is properly applied to the investigation of the *physical* causes of the phenomena of life—of the powers which are in operation, and the conditions under which they operate, in producing these phenomena. It is true that the different functions of life are dependent on one another in any individual animal; and the science of physiology is most conveniently *taught* by arranging their functions in the order of their dependence, and assigning, therefore, the final cause of each, after explaining the manner in which it is carried on. It is true, also, that the study of the uses to which the different functions are subservient, *i. e.* the study of final causes, has often led to the *detection* of physical causes in this as in other sciences. But

* Hist. of the Inductive Sciences, vol. iii. p. 467.

the final cause cannot be substituted for the physical in physiology any more than in other sciences; and this is what was meant by the assertion of Bacon, that the doctrine of final causes is *sterile*. The object of physiology is to explain, not *why*, but *how*, the various functions of life are carried on. But when the laws of life are even partially ascertained, and their application understood, i. e. when physiological facts are referred to their physical causes, they afford many proofs of design and contrivance, and so furnish a most important addition to the general science of final causes.

The science, relative to living bodies, which may truly be said to have its foundations laid in the study of final causes, is the science of Comparative Anatomy, or of animal morphology; i. e. the exposition of the modifications which the general type of animal structure, and the plan of the functions carried on in that structure, undergo in the different classes of animals, and by means of which the objects of the animal creation are accomplished by the laws of physiology throughout the whole extent of creation. These modifications are determined by the circumstances in which animals are placed on the one hand, and by the purposes which they are to serve in the creation on the other. Every variation of structure has its use, in reference to one or other of these objects, and the branch of natural history which consists in the description and arrangement of these varieties cannot be properly treated otherwise than by keeping their uses constantly in view.

Thus, in regard to the function of digestion in the higher animals, its physiology, properly speaking, consists in reference to the laws of sensation, of instinct, of muscular motion, of secretion, as modified by changes in the condition of the nervous system, of absorption, and of vital affinities and assimilation so far as they are known, by which the reception of aliment, and the changes on the aliment received into the body are effected; in this enquiry our object is *explanation*, and however useful the observation of the purpose served by the organs of digestion may be, in suggesting enquiries or experiments by which the laws of which we are in quest may be made out, it is an interruption, not an assistance, to refer to these purposes, or to the importance of the function in the animal œconomy, as if we thus obtained an explanation of the phenomena: but when these different laws of vital action are explained, their adaptation to the object in view is properly stated as a branch of the doctrine of final causes. And when we trace the modifications which the organs and function of digestion undergo in the different tribes of animals, in the carnivorous, the herbivorous, and the graminivorous,—in the quadruped, the bird, the fish, the insect, the polype, &c., and compare these with the provisions for assimilation and nutrition in vegetables, our object is merely *description*, and the arrangement by which we must be guided in this department of natural history is clearly laid down by attention to the purposes which these modifications are intended to serve, as adapted to the circum-

stances and to the offices of animals, i. e. to their final causes.

As, in this science of morphology, or in tracing the varieties of “metamorphosed symmetry,” we do not seek to assign the physical causes of any phenomena, it is no abuse of the doctrine of final causes to assume it as the basis of our arrangements; and that the principle of the unity of plan in the animal creation, without the study of the conditions of existence of the different tribes of animals, by which it is modified, and of the instincts accompanying each modification, is truly *sterile*, was clearly shewn by Cuvier, and has been ably illustrated by Mr. Whewell.*

This observation is strictly applicable to the instincts of animals, considered as an essential element in their physiology. We obtain no *explanation* of the phenomena of instinct by referring to their use, or final cause; but the inferences drawn from the study of instincts, as to the existence and attributes of the Author of the universe, and the insight we thus acquire into the arrangements of the animal creation, are not, on that account, the less certain or the less important.

In order to perceive the extent and importance of these inferences, it is necessary to consider, as has been stated above, not only the mutual adaptation of structure and instincts to each other, but also the adaptation of both, in the case of every animal, first, to the purposes of its own œconomy, and secondly, to the purposes which it is fitted to serve in the general œconomy of nature.

Assuming, as we may safely do, that one great object, if not the most essential object, of all the arrangements of organized beings is to secure the greatest possible amount of sentient enjoyment throughout the world, the varying instincts and powers by which animals provide themselves with food will appear on consideration to be better adapted to the attainment of this end than they could have been on any other plan, consistently with the general laws, that animal enjoyment depends on the maintenance of organized animal structure, and this on the continual appropriation and assimilation of previously organized matter. The different races of animals are widely diffused over the globe by the powers which have been granted them of indefinite reproduction. Those of them which are immediately dependent on vegetables for subsistence are naturally limited by the extent of surface over which vegetation is spread; and when this limit has been attained, the only expedient that can increase the number of animals (and it may be added, one which at the same time varies and multiplies the kinds of animal enjoyments) is to make animals prey on one another, either in the living or dead state. “Such is the command given,” says Dr. Roget, “to countless hosts of living beings which people the vast expanse of ocean; to unnumbered tribes of insects which every spot of earth discloses; to the greater number of the feathered race, and also to a

* 1b. p. 472, et seq. .

more restricted order of terrestrial animals. To many has the commission been given to ravage and slaughter by open violence; others are taught more insidious, though not less certain arts of destruction; and some appear to be created chiefly for the purpose of quickly clearing the earth of all decomposing animal or vegetable materials (e. g. among the larger beasts of prey, the hyena, the jackall, the crow, and the vulture; among marine animals the crustacea and numerous mollusca, and among the lower orders, innumerable tribes of insects.)

“That a large portion of evil is the direct consequence of this system of extensive warfare, it is in vain to deny. But although our sensibility may revolt at the wide scene of carnage, our more sober judgment should place in the other scale the great preponderating amount of gratification which is the result. We must take into account the vast accession that accrues to the mass of animal enjoyment from the exercise of those powers and faculties which are called forth by this state of constant activity; and when this consideration is combined with that of the immense multiplication of life, which is admissible on this system alone, we shall find ample reason for acknowledging the wisdom and benevolent intentions of the Creator, who, for the sake of a vastly superior good, has permitted the existence of a minor evil.”*

This consideration is forcibly stated by Mr. Kirby in relation to one very numerous class of animals. “The object of the creation of the Arachnidans seems to have been to assist in keeping within due bounds the insect population of the globe. The members of this great and interesting class are so given to multiply beyond all bounds, that were it not for the various animals that are directed by the law of their Creator to make them their food, the whole creation, at least the organized part of it, would suffer great injury, if not total destruction, from the myriad forms that would invest the face of universal nature with a living veil of animal and plant devourers. To prevent this sad catastrophe, it was given in charge to the spiders, to set traps every where, and to weave their pensile toils from branch to branch and from tree to tree, and even to dive beneath the waters.” “The Scorpions and other Pedipalps are found only in warm climates, where they are often very numerous. Insects multiply beyond conception in such climates, and unless Providence had reinforced his army of insectivorous animals, it would have been impossible to exist in tropical regions. The animals we are speaking of not only destroy all kinds of beetles, grasshoppers, and other insects, but also their larvæ and eggs.”†

Without going into further details as to the adaptation of the instincts and powers of animals to their office in the world, we may remark, that there are two peculiarities attending many of the phenomena of Instinct, which make them perhaps more important than any others, as indications of Design in the universe.

1. The evidence of design and of intellect which is drawn from the instinctive actions of animals, is precisely similar to, and comes into strict comparison with, that by which each of us is informed of the mental qualities, and even of the mental existence of every human being except himself. What evidence have we of the existence of reason in any of our fellow-men? Only this, that their actions and their words, which are a set of definite muscular actions, appear obviously to be directed to certain ends, and fitted for the attainment of these ends. Therefore, we say, they indicate design or contrivance, i. e. reason or understanding, in the agents. The adaptation of means to ends is the indication of intellect, to which we yield practical assent every hour of our lives, and it would be a proof of deficiency of our own intellect if we failed to do so. Now, when we survey many of the instincts of animals, especially many of those which are directed to the preservation of their lives or the reproduction of their species,—when we see birds of all kinds building nests for their future progeny, and afterwards vivifying their eggs by incubation,—the salmon ascending rivers to deposit their eggs in contact with the atmosphere,—beavers constructing their houses,—bees or ants piling together their cells and collecting their stores,—the migratory birds repairing to warm climates before winter,—the reptiles excavating their winter retreats,—the squirrel, the dormouse, or the pika, laying up their winter store of provisions,—the snail closing its shell and securing its magazine of air for the return of spring,—the spider spinning its web, and preparing its cell and trap-door,—the ant-lion digging his pitfall,—the fishing-frog spreading his lines,—the camel storing his stomach with water for consumption in the desert,—the pelican filling her pouch with food for her young, and an infinity of other contrivances which the organs of animals enable them to execute, which they do execute day after day and year after year with perfect precision, and without which they could neither maintain their own existence nor perpetuate their species; it is plain that we are contemplating a set of living muscular actions, equally adapted to certain definite ends, and equally efficient for the attainment of those ends, as the words or actions of any human being; and we cannot, without obvious and gross inconsistency, decline to draw from them the same inference that we habitually deduce from the adaptation of means to ends by the muscular actions of human beings. And if we are satisfied by the considerations stated in the beginning of this paper, and, in the case of our own instinctive propensities, by the evidence of our own consciousness, that the reason and intelligence, and anticipation of consequences, which are concerned in, and may be inferred from, these instinctive actions of animals, are not the mental attributes of the animals themselves, we have no resource but to attribute their mental qualities to a superior Being, who gave to the first individual of each species of animals, and perpetuated to each race, its organic structure, its sensations, its muscular

* Bridgewater Treatise, vol. i. p. 46.

† Bridgewater Treatise, vol. ii. p. 302.

powers, and its instinctive propensities. Either directly or indirectly a Mind, and that not the mind of any living animal, must rule, according to general laws, the instinctive actions of all.

It is true that there have been, in all ages, some resolute sceptics, who do not assent to the proposition that design can be traced from its effects, or that the observed adaptation of means to ends authorizes us to infer the existence of an intelligent agent; but such a sceptic, if he be consistent, must also refuse his assent to the evidence of the existence of any sentient or intelligent being but himself. "How do I know," says Dr. Reid, "that any man of my acquaintance has understanding? I never saw his understanding. I see only certain effects, which my judgment leads me to conclude to be marks and tokens of it. But, says a sceptical philosopher, you can conclude nothing from these, unless past experience has informed you that such tokens are always joined with understanding. Alas, it is impossible I can have this experience. The understanding of another man is no immediate object of sight, nor of any other faculty which God has given me; and unless I can *conclude* its existence from tokens that are visible, I can have no evidence that there is understanding in any man."

In fact, the sceptical reasoner who refuses his assent to the intuitive judgment by which we infer design from its effects, can only be truly and thoroughly consistent if he place no faith in any intuitive truth, or first principle of belief, and therefore disbelieves the suggestions of his own consciousness. "To such a sceptic," says Dr. Reid, "I have nothing to say; but of the semi-sceptics, I should beg to know, why they believe in the existence of their own impressions and ideas. The true reason I believe to be, because they cannot help it; and the same reason will make them believe many other things."*

2. The evidence of design, which we deduce from the instinctive actions of man himself, has this striking peculiarity, that we are actually *conscious* of the propensities which excite them, and at the same time *know* that the purpose or design of these actions is not of our own contrivance. We may be said actually to *feel* the adaptation, designed by Nature, not by ourselves, of the constitution of our minds to the laws of external nature and to the wants of our bodily organization. The very same machinery, consisting of efforts of volition, of actions propagated along nerves, and of contractions of muscles, which we put in motion to accomplish any of those objects which our own intelligence and foresight enable us to understand, we here put in motion in obedience to propensities implanted in us by nature, with as little knowledge of the purpose which it is to serve, and in the first instance with as little knowledge of the pleasure it is to procure, as the heart that beats within us has of the nature and uses of the circulation which it supports. In the performance of every one of these actions, we

may truly say that the intelligent mind of man bows to the superior wisdom of the Author of Nature.

The speculations of Darwin on this subject seem intended to weaken the evidence as to the divine existence and attributes drawn from the phenomena of instinct, *first*, by attempting to explain the instinctive movements of young animals on the principle of irregular movements being first produced by uneasy sensations, and then those motions being selected, and voluntarily performed, which are found by experience to appease these sensations or procure pleasure; and *secondly*, by referring to the fact formerly stated, that most instinctive propensities are linked to, and, as he expresses it, "under the conduct of sensations and desires." The first of these assertions is quite inconsistent with what has been observed by others (as already remarked) in regard to the commencement of the instinctive actions in young animals.* As to the second, it is quite plain that the inference, which is drawn from the observed adaptation of means to ends in the phenomena of instinct, does not require that there shall be no mental antecedent exciting the instinctive propensity, but only that the mental antecedent shall not be an anticipation, grounded on reasoning, of the effect which the action will produce. Even if the immediate antecedent of every instinctive effort were a pleasing sensation, it would still be a fact, in the constitution of animals, that certain of their sensations, *and not others*, are naturally followed by certain definite muscular contractions, varying in the different tribes, and each adapted to a determinate end, known neither by experience nor by the reason of the animal exhibiting it; and this is the fact which justifies the conclusion in question. This has been already explained, and is so fully illustrated by Mr. Stewart in the answer, contained in his *Life of Dr. Reid*, to the criticisms of Darwin, that it is unnecessary to dwell upon it.

But although it is clearly no objection to the evidence of design and benevolence in the Author of Nature, drawn from the phenomena of instinct, that the instinctive propensities are often linked to and excited by certain pleasurable sensations, yet it is a strong indication of the superior power by which they are implanted in the different orders of animals, that when they are in full force, and the object to be accomplished by them is important, they have frequently power to supersede and subvert the motives, by which the ordinary actions of the same animals are regulated, and suspend the ordinary laws of their mental constitution, so as to induce an animal to persevere in actions attended with privation and fatigue and positive suffering. "It ought not to be forgotten," says Paley, "how much the instinct often *costs* the animal that feels it; how much (e.g.) a bird *gives up* by sitting on her nest,—how repugnant it is to her organization, her habits, and her pleasures. An animal formed for liberty

* *Essays on Intellectual Powers*, p. 621 et seq.

* See Kirby and Spence, *Introd. to Entomology*, vol. ii, p. 468.

submits to confinement at the very season when every thing invites her abroad ; an animal delighting in motion, made for motion, all whose motions are so easy and so free,—hardly a moment at other times at rest,—is for many hours of many days together fixed to her nest as closely as if her limbs were tied down by pins and wires. For my part, I never see a bird in that position, but I recognize an invisible hand, detaining the contented prisoner from her fields and groves, for a purpose, as the event proves, the most worthy of the sacrifice.”

(W. P. Alison.)

INTESTINAL CANAL. See STOMACH AND INTESTINAL CANAL.

IRRITABILITY ; etym. *irrito*, to irritate, stimulate, excite ; Syn. *contractility*, Dr. Bostock ; the *vis insita*, as distinguished from the *vis nervosa*, of Haller ; Germ. *Reizbarkeit* ; that peculiar vital power in the muscular fibre by which it *contracts* on being *stimulated*.

The term irritability is certainly not the best which might have been devised to express this vital power, for it only expresses the susceptibility of being irritated ; the term contractility is equally inadequate, for it only expresses the result or effect of irritation in peculiar textures ; the designation irrito-contractility, if not objectionable by its length, would in my opinion express the fulness of this property in the muscular fibre of animal bodies.

The term irritability was employed by Glisson, and some of its phenomena were not unknown to Harvey, Peyer, Baglivi, and other early physiologists ; but it is to Haller that we owe the accurate distinction of this principle from other principles in the animal œconomy, its full development, and its application to physiology. Many were the disputes in his own time as to the degree of his originality and merit in this matter, and Whytt proved a steady and persevering opponent to his claims ; but posterity has done him the justice which his contemporaries pertinaciously withheld ; and now whenever there is a doubt as to the meaning or acceptance of the term irritability, that doubt is at once dispelled by adding the epithet Hallerian.

The best *test* of the Hallerian irritability is the electric influence. It is by means of this agent that we detect the presence and the persistence of this vital power. Generally the parts which are originally most irritable preserve their irritability longest ; but we are not prepared to say that this is an invariable rule.

As galvanism is the best test of irritability, so a muscle, endowed with a high degree of irritability, becomes in its turn an excellent test of electricity ; and it was by the irritability in the muscles of the frog that Galvani first detected that form of electricity which has since borne his name, or that of galvanism.

It is an important question, whether the property of irritability belongs to the pure and isolated muscular fibre, or whether it belongs to this, combined with the nerves—the *nervo-muscular fibre*. The two textures cannot be separa-

ted, the muscular fibres cannot be isolated from the fine fibrillæ of the muscular nerves, and therefore the question cannot be determined by distinct experiment. But many facts, anatomical and analogical, would lead us to attach the term irrito-contractility, at least, to the *compound texture* ; the nervous portion receiving the stimulus, the muscular undergoing the contraction.

Why are the muscles which perform involuntary functions so richly endowed with nerves ? Some of the disciples of Haller, and especially Behrens, contended, indeed, that the muscular structure of the heart, for example, was not supplied with nerves. The anatomist whom I have just quoted wrote a treatise entitled, “*Dissertatio quâ demonstratur Cor Nervis carere*,” in which he asserted that the cardiac nerves were distributed entirely to the bloodvessels ; to this the celebrated Scarpa triumphantly replied in his “*Tabulæ Neurologicæ Cardiacorum Nervorum*,” &c.

Dr. A. P. W. Philip has placed himself at the head of the Hallerian school of the present day : Legallois had asserted that the spinal marrow was the constant and essential source of the action of the heart, which accordingly ceased when the influence of the spinal marrow was removed. But Dr. Philip detected a source of fallacy in Legallois’ experiments, and discovered that although to *crush* the spinal marrow suddenly, as in those experiments, suspended the action of the heart, yet that the spinal marrow might be slowly and gradually destroyed, and the action of the heart still remain uninterrupted. Similar experiments were afterwards made with similar results by M. Flourens, and published in his admirable “*Recherches sur le Système Nerveux*,” p. 18. But though Dr. Philip has the merit of detecting the error of Legallois and of establishing the fact that the circulation may continue after the destruction of the spinal marrow, he has totally failed in proving that the action of the heart is independent of the nervous system, and that the irritability of Haller is exclusively a muscular power. It should be remembered that, after the removal of the brain and spinal marrow, the grand centres of the nervous system, the ganglionic or subsidiary nervous centres, remain, and that even after the removal of the heart from the animal body altogether,—in which case I have proved that its power of maintaining the circulation remains,—* there are still probably as many nervous as muscular fibres ; and we know that the nerves themselves possess, independently of the nervous centres, the *vis nervosa*, or power of exciting under the influence of stimuli, the muscular fibre to contraction.

I have also positively ascertained that after the destruction of the brain and spinal marrow in the eel, the heart is susceptible of being impressed through the medium of the ganglionic system. “*In an eel, in which the brain had been carefully removed, and the*

* See my Essay on the Circulation of the Blood, p. 121.

spinal marrow destroyed, the stomach was violently crushed with a hammer. The heart, which previously beat vigorously sixty times in a minute, stopped suddenly and remained motionless for many seconds. It then contracted;—after a long interval it contracted again, and slowly and gradually recovered an action of considerable frequency and vigour.”*

Dr. W. C. Henry has added an argument in favour of the theory of neuromyic action of another kind. It is known that certain narcotics, applied to nerves, destroy the *vis nervosa* of that part. Dr. Henry found that “a solution of opium injected into the cavities of the heart, or introduced into the intestine, immediately arrested the actions of these organs.”† It seems difficult to imagine that this effect of the narcotic was not produced through the medium of the nervous fibrillæ, the muscular being defended by the internal lining of these organs respectively, in the latter organ, a mucous membrane.

After much consideration given to this subject, we should be disposed to conclude that in the phenomena of muscular action, the stimulus acts upon the nervous fibre, and that the contraction is an effect and the property of the muscular fibre.

If this view be correct, we are necessarily led to consider the *vis insita*, or muscular power, in connection with the *vis nervosa*. This latter power is peculiar to certain parts of the nervous system. It is not possessed by the cerebrum or cerebellum, or by the ganglia; but it exists in the tubercula quadrigemina, the medulla oblongata, the medulla spinalis, and the muscular nerves. The heart itself has recently been observed by Burdach to contract on stimulating the cardiac nerves by galvanism.

We owe the discovery of the distinct limitation of the *vis nervosa*, or, as he terms it, the “excitabilité,” to M. Flourens.‡

The following were the supposed laws of action of the *vis nervosa* by Haller, Bichât, and Professor Müller, before I began my own researches on this subject:

Haller observes, “Irritato nervo, convulsio in musculo oritur, qui ab eo nervo ramos habet.” “Irritato nervo, multis musculis communi, totive artui, omnes ii musculi convelluntur, qui ab eo nervo nervos habent, sub sede irritationis ortos. Denique medulla spinali irritata, omnes artus convelluntur, qui infra eam sedem nervos accipiunt; neque contra artus, qui supra sedem irritationis ponuntur.” He concludes, “conditio illa in nervo, quæ motum in musculis ciet, desuper advenit, sive a cerebro et medulla spinali, deorsum, versus extremos nervorum fines propagatur.” And—“ut adpareat causam motus a trunco nervi in ramos, non a ramis in truncum venire.”§

Bichât observes, “l'influence nerveuse ne se propage que de la partie supérieure à l'inférieure, et jamais en sens inverse. Coupez un

nerf en deux, sa partie inférieure irritée fera contracter les muscles subjacens; on a beau exciter l'autre, elle ne détermine aucune contraction dans les muscles supérieurs; de même la moëlle, divisée transversalement et agacée en haut et en bas, ne produit un effet sensible que dans le second sens. Jamais l'influence nerveuse ne remonte pour le mouvement, comme elle le fait pour le sentiment.”*

Lastly, Professor Müller observes, “the motor power acts *only* in the direction of the primitive nervous fibres going to muscles, or in the direction of the branches of the nerves; and *never backwards*;” and “*all* nervous fibres act in an isolated manner from the trunk of a nerve to its ultimate branches.”†

It is a singular circumstance, that an established fact in *experimental* research, an established *principle* of muscular action in the animal œconomy, should be without application to physiology. Yet such has been the case. For what is the application of the *vis nervosa* to the explanation of the functions of the animal œconomy?

Before any such application could be made, it was necessary that other modes of action of this power should be ascertained. I have, by a series of experiments, determined *new laws* of action of the *vis nervosa*, and have thus been enabled to make an extensive application of the principle to the functions of life.

The head of a river tortoise being separated between the third and fourth vertebæ:

1. The dorsal portion of the spinal marrow was laid bare to the extent of one inch below the origin of the brachial nerves; the spinal marrow was then excited by means of the probe and by galvanism; both anterior and posterior extremities, with the tail, were moved.

2. A lateral intercostal nerve was then laid bare, and stimulated in the same manner; the same effects were produced as in the former experiment.

These experiments have been repeated many times, and I performed them in the presence of M. Serres and other gentlemen at Paris, in the month of August, 1839. They establish the following *new laws* of action of the *vis nervosa*:—

1. That it does act in the direction from branch to trunk;

2. That it is in a *retrograde* direction in the spinal marrow.

The application of these new laws to physiology—the first application of the *vis nervosa* to physiology—is very extensive, co-extensive indeed with all the acts of ingestion and egestion in the animal œconomy. But it does not belong to our present article to treat of this important and extensive subject. We now return to that of irritability in general.

The degree of irritability is not the same in every organ of the body. Haller and Nysten have investigated this subject, and the following are their statements respectively:

Haller observes, “Tenacissima virium insin-

* Anatomie Générale, 2de partie, t. iii. p. 277-278, éd. 1801.

† Handbuch der Physiologie, i. 656.

* Op. cit. p. 160.

† Abstracts of papers read before the Royal Society, vol. iii. p. 65.

‡ Op. cit. p. 16, &c.

§ Elementa Physiologiæ, Lausannæ, t. iv. p. 335.

tarum intestina sunt, quæ et evulsa pergunt se contrahere et frigida demum; etiam his tenacius cor, si omnia computaveris, in pullo etiam evidentissime et in frigidis animalibus.*

The observations of Nysten are more extensive, and his inferences were deduced from experiments made upon the human subject immediately after decapitation. They are as follow:

"1. La contractilité du ventricule aortique était éteinte 49 minutes après la mort;

"2. L'aorte n'a offert aucun mouvement de contraction;

"3. Cinquante-six minutes après la mort, la contractilité de l'estomac, des intestins et de la vessie était éteinte; mais ces organes n'ont pu être soumis assez promptement au galvanisme pour connaître la durée relative de leur force contractile;

"4. Le ventricule pulmonaire perdit sa contractilité une heure 58 minutes après la mort;

"5. Deux heures 2 minutes après la mort, le diaphragme ne se contractait plus; les muscles de l'appareil locomoteur perdirent successivement leur contractilité à mesure que le contact de l'air agissait sur eux; mais ceux qui ne furent exposés à l'air que tard, par exemple au bout d'environ 4 heures, ne cessèrent de se mouvoir que 4 heures 15 minutes après la mort;

"6. Les oreillettes du cœur, qui étaient exposées à l'air depuis le commencement de l'expérience, ne cessèrent de se contracter que 4 heures 40 minutes après la mort."†

But if there be a difference in the irritability of different organs in the same animal, there is a still greater difference in the different animals themselves of the zoological scale. It may be stated in general terms, that the degree of the irritability in the different parts of the animal series, as tested by galvanism, is inversely as the quantity of the respiration; so that in the reptile tribes, in which the respiration is exceedingly low, the irritability of the muscular fibre is such as to afford a delicate test of galvanism; and in birds, in which the respiration is at its maximum, the irritability exists in its lowest degree.

This important subject deserves the fullest development. We shall here, therefore, insert some observations which were read to the Royal Society, and published in the Philosophical Transactions in 1832.

The due actions of life, in any part of the zoological series, appear to depend upon the due ratio between the quantity of atmospheric change induced by the respiration, and the degree of irritability of the heart: if either be unduly augmented, a destructive state of the functions is induced; if either be unduly diminished, the vital functions languish and eventually cease. If the bird possessed the degree of irritability of the reptile tribes, or the latter the quantity of respiration of the former, the animal frame would soon wear out. If, on the contrary, the bird were reduced to the quantity of respiration appropriate to the

reptile, or the latter to the degree of irritability which obtains in the former, the functions of life would speedily become extinct. Various deviations from the usual proportion between the respiration and the irritability, however, occur, but there is an immediate tendency to restore that proportion; increased stimulus exhausts or lowers the degree of irritability, whilst diminished stimulus allows of its augmentation. The alternations between activity and sleep afford illustrations of these facts.

Changes in anatomical form in the animal kingdom present other illustrations of the law of the inverse proportion of the respiration and irritability. The egg, the fœtus, the tadpole, the larva, &c. are respectively animals of lower respiration, and of higher irritability, than the same animals in their mature and perfect state. Changes in physiological condition also illustrate the same law. The conditions of lethargy, and of torpor, present examples of lower respiration, and of higher irritability, than the state of activity.

It may be remarked that whilst changes in anatomical form are always from lower to higher conditions of existence, changes in the physiological condition are invariably from higher to lower.

These views are further illustrated by a reference to the quantity of stimulus and the degree of irritability of each of the parts and organs of the animal system. The oxygen of the atmospheric air is the more immediate and essential stimulus of this organ. Taken up in respiration, it is brought into contact with the heart, by means of the blood, which may be considered as the carrier of this stimulus, as it is of temperature and nutriment, to the various parts of the system. As oxygen is the principal stimulus, the heart is the principal organ of irritability, in all the vertebrated animals; if the contact of oxygen be interrupted, all perish in a greater or less period of time.

The extraordinary differences which exist in animals which occupy different stations in the zoological scale, have long excited the attention of naturalists. Nor have the differences which obtain in the various ages and states of its existence, in the same animal, escaped the attention of the physiologist. A similar remark applies to that singular state of existence and of the functions of life, designated hibernation. But it appears to me that a sufficiently comprehensive view has not been taken of the subject, and that many facts, with their multitudinous relations, still require to be determined.

I. *Of the pneumatometer.*—The principal of these facts is that of the quantity of respiration. This is greater in proportion as the animal occupies a higher station in the zoological scale, being, among the vertebrated animals, greatest of all in birds, and lowest in fishes; the mammalia, the reptiles, and the amphibia occupy intermediate stations. The quantity of respiration is also remarkably low in the very young of certain birds which are

* Haller, *Primæ Lineæ*, 1767, p. 207.

† *Recherches de Physiologie*, 1811, p. 312.

hatched without feathers, and of certain animals which are born blind; and in hybernation it is almost extinct.

To ascertain the quantity of respiration in any given animal, with extreme minuteness, was a task of great difficulty. It was still more difficult to determine this problem, so as to represent the quantities of respiration in the different kinds, ages, and states of animals, in an accurate series of numbers. The changes induced in a given volume of air made the subject of experiment, by changes in the temperature and pressure of the atmosphere, and by variations in the height of the fluid of a pneumatic trough, which it is so difficult to appreciate minutely; the similar changes induced by the humidity of expired air, and by the heat of the animal itself, were so many and complicated, that it appeared almost impossible to arrive at a precise result. These difficulties, in fine, were such as to lead one of the first chemists of the present day to give up some similar inquiries in despair.

Fortunately I have been enabled to devise an apparatus which reduces this complex problem to the utmost degree of simplicity. I now beg the indulgence of the reader whilst I give a detailed description of its construction and mode of operation.

This apparatus, which I shall designate the *pneumatometer*, consists of a glass jar (*fig. 1, a, b,*) inverted in a mercurial trough (*c, d,*) so grooved and excavated, as accurately to receive the lower rim of the jar and the lowest part of the tube (*e, f, g,*) and also to admit of the animal which is made the subject of experiment, being withdrawn through the mercury. This jar communicates, by means of the bent tube (*e, f, g, h,*) with the gauge (*i, j,*) which is inserted into a larger tube (*k, l,*) containing water. A free communication between the jar and the external air is effected and cut off, at any time, by introducing and withdrawing the little bent tube (*m, n,*) placing the finger upon the extremity (*m,*) whilst the extremity (*n,*) is passed through the mercury.

If the jar be of the capacity of one hundred cubic inches, the gauge is to contain ten, and to be graduated into cubic inches and tenths of a cubic inch; so that each smallest division shall be the thousandth part of the whole contents of the jar.

Attached to the same mercurial trough is placed a little apparatus (*o, p,*) termed an *ærometer*, and consisting of a glass ball (*o,*) of the capacity of ten cubic inches, communicating with a tube (*p, q,*) bent at its upper part, of the capacity of one cubic inch, di-

Fig. 1.

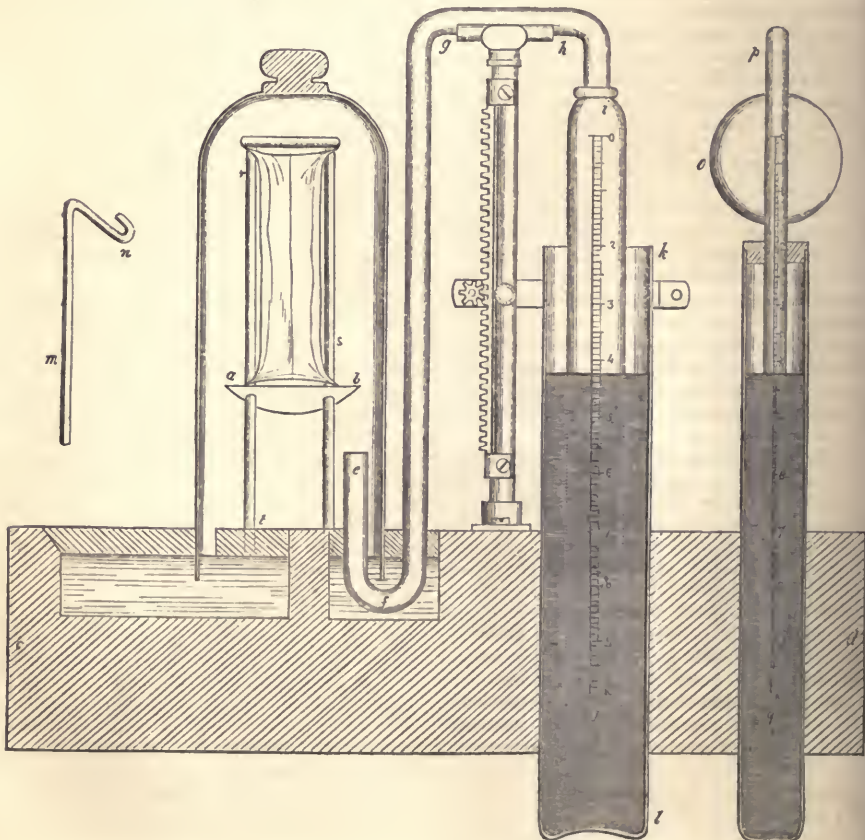

vided into tenths and hundredths, and inserted into a wider tube containing water, precisely in the manner of the gauge (i, j .) In order to secure the exact proportion between the capacity of the pneumatometer and that of the aërometer, it is only necessary to add more or less of mercury to the trough.

The whole apparatus is inclosed in a glazed frame so as entirely to obviate the influence of partial currents of air. It is plain that changes in external temperature and pressure will affect both these parts of the apparatus equally; and that the fluids in the gauge (i, j .) and in the tube (p, q .) will move *pari passu*. It is therefore only necessary to compare them, and to take the difference, for the real alteration in the quantity of the gas in the jar.

Previously to noticing this difference, the fluids in the outer and inner tubes are to be brought accurately to the same level, by raising or depressing the outer tube (k, l .) and the inner one (p, q .)

In order that the air within the jar and that in the aërometer may be in the same state of humidity, a little water is introduced into the glass ball (o .) of the latter.

When the animal is to be removed, the fluid in the inner and outer tubes of the gauge are to be brought to a precise level; the animal is then to be withdrawn through the mercury, by a cord attached to the little net or box in which it is secured; a quantity of fluid will immediately rise in the inner tube, (i, j .) equal to the bulk of the animal; the bent tube (m, n .) is now to be passed through the mercury into the jar so as to effect a communication with the atmospheric air; a portion of air equal to the bulk of the animal rushes into the jar, whilst the fluids in the gauge regain their level.

To avoid the error which would arise from the influence of the temperature of the animal upon the air within the jar of the pneumatometer, the first observation of the degree upon the gauge must be made the instant the experiment is begun, and before the temperature of the animal can have been communicated to it; and the last, so long after the animal has been withdrawn as to allow of its restoration to the temperature of the atmosphere.

In this way all calculations for the varied temperature and pressure of the external air, for augmented humidity and temperature of the air of the pneumatometer, and for the changes in the height of the fluid of the trough, are at once disposed of in a manner the most accurate and simple.

It now remains to determine the quantity of change induced upon the air of the pneumatometer, by the respiration of the animal. Two views may be taken of this change; that of Messrs. Allen and Pepys, that the oxygen which disappears is replaced by a precisely equal bulk of carbonic acid; or that of M. Edwards, that there is generally an excess of the oxygen which disappears over that of the carbonic acid evolved. In either case the quantity of respiration is ascertained by the

gauge of the pneumatometer in the following manner. A frame made of glass rods (r, s .) is placed within the jar (a, b .) suspending portions of calico, imbued with a strong solution of pure potassa, and provided with a small dish of wood, so as to prevent the caustic liquid from dropping upon the animal beneath. By this means the carbonic acid is removed as it is evolved, or after the animal is withdrawn. The rise of the fluid in the gauge of the pneumatometer gives the quantity of oxygen which disappears,—whether this be entirely exchanged for carbonic acid, or only partly exchanged for carbonic acid, and partly absorbed, —and denotes the precise quantity of the respiration.

The question itself, of the entire or partial exchange of the oxygen gas which disappears, for carbonic acid gas evolved, is at once determined by employing the same apparatus without the solution of potassa: in the entire exchange, there is no alteration in the bulk of the air of the pneumatometer; in the case of a partial exchange, the alteration in the bulk of the air gives the precise excess of oxygen gas which disappears, over the quantity of carbonic acid evolved.

But this question, and that of the absorption and evolution of nitrogen, with the influence of night and day, of season, &c. are reserved for a future stage of this inquiry.

It is important that the animal should be left for a considerable time in the very situation in which it is to remain during the experiment, before that experiment is begun, and before the jar is placed over it. In this manner the effect of timidity or restlessness is allowed to subside, and prevented from mingling with that of the natural state of the respiration. A bit of cork must also be attached to the mercurial trough, so as to float upon the mercury at t , and prevent the disturbing effect of the contact of this fluid with the animal.

It is also well, after having placed the jar in the groove of the mercurial trough, to pour a little water over the mercury exterior to the jar. The apparatus is thus rendered perfectly air-tight, which is not always effected by the mercury alone.

By means of this apparatus we readily and accurately determine the quantity of the respiration of any given animal, in any given circumstances.

II. *Of the measure of the irritability.*—The problem to be next determined is that of the degree of irritability of the muscular fibre, and especially of the heart. The question is beset with scarcely fewer or less difficulties than that of the quantity of respiration, whilst it involves far greater errors and more discrepancy of opinion on the part of physiologists.

Even Baron Cuvier has fallen into these errors. It will be shortly demonstrated that the degree of irritability is, in every instance, inversely as the quantity of respiration. Yet M. Cuvier, in a remarkable paragraph, states the very contrary, and even speaks of that which is the exhauster, as the repaireur, of the

irritability; whilst, on the other hand, he makes statements which appear to me at variance with this very opinion. In the *Anatomie Comparée* (tome i. p. 49.) this celebrated writer observes, "Les expériences modernes ont montré qu'un des principaux usages de la respiration est de ranimer la force musculaire, en rendant à la fibre son irritabilité épuisée." See also tome iv. p. 301. Similar observations are made in M. Cuvier's more recent work, the *Règne Animal*: "C'est de la respiration que les fibres musculaires tirent l'énergie de leur irritabilité," (tome i. p. 57, 2me edit.) "C'est la respiration qui donne au sang sa chaleur, et à la fibre la susceptibilité pour l'irritation nerveuse," (tome ii. p. 1.) On the other hand, speaking of the mollusca, (tome iii. p. 3.) M. Cuvier observes of those animals of low respiration, "L'irritabilité est extrême dans la plupart." The same term is, in fact, used in two distinct senses, in these paragraphs.

No further proof can be necessary of the extreme vagueness and incorrectness of the prevailing notions and expressions of physiologists in regard to this subject. All this will appear still more extraordinary, when the law, that the quantity of respiration and the degree of the irritability are, in fact, inverse throughout all the series, stages, and states of animated being, is clearly established.

It is well known that the irritability of the heart and of the muscular fibre in general is greater in the mammalia than in birds, and in reptiles and amphibia than in the mammalia, whether we judge of it by the force and duration of the beat of the heart, exposed to the stimulus of the atmospheric air, or by the contractions of the other parts of the muscular system. Now this is precisely the order of the quantity of respiration in these animals, as ascertained by the pneumotometer, inverted. It is essential, in accurately determining the question of the irritability of the muscular fibre, to compare animals of the same class inter se; birds and the mammalia, reptiles and amphibia, fishes, the mollusca, &c. must be compared with each other, both generically and specifically. It is especially necessary to compare the warm-blooded, the cold-blooded, the air-breathers, and the water-breathers, in this manner. However the different classes may differ from each other, there are differences in some of the species of the same class, and especially that of fishes, scarcely less remarkable.

Great differences in the duration of the beat of the heart are observed in fetal, early, and adult states of the higher animals; this duration being greater in the first, and least in the last of these conditions. The order of the quantity of respiration is inverse.

The law of the irritability being inversely as the respiration, obtains even in the two sides of the heart itself, in the higher classes of animals. The beat of the heart removed from the body does not cease at the same time in the wall of all its cavities, or of its two sides: but, as Harvey observes, "primus desinit pulsare sinister ventriculus; deinde ejus auricula; de-

num dexter ventriculus; ultimo (quod etiam notavit Galenus) reliquis omnibus cessantibus et mortuis, pulsatur usque dextra auricula."*

Even in this case the irritability is greatest in the part in which the respiration is least.

It was shown by Hook, in the early days of the Royal Society,† that if, the respiration being suspended, an animal appeared to be dying, the beat of the heart and the signs of life were speedily restored, on performing artificial respiration, or even by forcing air through the trachea, bronchia, and pulmonary air-cells and allowing it to escape through incisions made through the pleura.

It was, in the next place, clearly shown by Goodwyn, in one of the most beautiful specimens of physiological inquiry in any language,‡ that in suspended respiration, it is the left side of the heart which first ceases to contract, the right side still continuing its function for several minutes, until the supply of blood may be supposed to fail.

The facts detailed by Harvey had shown that the left side of the heart was endued with less irritability than the right; the experiment of Hook, that respiration restored the action of the heart, if it had previously ceased; that of Goodwyn, that this cessation and restoration of functions were observed in the left side of the heart. It was obvious, on the other hand, that the respiration belongs, as it were, to the left side of the heart.

It appears plainly deducible from these facts that in circumstances and structures the most similar, the respiration is accurately inversely as the irritability.

For the sake of a comparison with the hibernating animal, the object of which will be explained hereafter, I thought it right to repeat this experiment.

Before I proceed to detail the result, I may just describe an easy method of performing that part of it which consists of artificial respiration. A quill is firmly fixed in the divided trachea: a small hole is then cut into that part of the quill which is external; Read's syringe is then adapted to the other end of the quill. At each motion of the piston downwards, the lungs are distended; whilst the piston is raised, the air escapes through the opening in the quill, producing expiration. The experiment, therefore, only requires the common action of the syringe.

The experiment itself answered my expectation. During the cessation of respiration, the left ventricle ceased to beat, the right ventricle retaining its function; on renewing its respiration, the left ventricle resumed its beat. It appears from this experiment, that from want of a degree of irritability equal to that of the right ventricle, and its own proper stimulus of arterial blood, the left ventricle ceased its contractions. The function of the right ventricle

* Opera Omnia, Collegio Medicorum Londinensi edita, 1766, p. 28.

† Phil. Trans. vol. ii.

‡ On the Connexion of Life with Respiration: London, 1783, p. 72, 82 note.

must soon cease in consequence, from want of a supply of blood.

These facts prove that arterial blood is the necessary stimulus of the left side of the heart, its irritability being low; but that venous blood is a sufficient stimulus of the right, from its higher irritability: the phenomena plainly flow from the law, that the quantity of respiration and the degree of irritability observe an inverse ratio to each other, and from the facts on which that law is founded. In this double sense, besides that of distinct cavities, the mammalia have, therefore, two hearts; and as the highly aerated blood of the left is the peculiar property of birds and the mammalia, so the highly irritable fibre of the right may be compared to that of the heart of reptiles and the fishes.

Except for the objection to new terms, the left side of the heart might be termed arterio-contractile, and the right veno-contractile; the first being stimulated by arterial, the second by venous blood.

It is quite obvious that the heart will bear a suspended respiration better, the more nearly its irritability approaches to that which may be designated veno-contractile. *The power of bearing a suspended respiration thus becomes a measure of the irritability.* It is expressed, numerically indeed, by the length of time during which the animal can support a suspended respiration; a conclusion of the highest degree of importance in the present inquiry.

Birds die almost instantly on being submerged in water; the mammalia survive about three minutes, the reptiles and the batrachia a much greater length of time.

The unborn fœtus, the young animal born with the foramen ovale open, the reptile, the mollusca, having all a state of the heart approaching to the veno-contractile, bear a long-continued suspension of the respiration, compared with the mature animal of the higher classes.

But the most remarkable fact deducible from this reasoning is the following: if such a case existed as that of the left side of the heart being nearly or absolutely veno-contractile, such an animal would bear the indefinite suspension of respiration; such an animal would not drown though immersed in water. Now there is precisely such a case. It is that of the hibernating animal. It may be shown that in the state of perfect hibernation the respiration is nearly suspended; the blood must, therefore, be venous. See HYBERNATION. Yet the heart continues to contract, although with a reptile slowness. The left ventricle is, therefore, veno-contractile, and in this sense, in fact, sub-reptile. The case forms a solitary exception to the law pointed out by Harvey, that the left ventricle ceases to contract sooner than the right. If in the hibernating animal the left ventricle does cease to beat sooner than the right, it is only in so slight a degree as to be referred to the greater thickness of its parietes, and the slight degree in which respiration still remains. It is obvious that the foregoing statement must be taken with its due limitations.

Venous blood is unfit for the other animal purposes, even though it should stimulate the heart to contraction.

Another mode of determining the degree of irritability, is the application of stimuli, as galvanism. A muscular fibre endowed with high irritability, as that of the frog, and the galvanic agency are mutually tests of each other.*

A third criterion and measure of the irritability is afforded by the influence of water at temperatures more or less elevated, in inducing permanent contraction of the muscular fibre.

There are two other properties of animals which depend upon the varied forms of the inverse ratio which exists between the respiration and the irritability. The first is *activity*, the second, *tenacity of life*.

The activity, which, I believe, M. Cuvier has confounded with the irritability, is generally directly proportionate to the respiration, and intimately depends upon the condition of the nervous system resulting from the impression of a highly arterial blood upon its masses, and not upon the degree of irritability of the muscular fibre. It is the pure effect of high stimulus.

To show that M. Cuvier has blended the idea of the irritability of the muscular fibre with that of the activity of the animal, it is only necessary to recur to the passages already quoted from that author, and to adduce the observations with which they are connected. "On vient de voir à quel point les animaux vertébrés se ressemblent entre eux; ils offrent cependant quatre grandes subdivisions ou classes, caractérisées par l'espèce ou la force de leurs mouvements, qui dépendent elles-mêmes de la quantité de leur respiration, attendu que c'est de la respiration que les fibres musculaires tirent l'énergie de leur irritabilité."† "Comme c'est la respiration qui donne au sang sa chaleur, et à la fibre la susceptibilité pour l'irritation nerveuse, les reptiles ont le sang froid, et les forces musculaires moindres en totalité que les quadrupèdes, et à plus forte raison que les oiseaux; aussi n'exercent-ils guère que les mouvements du ramper et du nager; et, quoique plusieurs sautent et courent fort vite en certains moments, leurs habitudes sont généralement paresseuses, leur digestion excessivement lente, leurs sensations obtuses, et dans les pays froids ou tempérés, ils passent presque tous l'hiver en léthargie."‡

It is extraordinary that M. Cuvier should have associated the elevated temperature of the blood with a high irritability of the muscular fibre, when they are uniformly separated in nature, and are, indeed, absolutely incompatible in themselves. The muscular fibre of the frog is so irritable, that it would instantly pass into a state of rigid contraction, if bathed with a fluid of the temperature of the blood of birds.§

* Bostock on Galvanism, pp. 4, 14.

† Le Règne Animal, tome i. pp. 56, 57. 2de edit.

‡ Ibid. tome ii. pp. 1, 2. 2de edit.

§ See an Essay on the Circulation, chap. vii. pp. 180, 181.

The same confusion of ideas on the subject of the activity of the animal and the irritability of the muscular fibre prevails, I believe, amongst our own physiologists; at least, in conversation with two, who may rank amongst the first, I found that they had uniformly considered the respiration and the irritability to be directly, instead of inversely, proportionate to each other.

That singular and interesting property of the lower orders of animals termed *tenacity of life* is, on the other hand, distinctly associated with a high degree of irritability of the muscular fibre. The property may be defined as consisting of the power of sustaining the privation of respiration, the privation of food, various mutilations, divisions, &c. It is greater as we descend in the zoological scale. As activity depends upon the presence and condition of the spino-cerebral masses acted upon by arterial blood, tenacity of life depends upon the diminution or absence of these masses and of this highly arterialized blood, being greatest of all in those animals which approach a mere muscular structure. Almost the sole vital property then remaining is the irritability; and this property does not immediately suffer from division.

It is possible to reduce some of the reptile tribes to a state approaching that of animals still lower in the scale, by removing, by very slow degrees, successive portions of the nervous masses. This is most readily done in animals in which the respiration is already low, and the irritability high, as in the fœtus, in the very young animal, in the reptile, &c., as in the experiments of Legallois,* M. Serres,† myself,‡ &c.

There is, even in animals most tenacious of life, one kind of mutilation—one kind of injury not well borne. As the blood is in its lowest condition of stimulus, it cannot be withdrawn with impunity; even frogs soon perish if their blood be allowed to flow. As the irritability, on the other hand, is high, certain stimuli, as galvanism, slightly elevated temperatures, &c. are speedily fatal. The batrachia are promptly destroyed by immersion in water of a temperature of 108° of Fahr., and some fish and crustacea perish in great numbers under the influence of a thunder-storm. It is a singular fact, that the fish alone, whose food is found amongst animals of a high irritability, should possess an electrical organ for the destruction of its prey.

The application of stimulus has uniformly a tendency to reduce the degree of irritability. The exclusion of all stimuli allows its augmentation. During active exercise the irritability is diminished; during sleep it is proportionally augmented.

We are now led to take another view of this subject of irritability. What is its source? How is it renewed when it has been exhausted? These questions lead us to take up another of great interest, to

physicians especially, viz. what is the condition of the muscular irritability in those cases in which the influence of the cerebrum, or of the spinal marrow, or both, is removed respectively? We cannot discuss this subject more clearly than by adducing the following observations, read before the Royal Medico-Chirurgical Society and published in its Transactions, in the year 1839.

The utmost discrepancy of opinion prevails amongst physiologists and medical writers upon this subject. Prochaska, Nysten, and Legallois state, that the irritability of the muscular fibre remains in paralytic limbs; whilst Professor Müller and Dr. Sticker assert the contrary. No attempt has been made to reconcile a contradiction not very honourable to our science. To explain this discrepancy of opinion is one of the objects of this communication.

The authors to whom I have referred, misled by the generic term and idea of paralysis, have not sufficiently distinguished between its different species. Yet it will be found, as we proceed, that this distinction is of the utmost importance in the explanation of the phenomena. In fact, cerebral paralysis, or that which removes the influence of the brain, and spinal paralysis, or that which removes the influence of the spinal marrow, are in totally opposite conditions in reference to the irritability of the muscular fibre in the limbs severally affected; facts equally obvious in experiments and in clinical observations. I must make quotations of some length, for these are necessary to show the present state of the science. I shall then proceed to the detail of my own investigations.

The first distinct notice of this subject which I think it necessary to adduce, is contained in the following extract from the Opera Minora of Prochaska:* “Vis nervosa quæ in nervis a commercio cum cerebro separatis superest, non unâ alterâve musculi contractione, quam irritati cient, exhauritur, sed millenis plane convulsionibus excitandis par est; quod expertus sum in ranâ, cui medullam spinalem in dorso abscondi. Supervixit huic vulneri aliquot diebus; interim irritando medullæ spinalis partem eam, quæ erat infra sectionem, convulsiones in artubus inferioribus excitavi toto tempore, quo supervixit, planè innumeras; neque extremitates inferiores prius mortuæ sunt, quam tota rana; Dein quod vis nervosa in nervis diu persistere possit citra cerebri auxilium probare videntur musculi paralytici, in quorum nervis ob compressionem aliquam præternaturalem totum commercium cum cerebro sublatum est, nihilominus tamen à stimulo electricæ scintillæ longo jam tempore paralytici musculi convelluntur.”

More detailed remarks were made by Nysten, and these, from being founded upon very distinct post-mortem experiments on the human subject, have excited more attention. This celebrated physiologist observes, “Chez deux apoplectiques qui avaient succombé au bout de

* Experiences sur le Principe de la Vie.

† Anatomie Comparée du Cerveau, tome ii. p. 224.

‡ Essay on the Circulation, chap. iii. § 1.

* Ed. 1800, p. 84.

quelques jours, l'un à la première attaque et l'autre à la seconde, le galvanisme a déterminé des contractions aussi fortes dans les muscles du côté sain que dans ceux du côté paralysé : les iris des deux côtés sont également contractés." " Cette propriété n'a été complètement anéantie dans les organes musculaires des deux sujets qu'environ 12 heures après la mort ; et on n'a observé aucune différence dans les muscles paralysés.*

Legallois makes similar remarks, founded upon experiments made upon animals. He observes, " M. Nysten a montré que dans les paralysies les plus complètes, l'irritabilité se conserve dans les membres paralysés tout aussi bien que dans ceux qui ne le sont pas. J'ai obtenu un résultat semblable d'une expérience que j'ai souvent répétée. Elle consiste à détruire la moëlle lombaire dans un lapin âgé de moins de dix jours ; il faut le choisir de cet âge, pour que la circulation ne soit pas arrêtée, et qu'il puisse continuer de vivre. Quoique dans cette expérience, le train de derrière soit frappé de mort, et que ses nerfs ne puissent plus recevoir aucune influence de la moëlle épinière, l'irritabilité s'y conserve, et l'on peut, pendant fort long-temps, faire contracter les cuisses, en irritant les nerfs sciatiques. Il paraît donc qu'il se fait dans toute l'étendue des nerfs une sécrétion d'un principe particulier." †

From these quotations from Nysten and Legallois we should be led to the conclusion that the muscles of paralytic limbs, in all cases of hemiplegia and of paraplegia, simply retain their irritability. From another series of observations, made by philosophers equally worthy of our confidence, we should be led to an opposite conclusion.

Some interesting experiments on this point have been recently performed by Professor Müller and Dr. Sticker. The former celebrated physiologist observes, † " It was known that, after the division of a nerve, the portion cut off from communication with the brain retains, for a certain time, its excitability ; but the question, how far the continuance of the connection with the brain and spinal marrow is necessary for the longer preservation of the irritability of the nerves, and whether the muscles retain their irritability when their nerves no longer communicate with the central parts of the nervous system, could not hitherto be answered with certainty, and had indeed been seldom mooted. Nysten had asserted that the muscles of patients who died a short time after an apoplectic seizure preserved their irritability, and contracted under the influence of the galvanic stimulus, although the functions of the brain had been paralyzed.

" I had good reasons, however, for believing

that, in such cases, the nerves retain their power only for a short time, losing it entirely after a longer interval ; for, in experiments on the reproduction of the nervous tissue in a rabbit, I had once observed, that the lower portion of the nervus ischiadicus, which I had divided some months previously, had lost all its excitability ; and a similar fact had been before observed by Fowler. I have since performed, in conjunction with Dr. Sticker, new experiments, which have completely confirmed that supposition. To prevent the regeneration of the nerves, and to withdraw more effectually the lower portion from the influence of the brain and spinal cord, a portion of the nerve (the ischiadic) was entirely removed. The experiments were made only on two rabbits and a dog ; yet the results were so constant, that they are quite worthy of dependence.

" Eleven weeks after the division of the nerve in the first rabbit, it was laid bare in its course between the biceps and semitendinosus muscles. Contrary to expectation, and to our mortification, the continuity of the nerve was found to be restored. It was divided anew below the cicatrix ; and it is remarkable that, although the animal uttered a loud cry, the section excited no contraction of the muscles. The lower portion of the nerve was now exposed to the galvanic stimulus of a single pair of plates, was cut and pulled in every possible way, but not the slightest muscular contraction was excited.

" For the sake of comparison, the nerve of the opposite side was divided, when the animal showed signs of suffering the most severe pain, and violent muscular spasms took place ; and, after the division, very slight irritation of the nerve itself, that is to say, of the lower portion of it, or merely of the muscles, excited strong twitchings, even after death.

" Ten weeks after the division of the nerve in the dog, the ends were found to be reunited. The experiment was performed exactly as in the rabbit, and the result, as to the effect on the nerve, was entirely similar : it had lost all its excitability ; but the muscles still contracted slightly when stimuli were applied directly to them immediately after death : however, this remaining irritability was gone, while, in the muscles of the opposite leg, the strongest contractions could be excited.

" Five weeks after the nerve had been divided in the second rabbit, we proceeded to examine its state, and were the more interested on account of the short time that had elapsed since its division. The ends were not united ; they were somewhat swollen, and connected with the surrounding cellular tissue. In the other instances, the portion of nerve removed measured about four lines only ; here its length was eight lines. No contraction of the muscles could be excited by irritating the nerve either mechanically or by a chemical stimulus, caustic potash, or by galvanism ; nor by irritating the muscle itself, although the rabbit had plenty of vital power. On the left side the muscles were found irritable, as in the other cases, both before and after death.

* Recherches Physiologiques, 1811, p. 369 ; compare p. 377 and 419 ; and Cuvier, Histoire des Sciences Naturelles, tome i. p. 213.

† Œuvres de Legallois, éd. 1824, p. 23 and 24.

‡ See the excellent translation of the " Handbuch der Physiologie," by William Baly, M.D., vol. i., p. 631-633 ; and compare p. 663, 724, 727, 898, &c. and Grainger on the Spinal Cord, p. 96, 97.

"The foregoing experiments prove, at least, that when the communication of the nerves with the brain is wholly cut off, they gradually lose the power of exciting the muscles to contraction, while the muscles lose their irritability. The result would, however, have been still more decisive if, in place of a single pair of plates, a small galvanic battery had been employed to stimulate the nerves and muscles. That, and that alone, would have enabled us to determine with certainty whether all the power of the muscles, in two of the cases, had been lost. The experiments as they were made, however, prove distinctly enough the necessity of communication with the brain for the preservation of nervous and muscular power. We may from them conclude also that if, after the division of a nerve, the excitability of the lower portion, and the irritability of the muscles are restored, the nerve has itself been completely reproduced; and that this has not been the case if the nerve and muscle do not retain their vital properties."

I may here observe, that an experiment, similar to those of Professor Müller and Dr. Sticker, in which Sir Astley Cooper assisted the late Dr. Haighton, was made in this country many years ago, but never published. The sciatic nerve was divided in a dog. In a few days the lower portion had lost its power of exciting muscular contraction.

These statements appear, then, sufficiently opposed to each other; how shall we explain or reconcile them? Before I proceed to discuss this question, I must beg the attention of the reader to a third series of observations and experiments, in a certain sense at variance with both those which have been detailed.

My own attention was first drawn to this interesting point by the fact, well known to physicians, that if we administer strychnine to patients affected with paralysis, it is frequently the paralytic limbs which first manifest the peculiar influence of this powerful remedy. M. Fouquier has, I believe, too hastily generalized this effect of strychnine on the muscles of paralytic limbs. And how well do I remember the same remark being made by M. Louis, as, in our visit round his wards at La Pitié, we came to a case in point. From that moment I did not cease to revolve the question in my mind, and to devise modes of observation and experiment to solve it. Certainly the conclusion of M. Ségalas d'Etchepare, in regard to it, is any thing but satisfactory. M. Ségalas observes:—

"Ces expériences réunies autorisent donc à conclure que le tétanos produit par la noix vomique a pour condition première de son développement la présence du poison dans le sang, et que les phénomènes qui l'accompagnent sont dus à l'action anormale de ce fluide sur le système nerveux.

"Cette manière de considérer l'action de la noix vomique donne un moyen simple d'expliquer les effets de cette substance chez l'homme, et particulièrement ce fait si remarquable de la contraction des muscles paralysés plus prompte et plus énergique que celle des muscles sains,

fait observé d'abord par M. Fouquier,* et constaté depuis par tant de praticiens du premier ordre. Il est facile, en effet, de concevoir que les muscles sains, soumis à la fois à l'empire du cerveau et à l'action du poison, résistent à celle-ci plus que les muscles paralysés, qui, soustraits à l'influence cérébrale, ne sont plus commandés que par le poison."

Upon these observations of M. Ségalas, M. Ollivier remarks—"Mais s'il en est ainsi, comment se rendre raison d'un fait observé depuis long-temps par tous les praticiens, et sur lequel je viens d'appeler l'attention, c'est que la noix vomique cause souvent de violentes douleurs dans les membres paralysés, sans apporter aucun trouble dans les parties saines? Pourquoi cette action spéciale sur les seuls organes paralysés? et, d'un autre côté, la douleur perçue ne prouve-t-elle pas que les parties paralysées ne sont point isolées entièrement du centre nerveux, et qu'ainsi ce ne peut être à cette inconstance qu'on doit attribuer la localisation singulière des effets de la strychnine?" †

It will soon be seen that this view, like a former one, is far too general, far too indiscriminate—that it is not in every case of paralysis, that the strychnine would first display its influence on the paralytic limbs. Meantime, however, I figured to myself the fact of the strychnine acting on the spinal marrow, and diffusing its power equally along the nerves, to the right hand and to the left, to the muscles to which they proceed respectively: and I asked myself the question—Is the difference observed in its ultimate effects on those muscles, the power being obviously the same, owing to a difference in the degree of the irritability of the muscular fibre itself? Is the irritability of that fibre actually augmented? If so, the phenomenon would be explained!

I waited with anxiety for opportunities of submitting this question to the decision of experiment. This I entrusted, in the first instance, to my young friend and intelligent pupil, Mr. Dolman. The result was as I anticipated. A little child, aged two years, was perfectly paralytic of the left arm. The slightest shock of galvanism was directed to be applied which should produce an obvious effect. It was uniformly observed that the paralytic limb was agitated by a degree of galvanic energy which produced no effect on the healthy limb.

A similar patient, with paralysis of one leg, was subjected to the same experiment by my friend and former pupil Mr. W. F. Barlow, and with the same result.

I repeated the trial on several patients affected with hemiplegia, at my own house, uniformly with the same event: the paralytic limbs were always moved by an influence which was lower than that required to affect the healthy limb, or if both limbs were agitated, it was uniformly the paralytic limb which was more shaken than the other.

* Mémoire sur l'emploi de la noix vomique dans les paralysies, par M. Fouquier, 1815.

† Traité de la Moëlle Epinière, 1827, p. 841.

I next repeated my observations upon a more extensive scale, at the St. Mary-le-bone and St. Pancras Infirmarys. There were two exceptions to the rule; whilst the numbers in which the phenomena as already described were observed were considerable.

These exceptional cases I shall notice particularly hereafter. I must now remark that these observations seem, even more than those of Prochaska, Nysten, and Legallois, at variance with the experiments of Professor Müller and Dr. Sticker. Before I proceed to discuss this question, I must, however, detail some experiments of my own.

They were made on six frogs. I divided the spinal marrow immediately below the origin of the brachial plexus; and I removed a portion of the ischiatic nerve of the right posterior extremity. I had immediately, or more remotely, the following interesting phenomena.

1st. The anterior extremities alone were moved spontaneously; both posterior extremities remaining entirely motionless, when the animal, placed on its back, made ineffectual efforts to turn on the abdomen.

2d. Although perfectly paralytic in regard to spontaneous motion, the left posterior extremity, that still in connexion with the spinal marrow, moved very energetically when stimulated by pinching the toes with the forceps.

3d. The right posterior extremity, or that of which the ischiatic nerve was divided, was entirely paralytic, both in reference to spontaneous and excited motions.

4th. After the lapse of several weeks, whilst the muscular irritability of the left posterior extremity was gradually augmented, that of the right was gradually diminished, phenomena observed when the animal was placed in water, through which a slight galvanic shock was passed accurately in the direction of the mesial plane.

In this interesting experiment we have, then, first the phenomena of loss of spontaneous motion on removing the influence of the brain, the excited or reflex actions remaining; and the loss of these on removing the influence of the spinal marrow; secondly, in the case of mere cerebral paralysis, we have augmented irritability, and in that of the spinal marrow we have the gradual diminution of this property.

5th. Strychnine being now administered, the anterior extremities and the left posterior extremity, or that still in connexion with the spinal marrow, became affected with tetanus; but the right posterior extremity, or that severed from all nervous connexion with the spinal marrow, remained perfectly flaccid.

6th. Lastly, the difference in the degree of irritability in the muscular fibre of the two limbs was observed when these were entirely separated from the rest of the animal.

In a word, the muscles of the limb paralysed by its separation from both cerebrum and spinal marrow, had lost their irritability; whilst those of the limb separated from its connexion with the cerebrum only, but left in its connexion with the spinal marrow, not only retained their irritability, but probably possessed

it in an augmented degree. The next question came to be,—Do these phenomena obtain in the human frame? I visited a patient affected with hemiplegia, including paralysis of the face, and I passed a slight galvanic shock through two pieces of metal, of which one was placed over each cheek. The muscles of the paralytic side were most affected. I repeated the experiment with the same result. I now compared with these, two cases of injury of the facial nerve, passing the galvanic shock in the same manner, through the fibres of the orbicularis: it was now the muscle of the healthy side which was affected by the galvanism, the eyelid of that side being closed, whilst that of the paralytic side gaped as before. I next compared the effect of galvanism in two cases of complete paralysis of the arm, one hemiplegic, the other the result of dislocation of the shoulder. The muscles of the former were more, those of the latter less, irritable than those of the healthy arm respectively, as were also those of the arm of a patient affected with the paralysis induced by lead. Lastly, I compared the cases of paralysis of the lower extremities, one arising after pertussis, and therefore cerebral, the other, I think, from disease within the lumbar vertebræ: in the former there was augmented, in the latter, diminished irritability.

By means of these experiments and observations we are enabled, I believe, to explain all the apparent discrepancies between the statements of former authors, and between each of them and my own.

The observations of Nysten and others determined that the irritability of the muscular fibre still existed in ordinary hemiplegia; but they did not extend far enough to determine the comparative degree of irritability of the paralytic and of the healthy limbs, or the question whether, in the former, the irritability was diminished—the event probably expected—or augmented, a result, I believe, never anticipated.

Prochaska and Nysten and Legallois failed in their experiments, too, by not allowing time for the change in the condition of the irritability of the muscular fibre to take place.

Professor Müller and Dr. Sticker, on the other hand, did not distinguish between paralysis arising from separation from the cerebrum merely, and paralysis arising from separation from the spinal marrow, a distinction of the utmost importance in every point of view, and that which explains the phenomenon under discussion. The term paralysis has been used by all the authors whom I have quoted in too general a sense. This is so true that I may affirm that in one kind of paralysis, that which removes the influence of the cerebrum, and which is therefore paralysis of spontaneous or voluntary motion, there is augmented irritability; whereas in the other, that which severs the influence of the spinal marrow, the irritability is diminished or even annihilated.

We may conclude that in cerebral paralysis the irritability of the muscular fibre becomes augmented from want of the application of the stimulus of volition; in paralysis arising from disease of the spinal marrow and its nerves this

irritability is diminished, and at length becomes extinct, from its source being cut off.

We may further deduce, from the facts which have been detailed, that the spinal marrow and not the cerebrum is the special source of the power in the nerves of exciting muscular contraction, and of the irritability of the muscular fibre; that the cerebrum is, on the contrary, the exhauster, through its acts of volition, of the muscular irritability.

As a further deduction from the same facts, we may infer the diagnosis between cerebral and spinal paralysis: mere cerebral paralysis is attended by augmented irritability, whereas spinal paralysis is that which is attended by diminished irritability. This fact will prove useful in many obscure cases.

Having thus cleared up the physiological question, I proceed to the application of the principle to pathology; and I may here observe that there is a whole series of phenomena which admit of explanation by its aid.

And, first, the exception to the rule of augmented muscular irritability in paralytic limbs, is obviously dependent upon its existing in the cases of paralysis from the severed influence of the spinal marrow, as distinguished from those arising from the severed influence of the cerebrum merely.

Secondly, we understand at once why the influence of strychnine is first and most seen in cerebral paralysis in the paralytic limbs.

But there are still some other points which I must bring before the notice of the reader.

The first of these is the influence of emotion in paralytic limbs.

The second is the similar influence of certain acts of respiration; as yawning, sneezing, coughing, &c.

The third, the similar influence of the tonic power.

It must have occurred to us all to observe the influence of surprise or agitation on the arm and hand, and perhaps on the leg, of a patient long affected by hemiplegia, whilst the limbs of the healthy side remained unaffected. In this case the influence of the emotion is, like that of strychnine in the case formerly discussed, exerted equally upon the limbs of both sides; but it is the muscles of the paralytic limbs which are most irritable, most susceptible of the stimulus; it is, therefore, these limbs which are most convulsively affected.

The same phenomenon is not observed in paraplegia, because the influence of the emotion is cut off from the affected limbs.

Case 1.—I was called to a patient a short time ago, affected at that moment with bronchitis. He was forty-three years of age, and at the age of twenty-four had been seized with hemiplegia. Recovering from the immediate danger of the attack, he remained hemiplegic, scarcely regaining the use of the hand and arm at all, and only partially that of the leg.

Whenever this patient is excited by meeting an acquaintance, or in any similar way, he has a little strabismus, and the hand and arm are contracted and convulsed in the most extraordinary manner: whenever he coughs, the leg

is thrown involuntarily upwards. The arm is severed, as it were, from volition, but affected by emotion.

Similar facts have been observed in regard to the influence of certain respiratory acts, but especially those of yawning, sneezing, &c.

Dr. Abercrombie details the following interesting case in a note to the late Mr. Shaw.

“ I think the following case will be interesting to you and Mr. Bell. I had some time ago under my care, a man affected with hemiplegia of the left side; the palsy complete, without the least attempt at motion, except under the following circumstances: he was very much affected with yawning, and every time he yawned the paralytic arm was raised up, with a firm steady motion, until it was at right angles with his body (as he lay in bed on his back), the fore-arm a little bent inwards, so that his hand was above his forehead at its greatest elevation. The arm was raised steadily during the inspiration, and when the expiration began seemed to drop down by its own weight, with considerable force. He continued liable to the affection for a considerable time, and it ceased gradually as he began to recover the natural motion of the limb.”—That is, as I conclude, as the state of augmented irritability was removed by the returning acts of volition.

Not less interesting are the effects of the tonic power. In cases of hemiplegia of long duration, the paralytic limbs, but especially the arms and hands, are drawn into a state of chronic, rigid, contraction. This phenomenon is owing to the principle of tone constantly acting upon muscles now possessing augmented irritability, whilst they are never, or rarely, relaxed by acts of volition.

A similar effect is seen in idiots born with atrophied cerebrum: the influence of volition is wanting; that of the spinal marrow, the source, at once, of the tone and of the irritability of the muscular system, is in constant action, and induces chronic contraction, an effect which must, however, be distinguished from that of spasm, which is excited immediately by some disease of the spinal marrow itself.

I may now resume the subject of the action of strychnine on paralytic limbs. It is obvious that the generalization of M. Fouquier, M. Ségalas, and others, that the strychnine attacks the paralytic rather than the healthy limbs, was too hasty. This is only true in those cases of paralysis in which the muscles still remain in nervous connexion with the spinal marrow; the opposite result is observed in those other cases in which such connection between the muscles and the spinal marrow is intercepted.

I would here make another observation. The arms and hands, generally speaking, are more under the influence of the cerebrum than the lower extremities; and these, on the other hand, are more under the influence of the spinal marrow than the arms and hands. The superior extremities are more and more frequently affected by hemiplegia than the inferior; these are more influenced by tetanus, by strychnine, &c. than the former, a fact which

I have observed, in regard to strychnine, in some cases of hemiplegia. These facts must be borne in mind in making our observations.

Another circumstance must also be noticed. The more perfect the paralysis, generally speaking, the more the irritability of the muscular fibre is augmented. In hemiplegia, the arm is generally at once more paralytic and more irritable than the leg. In chronic cases, however, the irritability becomes impaired, together with the nutrition.

I will now adduce a few cases which, however succinctly detailed, will exemplify and substantiate the preceding observations.

Case 2.—On January the 16th, 1839, I visited a patient who had been seized with hemiplegia nine months before: the arm was perfectly paralytic, the leg less so, the face less so still. On passing the galvanic influence through the arms, the left or paralytic arm was much more affected than the right, and distinctly affected by a force which induced no effect whatever on the right, the tendons starting on each completion of the galvanic circle; the contraction of the muscles of the left side of the face was seen in its effect on the features; and that of the left gastrocnemius, in its effect on the tendo Achillis, when no effect was perceptible on the right side of the face, or in the right leg.

In this patient other and very interesting phenomena were observed:

1st. The arm has, from the beginning, been much more paralytic than the leg or the face:

2d. The influence of strychnine was observed in the paralytic arm and leg only, in the latter more than in the former:

3d. Any sudden noise, or other causes of emotion, affect the paralytic side only—the leg, however, more than the arm:

4th. Yawning and sneezing move the paralytic limbs; the former the arm, the latter the leg, principally:

5th. The act of stretching, and the act of raising the right arm above the head, induce unconscious movements of the left or paralytic arm:

6th. During sleep, the left or paralytic arm and hand are greatly contracted and painfully pressed to the side:

7th. The paralytic arm shrinks from the application of cold, as the sudden contact of a cold hand; an example of the reflex action in hemiplegia:

8th. Lastly, the paralytic hand and arm are constantly in a state of contraction.

I repeated the trials with the galvanic shock, with the same results, on February the 14th.

Case 3.—On January the 15th and 22d, 1839, I passed a slight galvanic shock through the orbicularis of each side of the face, in a patient affected with paralysis of the left facial nerve from exposure to cold, of six weeks' duration. Here the right eyelid was forcibly closed, the left or paralytic eyelid being totally unaffected.

Case 4.—On February the 13th, I passed the galvanic shock through the two orbicularis in a patient whom I visited with Mr. Burford, and in whom the facial nerve was partially

paralyzed by the removal of a considerable branch of the nerve, together with a tumour which had formed in its course along the cheek.

The muscle of the paralytic side was unaffected, whilst that of the healthy side closed the eyelids on every application of the galvanic influence.

Case 5.—I have more recently performed the same experiment on a patient affected with paralysis of the facial nerve, from otitis and disease of the temporal bone, with precisely the same result.

Case 6.—On February the 9th, I compared the galvanic influence in two patients at the St. Pancras Infirmary: both were affected with complete muscular paralysis of the arm; the first case was cerebral, being hemiplegia; the second was an injury of the brachial plexus, having resulted from dislocation of the shoulder; the results were what I had anticipated; in the case of hemiplegia, the irritability of the muscles of the paralytic limbs was greater than that of the muscles of the healthy limb; in the case of injured brachial plexus, the opposite state of things was observed, the irritability of the muscles of the paralytic hand and fore-arm being greatly diminished.

Case 7.—On January the 23d, 1839, I passed the galvanic shock through the hands of a patient who had been gradually affected with paralysis of the right, from handling leaden types, as a compositor. Here, again, the paralytic muscles were unaffected by a degree of galvanism, which induced an evident effect on the muscles of the healthy limb.

Cases 8 and 9.—On January the 10th, 1839, I galvanized a little boy with paralysis of the left leg; the muscles were more irritable than those of the healthy leg; the affection had followed pertussis, and I concluded that it was cerebral. This conclusion was confirmed by a fact which I learnt afterwards, viz. that in the commencement there was imperfect closure of the eyelids during sleep. On the same day I tried the galvanic influence in a case of partial paraplegia in a little girl, a patient of Mr. Burford; in this case the muscles of the paralytic limbs were less irritable than those of the healthy limbs; I concluded that the disease was seated in the course of the nerves, and probably within the lumbar vertebræ.

Case 10.—It has been suggested to me that the loss of irritability in the cases of spinal paralysis might be owing to the defective nutrition of the muscles. I therefore tried the effect of galvanism in a case of chronic cerebral paralysis, or hemiplegia, with much emaciation of the paralytic muscles. I found these muscles, as before, much more irritable than those of the unaffected limb.

I must repeat, that I am perfectly aware of the sketchy manner in which these notes of cases are given; but I have thought it better to leave the further details for another form of communication.

In the meantime we may conclude, that by the test afforded by the galvanic trough, we are enabled to effect a diagnosis between the cases to which I now allude. Disease of the cere-

brum itself,—disease of the dorsal portion of the spinal marrow,—induces cerebral paralysis, hemiplegia, or paraplegia; disease compressing or destroying the facial nerve, or the cauda equina in the lumbar region, induces both cerebral and spinal paralysis. In the former case we shall observe augmented, in the latter diminished irritability of the muscular fibre.

I may now resume the points of this article, and observe,

1st. That the spinal marrow, exclusive of the cerebrum, is the source of the muscular irritability:

2d. That the cerebrum is, in its acts of volition, an exhauster of that irritability:

3d. That in muscles separated from their nervous connexion with the brain we have augmented irritability:

4th. That in muscles separated from their nervous connexion with the spinal marrow we have, on the contrary, diminished irritability:

5th. That the degree of the irritability of the muscular fibre of paralytic limbs, compared with that of the muscles of the healthy limbs, will afford us a source of diagnosis between cerebral and spinal paralysis, and especially between

1. Hemiplegia of the face, and
2. Paralysis of the facial nerve;
3. Hemiplegia of the arm or leg, and
4. Disease of the nerves of these limbs;*
5. Disease of the spinal marrow in the dorsal region, and
6. Disease of the cauda equina in the lumbar region; &c.

6th. That the greater influence of emotion, of certain respiratory acts, of the principle of tone, &c. on the muscles of certain paralytic limbs than on those of healthy limbs, depends on their augmented irritability:

7th. That the same principle explains the greater susceptibility of the muscles in certain cases of paralytic limbs, to the influence of strychnine:

8th. That, in the conclusions of M. Fouquier, Professor Müller, &c., a sufficient distinction was not made between the influence of the cerebrum and of the spinal marrow, which in this, as in so many other respects, have such different properties:

9th. From these and other experiments and observations, I conclude, too, that sleep restores the irritability of the muscular system, by arresting the acts of volition which exhaust or diminish it; muscular efforts, on the other hand, diminish the irritability and induce fatigue.

Before I conclude, I must beg my reader's attention to some experiments of that able physiologist, Dr. J. Reid, of Edinburgh, which appear, at first sight, to be contradictory to those which I have just detailed.

Dr. J. Reid's paper is published in the

* In disease of the cervical vertebrae the arms are sometimes paralyzed without paralysis of the legs; this probably arises from compression of the brachial plexus. See Sir B. Brodie's paper in the *Medico-chirurgical Transactions*, vol. xx. p. 130; the galvanic trough would determine the question.

Fourth Report of the British Association for the Advancement of Science, p. 671. It is as follows:—

“Although physiologists are still divided in opinion as to the question whether nerves furnish a condition necessary to the irritation of muscles, (i. e. whether every stimulus which excites a muscle to contraction acts on it through the intervention of nervous filaments,) they have now very generally abandoned the once prevalent theory, that the irritability of muscles is derived from the brain or spinal cord, i. e. that muscles are continually receiving, through their nerves, from those larger masses of the nervous system, supplies of a certain influence or energy, which enables them to contract; and that some of the statements of Dr. Wilson Philip, in particular, are generally regarded as decisive against this theory.

“Dr. Wilson Philip found by experiment, that the irritability of a muscle of which the nerves were entire, was exhausted by applying a stimulus directly to the muscular fibres (sprinkling salt on them) even more quickly than that of a muscle of which the nerves had been cut, and where all communication with the supposed source of nervous influence or energy had been cut off; and he states generally that a muscle of voluntary motion, if exhausted by stimulation, will recover its irritability by rest, although all its nerves have been divided.

“But in opposition to this statement, and in support of the old theory of nervous influence continually flowing through certain of the nerves into the muscles, it has lately been stated by Mr. J. W. Earle, that when the nerves of the limb of a frog were cut, the skin stripped off, and the muscles irritated by sprinkling salt on their fibres, until they had lost their power of contraction, although they did not lose their power much more quickly than when the nerves were entire, yet *they did not regain their power*, although left undisturbed for five weeks; while the muscles of the limbs of another frog, similarly treated, but of which the nerves were left entire, completely recovered their irritability.

“It occurred as a fundamental objection to the experiment of Mr. Earle, that in the case where the nerves had been divided, the muscles had become inflamed; being found at the end of the five weeks ‘softer in their texture than natural, a good deal injected with blood, and with some interstitial deposition of fluid in them;’ while in the limb to which the salt had been applied, but of which the nerves were left entire, and where the irritability was recovered, ‘although the colour of the muscles was rather darker than natural, their texture remained unchanged, and there was no interstitial deposition of fluid in them.’

“In these circumstances it might evidently be supposed that it was the inflammation and disorganization of the muscles, not the section of the nerves, which prevented the recovery of the irritability in the case where the nerves had been cut; and it became important to have the experiment repeated, with care to avoid such

injury of the limb of the animal as should cause inflammation to succeed the section of the nerves.

"With this view, Dr. Reid performed a number of experiments on frogs, in which the irritability of the muscles of both hind legs was exhausted or greatly diminished by galvanism, after the nerves of one leg had been divided, and the lower part of the limb rendered perfectly insensible and incapable of voluntary motion, (but without stripping off the skin,) while the nerves of the other had been left entire. The state of the muscles of both limbs was examined after some days. The results of these experiments were not uniform; but in several, where every attention to accuracy seems to have been paid, the irritability of the muscles in the palsied limbs appeared to be *restored as perfectly as in others*; contractions being excited in them, in several instances, by the galvanism from four or even two plates, whereas they had formerly been irritated until they were no longer excitable by that from fourteen plates.

"That the muscles which thus recovered their irritability had lost all nervous connexion with the brain or spinal cord was proved, not only by their obvious insensibility, but by afterwards cutting off the heads of the animals and forcing a probe along the spinal canal, which excited forcible contractions in all parts, excepting the palsied limbs.

"Dr. Alison's paper contained the details of several of these experiments; and he stated, in conclusion, that as a *positive* result in such an inquiry must always outweigh a *negative* one, (particularly where a source of fallacy attending the latter can be pointed out,) these experiments appear fully to justify the assertion of Dr. Wilson Philip, that a muscle of voluntary motion may recover its irritability by rest, although all its nerves be divided; and that they afford, perhaps, more direct evidence than any others in support of the doctrine of Haller, now generally admitted in this country, that the property of irritability in muscles is independent of any influence or energy continually flowing from the nervous system, although, like every other endowment of living animals, it is subjected to the control of causes which act primarily on that part of the living frame.

"Dr. Allen Thomson expressed a doubt whether these experiments warranted the conclusion drawn from them, not because he acquiesced in the theory to which they are opposed, nor because he called in question the accuracy of the results described to have been obtained, but because he knew that former experiments had failed in producing such diminution or exhaustion of the irritability of muscles as had been found by Dr. Reid; and conceived it possible that some of the numerous fallacies to which such experiments are liable might not have been sufficiently guarded against.

"The accuracy of Dr. Reid's statement as to the great diminution or apparent exhaustion of the irritability of the muscles under the in-

fluence of galvanism, and the subsequent recovery of the power, notwithstanding the division of all their nerves, was satisfactorily established. It is to be remarked, however, that in these experiments, as usual in such cases, the limbs to which the galvanism was applied were kept moist by the same saline solution with which the galvanic trough was charged; and Dr. Thomson has observed, that when they are moistened with pure water, the diminution of the irritability under the excitement by galvanism is much less obvious. Hence he was led to suspect that the apparent loss of power in the muscles under that process might depend, not on the circumstance of repeated excitement, but on a degree, however slight, of injury to their texture by the action of the salt. This inquiry he proposes to prosecute further; but in the meantime it is certain that by the usual process of galvanizing a living muscle moistened by a saline solution, a very great diminution of its irritability may be effected, which may subsequently be regained, notwithstanding the division of all its nerves; and as the fact of its recovery, not the cause of its diminution or exhaustion, is the point on which the inference drawn from these experiments rests, that inference may be held to be sufficiently justified."

The first question is,—what is the nature of that effect produced upon the nervous and muscular system by such agents as those employed in these experiments temporarily to diminish or suspend their powers? The immediate effect of an attack of hemiplegia, the immediate effect of an injury done to the spinal column, by accident, or in an experiment, the immediate effect of galvanism, or other stimuli, applied to the nerves or muscles, is to suspend, for a time, the phenomena of the excito-motory power of the nerves, and of the irritability of the muscles, respectively; which, however, repose renews. What is the nature of these changes? Do they not consist in the sudden reduction and more gradual removal of some *physical* effect, different from the diminution and restoration of a purely *vital* property of these textures, widely different from the slowly induced loss of irritability resulting from the removal of its source, the natural *physical* condition remaining unchanged? At any rate we must agree with Legallois. "Il faut se souvenir que deux faits bien constatés ne peuvent jamais s'exclure l'un l'autre, et que la contradiction qu'on croit y remarquer tient à ce qu'il y a entre eux quelque intermédiaire, quelque point de contact qui nous échappe."*

I must here adduce two experiments of my own, performed and published many years ago.†

"In an eel, in which the brain had been carefully removed, and the spinal marrow destroyed, the stomach was violently crushed with a hammer. The heart, which previously beat vigorously sixty times in a minute, stopped suddenly and remained motionless for many seconds. It then contracted; after a long in-

* Œuvres, Paris, 1824, t. i. p. 21.

† See my Essay on the Circulation of the Blood, 1831, p. 160, 188.

terval it contracted again, and slowly and gradually recovered an action of considerable frequency and vigour."

"A frog was made perfectly insensible by the application of laudanum or alcohol. Its respiration ceased. It did not move on the application of any irritant. The circulation in the web was carefully observed. When it had long continued in the same enfeebled state without change, the thigh was crushed. The circulation in the minute and capillary vessels ceased at once, and never returned. The stomach was now crushed in the same manner. The heart ceased to beat for many seconds. Its beat then returned, but never regained its former force."

In these experiments we have the sudden influence of shock and its gradual subsidence. The experiment is peculiarly interesting in many points of view:—1. it is the only one on record of the effects of shock induced *solely* and *exclusively* through the medium of the ganglionic system; 2. it exemplifies the effect of shock or excessive stimulus on the *heart*, with its gradual though incomplete subsidence.

The connexion of the ganglionic system with the irritability of the visceral muscles,—the heart, the stomach, the intestines, &c. forms the subject of an experimental investigation, in which I am at this moment engaged, and the results of which I purpose to give under the head of *vis nervosa* and *vis insita*. It is probable that the ganglia are to the internal muscular organs what the spinal marrow is to the muscles of the limbs, viz. the power of irritability, &c. This inquiry is founded on a fact first ascertained by myself, that, in spring, we may, by portions at a time with considerable intervals, totally destroy the brain and spinal marrow in the frog, eel, &c. leaving the circulation in the web or the fins and tail.* We have thus isolated the ganglionic from the rest of the nervous system, on which we may therefore proceed to experiment, watching the effect of various agents on the circulation and on the action of the heart, the stomach, the intestines.

We have thus passed in review in its anatomical, physiological, zoological, pathological, and those peculiar relations, the question of the irritability of the muscular fibre. It only remains for us to advert, once more, to the extreme importance of this principle in physiology: all physiology is involved, indeed, in the topic of the nervous system and the vascular system, and the principle of irritability seems, with its various and appropriate stimuli, to be placed between those two.

(Marshall Hall.)

JOINT.—See ARTICULATION, and the articles under the headings of the several joints for both the normal and abnormal anatomy.

KIDNEY.—See REN.

KNEE-JOINT (normal anatomy of the).
Gr. γῆρυ; Lat. genu; Fr. genou; Germ.

Kniegelenk; Ital. *ginocchio*. The knee-joint, the largest joint in the body, results from the articulation of the os femoris with the tibia below and the patella anteriorly. It admits of extensive motion as a ginglymus, to which is added an arthrodial motion, or a small degree of rotation of the leg and foot, when the joint is partly flexed. The articular surfaces are large and complicated, the ligaments numerous, and the joint chiefly superficial; circumstances necessary to the freedom, stability, and symmetry of the limb, but exposing this important articulation to frequent accident and disease. It is intended here to describe so much of, *a*, the bones entering into the formation of this joint, and, *b*, the cartilages, ligaments, &c., as may be necessary to the elucidation of, *c*, the mechanical functions.

(*a.*) *Bones*. The shaft of the os femoris, which in the middle of the thigh is triangular, becomes of a four-sided form as it approaches the knee, in consequence of the bifurcation of the *linea aspera*. This rough ridge, which in the middle of the bone forms a prominent posterior angle, divides on entering its inferior third into two diverging lines which terminate at the convex articulating eminences called *condyles*; a flat triangular surface of bone is thus left, where the popliteal vessels lie. The outer line is most strongly marked, and gives origin to the vastus externus and short head of the biceps flexor cruris: the inner line is deficient near the upper part, over which the femoral vessels pass into the ham; it gives attachment below to the vastus internus and adductor magnus. The internal condyle is narrower and more projecting behind than the external; and in relation to the shaft of the bone, it appears to extend further downwards; but the natural oblique position of the os femoris brings the condyles nearly horizontal. The greater width of the pelvis in women gives, cæteris paribus, a greater obliquity to the os femoris than in men. The condyles are separated behind by a deep fossa, out of which the crucial ligaments take their origin; their articulating surfaces are convex both in the transverse and in the antero-posterior directions, until in front they coalesce into one pulley-like surface over which the patella plays in the motions of the joint: this *trochlea* is convex from above downwards, but concave from side to side; its outer half is more prominent than the inner, and extends higher up the corresponding condyle. Above the trochlea there is a flattened or slightly depressed surface, upon which the patella partly rests during complete extension of the joint. The thickness of the os femoris from front to back undergoes little change till the condyles suddenly jut out behind, and the edges of the trochlea rise up in front; but from side to side the shaft of the bone increases in breadth as it approaches the knee, the two postero-lateral surfaces winding gradually round to become antero-lateral, at the same time diverging rapidly to form a smooth slope on the side of each condyle. Towards the posterior part of each of these sloping surfaces, there is an irregular prominence called the *tuberosity*, for the attach-

* Op. cit. p. 136.

ment of the lateral ligaments; below which, on the outer condyle, there is a pit for the origin of the popliteus tendon, and a fossa leading upwards and backwards from it which lodges the tendon when the joint is fully flexed. In the lateral aspect of the bone we best see the peculiar curvature of the articulating surface. In two adult, but rather small, specimens before me the inferior part of the outer condyle is a segment of a circle of fourteen lines radius, while the radius of the posterior portion is only seven lines; similar measurements of the curves of the internal condyle give radii of six and twelve lines respectively: the centre of the smaller circle coincides precisely with the point of attachment of the lateral ligament on each side, and the advantages of this arrangement will appear when we come to consider the functions of the joint. The smooth articulating surface of the trochlea and condyles is, in the recent state, covered with cartilage. Above this surface and in the fossa between the condyles are numerous foramina for the transmission of the nutrient vessels of the bone, the internal structure of which is here made up of minute cancelli. The lower extremity of the os femoris is cartilaginous at birth, becomes ossified from a separate centre, and long continues to form an epiphysis; but it is ultimately joined to the shaft by perfect bony union.

The thigh-bone exposes the largest extent of surface in the knee-joint; that of the *tibia* is the next in size. Its superior extremity is expanded into the same kind of cancellated structure as the os femoris possesses at its lower part; and the width from side to side equals that of the condyles, which rest upon its upper surface. That surface is nearly horizontal, in the erect position of the body; it is irregularly oval, the long axis passing from side to side, and is marked in the centre by a rough prominence or *spine*, in front of which is a depression, and at the back part a notch. On each side of these inequalities there is a smooth articular surface; the inner one the larger, especially from before backwards, and slightly concave; while the outer one is flat round the margin and raised at the inner side by the base of the spine. Viewing the bone in its anterior aspect we observe that below the articular surface it slopes downwards and forwards to the *tubercle* which stands out at the upper part of the shin or *crest* of the tibia; this tubercle gives insertion at its lower part to the strong ligament of the patella, a bursa being interposed between that ligament and its upper smooth portion. Numerous foramina are to be observed round the head of the bone for the purposes of its nutrition. Below the tubercle a section of the tibia shows it much reduced in size and somewhat triangular in shape; the outer side forming, in conjunction with the fibula, a large fossa for the tibialis anticus and other muscles; and the inner, facing also anteriorly, being a portion of that surface of bone which is covered only by skin and periosteum; except at its upper part, where three flat tendons pass upon it to be inserted by the side of the tubercle in the following order; that of the semitendinosus lowest,

the gracilis next above, and the sartorius the highest up and most anteriorly. The posterior surface of the tibia at the supposed place of section has advanced considerably forwards, so as to leave a hollow for the popliteus muscle which lies obliquely on this part of the bone. A few lines below the great articulating surface on the head of the tibia there are two things to be noticed on its posterior aspect; at the outer side a small articular surface for the head of the fibula, and at the inner side a shallow pit where the tendon of the semimembranosus is inserted.

The *patella* is a flat disk of bone placed in front of the knee-joint; it equals in width the trochlea of the os femoris to which it is applied, the posterior surface being for that purpose covered with cartilage and divided into two slight cavities by a prominent vertical line; the articular surface is oval from side to side and does not reach to the lower edge of the bone. Anteriorly, the patella is convex, and its horizontal slightly exceeds its vertical measurement, particularly in the female; into its upper edge are inserted the united tendons of the rectus, cruralis, and vasti muscles; into its lower edge the strong ligamentum patellæ which joins it to the tubercle of the tibia; it is covered only by skin, fascia, and some tendinous fibres, to which latter may be attributed the appearance of vertical striæ observable on the bone.

(b.) *Cartilages, ligaments, &c.*—The whole of the bony surfaces which come into contact with each other or with the interarticular cartilages during the movements of the knee-joint are covered with “cartilages of incrustation” (see ARTICULATION); and the extent of these on the condyles and trochlea of the os femoris, on the head of the tibia and the posterior surface of the patella, is well marked even in the dry bones by their smooth and compact appearance and the total absence of foramina on the parts so covered. Besides these pure cartilages there are two fibro-cartilages of a semilunar form lying upon the head of the tibia, which serve to deepen the articulating surfaces for the reception of the condyles. These *semilunar cartilages*, (*cartilaginee falcate*, s. *lunatae*) as they are named, are thickest at their convex edges which are attached rather loosely to the circumference of the head of the tibia; the concave edges are thin and sharp, and lie unattached between the condyles and the tibia. The two semilunar cartilages differ slightly from each other in the two following points; the inner one is falciform, decreasing in breadth from behind forwards; the greatest width being at the inner and back part, five-eighths of an inch, whilst in front it is hardly more than one quarter of an inch; the anterior and posterior cornua are separated to the distance of an inch, whilst those of the outer semilunar cartilage approach to within three-eighths of an inch of each other; and, besides that the ring is thus more nearly completed, the breadth of the outer one is more uniform, being about three-eighths of an inch throughout the greater part. The thickness of either of them barely exceeds one-

sixth of an inch, at the outer margin or thickest part. They are both composed of concentric fibres, the extremities of which are fixed to the central parts of the head of the tibia, before and behind the crucial ligaments, with whose fibres they intermingle; the anterior extremities are usually joined together by a *transverse ligament*, but this is sometimes wanting.

The *ligamentum patellæ*, of vast importance in the actions of the knee-joint, is yet the most distant from its articular surfaces; it extends, broad and flat, from the lower somewhat pointed portion of the patella to the inferior part of the tubercle of the tibia, being in the adult about two inches in length. It forms a strong inelastic but inflexible bond of union of the patella with the tibia, and may with propriety be looked upon as a continuation of the extensor tendons which are inserted into the upper and lateral margins of the former bone; some fibres indeed pass over its anterior surface, but it is only through this bone and its ligament that the extensor muscles can act upon the leg. The patella is thus seen to be placed in a situation analogous to that of the sesamoid bones, in the tendons which play over bony surfaces, in the hands and feet. The ligament of the patella is covered anteriorly by dense integument, and the fascia of the leg; posteriorly a cushion of fat is interposed between it and the joint at the upper part, while below it is separated from the bone by a bursa, whose situation was pointed out in the description of the tibia. (See *fig. 111, b*, vol. i. p. 252.) More closely applied to the joint are the *lateral ligaments*, the *posterior* and the *crucial ligaments*; and *portio 3* of the synovial capsule which are described by some anatomists as *alar* and *mucous* ligaments. The lateral ligaments have a vertical direction at each side of the knee, and are placed nearer to the posterior than the anterior boundary of the joint; the upper attachment is in fact to the tuberosity at the centre of the smaller curve which the articular surfaces of the condyles form at their back part. The internal lateral ligament descends from the tuberosity of the internal condyle of the os femoris to beneath the head of the tibia; it is nearly three inches in length, of a flattened form, narrow at its commencement, but enlarging considerably opposite the joint, to the synovial membrane of which as well as to the internal semilunar cartilage it adheres; inferiorly it again contracts in width. Its upper attachment is covered by the fascia lata; below, it is inserted into the shaft of the tibia just beneath the head of the bone, and anterior to its inner angle; and the tendons of the sartorius, gracilis, and semitendinosus cross over it.

The external lateral ligament (*lig. laterale externum*) arises from the tuberosity on the external condyle of the femur, and descends, inclining backwards, partly covered by the tendon of the biceps, to be inserted with it into the head of the fibula; the attachment of its upper extremity is immediately above the origin of the popliteus tendon, which it crosses in its descent, so that this tendon enveloped by its synovial sheath is situated between the liga-

ment and the joint. The deviation of this ligament from the perpendicular direction is perceived most distinctly in the state of extension; when the joint is flexed, the upper attachment of the ligament is brought more into the perpendicular over its fibular attachment, the ligament is relaxed and assumes the perpendicular direction; hence, in the flexed condition of the joint, the external condyle of the femur, or the tibia on it, admits of a more free motion. This ligament is contrasted by its less length and more rounded form with the internal lateral, and is composed like it of shining tendinous fibres; a still shorter set of fibres sometimes passes more posteriorly from the condyle to the head of the fibula, or from the sheath of the popliteus tendon, and has been called the *short external lateral ligament*.

The *posterior ligament* (*lig. posticum Winslowii*) is a portion of the tendon of the semi-membranosus muscle which is given off near its insertion at the posterior and inner margin of the head of the tibia; the portion under consideration forms a flat and dense fascia which passes upwards and outwards to the external condyle, where it becomes adherent to the synovial capsule and mingling with the tendinous origin of the outer head of the gastrocnemius; posterior to it lie the popliteal vessels, and in front of it there is a quantity of firm granulated fat, into which some of its fibres penetrate.

When the posterior ligament and the fat just spoken of are removed, and the joint is extended, the two *crucial ligaments* (*ligamenta cruciata**) are brought into view; they may be seen on the anterior aspect by dissecting down the patella from the fore part of the joint, and putting it in a state of flexion; in the former view, the posterior crucial ligament is best seen; in the latter, the anterior: the upper extremities of both are fixed in the fossa between the condyles of the os femoris; their lower extremities are attached to the head of the tibia between the two articular surfaces.

The *anterior crucial ligament* passes from the inner and back part of the *outer condyle* downwards and forwards to the depression in front of the spine of the tibia, where some portion becomes continuous with the anterior extremity of the internal semilunar cartilage. The *posterior* extends from the fore and outer part of the *internal condyle* downwards and backwards to the notch at the posterior margin of the head of the tibia, where it becomes likewise attached to the posterior extremity of the external semilunar cartilage. The crucial ligaments thus derive their name from decussating one another like the strokes of the letter X; the crossing is, however, considerably above their centre: the anterior passes to the outer side of the posterior.

The *synovial capsule*† entirely surrounds the

* [It is useful to bear in mind that these ligaments are called *anterior* and *posterior* with reference to their insertions into the tibia, the one in front of, the other behind, the spine of that bone.—*Ed.*]

† [Weber recommends as a good way of demonstrating the full extent and connexions of the

joint, and there are good reasons for affirming that it is continued in a highly attenuated state over all the interarticular and incrusting cartilages, giving them their smooth and secreting surfaces. (See ARTICULATION.) The remainder of its extent may be traced in the following manner: from the upper edge of the patella it ascends behind the common extensor tendon, and is loosely reflected upon the thigh-bone two or three inches above the trochlea in the extended position of the limb; from each side of the patella it passes backwards in a broad sheet, whose lower margin is attached to the edge of the semilunar cartilage, and thence goes to the tibia, while above it is loosely reflected on to the condyles of the os femoris, at the distance of nearly an inch from their cartilaginous surfaces; from the back part of the condyles these two lateral portions pass into the fossa and join to cover the anterior surface of the crucial ligaments. From the lower edge of the patella the synovial membrane descends to cover the fatty body which is placed in that part of the joint, and it accompanies a small prolongation from that body which frequently passes across the joint to the lowest portion of the trochlea of the os femoris, forming what has been named the mucous ligament; this structure however is not always present. There is some discrepancy in the descriptions of different anatomists as to the *alar* ligaments, which are described as folds at the sides of the patella, and it seems altogether unnecessary to distinguish these lateral portions by name from the other parts of the synovial capsule. They are simply folds of the synovial membrane projecting into the articular cavity, and obviously destined to increase the extent of synovial surface for a greater amount of secretion. This membrane has a dense cellular tissue on its outer surface, by which it is connected firmly to the posterior surface of the extensor tendons and fascia lata. It possesses some degree of elasticity, but its chief power of accommodation to the motions of the joint is derived from its lax connection with surrounding parts.

(c.) The *mechanical functions* of this joint, or the movements of which it is capable within certain limits, and the resistance which it opposes to motion beyond those limits, are plainly deducible from a knowledge of the parts of which it is composed. To say that the knee is a hinge-joint with a slight arthrodioid or sliding motion, gives a very faint idea of the complex problem which has been solved in its construction: to procure firmness without the aid of bony processes interlocking with one another (as in the ankle and elbow); and yet to combine free power of flexion with impossibility of over-extension; to oppose large surfaces of bone to one another, so as to ensure stability in the erect posture, without making the joint

unsightly by its size, are some of the indications most admirably fulfilled.

In the straight or extended position of the leg, the joint is firmly locked so as to admit of no lateral or rotatory motion; the pointing of the toes in and out in this position is effected by moving the hip-joint. The portions of the condyles forming the segments of large circles are, during complete extension, applied to the tibia and form a broad surface of support; the patella is drawn to the upper or deepest part of the trochlea; and the lateral and crucial ligaments, being attached nearer to the posterior than to the anterior surface of the thigh-bone, are together with the posterior ligament put upon the stretch. If the curve of the articular surfaces of the condyles had been uniform, with the lateral and crucial ligaments fixed to the centre of that curve, the posterior ligament only could have acted to restrain the leg from being flexed forwards upon the thigh, and it would be quite insufficient for that purpose: whereas, by the present arrangement, the centre of motion being placed nearer to the posterior surface of the condyles, the lateral and crucial ligaments cooperate with the posterior in opposing a strong check to over-extension. In flexion the joint admits of motion to the extent of about 140 degrees, when it is arrested by the crucial ligaments. During this movement the condyles offer a diminishing surface to the head of the tibia, and the semilunar cartilages have their ends brought closer together, so as to deepen the cavities for their reception: in extension, the reverse takes place, the semilunar cartilages are pressed out from betwixt the bones to their greatest extent. The adjustment of these fibro-cartilages during flexion is effected partly by their elastic power of resuming their shape when pressure is removed, and in some degree by the atmospheric pressure urging these moveable parts between the ends of the bones, to prevent the formation of a vacuity in the joint. During the motions of the knee, the patella undergoes important changes of relative position both with regard to the os femoris and the tibia; it plays over the whole extent of the trochlea, being drawn in extreme extension half its diameter above that pulley, whilst in extreme flexion it has moved through a quarter of a circle and is found at right angles with the os femoris, forming in that situation the surface which comes to the ground in kneeling, and so defends the joint from injury. In relation to the tibia, the patella always keeps the same distance from the tubercle, being joined thereto by the ligamentum patellæ; but as the condyles recede during flexion, the patella follows them; so that a line passing over its anterior surface and that of the tubercle will, if prolonged, reach the point of the great toe, though a similar line in the extended position will fall through the ankle-joint. The necessity for this advancing and receding movement of the patella explains why it is a separate bone instead of forming a process of the tibia, as in the elbow-joint the olecranon forms a part of the ulna; and may also suggest the use of the

synovial membrane of the knee-joint, to distend it by injecting some coagulating fluid, as size, through a hole bored through the centre of the patella.—*Mechanik der menschlichen Gehwerkzeuge*, p. 195. Ed.]

bursa behind its ligament. It has been said above that besides its ginglymoid motion, the knee-joint has a slight arthrodial motion in the bent position: this is strictly a rotation of the tibia on its axis, and the effect is to point the toes more or less to the outer side, rotation inwardly to any great extent being prevented by the crucial ligaments. During this movement of rotation, the inner articulating surface on the head of the tibia advances forwards, while at the same time the outer one recedes; the lateral ligaments allow of this motion, in consequence of their inferior attachments being a good deal below the margin of the joint; and the crucial ligaments permit the successive, though not the simultaneous, advance or recession of the cavities on the head of the tibia. In all positions of the joint the arrangement is such that the attempt to thrust *forwards* the whole head of the tibia is resisted by the *anterior* crucial ligament, whilst the *posterior* prevents it from being driven *backward*.* The

* [The following experiments, which may easily be tried, illustrate the respective offices of the several ligaments.

If the external fibrous investment of the joint be completely removed, taking care that the lateral and crucial ligaments shall be free from injury, the motions of the joint will be in no degree affected; but if the opposite experiment be tried, and the lateral and crucial ligaments be cut, leaving the external fibrous investment uninjured, excepting a small hole made for getting at the ligaments, it will be found that the integrity of the joint is completely destroyed, the bones are but loosely connected to each other, their apposition is destroyed, and they move about indifferently in every direction.

Again, if after dissecting off the external fibrous investment both crucial ligaments be cut, leaving the lateral ligaments as the only bonds of connection between the two bones, it is found that during extension, the fixedness of the joint is unimpaired, but if flexion be made gradually, the bones become less in apposition and more moveable, and in the completely bent state of the limb, they become quite loosely connected and may readily be moved from side to side, and the only limit to flexion is from the tibia coming against the femur.

If the lateral ligaments be cut, leaving the crucial uninjured, the bones remain firmly connected when the joint is in the state of complete flexion, and the crucial ligaments still, as in the natural state, oppose any further flexion. In the gradual diminution of the flexion, the junction of the bones becomes less complete, and when the extension has been carried to its full extent, the bones may be separated from each other, and admit of lateral motion; and if the joint be held up so as to allow the tibia to hang from it, the foot will become everted by its own weight, and the two crucial ligaments, instead of their crossed and oblique position, will assume a parallel and vertical direction. These experiments are described by Weber, but there are few anatomists in this country, for many years back, who have not frequently tried them.

The office of the semilunar cartilages is threefold: 1. filling up the empty space which the articular surfaces leave around their point of contact, they distribute the pressure over a greater surface; 2. they serve to distribute the tension of the ligaments in the movements of the joint more uniformly, and thereby to oppose any jarring of the bones against each other; and, thirdly, they deaden the vibrations which in the various movements of

mucous ligament and fatty body of the joint change their situation in some degree during its motions and may serve to fill spaces which which would otherwise be left vacant: the idea that they are peculiarly concerned in secreting the synovia has been satisfactorily refuted under "ARTICULATION."

The bursæ in the neighbourhood of the knee-joint are numerous and not unimportant, from the circumstance that some of them often open into the joint itself. In the layers of fascia anterior to the patella, one or more exist, imperfectly formed and very liable to inflame and suppurate. The situations in which the more perfect specimens are found are as follow, viz. behind the ligament of the patella; between the cruralis and fore-part of the os femoris; beneath the internal lateral ligament; at the insertion of the semitendinosus, gracilis, and sartorius; underneath each head of the gemellus; and around the tendons of the semi-membranosus and popliteus respectively; the last-named bursa is continued down some distance between the popliteus and the tibia, and it often communicates below with the superior tibio-fibular articulation, as well as with the knee-joint above. This joint is supplied with blood from the popliteal artery by five different branches, viz. two superior articular, which wind round the lower part of the os femoris; one middle articular which passes through the posterior ligament to the central parts of the joint; and two inferior articular, which take their course round the head of the tibia, and anastomose freely with each other, and with the two upper; the returning veins go to the popliteal.

The comparative anatomy of the knee-joint gives for the most part the same essential structure as we have described in man, though variously modified.

In most animals, when in a standing posture, the knee maintains habitually a state of flexion, and this arrangement conduces much to fleetness and agility of motion. In the elephant, however, the bones of the hind leg form an upright pillar of support, and the knee is extended as in the human subject. The elephant also resembles man in the circumstance of the knee being brought to the ground in kneeling; whereas, in most genera, the true knee is placed much nearer to the body of the animal.

(Alfred Higginson.)

KNEE-JOINT, ABNORMAL CONDITIONS OF.—The abnormal conditions of the knee-joint may be arranged under those which result from disease and accident. The deviations occasionally met with as the consequence of congenital malformation are fortunately rare.

DISEASE.—The abnormal appearances in the knee-joint resulting from disease are those which spring from some specific irritation, such as struma, gout, rheumatism, syphilis, or malignant disease, or from direct violence. Most of these irritations affect all the structures of the

the limbs, especially in standing, walking, or running, are propagated along the bones.—Vide Weber, *Mechanik*, &c. p. 193. ED.]

articulation, and are associated with some form of inflammatory action, either acute or chronic.

Simple acute inflammation of the knee-joint, or acute arthritis genu, may be the result of a contusion, a sprain, or a wound; or there may be no assignable cause. In the latter case it may have been preceded by rheumatic fever, erysipelas, or diffuse inflammation, which had previously engaged distant organs and other structures. The symptoms are usually strongly marked. Considerable pain, which comes on very suddenly, is felt in the knee; the leg in most cases soon becomes flexed and reposes on its outside; and the patient cannot bear the slightest movement to be communicated to the knee-joint. There is considerable increase of temperature in the skin over the affected articulation, together with tension of it from inordinate effusion of synovial fluid into the joint. Although the usual phenomena of redness as an accompaniment of phlogosis may not be observed externally, there can be but little doubt that the capillary vessels pervading the different structures of the interior of the joint are in a state of hyperæmia. The patient has but little sleep, and this is frequently interrupted by unpleasant dreams and painful spasmodic startings of the affected extremity. Œdema of the lower part of the limb now occurs, and in severe cases sometimes extends up the whole leg and thigh, even to the groin. The sympathetic fever may run so high, and the swelling and other local symptoms proceed so rapidly as to deprive the surgeon of any opportunity of proposing or performing amputation to save the patient's life.

The fever in well-marked cases of acute arthritis genu is sometimes symptomatic of the local disease; sometimes it has preceded the local affection, and has been ushered in by a very severe rigour followed by profuse perspiration. Like the disease, the fever will vary in its character. Erysipelas, rheumatic fever, and diffuse inflammation, as has been mentioned, will each occasionally present in their progress examples of the disease of the knee-joint now under consideration, and the accompanying fever will bear the character of the disease with which the inflammatory affection of the joint is associated. The local phenomena presented by an acute arthritis genu do not, however, vary so much, except in degree and severity.

Acute arthritis genu may supervene as a consequence of wounds. Sometimes these wounds are very small. We have known one case in which a puncture made with a fine sewing needle, which was accidentally driven with force into the knee-joint, at the inside of the patella, was the cause of a fatal inflammation of the joint: the point of the needle probably penetrated the bone. The patient, a young woman, was under the care of Mr. Colles many years ago, in Steevens's Hospital. In some instances we have known inflammation of the synovial membrane of the knee to have been the result of a wound of the subcrural bursa. A countryman had received a transverse wound by the cut of a broadsword just above the patella, and fatal inflammation

extended from this bursa, which was opened, to the synovial sac of the knee-joint.

Acute inflammation of the knee-joint has been the result of surgical operations, such, for instance, as that occasionally undertaken for the extraction of moveable bodies which form in the joint and interfere with the due performance of its functions. This operation, we believe, is now very seldom recommended. We have heard and read of many cases in which it has been performed with complete success; on the other hand, we have reason to know that many have died of the inflammation consequent on it, and that others have narrowly escaped with their lives, having ever afterwards an ankylosed knee-joint. It is rather singular, but we believe it to be true, that the inflammation resulting from a valvular opening having been made in the knee-joint has not come on for six or seven days after the moveable cartilage has been extracted; but inflammation being once set up, its course is generally acute and dangerous.

We consider the observations and experience of Mr. Guthrie on the subject of wounds of the knee-joint to be too valuable to be here passed over. "Wounds of the knee-joint," he remarks, "however simple, should always be considered of a dangerous nature, infinitely more so than of the shoulder, the elbow, or the ankle." "I could," he adds, "relate an infinite number of cases on these points, terminating fatally or in amputation, where the injury was severe, or apparently at first but slight, and but few cases where the capsular ligament was opened into by a musket-ball, where the patient has preserved the use of the limb. In every case where the wound was known to be serious, I have invariably been disappointed in the hope of saving the limb." He then adduces the following case as an instance of apparent simple injury that frequently occurs. "This case," he adds, "will shew the danger of all these wounds, and the very great care and attention that are necessary for their cure. Colonel Donellan, of the forty-eighth regiment, was wounded at the battle of Talavera in the knee-joint by a musket-ball, which gave him so little uneasiness, that when a roller had been put on his leg, with some simple dressing, he could scarcely be persuaded to proceed to the rear. At a little distance from the fire of the enemy we talked over the affairs of the moment, when, tossing his leg about on the saddle, he declared he felt no inconvenience from the wound, and would go back, as he saw his corps was very much exposed. I explained to him the dangerous nature of the wounds of the knee-joint, and after he had staid with me a couple of hours, I persuaded him to go into the town. This injury, although at first to all appearance so trifling, and under the best surgical care, caused the death of this officer in a very short time, and proceeded so rapidly as to prevent any relief at last being obtained by amputation."

Some years ago MM. Larrey and Garriques, in France, recommended the amputation of the leg immediately below the tuberosity of the

head of the tibia, instead of amputation of the thigh, where it was found impracticable to remove the leg at the ordinary place of election—four inches below the knee-joint. But Larrey made an addition to this operation, namely, the extraction of the head of the fibula. He says, "when the fibula is left short, which is usually the case, it is to be extirpated as useless, and troublesome in the application of the artificial leg, and the skin is to be left as long as possible, to cover the stump." Mr. Guthrie gives Larrey much praise for drawing the attention of the profession to this "great improvement," and adds the weight of his high authority by recommending the removal of the head of the fibula. In alluding to this subject we may appear to be departing from the proper object of this article,—the abnormal appearances presented by the knee-joint; but having known some melancholy examples of acute inflammation of the knee-joint to follow the operation here recommended, we take this opportunity of warning the profession against it. Mr. Guthrie himself says, "it is possible, however, that a case may occur (perhaps one in a thousand) in which the head of the fibula communicates with the general cavity of the knee-joint; in such a case amputation must be done above the knee." Independently of this communication between these two contiguous joints which Mr. Guthrie considers so rare, we have found, by repeated anatomical examinations of the relation existing between the synovial sacs of the knee-joint and that of the superior tibio-fibular articulation, that these two sacs are so close as to have but a thin transparent wall separating them. We consider it, not absolutely, but very nearly impracticable to cut out the head of the fibula in the living subject without making a communication with the posterior and back part of the synovial membrane of the knee-joint, so delicate is the thin transparent membrane which is interposed between the synovial sac of the knee-joint and the little synovial sac which partially envelopes the head of the fibula. Besides, in the living subject it must always prove to be a difficult matter to remove the head of the fibula without interfering with the tendon of the popliteus muscle, as we know the tendon to be enveloped by a synovial production sent down along it, like that which in the shoulder-joint invests the tendon of the biceps. This synovial production is not confined to the tendon of the popliteus, but is also reflected over the groove formed for the reception of this tendon, and must be in danger of being opened in every operation which we can devise for the removal of the head of the fibula; and consequently, although there may be many cases in which it may be advisable to amputate the leg a little below the tubercle of the tibia, *in no case*, in our opinion, should the surgeon attempt to extirpate the head of the fibula. The idea that this small portion of bone, when left, is "useless and troublesome in the application of the artificial leg," may be true, but it is not the less true that in the majority of cases acute arthritis of the knee-joint will be very likely to

succeed to this operation; and we feel satisfied that, as soon as these anatomical relations between the synovial sac of the knee-joint and that of the superior tibio-fibular articulation are reflected on, this modern proposal will be rejected.

Among the causes of acute arthritis genu, exposure to cold is very frequently referred to by the patient, and apparently with reason. The knee-joints being less covered by muscular parts than any other of the large articulations, are more subjected to the influences of cold, and on this account are perhaps more generally affected by acute and chronic inflammation than other articulations. It must be admitted, however, that we have met with cases of acute inflammation of the knee-joint for the origin of which we could assign no cause, having come on, as we are accustomed to say, *spontaneously*. Acute arthritis genu sometimes arises as a symptom in the course of different diseases. Thus in diffuse inflammation and in phlebitis it is quite usual to find the joints visited by most severe attacks of inflammation. We have seen examples of acute arthritis supervening suddenly in the course of a severe attack of erysipelas;* and in rheumatic fever and puerperal rheumatism we can see little else than an inflammation of the joints, the nature of the inflammation in these cases, however, being very different.

Although we have here spoken of three different forms of disease, diffuse inflammation, phlebitis, and puerperal rheumatism, we have ourselves long entertained the opinion expressed by Mr. Arnott, Velpeau, Dance, Cruveilhier, our friend Dr. Beatty, and others,† that the three forms of disease in which the acute arthritis we are here treating of occurs, are the same, and that the arthritis in all three is similar, and proceeds from the same common cause, viz. phlebitis and its consequences.

The peculiar form of acute arthritis here adverted to has in almost all cases been found to have been preceded by phlebitis. This may have come on spontaneously, or in consequence of a wound, or of the vessel having been included in a ligature. The form of acute arthritis which has been called puerperal rheumatism has also been found, in many cases, coincident with or preceded by phlebitis of the veins of the uterine system, or of some other veins.‡

We have seen many cases which we considered to be examples of diffuse inflammation in very young subjects, engaging the periosteum of the femur and tibia, and terminating in the complete destruction of the bone, in the short space of three days. Sometimes the periosteum of the femur, for example, formed a complete cylindrical sac containing the detached shaft of the bone.

The symptoms of acute arthritis which occur in the course of a case of diffuse inflammation

* See Dublin Journ. vol. xvii. p. 336, and in this article p. 55.

† See Dublin Journ., and Mr. Arnott's valuable observations in the Med. Chir. Trans.

‡ See Dance's, Beatty's, and Mr. Harrison's cases, Dublin Journ.

are usually ushered in by a severe rigor followed by perspiration. The patient is remarkably restless and depressed in mind. If the phlebitis be external, as in that occasionally succeeding to venesection, which has preceded the acute arthritis, the inflammation along the course of the wounded vein will be observed for several days before the attack of arthritis shall come on. Whatever may have been the cause of the inflammation of the joints, the disease does not, as in rheumatic fever, pass successively from joint to joint, completely leaving one joint to visit another. Although varieties may of course be noticed in the local symptoms which this dangerous disease presents, it very constantly happens that a joint once visited by it seldom or never completely recovers its effects. Usually many joints are successively or simultaneously affected, and we very generally discover that one or more of the internal organs is also implicated. Whatever joint is attacked in the course of the disease, it presents the ordinary characters of an acute arthritis. The integuments covering the articulation sometimes wear a pink hue, and always have an elevated temperature. The affected limb is powerless. The patient complains of very considerable pain, more particularly, as it appears to us, in puerperal arthritis than in the affections of the joints which attend on the ordinary forms of diffuse inflammation. The swelling, when first examined, is soft and fluctuating. After a time the effusion of synovial fluid and pus increases, giving rise to the distension of the synovial sac. If at this advanced period we carefully examine the parts immediately surrounding the inflamed joint, we can discover that the integuments and subjacent parts feel somewhat indurated and œdematous, reminding us of the hardened basis which we find circumscribing an abscess. It is probable that this condition of the surrounding parts arises from diffuse inflammation and the infiltration of its digested purulent matter. The arthritis in these cases is seldom the cause of death; either some internal vital organ becomes violently inflamed by which the death of the patient is accelerated, or abscesses form in the subcutaneous or intermuscular cellular membrane in various parts of the body, which, although more slowly, as certainly lead to a fatal issue, for when the evacuation of the pus takes place, the quantity of matter which is discharged and continues to be secreted is so excessive as greatly to reduce the patient's strength, and the exhaustion from this source and from the diarrhœa which usually attends are sufficient to prostrate the powers of the youngest and strongest individuals. Most writers indeed have observed that in the majority of cases the subjects of this disease had been in a bad state of health at the time the exciting cause came into action,—a cachectic condition produced by over-exertion of mind or body, and that from these circumstances the susceptibility or predisposition to this disease most probably arose.* These observations are, we believe, fully borne out by experience, and it may not

perhaps be uninteresting to adduce some remarks published by an author nearly forty years ago, which prove that he was practically acquainted with the complaint denominated by the moderns puerperal rheumatism or puerperal arthritis, and that he took a similar view of the predisposing causes of this disease. Mr. Russell in his work on the knee-joint, in treating of acute cases of what he calls white swelling, says: "in those cases which proceed most rapidly, the disease will reach its acmé in the course of a few weeks." The very rapid and acute cases seem to be connected with some state of great relaxation and weakness. He adds, "the most remarkable instances of this variety which have fallen under my observation, have occurred in the cases of women in child-bed." In the Richmond Hospital (Dublin) we had had many cases of this form of acute arthritis, from which we select the two following as serving to illustrate some of the foregoing observations. Both these individuals were in a delicate state of health when the disease attacked them, and the swelling of the knee-joints and other articulations formed a very small part of their diseases.

Andrew Turner, 28 years of age, was admitted into the Richmond Hospital on the 7th of May, 1836. He had much abused his health and constitution. Five days after having been bled in the right arm to relieve the consequences of a severe beating, a superficial diffused redness appeared on the skin of the forearm; the venesection wound was swelled and inflamed; a severe rigor occurred, followed by profuse perspiration and fever; erratic erysipelas characterized by a faint red mottling of the skin in patches appeared; a blush of inflammation in the form of a patch showed itself on the shoulder, but not continuous with that on the fore-arm; a pink patch next appeared over the right knee, then on the left arm, and afterwards on the left lower extremity; and while this disease invaded the body part after part, those once occupied remained engaged as before. On the 15th May, the ninth day from his admission, there was observed effusion into the right knee and into the bursa which is subjacent to the cruræus muscle. Although considerable, this effusion escaped the patient's attention; he complained of no pain, and to our enquiries always replied that he was going on "gaily." On the 18th the left knee-joint was tumefied, but not to the same extent as the right. He died on the 26th, his death being preceded by the ordinary symptoms of pneumonia, pleuritis, &c. On the post-mortem examination the anatomical appearances of pneumonia, pleuritis, and bronchitis were seen; there was also effusion into the cavities of the pericardium and peritoneum. In the right knee-joint and subcutaneous bursa, which freely communicated with it, there was a large quantity of yellowish green fluid, which seemed to be formed of the mixture of purulent matter with the synovial fluid: flakes of lymph floated in it. The synovial lining of the subcruræus bursa was very red, as was also that of the joint itself. The synovial membrane was elevated above the level

* See Dr. Beatty, Dublin Journal, &c.

of the cartilages by subsynovial infiltration. The ligamentum mucosum, as it is called, was very vascular. The capillary system of the semilunar cartilages was injected with minute red vessels. The left knee-joint, which had been but lately attacked, contained an inordinate quantity of synovial fluid, of a greenish-yellow hue, and of a thicker consistence and a deeper colour than natural. The synovial membrane was pale, and there was no infiltration in its subsynovial structure. The vein in which venesection had been performed was contracted in the neighbourhood of the wound, and lymph adhered to its lining membrane. Above the right elbow-joint and internal to the course of the vein, there was a small collection of matter between the skin and fascia.

Susan Brett, æt. 24, was brought into the Richmond hospital on 26th February in great distress and pain. On the 14th February she was suddenly seized with convulsions, being seven months pregnant. She was bled in the right arm and her head shaved. Two days after the operation the arm became very painful and swollen. The pain increased, and on the 21st labour-pains came on and continued during the day. In the evening she was again attacked with convulsions, and blood was drawn from the left arm. The child (her first) was not expelled until early the next morning; the evening of the same day she had a severe rigour, which lasted half an hour, and was succeeded by profuse perspiration; this soon went off, but she remained cold and chilly for the remainder of the night. On the following morning (23d) she was seized with what she called severe rheumatic pains in her hips and right shoulder, which left her "all sore" and completely powerless. On the 24th the pain in the right shoulder-joint became most intense, and a severe stitch seized her in the same side, which prevented her drawing her breath. The pain in the arm also was now very severe, extending upwards from where venesection was originally performed. The wound was found not yet healed.

When brought to the hospital, the fifth day from her lying-in, she was in great distress and pain. Her pulse was 140, with some fulness, but still compressible. She preferred lying on her right side bent forwards, with her knees drawn up. Her respirations were fifty-two in a minute, and greatly oppressed. At each effort of inspiration the *alæ nasi* were much dilated. Her countenance was anxious, and there was a bright circumscribed flush on each malar eminence. For the last week she has raved constantly at night, and has been more ill at certain hours of the day, very early in the morning, and again at half-past five, P.M. At the latter hour she was generally found perspiring copiously. Her bowels were too free. She complained of pain chiefly in the right shoulder and the lower part of the back; also in both her knees and metacarpal joint of the index-finger of the left hand. She also complained of her left hip. The right arm was swollen but not discoloured, œdematous, and pitting on pressure. The original wound made for vene-

section was gaping, with unhealthy everted edges; no matter exuded from it. She kept the arm in the flexed position; to herself it felt quite powerless, and when the least movement was communicated to it, she suffered great torment. There was a hard line up the arm corresponding to the course of the basilic vein, and when even the slightest pressure was made in this line, she suffered pain. Immediately above the elbow-joint the skin was hard; the subcutaneous cellular structure seemed more or less œdematous as if infiltrated with fluid; the skin and subjacent parts seemed to be matted together and somewhat œdematous, and pressure here also gave the patient much uneasiness. There was a suffused pink blush on the skin covering the metacarpal joint of the index finger; the joint was much swollen, and she complained of much pain in it. Her principal suffering was from dyspnoea. An examination of the chest by auscultation and percussion furnished all the evidence of extreme bronchitis in both lungs, pleuritis with incipient pneumonia: it was also inferred that effusion had taken place into the right side of the thorax.

On the 28th February some of those deceitful appearances of amendment not unusual in the course of acute disease discovered themselves. It was reported that she had passed a better night; her pulse fell to 128; her respiration was reduced to forty in the minute; but in the evening a pain, which she referred to the situation of the diaphragm, came on with great severity. Her cough was troublesome and in paroxysms; she expressed great anxiety about herself, inquiring whether there were any hopes for her, and complained of pain in her left elbow, where, however, there was no swelling. The original wound made in the right arm for the first venesection was still open, but there was no inflammation about it. The wounds made in the left arm for two subsequent bleedings healed perfectly. She now had pain in all her joints, particularly in the metacarpal joint of the index finger of the left hand. The shoulder-joints were swelled, and she could not bear the slightest movement of them. Her knees were very painful, chiefly the left, which was greatly swollen, but its integuments were not discoloured. Diarrhœa was very troublesome.

On the 2d of March profuse perspiration broke out over the whole body, and œdema of the feet came on. The next morning her pulse was 128; respiration was jerking and very much hurried; and her countenance betrayed great internal distress. She had raved all night. There was complete orthopnoea, and the swelling of the knees increased. She died at four o'clock.

On an examination of the body twenty-two hours after death, the shoulder-joints were found to contain a viscid greenish imperfectly formed pus. Matter of the same appearance, but less viscid, was met with on cutting down to the right shoulder-joint among the muscles external to it. The cartilages in both these articulations had lost their colour and seemed

thinner than natural, but were not ulcerated. The elbow-joints were in a normal condition. The joint of the index finger contained a thin greyish coloured matter, which was not confined to the joint, being also found in the muscles external to it. The cartilages on the head of the metacarpal bone and corresponding surface of the index finger were much ulcerated and partially removed. The knee-joints contained a large quantity of a viscid greenish matter like lime-water and oil. Behind the right knee-joint, and extending down to the gastrocnemii muscles, matter of somewhat a similar character, except that no synovial fluid was mixed with it, occupied the interstices of the muscles and the cellular tissue of the lower part of the popliteal region. The hip-joint did not contain any matter.

The basilic vein of the right arm was plugged up with a dense coagulum, which closely adhered to its internal tunic, and was not easily separable from it. There was no pus in the vein; its exterior presented an unusual red colour.

On opening the cavity of the chest a quantity of serum escaped. There was a great quantity of a very yellow lymph effused on the surface of the pleura of both lungs, principally the right. In many places it was very thick, rough, and consistent. On the diaphragm and in the right side of the chest the lymph was soft, of a greenish colour, being in shreds easily removed, and leaving the subjacent membrane highly vascular. There were also evidences of interlobular pleuritis having existed: all division into lobes had been effaced. The lungs presented specimens of pneumonia in its three stages. A very small portion of the apex of the left lung alone seemed healthy, but even here the bronchial membrane was engaged and presented evidences of bronchitis having existed. In the substance of the lungs there were also found small abscesses presenting near their surface like little gangrenous abscesses surrounded by ecchymosed red spots; these contained some grumous dark-coloured fluid, which, however, was inodorous. In others was found an ill-digested purulent matter; and leading to one of these disorganized portions of the right lung near its apex, the minute veins on very careful dissection were found thickened, with yellow parietes; and many of those present at the examination satisfied themselves that these minute veins contained purulent matter. The heart and pericardium were natural. The most careful examination could discover nothing abnormal in the uterus. The large intestines throughout presented numerous ulcerations on their mucous surface; the neighbourhood of the ileo-cæcal valve being most beset by them. The mucous membrane was in a state of hyperæmia.

The prognosis in cases of acute arthritis genu is in general very unfavourable except when the disease accompanies what has been usually termed rheumatic fever. In this case the synovial system of all the articulations is visited in succession, until the inflammatory disease exhausts itself as it were in three or four weeks,

often leaving no trace behind. It is, however, well known to medical men that in the course of these fevers fatal metastasis may occur from the synovial membrane of the knee or other joint to the pericardium or peritoneum.* In some few cases, after the general rheumatic fever and acute specific arthritis had subsided, we have known the chronic rheumatism, or nodosity of the joints, to set in, remaining permanently to interrupt the patient's health. Not long ago there was a young woman in the Richmond Hospital, under the care of Dr. Hutton, having acute arthritis of the right knee-joint, which had remained after a severe attack of general rheumatic fever. All the joints in succession had been visited by inflammation. The fever, with its debilitating accompaniments, profuse perspirations, &c. subsided, but the local symptoms of acute arthritis of the right knee-joint continued, and increased even to suppuration, nor did amputation of the limb save the patient's life. These unfavourable results of acute arthritis, of the rheumatic form, may be considered as exceptions. In general the form of inflammation of the joints, commonly called rheumatic fever, terminates favourably; on the contrary, in cases where the knee-joints and other articulations are engaged during an attack of diffuse inflammation, puerperal arthritis, or phlebitis, the prognosis is most unfavourable, the disease in all these cases being generally fatal whether the joints be implicated or not.

Anatomical characters of the acute arthritis of the knee.—On examining the interior of a knee-joint which had recently been the seat of acute inflammation, we find that the synovial fluid has accumulated in the cavity of the joint, and that it is mixed with purulent matter; when this is removed, we perceive that the synovial sac has been widened and enlarged, and that the subsynovial tissue is much infiltrated, causing the synovial membrane to be raised up above the level of the articular cartilages. We have seen the synovial membrane or subsynovial tissue as red as the conjunctiva oculi in acute purulent ophthalmia. In these cases the articular cartilages lose much of their natural white silvery lustre, become yellowish, and are found softened at their edges or circumference, where the elevated and inflamed synovial membrane is in contact with them. We have found the cartilage of the patella softened and partially detached from the bone, even in very recent cases. In cutting down to the joint we have noticed an alteration in the natural colour of the muscles; and outside the synovial sac we often encounter abscesses containing true pus. Generally speaking this sac is of an intensely red colour, and covered here and there with a green but not very consistent layer of organizable lymph. Some fragments of thinned shreds of exfoliated articular cartilage, with serrated edges, hang into the cavity of the joint, and some portions are altogether free,

* See Dublin Hosp. Rep. vol. ii. p. 321. vol. iv. p. 365.

and float about loose in the interior. We have found the minute capillary vessels of the cartilages faintly traced in red lines, and have also discovered that these vessels admit the colouring matter of our injections. The vascularity of the cartilages under the influence of acute inflammation seems to be fully proved. We have it on the authority of Sir B. Brodie that he had been able to detect with the naked eye vessels in articular cartilage filled by blood; and it is fresh in the recollection of the profession that Mr. Liston has lately laid before the Medico-Chirurgical Society important observations on this subject.—The periosteum of the bones in the immediate vicinity of the knee is usually found to be of a red colour, thicker than natural, and easily detached from the bone; the bones themselves occasionally present a reddish or pink hue externally, and a section of them shews, by its bright red colour, an increase in the number or size of the capillary vessels, admitting red blood, which pervade their medullary membrane and cancellated structure.

Example of acute arthritis genu.—Michael Roche, twenty-seven years of age, was admitted into the Richmond Hospital in April 1832. He had an emaciated appearance, a dry tongue, and some fever. He complained of severe pain in the left knee, which completely interrupted sleep, and of frequent spasmodic startings of the limb. The limb was so much swollen that measurement of it showed an increase of six inches in its circumference over the sound one. The superficial veins were dilated, the patella was thrown much forwards, and the leg and foot were œdematous; the integuments were red and thinned, and a fluctuation of matter in the joint was very evident. He stated this violent attack to be of five weeks' duration, having commenced with a very severe rigor, and attributed it to his having lain for some hours on wet grass. Three years previously he had had an attack of acute inflammation of the knee, which, however, quickly subsided, but leaving a stiffness of the joint. An opening was made with a lancet into the part of the knee-joint which was red and thinned, and eight ounces of purulent matter were let out, but no relief was afforded. Some superficial inflammation was observed, in the course of the lymphatics to the groin, from the wound, as also swelling of the inguinal glands. The spasmodic startings of the limb became more urgent, and the œdema increased. On the 17th of April Dr. McDowel amputated the limb. The incision passed through a sinus which he thought it necessary to dissect out. The muscles did not retract. On the following day the report from the man was that he rested well at night. But on the fourth day after the operation his countenance was flushed, his pulse feeble—96, and he complained much of the pain of the stump. On the 22d of April, the fifth day after the amputation, he had a rigor followed by a hot and sweating stage: his pulse amounted to 144. For some days subsequently he had frequent rigors. The stump was not doing well; the muscles were

shrinking away daily and leaving the bone uncovered. The edges of the wound had a sloughy appearance, and towards the end of the month he was attacked with diarrhœa which in a few days proved fatal.

On an examination of the knee-joint all the structures entering into its composition exhibited evidence of their having been the seat of recent high inflammatory action. The bones and synovial membrane presented a very great degree of vascularity and redness; purulent matter and flakes of lymph were contained in the interior of the joint; a fragment of one of the semilunar cartilages alone remained, and the articular cartilages were in many places removed altogether; in other situations these latter were thinned very much, and in one or two places a number of minute perforations were seen in the articular cartilage investing the lower end of the outer condyle of the femur. The minute vessels of the joint were rendered evident by a previous injection of fluid size coloured by vermilion. The synovial membrane was much thickened and raised above the level of the cartilages; it presented a red pulpy appearance, and productions from it passed from the side of the femoral condyles and were loosely folded over the articular cartilages; and wherever this loose membrane was in contact with the articular cartilages, these seemed to have been absorbed. Depressions in the cartilages exactly corresponded in form with this vascular membrane, which was lodged in these superficial depressions. The articular cartilages were thinned, and when elevated from the bone a red pulpy membrane, very similar in appearance to the free surface which the synovial membrane presented, was seen. The minute pores and perforations in the articular cartilages already noticed were evidently formed by the action of a pulpy membrane subjacent to them, and causing their absorption, evidently in the same manner, it appears to us, as we find an exfoliation from a flat bone of the cranium to be perforated by the absorbing powers of the granulations proceeding from the bone beneath it. In examining this preparation, and reflecting on the history of the case, it would appear that when the limb was amputated, the complete destruction of the articular cartilage was in progress. On the free surface towards the cavity of the joint, the cartilage was evidently absorbed by the villous productions from the inflamed synovial membrane; on the osseous surface the cartilage was acted upon by a pulpy membrane, which existed here also, and it was this membrane which was produced from the bone and caused the number of minute perforations already alluded to, having partially removed the articular cartilage.* The bones were in a condition of hyperæmia. This newly formed membrane seems to be endowed with a power of absorbing, by its villi, the cartilage with which it comes in contact; for we must agree with Mr. Key that these vascular fimbriæ or tufts are often buried into excavations in the

* The preparation is preserved in the museum of the Richmond Hospital.

cartilage, and the convexity of the villous membrane seems sunk into foveæ formed in the cartilage, so as to leave no doubt of the vital mechanism, if we can so say, of the process, which seems quite analogous to the absorption of the sequestrum of a cylindrical bone, or the exfoliating piece of a flat bone. The writer presented to the Pathological Society of Dublin a recent specimen and a drawing of the knee-joint of a man aged seventy, William Walsh, who died the day previously (13th Dec. 1839) in the House of Industry, of an attack of acute arthritis genu which had supervened on a chronic disease of the joint of long standing. The synovial sac of the joint had been much distended and was more capacious than usual. It was greatly thickened, and presented on its internal surface an intense scarlet colour. Extensive deposits of a yellowish green lymph were noticed over the entire of the synovial sac: the strong contrast in colour between the green lymph and the red villous synovial membrane is well seen in the preparation. The crucial ligaments were partially removed, and it was found on dissection that the internal and external lateral ligaments had lost all their distinctness as fibrous bands; both seemed to be resolved and spread out into thin membranes or fasciæ, which but little restrained the movements of the knee, and allowed of a motion of rotation being communicated to the joint. The articular and semilunar cartilages were removed, and the denuded porous surfaces of the bones of the tibia, femur, and patella presented numerous small red spots, as if they had been sprinkled with red sand. An abscess containing about two ounces of yellowish green pus, of a laudable consistence, was found under the cruræus muscle, just above the synovial sac of the joint: this abscess was isolated, and had no communication whatever with the interior of the sac of the joint. The fluid in the interior of the articulation was more of a thin sanies than pus, but was abundant in quantity, and had made its way externally by a large sloughy-looking opening in front of the leg, about two inches below the knee.

Michael Smith, 58 years of age, was admitted into the Richmond Hospital in 1838, labouring under erysipelas of the head. During the course of the disease, one of his knee-joints became hot and swollen, the patella seemed to float, and on each side of it a fluctuation became evident. He was more or less insensible from the erysipelas of the head, but when the knee-joint was moved, he exhibited signs of suffering. On the eighth day after the knee-joint was first affected, he died of the erysipelas of the head. The knee-joint was carefully inspected, fine red injection having been previously thrown into the femoral artery. The synovial sac of the articulation was distended by a turbid yellowish-green fluid, apparently composed of a mixture of pus and synovia. When this was washed away, the synovial membrane was found not so much thickened as in the former case, nor had it so much of the vivid scarlet colour as the last specimen alluded to; and reminded those who examined it of the

appearance which the conjunctiva presents in subacute conjunctivitis. This membrane appeared to be thickened and pulpy where it had already advanced somewhat over the external condyle of the femur. The subsynovial tissues were more or less infiltrated. The cartilages had lost their normal whiteness and brilliancy, and were of a murky yellowish hue; they were somewhat softened in their substance, and the cartilaginous covering of the patella was slightly elevated, in patches, and one spot of ulceration was seen at the circumference of its external edge. The cartilage covering this bone was so soft that the blunt probe easily penetrated into its structure. Many would call this a case of simple synovitis genu, but it is manifest that, although the acute disease in the knee originated in the synovial membrane, the other structures of the joint very soon became implicated, and that, at the period of the patient's death, which was only a few days after the first attack of the joint, the term of synovitis of the knee-joint was not sufficiently comprehensive. We have had many opportunities of examining the knee-joints of those who have died of diffuse inflammation, which has occurred in females some short time after parturition, and in those cases denominated puerperal rheumatism, and in cases where the arthritis of the knee or other joints was concurrent with phlebitis; and in such cases we have found the most remarkable phenomena to be,—great effusion into the knee-joint of a fluid which would seem to be composed of equal parts of pus and synovial fluid. This was viscid, of a sea-green colour, and of the consistence of honey. In cutting down to the joint in these cases we frequently met with ill-digested matter in and amongst the muscles surrounding the affected articulation. The synovial membrane was of a pink colour. The articular cartilages presented an appearance which was rather peculiar. We have found them generally to preserve their normal adhesion to bone, to be smooth on their surface, but to be evidently thinned, and so reduced as to form a stratum covering the condyles of the femur scarcely half a line in thickness. The inter-articular cartilages externally preserve their normal appearance, but we can occasionally discover that after an attack of acute arthritis of the description now under consideration, these structures shew that they are permeated internally by capillary vessels containing red blood. We have had many,—too many examples lately verifying the above description of the anatomical appearances presented on the examination of the knee-joints of those who have died of diffuse inflammation.

Simple chronic arthritis of the knee.—The symptoms which denote the existence of simple chronic inflammation of the knee-joint are very similar to those belonging to the acute affection of this articulation, being only slower in the different stages of their development and milder in their character.

The simple chronic arthritis genu commences with a pain which the patient usually refers to the inner side of the joint. This pain is not sufficient to prevent him from following his

ordinary occupation, and is at first usually unaccompanied by swelling, or if swelling exist at this early period, it is inconsiderable. There is more pain and less swelling than in the ordinary case of scrofulous white swelling. The swelling, too, is different, that in the strumous being more elastic, more of a globular form, and situated at first more at the lower and anterior part of the joint around the ligamentum patellæ: in the strumous also the ham is sooner filled up. Moreover, the simple chronic arthritis of the knee is a disease of adult life, and the strumous of the younger subject. As the simple chronic arthritis of the knee proceeds, the limb wastes somewhat, a preternatural effusion of synovial fluid into the joint takes place, and pain on motion becomes so severe as to confine the patient to the house; he complains of a constant, deep, boring pain, which is usually referred to the inner condyle of the femur or tibia, and is accompanied by some spasmodic starting of the muscles of the limb, by which his sleep is disturbed. When pressure is made on the knee over the situation where uneasiness is experienced, the pain is increased; and the integuments of the affected articulation have a higher temperature than natural. In the early stage of the disease the popliteal space is not filled up. As the inflammatory action proceeds, the patient's strength and spirits become exhausted by continued pain and confinement; the constitution becomes engaged, suppuration occurs in the interior of the joint, and matter makes its way to the surface, œdema of the instep manifests itself, and the disease now runs very much the same course as does the chronic strumous white swelling, partial dislocation of the tibia outwards or backwards occurring, and amputation becoming necessary to save life.

The two following cases may serve as examples of the simple chronic arthritis genu. The first presented us a rare opportunity of witnessing the anatomical characters of the disease in a very early stage; the second in the advanced form, as amputation could no longer be deferred with safety.

J. McCann was admitted into the Richmond Surgical Hospital on the 13th Dec. 1836, for an affection of his left knee-joint. The attack was about six weeks coming on, but he remembered that about ten years previously he had fever, and that the left knee-joint was at that time severely visited by inflammation. Since that period, however, he remained well until he got cold, which ended in the present attack of the knee, and at this time no other joint was affected. The joint appeared to be much enlarged when compared with the right and healthy knee; the prominences of the bones were no longer evident; the swelling was soft and fluctuating, and extended up the front of the thigh, but the ham was not in the least filled up; the knee was slightly flexed, and the tendons of the hamstring muscles were remarkably tense; he referred the pain to the internal side of the joint. Hoping to be released of these symptoms he sought admission into the hospital. He was ordered twenty-four leeches and fomentations to the knee-joint, and to take

three times a day a pill containing two grains of calomel and half a grain of opium. On the fourth day of this treatment he complained of scalding when passing urine, and of acid eructations from his stomach. For the latter magnesia and lime-water were given. On the fifth day diarrhœa, probably mercurial, set in, which was very severe and did not yield to the treatment, which consisted in the administration of an emollient enema containing forty drops of tincture of opium, and of a pill every third hour, containing two grains of acetate of lead and one grain of opium; and warm fomentations with turpentine to the abdomen. After the fourth pill had been taken the diarrhœa ceased. It is proper to mention that the foregoing symptoms were accompanied at the commencement by a good deal of fever of the sthenic type; the patient's face was greatly flushed, his eyes glistened, the lips were vermilion red, the pulse was one hundred and strong, and there was much increase of heat of the surface. When the diarrhœa ceased, a new phenomenon, hæmaturia, presented itself, accompanied by great pain across the lumbar region, along the course of the ureters, and in the testicles. The calls to pass water occurred hourly, and half a pint of urine and blood mixed would pass, which had not any urinous odour. These calls became less frequent, but the fluid passed became more and more red; his countenance changed, and he had the general symptoms of loss of blood. Added to this his stomach was in a continued state of erethism; he had urgent desire for cold drinks, but nothing, not even cold water, would for one moment remain on his stomach. His countenance was sunken and exsanguineous; his pulse, one hundred and forty, could scarcely be counted. His surface became cold, and he complained of the greatest sense of exhaustion. At this period most urgent singultus set in and added much to his other sufferings. The hæmaturia continued, the stomach rejected every species of nutriment, and medicine failed altogether to relieve his symptoms. He died exhausted on the fourth day from the diarrhœa setting in, and on the seventh from his admission into hospital. It is remarkable that during the last three days of his illness he did not feel any uneasiness in his knee, and the swelling of the joint had greatly diminished.

On a post-mortem examination the kidneys were found much enlarged and friable, with some purpuric spots (petechiæ hæmorrhagiæ) on their surface. The spleen was very small and of a healthy consistence. On opening the bursa beneath the rectus and vasti, it was found to be distended with synovial fluid of the ordinary character; no communication existed between this bursa and the knee-joint. When the proper synovial membrane of the joint itself was opened, the quantity of synovial fluid was found to be very scanty. The semilunar cartilages were normal, but the articular cartilages which invest the tibia and femur were of a yellowish hue, and here and there appeared softer than natural. In one spot the cartilage covering the convexity of the internal condyle

of the femur was superficially removed for the size of a sixpence. To this softened, ulcerated, or abraded point the principal pain was referred, by the patient during life. There were not any loose and vascular synovial fringes hanging into the interior of the joint, but examining at the circumference of the cartilage, where it invests the external condyle of the femur, this membrane and its subsynovial tissue were very red, vascular, and villous-looking. The outer edge of the cartilaginous covering of the femoral condyle was thin and minutely serrated, and the eye of the probe could be placed under this edge.

John Nugent, æt. 19, was admitted into the Richmond Hospital, January, 1839. He had been under treatment in the country for six months for a disease of the left knee-joint which originated in a blow on the joint from the handle of a printing-press. He fainted at the time of the accident, and the pain never ceased from that day up to this period of his admission. He was reduced a good deal in flesh. He had occasional perspirations during the night, particularly about the head, and starting pain shooting up and down the leg. He could not bear the joint to be moved but kept it semiflexed, and the limb lying on the outside. He stated that before his admission he had never been altogether confined for the complaint. There was some little swelling of the knee, which was tender on pressure. There was no swelling in the ham, nor enlargement of the inguinal glands. The calf of the leg was wasted, and the thigh also was less than the other by an inch in the measure of its circumference above the knee. He remained much in this state until March 14th, when he complained of suffering a constant "dead pain" across the joint below the patella; besides this there was occasionally a throbbing sensation which was more distressing to him than any other, even than the spasmodic starting of the limb. On the 2nd of April a valvular opening was made with caution into an abscess on the inside below the articulation; thin curdy matter came away. This gave him some relief. On the 4th another opening was made in the outside above the joint, where also the abscess showed itself: matter of a similar description came away. Previous to these punctures having been made, amputation was proposed to the man as the only means of escape from this disease, but he preferred to have the abscesses opened. Fever did not follow upon this first or second operation, but subsequently it set in, and ran very high for four days, during which he perspired largely and had much pain and starting of the limb, with head-ache and anxiety of manner, and for two days he was in a confused state bordering on delirium. Nor did the evacuation of the purulent matter prevent the enlargement of the cavities of the abscesses connected with the diseased joint, as appears by the following report, dated May 10th, made by our clinical clerk, Dr. Bradshaw. "The abscess has ascended up the thigh, running high up the popliteal region. The hectic fever is severe; his pulse in general 120, small and compressible; emaciation had advanced and is still advancing; his strength is giving way

under the disease, and he must soon sink if amputation be not consented to." On the 10th May the report was, "Diarrhœa still continues, but without abdominal pain or tenderness. The emaciation is very great. Pulse 120, small, and compressible. Tongue red, moist, and morbidly clean. The flexion of the leg on the thigh becomes every day more and more considerable, so that the angle becomes daily more acute." On the following day amputation high up was performed. The disease of the knee had much affected the cartilaginous structures of the joint, the absorption of which seemed to have been effected by a vascular pulpy membrane. The parts that had suffered most were the external condyle of the femur, the inner head of the tibia, and the inner and posterior surface of the patella. Along the trochlea of the femur there existed longitudinal grooves or furrows in the cartilage, which was not removed. A highly vascular and pulpy membrane was found filling the parts wherever the cartilage had been absorbed, and this membrane could be traced insinuating itself beneath the edge of the remaining portions of the cartilage, by which means the process of absorption seemed to have been effected. In the interior of the joint there were much pus and flakes of lymph, and where the cartilages had been removed the porous surface of the bones had been covered by soft layers of lymph of very recent formation.

Chronic rheumatic arthritis of the knee.—In the articles HAND, HIP, ELBOW, &c. in this work we have treated of a chronic disease affecting other articulations, which we have denominated *chronic rheumatic arthritis*; we shall now give an account of the symptoms and anatomical characters of this disease as we have found it in the knee-joint. When this articulation is affected with it, other joints in the same individual will also be found more or less implicated. The commencement of this disease of the knee is marked by evidences of subacute inflammation, such as pain, heat, considerable swelling. This is followed by a second period, in which the heat and swelling diminish, but the pain continues. This pain is usually referred to the inner condyle of the femur and tibia. The patient may for a long period be able to walk, but every movement produces considerable pain, and at length he becomes incapable of walking or even of standing. The limbs diminish in size, but become remarkably firm to the feel. The patient having at last lost the power of flexing or extending the limb, the hamstring muscles gradually become more tense. The knee-joints from the commencement incline slightly inwards, and the tibia outwards, and this bone is at the same time rotated in this last direction, so that the foot is everted; if the limb then be kept in the semi-flexed position, and the tibia be thus rotated outward, carrying with it the ligamentum patellæ, it is easy to account for the circumstance which we have in some examples witnessed in the disease,—viz. that the patella leans towards the outer condyle, and further, that it is then sometimes thrown completely over it, so as to represent the external dislocation of this bone.

When the distension of the synovial sac of the articulation is at its maximum, we usually notice in this disease a prominent tumour about the size of a small hen's egg projecting into the popliteal space (*fig. 3*). This tumour leans towards the inner head of the gastrocnemius; it disappears when the knee is flexed, and becomes more tense and hard when the limb is in the extended posture, as when the patient stands erect. We have known several cases of this disease of the knee-joint, where the synovial sacs of the knees have been much distended, and have on these occasions almost uniformly observed this popliteal tumour formed. From its situation, and from negative evidence, we can readily infer that the swelling consists of synovial fluid contained in a bursa, which has a communication with the interior of the knee-joint.

We have witnessed very many cases of this chronic rheumatic arthritis of the knee, in which this dropsical condition of the popliteal bursa existed, and some of these having had this chronic disease in both knee-joints, the bursæ were seen in both popliteal spaces,—presenting in these cases on a superficial inspection the resemblance to a case of double popliteal aneurism.

We have also enjoyed an opportunity of ascertaining by anatomical examination the real condition of this synovial sac in this disease, and its relation to the synovial membrane of the joint itself, to which we shall have occasion just now to revert.

When the palm of the hand is applied over the patella in the early stages of the affection, a sensation of a preternatural degree of heat is felt; and when pressure is made on the patella, and a lateral movement across the condyles is communicated to it, a very evident roughness is perceived, either on the articular surface of the patella itself, or the corresponding surface of the trochlea of the femur; and when the knee-joint is fully flexed, a characteristic articular crepitus becomes manifest. In the later stages of the disease, the subsacute inflammation, with the phenomena which it presents, subsides, the synovial fluid becomes absorbed, and the patella falls down on the trochlea of the femur; the popliteal bursa also disappears, and the grating produced by rubbing surfaces is perceived by the patient himself in all his movements, and can even be heard by the bystanders. If the joint be now examined carefully by the surgeon, he feels satisfied that the smooth cartilage has been removed, either partially or completely, from the articular surfaces. Crests of ossific deposit may even be perceived, and, almost invariably, foreign bodies may be felt in the interior of the joint. Some of these are superficial, small, and moveable; others are evidently situated more deeply in the interior of the joint. Some are small, some large, and we have known one case, which we learned to be of forty years standing, in which numerous bodies* of this description

could be felt, some literally as large as the patella, floating about in the interior of the knee-joint, and which, we doubt not, were exactly of the same nature as those we have described in the elbow-joint.

The prognosis in this disease must be unfavourable, as it seldom yields to medicine, but it does not appear to us to shorten life. We have seen an example in which the knee-joints had been affected with this disease, as the patient herself reported, for forty years. We are not prepared to say, however, that medicine and proper treatment may not occasionally cut short the disease, and we are sure the sufferings of the patient may be palliated at least by appropriate treatment. The following case is a good example of this disease.

Case of chronic rheumatic arthritis.—Patrick Donohoe, aged 38, a carter, admitted into the Richmond Hospital, (Dublin), Nov. 24, 1836, complained of chronic pains in all his joints, but the principal source of his uneasiness was the diseased condition of his knee-joints, which prevented his earning his livelihood. Both knee-joints were greatly swollen; he complained of stiffness of them, and of some pain at the inner condyle of the tibia, which increased when he stood up; yet he was able to walk a considerable distance. The limbs could be fully extended, and when in bed he kept them pretty constantly in this position. He could not fully flex them backwards. The swelling of the knees differs from that of an ordinary white swelling, although it might correspond much to the characters which a case of chronic synovitis of the knee might present, or to a case which the older writers denominated *hydrops articuli*. The swelling viewed in front is of an irregular globular form, involving the patella, its ligament, and the hamstring tendons in one uniform tumour; on the contrary the ligamentum patellæ can be felt, with its edges as yet sharp and well defined, when the patient is desired to exert the extensor muscles of the leg. The tibia at the side of the ligament, as far as the insertion of the internal lateral ligament, can be plainly felt through the skin to be rough and scabrous, and it can be perceived that this part of the bone is beset with bony vegetations. The breadth of the head of the tibia is increased; the synovial membrane contains a redundant secretion, which elevates the vastus internus and forms a swelling here which measures about seven inches in its vertical diameter, and which seems to be somewhat constricted transversely in its centre (*fig. 2*). The swelling of the knee on the outside is evident enough, but is not so well marked as that on the inner side. It presents no transverse band, subdividing it into two tumours. The outline of the hamstring tendons is seen, when the joint is viewed in profile, either from without or within, and a very well defined ovoid projection from the popliteal space is observed (*fig. 3*). Its centre is on a level with the up-

joint of an old woman who died of apoplexy, we think must have been a case of the chronic disease we are now describing.

* The case mentioned by Morgagni in which he saw twenty-five of these bodies in the left knee-

Fig. 2.



Left knee-joint, front view.

The prominent swelling on the left, A, is from the enlarged head of the tibia; that on the right, B, is the soft globular swelling resulting from the effusion into the synovial membrane.

Fig. 3.



Left knee-joint, side view, showing the enlarged bursa in the popliteal space.

per and projecting margin of the inner condyle of the tibia: it leans to the inner hamstring muscle. The rest of the popliteal space presents a normal appearance. When the limb is fully extended, and the muscles are allowed to remain in a passive state, the patella may be moved from side to side with much freedom. It appears to float as it were on the surface of an accumulated quantity of synovial fluid. When pressed against the trochlea of the femur, this fluid is moved laterally, and the patella strikes against the femur, and if a lateral movement be now communicated to this bone, a grating of rough surfaces may be perceived. If we grasp the leg and flex it on the thigh, we find we can elicit a peculiar articular crepitus. In this case it is quite audible, and resembles much the noises which electric sparks make when discharged in quick succession from an electrical apparatus. When the limb is much flexed, the swelling of course feels remarkably hard and solid, but when the limb is again brought back to its ordinary state of extension, fluctuation may be felt very evidently in it over its whole surface. The popliteal bursa, however, is felt very tense in the extended position of the joint, as when the patient stands and throws his weight on the limb. If we feel this bursa, and then cause the patient's limb to be flexed, we can follow the fluid, as it were, with our fingers into the articulation. As the patient lies in bed, the limb left in the extended posi-

tion, and the synovial sac as flaccid as possible, moveable bodies may be detected in its interior. Some appear to be adherent, and situated more particularly in the upper portion of the subcrural bursa. When we elevate the leg, and preserve it still in the fully extended position, the patient, without any apprehension of pain, will permit us to press it firmly against the femur, and does not experience the least suffering even if we strike the heel forcibly. (See HIP, ABNORMAL CONDITION OF.)

Both knee-joints in this case are affected with this disease, but the left is more distended by fluid than the right. The inner condyles of the femur and tibia of this limb are thrown somewhat inwards, and form a salient angle in this direction, which, the patient says, is certainly the result of disease, as his limbs were perfectly straight before he was visited by his present illness.

Although his knee-joints are more affected with this chronic disease, his other joints present very evident traces of this afflicting malady. The disease in him followed a rheumatic fever, which was brought on in consequence of his having lain a whole night asleep on a wet road, having fallen unobserved from his cart when in a state of intoxication.

Although this is not the place to speak of treatment, we may be permitted to say that under the influence of rest in bed and a mild mercurial course, followed by a long-continued use of sarsaparilla with large doses of the hydriodate of potass, this man left the hospital, by no means cured, but much improved and tolerably well able to follow his occupation.

He found it necessary, however, after the lapse of three years, to seek re-admission into the hospital, where he now is. The right knee-joint is now enlarged, and in a condition similar to that of the left on his first admission. The latter, on the contrary, has nearly resumed its normal condition; the dropsical effusion of synovia has disappeared; he does not complain of pain in it; but if the joint be accurately examined, the bony irregularities which were noticed on the head of the tibia will be found, as might be expected, still to exist. If we move the patella transversely, an articular crepitus is perceived, plainly shewing that the cartilages have been removed from the patella and corresponding trochlea of the femur. The edges of the trochlea can also be felt through the skin to be elevated into rising crests. The peculiar crackling noise which is elicited when the joint is flexed and extended is infinitely more remarkable in the left knee-joint now, when it is comparatively well, than formerly, when it was much swollen, and when the synovial membrane was in what has been called a dropsical condition.

Anatomical characters.—When we have an opportunity of making an anatomical examination of a knee in which the disease had been fully established, we find the synovial fluid increased in quantity, and but little altered in its sensible qualities. The membrane is thicker than natural, and opaque. Sometimes vascular synovial fimbriæ are formed, and hang into the synovial sac.* We also find moveable cartilaginous bodies in the interior, similar to those noticed in the elbow-joint.† (See ELBOW, ABNORMAL CONDITIONS OF.)

In the line of flexion and extension we observe narrow sulci formed by the removal of the cartilages. On examining the popliteal tumour, we find it to be, what we might have surmised, an enlargement and dropsical condition of the bursa, which naturally exists at the point of decussation of the semi-membranosus tendon with the tendon of the internal head of the gastrocnemius. This bursa communicates normally with the synovial sac of the knee-joint by a very small circular aperture. It is not an uniform ovoid sac, but evidently has semilunar septa irregularly thrown across its interior, making the bursa a small multilocular cavity. When the joint is much distended by synovial fluid, the bursa admits some of this fluid, and takes upon itself the same morbid process which affects the proper synovial membrane of the joint itself. As we examine the disease when it has existed for some time, we find that the cartilage has been removed in grooves, and its place supplied by a porcelainous or ivory deposit. The bones of the knee-joint, however, present appearances characteristic enough: they generally appear to be enlarged. This is obviously the case with the patella: it is broader than natural, excavated, and grooved vertically. All the bones seem enlarged and porous on all those parts of the

articular surfaces which have not been worn by use into porcelainous polished surfaces and sulci.

The cavities of the head of the tibia for the reception of the condyles of the femur are much deepened, and exuberant nodules or vegetations of bone are thrown out around the circumference of this head. When we examine the femur, we find here also bony vegetations, arranged along the lateral margins of the condyles, similar to those which we noticed around the corona of the head of the femur.* The part of this bone called the trochlea, upon which the patella moves, is also grooved vertically, and the trochlea has rising edges to it, or crests, which will be found to correspond to the lateral margins of the patella when this bone is laid upon the trochlea of the femur. The anatomical characters of this disease when it has existed long, will of course be still more strongly marked. However, the dropsical effusion into the synovial sac will be found to be much less as the disease is of longer duration. The joint becomes more and more flexed, the tibia has a tendency to be partially displaced outwards, and the toe is everted: the patella under such circumstances is dislocated on the external condyle, giving us another example of this luxation from disease. In the interior of the joint foreign bodies are found, while the articular and semilunar cartilages are altogether absorbed.

White swelling, or chronic strumous arthritis of the knee.—The knee-joint is more liable to the disease commonly called white swelling than any other articulation. This disease, though utterly insidious in its attack and slow in its progress, nevertheless presents some of the characters of an inflammatory complaint during its whole course. The first symptom generally is reported as a deep-seated dull heavy pain unattended by swelling and not increased by motion, but in children the swelling is often the first symptom noticed. This is followed by pain, which, although it comes only occasionally, is severe, and is referred almost uniformly to the inside of the knee. Some increase of temperature of the affected joint on comparison with the other knee, can be ascertained.

The swelling does not at first encompass the whole joint, but first appears on the anterior and lower part of the knee, occupying in general the two little hollows on the different sides of the ligament which joins the patella to the tibia. This swelling is elastic, and on examination by the finger conveys a sense of softness and fluctuation, as if it contained a fluid, although no fluid to any amount really exists. The skin over the knee becomes pale and shining, as if thinned. The subcutaneous veins dilate and become very evident. The muscles of the leg waste, so that the volume of this portion of the affected extremity is considerably reduced, and the inferior part of the thigh just over the knee suffers a characteristic diminution in the measure of its circumference.

* See Cruveilhier, liv. 9. pl. 6.

† See Morgagni's case, in note above.

* See HIP, ABNORMAL CONDITION OF, fig. 310; also Cruveilhier, liv. 9. pl. 6. fig. 2.

Patients under an incipient attack of white swelling first experience inconvenience in walking from weakness of the joint, a symptom which is more especially troublesome after exercise. But as soon as the pain becomes constant, the patient is no longer able to rest the weight of his body upon the affected limb without a great increase of uneasiness. On this account he is willing to save the limb as much as possible; he touches the ground, therefore, merely with his toes, trusting the support of his body chiefly to the other limb. In walking in this way the knee necessarily becomes bent, and what is thus begun becomes permanent from other causes; so that after a certain period the joint continues permanently in a state of flexion.

Although we occasionally see cases in which the leg remains extended on the thigh, they must be considered rare, for in general the leg is in a more or less forced state of flexion on the thigh, and such is the patient's apprehension of pain he will not on any account extend the leg voluntarily, nor allow it to be extended by others.

The earlier period of the disease is succeeded by a second stage,* in which the patient usually submits to the adoption of active and energetic treatment. The pain now not unfrequently diminishes, but the swelling continues increasing, the ham becomes fully occupied by it, the extremities of the bones appear to enlarge, and become more prominent as the flexion increases. Attacks of inflammation ensue, accompanied by pain starting up and down the limb, by which sleep is interrupted. These attacks are usually succeeded by effusion of fluid into the synovial sac of the joint and cellular interstices around: abscesses form, and some fluctuation may now be discovered in different parts of the swelling. If at this period, which may be called the third or suppurative stage of the disease, the bones be moved laterally, it will be perceived that the ligaments permit an unnatural degree of motion between them, and now, as in other articulations, partial or complete luxation may occur. Such, however, is the breadth of the surfaces of contact of the bones of the knee-joint, that complete luxation seldom happens. The limb at this period is usually found lying powerless on its outer side and in the semiflexed position; and after some time a partial displacement of the leg outwards on the femur occurs: under other circumstances a partial or complete luxation backwards happens. Although the disease, arrived at this stage, seldom terminates favourably, still instances do occur of unexpected improvement of the general health, of the resolution of the swelling, of the absorption of matter, and of one of the forms of anchylosis taking place. But usually the matter formed in and around the joint goes on accumulating,

the tension of the knee-joint increases, and now in most cases an accompanying œdema of the foot is observed, a symptom than which there can be none more unfavourable. The nocturnal startings of the limb, disturbing the patient's rest, become more painful and urgent, and abscesses communicating with the interior of the articulation open externally by one or more orifices, and give exit to a quantity of matter, which rarely has the quality of laudable pus; on the contrary, it is for the most part a sero-purulent liquid, of a yellowish green colour, like whey, in which curdy matters are found floating. It is remarkable that little diminution in the size of the swelling follows the escape of this matter.

We have stated that the pus is seldom laudable. On some few occasions, however, its consistence may be that of good pus; but even then it soon degenerates into a thin fetid sanies of bad quality. The openings giving exit to the discharge sometimes close very speedily, and new collections form in different parts of the tumour. This, however, is unfortunately rare, for generally the openings degenerate into fistulæ. A probe introduced into one of these penetrates, if the route be not long and circuitous, into the interior of the joint, and discovers the internal parts to be carious and disorganised; and if the bones of the articulation be now pressed together, a crepitation, arising from the friction of the carious and ulcerated surfaces, is perceived, furnishing unequivocal evidence of the last stage of disorganization of all the structures of the articulation. This is the most common course of the disease, but in some cases there are varieties to be observed. For example, the suppuration of the soft parts and of the cartilages, and even caries of the bones, may occasionally precede the displacement of the bones; and all the parts of the articulation may be destroyed without the occurrence of any displacement; but if, in this case, we move the bones of the articulation in opposite directions, we easily ascertain the relaxation of the uniting ligaments, and that many of the conditions necessary to the displacement exist, although, from some cause not easily explained, it has not occurred.

As to our prognosis we should remember that the age and constitution of the patient have considerable influence on the ulterior progress of the disease, and our knowledge of this must control our anticipations as to the result to be expected, *ceteris paribus*. The disease in the truly strumous subject is very rebellious, and has a disposition to terminate in suppuration which it is difficult to baffle. In young subjects it is in general more acute, or the succession of the different orders of symptoms is more rapid; but in young persons there is much more hope of cure than in the old and exhausted. We agree with Mr. Russell in opinion that it is in the cases of infants that the formation of anchylosis may be expected as the termination of a case of white swelling, though even with these true bony anchylosis must be considered as a very rare occurrence.

In the beginning the disease has but little

* Mr. Lloyd divides scrofulous white swellings into three stages; the first being that in which the affection is confined to the bone; the second that in which the external parts become thickened and swelled; and the third what he denominates the sub-acute stage.—*Lloyd on scrofula*.

influence on the constitution: it is not until it arrives at the second or third stage that it produces any very remarkable alteration in the health; but the pain about the commencement of the third stage is sometimes so violent as to deprive the patient of sleep and appetite. When the part is distended by abscesses, the pain is increased, but when these open or are opened, although temporary relief follows, slow fever supervenes, the discharge becomes sanious and fœtid, and nocturnal sweats and colliquative diarrhœa shew themselves, together or alternately.

Anatomical characters of the chronic strumous arthritis of the knee.—The anatomical examination of a limb which has been amputated on account of a white swelling, or after the death of the patient, demonstrates different alterations which disease produces in the structure of the soft parts surrounding the diseased articulation, and in that of the bones, synovial membranes, and cartilages which compose it. The skin and subcutaneous cellular tissue are not greatly altered from their natural condition, except that the latter is usually infiltrated with a gelatinous matter, as is also the cellular structure, which lies deeper, viz. that which unites the femur with the inferior part of the cruræus muscle, as well as that behind the ligament of the patella, and that also which occupies the intervals between the condyles of the femur behind the crucial ligaments. These parts are equally infiltrated by a gelatinous fluid, of more or less density. The whole of this cellular structure presents the appearance of a soft, spongy, homogeneous mass. The ligaments which secure the junction of the bones of the joint seem themselves involved in this morbid change of the surrounding cellular structure, so that the tumefied ligaments and other structures seem to be confounded together, and to present an appearance almost like a fibro-cartilaginous mass. "Thus have we seen," says Boyer,* "the fatty cellular tissue which is placed behind the ligamentum patellæ, so dense and thickened that it formed but one mass in which ligament and cellular tissue seem confounded together." All these appearances are present even before suppuration has occurred. If the disease had existed for any length of time so as to have arrived at the period of suppuration, we find, among the structures thus altered, that symptomatic chronic abscesses have been formed. One extremity of them we observe usually communicating with the knee-joint, while the other reaches the surface, and presents one or more openings which had become fistulous. These abscesses and fistulous canals we find always lined by a false membrane. The muscles which surround the diseased joint are pale and wasted, and the cellular tissue which is found in their thickness is ordinarily more or less infiltrated with the peculiar glairy matter above alluded to. The tendons of the flexor muscles are generally retracted and preserve their normal appearance. The nerves we have had occasion to observe to

be thicker than natural. These are the alterations which are noticed in the soft parts, as we pursue an anatomical examination down to the bones and ultimate structures of the joint itself. It is probable, however, that these changes will not be found to have occurred unless the disease has existed for some time previously in the centre of the bones themselves. Sir B. Brodie, Lloyd, and others are of opinion that this strumous disease begins in the centre of the heads of the bones of the knee-joint, in the cancellous structure;† and Rust has satisfied himself that the membranous tissue which lines the cancellous structure of the bones is the seat of the first morbid action. They have found the interior of the spongy tissue of the bones more vascular than natural, and with much apparent justice conceive them to be inflamed. These changes, then, in the interior of the bone they believe to constitute the anatomical characters of the first period of the disease, and that when the parts external to the joint become swelled and infiltrated by the gelatinous matter above alluded to, the second period is fully established.

When the second period has commenced, and the soft parts are excited into irritation, if opportunities occur of examining the interior of the bones, they will be found to be softened and easily penetrated by a knife. The synovial membrane contains an unusual quantity of fluid, and the bones will undergo further changes as the disease grows worse. These structures become still softer, their cancellous structure is found filled with a yellowish cheese-like matter. The bones, which in the first period were in an hyperæmic condition, are now found to be less vascular, and portions even become necrosed, so that it is not uncommon in advanced cases to find in the interior of the joint portions of dead bone. In these cases the spongy portion of the bones seems so altered in structure as to appear half dissolved, and to contain a sanious and fœtid matter in its substance. The periosteum investing the bones in the neighbourhood of the diseased knee is very much thickened and easily detached. It is surprising to what an extent this strumous disease may have advanced in the bones and in the external parts around the joints while the synovial structures and cartilages remain but partially engaged. The writer has lately been compelled to amputate a thigh for this disease of the knee in consequence of the constitutional symptoms which it excited in the system. In this case he discovered that while the bones and soft parts externally were far advanced in the second stage of the disease, the synovial membrane and cartilages were perfectly natural. When, however, the disease has advanced far, and the fistulous orifices are found to communicate with the interior of the joint, we find that the synovial membrane presents appearances of morbid action having gone on in it, and when the puriform fluid contained in it is wiped away, that the surface of this mem-

* *Maladici Chirurgicalcs.*

† Russel entirely differs from them.

brane, instead of being white, is red and villous, and much like mucous membrane in a high state of inflammation. We can frequently ascertain that this membrane has superadded to it layers of newly deposited lymph, which have become highly organized. Mr. Russell says, that in his dissections of white swelling of the knee, he has found the inside of the synovial membrane covered with a layer of a soft substance, of a pale yellowish colour, and semi-transparent; that this substance was nearly one-eighth of an inch in thickness, softer in its inner concave surface, and firmer on the outer convex part, where it adhered to the inside of the synovial capsule of the joint with a considerable degree of firmness. In many places he observed on it a very beautiful plexus of vessels; and at the interstices between the surface of the femur and tibia, he states that he generally found an appendage full of blood-vessels which had insinuated itself to the distance of nearly half an inch. It very frequently happens that the cartilages and crucial ligaments are completely concealed from our view by a membrane, in some places of one-quarter or even one-half of an inch in thickness, presenting a loose cellular structure, highly vascular, occupying the intervals between the condyles, and hanging into the interior of the joint; and we have usually found this newly-formed structure to be superadded to the original synovial membrane, and to establish adhesions between the bones of the articulation, and we find bands of organized lymph stretching from the femur to the tibia. When this condition of the synovial membrane existed, we have usually found the cartilages remaining; but in other cases the synovial membrane itself has been found to be but little altered; and yet the cartilages have been removed partially or completely, the porous substance of the bone having been found exposed, or covered by recent deposits of soft pulsatious lymph.

Such are the organic changes which usually produce white swellings. These changes present numerous varieties, but it is sufficient to notice the principal ones, and to observe that there are scarcely two patients in whom they are perfectly alike.

Sir Benjamin Brodie, in his work on the joints, has remarked that when acute inflammation attacks the shaft of a cylindrical bone and the periosteum covering it, the disease is usually limited by the epiphysis, so that, notwithstanding the extensive abscesses and exfoliations which frequently ensue, the neighbouring joints are not affected by it. Although we have seen numerous specimens proving the general truth of this observation, yet on the other hand we have witnessed exceptions to it: indeed Sir Benjamin Brodie has further observed that a few instances occur in which acute inflammation attacks the epiphysis itself, terminating also in exfoliations, &c. more or less extensive.

In very young subjects we occasionally see examples of diffuse inflammation which has engaged the periosteum of the femur or tibia,

and the epiphysis of one or both of these bones, the inflammation extending to the knee-joint. These cases are usually rapid in their course, and too frequently terminate fatally, the ordinary symptoms of diffuse inflammation being exhibited in their progress. In the *post-mortem* investigations of these cases we find that the periosteum is extensively separated from the bones by purulent matter; that the epiphyses, detached from the shafts of their respective bones, are loose in the interior of the joint; and that the synovial membrane is distended by matter. In the serous and mucous membranes of the chest also we generally find evidences of acute inflammation having existed. The origin of these violent attacks is sometimes referred to a fall or other accidental injury, sometimes to a cold which commenced with a rigour. We have sometimes known this severe form of disease to succeed immediately to attacks of small-pox, and also of scarlatina. Dr. McDowel, in the third and fourth volumes of the Dublin Journal, has described this disease under the heads Periostitis and Synovitis; and the museum of the Richmond hospital contains many specimens of these unhappy results of diffuse inflammation.

Cases of diffuse inflammation are not the only ones in which we have seen matter, formed beneath the periosteum of the tibia, passing the epiphysis and getting into the cavity of the knee-joint; we have known instances of such occurrences in cases of acute necrosis of the tibia, in which the disease in its commencement had been exclusively confined to the one bone. Mr. Smyly, one of the surgeons to the Meath Hospital, presented to the museum of the College of Surgeons in Dublin, a specimen, the result of an acute necrosis of the tibia. The following is the history of this case, which he kindly communicated to the writer. James Jarman, æt. 9, was admitted into the Meath Hospital the 5th October, 1837. Sixteen days previously he had suffered a very severe contusion on the front of the left tibia by the accidental falling of an iron bar; there was, however, no breach of the skin, and the boy was able to walk about as usual for two days, when acute inflammation attacked the contused part, and daily increased for a fortnight. On the 4th of October he applied for relief at the dispensary. At this time a large and tense swelling extended from above the knee to the instep; a fluctuation was evident the whole way down the front of the leg. An incision was made into this swelling, which gave exit to a considerable quantity of thin discoloured pus, and the tibia was found quite denuded of periosteum. Great relief followed the opening of the abscess, but on the 10th of October there was much tumefaction observable at each side of the patella, and redness, as if the joint were in a state of suppuration. The boy suffered much from irritative fever and occasional diarrhœa: his pulse became very frequent, and his tongue red and dry. The operation of amputation at the lower third of the thigh was now the only resource, and it was accordingly performed.

On examination, the knee-joint was found distended with purulent matter. The synovial membrane was covered in patches by a vascular pulpy membrane; the cartilages were removed in several places. An opening was found in the inner condyle of the tibia, which perforated the spongy substance of this bone, and thus established a communication between the interior of the knee-joint and a large abscess as it were which had formed under the periosteum of the tibia. The shaft of the tibia was detached from the epiphysis and the periosteum, and was surrounded by matter. The periosteum was thickened, vascular, rough, and gritty from minute particles of bone deposited in it. The ankle-joint was free.—The boy recovered his health.

Acute arthritis of the knee may be combined with acute osteitis of the bones of this articulation, and without any discoverable communication between the cavity of the articulation and the interior of the bones. On the 21st March, 1840, Mr. Smith presented to the Pathological Society the following case. Susan Christie, æt. 56, an inmate of the House of Industry, and for a long period disabled by the affection of the knee-joints which we have described as *chronic rheumatic arthritis*, was removed to the Whitworth Hospital, where she died of a most acute attack of inflammation of the right knee-joint. On the post-mortem examination old adhesions were observed in the chest. The right knee-joint presented the external appearances noticed as belonging to the chronic rheumatic arthritis in a somewhat advanced stage; moreover, it was greatly swollen, and when the synovial membrane was opened purulent matter escaped; organizable lymph lined this membrane and the cartilages generally. These structures, however, were in some places removed altogether, their place being supplied by a porcelainous deposit, grooved in the line of flexion and extension. From the condyles of the tibia the cartilage was raised up from the bone, apparently stretched out, and converted into a thin, flexible, and soft yellow membrane, difficult to be distinguished, except by its situation, from a deposit of lymph the produce of recent inflammation.

But the interior of the head of the tibia, its cancellated structure, the medullary membrane lining these cancelli, and the membrane of the medullary canal itself, all presented evidences of their having been the seat of acute inflammation. The purulent matter was diffused through the cancelli of the tibia, from the knee-joint, for one-third of its extent, but was nowhere collected into any isolated cavity or abscess, nor was there any communication between the purulent matter which occupied the synovial sac of the knee-joint, and that which pervaded the medullary structure and cancellated tissue of the tibia. In a word, the anatomical characters of a true acute osteitis of the bones entering into the formation of the knee-joint coexisted in an advanced stage with those of acute inflammation of all the other structures of the articulation.

The osteitis of the lower extremity of the

femur or upper portion of the tibia sometimes presents more of a chronic character. The inflammation of the interior of the bone may proceed to cause the death of a portion, which is converted into a sequestrum, the presence of which becomes a source of irritation and inflammation of the surrounding bone and the formation of an abscess. The following case came under the writer's observation while under the care of his colleague Dr. Hutton in the Richmond Hospital. Thomas Conolly, æt. 43, was admitted in May, 1838, for a disease in the lower extremity of the left femur, of many years' duration. He had long suffered from a deep boring pain in the interior of the bone. At length an abscess formed, matter made its way to the surface and was evacuated, and two small fistulous openings remained, through which a probe could be passed deep into the interior of the enlarged femur. The man was greatly exhausted by the quantity of the discharge, by confinement, and hectic fever, and amputation was performed in the femur just above the diseased part. The femur was found much enlarged near the knee-joint, and covered by wasted muscles, which had undergone a considerable degree of fatty degeneration. When these were removed, the periosteum was found thickened. A vertical cut from before backwards was made through the femur, knee-joint, and tibia, by which section the cavity of an abscess capable of containing a hen's egg was exposed, which was placed transversely between the condyles, having two open fistulous orifices, one on the inner, the other on the external condyle. This abscess was lined by a thick membrane which by a fine injection proved to have been highly vascular; villous flocculi hung from it into the interior of the cavity; a dark-looking sequestrum of a cylindrical form, an inch and a half long and half an inch thick, occupied the superior half of the cavity; one end of the sequestrum was fixed into the bony tissue of the femur, as if it were on its way to present itself at the outer fistulous orifice; the remainder of it lay diagonally across the cavity of the abscess, the front wall of which was principally constituted of soft parts, the femur having been absorbed in this situation. In the vicinity of the abscess, particularly above it, the bone was greatly thickened, its cancellated structure solidified, and rendered apparently as dense as ivory. The interior of the joint was quite unconnected with the cavity of the abscess, but the joint itself presented evidence of its having been at one time the seat of some form of inflammatory action, because the shape of the condyles of the femur was somewhat altered, and at the same time the tibia was partially displaced backwards, and ligamentous ankylosis had taken place. The cartilage had been removed somewhat from the ends of the bones, and its place supplied in patches by a membrane like periosteum, and in other situations by a dense polished enamel. It was to be inferred from the appearances which the bones and contiguous structures presented, that the knee-joint had latterly been quite useless.

Abscess may, however, form in the interior of the heads of the tibia or lower extremity of the femur without being preceded by the death of any portion of the bone, as is proved by a specimen in the museum of the Richmond Hospital. A child, aged about twelve, had long suffered from chronic disease of the upper portion of the tibia. A chronic symptomatic abscess pointed and opened spontaneously in the popliteal space, and here a fistulous opening remained discharging a quantity of thin sanious pus. While under treatment for this chronic disease, a sudden attack of acute arthritis set in, which threatened the patient's life, and amputation was immediately performed. Upon examination of the knee-joint and of the interior of the bones, which were exposed by a vertical section made from before backwards, an abscess was discovered in the centre of the head of the tibia, capable of containing a walnut. This communicated with the popliteal abscess, which had long had a fistulous opening in the ham; but the abscess in the interior of the tibia was now found to have another opening into the cavity of the knee-joint, which had all the appearance of having been quite recent. The matter of the abscess of the tibia having suddenly made its way into the cavity of the knee-joint was the immediate exciting cause of the acute arthritis genu, evidences of which were seen in a layer of lymph which invested the synovial membrane and the cartilages. The patient ultimately recovered.

When the chronic form of necrosis affects the tibia and the epiphysis is included in the disease, the knee-joint sometimes remains but little altered, but in other cases remarkable changes in its form take place. The leg is sometimes fully extended, and is even in advance of the natural line, but it is more generally flexed on the femur, and the tibia is at the same time somewhat curved into the form of an arch, the concavity looking forwards. We have frequently known displacement of the superior head of the tibia, where it enters into the formation of the knee-joint, to take place *backwards* towards the popliteal space. This displacement is usually incomplete. We have examined many living examples of this deformity, and have had a few opportunities of investigating the anatomical changes the joint has been subjected to.

Many circumstances tend to influence the direction in which the luxation may take place. The position in which the limb is preserved during the attack of inflammation of the tibia is one of the most influential. As the limb is generally flexed during the first stage of the disease, the partial luxation backwards will be the one most likely to occur. In these cases, whether the femur or tibia close to the knee be the seat of the necrosis, more or less of effusion takes place into the synovial sac of the knee-joint; all the ligaments of the joint become softened and relaxed; and the action of the hamstring muscles overcomes the resistance of any remaining structures, and the tibia is displaced partially backwards.

Mr. West, surgeon to the Longford Infirmary, sent to the writer of this article the leg and knee-joint of a man who had long contended against the consequences of a chronic necrosis of the tibia. There were from time to time exfoliations of bone, and a continual discharge of a thin sanious matter which so reduced the strength of the patient as to render amputation necessary. A cast of the limb, taken by Mr. Smith, and the bone are preserved in the museum of the Richmond Hospital, (*figs.* 4 and 5,) from which it will be observed that the

Fig. 4.



Displacement of the tibia backwards from necrosis.

displacement of the head of the tibia was partially backwards. This bone was drawn also somewhat upwards, passing inferiorly so far round the condyles of the femur that the articular surfaces were almost abandoned. This is the simplest form of displacement of the tibia at the knee-joint from disease which we have noticed as the result of a chronic process of necrosis. We have seen some instances of necrosis in which the whole leg and foot were greatly rotated outwards on the femur, so that the inner ankle was placed directly forwards, and the outer malleolus directly backwards. In these cases the patella is completely dislocated on the outer condyle of the femur (*fig. 6*), because the tubercle of the tibia, in its movement of rotation outwards, carries with it the ligamentum

Fig. 5.



Same as fig. 4, the soft parts removed.
1, right femur displaced forwards; 2, tibia backwards; 3, rough scabrous surface of tibia; 4, line of junction of the epiphysis.

Fig. 6.



Partial displacement of femur inwards; tibia and patella outwards.

Fig. 7.



Left knee-joint. Displacement of femur inwards and tibia outwards.

patellæ, and consequently gradually draws this bone outwards completely over the outer edge of the trochlea of the femur. We have seen at the Richmond Hospital two similar cases of this very curious result of necrosis of the tibia. In these examples the knee-joint had participated in the inflammation of the contiguous structure, and great deformity of the whole limb was the consequence (fig. 7). The subject of one of these cases (Christopher Tarrer, æt. 30) died of erysipelas, which was idiopathic, and had no connexion with the deformity. The knee joint was examined, and the patella was found dislocated outwards, and ankylosed to the outer surface of the external condyle of the femur (fig. 8.) The superior extremity of the tibia was partially displaced backwards, and was greatly deformed and enlarged, particularly the outer condyle of this bone, the anterior half of which was deeply excavated to receive the condyle of the femur; the posterior half of this condyle was free and had no bone in contact with it; but this portion of the tibia and the head of the fibula were so much rotated or twisted outwards and backwards as to form a very conspicuous elevation in the lower part of the popliteal space. The fibula was placed directly behind the tibia. The lateral ligament did not exist. The ligamentum patellæ was great

Fig. 8.



Femur displaced inwards. Patella ankylosed.

Fig. 9.



Displacement backwards of the superior extremity of the lower fragment.

elongated and was directed backwards. The crucial ligaments were also elongated, and instead of crossing each other were untwisted as it were and lay side by side. The cartilages were altogether removed, and when the femur was forcibly separated from the tibia, there were corresponding elevations and depressions which marked the several points of contact between the bones, in which a species of ankylosis had occurred. The body of the tibia was greatly enlarged and hypertrophied, and round perforations existed in its head, from which sequestra had been discharged.

II. ABNORMAL CONDITIONS OF THE KNEE-JOINT RESULTING FROM ACCIDENT.—Fractures and dislocations are the principal accidents to which the bones of the knee-joint are liable. The muscular and tendinous fibres common to the rectus, cruræus, and vasti are occasionally torn from the patella, and the ligament of this bone is also sometimes ruptured. The proper ligaments, too, and other structures of the knee-joint, suffer from sudden injuries, which we must here advert to as briefly as we can.

Fractures of the shaft of the femur near to the knee-joint may be *transverse* or *oblique*, or one or both of the condyles may be broken off from this joint.

1. When a *transverse* fracture is situate immediately above the condyles of the femur,

it is the inferior fragment which is displaced, its superior extremity being directed backwards towards the popliteal space (see fig. 9); the anterior part of the condyles and trochlea have their aspect directed upwards, and form a swelling above the patella, giving to the joint a singular appearance. This direction backwards of the superior extremity of the lower fragment is the result of the action of the gastrocnemii, the plantaris, and popliteus muscles.

2. *Oblique* fractures of the lower extremity of the femur near the knee-joint are more serious and embarrassing than transverse fractures, not only on account of the immediate danger of the penetration of the skin by the upper fragment, and of the accident being thus rendered compound, but also on account of the great difficulty which is always experienced in maintaining the bones in apposition during the treatment of the case.

Sir A. Cooper says the appearances presented by the usual oblique fracture of the lower extremity of the femur are the following:—"The lower and broken extremity of the shaft of the femur projects, and forms a sharp point, which pierces the rectus muscle, just above the patella, threatens to tear the skin, and sometimes

does so, whilst the patella, tibia, and condyles of the femur sink towards the ham, and are drawn upwards behind the broken extremity of the shaft of the os femoris, which is thrown forwards." He adds that falls from a great height on the feet or knees have been the usual sources of this accident.* In most of the cases already met with, and described, of oblique fracture of the lower extremity of the shaft of the femur, the direction of the obliquity was from above downwards, and from behind forwards, and the pointed extremity of the broken bone was consequently directed downwards and forwards; but the pointed extremity has been seen towards the popliteal space. In Sir Charles Bell's lectures on the thigh-bone which he has published, there is an engraving of a very remarkable case, which appears to us to have been an oblique fracture of the femur near the knee-joint, in which the pointed extremity of the superior fragment presented towards the popliteal space.† About twenty years after the bone had been fractured, the patient, in jumping down from a chair, felt something snap, and very soon after a pulsating tumour formed, which was discovered to be a popliteal aneurism. The direction of the course of an oblique fracture may be various; that downwards and outwards is the least likely to be followed by dangerous consequences.

3. *Oblique fractures of the os femoris into the knee-joint*, detaching laterally the condyles, are not very uncommon accidents; they may be known by the great and sudden swelling of the joint by which they are accompanied, by the great degree of lateral motion which can be communicated to the limb, by the crepitus which can be felt, and by the obvious deformity with which they are attended.

It is sometimes the inner condyle, and sometimes the outer, which is detached from the shaft; and in these cases the cavity of the synovial membrane of the knee-joint is always opened into by the fracture. The following case presents a good example of an oblique simple fracture, which detached the outer condyle of the femur from the shaft of this bone.

Ganet Doyle, æt. 45, was admitted into the Richmond Hospital under the care of Dr. Hutton on the 27th March, 1839. He stated that about ten minutes before his admission he was standing on a double ladder about four feet from the ground; the ladder gave way under him suddenly, and he fell with it, the right limb having been engaged between two of the steps. During the fall he was sensible of being bruised below the knee by the steps, and of something "cringing" in the lower part of the thigh; immediately after the fall he found the limb quite powerless and was unable to put it under him. Tumefaction of the knee and lower part of the thigh took place instantly and to a great extent. On examination the outer condyle was found to move and grate against the inner through the centre of the joint; no breach of continuity

could be detected between the inner condyle and shaft of the bone. The femur, as the patient endeavoured to stand, was directed downwards and inwards, and the tibia downwards and outwards, so that the junction of these two bones at the knee-joint formed an obtuse angle salient internally. There was considerable enlargement of the femur in the situation of the fracture for several inches above the knee-joint, and on measurement there was shortening of the injured limb for half an inch. By making extension, and by pressing the condyles towards each other, the natural form of the limb was restored. No fever nor constitutional disturbance arose, and at the end of the fifth week passive motion was recommended. When the man left the hospital the external appearance of the joint was very nearly natural, except that the patella had been elevated at its outer edge obliquely by the callus which had united the fracture. When this bone was moved across the trochlea of the femur, a roughness was perceived to exist on the corresponding surface, and a sensation of something grating was conveyed to the fingers of the examiner. There was some shortening of the limb, which also still remained more inclined inwards towards the knee-joint than natural, and the movement of flexion was limited.

Sometimes an oblique fracture occurs through the lower part of the femur into the joint, which detaches the inner condyle. The prognosis in these cases of simple oblique fractures of the inner and of the outer condyle of the femur, so far as life is concerned, does not appear, from what we have seen of them, unfavourable; but we have known some examples of what may be designated as T fractures of the lower extremity of the femur—that is to say, a transverse fracture of the lower extremity of this bone, combined with a vertical split from the transverse fracture down through the trochlea into the outer condyloid fossa of the femur, in which the prognosis is generally unfavourable, even when the fracture is uncombined with any wound in the integuments. Mr. Chelius, of Heidelberg, shewed Mr. Smith and the writer, in August 1837, two specimens of T fracture of the lower extremity of the femur. In the first case, the exact nature of the accident was unknown to Mr. Chelius. Violent inflammation set in in the knee-joint and the whole limb, causing the death of the patient. In the second case he recognized the nature of the injury early, and amputation in the thigh saved the patient. In such cases, to decide at once whether amputation shall be immediately resorted to or not, becomes a very critical and often a very urgent question. If the first opportunity be lost, the constitutional symptoms attendant on the local inflammation set in so speedily, and run to such a height, that a second seldom offers; the two following examples, however, should caution us against deciding hastily on immediate amputation in cases of simple fracture, in which the cavity of the knee-joint is implicated, because, although in the first case the femur was broken into a great number of fragments, the inflammation

* Sir A. Cooper on Dislocations, 8th edition, plate xv.

† Fig. 3, plate iv.

which followed was inconsiderable, and in the second an opportunity for "secondary amputation" was afforded even after acute inflammation of the joint had taken place.

A healthy labourer, about 30 years of age, was admitted into Jervis-street Hospital about eight years ago, under the care of the late Mr. Wallace, for a comminuted, but still a simple fracture of the lower extremity of the femur, where it entered into the formation of the knee-joint. The accident was attended with enormous effusion, and there was a degree of mobility of the limb in the seat of the comminuted fracture truly astonishing; but little inflammation followed, and under the simplest treatment the man ultimately recovered with a stiff knee-joint. The second case was that of a boy aged 13 years, who had received a simple fracture of the lowest part of the shaft of the femur. The condyles of this bone were detached at their normal line of junction with the shaft, and where they are covered with synovial membrane; the posterior and anterior crucial ligaments were separated from the femur, and had carried with them small portions of this bone. The result of the operation is not recorded, but the specimen, preserved in our museum at the Richmond School of Medicine, exhibits, besides the injury the bones received, traces of the very acute inflammation which followed, particularly on the surface of the synovial membrane, which is covered with lymph. The periosteum of the femur in the vicinity of the fracture is much thickened and detached all round from the femur.

Among the valuable preparations presented by Mr. Kirby to the College of Surgeons in Dublin is a specimen of one of these transverse fractures of the lower extremity of the femur, which was combined with a vertical split of the bone down through the trochlea and outer condyloid fossa. Although the fracture was a simple one, it was followed by enormous effusion, succeeded by acute inflammation of the structures of the joint; and Mr. Kirby informs me that amputation was successfully resorted to. The synovial membrane was much thickened, and evidences of acute inflammation of the structures of the knee-joint are still to be seen in the preparation.

Fractures of the tibia close to the knee-joint may be *transverse*, or through the line of junction of the epiphysis with the rest of the tibia in the young subject, or in the situation and direction of this line in the adult. In this case the broad surfaces of the broken tibia nearly maintain their relations with each other. If there be any displacement, it will be that of the superior fragment, which will be drawn backwards towards the popliteal space, as the inner hamstring muscles will draw the bone in this direction.

Oblique fractures of the upper extremity of the tibia which run into the knee-joint are accompanied with symptoms not very dissimilar from those belonging to oblique fractures of the internal condyle of the femur, except the situation of the pain, and the crepitus which can be elicited on motion being communicated

to the broken portion of bone. There is the same sudden effusion into the knee-joint, and a very great degree of lateral motion is allowed, which is a movement the knee-joint does not normally possess.

We learn from Blandin that Beclard had very frequently observed elderly females to be the subjects of fractures of the upper portion of the tibia, produced by the contraction of the flexor muscles of the leg, which muscles also he observed uniformly pulled the superior fragment into the hollow of the ham. The explanation of the fracture occurring from such a cause must be referred to the atrophy which the head of the tibia undergoes in elderly people, in consequence of which the tibia becomes thin in its shell, and the interior osseous structure reduced to a thin reticular tissue, which in the dead subject we notice yield to the slightest pressure of the fingers. We have known this atrophy of the tibia to exist in adults as well as in old subjects, and when present, it of course renders the bone liable to be broken by slight causes. Moreover, we have usually found the species of reunion of the broken bone which can be effected under such circumstances to have been very imperfect; the patient after a long period endeavours to move about with the assistance of crutches; and effusion takes place into the knee-joint, the functions of which become greatly impaired for the rest of life.

Fracture of the patella.—This fracture occurs almost always in the transverse direction; it is rarely oblique, and still more rarely longitudinal; sometimes a fracture divides this bone into three or four pieces, or is what is called comminuted. The longitudinal fracture is rare, and this and the comminuted are generally the result of direct violence; and, although the transverse fracture may depend on a similar cause, still the violent contraction of the extensor muscles of the leg is the most frequent source of this accident. When a fall occurs directly on the front of the knee, this joint being at the moment in a state of semiflexion, if a fracture take place it will no doubt be considered as the result of the fall directly on the bone, by which it is broken; certainly muscular action may lend its assistance to the external violence even in producing the fracture, and *after* this has occurred, to cause the separation of the fragments.

This fracture cannot so readily be effected by muscular action when the limb is in a state of complete extension as when it is in a commencing state of flexion, because in complete extension the muscles act in the direction of the long axis of the bone; but in flexion at the knee to the first degree the patella is in a particular condition, which is favourable to the production of fracture; it only applies itself to the condyles of the femur by its middle point. The base and summit of this bone are unsupported; the extensor muscles of the leg on one side, and the tendon or ligament of the patella on the other, are, in this position of the joint, oblique with relation to the long axis of the patella; the muscles then bend the

patella backwards, and it breaks transversely, —according to Boyer and Malgaigne, “ par la même mécanique que nous cassons un bâton placé en travers le genou ; en agissant avec les deux mains sur ses deux extrémités.” In transverse, oblique, and comminuted fractures of the patella there is almost always more or less separation of the fragments, and the signs of the accident are easily recognized. In some cases of fracture of the patella the fibrous and aponeurotic layer which immediately invests it anteriorly is broken ; in other cases, particularly those from external violence, the fibrous layer remains entire ; it is in these latter cases, as the fragments are preserved in complete apposition, that bony consolidation may be expected. The following case, which it lately fell to our lot to attend in the Richmond Hospital, appears to possess some interest as a fact, tending to throw light on some of the disputed questions here adverted to relative to this accident.

A man, æt. 18, on the evening of 16th February, 1839, fell from the height of twenty feet to the ground, and fractured two of the cervical vertebræ, of which injury and its consequences on the spinal marrow he died in forty hours. His lower limbs were paralyzed. It was noticed that the integuments over the patella were much bruised, and that there was some effusion into the cavity of the knee-joint. On the post-mortem investigation, the patella was found traversed by a perfect fracture of the bone ; but the fragments were not separated from each other. On examining the patella anteriorly, its fibrous and aponeurotic coverings were in a perfect condition. Upon looking at the posterior articular surface of the patella, the *cartilage* was broken corresponding to the line of the transverse fracture of the patella, but only half-way across the transverse extent of the fracture was entirely through the bone. We regarded this accident to the patella to be the result of direct violence, complete paralysis of the lower limb having occurred as the immediate effect of the lesion of the spinal marrow ; the usual source of displacement arising from muscular contraction was here destroyed. When we bear in mind the complete apposition existing in the fragments of this patella, we cannot for our parts question but that if life had been preserved, complete consolidation should have taken place. Although but few doubts are now entertained that the transverse fracture of the patella is in general a real rupture of the bone transversely, owing to the powerful action of muscles, it may not perhaps be amiss to adduce as an example of it, the following case of a patient who many years ago was under the care of the late Mr. Todd in the Richmond Hospital. A remarkably muscular man, a lamp-lighter in this city (Dublin), was on the top of his ladder when it slipped from the lamp-post, and he fell with it to the ground, making at the moment vain but violent efforts to save himself. The whole muscular system, according to his own account, seemed to be suddenly thrown into energetic and involuntary effort, to resist

the fall ; when he was lifted up, he was unable to stand. Mr. Todd, having examined him, found both olecrana and both patellæ broken transversely. We have often heard the above-named professor mention this case in his lectures, and the treatment of the accident was also witnessed by Dr. Hutton.

It was for a long time greatly doubted that bony union of the broken pieces of the patella could occur, but it is now fully proved that the fractured patella does not want really any of the conditions necessary to the reunion and consolidation of broken bones. The spongy structure of the patella and the great number of bloodvessels entering into its structure ought to favour the inflammatory turgescence (Boyer) which seems necessary in the early stage of ossification, and would do so but that the continual contraction of the muscles feebly resisted by the bandages suggested by surgery, keeps the fragments separated from each other, and hence union has been so rare in those cases that the possibility of it under any circumstances was for a long time questioned. Pibrac, one of the most distinguished members of the ancient Academy of Surgery of France, defied all the surgeons of Europe to shew a specimen of the fracture of the patella united solidly by bone, and no example was at that time produced. Among many cases published since that time in various works, proving the possibility of bony consolidation of the broken patella, we adduce the following.*

Louis Manilla, aged 36 years, of a most vigorous constitution, being a veteran soldier in the Salpêtrière, on the 7th of April, 1797, was thrown down by a comrade, with whom he was struggling. One of his knees supported all the effect of this fall, and the patient suffered in this part a sensation of crackling and laceration and a pain which was extremely severe. He could not rise without assistance, and M. Lallement recognised a transverse fracture of the patella. The interval between the two fragments was very perceptible, but approximation of the two pieces was easily accomplished when the leg was extended. The patient having been brought to the infirmary, the fracture was reduced by M. Lallement, and retained by means of the apparatus of Desault. This bandage was kept on for two months, at the end of which time the fracture appeared to be united. During one year the patient walked with the assistance of a cane and then returned to his duty. The movements of the knee were nearly perfect, with the exception of flexion of the leg, which was still a little confined on the 18th Aug. 1816. Manilla died of an attack of apoplexy, and M. Lallement having examined the knee became satisfied that the two fragments of the patella were solidly united. This bone being submitted to ebullition for ten hours was deprived of the articular cartilage which covered its posterior surface, and of the tendinous and aponeurotic fibres which enveloped it. It was now evident that the total height of the patella

* See Boyer's Surgery, vol. iii. p. 353. Ed. Paris, 1818.

which had been broken exceeded by about six times the same diameter of that of the opposite side. The fracture did not represent a straight transverse line, but was somewhat undulated. At the two extremities of the line of junction of the fracture it was quite evident that the union of the broken bone was immediate, and by the intervention of a true bony callus. Lallement presented Boyer with the patella thus solidly united, and he has given an engraving of it in his valuable work.

In the collection of Dr. William Hunter, there is a well-marked instance of bony union of a transverse fracture of the patella, and other examples have been seen in the dead subject by Mr. Wilson. In Sir Charles Bell's museum were likewise similar specimens, one or two of which are now in the Museum of University College.*

Dislocations of the femur from the tibia at the knee-joint.—The articular surfaces of the head of the tibia for the reception of the femoral condyles are very superficial; and although the semilunar cartilages are superadded to them for the reception of the condyles of the femur, they have no direct tendency to resist luxations of the femur at the knee-joint. On the other hand it is to be recollected that the surfaces by which the tibia and femur are articulated together are broad, and that the number and strength of the ligaments which unite these bones is considerable. The solidity of the articulation is further augmented by numerous and powerful tendons which surround the joint. Although therefore the knee-joint from its situation and functions must be subjected to numerous injuries, dislocations are very seldom witnessed as the result of accident. Dislocations, however, occur in four different directions; two of them are incomplete and lateral while the others are perfect luxations, the femur being thrown either backwards or forwards. The lateral luxations are the rarest.

The lower extremity of the femur is now and then dislocated *backwards*: the signs of the accident are the following. The thigh-bone is somewhat displaced to the side as well as backwards, and the tibia is advanced before the condyles of the femur. The lower dislocated extremity of the os femoris makes such pressure on the popliteal artery as to prevent the pulsation of the anterior tibial artery on the foot. The patella and tibia are drawn by the rectus muscle forwards; such, Sir A. Cooper tells us, are the appearances the knee-joint presented in a man brought into St. George's Hospital in the year 1802. The limb in this case was easily reduced by extending the thigh from above the knee, and by drawing the leg from the thigh and inclining the tibia a little backwards. As soon as it was reduced, the popliteal artery ceased to be compressed, and the pulsation in the anterior tibial artery was restored. We will quote the following abstract of a case of dislocation of the lower extremity of the femur backwards;† the

subject of the accident, besides other injuries, was brought into the Chester Infirmary with a very complete dislocation of the lower extremity of the femur backwards. The whole limb was shortened four or five inches, and the condyles of the femur could be felt plainly among the muscles of the calf of the leg, while the tibia was in advance of the femur and drawn upwards on the anterior part of this bone. The leg and foot were swollen and cold; all circulation below the knee was stopped; there were no marks of external contusion. It appears that although the pulleys were used to reduce the luxation, it was easily effected by gradual extension of the limb. It became necessary after about five weeks had passed from the time of the accident, to amputate the limb in consequence of an extensive abscess which formed in the ham and calf of the leg. Upon examining the amputated limb, it was found that the popliteal abscess was very extensive and communicated with the knee-joint. On tracing the course of the artery, which had been previously injected, it was found to be obliterated from just below the point where it gives off the superior articular artery, exactly to its bifurcation into the anterior and posterior tibial arteries. The nerve also for this distance was slightly enlarged and firmer than natural, having a cord-like feel; the whole being so closely connected by dense cellular tissue as to be scarcely separable. The attachments of the muscles were all perfect and did not appear to have been lacerated. With respect to the joint the lateral ligaments on both sides were perfect; the anterior crucial ligament had been absorbed, but the posterior crucial ligament and the posterior ligament of Winslow were united into one band; the synovial membrane was healthy or but very little altered; the semilunar cartilages, as well as those on the ends of the bones, were sound; there was no fluid in the joint.

Case of dislocation of the femur backwards from the tibia.—Sir A. Cooper remarks that cases of dislocation of the knee-joint are so rare that every instance of this accident is worthy of recital. He adduces the following example from the experience of Mr. Toogood, of Bridgewater. Francis Newton, a strong athletic man thirty years old, fell from the fore part of a waggon, and was dragged a great distance before he was disentangled from the framework of the shafts. In two hours after the accident the left knee was observed to be very much swollen; the os femoris was dislocated backwards, and its lower extremity occupied the upper part of the calf of the leg, the internal condyle of the femur being nearly through the skin; the tibia, fibula; and patella were driven up in front of the thigh. The appearances of the limb were so dreadful that Mr. Toogood despaired at first sight of being able to reduce it, but to his surprise the reduction was easy. The limb was placed in splints; the strictest antiphlogistic treatment with rest was prescribed; the symptoms were mild, and he suffered little from pain or inflammation.

Malgaigne, in a letter to Velveau in the Archives Medicales, June 1837, upon the subject

* Prof. Cooper.

† London Medical Gazette, May 14, 1836, given by Mr. Thomas Brittan, House Surgeon, Chester Infirmary.

of dislocation of the knee, to which we refer for many observations we have not space for, gives a case of luxation of the femur backwards and of the tibia forward, which in some respects differed from those adverted to by Sir A. Cooper. He informs us that M. Lavalette was called on the 6th of April, 1815, to visit a man who had just before met with the accident we are now describing under the denomination of dislocation of the femur backwards and of the tibia forwards at the knee-joint. The limb was in a state of extension, somewhat inverted, and much shortened; it could, however, be flexed and extended, although with much pain. The extensor muscles of the leg were in a relaxed condition, as were also the hamstring muscles from the shortening of the whole limb. A depression existed where the condyles of the femur ought to present themselves anteriorly, and below this space the superior extremity of the condyles of the tibia could be felt. The patella was placed horizontally on the upper articular surface of these condyles; its point, which is normally placed downwards, was now directed forwards, and its superior margin backwards; its anterior or cutaneous surface was placed directly upwards, and its articular facet downwards, resting, as already mentioned, on the flat surface of the upper extremity of the condyles of the tibia. Lavalette here knew that he had to deal with a complete luxation, which we have called a luxation of the femur backwards and of the tibia forwards; and he was finally convinced of the real nature of the case by placing his hand in the popliteal region, where he distinctly felt the two condyles of the femur.

Luxation of the lower extremity of the femur forward.—The lower extremity of the femur is sometimes thrown forwards off the condyles of the tibia, while the latter bone is thrown backwards behind the condyles of the femur, producing the following appearances: the limb is shortened, the condyles of the os femoris are seen projecting, the ligament of the patella is depressed, and the leg is bent forwards. Sir A. Cooper gives a case in which the condyles of the femur were completely dislocated forwards, and the head of the tibia passed so far backwards behind the condyles as to fill up completely the popliteal space. The tendinous connexion of the patella to the rectus muscle was ruptured; the external condyle of the os femoris was very protuberant; the leg was bent forward and shortened, and a depression existed just above the patella. The patient felt most excruciating pain when the limb was moved, but when at rest there was not any considerable suffering; the luxation was reduced, and in five months recovery was complete.

Lateral luxation of the femur at the knee-joint.—Although from the structure of the parts it might at first be supposed that complete lateral luxation should be less resisted than the luxation of the femur either forwards or backwards, still there is no case on record with which we are acquainted of complete lateral luxation of the femur from the tibia as the

result of accident. We commonly see only one of the condyles of the femur abandon the tibia, while the other remains in the cavity the first had left. The luxation is then what is called incomplete. The reduction of this luxation is easy in consequence of the rupture of the ligaments.*

Dislocation outwards of the femur at the knee-joint.—In the dislocation outwards of the femur at the knee-joint, this bone is thrown off the external condyle of the tibia, and this latter bone projects on the inner side of the joint so as at once to disclose the nature of the injury. Sir A. Cooper once saw a case of this kind at St. Thomas's Hospital, and stated he was struck with three circumstances. The first was the great deformity of the knee from the projection of the tibia inwards; the second, the ease with which the bone was reduced by gradual extension; and the third, the little inflammation which followed upon what appeared so serious an injury. The man was discharged after a few weeks, having suffered little local or constitutional irritation.

Example of dislocation of the femur outwards.—Mr. Bovill was thrown from a gig; the femur projected much externally at the knee, and the tibia much (below the situation of the inner condyle of the femur) to the inner side of the condyle of the os femoris. The limb was extended from the thigh-bone, in a bent position; the extension was a long time continued, and force was employed by several persons for half an hour before the luxation was reduced. Sir A. Cooper saw him eighteen months after the accident; the patient could not then bend the limb at right angles with the thigh; there was also an unnatural lateral motion of the joint from the injury which the ligaments had sustained.

Incomplete dislocation of the femur inwards at the knee-joint.—The femur is sometimes thrown on the inner side of the knee-joint, the condyles of the tibia being carried outwards. The under surface of the inner condyle of the femur may be felt through the skin, while the outer condyle of this bone rests on the cup-like cavity hollowed on the upper extremity of the inner condyle of the tibia, or rather behind it. A deformity is produced analogous to that in the external dislocation, and may be easily conceived. From the little experience had of such cases, the reduction of the limb is stated to be equally easy with the former, and the patient recovers with little diminution of the powers of the part. Sir A. Cooper states as his opinion that in these cases the condyle of the os femoris with respect to the tibia is thrown somewhat backwards as well as outwards or inwards. An alderman fell from his horse and partially dislocated the condyle of the os femoris inwards, and the tibia outwards; the femur was easily replaced. He was perfectly recovered in twelve months.

To whichever side the tibia is luxated, it always pulls with it the patella, which suffers

* Blandin says: "Je l'ai éprouvé moi-même une fois à l'Hôpital de la Charité." *Traité d'Anat. Topog.* Paris, 1826, p. 617.

also a displacement more or less considerable according to the degree of displacement of the tibia. In these incomplete dislocations of the knee-joint, the patella, it is said, suffers but little displacement, its long axis only becoming oblique, and the lower point of the patella being directed either outwards or inwards, towards the tubercle of the tibia, according to the nature and direction of the dislocation. These are the opinions of Boyer, who evidently has not witnessed many cases of either complete or incomplete dislocations of the knee-joint. From what we ourselves have noticed of the situation the patella takes when the bones are displaced under the influence of disease, we should be disposed to believe that even in partial luxation of these bones laterally—particularly in the dislocation of the femur inwards and of the tibia outwards—in *this* case the patella would be thrown completely over the trochlea and lie on the outer side of the external condyle, as in fig. 6 and 8. If the limb be flexed and at the same time the tibia everted, such an event appears almost inevitable.

Dislocations of the patella.—Although the patella is not articulated with the tibia, nevertheless it is so strongly attached to this bone by ligament that the leg cannot be luxated from the femur without the patella necessarily undergoing a change of place; but the patella may be luxated independently of the tibia. Authors speak of luxations of the patella in the directions upwards, downwards, inwards, and outwards; but of these the two last alone deserve the name of luxations. The patella cannot descend beneath its usual place unless the extensor muscles of the leg be torn from their attachment to its upper margin; nor can this bone be elevated above its usual situation unless the ligamentum patellæ be ruptured. Luxations of the patella then may take place in the direction inwards or outwards. The latter is decidedly the more common. Either luxation may be complete or incomplete. (Boyer.)

Complete luxation of the patella outwards.—In this accident the patella is thrown completely off the articular trochlea of the femur. The internal edge of the bone is directed forwards, its external edge backwards; its posterior cartilaginous surface is applied to the outer surface of the external condyle of the os femoris, and its anterior or subcutaneous surface is turned completely outwards. In this case the ligamentum patellæ is somewhat twisted on itself, and its direction rendered oblique.

We recognize the complete luxation outwards by the extended condition of the patient's limb, by his inability to flex it, by the severity of the pain when he attempts to do so, and by the depression which is observed to exist in the place the patella had abandoned, (at the bottom of which depression we can easily distinguish the articular pulley of the femur); finally, by the tumour formed by the patella on the anterior part of the tuberosity of the external condyle of this bone. The accident usually occurs to a person who, while

walking or running, falls with the knee turned inwards and foot outwards, and thus by the violent action of the extensor muscles instinctively exerted to prevent the fall the patella is drawn over the external condyle of the os femoris. When the person rises he finds himself unable to bend or extend his leg, and the muscles and ligaments of the patella are on the stretch. This accident is generally the effect of muscular action, but the dislocation may result from accidental force acting on the patella.

In the greatest possible flexion of the leg the patella is too much sunk between the condyles of the femur, and is too strongly applied against these eminences by its ligament and by the tendon of the extensor muscles, to permit it to yield to the action of external force. But, on the contrary, when the leg is moderately extended, these attachments are relaxed; the bone projects more, and enjoys greater mobility, which renders it susceptible of yielding and of being displaced either outwards or inwards according to the direction of the impelling force. The luxation outwards, more easy and more frequent than that inwards, is ordinarily, as we have stated, the effect of a force acting upon the internal edge of the patella, by which this bone is pushed outwards, the leg being at the time either extended or moderately flexed. The natural prominence of the internal border of the patella renders it liable to be acted upon by blows, &c., and to be from this cause frequently thrown outwards over the external condyle of the femur.

The patella is sometimes dislocated spontaneously in persons of weak habit and of lax fibre, as it is denominated. If a person of this constitution be so malformed that the knees are directed too much inwards, the patellæ are from this cause still more predisposed to spontaneous luxation. The mere circumstance of the existence of a faulty inclination of the knees inwards is not sufficient in itself to predispose a patient strongly to a dislocation of the patella outwards; but when such a malformation coincides with an habitual state of muscular relaxation, this spontaneous luxation is likely to occur.

Luxation of the patella inwards.—This luxation is much less frequent than that outwards. It happens from falls against a projecting body, by which the patella is struck upon its outer side, the leg being at the time of the fall turned inwards. We require no other signs to enable us to recognize this accident than the cavity we notice in the place the bone has left, and the eminence it forms in the place to which it has been transferred, namely, on the internal side of the inner condyle of the femur.

Incomplete luxation of the patella.—The signs of this incomplete luxation are so evident* that it is impossible to mistake them. The leg is extended, and if we endeavour to flex it, the pain the patient suffers is considerably increased. The natural form of the knee is altered; we perceive through the skin the

* Boyer.

salient internal border of the articular pulley of the femur, which the patella has abandoned. This last bone forms in front of the external border of the pulley a very remarkable tumour, upon which the finger may easily distinguish the external border of the patella. We can also easily recognize through the skin and the capsular ligament the posterior articular surface of the patella, which has passed beyond the edge of the trochlea of the femur.

"In the course of a long practice," says Boyer, "I have met with but one case of dislocation of the patella," (and this, it appears, was an incomplete luxation.) "A young man, *æt.* 16 to 18, very tall, fell, running along a corridor. The internal part of the knee in passing struck violently against the corner of a trunk, which produced an incomplete luxation of the patella outwards. The surgeon in ordinary of the family was called; but whether it was that he did not recognize the luxation or that he did not consider he could reduce it, he did not wish to undertake it without having the assistance of Sabatier. This celebrated professor was at first uncertain as to the species of dislocation which the patella had suffered; but having carefully examined it and reflected on the phenomena the accident presented, he recognized the true nature of the case. He then attempted the reduction of the luxation, but failed in replacing the bone."

When Boyer arrived, he states that the patient was lying on his bed, the limb being extended and raised by pillows. The ordinary form of the knee was altered; the patella formed a tumour, which was sensible on the front of the external border of the articular pulley of the femur; in front of the internal border of the same pulley there was a depression, in the bottom of which could be perceived with the finger the same border of this pulley. The direction of the patella was changed in such a manner that its anterior surface was inclined inwards, and its external border forwards; finally, the external articular facet of the patella could be felt by the touch through the integuments which covered it. By these signs it was easy to recognize the incomplete luxation outwards.

Luxation of the patella on its edge.—Some very eminent surgeons have doubted the possibility of such an occurrence as a dislocation of the patella on its edge. "Some," says Boyer, "have imagined that the patella could be luxated turning half round on its vertical or long axis so as to rest on one of its edges on the articular trochlea of the femur. We cannot conceive," he proceeds, "how the tendon of the extensor muscles of the leg and the ligament of the patella could lend themselves to such a rotation of the bone on its long axis; much less can we understand how these parts can admit of a total reversion of the bone, as authors pretend to have observed." Notwithstanding these observations, it seems fully proved, that the patella can really be dislocated on its edge, and if we once admit the possibility of the partial rotation of the bone on its long axis, so as to constitute what is called a dislocation of the

patella on its edge, we can imagine that a more complete rotation of the bone on its long axis might happen, constituting the complete reversion of the position of the surfaces and edges of this bone spoken of by some writers.

It does not appear that Sir A. Cooper has seen the dislocation of the patella on its edge, but he states that he was informed by Mr. Willing, formerly of Hastings, that he was called to a case in which the patella was dislocated on its edge. The nature of the accident was very obvious, as the edge of the bone forced up between the integuments to a considerable height between the condyles on the fore part of the joint. Mr. Willing reduced the dislocation, but with considerable difficulty, by pressing the edges of the bone in opposite directions.

The following case of dislocation of the patella on one of its edges occurred lately in the practice of Mr. Pentland, surgeon to the Drogheda Infirmary, and is very interesting and important, coming as it does from an acute and experienced observer. J. M'Greene, *æt.* 25, of middle stature, was struggling to get down a strong man in play. He succeeded so far as to get him on his knees, when the fallen man took hold of both his legs with his arms closely embraced round them, and when M'Greene was struggling to disengage himself, he heard and felt his right knee give a loud snap. This was attended with the most excruciating pain, and he fell to the ground to the left side; he felt that he had lost all power over the right leg. He was carried to bed, and Mr. Pentland saw him in a few minutes after the accident. The knee was in a flexed state, presenting a most extraordinary appearance, but which was readily seen to proceed from the patella having been dislocated on its edge. Mr. Pentland stated that he had some difficulty in ascertaining which side was turned out, but he soon concluded that it was the under or articular surface. The man could not move the limb at all, "and never," says Mr. Pentland, "did I witness more dreadful suffering. You would suppose," he adds, "that the patella would force out through the integuments." After repeated attempts he at length succeeded in getting it into its place; the reduction was attended with a loud noise, and during the operation the man seemed to suffer frightful torture. Immediately on the reduction, all pain ceased, and in a very short time he recovered the perfect use of the limb.

A case of dislocation of the patella on its edge is recorded by Dr. Watson in the *New York Journal of Medicine and Surgery*, October, 1839. He calls the accident a dislocation of the patella on its axis, and says, "in the case I have described, the leg could be slightly flexed; no part of the pulley except its elevated border at the condyles of the femur could be felt. The patella was drawn upwards, and twisted nearly at right angles with its proper position, so that its anterior face was directed inwards, and its outer edge was thrown completely forwards, forming an uneven and very prominent line beneath the skin in front of the joint. The reduction of the bone to its normal position was not effected without difficulty."

Internal derangement of the knee.—"The knee-joint," says Mr. Hey, "is not unfrequently affected with an internal derangement of its component parts, and this sometimes in consequence of trifling accidents. The defect is, indeed, now and then removed as suddenly as it is produced, by the natural motions of the joint without surgical assistance; but it may remain for weeks or months, and will then become a serious misfortune, as a considerable degree of lameness may remain. This disorder may happen either with or without contusion. In the latter case the accident is easily distinguished from all others. The joint, with respect to external form, seems perfect; if there be any difference from its natural appearance, it is, that the ligament of the patella appears rather more relaxed than in the sound limb. The leg is readily bent and extended by the hands of the surgeon, and without pain to the patient; at most the degree of uneasiness caused by this flexion and extension is trifling; but the patient himself cannot freely bend, or perfectly extend the limb in walking; he is compelled to walk with an invariable and small degree of flexion. Though the patient is obliged to keep the leg thus stiff in walking, yet in sitting down the affected joint will move like the other."

The complaint, Mr. Hey apprehends, may be brought on by any such alteration in the state of the joint as will prevent the condyles of the os femoris from moving truly in the hollow formed by the semilunar cartilages and articular depressions of the tibia. According to him, an unequal tension of the lateral or cross ligaments of the joint, or some slight derangement of the semilunar cartilages, may probably be sufficient to predispose any one to this accident. Sir A. Cooper, in alluding to the internal derangement of the knee-joint described by Hey, calls the accident a "partial luxation of the thigh-bone from the semilunar cartilages;" but it does not appear to us that he had any opportunity of ascertaining the anatomy of such an accident. Sir A. Cooper has observed it to occur most frequently, when a person in walking strikes his toe, the foot being at the time *everted*, against any projecting body, as the fold of a carpet, after which the patient feels pain in the knee, which cannot be extended. He has also seen this accident happen from a person having suddenly turned in his bed, when, the clothes not suffering the foot to turn with the body, the thigh-bone has slipped from its semilunar cartilage. He also states that he has known it occur from a sudden twist of the knee inwards when the foot was turned out. He says, "under extreme degrees of relaxation, or in cases in which there has been increased secretion into the joint, the ligaments become so much lengthened as to allow the cartilages to glide upon the surface of the tibia, and particularly when pressure is made by the thigh-bone on the edge of the cartilage. The cartilages which receive the condyles of the os femoris are united to the tibia by ligaments; and when these ligaments become extremely relaxed and elongated, the cartilages are easily pushed from their situations by the condyles of the os femoris, which are then

brought into contact with the head of the tibia; and when the limb is attempted to be extended, the edges of the semilunar cartilages prevent it." It may be inferred from his observations that the accident may occur either at the internal condyle, which is the more common, or at the external, and that the position of the foot at the time of the occurrence of the accident has much influence in determining which of the semilunar cartilages is to be displaced. Thus, if the toe be everted, the displacement of the internal cartilage will occur; on the contrary, if the foot be fixed and inverted at the moment of the accident, the subluxation of the external condyle of the femur from the external semilunar cartilage will be the accident. Sir A. Cooper adduces the following case. Mr. Henry Dobley, *æt.* 37, has often dislocated his knee, turning the foot inwards, and the thigh-bone outwards, by accidentally slipping on uneven ground, or by sudden exertions of the limb. Considerable pain was immediately produced, accompanied with a great deal of swelling. His mode of reducing it is as follows. He sits upon the ground, and then bending the thigh inwards, and pulling the foot outwards, the subluxation of the os femoris being external, the natural position of the limb becomes restored.

Mr. L. a well-formed gentleman, *æt.* 29, has consulted me twice or thrice these last two years concerning this internal derangement of the knee-joint so well described by Hey. Mr. L. complains that, whenever he unguardedly flexes the knee suddenly, the toe at the time being much inverted, he is instantaneously seized with very disagreeable sensations in the knee-joint, not amounting to pain. There is a sudden sense of weakness across the front of the joint, the limb is semiflexed, and a great feeling of tightness and stiffness exists behind, along the course and about the insertion of the biceps tendon. All these symptoms come on suddenly from some awkward movement or false step, such as, in walking, putting his foot into some unexpected hole, but so very suddenly does the internal derangement occur, that, if walking at the moment, he generally falls to the ground. After a little time, though lame, he is able to walk, and to place the heel to the ground, and though he usually keeps the limb slightly flexed, he can at will extend it. These accidents are usually followed by some effusion of synovial fluid into the joint. I have practised with success the extension and sudden flexion of the limb advised by Hey, and my patient has himself occasionally, and with success, directed this manœuvre to be practised on him by his servant, or by any one who happened to be at hand when the accident occurred. He attributes the first cause of this liability to the sudden derangement of the articulation to a violent sprain of the knee-joint he got while ringing a young and powerful horse; the latter pulled away from him with such violence, that Mr. L. fell to the ground, and during the fall he felt as if something at the internal side of the knee-joint had been broken: the thigh and tibia were bent in such a manner as

to form an obtuse angle internally, and it is not improbable, that by the sprain the internal lateral ligament or other structures in the interior of the joint were injured. The sprain was followed by swelling, &c., and it was six weeks before he recovered so as to be able to walk. Mr. L. remained well for eight months, when, in crossing over a ditch, the sudden derangement recurred. The moment the displacement of some part of the interior of the joint occurred, he dropped suddenly to the ground. Another day, while practising some gymnastic exercise, it occurred. Again, it happened while in bed, the bed-clothes embarrassing the motion of the foot while he was turning his body round. On the last occasion on which the displacement happened, he was on horseback; he had just mounted, and was, while his knee was flexed, seeking with the *inverted* foot for the off-stirrup, when the displacement happened. On all these occasions he has without loss of time sought to replace the deranged parts, and sometimes has succeeded instantaneously, and sometimes weeks have passed without the adjustment of the parts in the interior of the joint occurring. The restoration of the use of the joint has always been as sudden as the derangement, and the replacement has invariably been accompanied by a sudden snap, as if something at that moment changed its place, and this to him was always the signal of recovery of the uses of the joint. When the extension and flexion of the limb in the manner recommended by Hey has been the means of restoration, he has on some occasions not only felt the sudden movement of what he considers the dislocated part in the interior of the joint, but he thinks he could distinctly hear the crack the part gave in resuming its ordinary place. The writer of this has lately seen and examined Mr. L.'s knee-joint, and compared it with the opposite one, and cannot perceive the slightest difference on a simple inspection of both articulations either before or behind. The patella and the ligament which connects it to the tibia are just as firmly applied in front of the joint as usual, and there is now no effusion into the joint of any unnatural quantity of synovial fluid. He habitually wears a laced knee-cap, and finds only a difficulty in flexing as fully the affected knee-joint as the other, and he has an habitual fear of any movement of the leg in which this is at the same time flexed, and the foot inverted. This is a well-marked example of the internal derangement of the knee described by Hey; but what are the true anatomical characters of the accident, or what really is the structure, whether normal or abnormal, which slips in and out with a noise? Nothing positive, in our opinion, has been added to the knowledge of the nature of the accident given to us by Hey, who has the merit not only of first describing the injury, but of also pointing out a simple and generally successful remedy.

Many surgeons have considered that the internal derangement of the knee described by Hey, and considered by Sir A. Cooper as a

"partial luxation of the femur from the semilunar cartilages," is a dislocation of these fibro-cartilages. Malgaigne justly criticises the vagueness of the language used by authors relative to this matter. M. Velpeau, according to Malgaigne, in one place treats of this luxation as a luxation of the semilunar fibro-cartilages, and in another work he seems so uncertain of the nature of the accident as to demand whether the phenomena may not be owing to the existence, in the interior of the joint, of some of those cartilages which we call foreign bodies. Malgaigne himself seems to fall into the opinion of Sir A. Cooper upon this subject, although he does not use the same terms, and considers the accident to be a simple and partial luxation of the femur from the tibia, the consequence of the *relaxation of all the ligaments*, but adduces no anatomical evidence of the truth of his hypothesis. He considers the accident, "Une simple luxation incomplète du femur sur le tibia, produite par un relâchement de tous les ligamens, et tout-à-fait analogue aux déplacements occasionés par la même cause dans les autres articulations." Sir A. Cooper is of opinion that Mr. Hey's plan is generally, but not invariably successful, and adduces the case of a lieutenant in the army who suffered this accident repeatedly, and the limb was often reduced by the above-mentioned means; but at length, turning in bed, from the pressure of the bed-clothes on his foot, the accident recurred. He came to London, but bending the limb had now no effect in enabling him to extend the joint. Sir A. Cooper, therefore, advised him to visit Mr. Hey, but he learned that in this case the dislocation was never reduced. In an obstinate case of this internal derangement of the knee-joint, which resisted all the ordinary means of surgical treatment, the writer succeeded (in Jervis-street Hospital) by using the pulleys. Under exactly similar circumstances, his lamented friend, Dr. M'Dowel, subsequently succeeded by having recourse to the pulleys when all other means had failed.

The knee-joint is seldom affected by *sprains*. When, however, there is an undue inclination of the knee inwards, the internal lateral ligament is occasionally, by an accidental false step or twist, sprained, and sudden lameness comes on followed by swelling, and more or less inflammation of the synovial membrane of the articulation. It has not been ascertained whether in such cases the fibres of the internal lateral ligament have given way, or whether they are detached from the bone or not; but it is not improbable that some such lesion has occurred as that we have already noticed under the head of *Sprains* in another articulation: (see ANKLE.) When sprains of the knee take place, it is almost invariably the inner side of the joint to which the patient refers as the principal seat of tenderness and pain. The joint admitting of motion unaccompanied by any crepitation (although the act may be painful), readily distinguishes a sprain from any fracture of the bones of the articulation. It is not improbable that in sprains of the knee-

joint, the interior of the articulation is occasionally injured; that the crucial ligaments are stretched; and that some of their fibres give way occasionally, breaking in their centres, or detached by their extremities from the bone. We lately had an example of a severe injury of the knee-joint, in which the anterior crucial ligament must have suffered great violence. The fibres of this structure did not give way, but the portion of the tibia to which they were naturally connected was torn up with the crucial ligament. We are not aware that such an accident as this has been before noticed, although it is probable that all complete luxations of the knee-joint must be preceded by such a lesion.

A young man, aged 25, was admitted into the Richmond Hospital under the care of Dr. Hutton, on the 11th of December, 1837, with an injury of the left knee-joint, which occurred when wrestling. Being intoxicated at the time his account of the manner in which the accident occurred could not be depended upon. The joint was much swollen, very tense, and painful; no fracture, and no other deformity than that occasioned by the general swelling of the joint could be detected. The limb was maintained in the semiflexed position and on the outside. Inflammation and symptomatic fever ran very high, and the pain was excessive, especially on the least motion of the joint. On the eleventh day the pain and swelling had diminished. He could then raise the limb from the bed, but could not increase the amount of flexion. On the seventeenth day symptoms of diffuse inflammation set in; these rapidly increased, and on the twenty-fourth day from the receipt of the injury he died. The knee-joint was found to contain eight ounces of purulent matter, in which flakes of lymph floated; the synovial membrane was soft, pulpy, and vascular; the circumference of the cartilages covering the condyles of the femur was in a slight degree absorbed. On flexing the joint, the spine and central portion of the head of the tibia, with a considerable portion of its left articulating surface, were found torn up from the rest of the bone in one piece, (fig. 10,) and remained attached to the anterior crucial ligament.

Rupture of the quadriceps extensor tendon from its attachment to the superior border of the patella.—The muscles and tendons around the knee-joint are very seldom the subject of accident. We have never heard of any accidental rupture of the tendons of the hamstring muscles; we have, however, known some instances of rupture from the upper edge of the patella of the muscular and tendinous structure attached to the superior edge of this bone, consisting of the combined muscular and tendinous attachments, of the rectus, cruræus, and vasti muscles. A person who has met with this accident cannot rise from the ground, nor can he stand when raised without being sustained by two persons; when he attempts to lean his weight on the affected limb, it yields and bends forwards. On examining the knee we observe between the superior border of the

Fig. 10.



Anterior crucial ligament torn up with portion of tibia.

patella and broken tendon a separation of one inch, which is diminished when we extend the leg, and increased much when we flex it. If we introduce our fingers into the bottom of this depression, we feel plainly the trochlea of the femur. In this case, as may be expected in all analogous accidents, there is much effusion of synovial fluid, which distends the interior of the joint; and it is probable that the synovial membrane does not escape laceration.

Patrick Dignam, æt. 69, was admitted into the Richmond Surgical Hospital on the 15th of December, 1839, for a rupture of the tendon of the rectus cruris. He stated that about a week previously, while carrying on his back a load of about two hundred weight, he slipped and fell backwards, and in making a violent muscular effort to recover himself, he felt something snap about his knee. He fell backwards, and was unable to rise without assistance. When placed on his sound limb, he found he could not elevate the affected one; he could only flex it. Whenever he attempted to put the limb under him, it quite failed him, his knee giving way and becoming instantly flexed against his will. It was found that considerable effusion had taken place into the knee-joint: the patella was raised up and seemed to float as it were on the synovial fluid and was very moveable; its entire outline could be easily ascertained; and when the leg was fully flexed, the patella was still quite moveable in the lateral directions. Above the margin of the patella a considerable depression existed

into which the fingers could be sunk, and the posterior articular surface of the patella could be felt and the condyles of the femur also could be recognised through the skin. The ligamentum patellæ seemed to be of its natural length. The patient, when standing on the sound limb, could easily flex the affected one, but could not elevate it nor advance it in the least. When supported under each arm and desired to throw his weight on the injured limb, it instantly gave way under him, becoming suddenly flexed; and if the man were not supported, he would instantly fall forwards. It is now five months since he met with the accident, and being unable to earn his living he is obliged to seek a shelter in the poor-house. The upper edge of the patella can now be plainly felt, and the muscular fibres normally attached to this margin are separated from it fully one inch, this interval being increased in flexion. The surface of the trochlea and the condyles of the femur can be plainly felt. The man is obliged to use crutches in moving about. The result has been unfavourable, but it is to be recollected that the man was of a weak and debilitated frame and neglected to seek assistance for many days. A dignitary of the established church in this country, aged 70 years, who had met with this accident, was more fortunate; he was under the care of Mr. Wilmot, Professor of Surgery at the College of Surgeons, who informs me that his recovery from this accident took about a year, but that he could walk without lameness, and that the recovery was perfect.

The tendon or ligament which connects the lower extremity or front of the patella to the tibia is sometimes broken transversely. This rupture sometimes takes place across the fibres of the ligament, and sometimes one or other of the extremities of the tendon is detached from the bone to which it is naturally connected. This rupture usually takes place in a fall upon the knee, the leg being at the time carried suddenly in the greatest possible degree of flexion while the patella is drawn upwards by the contraction of the extensor muscles. We recognize this rupture by the following signs: the patient cannot raise himself from the ground; the leg has a singular tendency to flex itself, and cannot voluntarily be extended. If we examine the knee immediately after the accident and before any swelling has supervened, we observe that the patella is elevated, that its lowest point is now directed forwards, that a great degree of lateral movement can be communicated to it, and that its ligament is preternaturally relaxed. We observe underneath the skin at the place of the rupture a depression or considerable vacuum. If we push the finger from below upwards underneath the apex of the patella, we can elevate this bone so as to distinguish by the touch the eminence which separates the two articular surfaces of the tibia from each other. Such signs leave no doubt of the rupture of the ligament of the patella; but as this rupture takes place as a consequence of a fall upon the knee, and as this part is more or less contused, there fol-

lows sometimes so considerable a swelling that it is impossible to recognize the rupture. It is not until after the disappearance of the swelling that we can often assure ourselves of the true nature of the accident. Under careful management complete recovery takes place.

(Robert Adams.)

LACRYMAL ORGANS, or lacrymal passages, *organa lacrymalia s. via lacrymales*; Fr. *Les organes lacrymaux ou voies lacrymales*; Ital. *Gli organi spettanti alle lagrime*; Germ. *Die Thränenorgane*.

Under this head it is proposed to describe not only the lacrymal organs properly so called, but also the eyelids and conjunctiva. This article therefore comprehends all the accessory or protecting parts of the eye (*talamina oculi* of Haller) except the orbit and muscles of the eyeball, for which see the articles FACE and ORBIT. Those parts of the orbit directly connected with the lacrymal organs are however noticed here.

I. The eyelids.—*Palpebræ*.* Fr. *Les paupières*; Ital. *Le palpebre*; Germ. *Die Augenlider*.

The eyeball is invested in front by a mucous membrane called *conjunctiva*. Towards the margin of the orbit, this membrane leaves the eyeball and forms together with the skin, with which it is continuous, two horizontal folds, an upper and a lower, intended occasionally to cover and so to protect the delicate and transparent front of the eyeball. The folds thus formed by the application against each other of a layer of mucous membrane and a layer of skin are *eyelids*.

Such is the simplest idea of eyelids, and such are they found in the salamander and axolotl among reptiles, and so far as in certain instances they exist among fishes; such even is their state in man and the higher animals at the commencement of development. But, as in the perfect condition of the organ of vision, it is essential that the eyelids should admit of being readily drawn over the front of the eyeball, and as readily retracted in order again to permit the access of light, so something more than a mere tegumentary fold was required to constitute a perfect eyelid. There was, in fact, required something to impart firmness, especially to the margins of the folds,—a structure which, whilst it served as an advantageous point on which the muscles necessary for the movements of the eyelids might exert their action, should cause no undue pressure on the eyeball, but rather give it an equable support and shield it from that irregular compression which might otherwise have been produced. All these desiderata we find supplied by a thin fibro-cartilaginous lamina, called *tarsal cartilage*, contained in either eyelid, within the fold formed by the skin and conjunctiva.

The tarsal cartilages do not occupy the whole of the folds, but only a part at their free margins. Between the upper edge of the carti-

* *Palpebræ*, a palpitando, quod palpitare et tremere videntur, propter citissimum et frequentissimum motum.

lage of the upper eyelid and the lower edge of that of the lower, respectively, and the corresponding edges of the orbit, there intervenes a cellulo-membraneous expansion. This (and in the upper eyelid, the expansion of the levator palpebræ superioris,) together with the conjunctiva on its inside and the skin on its outside, serves as it were the office of a loose hinge for the firm part of the eyelid. But the pivots on which the motions of the eyelids, especially of the upper, more immediately take place, are the angles of the eye. The upper eyelid, indeed, moves somewhat in the manner of the visor of a helmet, its firm part, when the eye is open, being drawn up and retracted within the margin of the orbit whilst its loose part is thrown into folds.

External conformation of the eyelids.—The extent and form of the eyelids are best seen when they are closed in sleep. The convexity of their external surface then bespeaks a corresponding concavity of the internal adapted to the prominent front of the eyeball. The opening between the two eyelids is called the palpebral fissure, *rima palpebrarum*. In the closed state of the eye, this fissure represents a mere curved line with the convexity downwards; but on account of the way in which the eyelids are moved, it is, in the open state, a wide elliptical aperture.

It is chiefly by the motions of the upper eyelid that the open or closed state of the eye is commonly produced. The upper eyelid is larger than the lower, and in the closed state of the eye from relaxation simply, as during sleep or in death, it covers much more of the front of the eyeball than the lower. But in forced closure of the eye by the action of the orbicularis palpebrarum muscle, the lower eyelid is drawn up, being impressed at the same time with a horizontal movement towards the inner angle, and meets the upper half-way, so that the latter cannot descend so far as it does during sleep. Hence, in active closure of the eye the skin of the upper eyelid is thrown into folds, whereas, in passive closure, it is smoothly extended in a convex form over the eyeball. The lower eyelid is capable of pretty extensive motion. It can of itself alone cover almost entirely the whole front of the eyeball, either when the upper eyelid is held immovably retracted under the edge of the orbit, or in that morbid shortening or retraction of the upper eyelid known by the name of *lagophthalmos*. But as the covering of the eye by the lower eyelid is always the effect of a muscular exertion, the eye in *lagophthalmos* will not be covered during sleep, hence the lower can never serve as a substitute for the upper eyelid.

Sir Charles Bell* says, "Anatomists have sought for a depressor of the inferior eyelid, seeing that it is depressed, but such a muscle has no existence and is quite unnecessary. The levator palpebræ superioris opens wide the eyelids, depressing the lower eyelid at the same

time it elevates the upper one. If we put the finger upon the lower eyelid so as to feel the eyeball when the eye is shut and then open the eye, we shall feel that during this action the eyeball is pushed outwards. Now the lower eyelid is so adapted as to slip off the convex surface of the ball in this action and to be depressed, whilst the upper eyelid is elevated." I believe the following to be what is usually observable in regard to the motions of the lower eyelid: the lower eyelid is drawn up over the eye by a muscular exertion; when that exertion is discontinued it falls back into its former state simply by its own elasticity and that of the integuments of the cheek. It is only in the forced state of looking downwards that the prominence of the cornea forces down the lower eyelid, in the manner described by Sir Charles Bell. It is to be remembered, however, that in the act of looking downwards, whilst the prominence of the cornea forces down the lower eyelid, the upper, contrary to what might be inferred from Sir C. Bell's statement as quoted above, is depressed, instead of being elevated.

In winking the upper eyelid falls and the lower rises considerably.

The free margins of the eyelids are broad surfaces. That of the upper eyelid is about one-twelfth of an inch broad; that of the lower about one-fifteenth. The edge bounding the margin anteriorly corresponds to the insertion of the eyelashes and is round. The posterior edge is much sharper and more defined than the preceding, and is the place where the delicate integument of the margin of the eyelid is continued into the palpebral conjunctiva.

On the margin of either eyelid between the two edges or boundaries just described, but nearer the posterior than the anterior, and parallel to them, there is observable, on close inspection, a row of minute pores—the excretory mouths of the Meibomian follicles.

The margins of the eyelids have been said to present a slope towards the eyeball, so that their outer edges only meet, when the eye is closed; and hence is produced a sort of channel between them and the eyeball of a triangular prismatic shape, which serves to lead the tears to the inner corner of the eye. Such a conformation, if it exists in the upper eyelid, is very slight and is amply compensated for by the slope in the opposite direction of the margin of the lower eyelid. The fact thus appears to be that when the eyelids are closed, their margins, as has been remarked by Magendie, meet each other surface to surface as nearly as may be.

The inner and outer corners of the eye where the eyelids join are called *canthi*. The outer canthus, generally speaking, forms an acute angle; but on close examination, it is observed that the apex is rounded off, somewhat prolonged and turned slightly downwards. The conformation of the inner canthus is altogether peculiar and rather complicated. At the inner canthus the palpebral fissure is prolonged into a sort of secondary fissure;

* The Nervous System of the Human Body, p. 186.

hence, when the eye is open, the apex of the angle formed by the inner canthus is broader and to a much greater degree prolonged than the outer; it is also rounded and turned downwards, but likewise in a much greater degree. The margins bounding the secondary fissure being destitute of cartilage are not firm and square but soft and rounded.

Where the margin of either eyelid is continued into the margins bounding the secondary fissure in question, there is observed on slightly everting the eyelids a small prominence, and in the apex of it a minute aperture, larger however than those above mentioned of the Meibomian follicles. The eminence is called *lacrymal papilla* and the aperture *lacrymal point*.

The fissure is closed by the action of the orbicularis muscle at the same time as the eyelids; but its margins, especially at the lacrymal papillæ, come completely into contact before they do. The space within the inner or nasal canthus is called *lacus lacrymalis*. The lacrymal papillæ and their points are turned in towards it, ready to take up the tears as they collect.

At the bottom of the lacus lacrymalis, there is seen a small reddish glandular body, the *lacrymal caruncle*, and between the latter and the white of the eye a *semilunar fold* of pink-coloured conjunctiva.

Eyelashes, *Cilia*,* Fr. *Cils*; Ital. *Le ciglia*; Germ. *Die Augenvimpern*. Every one knows the conformation of the eyelashes. How that they are stiff compressed hairs, increasing at first in thickness from their root, then gradually tapering to their free and slender extremity; how that they spring from the anterior edge of the palpebral margins; how that those of the upper eyelid are stronger and more numerous than those of the lower; how that those in the middle are longer than those towards the corners of the eyelids; and how that those of the upper eyelid are curved upwards and those of the lower eyelid downwards, so that their convexities regard each other. In regard to the curvature it is to be remarked that it is not gradually throughout the whole hair but is betwixt the thickest part and the root. There is another slight but variable curvature towards the extremity.

The skin of the eyelids is continuous with and similar to that of the face, only somewhat more delicate. The skin of the upper eyelid is more delicate than that of the lower.

The eyebrows, *supercilia*, Fr. *Les sourcils*; Ital. *Le sopraciglia*; Germ. *Die Augenbraunen* (fig. 11). The external appearance of the eyebrows is too well known to require any particular description. Their prominence is produced partly by the superciliary arches of the frontal bone over which they lie, but principally by a cushion of cellular and adipose tissue underneath the skin, together with the roots of the hairs and muscular substance. The hairs of the eyebrow are, generally speaking, directed from within outwards, but internally, especi-

ally where they exist over the root of the nose, they are inclined in the opposite direction. Those immediately over the root of the nose indeed cross each other. Besides the general direction from within outwards of the majority of the hairs of the eyebrows, it is to be remarked that the uppermost ones are inclined downwards and the lowermost ones upwards, so that they are raised into a kind of ridge along the middle line of the eyebrow, an arrangement which presents a pleasing appearance of regularity. The eyebrows are capable of very free motions, and these are in close connexion with the affections of the mind; hence the eyebrows have always been considered a very important physiognomical feature. The movements of the eyebrows are effected by muscles inserted into their skin. These muscles are: the frontalis, which elevates the eyebrows; the upper and outer fibres of the orbicularis palpebrarum, which depress them, and the corrugator supercillii, which draws them inwards. For their description, see article FACE.

The eyelids act in conjunction with the iris on many occasions; thus, in a weak light and in the act of looking at distant objects, the eyelids are widely opened at the same time that the pupil is dilated; when the eye is exposed to a strong light, on the contrary, or in looking at near objects, the palpebral fissure is contracted along with the pupil. In sleep complete closure of the eyelids is associated with very great contraction of the pupil.*

Fig. 11.

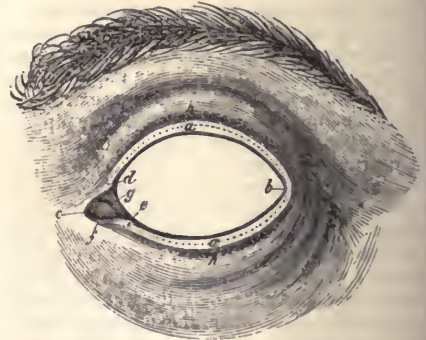

The eyelids of the left side widely opened, seen from without. (From Semmerring.)

- a a, The broad free margins of the eyelids, with the mouths of the Meibomian follicles.
- b, Outer canthus.
- c, Inner canthus.
- d, Lacrymal papilla and lacrymal point of upper eyelid.
- e, The same of the lower eyelid.
- f, Lacrymal caruncle, and g, semilunar fold, at the bottom of the lacus lacrymalis, which is the space within the fissure of the inner canthus.
- h h, The orifices whence the eyelashes have been plucked out.
- i, Eyebrow.

* See farther on this subject, Tourtnal, Ueber die Function der Augenlider beim Sehen. in Müller's Archiv, No. iii. 1838.

* Cilia, quia oculos ceclant ac tueantur.

Internal structure of the eyelids.—The tarsal cartilages may be looked upon as the skeleton of the eyelids, and the membranous expansion intervening between them and the margins of the orbits as connecting ligaments. The latter, indeed, are called the *tarsal ligaments*, although they do not in reality possess a ligamentous structure, but consist merely of dense laminar cellular membrane. On the inner surface of the tarsal cartilages and tarsal ligaments the palpebral conjunctiva adheres. On the outer surface are the palpebral and ciliary portions of the orbicularis palpebrarum muscle, over which is the skin. Moreover, incorporated with the superior tarsal ligament is the expansion of the tendon of the levator palpebræ superioris muscle. Imbedded in the substance of the tarsal cartilages lie the Meibomian follicles. Underneath the skin and the ciliary portion of the orbicularis palpebrarum muscle, the roots of the eyelashes lie close on the tarsal cartilages.

Tarsal cartilages.—*Tarsi*; Fr., *Les Tarses*; Ital., *I tarsi*; Germ., *Der Augenliedknorpel*. These are thin plates of fibro-cartilage, convex on the outer surface, concave on the inner, to be adapted to the front of the eyeball. The upper is the larger. One of their margins is thick and straight, the other thin and curved, especially so in the upper, which therefore represents in some degree a segment of a circle, whilst the lower is little more than a narrow stripe. The thick and straight margin, called the *ciliary*, forms the margin of the eyelid; the thin and curved margin, called *orbital*, degenerates into the membranous expansion already mentioned under the name of *tarsal ligaments*. Towards the outer canthus the orbital margins of the tarsal cartilages run into the ciliary ones at an acute angle, whilst towards the inner canthus they form an obtuse angle by their junction. The transverse length of the tarsal cartilages is somewhere about an inch, the breadth of the upper cartilage at its broadest part about one-third of an inch, the breadth of the lower cartilage only half as much. At the inner canthus the tarsal cartilages extend no farther than the lacrymal points, and at the outer canthus they stop close to the commissure of the two lids.

As to the intimate composition of the tarsal cartilages, they consist of what is called fibro-cartilage, a microscopically fibrous substance, without any of the corpuscles of common cartilage.

In the human lower eyelid, the thickness of this substance is inconsiderable, and its consistence not so great as in the upper. In the lower animals it is in the same state in both eyelids. This is what has led Zeiss† to say that he never found a real cartilaginous tarsus in the human lower eyelid, nor among the lower mammifera in the upper eyelid either. “In

the sow only,” says he, “there is a nearer approach to a tarsal cartilage than is to be found in any other of the lower animals.” Müller* has very well explained away all this difference of opinion, by showing that the dense cellular tissue which, according to Zeiss, occupies the place of tarsal cartilage in the human lower eyelid, and in both those of the inferior mammifera, is the same tissue, as the more consistent fibro-cartilage of the human upper eyelid, only in a less condensed state.

The Meibomian glands are commonly described as being situated between the palpebral conjunctiva and tarsal cartilage. Winslow, Haller, and Zinn describe them as lying in grooves on the posterior surface of the tarsal cartilages. The Meibomian glands are seen very distinctly from the inside of the eyelids, as if they were immediately underneath the conjunctiva. But if the skin and orbicularis muscle be removed from the outside, these glands become equally visible there. “Where, then,” asks Zeiss,† “do they lie,—before or behind the tarsal cartilage?” Examination of sections of the cartilage shows that the Meibomian glands lie in the substance of the tarsal cartilage itself; and in the human lower eyelid and in both those of the lower animals, in the less consistent fibrous structure which there composes the tarsus.

At the outer canthus the cellulo-membraneous expansions called tarsal ligaments are stronger, and form bands which decussate and thus tie the tarsal cartilages to each other and to the outer margin of the orbit. These bands compose what is called the *external palpebral ligament*.

The *internal palpebral ligament* is the tendon of the orbicularis palpebrarum muscle,—*tendo oculi*, or *tendo palpebrarum*. This, to adopt the description of Professor Harrison of Dublin, “is a small horizontal tendon, nearly one quarter of an inch in length. It is inserted internally into the upper end of the nasal process of the superior maxillary bone; thence it passes outwards and backwards to the internal commissure of the eyelids, where it forks into two slips which enclose the caruncula lacrymalis, and are then inserted each into the tarsal cartilage and the lacrymal duct.”‡

Orbicularis palpebrarum muscle.—This is described in the article FACE, vol.ii. p. 221. Here we shall only advert to some particular points in its history. The fibres of the orbicularis pertaining to the upper eyelid arise from the internal angular process of the frontal bone, and from the upper edge of the tendo palpebrarum, and proceed, forming a curve, at first upwards and outwards, and then downwards and outwards, within the upper eyelid and along and over the upper edge of the orbit towards the temple and outer angle of the eye. Here they meet those of the lower eyelid which have come from the nasal process of the upper jaw-bone,

* Tarsus, propter siccitatem quod carnis sit expers.

† Anatomische Untersuchungen der Meibomischen Drüsen des Menschen und der Thieren mit besondere Berücksichtigung ihrer Verhältniss zum Tarsus. In Ammon's Zeitschrift der Ophthalmologie. Bd. iv. p. 249.

* Archiv, 1836. Jahresbericht, p. xxxviii.

† L. c. p. 240, and op. cit. Bd. v. S. 216. See also Sichel in *Lancette Française, Gazette des Hôpitaux*, No. 53, 55, and 57. Paris, 1833.

‡ Dublin Dissector, 4th ed. p. 6.

and from the lower edge of the palpebral tendon, curving at first downwards and outwards, then upwards and outwards, within the lower eyelid and along the edge of the orbit, extending some way down over the cheek. The part of the orbicularis more immediately contained within the eyelids, sometimes called the *palpebral* and *ciliary* portions, in contradistinction to the outermost fibres, which are without the eyelids, and encircle the base of the orbit, therefore called the *orbital* portion, consists of pale thin fibres, of which those at the margin of the eyelids are collected into a considerable fasciculus, having interposed between them and the tarsal cartilage the roots of the cilia. At the outer canthus the upper and lower fibres intercross and adhere to the external palpebral ligament. That many of the fibres of the orbicularis are inserted into and exert their action in a great degree on the skin of the eyelids, may be easily ascertained in the living person, by observing, during the action of closing the eye, the traction of the skin of the eyelids towards the nasal canthus. By this traction, the skin, especially in the lower eyelid, is very much corrugated. This corrugation of the skin of the lower eyelid by the action of the orbicularis is greatest right over the lower part of the lacrymal sac,—that part which we commonly press upon when we want to evacuate any accumulation of mucus or tears,—that part where abscess of the sac generally bursts and leaves a fistulous opening,—that part which we open in the operation for so-called fistula lacrymalis. This part of the lacrymal sac must therefore be immediately affected by the contraction of the muscle, and the pressure thus produced, together with that on the upper blind end of the sac by the superior fibres, will promote the transmission of the tears and conjunctival mucus into the nasal duct.

The great use of the orbicularis palpebrarum is to close the eyelids; but in effecting this it acts at a disadvantage, inasmuch as its action on the eyelids is not direct, but oblique; therefore they are brought together only by being drawn horizontally inwards, though it is the lower eyelid alone which yields to this latter movement. We may imitate in some degree the mode of action of the orbicularis, but in an opposite direction, by pressing the skin immediately outside the outer canthus, towards the temple.

Levator palpebræ superioris muscle.—This is the antagonist of the upper part of the orbicularis. It is a weak slender muscle, but then it has the advantage of exerting its action in a direct manner. It extends from the bottom of the orbit to the superior tarsal cartilage, lying immediately underneath the roof of the orbit. It is the longest of all the muscles of the orbit. Thin and triangular, it rises by its apex, which is a short tendon, from the upper edge of the optic foramen. The fleshy body of the muscle gradually increases in breadth as it proceeds forwards; then bending downwards over the eyeball, its insertion takes place by a broad thin tendinous expansion, the base of the triangle, into the upper margin and anterior surface of

the superior tarsal cartilage, being incorporated at the same time with the so-called tarsal ligament. It is by the action of this muscle that the upper eyelid is drawn up and retracted within the orbit.

Having thus described the skeleton and muscles of the eyelids, it remains to consider their investments and appendages. The investment of their inner surface, the *palpebral conjunctiva*, will be described farther on, along with the rest of the conjunctiva. The skin of the eyelids lies over the fibres of the orbicularis palpebrarum. It is very fine and destitute of hairs, but contains minute sebaceous follicles. The latter are sometimes, especially in the lower eyelid, enlarged, and give out a morbid secretion, which is hard, and forms those horny excrescences occasionally met with in old persons.

Cellular tissue of the eyelids.—The conjunctiva investing the inner surface of the tarsal cartilages adheres without the intermedium of any cellular tissue. The connection between the two structures is immediate and intimate, as in the compound membranes called fibro-mucous. The rest of the palpebral conjunctiva adheres by cellular tissue. The palpebral and ciliary portions of the orbicularis muscle are connected on the one hand to the tarsal cartilages and other subjacent parts, and on the other to the superjacent skin, by a laminar cellular tissue, which, like that in some other parts of the body, is not combined with the adipose tissue. Being rather loose, the cellular tissue of the eyelids becomes readily infiltrated by effused fluids, as in *adema* and *emphysema*. It is not unfrequently the seat of abscess.

Roots of the eyelashes. From the anterior edge of the free margins of the eyelids, the eyelashes spring. They are inserted three or four deep, especially in the middle. The capsules of the bulbs of the eyelashes lie close on the tarsal cartilage under the ciliaris muscle and skin, extending to the depth of about one-eighth of an inch. One of the operations for *trichiasis* is to extirpate the roots of the eyelashes, but it is very difficult to remove them all, the oozing of blood is generally so great. When the part has healed after the operation, and the case seems doing well, a hair or two will often be found here and there sprouting out again.

Connected with the roots of the eyelashes as with other hairs, are small sebaceous glands consisting of minute but distinct lobules or grains closely surrounding the capsule, into which they send one or more excretory ducts.*

Meibomian glands. Glandula Meibomiana s. palpebrarum sebacea; — Fr. *Les glandes de Meibom*; — Ital. *Le glandule Meibomiane*; — Germ. *Die Meibomschen Drüsen*.

* Gurlt, Vergleichende Untersuchungen über die Haut des Menschen und der Haussäugethiere, besonders in Beziehung auf die Absonderungsorgane des Haut-talgdes und des Schweisses. In Müller's Archiv, 1835, p. 399.

† Zeiss. Fortgesetzte Untersuchungen über die Anatomie und Pathologie der Augenlider von Dr. E. Zeiss in Dresden. In Ammon's Zeitschrift, &c. B. 5, p. 216.

These are elongated more or less compound follicles, secreting a peculiar sebaceous matter intended as an ointment to protect the delicate integument of the margins of the eyelids from any irritation which might result from friction, or the frequent contact of the tears, and also to preserve to it that peculiar degree of sensibility which, like all other transition structures from skin to mucous membrane, it possesses. The Meibomian glands lie imbedded in the substance of the tarsal cartilages. They are arranged close and parallel to each other, and generally speaking in a direction at right angles to the ciliary margin of the eyelids, where they open in that row of minute apertures already mentioned. There are between thirty and forty Meibomian glands in the upper eyelid, but not so many in the lower, in which also they are shorter in consequence of the difference in breadth between the upper and lower tarsus. Sometimes two glands are united towards their orifice; sometimes, on the other hand, at their end. Frequently the tail of the gland bends laterally and describes an arch. The structure of the Meibomian glands consists essentially in a central canal running from one extremity to the other, like the duct of the pancreas, and around that canal glandular loculi or cryptæ opening into it directly, or through the medium of each other. The duct suddenly contracts before opening on the margin of the eyelid. In a transverse section of the Meibomian glands this canal is seen, according to Zeiss, as a small hole around which are placed from five to six glandular grains.

The Meibomian glands of the sow are small; representing merely a short cyst subdivided into several loculi. The glands of the eyelashes in the same animal are, on the contrary, large. The Meibomian glands of the sheep, dog, and fox, are long very thick-walled bodies, in the middle of which there is a wide canal. Ranking next in complexity of structure are the human Meibomian glands. Those of the horse, ox, goat, and cat, Zeiss found still more complex, consisting of lobes, lobules, and granules.*

The secretion of the Meibomian glands is a mild, yellowish, unctuous substance, of the consistence of lard. Occasionally the external orifice of one or more of the Meibomian ducts becomes covered by a thin film, apparently of epidermis. This prevents the escape of the secretion, which accumulating raises up the film into a small elevation, like a ptyctenua. This does not actually cause pain, but gives rise to uneasiness in the part when the eyelids are moved: the film is easily broken, and the accumulated secretion removed on the point of a pin.

Hordeolum, or stye, according to some, is abscess of the Meibomian glands; according to others, a small boil implicating the cellular tissue at the margin of the eyelid. Zeiss† suspects it has its seat in the capsule and glands

of the roots of the eyelashes. Abscess of the Meibomian glands does occur, and gives rise to a tumour on the edge of the eyelid like a stye, but the nature of the case is seen on everting the eyelid. There can be no doubt that the roots of the eyelashes are involved in the disease, because the hairs at the part affected generally fall out at the end. Dr. Zeiss proposes to anticipate this result by plucking them out at once, and he says that by this procedure the progress of the complaint is arrested, a thing, certainly, occasionally very desirable. In a small inflammatory tumour at the root of a hair on the cheek, I have obtained such a result from plucking out the hair.

Fig. 12.

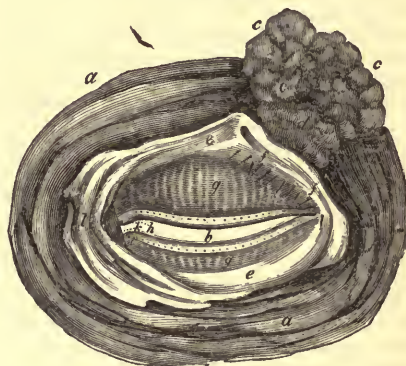

The eyelids of the right side seen from within.
(Modified from Soemmerring.)

a, a, Inner surface of orbicularis palpebrarum muscle.

b, Palpebral fissure.

c, c, c, Upper mass of lacrymal gland.

d, Lower mass of lacrymal gland.

e, e, Conjunctiva. The palpebral portion is smoothly spread on the inner surface of the eyelids. The portion which has been dissected from off the eyeball is in folds.

f, Hairs inserted into the orifices of the ducts of the lacrymal gland. These orifices are on the conjunctival surface of the upper eyelids towards its temporal extremity.

g, g, Meibomian glands of both eyelids seen shining through the conjunctiva and the thin layer of tarsal cartilage covering them on the inside of the eyelids.

h, Lacrymal papilla and point of the upper eyelid.

i, The same of the lower eyelid.

k, Lacrymal caruncle.

l, Semilunar fold pressed aside to show the caruncle.

II. The conjunctiva, semilunar fold, and lacrymal caruncle.

The conjunctiva in general.—*Tunica conjunctiva seu adnata*. Fr. *La Conjunctive*. Ital. *La Congiuntiva*. Germ. *Die Bindhaut*. The conjunctiva is that membrane which lines the posterior surface of the eyelids, and covers the front of the eyeball to the extent of about a third of its whole periphery. This disposition has given rise to the distinction of a *palpebral* and *ocular* conjunctiva. Towards the margin of the orbit, all round the circumference of the eyeball, a cul-de-sac is formed by the reflection

* Zeiss's papers in Ammon's Zeitschrift, B. iv. and v., already quoted.

† Locis citatis.

and continuation with each other of these two portions of the membrane. It is by this continuity that the eyelids and eyeball are held in connexion, hence the name *conjunctiva*, and that the orbit is closed in and cut off from all communication with the space between the eyeball and eyelids.

The space between the eyelids and eyeball we shall distinguish by the name of *oculo-palpebral space of the conjunctiva*, a name, the necessity for which appears from this, that in common language, when it is said a foreign body has got *into the eye*, it is only meant that it has got into the oculo-palpebral space of the conjunctiva. The propriety of the name moreover will become more evident when the space in Serpents and Geckoes comes under consideration, for in them it is a closed cavity, (in serpents already designated by Jules Cloquet* oculo-palpebral sac of the conjunctiva,) receiving the lacrymal secretion and communicating with the exterior only by the connexion it has with the nose through the nasal duct.

What are called the *superior and inferior palpebral sinuses of the conjunctiva* are those parts of the oculo-palpebral space under the upper and lower eyelids respectively, where the ocular and palpebral portions of the conjunctiva are reflected and continued into each other, forming a cul-de-sac. The conjunctiva is here loosely attached to the subjacent cellular and adipose tissue, &c. of the orbit, and forms folds constantly varying with the motions of the eyeball and eyelids. The superior palpebral sinus of the conjunctiva is deeper than the lower, the reflection of the conjunctiva from the eyelids upon the eyeball being when the eyelids are passively closed: above, at the distance of about seven-tenths of an inch from the margin of the upper eyelid, and below, at about three-tenths of an inch from the margin of the lower. The cul-de-sac formed by the reflection of the conjunctiva does not lie very deep within the outer canthus, speaking in reference to it alone, though as near the edge of the orbit as above or below.

The looseness of the folds formed by the conjunctiva at the upper and lower palpebral sinuses and within the outer canthus, together with the peculiar nature of its disposition at the inner canthus, presently to be noticed, allows of the free motions of the eyeball in all directions. These folds may be readily seen on everting either eyelid, as also the continuity of the conjunctiva from the eyelid to the eyeball by requesting the person to look upwards, if it is the lower eyelid which is everted, downwards in the contrary case.

In operations on the eyeball when the eyelids are held apart unskilfully, the folds are thrust out between the eyelids by the action of the orbicularis muscle, so that they almost bury the front of the eyeball and consequently impede the operator.

By long-continued catarrhal ophthalmia and the abuse of blue stone and similar escharotics,

the conjunctiva is apt to become contracted and thickened, and to acquire at the same time a callous articular surface. In such cases the contraction tells very much upon the looseness of the folds of the conjunctiva at the upper and lower palpebral sinuses, which may indeed be said to be obliterated. The consequence of this is great restriction in all the movements of the eyeball.

Foreign bodies which may have entered the oculo-palpebral space sometimes get lodged in the palpebral sinuses of the conjunctiva, especially the upper, and may be retained there for a length of time without causing much or any irritation, the conjunctiva being there so loose and the adjacent cellular and adipose tissue of the orbit so soft that the body is not much pressed upon by the opposing surfaces. The contrary is the case when the foreign body lies between the eyeball and the firm part of the eyelid, for here its irritation excites the orbicularis muscle to stronger action which serves but to aggravate the distress.

Disposition of the conjunctiva at the inner canthus.—Under this head falls to be considered the *semilunar fold*, the notice of which it will be advantageous to premise by a description of the lacrymal caruncle. In consequence of the prolongation of the palpebral fissure at the inner canthus into a secondary one, the lacrymal caruncle and semilunar fold are so exposed that their external conformation can be readily and indeed best studied in the living eye.

Lacrymal caruncle, *caruncula lacrymalis*. Fr. *La caroncule lacrymale*. Ital. *La caruncula lacrimale*. Germ. *Die Thränenkarunkel*. This is a small reddish yellow eminence having a slightly tuberculated surface, beset with very delicate scarcely visible hairs. It is situated, as has been said, within the secondary fissure of the inner canthus, and inclosed between the two slips of the tendo palpebrarum. To see the lacrymal caruncle in its whole extent, it is necessary to evert slightly the lower eyelid, when it is observed running into a point downwards and outwards. The lacrymal caruncle consists of a mass of loose fibro-cartilaginous tissue, similar to that of the tarsal cartilages, in which are imbedded follicles, secreting a fluid of the same nature as that of the Meibomian glands, and pouring it out by twelve or fifteen excretory orifices on its surface, which is invested by the conjunctiva. Anciently the lacrymal caruncle was thought to be the secreting organ of the tears, and the lacrymal points the excretory orifices.

Semilunar fold, *plica semilunaris*. Fr. *Le repli semilunaire*. Ital. *La piega semilunare*. Germ. *Die halbmondförmigen Falte*. In passing from the caruncle to the eyeball, the conjunctiva forms a vertical semilunar fold which encloses at its free edge a minute cartilage of a nature similar to the tarsal cartilages. This part of the conjunctiva is distinguished from the ocular portion by its reddish colour and greater thickness, indeed it resembles more the palpebral conjunctiva than the ocular. The concavity of the crescent, which is also the free edge of the

* Memoire sur l'existence et la disposition des voyes lacrymales dans les serpents. Paris, 1821.

fold, is towards the cornea. The rolling of the eyeball outwards has a tendency to undo the fold, which on the contrary is rendered more distinct when the cornea is turned towards the nose. In quadrupeds the semilunar fold is much more developed, and contains within it a more distinct cartilaginous plate. It constitutes what in them is called *membrana nictitans*. The third eyelid in birds is the same structure carried to its highest pitch of development. In man, in whom it is very small, its component structures are readily developed to a considerable size by inflammation. According to Soemmering the semilunar fold is larger in the negroes. We shall have occasion to recur to the *membrana nictitans* of quadrupeds and the third eyelid of birds.

The intimate nature of the connexion between the tarsal cartilages and the conjunctiva which lines them has been already noticed. Beyond the tarsal cartilages the adhesion of the palpebral conjunctiva becomes looser and looser until its transition into the ocular conjunctiva.

The ocular conjunctiva is smoothly spread over the front of the sclerotica, where it first passes on the latter. The interposed cellular tissue is loose enough to allow it to slide upon the sclerotica, or even to be raised up in wrinkles according to the motions of the eyeball, which are thus facilitated. But as the conjunctiva approaches the cornea it is more and more closely applied to the sclerotica and consequently less readily falls into wrinkles. The debated question of a conjunctival covering of the cornea will be considered when speaking of the intimate structure of the conjunctiva.

The cellular tissue between the conjunctiva and sclerotica is sometimes the seat of extravasations of blood, *subconjunctival ecchymosis*, sometimes the seat of an accumulation of serous fluid, as in the œdema attending erysipelatous ophthalmia. It is sometimes the seat of a more serious form of œdema, that known by the name of chemosis, and common in the purulent inflammation of the conjunctiva. It may also be the seat of emphysema, and is occasionally so of phlegmon.

Nature of the conjunctiva.—The conjunctiva forms part of that membranous system, continuous with the skin at all the natural apertures of the body, which lines the interior of the respiratory and digestive canals, and to which, as to that lining the genito-urinary passages, the generic name of *mucous membrane* is given. Of course different parts of this system present specific peculiarities in structure and function, and this is the case even in regard to the palpebral and ocular parts of the conjunctiva, though so near each other. Some of the Germans have unnecessarily involved this subject. Thus Walther viewed the conjunctiva as *mucous* in the eyelids, *tegumentary* over the sclerotica, and *serous* over the cornea. Whence we sometimes meet in their ophthalmological works such expressions as “the conjunctiva considered as a mucous membrane,” and “the conjunctiva considered as a serous membrane.” In reference to these opinions of his countrymen,

Müller* has thought it necessary to remark that the conjunctiva is as certainly a mucous membrane as any other of which the character has not been doubted. * * * On the other hand it has nothing in common with the serous membranes either in secretion, for the limpid secretion of the eyes is derived from the lacrymal gland, or in its form, which is not that of a shut sac.

Within the upper eyelid towards the outer canthus (*fig. 12 f*), the conjunctiva presents the minute mouths, nine or twelve in number, of the ducts of the lacrymal gland. At the inner canthus the conjunctiva is continuous through the lacrymal points with the membrane lining the canalicules, and so through them, the lacrymal sac and nasal duct, with the mucous membrane of the nose. At the margin of the eyelids its continuity with the skin is seen.

The ocular palpebral space of the conjunctiva receives the tears much in the same way that the mouth receives the salivary secretions. Like other mucous membranes the conjunctiva secretes a mucous fluid which lubricates its surface and serves to protect it from the irritating action of external agents, and even from that of the lacrymal secretion which is naturally poured out on it.

Intimate structure of the conjunctiva.

Palpebral conjunctiva, conjunctiva palpebrarum.—The conjunctiva lining the eyelids is thicker and more vascular than that which invests the sclerotica. On the posterior surface of the eyelids, about one-twelfth of an inch from and parallel with the posterior acute edge of the margin, there is a very slight groove. Between this and the edge of the eyelid the conjunctiva is sufficiently distinct by its moist shining surface and its vascularity, from the more integument-like though delicate investment of the margin of the eyelids with which it is continuous. But it is immediately in the groove and especially beyond it that the conjunctiva, as pointed out by Eble,† first shows itself truly as a mucous membrane, that is, presents all the characters commonly ascribed to mucous membranes.

The palpebral conjunctiva consists of a *chorion*, the free surface of which presents papillæ, constituting what is called the *papillary body*, and the whole is covered by an *epithelium*.

The *chorion* of the palpebral conjunctiva is intimately incorporated with the tarsal fibro-cartilages, so that the latter and their investing conjunctiva might be considered together as constituting a compound or fibro-mucous structure. Beyond the cartilages the *chorion* appears in its independent and separable form as a felt-work composed of an interlacement of filamentous cellular tissue, and is the nidus for the ramification of the vessels and nerves.

Papillary body.—If the upper eyelid be

* Handbuch der Physiologie des Menschen, Bd. 1, S. 429, Coblenz, 1836, or Translation by Baly, p. 436.

† Ueber den Bau und die Krankheiten der Bindehaut des Auges, p. 9. Wien, 1828.

everted and examined, the moisture being first wiped off from its surface, under different directions of the light, an appearance is observed as of a shining surface beset with small brilliant grains, as if minutely shagreened. This appearance is more or less distinct in different individuals and most so after death.

The appearance described is produced by numerous papillæ, considered nervous by Ruysch,* and small glands by Müller,† and, after him, by most other authors. Eble‡ objects to this view of the matter, and asserts that the papillæ are quite distinct from mucous glands, and are the same as the papillæ found on other mucous surfaces, and that they particularly resemble the papillæ of the mucous membrane of the gums and inner surface of the alæ nasi. Eble, however, adds that these papillæ present themselves in all the mucous membranes in a manner quite analogous to glands, and he thinks that the mucus of mucous membranes is the product of the secretion of the papillary body. And this is equally applicable to the secretion of the palpebral conjunctiva, whence it would appear that Müller and Eble really do not differ in opinion, but only in the terms they employ to express it.

The part where the papillary body appears least distinctly is between the edge of the eyelid and the groove on the posterior surface above mentioned. The palpebral conjunctiva all beyond the groove presents the papillary body in a more decided form, and the development of it goes on increasing to some distance beyond the orbital margin of the tarsus. The conjunctiva covering the lacrymal caruncle, as also the greatest part of the semilunar fold, present no papillary body. Towards the lacrymal points there is found a great number of pretty apparent papillæ.

The papillary body is very vascular. It is the morbid development of it which constitutes the so-called granulations of the eyelids in the puro-mucous ophthalmiæ; of which indeed the papillary body appears to be the peculiar seat. An inflammation suddenly affecting a healthy conjunctiva from atmospheric causes is what is conventionally called a *catarrhal ophthalmia*. If this be allowed to fall into a chronic state, or if the conjunctiva has been affected by a less marked inflammatory action for a time, the papillary body becomes hypertrophied. In this state it forms as it were a new organ ready to be affected by a form of disease which a healthy conjunctiva is not all at once so prone to assume. Mere congestion caused by over-exertion of the eyes, or by heavy caps and high tight collars, as Dr. Vlemminckx thinks, together with fatigue, exposure, want of cleanliness, abuse of stimulating liquors, &c., may give

rise to this unnatural development of the papillary body of the conjunctiva, and so predispose in a particular manner, on the occurrence of any atmospherical influence, to an attack of conjunctivitis, and that rather of the form of the Egyptian ophthalmia than of a simple catarrhal.

Epithelium of the palpebral conjunctiva.—“It is extremely difficult,” says Eble,* “to distinguish this on so fine a membrane. Although I have succeeded, by maceration in boiling water, in detaching it in part from the eyelids of an ox, I have not again been able to convince myself of the exactness of the observation as I could have wished.” J. F. Meckel doubted the existence of an epithelium. Eble says again that he would, however, admit its presence on the conjunctiva rather from analogy than from observation. Here is a good example of the assistance derivable from the microscope, two such observers as Meckel and Eble unable with the naked eye to determine the existence of a structure which later observers with the microscope have fully established. We shall return to the subject in speaking of the epithelium of the conjunctiva bulbi.

Sclerotic conjunctiva, conjunctiva sclerotica. As far as vascularity goes, there is a decided difference between this and the preceding. The sclerotic conjunctiva is composed of a chorion or vascular basis of the membrane covered by epithelium. Valentin‡ describes between the chorion and epithelium another structure which he calls papillary.

The chorion of the sclerotic conjunctiva consists of irregularly stratified fibres of cellular tissue interwoven with bloodvessels and nerves.

“Do the conjunctiva sclerotica and the conjunctival pellicle of the cornea also preserve a papillary body or not?” asks Eble,‡ in reference to Valentin’s assertion of one. Eble admits the structure described by Valentin under the name of papillary body between the chorion and epithelium of the conjunctiva bulbi, but thinks, and correctly, that it is a very different thing from the papillary body of the palpebral conjunctiva as described by himself. Valentin’s papillary body of the conjunctiva bulbi is a matter of the microscope—Eble’s papillary body of the palpebral conjunctiva, though minute, is still in some degree cognisable to the naked eye. Hypertrophy of the papillary body of the palpebral conjunctiva constitutes, as has been said, what is called granular conjunctiva. We never see such a granular state of the sclerotic conjunctiva.

The following is Valentin’s description of what he calls the papillary body of the conjunctiva bulbi:—It is best seen in the human eye, “when, after several days’ maceration, the loosened and swollen epithelium is carefully

* 10th Thesaurus.

† Erfahrungssätze über die contagiöse oder ägyptische Augenzündung. Mainz, 1821.

‡ Op. cit. p. 19, 29, pl. i and ii. Or the Belgian-French translation, “De la Structure et des Maladies de la Conjonctive. &c. Traduit de l’Allemand par Ed. de Losen de Seltenhoff, M.D. Publié par ordre du Ministre de la Guerre. Bruxelles, 1836.

* Loc. cit.

† Repertorium für die Anatomie &c. Bd. 1; pp. 142—300. Berlin, 1837.

‡ In medicinischen Jahrbücher des k. k. Oesterreichischen Staates. Neueste Folge, xvi. Band, p. 73.

removed and the papillary body then separated by a shaving cut through the surface of the conjunctiva. The papillæ are seen under a microscope magnifying three hundred diameters, as yellowish red corpuscles standing close together, of an arched conical shape and presenting a round nucleus in their interior. Many of the papillæ have short pedicles. Many present at their extremity a small point or filamentous prolongation which runs towards the epithelium. Henle* thinks Valentin's papillæ are nothing but the corpuscles of the epithelium, presently to be noticed, distorted by the action of the compressorium. It appears to me that Valentin's papillary body constitutes a structure of the same nature as the corpus Malpighianum of the skin. We know that such exists in the sclerotic conjunctiva from the circumstance that in negroes and many of the lower animals it is tinged of a black or brown colour, whilst in Isabella horses and in Swiss races among oxen it appears yellowish.

Epithelium of the conjunctiva. The discovery of a characteristic structure in epithelium enables us to determine its existence even when so delicate as not be separable as a distinct layer. It may appear merely as a tenacious mucus little more than perceptible to the naked eye, but examined under the microscope it is found to consist of minute polygonal cells, flat and containing a central nucleus. These corpuscles aggregated together more or less closely and in greater or less quantity constitute the substance of epithelium. The epidermis is essentially of the same structure; as also the corpus Malpighianum, only when this is coloured, the cellulæ are found to contain colouring particles, as is remarkably the case in the black pigment of the eye, the small hexagonal bodies composing the membrane of which belong to the same category as the corpuscles of the epithelium or corpus Malpighianum.

According to Valentin the epithelium of the conjunctiva consists of rhomboidal or quadrate cells lying close together, the boundaries of which are formed by simple lines. In every cell there is found without exception a somewhat darker and more compact nucleus of a round or largish form. The average diameter of these cells, in the human eye, is about the two-thousandth of an inch. The nuclei are about half the size.

Thickening of the epithelium takes place in ectropium and callous granulations. What is called cuticular conjunctiva is at the same time a general contraction of the whole conjunctiva with a thickened and dry state of the epithelium.

Does the conjunctiva extend over the cornea? Every one admits the existence of a layer on the anterior surface of the cornea, quite different from its proper substance, and apparently a continuation of the conjunctiva covering the sclerótica, but this layer on the anterior surface

of the cornea does not present exactly the same, or at least all, the anatomical and chemical characters as the sclerotic conjunctiva. What of it can be raised is like epidermis or epithelium, coagulated and rendered white by the heat applied to separate it, and moreover it is not vascular, the vessels seen ramifying on the surface of the cornea in some inflammations being situated underneath it.

What is the nature of the superficial layer of the cornea? It is composed of two lamellæ. The more superficial constitutes a very fine but firm epithelium. According to Valentin, after sixteen or twenty-four hours' maceration, the epithelium separates from the cornea. The cells have in this case lost a little in transparency and are somewhat distended. The nuclei appear more or less swollen by the action of the water. The other lamella situated underneath the epithelium is more loose in its cohesion, and is what Valentin considers the same structure as the papillary layer described by him in the ocular conjunctiva. Valentin says that a chorion or fibrous layer does not exist in the conjunctival extension over the cornea. The bloodvessels derived from the sclerotic conjunctiva run merely betwixt the papillary body and the surface of the proper substance of the cornea. They are very delicate and extremely difficult to inject.

Römer* has described the arteries of the conjunctiva corneæ from injections. The fine twigs of the arteries of the sclerotic conjunctiva unite together around the margin of the cornea into a vascular wreath or circle. From this there arise very numerous branches which run from the circumference towards the centre of the cornea, and in their course make two or three very fine subdivisions. Their ends bend distinctly inwards, and appear to penetrate the proper substance of the cornea.

Having thus shown on the surface of the cornea the existence of an epithelium and a structure, called by Valentin a papillary body, similar to what is found on the surface of the sclerotic conjunctiva, as also a stratum of bloodvessels, we must admit a cellular support for those vessels, however delicate. If so, the bloodvessels and cellular tissue would constitute the essential elements of a chorion.† We can only explain the development of those extensions of membrane like sclerotic conjunctiva, over the cornea by supposing an irregular and undue development or hypertrophy of these elements.

The question, "Does the conjunctiva extend over the cornea?" may be considered as answered in the affirmative by the above anatomical demonstration. Morbid anatomy now comes in advantageously with its corroborative evidence. "Nothing is more in favour," says Eble, "of the existence of a con-

* In Ammon's Zeitschrift Bd. v. p. 21, Table 1, Fig. 9 and 11. See also Müller's Archiv, 1836; Jahresbericht, p. 28; and Henle De Membrana Pupillari, &c. Bonnæ, 1832.

† Medico-Chirurgical Transactions, vol. xxi. p. 414, London, 1838; London Medical Gazette, vol. xxiii. pp. 571, 702, 815.

* Symbolæ ad Anatomiam Villorum intestinalium, imprimis eorum epithelii et vasorum lacteorum, p. 8. 4to. Berolini, 1837.

junctional layer on the cornea than the microscopical structure of this membrane, for there is the greatest resemblance between the structure of the sclerotic conjunctiva and the investment of the cornea.* Eble thus retracts the opinion he formerly expressed against the existence of a conjunctival layer of the cornea.

Externally the sclerotica overlaps or encroaches on, more or less, the edge of the cornea. In certain constitutions, and especially in old persons, † I have observed that the overlapping part of the sclerotica is thicker and more opaque than usual—perhaps also encroaching more extensively on the cornea. The conjunctiva covering the overlapping sclerotica, especially when the latter is to any considerable extent, appears in its independent form with its chorion fully developed, and although it adheres to the subjacent overlapping part of the sclerotica very closely by cellular tissue, it by no means presents the same intimate union with the subjacent structure and the same rudimentary state which the conjunctival extension over the transparent cornea has. In an eye before me in which the overlapping sclerotica is to some considerable extent at the upper edge of the cornea, I easily raised up in a fold and then separated by dissection the perfectly developed conjunctiva from over the part. The conjunctiva covering the overlapping part of the sclerotica has a vascular connexion with the latter no otherwise than by the anastomoses of the proper vessels of each—a vascular connexion, which indeed subsists between the sclerotica and conjunctiva elsewhere. The disposition just described is connected with a point in the pathology of the eye, viz. the bluish white ring which is observed to encircle the cornea more or less completely in certain internal inflammations of the eye, and so frequently in what is called arthritic iritis that it has been considered a diagnostic of it, but certainly without just grounds.

Before explaining the cause of the appearance, I would request it to be remembered that the insertion of the ciliary ligament is at some little distance from the apparent margin of the cornea; that the vessels which form the red zone of the sclerotica in the internal inflammations of the eye, and in inflammation of the proper substance of the cornea, are vessels which send branches inwards to the iris, opposite the ciliary ligament, branches outwards to anastomose with those of the conjunctiva, and lastly, branches which, following the original direction, go to be distributed to the proper substance of the cornea. These vessels are not apparent in the healthy state, and one set of them only may become apparent in inflammation. Thus in inflammation of the iris, they will be apparent only as far as opposite the insertion of the ciliary ligament. Between this and the clear part of the cornea is the opaque overlapping part of the sclerotica, which of

course not being in the way of the progress of the vessels towards the inflamed part, remains white as usual, and the cornea not being affected the minute branches to its proper substance remain unenlarged and unseen. Hence the overlapping part of the sclerotica is seen in contrast between the abruptly terminating red sclerotic zone on the one hand, and the transparent cornea (appearing dark on account of the dark structure behind it) on the other, forming the bluish white ring.

From this explanation the bluish white ring round the cornea ought to exist more or less in all internal inflammations of the eye, unless obscured by vascularity of the conjunctiva in inflammation of the cornea. So it does; but in persons of otherwise sound constitution and not of advanced age, the overlapping sclerotica is so transparent and sometimes also to so small an extent, that it is not strongly contrasted by the transparent cornea. It is otherwise the case, however, in certain persons, especially such as are advanced in life, in whom the encroachment of the sclerotica and fully developed conjunctiva on the cornea exists to a great degree and in a very opaque state, that the bluish white ring appears in the exaggerated distinctness which has commonly attracted the notice of surgeons.

The condition of the eye necessary for the distinct appearance of the bluish-white ring round the cornea occurring principally in old persons of bad constitution, and these being the very persons in whom an internal inflammation of the eye very often presents what is called the arthritic character, are circumstances which readily explain the error of supposing the bluish white ring round the cornea diagnostic of arthritic iritis.*

III.—Lacrymal organs properly so called.

Under this head are comprehended: 1. The secreting lacrymal organs, or the lacrymal gland and its excretory ducts. 2. The derivative lacrymal organs, or the passages by which the secretions of the lacrymal gland and of the conjunctival surface are drawn off into the nose, viz. the lacrymal points, the lacrymal canalicules, the lacrymal sac, and nasal duct.

The lacrymal gland and its ducts may be considered as a branched diverticulum of the conjunctiva; the derivative lacrymal organs, to use the expression of M. De Blainville, as nothing but the continuation of the conjunctiva and its anastomoses with the olfactive membrane.

1. Secreting lacrymal organs.

Lacrymal gland,—*Glandula lacrymalis*; Fr. *La glande lacrymale*; Ital. *La glandula lagrimale*; Germ. *Die Thränendrüse*.

When the lacrymal caruncle was supposed to filtrate the *succus lacrymalis*, and the lacrymal points to excrete it, the lacrymal gland was called *glandula innominata*.

The lacrymal gland (*Fig. 13*) consists of two masses, an upper and a lower. The upper mass, or *glandula lacrymalis superior*, lies in the lacrymal fossa, a depres-

* *Medicinische Jahrbücher des k. k. oesterreichischen Staates*; Neueste Folge. Band xvi.

† The *arcus senilis*, it is to be remembered, is not here the question.

* *London Medical Gazette*, vol. xxiii. p. 187.

sion of a size sufficient to receive the point of the thumb, situated in the roof of the orbit at its upper and outer angle, just within the overhanging outer extremity of the superciliary arch. The superior lacrymal gland is of an oval or triangular shape about three-fourths of an inch in its longest diameter and about half an inch across. It is flattened from above downwards. Its upper surface is convex; its lower plane or concave. The thickest edge of the gland is turned outwards. The gland is of a reddish colour and is enveloped in a thin but dense cellular coat. The lower mass of the lacrymal gland, or *glandula lacrymalis inferior*, is a loosely connected aggregation of lobules of the same glandular substance as the above. It was first described by the second Monro, who called the lobules, for distinction's sake, *glandula congregata*.*

The lower mass of the lacrymal gland is smaller than the upper, with which it is in contact above, whilst below it extends to the outer part of the upper margin of the tarsal cartilage of the upper eyelid. It lies indeed in the substance of the upper eyelid at the outer part. It is seen shining through the conjunctiva in everting the upper eyelid.

Fig. 13.



Lacrymal gland, left side.

a a, Superior mass; b b, inferior mass; c, part of inferior mass lying towards the outer canthus.

Intimate structure of the lacrymal gland.—The lacrymal gland is what is commonly called conglomerate. It belongs to Müller's compound glands with canals of the ramified type. "In the arrangement of the secreting canals of the lacrymal glands," says Müller,† "two principal forms are observed: the one is that which I discovered in the chelonian reptiles; the other, that which prevails in birds and Mammalia. In the chelonian, the gland is formed of a number of club-shaped lobes, united together by means of the different ducts which run in their interior. The duct of each lobe is pretty uniform in diameter, and into it open an innumerable quantity of microscopical tufts of cæca, which are arranged around it

* Monro's Observations, Anatomical and Physiological, wherein Dr. Hunter's claim to some discoveries is examined, p. 77. Edinburgh, p. 77. Rosenmuller, Partium Externarum oculi humani, imprimis organorum lacrymalium descriptio anatomica, &c. § 109. Lipsiæ, 1810.

† Handbuch der Physiologie des Menschen, Bd. i. S. 438. Or, Translation by Baly, p. 445. See also "De glandularum secretionum penitiorum structura, p. 51, 52, tab. v. figs. 3, 4, 5, & 8.

at right angles like the foliage of a moss on its stem." In birds, in which the lacrymal gland is very small and situate at the posterior angle of the eye, and Mammalia, the secreting canals of the lacrymal gland are regularly branched and terminate in each acinus in a number of small cells. In birds these cells are very large; and in them, and likewise in the horse, the cells can be filled with mercury from the efferent duct.

Efferent or excretory ducts of the lacrymal glands.—The lacrymal glands pour out their secretion by nine or twelve very slender excretory ducts which proceed from above downwards and open on the surface of the conjunctiva on the inside of the upper eyelid. The orifices of the ducts are placed at about one-twentieth of an inch apart from each other in a row extending about half an inch from the outer canthus inwards, parallel to but a little above the outer part of the upper margin of the tarsal cartilage, that is, at the inferior boundary of the lower mass of the gland.

The excretory ducts of the lacrymal gland were first discovered on the 11th of November, 1665, by Nicolaus Steno,* in the eyelid of a sheep. He delineated them from the eye of the calf. Moreover it appears that Steno describes vasa lacrymalia discovered in man, which opened in the membrane of the upper eyelid.†

Admitted by some and doubted by others from the time of Steno, the ducts of the lacrymal gland became a subject of dispute between Dr. William Hunter‡ and the second Monro,§ the one claiming to have observed them in the human eye before the other.

The best way to demonstrate the ducts is to stretch the upper eyelid, turned inside out, upon the finger; then wipe clean the surface of the conjunctiva, and having by close inspection at the place where the ducts open, as above described, discovered the orifices, take a short piece of human hair in the point of a forceps, and entering it at the orifice, push it on in the direction of the duct. From the orifices on the surface of the conjunctiva the ducts run nearly parallel with each other upwards.

Of two eyes before me I have in this way inserted hairs into nine orifices of ducts in the one and into twelve orifices of the other, a work which did not occupy five minutes for each eye. In both eyes there is one orifice of a duct exactly within the external commissure,

* Observaciones Anatomicæ, quibus varia oris, oculorum et narium vasa describuntur, novique saliva, lacrumarum et mucis fontes deteguntur et novum Bilsii commentum rejicitur. Leidæ, 1662. See also Bibl. Anat. Clerici et Mangeti. Genev. 1699. fol. tom. ii. p. 787.

† Thom. Bartholoni epistolarum medicinalium a doctis et ad doctos scriptarum centuria iii. & iv. Hafniæ, 1667-8. Epist. 53. cent. iv.

‡ Monro's Observations, Anatomical and Physiological, wherein Dr. Hunter's claim to some discoveries is examined, p. 77. Edinburgh, 1758.

§ Dr. William Hunter's Medical Commentaries, p. 1, containing a plain answer to Professor Monro. London, 1762-4.

and another rather within the lower eyelid. See *figs. 12 & 14*.

Fig. 14.

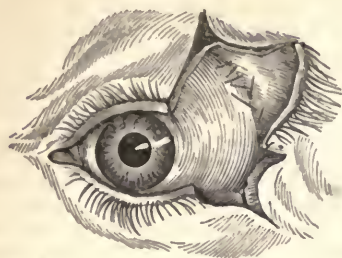

A left eye with the eyelids cut in the middle, and the outer halves everted to show the orifices of the ducts of the lacrimal gland, into which hairs are inserted.

The preceding description of the lacrimal gland and its ducts shows that the latter and the lower mass at least of the former may be readily wounded along with the upper eyelid, and that in Crampton's operation for entropion, the lower mass of the gland, together with some of the lacrimal ducts, must necessarily be wounded, if the eyelid be cut through near the outer angle and to any height. In cases in which I have performed the operation, however, I have not observed any lacrimal fistula or other bad consequence follow.

Tears.—*Lacrymæ*, Fr. *Les larmes*; Ital. *Le lagrime*; Germ. *Die Thränen*. The lacrimal secretion like the salivary appears constantly to flow, though in no greater quantity than is sufficient to moisten the surfaces of the conjunctiva. The derivative lacrimal organs are in this case equal to the removal of it; but when the tears are poured out in unusual quantity, as they are, like the salivary or urinary secretion as well as that of the skin, in certain affections of the mind, they run over the margin of the lower eyelids and drop down the cheeks.

According to Fourcroy and Vauquelin there remains after evaporating the tears, about one per cent. solid substance, which consists chiefly of common salt and a yellow extractive matter perfectly soluble in water. Before drying, this appears quite similar to mucus.

2. Derivative lacrimal organs.

Previously to describing the passages by which the tears are drawn off into the nose, it will be advantageous to take a glance at the osseous groove and canal in which the principal part of those passages is lodged.

Ossous groove for the lodgement of the lacrimal sac. The lacrimal groove, *sulcus lacrymalis*, is situated at the fore part of the inner wall of the orbit. It is directed from above downwards, extending from the junction of the frontal bone with the nasal process of the superior maxillary and with the lacrimal bone, on the one hand, and to the inner and lower angle of the margin of the orbit on the other. Here it runs into the osseous canal for the nasal duct. The lacrimal groove is pretty

deeply scooped out, and is about eight-tenths of an inch long and five-twentieths broad.

The outer aspect of the nasal process of the superior maxillary bone is divided by an ascending ridge, the continuation of that forming the lower margin of the orbit, into two surfaces. The posterior surface, which is the narrower, forms the anterior half of the lacrimal groove. The posterior half of the groove is formed by that narrow grooved part of the orbital surface of the lacrimal bone in front of its vertical crest. The line of junction (*shindylesis*) between the posterior margin of the nasal process of the superior maxillary bone and the anterior margin of the lacrimal runs down longitudinally in the bottom of the groove.

The *anterior margin* of the lacrimal groove formed by the ascending ridge subdividing the outer surface of the nasal process of the superior maxillary bone, is thick and rounded. The *posterior margin*, formed by the crest which subdivides vertically the orbital surface of the lacrimal bone, is thin and sharp.

Inferiorly the crest of the lacrimal bone forms a small curved prolongation directed forwards and outwards, which serves to form the commencement of the posterior wall of the osseous canal for the nasal duct. The process, which is called *hamulus ossis lacrymalis*, articulates with the orbital plate of the superior maxillary.*

The osseous canal for the nasal duct.—The osseous nasal canal, about half an inch in length, extends from the lower extremity of the lacrimal groove to the lowest meatus of the nose, at the anterior part of which it opens. Its orifice is overhung by the anterior extremity of the lowest spongy bone. The osseous nasal canal is directed a little obliquely from before backwards, and from within outwards. It is somewhat narrower in the middle than at either extremity. It is compressed from within outwards, hence a horizontal section is rather elliptical than circular.

The *anterior and outer walls* of the osseous canal are formed by a groove inclined downwards and backwards on the inner surface of the body of the superior maxillary bone, the continuation of that on the nasal process which contributes to form the lacrimal groove. The *posterior wall* of the canal is in great part formed above by the hamular process of the lacrimal bone, where it articulates with the orbital plate of the superior maxillary. The lowest part of the posterior wall is formed by the meeting together of the lacrimal process

* In man the lacrimal bone does not always form a single piece. "In a great number of cases," says M. Rousseau, "the lacrimal bone is found divided into two unequal parts, even in aged subjects. The larger contributes to form the inner wall of the orbit, the smaller is situated below and outside the preceding on the floor of the orbit; its exposed surface does not measure more than two millimetres in extent, but it dips under the vertical crest of the first portion, and contributes to form the lacrimal canal." See "Description d'un nouvel os de la face chez l'homme," in *Annales des Sciences Naturelles*. Paris, 1829.

of the lowest spongy bone and the posterior margin of the groove in the superior maxillary, constituting the anterior and outer walls. The internal wall of the osseous nasal canal is formed superiorly by a continuation of the osseous surfaces composing the lacrymal groove. Below, it is formed, in front, by a farther continuation of one of these surfaces, viz. that of the superior maxillary bone, and behind by a thin plate of the lowest spongy bone, the nasal or lacrymal process of the lowest spongy bone, which rises to join the inferior edge of the lacrymal. The anterior edge of this process of the spongy bone joins the posterior edge of the lower part of the lacrymal surface of the nasal process of the superior maxillary. The line of junction is thus the continuation of that at the bottom of the lacrymal groove.

Lacrymal papilla, points and canalicules.—(Fig. 15.) At the inner extremity of the ciliary

Fig. 15.

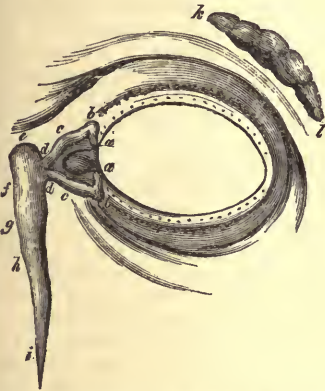

Continuation of Figure 11, showing the relative situation of the upper mass of the lacrymal gland, and the exact shape of the derivative lacrymal passages. (From Soemmerring.)

a, b, c, d, superior and inferior lacrymal canaliculi; *a, a,* lacrymal points; *b, b,* the small blind dilatations presented by the lacrymal canalicules, where they bend inwards to the lacrymal sac; *c, c,* continuation of the lacrymal canalicules; *d, d,* their entrance into the lacrymal sac; *e, f, g,* lacrymal sac; *e,* blind end of the lacrymal sac; *f,* middle part of the lacrymal sac; *g,* its termination; *h, i,* nasal duct; *i,* opening of the nasal duct into the nose.

margin of each eyelid, where the fissure of the nasal canthus begins, there has been already described a small papillary eminence, *lacrymal papilla*, *papilla lacrymalis*, in the summit of which is a small orifice, *lacrymal point*, of such a size as to admit a thick bristle. The lacrymal points, *puncta lacrymalia*; Fr. *Les points lacrymaux*; Ital. *I punti lagrimali*; Germ. *Die Thränenpunkten*; are from their size and situation sufficiently conspicuous as not to be confounded with one of the orifices of the Meibomian follicles. In the natural state the lacrymal papillæ are inclined towards the lacus lacrymalis. The lower papilla is somewhat more prominent than the upper, and situate somewhat more towards the temple. The *lacrymal*

canalicules, canaliculi lacrymales, s. cornua limacum; Fr. *Les conduits lacrymaux*; Ital. *I condotti lagrimali*; Germ. *Die Thränenkanälchen*; lead from the lacrymal points into the lacrymal sac. From the superior lacrymal point the superior canalicule proceeds upwards and outwards within the papilla a little way, then suddenly bending at an acute angle and forming at the same time a small dilatation, it runs downwards and inwards, inclosed in the fold of skin and conjunctiva forming the upper border of the fissure of the nasal canthus, to the lacrymal sac. The course of the inferior canalicule is the counterpart of the above. From the lower point it runs a short way perpendicularly downwards and outwards within the corresponding papilla, then bending abruptly and like the upper forming a small dilatation, it proceeds upwards and inwards, inclosed in the fold of skin and conjunctiva forming the lower border of the fissure of the nasal canthus, to the lacrymal sac.

The canalicules having met each other at the commissure of the fissure of the nasal canthus, pass under the tendon of the orbicularis muscle, and open by separate orifices, close to each other however, into the anterior and outer part of the lacrymal sac. These orifices indeed are separated merely by a duplicature of the mucous membrane composing their walls.

The lacrymal canalicules have pretty firm walls of mucous membrane, which do not collapse, but when cut across are seen gaping open. The calibre of the canaliculi is about the thirtieth of an inch in diameter; that of the points is less, but these are capable of being dilated.

The canaliculi are immediately surrounded by the fibres of the internal palpebral ligament, and those of the tensor tarsi muscle.

Lacrymal sac; saccus lacrymalis; Fr., *Le sac lacrymal*; Ital. *Il sacco lagrimale*; Germ., *Der Thränensack*.—(Fig. 16.) This is a membranous reservoir of a vertically elongated form, and externally compressed, nine-twentieths of an inch long, and two-tenths broad externally.

Fig. 16.



Derivative lacrymal passages of the left side, seen from the side of the nasal cavity.

Here it is seen that the nasal duct is much broader viewed from the side than from before. *a, b,* superior and inferior lacrymal canaliculi; *c, d,* lacrymal sac; *e, f,* nasal duct; *f,* nasal orifice of the nasal duct, seen quite in its natural state.

It lies, by its inner and posterior surface, in the lacrymal groove, with the periosteum of which it is closely incorporated. Its anterior and outer surface, which lies without the groove, is immediately covered by a strong aponeurosis derived from the upper and lower edge of the horizontal tendon of the orbicularis muscle, which passes across the lacrymal sac a little above the centre. This aponeurosis adheres to the margins of the bony groove in which the sac is lodged, and there becomes continuous with the periosteum. More superficially, the anterior and outer surface is covered by the muscular fibres of the orbicularis and by the skin.

Above the lacrymal sac forms a cul-de-sac or blind end,—*finis cacus sacci lacrymalis*. Below it passes into the nasal duct. This transition is marked by a slight contraction, sometimes inside, by a circular fold of the mucous membrane, of which both are formed.

At its anterior and outer part, a little below its upper blind end, and immediately behind the internal palpebral ligament, the lacrymal sac receives the canalicules. Overhanging the orifices of these there is a small semilunar fold of the mucous membrane of the sac.*

The nasal duct; *ductus nasalis*; Fr., *Le canal nasal*; Ital., *Il condotto nasale*; Germ., *Der Nasenkanal*, is a laterally compressed canal, about three-quarters of an inch in length, and readily admitting the passage of a probe the fifteenth of an inch thick, continued from the lower part of the lacrymal sac. It runs downwards, backwards, and a little outwards in the osseous canal already described, of which it is indeed nothing but the membranous lining. The nasal duct is more contracted in its middle than at either extremity. It opens in the anterior and upper part of the lower meatus, at the lateral wall of the nasal cavity, and about one inch from the entrance of the nostril. Its orifice, which is overhung by the lower spongy bone, is a long fissure, oblique from above downwards and from within outwards. The obliquity of the orifice of the nasal duct is owing to the circumstance that the posterior or external wall of the membranous part of the nasal duct descends farther than the osseous canal, and forms, by means of the folded pituitary membrane, a semi-canal, which descends in the external wall of the lower meatus, whilst the internal wall of the membranous part of the nasal duct is shorter, and terminates where the osseous canal stops.

The lacrymal sac and nasal duct are composed of a thick soft mucous membrane, which must be considered as productive of that of the nose. Externally, this mucous membrane is united with the periosteum of the osseous surfaces in connection with the lacrymal sac and nasal duct, and as far as concerns that part of the lacrymal sac not in the osseous groove, by the aponeurosis derived from the tendo palpebrarum.

Internally, the mucous membrane of the lacrymal sac and nasal duct forms various small

plicæ or rugæ. Red and villous, it is quite different from the white and smooth mucous membrane of the canalicules. Like the pituitary membrane of the nose, it secretes, in the healthy state, a clear, mild, fluid mucus.

Lacrymal or tensor tarsi muscle.—Here is perhaps the proper place to notice a muscle which was discovered many years ago by M. Duverney,* delineated and described by Rosenmüller† in 1805, and more recently re-described by Dr. Horner,‡ an American anatomist, with whose name it is now commonly associated.

To get a view of this muscle, Professor Horner directs us to cut through the eyelids and separate them from the ball, except at the inner canthus; then turn the lids over the nose, remove the semilunar fold and the conjunctiva in the neighbourhood, with the fatty matter, when the muscle, such as it is represented in the following description, will be seen.

"The tensor tarsi arises from the posterior superior part of the os unguis, just in advance of the vertical suture between the os planum and the os unguis. Having advanced three lines, it bifurcates; one bifurcation is inserted along the upper lacrymal canalicule, and terminates at its punctum, or near it; and the lower bifurcation has the same relation to the lower lacrymal canalicule. The base of the lacrymal caruncle is placed in the angle of the bifurcation. The superior and the inferior margins of the muscle touch the corresponding fibres of the orbicularis palpebrarum, where the latter is connected with the margin of the internal canthus of the eye, but may be readily distinguished by their horizontal course. The nasal face of this muscle adheres very closely to that portion of the sac which it covers, and also to the lacrymal canalicules. The lacrymal sac rises about a line above its superior margin, and extends in the orbit four lines below its inferior margin. The orbital face of the muscle is covered by a lamina of cellular membrane, and between this lamina and the ball of the eye are placed the semilunar fold of the conjunctiva, and a considerable quantity of adipose matter. As the bifurcated extremities of the muscle follow the course of the canalicules, they are covered by the conjunctiva. The muscle is an oblong body, half an inch in length, and about one quarter wide, bifurcated at one end; and it arises much deeper from the orbit than any acknowledged origin of the orbicularis. The su-

* Œuvres Anatomiques de M. Duverney, tom. ii. 4to., Paris, 1761. After speaking of the fibres of the orbicularis which lie over the lacrymal sac, it is said (tom. i. p. 130), "Entre ces fibres, il y a un petit muscle au dedans du grand angle qui prend son origine de la partie antérieure de l'os planum et s'insère à la partie interne du tendon mitoyen ou commun à l'apposé de l'orbiculaire; c'est un petit muscle que j'ai observé il y a long-temps."

† Rosenmüller, *Icones Chirurgico-Anatomicæ*. Wiemar, 1805. See also Mackenzie in *Medical Gazette*, vol. xi.

‡ *Medical Repository* for July, 1822. See also, *A Treatise on Special and General Anatomy*, by William E. Horner, M. D., Professor of Anatomy in the University of Pennsylvania, &c. vol. ii. p. 496. Philadelphia, 1826.

* Rosenmüller, *op. cit.* § 125.

perior fork, however, has a few of its fibres blended with the ciliaris.*

The action of the muscle appears to be to direct the lacrymal papillæ and points in towards the lacus lacrymalis, and to assist in keeping the edges of the eyelids properly adjusted to the eyeball.

Nerves.—The parts of the organ of vision which have been just described receive their nerves from the fifth and seventh pairs; the former communicating sensibility, the latter the power to move. See articles, FIFTH PAIR OF NERVES, and SEVENTH PAIR OF NERVES.

The first division of the fifth pair gives nerves not only to the accessory parts of the eye, but supplies also the eyeball; hence it is called ophthalmic. The second division of the fifth sends filaments to the lower eyelids.

Nerves from the first division of the fifth distributed to the accessory parts of the eye.—The first division of the fifth pair or the ophthalmic divides into three nerves, the *frontal*, the *nasal*, the *lacrymal*.

1. *Frontal nerve.* The *supra-trochlear* branch of this nerve gives filaments to the upper eyelid and inner canthus. The continuation of the frontal nerve sends filaments to the upper eyelid and external canthus.

2. *Nasal nerve.* The *infra-trochlear* branch of this nerve supplies the parts at the inner canthus, the conjunctiva, the lacrymal caruncle and lacrymal sac; it also gives filaments to the orbicularis palpebrarum. The tensor tarsi* receives two twigs from it. The *infra-trochlear* sends branches upwards, which anastomose with those of the *supra-trochlear*.

3. *Lacrymal nerve.*—After supplying the lacrymal gland the branches of this nerve emerge from it, and ramify in the conjunctiva, orbicularis muscle, and skin of the eyelids. The lacrymal nerve forms anastomoses with other branches of the fifth.

Nerves from the second division of the fifth pair distributed to the accessory parts of the eye.—The principal of these is the *inferior palpebral* branch of the *infra-orbital*. The *inferior palpebral* nerve divides into two branches, an external and an internal, which indeed may be separate from the first.

The external branch runs in the substance of the lower eyelid, distributing branches in its course, to the outer canthus, where it anastomoses with the inferior palpebral filaments of the lacrymal nerve.

The internal branch supplies the part of the lower eyelid towards the nose, and terminates in the parts at the inner canthus, anastomosing with a branch of the *infra-trochlear*.

The facial or portio dura of the seventh pair.—Of the accessory parts of the eye, the orbicularis muscle is that which receives branches from the portio dura of the seventh pair; perhaps, also, the tensor tarsi muscle, as Mac-

kenzie conjectures. These branches of the portio dura freely anastomose with the branches of the fifth pair above described.

To this superficial notice of the nerves of the accessory parts of the eye described in this article, all that requires to be added is, that the levator palpebræ superioris receives its nervous filaments from the third pair.

Bloodvessels.—1. *Arteries.*—The branches of the external carotid ramified on the face and the ophthalmic artery from the internal carotid are the sources from which the accessory parts of the eye receive their arteries.

The branches of the external carotid in the face, viz. the facial, the *infra-orbital* of the internal maxillary, the transverse artery of the face and the temporal send ramifications to the eyelids. Towards the inner canthus the facial ends in the *angular artery*, which anastomoses with the nasal branch of the ophthalmic. The angular artery, or some one of its branches, is implicated in the operation for fistula lacrymalis as it is called.

The ophthalmic artery gives off the *lacrymal*, usually one of its first branches after its entrance into the orbit. The lacrymal supplies the upper and lower masses of the lacrymal gland, besides other parts in the orbit, and at last issues from that cavity at the external angle of the eye. The muscular arteries of the ophthalmic, after supplying the recti muscles, are continued forward on the front of the eyeball—one from the external rectus muscle, and two from each of the other recti. These arteries divide into two sets of branches, of which one set ramify in the ocular conjunctiva, and the other set supply the sclerotica.

The ophthalmic, as it issues from the orbit at the internal canthus, gives off the *palpebral arteries, superior and inferior*. These ramify, in their respective eyelids, towards the external angle, where they meet and inosculate with the terminating branches of the lacrymal artery. The superior palpebral artery, moreover, inosculates with the supra-orbital and anterior temporal; the inferior palpebral artery with the nasal branch of the ophthalmic, the *infra-orbital* and transverse artery of the face, thus forming the *tarsal or palpebral arches*.

The ramifications sent, from the branches of the external carotid in the face, to the eyelids, and those from the ophthalmic, form by their inosculations a network, from which are supplied the different structures of the eyelids, the conjunctiva, the lacrymal caruncle, and the lacrymal sac.

Where the ocular and palpebral portions of the conjunctiva run into each other, bloodvessels from the muscular enter and subdivide into two sets of branches—one set smaller, to the ocular conjunctiva, the other set larger, to the palpebral conjunctiva. The latter receives another and a still larger set, which enter it at the orbital margin of the tarsal cartilages, anastomose with the first set, and ramify forwards to the free margin of the eyelids.

The bloodvessels of the ocular conjunctiva are few and small in comparison to those of the palpebral. They affect a reticular arrange-

* Rosenmüller, *Icones chirurgico-anatomicæ*. Weimar, 1805.

Trasmondi, *Intorno la Scoperta di due Nervi dell' Occhio umano ragguaglio*. Estratto dal Giornale Arcadico, t. xix. p. I. Roma, 1823.

ment, produced partly by the vessels crossing over each other simply, and partly by inosculation. The latter is particularly the case around the cornea. It is only in the inflamed state—in catarrhal ophthalmia—that the vessels of the ocular conjunctiva can be well seen. In catarrhal ophthalmia, large superficial tortuous vessels are observed proceeding in a direction towards the cornea; a few of the same size are seen crossing these, especially at a distance from the cornea. Underneath the large vessels is a network of smaller ones, the branches of the larger. The arrangement of the vessels around the margin of the cornea has been already noticed. It can scarcely be doubted that the large dark-coloured varicose vessels, derived from the muscular, seen in the conjunctiva in the so-called arthritic states of the eye, are veins, as also the largest and most tortuous of those seen in catarrhal ophthalmia.

Of the two sets of vessels distributed to the conjunctiva, one set supplies the conjunctiva forming the palpebral sinuses, the other that part of the conjunctiva which corresponds to the tarsal cartilages. Both sets give off numerous branches, which subdivide very minutely in the papillary body. The second set, after having given off their ramifications to the papillæ, proceed towards the margins of the eyelids; following, in the upper, a straighter and more parallel direction than in the lower.

2. *Veins*.—The veins from the eyelids discharge their blood into the anterior and posterior facial veins.

The blood from the other accessory parts of the eye is returned to the cavernous sinus by the ophthalmic veins, of which there are two to each eye:—one called the *cerebral ophthalmic*, and the other the *facial ophthalmic vein*.

Cerebral ophthalmic vein.—Larger than the facial ophthalmic vein, this begins at the inner angle of the eye, from the upper end of the anterior facial vein. From this it passes backwards through the orbit to the inner part of the superior orbital fissure, by which it enters the cranium, where it empties itself into the cavernous sinus—seldom into the circular sinus. In this course it has several communications with the facial ophthalmic. The cerebral ophthalmic vein receives directly or indirectly, besides the veins from the different parts of the eyeball and its muscles, a vein from the lacrymal sac, and from the parts lying at the inner canthus; the anterior nasal vein, the lacrymal vein, and the posterior nasal vein.

Facial ophthalmic vein.—This receives the infra-orbital and some other deep veins of the face, besides some veins from the eyeball. The deep branch of the anterior facial vein takes one of its origins from it. The facial ophthalmic vein leaves the orbit by the superior orbital fissure, and opens into the cavernous sinus below the cerebral ophthalmic.

Comparative anatomy and development.—In the description just given of the accessory parts of the human eye, allusion has been occasionally made to their structure in the lower animals; here such further observations will be

offered as may tend to illustrate their physiological importance in the animal series.

And first, it may perhaps be well to keep in mind that, although generally speaking, organs, traced from the higher to the lower animals, are observed to become depreciated in development; still that this is by no means always the case in a ratio corresponding to the position of the animal in our classifications. For the circumstances connected with the mode of life of an animal, be it mammal, bird, reptile, or fish, may be such as to call for a greater or less development of some particular organ. Thus, though in the mammifera we find the eyelids very perfectly developed, and in fishes in an extremely imperfect state, or entirely wanting, and though we find gradations between these two extremes in the animals holding an intermediate place, still there exist mammiferous animals in which the integument passes right over the eyeball without forming any palpebral fold; and there are fishes in which there are not only palpebral folds, but also an orbicular muscle. Again, the semilunar fold of man and the higher quadrumana is enlarged in quadrupeds into the membrana nictitans, and in birds forms the very artificially constructed third eyelid, which subsists, though in a less perfect state, in reptiles, but in fishes, where the structure does exist, it is found again reduced to a semilunar fold. In man the lacrymal gland is large. In the lower mammifera generally, in birds, and in the higher reptiles the lacrymal gland is also found. But it is small in proportion to another gland situated at the nasal canthus of the eye, the glandule of Harder, which is developed in a direct proportion with the membrana nictitans, or third eyelid, and to which it therefore belongs. In man and the quadrumana there is no trace of the glandule of Harder. It is incorrect to view the lacrymal caruncle in that light, for both may exist together.

Besides these differences in the development of the accessory parts of the organ of vision observed in the animal series and capable of being generalised, there exist specific and individual differences which can only be noticed in detail.

1. *Eyelids*.

In subterranean mammifera, as the blind rat, the chrysochloris of the Cape, the common mole; among reptiles, in the pipa, which lives in obscure places; and in perennibranchiate batrachia, which inhabit subterranean lakes or marshes, as the proteus and syren; and in fishes which burrow in the mud or sand, as the anguilliform and certain cyclostomatous fishes, the eyes are very small, and the common integument passes right over them without forming any palpebral fold. In the Ophidian reptiles as first pointed out by Jules Cloquet; in Geckoes among the Saurian reptiles, as shewn by J. Müller; and even in the blind rat, according to the latter author, there is a compounding of the simple continuation of the integuments over the eyeball, as described above, with the existence of a conjunctiva underneath, enclosing an oculo-palpebral space. This struc-

ture will be described in speaking of the conjunctiva. In birds there is no example of the eyeball being covered over in a similar manner by a continuation of the skin.

In man the upper eyelid is the more developed and the more moveable. Descending from him the lower is found gradually to assume the superiority in this respect. In the cetacea the upper and lower eyelids are tumid folds of skin enclosing fat, but no tarsus, and the Meibomian glands are entirely wanting. There is no orbicularis palpebrarum muscle, but muscular fibres proceed from the anterior and posterior end of the orbital process of the frontal bone to the eyelids in the region of the outer and inner canthi. Instead of the levator palpebræ superioris there is a hollow conical muscle which arises from the circumference of the foramen opticum and terminates in the eyelids. A similar in four divisions occurs in the seal.* In the ebidna there is a circular eyelid. In birds the lower eyelid is in general very much larger and more moveable than the upper. In the ostrich and some parrots both eyelids are equally moveable.

In birds the eyelids are closed in death. In the gallinaceous birds which I have examined this appears to be owing to an expansion of elastic membrane attached to the margin of the orbit and interlaced round the eyelids. During life the lower eyelid is opened by muscular action by a proper *depressor* muscle. The upper eyelid retains its levator. There is a tarsal cartilage in the lower eyelid; in the upper eyelid there is a less dense fibrous structure. The skin of the lower eyelid is naked and finer than that of the upper in accordance with its greater mobility.

In chelonian reptiles the lower eyelid is, as in birds, the larger and more moveable; and as the more moveable the eyelid the finer the integument, so in them the lower eyelid is naked as in birds.

In lizards the eyelids form a sort of sheet stretched before the eyeball with a horizontal fissure closed by a circular muscle and opened by a levator and depressor. In the chameleon the palpebral fissure is represented by a small hole opposite the pupil. Tracing the eyelids in a general way from batrachian reptiles to fishes, we find a gradual depreciation of structure; thus salamanders have two folds of skin, upper and under, for eyelids, but not sufficient to cover the eyeball, whilst the pipa has none. In fishes generally, the skin before passing over the front of the eye becomes finer and forms a slight circular fold, often only well-marked above. Sometimes there is an anterior and a posterior semilunar fold, as in the herring, salmon, but especially in several of the shark tribe. It is the *Orthogoriscus mola* which has circular folds for eyelids, and an orbicular muscle for closing them. The eyelids are again opened by five radiating muscles.

* Rapp, Die Cetaceen Zoologisch-anatomisch dargestellt, Stuttgart and Tübingen, 1837, quoted from Müller's Jahresbericht, p. cxx. in Archiv, 1838.

Among the invertebrata some of the cephalopoda have large palpebral folds. In the octopus "the eyes are small in proportion, and the skin is drawn over them so as to cover them entirely at the will of the animal."* There are no eyelids in the *sepia officinalis*, but a continuation of the integuments passes over the eye.

Eyebrows and eyelashes occur only in a few mammalia. Eyelashes exist in the pachydermata, ruminants, &c. but are wanting especially in small mammals. Meibomian glands are commonly found.

In birds the eyelids sometimes present cilia. This is the case only in some birds of prey, in some parrots, in the ostrich, &c. but seldom in other orders. Very small Meibomian follicles are said to exist in the eyelids of birds. In the eyelids of a common fowl at present before me, there are small transverse fissures on the margin of the lids filled with a sebaceous matter. They have the appearance of very small Meibomian glands, not closed as in the mammifera, but open along their whole length.

In a preceding part of this article I remarked on some points of resemblance between the iris and eyelids, as regards functions, and sympathy in the performance of those functions. In some of the lower animals there are certain points in which they even approximate in form. In connexion, therefore, with the subject of the eyelids it will not be out of place to allude to that flocculent growth of the uvea hanging from the upper margin of the iris over the transversely elongated pupil in the horse, &c. and which appears to serve the purpose, if it may be so expressed, of an internal eyelid. An analogous but more curiously and highly developed structure—a blending as it were of the iris with some remains of the structure of the eyelids—exists in the eyes of several fishes; among others in the skate.

The structure alluded to is a digitated extension of the whole substance of the upper part of the iris, hanging over the pupil, which it is large enough entirely to cover. There being no intrinsic power of motion in the iris of fishes, the mechanism by which this digitated veil is drawn up from over the pupil is this:—Where the upper part of the ciliary margin of the iris is connected with the sclerotica, the latter is very flexible and is externally intimately connected with a fold or rudimentary eyelid which the integument forms before passing as conjunctiva over the eye. Muscular fibres are inserted into this fold at the point of connexion, and draw it upwards; the flexible part of the sclerotica of course follows this movement and the upper part of the iris, the sclerotica, so that the digitated veil is drawn up from over the pupil. In a young skate which I removed from the egg and preserved alive for some weeks, I observed that the digitated veil was kept down during the day, but was drawn up toward evening, and the large black pupil exposed.

* Cuvier, Regne animal, vol. iii. p. 12, Paris, 1830.

2.—*The conjunctiva.*—*Semilunar fold, membrana nictitans or third eyelid.*—*Lacrymal caruncle and glandule of Harder.*

The existence of eyelids supposes a conjunctiva,—that is, the integument modified into a mucous membrane lining the posterior surface of the eyelids, covering the front of the eyeball, and thus connecting these two parts together. In those animals in which there is no palpebral covering either in the usual form of eyelids, or in that anomalous form in which there is no palpebral opening, there is, properly speaking, no conjunctiva: at the most, the common integument may be softer, thinner, and more transparent where it covers the eye.

The points deserving particular notice in the comparative anatomy of the conjunctiva are,

1. The oculo-palpebral space of the conjunctiva.

2. The membrana nictitans and third eyelid, with the glandule of Harder.

In most animals the oculo-palpebral space of the conjunctiva is as it has been described in man. Serpents have been generally regarded as being without eyelids and *viæ lacrymales*. The eye, indeed, has been commonly described as covered by a transparent lamella of epidermis, which is cast with the rest of the epidermis; and this has been often adduced as an argument in favour of the extension of the conjunctiva over the cornea in other animals. Serpents have a palpebral covering, a conjunctiva and *viæ lacrymales*; but the conformation of these parts is quite peculiar. For the first true exposition of the point we are indebted to Jules Cloquet.*

In the article HEARING, ORGAN OF, at the end of the section on the parallel between the ear and the eye, it is said, "A part in the composition of the appendages of the eye analogous to the membrana tympani is only to be conceived by supposing the existence of a *mediate anchylo-blepharon*, that is, an irregular membrane stretched between the edges of the eyelids, uniting them together, and closing in the space lined by the conjunctiva, which space would now communicate with the exterior only by the lacrymal canalicules and nasal duct, in the same way that the tympanic cavity communicates with the exterior only by the Eustachian tube." The *mediate anchylo-blepharon* here supposed is the *actual and regular structure* in serpents, and is the sole cause of the apparent anomaly in the conformation of their eye appendages. The structure is this:—

Around the margin of the orbit the skin appears as if it formed a palpebral fold, covered with scales, and representing a sort of frame, in which is set, as it were, a transparent continuation of the skin before the front of the eye. But this is not the conjunctiva; it is a *natural mediate anchylo-blepharon*, or a palpebral covering without palpebral fissure. It is, however, transparent, and was therefore formerly confounded with the cornea. A conjunctiva lines the inner surface of this palpebral covering

without palpebral fissure, and invests the greater part of the orbital cavity, from which it is reflected on the sclerotica, and is from thence continued over the cornea, closely adhering to it.

The conjunctiva thus forms a sac (called by Jules Cloquet oculo-palpebral sac of the conjunctiva), confining a space (which may in like manner be called oculo-palpebral) into which open the excretory ducts of the lacrymal gland. From it the tears are drawn off by a canal between the jaw and palate bone into the mouth, of which more will be said farther on.

Fig. 17.

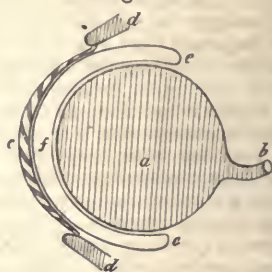

Vertical section of the eye of the common viper, to show the disposition of the conjunctiva. (From Jules Cloquet.)

a, the eyeball; b, the optic nerve; c, the eyelid; d, d, the scales surrounding the eyelid, and into which it appears as if enchased; e, e, folds and cul-de-sac formed by the oculo-palpebral conjunctiva on being reflected from the orbital cavity upon the eyeball; f, cavity of the oculo-palpebral sac of the conjunctiva.

From the above description it will be readily understood how it is from the palpebral extension of the skin that the epidermis falls when the skin is said to be cast, and not from the conjunctiva.

Muller* has found the above structure in all true serpents, even in the amphibœnæ, whose eyes are covered with thick skin. I do not know if it has been observed in cœcilia also. He has found a similar structure among the saurian reptiles in the geckoes, even in the genus *phyllurus*. He has even found it in a mammal, *spalax typhlus*,† the eyes of which appear to be covered by the thick hairy skin, underneath which, however, there is a small sac of conjunctiva. In the chameleons, which follow the family of the geckoes, in Cuvier's arrangement, there is a near approach to the same structure, the palpebral covering presenting only a very small palpebral opening opposite the pupil.

The membrana nictitans and third eyelids.—In the quadrumana, as in man, the conjunctiva forms at the nasal canthus a simple semilunar fold, but larger. In the other mammifera, including the herbivorous cetacea, and ex-

* Ueber eine Merkwürdige Eigenthümlichkeit im Bau der Augen und Thränenwerkzeuge bei den Geckonen. In Ammon's Zeitschrift, Bd. i. p. 179.

† Handbuch der Physiologie des Menschen, Zweiten Bandes Zweite Abtheilung, S. 313. Coelentz, 1838.

* Memoire sur l'Existence et la Disposition des Voies Lacrymales dans les Serpens. Paris, 1821.

cepting only the true cetacea, this fold is developed into the *membrana nictitans*, which is disposed vertically within the horizontal eyelids at the nasal canthus, and is capable of being pushed more or less towards the temporal canthus, over the front of the eyeball.

The *membrana nictitans* derives firmness from a thin plate of cartilage, which has sometimes a sort of pedicle passing backwards by the inner side of the eyeball. In the sheep, for example, the cartilage of the *membrana nictitans* is of the shape of the letter T. The cross top forms the margin of the membrane; and the leg, closely embraced by the glandule of Harder, extends backwards between the eyeball and inner wall of the orbit. The cartilage of the *membrana nictitans*, unlike the tarsal cartilages, is true cartilage, with nucleated corpuscles.

In the elephant it is said there is a muscular arrangement for carrying the *membrana nictitans* outwards over the front of the eyeball. I think I have observed in the rabbit that the *membrana nictitans* receives part of the expansion of the levator of the upper eyelid. The *membrana nictitans* has not, however, like the third eyelid of birds, any proper muscular apparatus; and when it is moveable, the motion is produced by the eyeball, on its being retracted deeper into the orbit by the retractor muscle, which displaces and presses forwards the cartilaginous pedicle above described.

The structure called semilunar fold in man, and *membrana nictitans* in quadruped mammifera, has attained its greatest development in birds, in which it is called the third eyelid. It is transparent and capable of covering the whole front of the eyeball. Enclosed in the conjunctival reduplication there is a fibro-cartilaginous structure, very thin and membranous. Of a triangular form, the third eyelid has its free margin oblique from above downwards, and from without inwards. In the state of repose it is retracted and folded vertically in the nasal angle of the eye. The third eyelid is drawn over the front of the eye by a very peculiar mechanism consisting of two muscles, the slender tendon of one of which runs through an elongated loop in the broad free end of the other. This muscular apparatus is supplied by the *nervus abducens*.

The *quadratus* is a broad thin trapezoidal muscle. It arises from the upper and posterior part of the eyeball, behind the prominence of its largest circumference. From this point its fibres, which form a thin but broad fleshy belly, descend towards the optic nerve, converging somewhat. It then terminates abruptly in a free tendinous margin, close to the upper part of the optic nerve. In this free tendinous margin, which is considerably narrower than the origin, there is an elongated loop or canal, in which the tendon of the other muscle plays.

Pyramidalis muscle.—The fleshy part of his muscle is comparatively smaller. It arises by a broad curved base from the lower part of the eyeball, opposite the preceding. In its ascent towards the optic nerve, the muscle becomes contracted, and at last ends in a slender

tendon on the nasal side of the optic nerve. The tendon immediately enters the pulley-canal in the extreme margin of the *quadratus*, and in traversing it turns round the upper part of the optic nerve. Thus changing its original direction, it passes downwards on the temporal side of the optic nerve to the lower part of the eyeball, round the prominent circumference of which it turns to get to the front of it, when it immediately enters the lower angle of the third eyelid. Having entered, it divides into two parts, one of which expands and runs between the layers of conjunctiva, forming the third eyelid, to the nasal angle of the eye; the other passes along and forms the pretty firm free margin of the eyelid in question. Having traversed the whole margin of this and arrived at the upper part of the eyeball, it is inserted into the sclerotica just at the middle of the line whence the *quadratus* derives its origin. It is by this arrangement that the superior angle of the third eyelid is attached to the sclerotica, and consequently rendered immovable.

By its own elasticity the third eyelid remains retracted at the nasal angle of the eye. In this state its tendinous margin is relaxed; but when the two muscles just described contract, the tendon of the *pyramidalis* is drawn straight, and the third eyelid is thus stretched over the front of the eye.

“From this curious disposition of the muscles,” says Dr. Porterfield,* “it is easy to conceive, how this internal eyelid is extended over the cornea far enough to cover all the pupil, though the muscles themselves are contained in a small space. Every body knows, that the contraction of all muscles is only in a certain given proportion to their length; and therefore that the eyelid might be drawn far enough over the cornea, nature was obliged to make use of a long muscle, which could not be contained in so small a place as the orbit, without being bent or inflected; and therefore the one muscle is bent upwards near the optic nerve, making an acute angle, where it passes through the perforated end of the other muscle, by which means its action is greatly increased. But its action is yet more increased by the contraction of the square muscle itself, which must draw the cord or tendon of the pyramidal muscle which passes through it, through a space double of what it moves itself; and thus the *membrana nictitans* is extended far enough to cover the whole cornea though its muscles are contained in a small space.”

In Owls Nitzsch discovered a small bone on the lower surface of the bony ring of the sclerotica, *ossiculum tuberculare*, for the support of the long tendon of the *pyramidalis*. In parrots the third eyelid is small.

Among reptiles there is in chelonia and lizards a third eyelid much the same as in birds, but smaller and less moveable. It is moved only by a single muscle analogous to the *pyramidalis* of birds. “An allied structure,” says Müller, “is a spectacle-like transparent part in the lower eyelid of some lizards,

* On the Eye, vol. i. p. 34. Edinburgh, 1759.

as several scinci, which may be drawn over the eye without interrupting vision, the cornea corresponding to it." This is the structure in the frog; for what Cuvier admitted as a third eyelid is horizontal instead of vertical, and, as Carus has shown, nothing more than the lower eyelid. In the frog the upper eyelid follows the motions of the eyeball. The lower eyelid has independent motion; admitting of being drawn over the eye and falling into a fold when this is open.

The anterior and posterior semilunar folds in certain fishes have been already alluded to.

The glandule of Harder.—The glandule of Harder belongs peculiarly to the membrana nictitans or third eyelid; it therefore does not exist in man and the quadrumana. The lacrymal caruncle is not the representative of it, as is asserted in Dr. Grant's Treatise on Comparative Anatomy, for both may exist together. I do not even know if it is correct to say that the two structures are developed in an inverse ratio, for in the sheep, in which the glandule of Harder is of considerable size, the caruncula is absolutely as great, if not greater, than that of man. Even among the hare kind, which have the membrana nictitans and glandule of Harder much developed, I find, particularly in the rabbit, a trace of lacrymal caruncle as scattered follicular grains along with small hairs at the inner canthus. It is only in birds that we lose all trace of the lacrymal caruncle.

The glandule of Harder is situated in the orbit between its inner wall and the globe of the eye. In the sheep, for instance, the glandular substance is collected around the cartilaginous pedicle of the membrana nictitans, on the inner surface of which it opens by two or three small ducts. In the elephant, in which the lacrymal gland is said to be wanting, or very small, the glandule of Harder is said to be very large. It opens between the membrana nictitans and the eyeball by an opening the size of a quill. In the hare kind, as has been said, the glandule of Harder is immense. It presents two lobes, and its duct opens in a wide lacuna within the membrana nictitans. According to Müller,* the elementary particles or ends of the ducts are minute vesicles everywhere equal and joining in the manner of branches into irregular oblong lobes. The excretory duct at the external surface of the gland opposite the eye is divided in the bilobed glandular mass into a great number of smaller ducts, which divaricating are joined each to a branch of the lobules.

In birds the glandule of Harder is commonly much more considerable than the lacrymal gland. It lies as usual at the nasal canthus and opens within the third eyelid towards the eyeball. There is never any caruncle. Müller tells us the glandule of Harder in birds is easily injected with mercury after its secretion has been all pressed out. The surface of the organ is divided into many smaller lobes. The internal ramification of the ducts does not appear to be complicated.

* De glandularum discernentium penitiori structura, p. 51, tab. v. fig. 6 and 7.

In reptiles the glandule of Harder is smaller than the lacrymal gland.

The secretion of the glandule of Harder is a thick transparent viscid matter.

III. *Secreting and derivative lacrymal apparatus.*—The development of the lacrymal gland and of that of Harder is generally in an inverse ratio. It would appear that the derivative lacrymal apparatus is more in relation with the lacrymal gland than with the glandule of Harder, as it is much developed in man, in whom there is no glandule of Harder, and, as is reported, it is wanting in the elephant, in which the glandule of Harder is said to be very large. The lacrymal gland exists in man, apes, sapajous, and snakes, but no glandule of Harder. In all other mammifera there is both a lacrymal gland and a glandule of Harder. In proportion as the latter enlarges the former becomes smaller. Among the cetacea, the dolphin possesses a lacrymal gland which surrounds the eyeball like a ring. Its excretory ducts, which are numerous, open on the inner surface of both upper and lower eyelids. The derivative lacrymal apparatus is wanting; in this respect, seals and walrusses agree with the cetacea.* Other mammals, as moles and shrewmice, are said to present no trace of lacrymal apparatus. In the elephant, small glandular grains the size of a pea are said to represent the lacrymal gland. Camper says the hippopotamus has no puncta, from which may be inferred the absence of any lacrymal passage into the nose. The elephant is also said to want the derivative lacrymal apparatus.

In birds the lacrymal gland is small, and lies at the posterior angle of the eye, either towards the roof or the floor of the orbit. The derivative lacrymal organs in the common fowl, for instance, consist of two large lacrymal points, the upper the larger, and a membranous canal leading into the nose.

In reptiles, the lacrymal gland lies behind the eyeball, and is of considerable size, especially in harmless serpents. According to Duverney, the lacrymal gland in one species of typhlops is six times larger than the extremely diminutive eyeball; but even in poisonous serpents, the viper for instance, it is large.

The sauria and chelonia have for the most part both a lacrymal gland and a glandule of Harder, the former the larger. Batrachia want the lacrymal apparatus.

In serpents the secretion of the lacrymal gland is poured into the oculo-palpebral space, from which a lacrymal duct leads. In the colubri there is, in the fore and lower part of the oculo-palpebral space, a hole or round pore, in some individuals seen with difficulty, very distinct on the contrary in others, and which may admit a bristle. This is the lacrymal point; it is single and is continuous with a very slender membranous duct, semi-transparent, which forms the lacrymal canal. This, in harmless serpents, opens into a large pouch communicating with the mouth in front

* Rapp. l. c. Rapp describes, in the Cetacea, scattered grains of lacrymal gland, which open on the conjunctiva near the eyeball.

of the palatine branch of the upper jaw. Cloquet* calls this pouch intermaxillary sinus or sac. In venomous serpents, the lacrymal canal opens, as in the mammifera, in the external wall of the nasal fossæ.

There is no lacrymal apparatus in fishes.

In the description of the lacrymal gland in man, the intimate structure of it in the lower animals has been already alluded to. The remark of Müller may be repeated here, that similar glands have often a perfectly different structure in different animals; of which the lacrymal gland examined in the chelonia, birds, and mammifera affords an example.

The lacrymal bone contributes to separate the orbit from the cavity of the nose. It is wanting in certain mammifera, as the phocæ and most cetacea. It is enormously developed, on the contrary, in certain others, as the giraffe, stag, &c. It exists also in birds, and forms in them often the greatest part of the inferior margin of the orbit. In reptiles, its existence is variable. It is found in crocodiles. It is absent in the chelonia, ophidia, and batrachia. It is also wanting in fishes, unless the first infra-orbital be assumed as analogous to it.

In ruminating animals, remarkably so in deers and antelopes, the infra-orbital fossa of the superior maxillary bone is very large, and is lined by a reflection of the skin, more or less in the form of a sac. The skin, which has assumed the characters of a mucous membrane, contains in its substance numerous follicles, which secrete a thick blackish unctuous humour—a secretion which appears to have some relation with the sexual function. This matter has been improperly called *tears*, hence the French name *larmiers* of the infra-orbital glandular sacs of ruminants. In the sheep these organs are represented by a mere fissure extending on the side of the nose from the nasal canthus. Meckel compares to this structure the foveæ in the face, behind the nostrils, of several poisonous serpents, such as the rattle-snake; but the membrane lining these parts scarcely appears to secrete anything. The temporal gland of the elephant seems to be of the same nature as the infra-orbital glandular sacs of ruminants.

Development of the accessory parts of the eye.—The accessory parts of the eye appear subsequently to the eyeball, and, as is the case with the accessory parts of the organ of hearing in reference to the labyrinth or ear-bulb, have quite a separate and distinct origin from it. That the development of the accessory parts of the eye is independent of that of the eyeball is confirmed by the anomalous conformation which the organ has been sometimes found to present; thus Malacarne relates a case in which the eyeballs, their nerves and muscles were wanting, whilst the lacrymal apparatus and eyelids were regularly developed.

Up to the eighth week the external integu-

ment passes quite smoothly over the eyeball. The conjunctiva is then partitioned off by the formation of a linear fold, which, in the ninth week, surrounds the anterior surface of the eyeball like a small ring. The upper and lower parts of the fold progressively enlarge until they meet each other over the eyeball, which takes place about the twelfth week.

The progress of the development of the eyelids is sometimes arrested, so that mere folds of skin have been found occupying their places, or, development having proceeded a little further, the eyelids have been found presenting their regular conformation indeed, but too short to cover the eyeball and incapable of motion.

Having met, the edges of the eyelids adhere by the extension of the epidermis from the one to the other. In the human embryo the adhesion between the eyelids by the extension of the skin ceases towards the latter months, but the edges continue sticking together by the Meibomian secretion until the period of birth. In the young of several of the mammifera, as the carnivora and rodents, the eyelids continue closed for some time after birth—from one to two weeks. In birds, even in the embryo state, the eyelids never unite.

Sometimes adhesion between the eyelids in the human subject is found at birth, constituting what is called *congenital anchyloblepharon*; and this may be either immediate or by the intervention of a membranous structure.

The closure of the pupil by the pupillary membrane in the fœtus corresponds to the adhesion of the eyelids to each other at that period. According to Meckel the pupillary membrane continues entire in animals born blind, as it is expressed, as long as the eyelids remain closed.

The tarsal cartilages first appear distinctly in the fifth month; and at birth, that of the upper is perfectly developed. The eyelashes first appear free about the sixth month.

The lacrymal gland is already evident in the last half of the fourth month.

The inner canthus of the eye is at first more elongated than it is afterwards.

On the first appearance of the eyelids, Burdach tells us, the lacrymal caruncle presents itself; and at the inner angle a diverticulum of the conjunctiva sinks down to the oro-nasal cavity as the commencement of the lacrymal sac and nasal duct. The lacrymal points project very much in the fifth month, and in the seventh are somewhat more retracted. The lacrymal apparatus in general, as also the Meibomian follicles, are proportionably much developed at an early period.

BIBLIOGRAPHY.—See that of article **EYE** and the several works referred to in the course of this. The most complete, indeed, so far as I know, the only monography, is that of John Christian Rosenmüller, "*Partium externarum oculi humani imprimis organorum lacrymalium descriptio anatomica, iconibus illustrata.*" Lipsiæ, 1810. In this will be found a catalogue raisonné of all preceding works bearing on the subject.

(T. Wharton Jones.)

* Op. cit.

† Burdach, Die Physiologie, als Erfahrungswissenschaft, &c. and Valentin, Entwicklungsgeschichte.

LARYNX. Syn. Gr. *λαρυγξ*, from *λαρυγγίζω* (clamo); Fr. *Larynx*; Germ. *Kehlkopf*; Ital. *Laringe*.—The larynx is a complex piece of mechanism resembling a kind of box, (*piris cava*,) composed of an assemblage of cartilages, the density and elasticity of which serve to protect its more delicate tissues, and to allow the free transmission of air for respiration. It is also exquisitely adapted for the production of voice.

The larynx is situated in the mesial line, and opens superiorly into the pharynx, and inferiorly into the trachea. It occupies the anterior superior part of the neck, immediately below the os hyoides, and before the pharynx, which lies between it and the vertebral column. In front it is very superficial, being covered only by the sub-hyoidean muscles, and the common integuments.

It admits of various kinds of motion: 1, those of elevation and depression parallel to the long axis of the body; 2, those complex movements within it which take place during respiration and the production of vocal sounds.

The larynx considered with reference to the trachea, presents an enlargement denominated

the *caput aspera arteriæ*, or the head of the trachea. The absolute volume of the larynx varies with the age and sex of the individual: its magnitude is much more considerable in men than in women; in the former it acquires an extraordinary development at the age of puberty. In eunuchs, however, this enlargement does not take place.

The larynx does not represent any regular geometrical figure; it may be defined as an irregular, inverted, truncated cone, whose sections at the apex and base are elliptical, but approaching nearly to a circle at its junction with the trachea.

This organ is perfectly symmetrical, which, however, applies to one of its sections only, viz. that of its mesial plane, or axis major; consequently, all the others must be unsymmetrical: the section made at right angles to it, or in its axis minor, gives the relative situation of its internal mechanism, as in *figs. 18* and *19*, which should be carefully studied, with reference to the physiology of this organ.

Fig. 18.

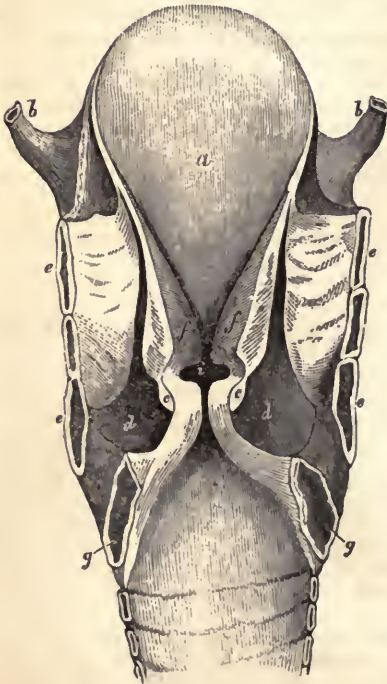

The anterior transverse section of the larynx and trachea. *a*, the epiglottis; *b, b*, the horns of the os hyoides; *c, c*, the inferior thyro-arytenoid ligaments (*chordæ vocales*); *d, d*, the thyro-arytenoid muscles; *e, e*, section of the thyroid cartilage; *f, f*, the superior boundaries of the ventricles; *g, g*, section of the cricoid; *h*, the trachea; *l, l*, the ventricles.

Fig. 19.



The posterior view. The letters *c, d, e, g, h*, represent corresponding sections of the same parts; *b, b*, the arytenoid cartilages invested by mucous membrane; *n*, the pharynx laid open.

The larynx is composed of several structures, which may be classed as follows: 1, the cartilages; 2, the ligaments; 3, the muscles; 4, the mucous membrane; 5, the mucous glands; 6, the arteries and veins; and, lastly, the nerves.

The cartilages of the larynx are nine in

number,* of which three are single and unsymmetrical, the epiglottis, thyroid, and cricoid; two are placed laterally, and form a pair, called the arytenoids. Upon the summits of these are found two minute cartilaginous bodies, termed *cornicula*; the remaining two (which, however, are not always present) are situated anterior to the arytenoids, and involved in the aryteno-epiglottic folds, named the *cuneiform cartilages*.

The cricoid cartilage. Gr. κρικος, a ring, εἶδος; Lat. *Cartilago annuliformis*; Fr. *Cricoïde ou annulaire*; Germ. *Ringknorpel*; Ital. *Cricoidè*.—This cartilage, situated at the base of the larynx, which it supports, is the thickest and strongest of the whole assemblage of cartilages. It is connected to the first ring of the trachea by elastic ligaments and mucous membrane. Its form, that of a ring, is not quite circular, but approaching to an elliptical figure. It is shallow in front, at *c, e*, (*fig. 20.*) but it is thicker and deeper than the first ring of the trachea; and, posteriorly, it is considerably deeper than at its anterior part, in the proportion of eight to two and a-half.

Fig. 20.

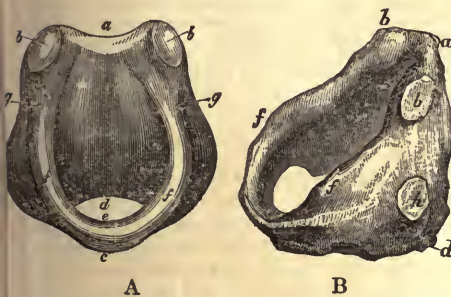

A, an anterior, B, the side view of the cricoid cartilage; *a*, the posterior superior margin; *b, b*, the crico-arytenoid articulating surface; *b, g, f, e*, the superior descending margin; *d, e*, the tracheal aperture of the cricoid; *a, d*, the greatest, *a, c*, the least depth of surface; *a, e*, the obliquity of the superior section to the axis; *h*, the left surface articulating with the inferior cornua of the thyroid cartilage.

The anterior external surface gives attachment to the crico-thyroid muscles (see *fig. 26*); more posteriorly we find an apophysis for the articulation of the thyroid (*h, fig. 20, B*). Its posterior surface is divided into two equal portions by a vertical ridge along its middle line, *a, d, fig. 20, B*. This ridge, which was first noticed by Galen, gives attachment to some longitudinal fibres of the œsophagus. On each side of it a concave surface is observed, which gives origin to the crico-arytenoidei postici, *e, e, fig. 27*.

The internal surface is smooth, and lined by the mucous membrane of the larynx. The inferior margin is horizontal, and nearly circu-

lar; but the superior, which is bevelled obliquely inwards and upwards, about *c, e*, (*fig. 20.*) ascends backwards in the direction of *e, f, g, b*, (*fig. 20.*) being slightly curved downwards between *f* and *g*. The anterior superior outline of this cartilage presents that of the section of a cylinder, whose obliquity to its axis is in the direction *a, e*, and therefore is elliptical. It recedes anteriorly from the lower margin of the thyroid cartilage in the direction of *g, f, e*, (*fig. 20.*) leaving an interval called the crico-thyroid space, *a*, (*fig. 20, B.*) which is occupied by the crico-thyroid ligament; on each side, in the lines *e, f, g*, by the lateral ligaments, and more posteriorly by the crico-arytenoidei laterales, in the space *f, g*, to the external side of *b* (*fig. 20*).

The posterior superior margin is horizontal on each side of *a*, (*fig. 20.*) and parallel to the inferior at *d*, having at *b* and *b* an oblong, oblique, and slightly cylindrical surface, inclined upwards and outwards for the articulation of the arytenoid cartilages. These surfaces are considered by Willis as "portions of cylinders, whose axes are inclined both with respect to the horizontal and vertical sections." In the vertical section, the projection of this articulating axis is in the position *G, C*, (*fig. 28.*) and in the horizontal, in the line *O, P*, (*fig. 30.*) Between these surfaces is a slight depression for the insertion of the arytenoid muscles.

The thyroid cartilage. Syn. Lat. *Cartilago scutiformis*; Fr. *Thyroïde*; Germ. *Schildknorpel*.—This cartilage derives its name from θυρεος, a shield, and εἶδος, form. It embraces the cricoid in a manner analogous to the carapax of the tortoise. It is formed to protect the internal mechanism of the larynx, both in front and at both sides, but is open behind. It serves

Fig. 21.

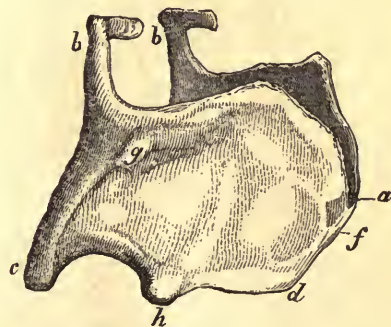

An angular view of the thyroid cartilage. *a*, the notch; *b, b*, the superior cornua; *c, c*, the inferior cornua; *g, g*, the superior tubercles; *h, h*, the inferior tubercles; *e, e*, the wings of the thyroid; *i, a, i*, the superior margin; *h, d, h*, the inferior margin; *a, d*, the mesial line; *f*, the pommel.

as a fulcrum and lever for the action of several muscles. It is composed of two quadrilateral laminae uniting in front at the mesial line (*a, d*,

* Galen describes only three, χωνδρος θυρεοειδης, χωνδρος θυρεος, χωνδρος α,υταινοειδης.

fig. 21): the angle of union becomes more acute as it approaches towards *d*. The prominence of this angle on the mesial line constitutes what is called the *pomum Adami*, which is more developed in the male than in the female sex, and becomes more conspicuous after the age of puberty; it may be readily felt in the living subject. On the four posterior angles of the thyroid are situated four cornua, or horns; two superior, *b, b*, and two inferior, *c, c*, (fig. 21); they appear mere prolongations of the posterior margins; the superior being longer than the inferior are called the great horns; they are articulated to the os hyoides by ligaments, which allow a motion for the approximation and recession of the larynx to and from the os hyoides. The inferior horns are shorter, curved forwards, and articulated at their extremities to the cricoid by oblique planes, directed forwards and inwards. On each wing of the thyroid there are two tubercles, one on the superior, and the other on the inferior margin (*g, g*, and *h, h*, fig. 21). The superior tubercles are the largest. A small ridge passes obliquely across the external surface of the wings from *g* to *h*, extending from the base of one tubercle to the other, dividing each wing into two unequal segments, of which three-fourths are anterior and superior, and one-fourth posterior and inferior to the ridge. The anterior margin of the ridge gives attachment to the hyo-thyroid, and lies under the sterno-hyoid muscles, and the posterior to the inferior constrictor of the pharynx and sterno-thyroid muscles.

The posterior or hollow surface of the angle formed by the junction of the alæ of the thyroid gives attachment on each side to the mesial line to the thyro-arytenoid ligaments (*chordæ vocales*) and muscles. The wings are concave internally for the lodgement of the thyro-arytenoidei and crico-arytenoidei laterales muscles, and give attachment at their posterior margins to the membrane of the pharynx.

The superior margin of each wing is curved in the line *i, a, i*, (fig. 21,) and gives attachment in its whole length to the thyro-hyoid membrane: it is deeply notched at *a*, immediately above the *pomum Adami*. It is less deep, and more broad and round in women than in men.

Near the superior tubercles there is a notch, sometimes a foramen for the transmission of the superior laryngeal nerve. The inferior margin of the thyroid is nearly horizontal, and is shorter than the superior: there is a slight prominence at *a*, (fig. 21,) to which is attached the crico-thyroid ligament. Between the inferior tubercles at *h, h*, (fig. 21,) and the inferior cornua, the lower margin is arched rather deeply. The posterior surface and margin of the wings of the thyroid are ridged, and give attachment to several muscles; it rests against the vertebral column, which forms a base to the arc of the thyroid, and protects the internal structure of the larynx.

The arytenoid cartilages. Syn.: Gr. *αρυταινοειδης*, Galen; Lat. *Cartilagine* ary-

tenoideæ; Fr. *Cartilages arytenoïdes*; Germ. *Giessbeckenknorpel*.—The arytenoid cartilages are two very irregularly formed bodies, situated on the articulating surface of the posterior, inner, and upper margin of the cricoid, (*b, b*, fig. 20,) in such a manner as to resemble the mouth of an ewer; hence their name. They may be considered of a triangular or pyramidal figure, having their bases spread out, (*a* and *a*, fig. 22,) and presenting surfaces for the attachment of ligaments and the action of muscles. We observe, 1, on their posterior aspect, triangular concave surfaces, between *f* and *e*, (fig. 22,) occupied by the oblique and transverse arytenoid surfaces. 2. Anteriorly, convex, triangular surfaces, *d, b*, (fig. 22,) with

Fig. 22.



A side view of the arytenoid cartilages. *a*, the base and position of the crico-arytenoid articulating grooves; *b, c*, the posterior concave surface; *c*, the lateral prominence; *f*, the corniculum laryngis; *g*, the vertical portion of the cuneiform cartilage.

ridges, (*b*, fig. 27,) for the attachment of the superior thyro-arytenoid ligaments. 3. Laterally, cavities for the insertion of the thyro-arytenoid muscles, and lodgment of the cuneiform cartilages, (*g*, fig. 22). 4. Internally, surfaces reciprocally parallel, lined with mucous membrane, which permit their close approximation. 5. Bases, on which are oblique, curved, oval grooves, *a* and *a*, (fig. 22,) corresponding to the articulating surfaces of the cricoid; there are also on each of these bases two prominences, one lateral, (*c*, fig. 22,) which gives attachment (*l*, fig. 27,) to the crico-arytenoideus lateralis and posticus muscles; the other anterior, giving attachment (*V*, fig. 29) to the inferior thyro-arytenoid ligament. The latter prominence projects over the vocal tube one-fifth of an inch in the male, and one-seventh in the female. On the summit of the vertical prominences (*f, f*, fig. 22) is situated a small appendage called *corniculum laryngis*. The arytenoid cartilages have extensive freedom of motion, consisting of a rotatory, round the articulating axis of the cricoid, *O, P* (fig. 30); and a sliding motion, transverse to their axis of articulation about the point *B* (fig. 30).

The cornicula laryngis.—Syn. *Capitula Santorini*; *tubercles of Santorini*; *cartilagine* *corniculis*; *Santorinischer Knorpel*, Germ. These are two very small cartilaginous bodies first described by Santorini, from whom they derive their name. Their figure is nearly triangular with a flat smooth surface at their bases, articulated with some freedom of motion to the apices of the arytenoid cartilages. They

lengthen the arm of the vertical lever of the arytenoid, and yield to any oblique force directed upon them.

The *cuneiform cartilages*, (Syn. *cartilaginee cuneiformes*, seu *Wrisbergianae*;) are two small cylindrical cartilaginous bodies, situated immediately in front of the vertical prominence of the arytenoid cartilages in the fold of mucous membrane *g*, (fig. 22.) They present a vertical and horizontal prominence in the shape of the letter L, and partake of the form of the arytenoid cartilages. They are not always present, and their existence in man is denied by Cruveilhier;* this however is an error. Both Cuvier† and Wolff‡ have confounded them with the cornicula or cartilages of Santorini. In the *Quadrumana* they are conspicuous, having the superior vocal ligaments attached to their bases, and they appear afterwards to connect them with the arytenoid cartilages. The cuneiform cartilages are sometimes described by Cruveilhier and other writers (though inaccurately) as the arytenoid glands. They serve as a link of connection between the arytenoid cartilages and superior ligaments.

The *epiglottis*, from *επι*, upon, *γλωττα*, the tongue. Syn. *κληθρον*, Hipp. § *Ligula*, Gal. *Operculum*, Cic. || *Cartilago epiglottidis*. *Epiglottis*, Fr. *Kehldeckel*, Germ. The epiglottis is a cartilaginous valve, situated at the base of the tongue, and covering the opening of the larynx. The direction of the epiglottis is vertical, except during the act of deglutition, when it becomes horizontal. In form it has been compared to a cordate leaf, (fig. 23,) or that of the artichoke. The dimensions vary with the volume of the larynx. The anterior aspect of the epiglottis is convex, the posterior concave; it is partly free and partly connected: the free portion projects above the level of the base of the tongue. It is lined by the mucous membrane: the centre of its superior margin is very slightly notched. Inferiorly it terminates by a kind of pedicle, very thin and delicate, which is attached to the angle of the thyroid immediately above the plane of the thyro-arytenoid ligaments. Numerous foramina are observed, perforating its substance (*ff*, fig. 23), rendering the structure of this cartilage less dense than that of the thyroid or cricoid cartilage. It is considered to be more brittle, in consequence of the cohesion of its particles being affected by these perforations. Its elasticity, however, is augmented by each perforation admitting some fasciculi of the yellow elastic ligament which is expanded, and, as it were, rivetted on its anterior aspect. In the larger Ruminantia, such as the ox, this structure is very conspicuous, the thickness of the elastic tissue being nearly equal to that of the epiglottis itself. This ligament is disposed so as to secure permanently the return of the epiglottis after its de-

Fig. 23.

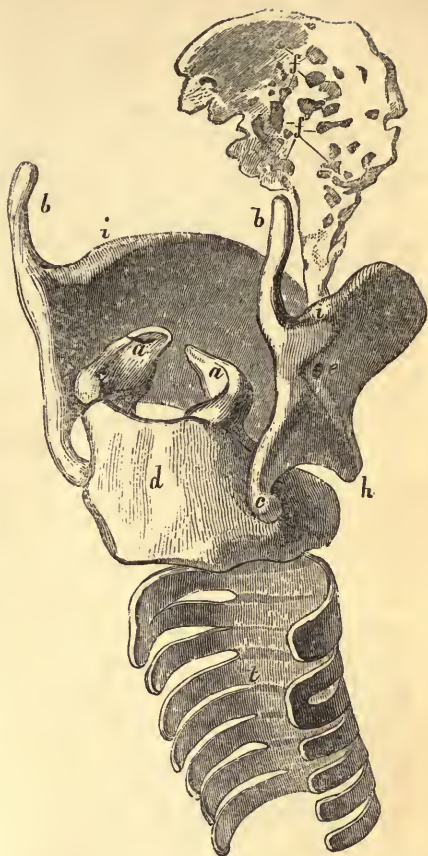

A posterior angular view of the cartilages of the larynx, exposing the rugged and perforated structure of the epiglottis after the removal of the mucous membrane and the yellow elastic ligamentous tissues. (Drawn from a preparation in the Museum of King's College, London.)

a a, the arytenoid cartilages; *b b*, the superior cornua; *c*, the right inferior cornu; *d*, the posterior surface of the cricoid cartilage; *e*, the foramen for the transit of the superior laryngeal nerve; *ff*, the perforation of the epiglottis; *i*, the superior margin of the thyroid; *h*, the right inferior tubercle.

pression in the act of deglutition, independently of any muscular fibres. Its perforations have been described as giving lodgement to "muciparous follicles," but their office seems not to have been hitherto thoroughly investigated.

Articulations and ligaments of the larynx.—The articulations are divided, first, into those connecting the larynx with surrounding structures, called extrinsic articulations; and, secondly, those peculiar to the larynx itself, termed intrinsic articulations.

Extrinsic articulations.—The hyo-thyroid

* Anat. Descript.

† Leçons Anat. Comp.

‡ De organo vocis Mammalium.

§ In Lib. Morb. 1.

|| De Nat. Deor. ii. p. 54.

articulation. The thyroid cartilage is united to the os hyoides by three ligaments: the middle and two lateral. 1st. The ligamentum thyro-hyoideum medium is a lax yellow tissue arising from the superior margin of the thyroid, and inserted into the inner margin of the os hyoides; it is thicker and denser at its middle part; its lateral borders are involved with the surrounding cellular membrane. The anterior surface in its middle is situated immediately under the integuments, having its sides covered by the thyro-hyoidei muscles, (*g*, *fig. 25*) and its posterior surface corresponding with the form of the epiglottis. 2d. The ligamenta hyo-thyroidea lateralia are small round ligaments on each side of the larynx, connecting the tubercles of the great horns of the os hyoides with the extremities of the superior cornua of the thyroid cartilage (*c c*, *fig. 24*). In the substance of these ligaments there are often found small osseous or cartilaginous bodies.

The articulations of the thyroid cartilage

Fig. 24.



A mesial section of the larynx, from Lauth. The mucous membrane and muscles are removed to expose the elastic ligaments.

a, the epiglottis; *b*, the hyo-epiglottic ligaments; *c c*, the lateral thyro-hyoid ligaments; *e*, a portion of the glosso-epiglottic ligament; *f*, the crico-thyroid ligament; *g i*, the junction of the crico-thyroid, and lateral crico-thyroid ligament; *n'*, the attachment of the lateral crico-thyroid ligaments to the base of the arytenoid cartilage; *n*, the elastic ligament lining the bottom of the ventricles; *o*, the superior inner margin of the cricoid cartilage; *s*, the lateral ligamentous connection with the inferior vocal cord; *t*, the superior vocal cord; the right arytenoid cartilage.

with the os hyoides are furnished with synovial membranes.

The ligaments of the epiglottis.—The epiglottis gives attachment to three ligaments, which contribute to its elasticity and the stability of its position.

1. The *ligamentum thyro-epiglottideum* arises from the mesial line below the notch of the superior angle of the thyroid, and is inserted into the base of the epiglottis. It binds the epiglottis to the thyroid cartilage. 2d. The *ligamentum hyo-epiglottideum* arises from the inner surface of the base of the os hyoides; its fibres passing horizontally are inserted into the anterior surface of the epiglottis; its action tends to keep the position of the epiglottis permanently vertical. 3d. The *ligamentum glosso-epiglottideum* arises from the base of the tongue; it lies in the median mucous folds between the tongue and epiglottis, and is inserted into the anterior surface of the epiglottis immediately above the ligamentum hyo-epiglottideum. Its action is nearly the same as that of the last-named ligament, but it is also connected with the motions of the base of the tongue.

The tracheo-cricoid articulation.—The lower margin of the cricoid cartilage is articulated with the first ring of the trachea by a series of the same ligamentous fibres which connect the rings of the trachea with each other. At the anterior mesial base of the cricoid there are found additional ligamentous fibres. The elastic tissue which connects the larynx with the trachea permits considerable freedom in the multiplied movements of the neck without impeding the regular transmission of the atmosphere. In these movements the first ring of the trachea passes within the inferior margin of the cricoid cartilage.

The intrinsic articulations of the larynx are, 1st, the crico-thyroid; 2d, the crico-arytenoid. Besides these may be included the articulation of the arytenoid with the cartilages of Santorini. The cuneiform cartilages are generally unarticulated in man.

The crico-thyroid articulation.—The inferior cornua of the thyroid are curved forwards and inwards. Their extremities present oblique planes directed inwards and downwards, which are firmly attached by a capsular ligament to the oblique discs on the sides of the cricoid, directed upwards and outwards.

The ligament of this joint is of an orbicular form, radiating in oblique fasciculi, the posterior fibres of which extend nearly to the crico-arytenoid articulation.

The crico-thyroid ligament. Syn. *Pyramidal, or conoid ligament.* Lat. *Ligamentum crico-thyroideum.* Pr. *Membrane, ou ligament thyro-cricoidien moyen.* The crico-thyroid ligament is a very thick, strong, yellow elastic ligament, arising from the mesial line of the inferior margin of the thyroid; it then crosses the crico-thyroid space, and is inserted into the superior margin of the cricoid. This ligament supports the anterior part of the cricoid cartilage, and

trachea in conjunction with the crico-thyroid muscle. The nature and position of the articulation of the thyroid, with the cricoid, render the force of this ligament of great utility and importance.

The *lateral crico-thyroid ligament*, *lig. crico-thyroid laterale*, arises immediately at the side of the crico-arytenoid articulation. Some fasciculi, according to Cruveilhier and Lauth, are attached to the bases of the arytenoids, others are reflected horizontally forwards to the inferior margin of the cricoid. It is bounded externally by the thyro-arytenoideus and crico-arytenoideus lateralis, and lined internally by the mucous membrane of the larynx.

The *crico-arytenoid articulation*.—The oblique articulating convex surface of the cricoid is received in a corresponding channel or groove at the base of the arytenoid cartilage. The ligament arises from the cricoid, and radiates both anteriorly and posteriorly round the base of the arytenoid cartilage; a fasciculus is reflected along the base of its anterior membrane behind the attachment of the thyro-arytenoid ligament. The crico-arytenoid ligament is thick and strong, yet sufficiently loose to permit a diversity of motion. Some anatomists divide the ligament into anterior and posterior. The articulation is lined and lubricated by a synovial membrane.

The *thyro-arytenoid ligaments*. *Syn. Chordæ vocales*, Ferrein. *Stimmbänder*, Germ. These ligaments, as their name implies, connect the thyroid with the arytenoid cartilages, and are instrumental in the production of voice. There are on each side two vocal cords, a superior and an inferior; the cavities between these ligaments are termed the ventricles of the larynx. The inferior thyro-arytenoid ligaments, or, as they are often denominated, "the true ligaments of the glottis," are much thicker and stronger than the superior: they present the form of nearly rectangular parallelograms, and are stretched horizontally across the long axis of the larynx, from the anterior horizontal tubercle of the arytenoids, to the angle formed by the junction of the wings of the thyroid (*c*, *fig.* 27). On their outer side these ligaments are connected with the thyro-arytenoid muscles; their anterior extremities are inserted into the thyroid, the posterior to the arytenoid cartilages; the internal margins are free to vibrate. On exposing them by the removal of the mucous membrane they are found less than their apparent volume. Immediately after death they are semi-transparent, very elastic, and composed of parallel fibres. They are connected with, and form a continuation of the ligamentum crico-thyroideum lateralis (*k*, *fig.* 24). The length of the vocal ligaments varies with the general dimensions of the larynx: in the adult male they are much longer than in the female. In infancy they are very short, and increase from that period to the age of puberty in an arithmetical ratio. Thus, if at one year old their length in parts of an inch is 0,2500, at five years they will be 0,3333, at nine 0,4166, and at fourteen 0,4999: these are close approximations.

The superior thyro-arytenoid ligaments or superior vocal cords are, in contra-distinction to the inferior, denominated (though incorrectly) the false ligaments: they are of less thickness and strength than the inferior ligaments, and are further removed from the axis of the larynx (*l*, *fig.* 24). They arise from the internal angle of the thyroid, and are inserted into the middle of the anterior superior prominence of the arytenoid cartilages (*fig.* 24); they are composed of a few slender fasciculi of elastic fibres, approaching less nearly the mesial plane than the inferior ligaments; they appear more prominent, in consequence of their forming the roof of the ventricles. They are in the same plane as the aryteno-epiglottic muscle, and are connected with the fibres of the lateral crico-thyroid ligaments.

According to M. Lauth there is a connexion between the crico-thyroid, the lateral crico-thyroid, and thyro-arytenoid ligaments by three fasciculi, one of which is vertical, one horizontal, and one ascending (*g*, *k*, *n*, *fig.* 24), the first of these being the crico-thyroid; the second the lateral; the third connects the thyro-arytenoid with the superior thyro-arytenoid ligaments, and lines the bottom of the ventricles. M. Lauth considers also that the thyro-epiglottic, the hyo-epiglottic, and glosso-epiglottic ligaments are composed of the same elastic tissue. Müller and Cruveilhier concur in these views. They certainly appear of the same colour and texture under the microscope, and undergo the same change by exposure to the atmosphere: they also possess the same cohesive elastic properties. The strength of the inferior thyro-arytenoid ligaments is so great that they will tear away the cartilage to which they are attached without being injured, and will support the force of many pounds weight.

Muscles.—The motions of the larynx are exceedingly complex, and are performed by two sets of muscles, which are divided into two classes:—1, the extrinsic; and, 2, the intrinsic muscles. The muscles which elevate the larynx are the digastrici, stylo-hyoidei, mylo-hyoidei, genio-hyoidei, and hyo-glossi, and those pharyngeal muscles which are inserted into the cricoid and thyroid cartilages. The muscles which antagonize these and lower the larynx are the sterno-hyoidei, the omo-hyoidei, the sterno-thyroidei, and the thyro-hyoidei. The os hyoides is the centre of motion for the action of these muscles. (See NECK, MUSCLES OF THE.) We shall here confine our description to the

Intrinsic muscles of the larynx, *Syn.*; *muscles intrinsiques*, Cruveilhier.—The muscles of this division comprise those acting exclusively on the larynx itself. There are four pairs and one single: 1, the *crico-thyroidei*; 2, the *crico-arytenoidei postici*; 3, *crico-arytenoidei laterales*; 4, *thyro-arytenoidei*; and, 5, *arytenoideus*, which, from a difference in the direction of certain of its fibres, is divided into the oblique and transverse. Independently of these, there are some muscular fasciculi, named the *thyro-epiglottidei* and the *aryteno-epiglottidei*.

The *crico-thyroidei*.—These are very short,

thick, almost quadrangular-shaped muscles, situated on each side of the anterior part of the larynx: they arise from the anterior and inferior surface of the cricoid cartilage, on each side of the median line. The fibres are fleshy: the most internal directed obliquely upwards and outwards (*m*, *fig. 25*), the central very

Fig. 25.

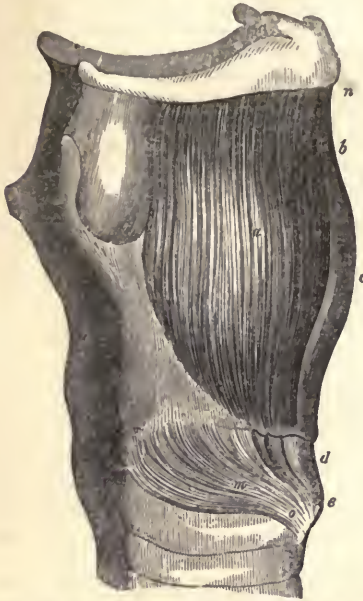

A side view of the larynx with the os hyoides attached. *a*, the thyro-hyoideus muscle; *b*, the middle thyro-hyoid ligament; *c*, the pomum; *d*, the crico-thyroid ligament; *m*, the crico-thyroid muscle; *O N*, the direction of the inferior fibres of the crico-thyroid lying nearly perpendicular to the axis of the crico-thyroid articulation; *f*, the trachea; *n n*, the insertion of the thyro-hyoid muscle and membrane to the inner margin of the os hyoides.

obliquely, and the inferior almost horizontally to the inferior margin of the thyroid and to the inferior horn: others are inserted into the posterior surface of the thyroid. A portion of this muscle is prolonged to the inferior constrictor of the pharynx.

Each crico-thyroid muscle is covered by the sterno-thyroideus, and lies external to the crico-arytenoid lateralis and the thyro-arytenoideus. The triangular space between the crico-thyroidei is occupied by the crico-thyroid membrane.

The action of the crico-thyroidei is to rotate the cricoid on the thyroid. The superior and middle fibres are at the greatest distance from the axis of rotation (*N*, *fig. 26*), and consequently acting as if at the arm of a long lever. In this action the anterior superior margin of the cricoid is elevated towards the inferior edge of the thyroid from *f* to *f'* (*fig. 26*), by which the posterior upper margin of the cricoid is carried backwards from *B* to *B'* indicated by the dotted line 1, 2, 3, 4, 5, (*fig. 26*), and as the space is greater from *A B'* than *A B*, it is manifest that the space in the mesial plane

Fig. 26.

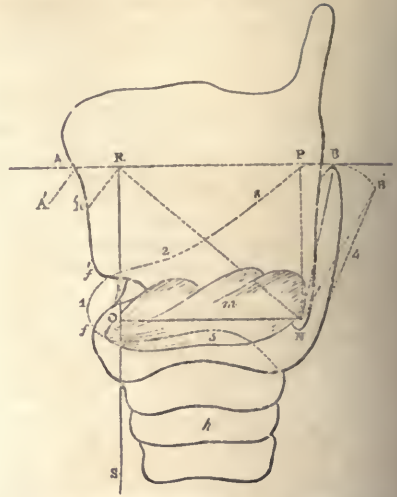

A view of the left side of the larynx to illustrate the functions of the thyro-arytenoid, the sterno-thyroid, and crico-thyroid muscles.

The dotted line 1, 2, 3, 4, 5, shows the position of the cricoid cartilage when the crico-thyroid muscles have closed the crico-thyroid space; *m*, the crico-thyroid muscle; *N*, the crico-thyroid articulating axis; *A B* and *B A*, the directions of the force of the thyro-arytenoideus muscle; *R S*, the direction of the force of the sterno-thyroideus muscle meeting that of the thyro-arytenoideus in *R*; *R N*, the resultant of the combined muscular forces *R P* and *R S*; *O N* and *P N* are perpendicular lines drawn from the directions of the forces of the thyro-arytenoideus and sterno-thyroideus muscles to the common axis of rotation; they are also the cosines of the angles *R N O*, *R N P*, and *B N P*, and show the amount of force on the axis of the sterno-thyroideus and thyro-arytenoideus muscles respectively; *R'* and *A'* are the points which *R* and *A* must pass through when the thyroid is rotated forwards on the cricoid; *A*, the point opposite which the thyro-arytenoideus is inserted into the posterior angle of the thyroid cartilage; *B*, the point on which the thyro-arytenoid acts in rotating *B* towards *A*; *f f'*, the crico-thyroid space; *H*, the trachea.

must be enlarged to an amount equal to the difference of the distance *A B* and *A B'* (*fig. 26*). The action of this muscle, therefore, is to stretch the thyro-arytenoid ligaments. The direction of the force of the inferior horizontal fibres of the crico-thyroid which are lying parallel to the line *O N* (*fig. 25* and *26*) being nearly perpendicular to the axis of rotation, can have, consequently, little or no effect, until the superior fibres have (by raising the cricoid) produced an angle with the axis *N* (*fig. 25*); they assist only when the crico-thyroid space is diminished. It has been commonly supposed that it is the thyroid which is drawn forwards on the cricoid, and Cruveilhier adopts this supposition; but it has been refuted by Magendie, and not only do we observe that the attachments of the crico-thyroidei are mechanically directed to produce a rotatory motion of the cricoid, but the latter has no fixed point of

Fig. 27.

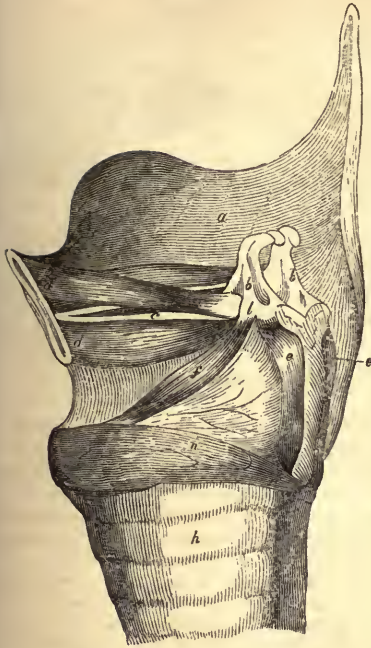

A side view of the larynx, the left wing of the thyroid and the mucous membrane removed, and the fibres of the arytenoid muscle depressed to expose the ligaments and chink of the glottis.

a, the internal surface of the right wing of the thyroid; *b b*, the arytenoid cartilages; *c*, the thyro-arytenoid ligament; *d*, the thyro-arytenoideus muscle; *d'*, the thyro-arytenoideus superior vel minor; *e e*, the crico-arytenoidei postici; *f*, the crico-arytenoideus lateralis; *n*, the cricoid cartilage; *h*, the trachea; *l*, the external prominence of the arytenoid cartilage.

attachment or muscles appropriated to fix it as a fulcrum for motions in an opposite sense.

The *crico-arytenoideus lateralis* is an irregular quadrilateral muscle, arising from the superior margin of the cricoid, from thence passing upwards and backwards, (*f*, *fig. 28*). It is inserted into the posterior surface of the external prominence of the arytenoid cartilage by a tendon common to it and the thyro-arytenoid muscle. It is deeply seated under cover of the thyroid cartilage and crico-thyroid muscle. The action of this muscle has caused much diversity of opinion. Cowper, Haller, Magendie, and others consider that it opens the glottis; but Bichât and Söemmering that it closes it. Its action has, however, been mechanically solved in the following manner by Willis. The arytenoid cartilage is loosely fixed to the cricoid by ligaments already described at *B* (*figs. 28 and 29*). The direction of the force of this muscle is represented by the line *N X* (*fig. 30*), having its point of insertion into the cricoid about *X*. The fibres in passing thence to the arytenoid (*f*, *fig. 28*) lie nearly parallel to the projection of the axis of motion, *G C*; the tension of this muscle in the direction *N X* (*figs. 29 and 30*)

Fig. 28.

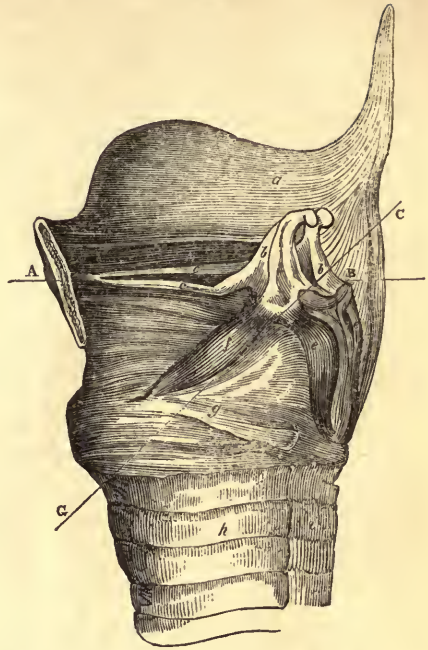

A section of the larynx similar to that of *fig. 27*, with the thyro-arytenoideus muscle removed to give a full view of the thyro-arytenoid ligaments, and the rima glottidis lying in the direction of *A* and *B*.

The line *G C* is the vertical projection of the crico-arytenoid articulating axis; *c c*, *f*, *g*, *h*, represent the same parts as in *fig. 27*.

tends to bring *N X B* into the same straight line and approximate the point *V* to the mesial plane; and as *N* is above the line joining *B X*, it will depress *N* and still more *V*, because the cartilage turns on the articulating surface beneath *Q*. The action, therefore, of this muscle is to approximate the anterior arytenoid prominences and depress them.

The *arytenoideus* (obliquus and transversus). Modern anatomists consider this as one muscle, but owing to the obliquity of the fibres of one of its fasciculi with respect to the other, some have made a division of it into arytenoideus obliquus and a transversus. It is a very short thick muscle, occupying the concavities on the posterior surface of the arytenoid cartilages and the interval between them. It consists of two layers; the superficial layer, which is composed of the oblique fibres, which arise from the base of the right arytenoid, and crossing the fibres of the deep-seated layer, are inserted into the summit of the left arytenoid cartilage: this is the *arytenoideus obliquus* of Albinus. The deep-seated layer is thicker and stronger than the superficial; its fibres, which are directed transversely from one arytenoid to the other, constitute the arytenoideus transversus of Albinus. The arytenoid muscle is covered posteriorly with mucous membrane, which is connected to it by loose cellular substance, in which some mucous follicles are found; anteriorly it

corresponds with the posterior surfaces of the arytenoid cartilages, and is connected by some muscular fibres and membrane with the superior margin of the cricoid cartilage and with the whole length of the internal margins of the arytenoid cartilages. The immediate effect of the contraction of the arytenoid muscles is to approximate the posterior internal surfaces of the arytenoid cartilages, but their action, at the same time, tends to separate the anterior prominences, and to open the chink of the glottis. To counteract this effect the action of the crico-arytenoideus lateralis is called simultaneously into play, and the joint effect of these two muscular forces, represented by the lines N X and N Y (*fig. 30.*) produce a resultant in the direction of W N; hence the crico-arytenoideus lateralis and the arytenoideus muscle acting together tend to close the glottis posteriorly.

The thyro-arytenoideus.—This is one of the most important, most complicated, and perhaps least understood of any of the muscles of the larynx. It arises from the side of the angle of the thyroid cartilage, occupying about two-thirds of its height, and reaches within two or three lines of its superior margin. The central fibres are directed horizontally backwards and outwards, slightly inclined upwards, and inserted into the prominence and concavity on the lateral surface of the arytenoid (*l*, *fig. 27.*) The superior fibres terminate in the external ridge of the arytenoid; some of them pass round the arytenoid, and enclose the arytenoid muscle like a sphincter.* The inferior fibres which arise near the median plane (*k*, *29*) are inserted, at a greater distance from it, into the arytenoid cartilages (*f*, *fig. 30.*); some external fibres are directed more eccentrically

Fig. 29.

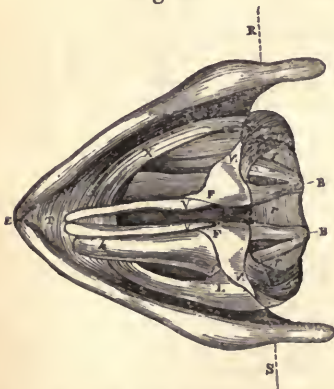

A view of the larynx from above. (From Mr. Willis.)

The mucous membrane is removed to shew the ligaments and muscles of the glottis. N F, N F, the arytenoid cartilages; T V, the vocal ligaments; N X, the right crico-arytenoideus lateralis, the left is removed; X v I, the ring of the cricoid capable of rotating on the axis R S; e e, the crico-arytenoidei postici; E, the junction of the wings of the thyroid.

* Lauth, Mem. de l'Acad. de Méd. 1835.

Fig. 30.

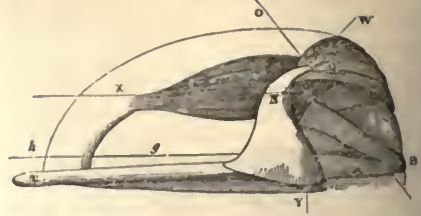

A portion of *fig. 29* enlarged to demonstrate the direction and result of the forces of the muscles of the larynx.

O P, the horizontal projection of the axis of articulation; T V, the vocal ligament; g h, the direction of the force of the thyro-arytenoideus; N X, of the crico-arytenoideus lateralis; N W, of the crico-arytenoideus posticus; N Y, of the arytenoideus transversus.

upwards and backward, corresponding to the superior ligaments and ventricles, where, according to Lauth, they terminate without reaching the arytenoid. Some fibres of the thyro-arytenoid take an oblique direction backwards and downwards, arising immediately below the superior internal margin of the angle of the thyroid, and are inserted into the vertical prominence of the arytenoid cartilage; they are sometimes detached from those passing horizontally, as in *d*, (*fig. 28.*) constituting the thyro-arytenoidei superiores of Albinus, but they are sometimes described as one muscle.

The thyro-arytenoideus corresponds to the internal surface of the thyroid cartilage, from which it is separated by some loose cellular and adipose tissue. Internally it is in contact with the inferior vocal ligament, which lies in contact with the thickest part of this muscle, the bulk of which causes the vocal ligaments on each side to project towards the mesial line and contracts the aperture of the larynx. Some anatomists consider that the thyro-arytenoid ligaments consist of nothing more than the tendons of these muscles; it is not difficult, however, to prove the contrary by dissection.

The functions of the thyro-arytenoidei, concerning which there has been much diversity of opinion, produce several changes in the relative position of the internal mechanism of the larynx, and therefore they require rigid investigation. The effects of these muscles may be considered, first, with respect to the tension of the vocal ligaments; secondly, to the aperture of the glottis. We observe that the points of attachment (at *d d'*, *fig. 27.*) of the thyro-arytenoid are situated within those at A B, (*fig. 28.*); and, as the arytenoid cartilage is tied by ligamentous fibres to the point B, it follows that the contraction of this muscle will draw upon the point B, through the interposed arytenoid cartilage: if A be made the fixed point, the contraction of this muscle will draw the point B towards A by rotating the cricoid on the thyroid. If, on the contrary, B be fixed, then A will approach B by the rotation of the thyroid on the cricoid. In both these cases the distance from A to B is diminished, and as the vocal ligaments are situated in a direct line

passing through A and B, this muscle must consequently relax them.

The closing of the anterior and central portion of the glottis by these muscles, or that part lying between T and V (*fig. 29*), is effected, according to Mr. Willis, partly by the approach of the point V of the arytenoids towards T arising from the obliquity of the axis of rotation, and partly by the swelling of the muscle whilst contracting to approximate the arytenoid cartilages tending to fill the space T N X V (*fig. 29*), and to close tightly the sides of the passage below the vocal ligaments; thus closing the anterior and central portions of the glottis.

The question as to how A is made a fixed point, in the above demonstration, remains to be solved. Mr. Willis remarks that while all writers agree that the crico-thyroidei serve to approximate the cricoid cartilage to the thyroid, either by raising the cricoid or by depressing the thyroid, none of them have shown how the cartilages are to be separated again. Let us investigate this proposition. In order that the motions necessary to dilate the crico-thyroid space be effected by muscular motion, it is obvious that A must be made a fixed point, so that B' may be drawn to B (*fig. 26*), by which *f'* ascends to *f*, the object in question (*fig. 26*). It is clear that the crico-thyroid muscle cannot be employed in this instance, as it has been already shewn that its action is to force B to B' and *f'* to *f*; whereas we have now to reverse the direction, and to bring back B' to B, so that *f'* may descend to *f*. The sterno-thyroidei are the only muscles, which by their origin, insertion, and direction of force are calculated to effect this purpose; the insertion of one of these muscles being about the point R at an angle with the axis R N (*fig. 26*), its force in the line R O S (*fig. 26*) cutting the right line O N at O; the effect of which will be to draw forwards and downwards the thyroid cartilage from A to A', and the point R R'; these muscles have the advantage of acting on the extremities of a lever equal to the line O N. When any force equal to that in R S is acting simultaneously with that of the thyro-arytenoideus, in the direction A R P B perpendicular to R S, the composition of these forces R S and A R P B will produce a resultant in the diagonal R N, which will cut the axis N; and as by hypothesis the forces R O and R P are equals, R and consequently A will be fixed points; but the attachment of the thyro-arytenoid at B makes an angle with the axis in the line B N, and the perpendicular cutting the direction of the force of this muscle produced to the axis is P N; thus whilst the sterno-thyroid has, by its action on the lever O N, fixed the points A and R, the thyro-arytenoid may act with an equal force at the point B on the lever P N; but as the force P N is produced on the cricoid (which is free to move by the relaxing of the crico-thyroid), the result will be to rotate the point B towards A, and depress the point *f'* to *f*; and thus the question is solved. In the preceding demonstration it must be remem-

bered that the point R is assumed to be that in which the whole of the sterno-thyroid is inserted, whereas it is expanded upon the surface around the oblique ridge, but any of its fibres below R will have the same effect as if at R, provided they are in the line O S. It must also be borne in mind that the thyro-hyoid prolongs the action of the sterno-thyroid to the os hyoides; but in this instance the os hyoides itself descends simultaneously with the expansion of the crico-thyroid space, and we know that the sterno-thyroid is always in action during the descent of the larynx. There is, however, very little muscular force required for rotating the cricoid in the direction in question. It is therefore evident that the sterno-thyroid is the antagonist to the thyro-arytenoid, and that, in this instance, during the rotation of the cricoid on the thyroid in the direction B B P A must be the antagonist to the crico-thyroid.

From the preceding demonstrations we conclude that when the crico-thyroidei, the thyro-arytenoidei, the crico-arytenoidei laterales, and the arytenoid muscles are acting simultaneously, the chink of the glottis is entirely closed. Another function of the thyro-arytenoidei relates to their effects during the production of vocal sounds, which will be considered in the article VOICE. In order that the glottis may be closed in the manner just described, it is necessary that the crico-thyroid assisted by the sterno-thyroid should have fixed the fulcrum for the play of these muscular motions.

The crico-arytenoidei postici.—The intrinsic muscles of the larynx already described tend, more or less, to affect the antero-posterior diameter of the larynx, the tension of the thyro-arytenoid ligaments, or the contraction of the chink of the glottis. The crico-arytenoidei postici have altogether a different tendency. They are a pair of muscles arising at the posterior surface of the cricoid (*ee, figs. 27 & 28*); the superior and middle fibres ascend obliquely, the inferior nearly vertically to be inserted into the lateral prominences at the bases of the arytenoid cartilages, anterior to the crico-arytenoidei laterales.

These muscles lie under the mucous membrane of the pharynx, and upon the posterior surface of the cricoid.

The contraction of these muscles is generally said to draw the arytenoids backwards, outwards, and downwards, and to open the glottis posteriorly. This view is in a great degree, but not strictly, accurate. The crico-arytenoideus posticus being inserted into the arytenoid cartilage at N has the effect of acting as on the arm of a short lever at N, and of rotating it upon the axis O P, in the direction of N W, which is directly opposed to the direction of the force of the crico-arytenoideus lateralis, which is represented by W N, therefore the effect of this muscle is to separate the vocal ligaments, and consequently to open the chink of the glottis. Mr. Willis remarks that the thyro-arytenoidei postici do not draw the arytenoids backwards, as described by anatomists, which implies that the posterior fasciculi of the

ligamentous fibres of the crico-arytenoid articulation at B (fig. 30) are relaxed; for, although some fibres lying nearest the mesial plane are directed to draw the arytenoids towards B, they are counteracted by the fibres lying furthest from it, and by assuming the whole to act together, the resultant will be as nearly as possible perpendicular to the axis of articulation O P, which would open the glottis; and therefore he concludes that the force of the thyro-arytenoidei postici in a direction backwards may be neglected. Bichat erroneously considered that they assist the thyro-arytenoidei and crico-arytenoidei in drawing the thyro-arytenoid ligaments very tense.*

The thyro-epiglottidei.—These are a pair of small muscles situated between the anterior surface of the thyroid cartilage and epiglottis; they arise from the internal surface of the thyroid near its middle, and not far from the origin of the thyro-arytenoidei; their fibres are directed upwards and forwards to the base of the epiglottis, to which they are inserted behind the ligamenta thyro-epiglottidea.

Their action is to depress the epiglottis.

The aryteno-epiglottidei are two small muscles, arising from the superior pyramid of the arytenoid cartilages posterior to the arytenoid muscles, or from the fibrous raphé situated vertically behind them; they pass upwards and forwards to the sides of the epiglottis, and upon the posterior border of the thyro-epiglottic membrane.

Action.—Owing to the direction of their fibres, the thyro- and aryteno-epiglottidei tend to depress the epiglottis, or rather to effect the tension of the aryteno-epiglottic mucous folds.

The action of the intrinsic muscles of the larynx may be briefly recapitulated as follows:

The crico-arytenoidei postici open the glottis; all the other muscles close it.

The arytenoideus obliquus and arytenoideus transversus approximate the arytenoid cartilages posteriorly. The crico-arytenoidei laterales and the thyro-arytenoidei bring them in contact anteriorly. The thyro-arytenoidei close the centre of the glottis, and with the crico-thyroidei, assisted by the sterno-thyroidei, regulate the tension, position, and vibrating length of the chordæ vocales.

The crico-thyroidei and sterno-thyroidei antagonise the thyro-arytenoidei, and in stretching the crico-thyroid ligament, the sterno-thyroidei with the thyro-arytenoidei antagonise the crico-thyroidei.

The crico-arytenoidei laterales, and thyro-arytenoidei, and the arytenoideus obliquus and transversus antagonise the crico-arytenoidei postici. These last-named muscles likewise may be said to antagonise all the muscles which close the glottis.

The genio-glossi, the linguales, the stylo-pharyngei, and crico-pharyngei, and hyo-glossi, are muscles associated in common with the mo-

tions of the tongue, pharynx, and larynx, and belong rather to the structure and functions of the two former of these organs than to the larynx, and consequently are considered only as auxiliary.

The motions of the internal mechanism of the larynx being effected by muscles, whose forces are directed, with respect to each other, in various degrees of obliquity, and in different planes, and producing by their combination results which can only be demonstrated on mechanical principles, it has been deemed desirable to introduce them into the preceding investigations to insure greater precision of detail and accuracy of result, and the more especially as we find in the works of our best anatomical writers the most discordant opinions, based apparently upon mere hypothesis or superficial observation, and without reference to any data or principle from whence their conclusions are drawn.

The perusal of the works of Albinus,* Haller,† Cowper,‡ Söemmering,§ Meckel,|| Bichat,¶ Magendie,** and Bell,†† confirm these remarks; exceptions to these observations are found in the works of Borelli,‡‡ Barthez,§§ E. and W. Weber,|||| Bernouilli,¶¶ Barclay,*** and Willis;††† from the invaluable investigations of the latter much assistance has been derived.

Bloodvessels.—The arteries of the larynx are derived from the superior thyroid, a branch of the external carotid and from the inferior thyroid, a branch of the subclavian. Small veins accompany the arteries and empty themselves into the neighbouring trunks.

Structures called glands.—*The arytenoid gland.* Syn. *Glandula arytenoidea*, Morgagni, Bichat, Cloquet; *cartilago cuneiformis*, Wrisberg, Bandt. The arytenoid gland is an inappropriate designation given to the cuneiform cartilage by Morgagni,††† whose views of the structure of this body are adopted by Bichat,§§§ Cloquet,|||| and Cru-

* Historia Musculorum, lib. ii. chap. 2.

† Elem. Phys. tom. iii.

‡ Anat. of the human body.

§ De Corporis Hum. Struct.

|| Traité Générale, tom. x.

¶ Traité d'Anat. desc. tom. ii.

** Physiol.

†† Anat. of the human body.

‡‡ De motu animalium. Lugd. Batav. 1685.

§§ Nouvelle mécanique des mouvemens de l'Homme et des Animaux, 1798.

|||| Mechanik der Menschlichen Werkzeuge, mit xvii Taf. Gött. 1836-8.

¶¶ De motu musculorum.

*** The muscular motions of the human body.

††† Cambridge Phil. Trans. 1833.

‡‡‡ Constant glandulæ arytenoideæ ex granosa substantia è livido abescente, de qua utilem oblinendo laryngi succum maximè inter edendum, aut vociferandum, appressa epiglottis; vel contacti vicini musculi expriment.

§§§ Il apparait que les deux glandes arytenoïdes ne sont que des glandes muqueuses plus prononcées que celles qui entourent le reste de la membrane laryngée, mais qu'elles ont absolument le même usage. Op. cit. p. 386.

||||| Les glandes sont formées de petits grains arrondis, assez consistans, d'une couleur grisâtre. Op. cit.

* Quand les thyro-arytenoïdiens et crico-arytenoïdiens lateraux d'une part, et les crico-arytenoïdiens postérieurs d'une autre part agissent simultanément, les ligamens thyro-arytenoïdiens sont fortement tendus.

veilhier.* The description given of it by Morgagni is, that it consists of a granular substance of a livid whitish colour, from which under the pressure of the epiglottic or neighbouring muscles a fluid is poured out. Wrisberg† described it as a cartilage under the name of cuneiform. Cuvier and Wolff, as before stated, have confounded it with the cartilage of Santorini. Morgagni appears to have mistaken for glandular the yellow elastic tissue penetrating its body. Lauth describes some mucous follicles about its base and internal surface, but he opposes the views of Morgagni on the constitution of this body. This body is sometimes absent in the human subject, but scarcely ever in the quadrumana. Its structure is decidedly cartilaginous.

The epiglottic gland.—Syn. *glandula epiglottidis*, Fab. Cass. Morg. The epiglottic gland is a name given to a mass of yellow ligamentous adipose and cellular substance, situated in the triangular space between the anterior surface of the epiglottis and the angle of the thyroid cartilage; it is bounded anteriorly by the thyro-hyoid membrane, above by the thyro-epiglottic mucous membrane and ligament; below, by the union of the epiglottis with the thyroid cartilage, and on each side by the mucous membrane passing from the thyroid to the epiglottis. Berengarius speaks of it as a fleshy gland: Steno and many others as composed of granules, whose ducts perforate the epiglottis and open on its posterior surface. Fabricius, Casserius, and Morgagni † have described and figured these supposed granules and ducts. Bichât, § Cloquet, ¶ Quain, ¶ and most modern anatomists adopt the same views. Morgagni, upon the same supposition as he had formed of the nature of the elastic tissue, considers the composition of the epiglottis to be chiefly glandular. Cloquet and Bichât admit the difficulty of detecting any follicular structure, nor could we discover any under the microscope; and from what has been already stated on the structure of the epiglottis, we conclude, as of the arytenoid, that the structure which enjoys the name of epiglottic gland is not glandular.

Mucous membrane.—The mucous membrane of the larynx is continuous with that which covers the mouth and pharynx. The posterior surface of the larynx is bounded by the pharynx, and is lined by mucous membrane both on its

anterior and posterior surfaces. If the statement of Cruveilhier be correct, this singular duplication is not to be found elsewhere in the animal economy; afterwards it is reflected over the surface of the base of the tongue, and lines the interior surface of the epiglottis; in this space it forms three folds, called *glosso-epiglottic*, often described as the middle, and two lateral, which adhere closely to the surface of the epiglottis. The mucous membrane being reflected over the free part of the epiglottis, to which it rather closely adheres, then lines its posterior surface and dips into the larynx.

A duplication called the *aryteno-epiglottic* fold passes from each side of the lateral margin of the epiglottis to the vertical apophysis of the arytenoid cartilage. This membrane is connected posteriorly with the mucous coat of the pharynx, and lines the posterior surface of the larynx; it is reflected over the arytenoid cartilages, and with the aryteno-epiglottic fold forms the posterior and lateral superior margin of the larynx; covers the superior thyro-arytenoid ligaments, penetrates to the bottom of the ventricles; from thence, after lining the inferior thyro-arytenoid ligaments, it passes through the chink of the glottis, covers the thyro and crico-arytenoideus lateralis muscles, and the internal surface of the cricoid cartilages, and becomes the investing membrane of the trachea.

The laryngeal membrane is perforated by numerous mucous orifices of a peculiar pale rose-colour; and is remarkable for its great sensibility, more especially in the region above the rima glottidis.

The rima glottidis. Syn. *cavum seu sinus laryngis* The chink of the larynx is an aperture directed horizontally, connecting the supra and infra-laryngeal regions, and allowing the free transmission of air in respiration. It is bounded posteriorly by the arytenoid cartilages, arytenoid muscle and mucous membrane; laterally by the arytenoid cartilages and the thyro-arytenoid ligaments, which, with the mucous membrane reflected over them, present nearly rectangular-shaped valves, attached on three sides, leaving one, bounding the glottis, free; anteriorly by the angle of the thyroid. Immediately above it are the ventricles, one on each side. The intrinsic muscles of the larynx not only contribute to its functions in the production of voice, but determine its form. The form of the chink of the glottis is variable; in the state of repose, or that of ordinary respiration, it is triangular, the aperture dilating during inspiration and contracting during expiration. When the arytenoids are separated to the greatest extent by the crico-arytenoidei postici, it assumes a lozenge form; if the posterior bases of the arytenoids are closed by the arytenoid muscles it becomes an ellipse; if the anterior apophyses of the arytenoids meet by the action of the crico-arytenoidei laterales, the chink may be divided into two parts. The length of the chink of the glottis is very variable, and bears a relation to that of the thyro-arytenoid ligaments; like the latter, it increases with age in an arithmetical proportion until the period of puberty; at that time its length in the male sex under

* *Traité d'Anat.*

† *Præmæ lineæ phys. anat. a de Haller, ed. Wrisberg, Götting. 1780-8. p. 157.*

‡ *Morg. advers. anat. om. tab. ii. p. 48.*

§ “Cet espace est occupé par un corps manifestement celluleux, et grasseux, dans sa plus grande partie, mais qui est inférieurement recouvert de petits grains glanduleux, tantôt agglomérés, tantôt isolés, lesquels envoient sensiblement des prolongemens dans les trous dont est percée l'épiglotte: les prolongemens paroissent s'ouvrir sur sa surface laryngée, aux orifices qu'on y distingue. Quelquefois les petits corps glanduleux sont tellement masqués par cette graisse jaunâtre, qu'on ne peut les distinguer.” *Traité d'Anat. descript. tom. ii. p. 385.*

¶ *Anat. descript. p. 245.*

¶ *Elem. of Anat. p. 858.*

goes a sudden development, whilst in the female it remains stationary. The comparative length of the chink in the male and female is proportional to the relative lengths of the vocal ligaments already detailed. The length of the rima glottidis bears no relation to the stature of the individual. In the adult male it is about eleven lines, of which the boundaries formed by the arytenoid cartilages are four, and the thyro-arytenoid ligaments seven lines. In the male and female it is on a mean average as three in the former to two in the latter. In a female, M. Lauth however found the rima glottidis to measure from ten to eleven lines, whilst that of a tall male extended only from eight to nine lines; but this is a rare instance.

The pomum Adami on the thyroid has a corresponding concavity within, which affords a greater length in the mesial section of the larynx, and which tends to increase the longitudinal dimensions of the glottis. In several of the ruminantia the concavity is very conspicuous.* The breadth of the glottis is much less than its length. In a state of repose its transverse section is not more in the adult than about two or three lines, or with respect to its length as two to eleven, but the diameter varies with the intensity of the forces of the intrinsic muscles of the larynx.

The ventricles. Ventricule ou sinus du larynx.

Cruv.—These are oval or elliptical cavities directed from before backwards, between the superior and inferior ligaments. The depths of the ventricles are effected by the distance from the free margin of the vocal ligaments to the internal surface of the thyroid, or rather to the thyro-arytenoid muscles, which constitute the bottom of the ventricles. The internal part of the posterior cavity of the ventricles is enlarged and deepened by a duplicature of the mucous membrane passing external to the arytenoid cartilage, which has been described by Morgagni, and recently more particularly by Mr. Hilton† under the name *sacculus laryngis*. The ventricles are prolonged anteriorly, extending along the vocal cords on each side of the epiglottis. In size the ventricles vary with the general dimensions of the larynx; they are each divided into an anterior and posterior cavity by a transverse ridge. The ventricles afford greater freedom of motion to the inferior thyro-arytenoid ligaments.

Nerves.—The larynx is exquisitely sensible, and, as we have seen, combines complex and delicate motions with secreting surfaces. These properties result from its nervous endowment, which is derived from two branches of the pneumo-gastric nerve, namely, the *superior* and the *inferior laryngeal nerves*.

It will be unnecessary to enter into any detailed description of these nerves here. Their distribution will be found fully described in the article *PAR VAGUM*, to which we refer. Let it suffice to mention, that the superior laryngeal nerve by its external branch gives filaments, 1, to the inferior constrictor of the pha-

Fig. 31.



A view, from Mr. Swan, of the superior and inferior laryngeal nerves. *a*, a portion of the tongue; *b*, the epiglottis; *c*, the thyroid cartilage; *d*, the posterior arytenoid muscle divided for showing a branch of the recurrent nerve passing to the oblique and transverse muscles; *e*, the lateral crico-arytenoid muscle; *f*, the thyro-arytenoid muscle; *g*, the arytenoid obliquus; *h*, the arytenoideus transversus; *i*, the crico-thyroid; *j*,

1, the superior laryngeal nerve; 2, a branch of this nerve to the membrane connected with that covering the epiglottis; 3, a branch of the superior laryngeal to the membrane placed between the superior extremities of the arytenoid cartilage; 4, the recurrent nerve; 5, a branch of the recurrent given off to the membrane lying between the larynx and pharynx; 6, a branch of the recurrent nerve to communicate with a branch of the superior laryngeal nerve; 7, a branch of the recurrent to the posterior crico-arytenoid muscle; 8, a branch to the crico-thyroid and crico-arytenoid muscles; 9, a branch giving filaments to the posterior crico-arytenoid, and passing between this muscle and the arytenoid cartilage, to terminate in the oblique and transverse arytenoid muscles.

ryn; 2, to the thyro-hyoid muscle and membrane; 3, to the laryngeal plexus; 4, to the crico-thyroid muscle; 5, to the thyroid gland. The internal branch of the superior laryngeal nerve supplies filaments, 1, to the epiglottis; 2, to the adipose and mucous membrane; 3, to the arytenoid muscles; 4, to the thyro-arytenoideus; 5, to the crico-arytenoideus lateralis; 6, a descending anastomotic branch to the

* Vide Pallas Spicil. Zool. Trans. xii.

† Guy's Hosp. Reports, No. v.

recurrent; and, 7, to the aryteno-epiglottic mucous folds and muscles.

The inferior laryngeal or recurrent nerve gives filaments, 1, to the pneumo-gastric and cardiac plexus; 2, to the pharynx; 3, to the trachea; 4, to the œsophagus; 5, to the crico-arytenoideus posticus; 6, to the arytenoideus obliquus and transversus; 7, to the crico-arytenoideus lateralis and thyro-arytenoideus; 8, an anastomosing branch to the superior laryngeal.

Our knowledge of the anatomical distribution of the laryngeal nerves, and of the functions of the intrinsic muscles of the larynx, are sufficient, independently of experiment, to demonstrate the inaccuracy of the well known assertion of M. Magendie, supported by Cloquet, Pinel, Percy, and several others, that the recurrent nerve presides over those actions which *open* the glottis, whilst the superior laryngeal influences those muscles which *close* the glottis. The principal facts opposed to this theory of M. Magendie may be briefly stated as follows. 1. It was well known long before the promulgation of Magendie's views that the inferior laryngeal nerve gave to the arytenoid muscle a filament which had been described by Andersch,* Bichat,† and Meckel,‡ and subsequently by Schlemm Bischoff, Swan, Cruveilhier, Dr. Reid, and others, therefore it has been sufficiently demonstrated that the recurrent nerve supplies the muscles that close, as well as those which open the glottis. 2. M. Magendie has stated that the crico-arytenoideus lateralis and thyro-arytenoideus opened the glottis, whereas in the preceding details it has been proved that these muscles close it. 3. The loss of voice which follows the section of the recurrent nerves results from the paralysis of all the muscles (except the crico-thyroid) which both open and close the glottis, a fact proved by the experiments of Le Gallois and Dr. Reid. The limited space allotted to this article will only permit us to notice the conclusions to which recent experimenters have arrived respecting the functions of the laryngeal nerves. The external branch of the superior laryngeal is composed chiefly of motor fibres, and it controls the action of the crico-thyroid and the other muscles to which it gives filaments. The internal branch of the superior laryngeal is composed of sensitive fibres, which confer the most exquisite sensibility on the mucous membrane of the larynx, more especially in its supra-glottideal region. It is therefore the sensitive and the motor nerve of the larynx. The inferior laryngeal supplies the muscles that both open and close the glottis, and is chiefly a nerve of motion when it reaches the larynx, but a few of its fibres go to the mucous membrane. The union of the superior with the inferior laryngeal branch by an anastomosing filament, preserves reciprocal play in the functions of these

nerves: whilst the branches anastomosing with the sympathetic, connect the larynx with the ganglionic system; the pulmonary and cardiac branches connect it with the respiratory and circulating systems, and thus associate the larynx with those vital functions. The laryngeal nerves also belonging to the reflex system, impressions made on the sensitive filaments of the larynx are reflected to the medulla oblongata, and propagated by a circuitous route to the motor filaments of the recurrent, so that a long interval is traversed in circulating an impression from the sensitive to the motor nerves of the larynx; but according to the estimate made of the speed with which an impulse is propagated along a nerve, which is assumed to be equal to that of electricity, the time occupied to transmit an impression from the filaments of sensation to those of motion must be inappreciable to our senses. Other important physiological considerations result from recent experimental researches, those of Le Gallois and Dr. Reid in particular. 1. With respect to the motions of the glottis during respiration, the dilatation during inspiration, and contraction during expiration, are the effects of the play of muscular force in opposition to the direction of the current of air in its passage to and from the lungs, the tendency of which is to produce the reverse action.* There is a constant periodical oscillatory motion of the arytenoid cartilages, revolving upon the axis of articulation, O P, (*fig. 30*.) at every expiration and inspiration; hence the necessity of a synovial membrane to lubricate the crico-arytenoid articulation. 2. When the recurrent nerves are diseased, compressed, or cut, so as to paralyse the crico-arytenoideus posticus, the power of muscular action in opposition to the direction of the inspired air is lost. The valves of the glottis are drawn downwards with the air, the anterior apophysis of the arytenoid cartilages rotated inwards, the chink closes, symptoms of suffocation supervene, and asphyxia results.

When spasmodic closure of the chink of the glottis occurs, the obstacle to the ingress of air is increased by convulsive attempts to draw in the breath, which causes a rarefaction of the air below the glottis, and augments the atmospheric pressure above it; and the chest thus, says Dr. Ley, "becomes hermetically sealed." If the aperture of the glottis be partially open, the air rushing through it causes a stridulous sound (*laryngismus stridulus*), whilst in another position of the glottis the crowing inspiration is produced; this effect arises (according to Dr. Ley) from the chink of the glottis being partially open for the admission of air, and remaining so until an explosive expiration, such as screaming, coughing, or belching, mechanically bursts open the floodgates, and terminates the paroxysm.

* In the production of these periodical movements, the action of the muscles is involuntary, but in their action for the purposes of voice, they become subordinate to the will, and therefore belong also to the voluntary system.

* Fragmentum descr. nervor.

† *Traité d'Anat.* tom. iii. p. 216.

‡ *Man. d'Anat.* tom. iii. p. 66.

Asphyxia is often delayed by the posterior chink of the glottis being retained partially open, in consequence of the coincident paralysed force of the arytenoid muscles, and by the great inclination of the crico-arytenoid articulating axis, with respect to its vertical section, preventing the approximation of the arytenoid cartilages by which the posterior part only of the chink can be closed. When any irritation is produced on the exquisitely sensitive mucous membrane of the larynx, it transmits a reflex action to the motor filaments of the recurrent, and the glottis is spasmodically closed, without any such morbid condition of the recurrent nerve as Dr. Ley supposed necessary.

The larynx, when dissected out, and cleared of its extrinsic structures, presents on its anterior aspect the free margin of the epiglottis, the notch of the thyroid, the pomum Adami, its mesial line, the crico-thyroid space, and ligament, and the anterior border of the cricoid cartilage.

On each side of the larynx are observable a portion of the wings of the thyroid, the crico-thyroid muscle, the great and lesser cornu, the superior and inferior tubercles, the oblique ridge, the superior and inferior margins of the thyroid, the side of the cricoid, with a portion of the lateral crico-thyroid ligament, and the superior, inferior, and posterior margins of the cricoid.

On the posterior aspect are observable, the posterior free surface of the epiglottis, the arytenoid cartilages and muscles, the aryteno-epiglottic mucous folds, the crico-arytenoidei postici muscles, the vertical ridge of the cricoid, the posterior margins of the thyroid, and the posterior surface of the cricoid cartilages.

In the internal surface, from above, we observe the superior margin of the thyroid cartilage and great cornua, forming the superior boundary of the larynx, the superior margin and notch of the epiglottis, the cornicula laryngis, the arytenoid and cuneiform cartilages, the aryteno-epiglottic mucous folds, the superior and inferior vocal ligaments, the ventricles, the rima glottidis, and the mucous membrane.

Looking from below upwards, we perceive the inferior circular margin of the cricoid, the membrane lining its internal surface, the inferior aspect of the thyro-arytenoid ligaments, and the rima glottidis.

The preceding outline of the general anatomy of the larynx will give the reader an idea of its manifold structures, its exquisite sensibility, its complex motions, its connection with the process of deglutition, and its admirable adaptation for the production of sound, and may serve to impress a conviction that it is one of the most elaborate and perfect specimens of mechanism in the human body.*

BIBLIOGRAPHY.—*Galenus* Opera, de locis affectis, lib. i. cap. 6, p. 6. *Vesalius*, De corp. humani fabrica, Basilæ, fol. 1555. *J. Casserius*, de org. vocis et auditu, Ferraræ, 1600. *Riolanus*, Opera. Anat. Paris, fol. 1649. *Bidloo*, Anat. Humani Corp.

* For the description of the vocal functions, see the Article VOICE.

Amstel. fol. 1685. *Malpighi*, Opera omnia, Lond. fol. 1687. *Coeper*, Myotomia reformata, Lond. 8vo. 1694, p. 80. *Dodart*, Mem. de l'Acad. Roy. des Sciences, 1700. *Morgagni*, Advers. Anat. omnia, Lugd. 1718. *Santorini*, Observationes Anat. Venice, 4to. 1724. *Albinus*, Hist. Muscul. Hominis, Leidæ Batavorum, 4to., 1734. *Ferreus*, Mem. de l'Acad. Royale, 1741, p. 400. *Piccolomini*, Anat. Int. Veronæ, fol. 1754, p. 15, 45, 53. *Duvernoy*, Ouvres Anat. Paris, 8vo. 1761, p. 91. *Winslow*, Anat. Edinb. 8vo. 1763. *Vicq d'Azyr*, Mem. de l'Acad. Royale, 1779. *Haller*, El. Physiol. *Soemmering*, De corp. humani struct. vol. vi. Trajecti ad Mœnum, 8vo. 1801. *Savart*, Ann. de Chimie et de Physique, Paris, 8vo. 1825. *Ben-nati*, Recherches sur la Mechanisme de la Voix, 8vo. Paris, 1832. *Willis*, Camb. Phil. Trans. vol. iv. p. 323, Camb. 1832. *Cloquet*, Traité d'Anat. descrip. Paris, 8vo. 1834. *Lauth*, Mem. de l'Acad. Royale de Med. 1835. *P. Broc*, Traité d'Anat. descrip. Paris, 1837, p. 527. The principal systems of anatomy.

(J. Bishop.)

LARYNX. (MORBID ANATOMY AND PATHOLOGY.)—The importance of this organ to life, and even when existence is not actually endangered, to the comfort and well-being of the individual, must render any deviation from its healthy and normal condition in the highest degree interesting to the pathologist: nor will that interest be diminished by reflecting on the paramount value of a knowledge of these deviations to every practical physician. Small in size and composed of few and apparently simple structures—its functions so obvious that any imperfection in their performance could be quickly perceived and readily understood—it would appear only reasonable to suppose that its various pathological conditions should have been observed, and the symptoms connected with them long since collected and arranged. Yet, such is not the history of the pathology of the larynx: on the contrary, it presents itself to us with all the interest of a new discovery, and whatever is known on the subject is the result of investigations made within the last few years. We have the opinion of the late Dr. Cheyne, (no mean authority on the subject,) that in the year 1800, "perhaps there was not in Britain more than one individual, namely Monro, who was acquainted with the true nature of the disease of which General Washington died—acute laryngitis;" and the same writer goes on to shew that in ten years subsequent to that general's death, Dr. Baillie, then at the head of the medical profession in England, admitted that he was ignorant of the nature of the same malady. But without reverting so far back, I may be permitted to state, that within a comparatively recent period I can personally remember the lack of knowledge that obtained amongst medical practitioners in this particular, and the deplorable results that too frequently ensued: and although it may be gratifying to reflect on the altered condition of things at present, yet it must be obvious that a subject so short a time under investigation cannot be expected to have been thoroughly worked out. Much as has been brought forward—perhaps more remains behind, and any person now attempting to give

an exact and adequate description of the pathology of this organ, may probably find it necessary to bespeak a very considerable degree of indulgence.

Accustomed to consider laryngeal disease practically, and more particularly with reference to operation, I find it difficult to bind myself down to mere pathological arrangement, or to attempt a satisfactory classification. True, like other organs, the larynx is composed of different structures, in each of which disease will assume the character peculiar to itself, and exhibit the appropriate appearances in an examination after death, but it rarely happens that morbid actions are so limited in extent, as to exist and produce their proper results in one tissue without the participation more or less of the others. This will produce confusion, and render it a matter of difficulty to connect symptoms with the existing pathological conditions that occasion them, and may be adduced as an objection to any attempt at arrangement founded upon structure alone: yet there really can be no classification altogether exempt from the same or a similar observation, and therefore I shall adopt this one as having the merit of the greatest simplicity. Following this view then, I find the larynx to be composed of the following structures, viz.:—

1. Mucous membrane, exhibiting all the varieties of inflammation that are observed in that tissue when situated in other organs. Thus inflammation here may be acute or chronic, phlegmonous or erysipelatous, idiopathic or symptomatic, and attended by fever of a typhoid or an inflammatory type. And these varieties producing different effects or results. Thus we have examples of acute idiopathic inflammation with fever of a sthenic kind in the croup of children, producing the adventitious membrane, and in the laryngitis of adults, that terminates so frequently in œdema; and of the same local disease with asthenic fever in the diphtherite and in erysipelas: whilst accident furnishes numerous instances of the results of symptomatic inflammation in the consequences of burns, scalds, penetrating wounds, and the swallowing of caustic poisons. As happens so constantly in other structures, chronic inflammation is here best known by the changes it induces, and furnishes us with abundant specimens of hypertrophy or thickening of the membrane, and of the different forms of ulceration.

2. Submucous tissue, which is the seat of œdematous effusions, and of the sloughy and putrid matter produced by diffuse inflammation.

3. Cartilage, in which we remark great and important varieties of disease, such as inflammation, ulceration, mortification, degeneration into an earthy unorganized material, atrophy, hypertrophy, and some alterations of shape and structure probably depending on scrofula or other constitutional taint.

4. Muscle, the seat of those spasmodic actions so frequent and so perilous in laryngeal affections, and perhaps occasionally of gout and rheumatism also.

5. Ligaments. I know not whether disease ever originates in these structures, but there can be no doubt that they are sometimes removed by ulceration, and there is reason to believe that great inconvenience and even danger may be occasioned by a preternatural relaxation of some of them.

1. Acute inflammation of the mucous membrane is always in the first instance attended by a change of colour more or less intense according to its situation, being comparatively pale where it is closely attached to a subjacent cartilage, but of a deep and concentrated red tint, verging on purple, where it is more loosely connected by the intervention of cellular tissue or muscle. The membrane is also swollen, soft and pulpy, these characters being likewise influenced by the nature of its connection to subjacent parts, and I believe the usual symptom of inflammation, "pain," is not absent, although the mental agony attendant on obstructed respiration renders this a secondary consideration to the patient: certainly in the laryngitis of the adult, pressure on the pomum Adami is very sensibly felt. In connexion with these changes the functions of the organ are interrupted and impaired. The usual secretion of the membrane is diminished in quantity, or perhaps ceases altogether, and hence the sensation of dryness or huskiness in the throat, and the peculiar solitary ringing cough that uniformly is present. The voice is also injured, being occasionally nearly if not altogether lost, and there is difficulty of breathing accompanied by a harsh stridulous sound; this latter being caused by the mechanical obstruction to the passage of air produced either by tumefaction or by spasm. Having continued a given time,—and the first stage of inflammation of the larynx if very acute is usually but short,—certain results or effects are developed, which, differing in the child and the adult, require a brief separate notice for each.

The acute laryngitis of the child, or croup, although generally commencing in the larynx alone, and sometimes altogether confined to it, is by no means uniformly so: on the contrary, it not only may commence in or extend to the trachea, but possibly have its origin in the bronchial cells, and pass thence upwards along the tubes. It may also perhaps not be strictly correct to arrange croup amongst the diseases that are preceded or accompanied by inflammatory fever, for occasionally it makes its attack without any previous warning whatever, and a child that had retired in apparently perfect health may arouse and alarm its attendants in the middle of the night with the sounds of that dry, harsh, and incessant cough, and that loud and stridulous respiration which afford to the practised ear the painful but unerring evidence of the nature of the mischief present. In either case, however, the disease hastens to its second pathological state, in which the evidences of increased vascularity begin to disappear, and are succeeded by the secretion or effusion of a viscid tenacious lymph, which, assuming the form of a membrane, has ob-

tained the name of the false or adventitious membrane of croup. This substance is of a pale yellow colour, viscid and tenacious; more generally found in the larynx than the trachea; seldom occupying the entire circumference of the tube; unorganized; incapable of becoming the medium of union between opposing surfaces, and with a strong disposition to separate from the surface on which it was originally formed. It usually commences in the larynx, and travels downwards along the trachea; more rarely it seems to begin in the ramifications of the bronchial cells; and again, still more seldom is the entire of the mucous membrane attacked at once, and the adventitious membrane thrown out over its whole extent. Considered as a pathological production, this false membrane of croup presents some curious and interesting subjects for observation, for although so generally met with that by some it has been regarded as the essential characteristic of the disease, yet perhaps it is not invariably or necessarily so; at least I have seen cases so far resembling croup in all their stages, that they could not be distinguished from it during life, in which dissection subsequently shewed the mucous membrane swollen, and soft, and pulpy, with copious submucous effusion, yet without the formation of a single flake of lymph. Possibly in the few cases of this description that came under my observation, the disease had proceeded with a rapidity which proved fatal before the membrane had time to have been formed. Again, it is the only* instance of lymph being produced on a mucous surface as the result of active acute inflammation. In chronic affections membranous layers of lymph are often formed, and in different situations, as in the bronchial cells and the mucous coat of the intestines, but the acute produces it alone in the structures that are the seat of croup. And lastly, it appears that this effect of inflammation is restricted to patients under twelve years of age. Mr. Ryland, in his excellent treatise on the larynx, has published a table from Bricheateau, by which it is shewn from the experience of fourteen distinguished authors, that croup "has never occurred at a later age than twelve years, and very rarely at that age." My friend, Dr. W. Stokes, considers the cases published as examples of croup occurring in the adult as not being inflammatory croup at all, but analogous to the diphtherite of Bretonneau, which will be shewn to be a very different disease indeed.

Such is the pathological condition of the parts in the second stage of croup—a condition indicated by the increased difficulty of breathing—the pale and swollen countenance—the straining eye—the dilated nostril and the purple lip; by the occasional expectoration of some portions of the false membrane; and (as happens in every affection of the larynx) by severe and protracted spasms of the glottis. If the patient still continues unrelieved, the third and

last stage supervenes. The child still breathes with difficulty, but with increasing languor: its countenance is pale; its lip bloodless; there are generally convulsions, in one of which the fatal event may take place; or else he sinks gradually, exhausted and worn out, and dies comatose. And we are to look for the actual and immediate cause of death not to the larynx but to the lungs and brain. No matter how much the membrane may be swollen, or how extensively the false membrane may have been formed, the rima is not completely closed, and the patient dies, not because there is an absolute insufficiency of air to provide for the arterialization of the blood, but because some change has taken place in the organ by which this most important function is performed. When the thorax is opened the lung does not collapse under the influence of atmospheric pressure; when the lung is cut into, it is found to be loaded with dark blood and with frothy serum, the effusion of which latter is often so abundant as nearly to fill the trachea. The brain, if examined, is found congested, and not unfrequently is there an effusion of serous fluid into its ventricles.

The acute inflammation of the mucous membrane of the larynx bears no resemblance in the adult to that in the child, excepting only in the agonizing difficulty of respiration and the fatality of the result, but the pathological conditions are different, and therefore is the disease in the adult far more manageable. I can scarcely conceive, much less describe the existence of acute laryngitis to any dangerous extent in the membrane alone without the participation of the submucous tissue, in which the perilous tumefaction is generally, if not always, seated; I shall, therefore, as I have hitherto done, consider this affection in connection with its principal pathological result—the formation of an oedematous effusion.

Mucous membranes in every situation seem to be connected to the adjacent tissues by that species of cellular membrane termed reticular, as a provision that the courses of the canals of which they form so important a part should not be impeded by any accumulation of fat: and this reticular membrane is more or less lax according to the nature and consistence of the subjacent structure. Where mucous membrane is attached to bone, the nature of the connecting medium is so short and close, that in many instances it is scarcely observable, and the membrane, in addition to its own functions, appears to perform that of a periosteum, whilst in other situations, as in the intestine, it is so lax as to allow the organ to become distended to an almost unlimited extent. The usual effect of inflammation on this reticular tissue is an effusion of a serous fluid within its cells, and the production of oedema; but this is of little consequence where the tissue is dense and close, and perhaps of still less where the organ is widely distensible. The larynx, however, presents an organ of a mixed character—the mucous membrane is here attached to muscle and to ligament, and these

* For an apparent exception to this rule, see a case published in the *Dub. Journ. of Med. Science*, September 1838, No. 40, vol. 14.

again are supported and restrained by resisting cartilages externally, so that if the submucous tissue which is here so loose as to allow the membrane to be thrown into natural folds, should become the seat of infiltration, the swelling so produced cannot take a direction outwards, but must tend to compress and close the aperture of the glottis. This is the œdema of the glottis, a formidable and too often a fatal affection, but nevertheless presenting very considerable pathological varieties. Thus it is sometimes attended by fever, and forms only part of a more extended inflammation, involving tonsils and fauces, pharynx and larynx: again, it is purely local, confined to the larynx alone, and so entirely free from any accompanying fever, that the patient only complains of the difficulty of breathing and the cough. It is often idiopathic, but may be produced by injury, and is a common result of swallowing caustic poisons and boiling water; nor is it in this latter respect confined to the adult, for I have thus seen the superior aperture of the glottis, in a very young child, pursed up and closed as if by the drawing of a running string. It may be situated only in a part of the larynx, the rest remaining free; thus it is no uncommon occurrence to see only one side of the glottis puffed and swollen, and the slit-like aperture thus converted into a curve; but the most interesting because the most practical illustrations of partial œdema will be found in cases published by Sir Henry Marsh, in which the disease appeared to be confined to the epiglottis alone.* Lastly, I believe it is possible to have this œdema produced without any external evidence of inflammation. In the Museum of the School of Park-street there is a preparation shewing it as apparently occasioned by the vicinity of a large carcinomatous tumour.

Considering the pathology of this affection, the degrees of inconvenience and of danger likely to result from it will be easily understood. The symptoms will be, a loss or imperfection of voice, which is generally very well marked, the utmost effort at articulation amounting to no more than an indistinct whisper; and difficulty of respiration, including cough and other signs of local irritation. The danger will probably be in proportion to the rapidity with which the effusion is formed, for life may be maintained with a wonderfully diminished supply of air to the lungs, provided the diminution takes place gradually and slowly: but it may not arise solely from this cause, for here, as in every other form of laryngeal disease, spasmodic exacerbations are painfully frequent, and place the patient's life in momentary danger. Dissection, therefore, develops three different causes of death. One, the most infrequent where the patient has perished by spasm: the glottis, although swollen, is still pervious—perhaps apparently sufficiently so for the ordi-

nary purposes of respiration; but in order to observe the relaxation after spasm, several hours must be allowed to elapse between death and the post-mortem examination, for the bodies of those who die of laryngeal disease become extremely rigid, and remain in this state a considerable time. A second, in which the effusion having been poured out with great rapidity, the rima is found mechanically blocked up, and immediate suffocation occasioned: in this case neither the lungs nor brain are engaged, at least not necessarily. The third is, where the disease has lasted three or four days or more, the œdema has been developed but slowly, and the diminution of the supply of air been less sudden: in these cases, besides the symptoms of strangulation, others, indicative of a congested condition of the lung and brain, are observed during the latter periods of existence, and corresponding morbid appearances are discoverable after death.

Very severe inflammatory affections of the mucous membrane of the larynx are unfortunately too frequent to admit of doubt or to create difficulty; but a good deal of confusion has arisen from an attempt to identify them, or some of them, with croup, because an exudation takes place from the surface in some respects resembling the adventitious membrane formed in the latter disease. One of these has been described with graphic accuracy by M. Bretonneau of Tours, by him supposed to be the same with croup, and named Diphtherite: but although the differences between these affections have been observed and pointed out, the name is still frequently applied (I fear) without very precise ideas attached to it. The exact disease described by Bretonneau I do not profess to have ever seen, neither have I heard of it, unless in one instance in a family in this country which lost four of its young and interesting members by a visitation at least bearing some resemblance to it. In hospital I have heard the name applied to some throats which I never should have thought of identifying with that described by the French writer, and I feel satisfied that the attempt to mix up different and it may be opposite diseases under one generic name has done anything but simplify the study of pathology. If, however, by asthenic croup or diphtherite is meant the peculiar local disease which accompanies the eruption of scarlatina anginosa, or which is frequently met with without any cutaneous eruption, especially in adults—which is accompanied throughout by low and typhoid fever, and is often propagable by contagion—then is the affection well known and its description easy: but it bears no similitude whatever to inflammatory croup. For besides that the constitutional affections are totally opposite, a circumstance of the greatest importance as influencing the progress of the respective cases, the local symptoms and appearances have marked and distinct characters. Thus the asthenic angina is always ushered in by shivering and other precursors of fever; the soreness of the throat is intense from the very commence-

* See Dub. Journ. of Med. Science, March 1838, v. 13, no. 37. This excellent paper of Sir H. Marsh's contains many illustrations of the same fact.

ment, and the part is even painful on pressure externally; every attempt to swallow is so dreadfully distressing that patients will suffer to be half-famished rather than attempt to get down a spoonful of fluid. In attempting to examine the throat there is often great difficulty, because the patient either cannot, or from the pain it occasions, will not open his mouth; but if it can be seen, it is observed to be of a deep red colour, verging on purple, sometimes diffused over the surface, sometimes in patches, and even from an early period abundantly covered by a thick glairy tenacious mucus that it is difficult to wipe from it. If the disease is severe, the membrane soon becomes sloughy: "the colour of the slough is grey or ashey: in some few instances it appears brown; its edges are abrupt and well defined, and it is surrounded by inflammation of an intensely deep red colour. The slough is in general slow in separating, and when thrown off it appears to resemble a membrane of viscid lymph not unlike the adventitious substance formed in croup, and the surface underneath looks of a bright red colour, is nearly level with the adjoining parts of the membrane, and seems more like the blush of erythema than the relic of mortification. I believe that wherever croup has appeared to have been contagious it will be found that malignant scarlatina has prevailed also; and that the occurrence of the laryngeal or tracheal disease was occasioned by the spreading of the inflammation from the fauces to the windpipe, or perhaps by the actual presence of one of these sloughing ulcers in the immediate neighbourhood of the glottis."*

Such is the description of the effects of *angina maligna* on the mucous membrane written in the year 1825, but without any suspicion on the part of the writer that it could ever be ranged by the side of the affection termed croup: for besides the essentially opposite characters of the fever in each, which by themselves would be all-sufficient, there are the following differences. The *angina maligna*, diphtherite, or by what other appellation it is to be known,—for with respect to it we enjoy a most happy abundance of nomenclature,—commences always in the fauces, and when it attacks the windpipe, which is by no means very frequent, it does so secondarily by spreading to it; whereas croup seldom or never commences in the fauces unless when it appears as the sequela of some serious injury, such as the swallowing of boiling water. *Cyanche maligna* even locally is not confined to the mucous membrane, as is evidenced by the intense pain in swallowing, the difficulty of opening the mouth, the enlargement, suppuration, and even gangrene of some of the adjacent glands; and it occasionally exhibits something like a metastatic transfer of disease to some important organ, such as the brain or liver. And even when recovery takes place, the difference is still remarkable: it is slow, often imperfect,

and followed by *anasarca* or some similar evidence of a broken and cachectic habit. This is not the place to enter more fully into the examination of these two diseases, which the reader will find admirably contrasted in Dr. W. Stokes' work on diseases of the chest, where the *angina* is spoken of under the name of secondary croup.

There remain two other affections of the larynx to be noticed accompanied by *asthenic fever*, in both of which the pathological condition of the submucous tissue is of great importance, viz. *erysipelas* and *diffuse inflammation*. I believe the larynx is very seldom the primary or original seat of an *erysipelatos* attack, at least such has not come under my observation; but I have not infrequently seen it seized either by the spreading of the disease from the head and face, or by some species of *metastasis*. The constitutional symptoms during life are of a low and typhoid character; the local, those of painful and difficult deglutition and respiration, and the termination (as far as I know) always fatal. Nor are the appearances after death always satisfactory, for, as in other cases of *erysipelas*, the tumefaction often subsides and the colour fades very soon after death. In most instances, however, we find the mucous membrane of a pale yellow colour and apparently greatly thickened: the submucous tissue filled sometimes with serum, sometimes with a gelatinous lymph, and sometimes with a sloughy and putrid matter; the natural folds of the organ obliterated, and the rima more or less blocked up and closed by the thickening and tumefaction of the adjacent parts.

But one of the most curious affections to which the larynx is liable is that of *diffuse inflammation*. I say "curious," because it is not necessary that the mucous membrane should be inflamed or thickened or otherwise engaged, or that there should be any remarkable swelling of the parts, and yet the breathing is harsh, sibilous, or croupy, as if from the presence of some mechanical obstruction. In these cases, which are always fatal, the cellular tissue is the seat of the disease, and is found filled with offensive purulent matter and flakes of unorganized lymph, sometimes around the larynx, trachea, and *œsophagus*, sometimes at the front of the throat, and not infrequently extending to a considerable distance down into the anterior mediastinum.

Chronic inflammation of the mucous membrane of the larynx resembles in its effects a similar form of disease in other structures, except that as the aperture of the glottis is small, and its functions essential to life, the same degree of alteration or of disorganization cannot have place here that may occur in other situations without the patient generally experiencing a degree of distress that will at least direct his attention to the subject. Still is this affection sufficiently insidious, and its progress in many instances so slow, that often irremediable mischief is produced before assistance is sought for: and thus it happens that we are obliged to speak of chronic inflammation, not with re-

* Potter on the larynx and trachea, p. 17.

ference to its commencement or the early periods of its progress, but to its effects or products, which, exhibiting various forms of derangement and disorganization, shew to the morbid anatomist the length of time the work of destruction must have been in operation, and the extraordinary changes of shape and form and structure that may occasionally be endured consistently with the maintenance of a miserable existence.

The simplest form of altered structure in the mucous membrane that I am aware of is that effected by a slow but progressive deposit (probably of lymph) within its substance, which renders it firmer, thicker, and more solid; and although this must occasion inconvenience and difficulty of respiration to a certain extent, and is troublesome from the dry cough and occasional spasmodic exacerbations that accompany it, yet perhaps, whilst restricted to this stage, it is seldom perilous to life. But these alterations of structure, particularly if neglected, are seldom quiescent, and however slow in their progress have a tendency to move forward either to a morbid or perhaps malignant change of the tissues, or to the partial removal of these by the process of ulceration. Thus, ulcers of the larynx, however heretofore overlooked by pathologists, are now found to be extremely common, and I know of nothing more difficult than to subject the numerous varieties of them to any form of classification. They cannot be arranged according to structure, for they are very seldom so superficial or so insulated as to engage the mucous membrane alone; neither can they be classed according to the symptoms they occasion, for the suffering of the patient or even his ultimate danger does not seem entirely to depend on their extent or character. The most practically useful division of these ulcers would be as to their exciting cause if it could always be discovered; yet even here there is so much uncertainty of symptom during life and such diversity of appearance after death as to render the subject obscure and unsatisfactory.

In some instances the larynx becomes the seat of idiopathic ulceration, that is, the disease seems to have been occasioned by cold or other causes of local irritation—at least such is the only explanation to be offered. "Thus the laryngeal surface of the epiglottis and the internal parts of the organ itself may be studded over with numerous minute aphthous ulcerations; sometimes the edges are marked by a yellow line of superficial excoriation, bordered by a deep blush of inflammation; and in these cases I have always observed, during life, that great pain and difficulty of deglutition accompanied the symptoms of dyspnœa, and often formed the most prominent feature of the case. Occasionally the ulceration is deep and foul, and spreads with an almost phagedenic destructiveness: these sporadic sores, usually commencing above, either in the soft palate or the back of the pharynx and spreading downwards, too often involve the destruction of the patient. Occurring as they constantly do in bad and cachectic habits, they are little under

the control of medicine, and operation, however it may prolong existence, scarcely holds out a hope of ultimate recovery."

In other cases the ulceration seems to be sympathetic, and either precedes or follows certain affections of the lung. Thus in cases of tubercular consumption, aphonia is often a very distressing symptom, sometimes accompanied by difficult respiration, and occasionally by painful deglutition. In these instances not only is the larynx studded over with specks of ulceration, but the trachea and bronchial tubes leading to the cavity in the lung present a similar appearance, as if the matter possessed some corrosive quality and its passage over the mucous membrane became the cause of its ulceration. These appearances have been too frequently observed not to have attracted the notice of the morbid anatomist, but still it is extremely difficult to connect them with disease of the lung in the relation of cause and effect, for sometimes the loss or imperfection of voice precedes or at least is amongst the earliest symptoms of consumption, and in other instances it only becomes manifest in the very latest stages. It is easy to conceive that the presence of an ulcer in the larynx, by producing difficult breathing and occasioning a diminution of the supply of air, may determine the development of an abscess in a scrofulous lung already well disposed to such disease; but when the ulceration has occurred at a late period, and the difficulty of swallowing, the aphonia, and stridulous breathing appear among the closing symptoms of consumption, it will be difficult to account for the appearances observed, unless by supposing them to be sympathetically produced.

But of all the causes from which ulcerations of the larynx are known to proceed, some specific or constitutional taint seems to be the most influential, such as syphilis, scrofula, mercury, or a combination of two or more of these. As far as my own observation extends, I cannot say I have ever seen the larynx engaged in a case of venereal where no mercury had been used, but on the other hand there is scarcely any organ more likely to be attacked where the medicine has been imperfectly or improperly used, or in which the attack is more perilous and unmanageable. Sometimes the larynx becomes ulcerated in consequence of phagedena or other destructive form of the disease spreading downwards from the throat or fauces, but more frequently is it engaged alone. The ulcers here are seldom solitary, but present several spots of ulceration, and in some cases are so extensive that the whole configuration of the organ is spoiled and lost, the epiglottis being partially or entirely removed, and the chordæ vocales and ventricles carried away. The surface of this extensive ulceration is irregular, warty, and gives the appearance of uneven granulation, and there are chaps and fissures that pass deeply into the substance of the subjacent cartilage, portions of which are removed. When the ulcers are more superficial they very often exhibit the herpetic appearance and the tendency to spread observed in mercurial sores,

healing in one situation whilst fresh ones break out in the neighbourhood, and cicatrizing with a depressed surface and evident loss of substance. With respect to symptoms, the loss or imperfection of voice will very much depend on the situation of the ulcers; but the difficulty of breathing and general distress are by no means criteria by which the extent of destruction of parts can be estimated, for sometimes there is uncommon suffering where the ulceration is extremely limited. Very frequently these ulcers (particularly if the epiglottis is engaged) produce symptoms of difficult deglutition, exactly resembling those of stricture of the œsophagus: but this is only during the time the sores are actually open, for, when healed, swallowing is performed with astonishing facility, even although the greater part of the epiglottis may have been carried away.

But the most interesting fact in connexion with these ulcers is, that by rest and proper treatment they are susceptible of cure, and fortunate it is that by means of operation we are enabled to afford this important organ the requisite degree of repose. Mr. Carmichael has published two most interesting cases illustrative of this fact; in which the patients recovered, and in which we have consequently a right to infer that the ulcerations healed. In the summer of 1838 I operated on a woman in the Meath Hospital, who had symptoms of such extensive destruction of parts as must have proved fatal, but who nevertheless recovered with a complete capability of breathing through the rima, but with nearly a total loss of voice. The healing of this kind of ulceration may be inferred from that case also, but it is proved by the following observation: "In the Museum of the School of Park-street, Dublin, is a preparation taken from a poor woman who had been an inmate of the Meath Hospital ten or eleven different times for venereal ulceration of the larynx, and finally died there quite suddenly, as if from the effects of spasm. It shews where a large portion of the epiglottis had been removed, the ulcer having healed by a puckered cicatrix. From below the left ventricle a longitudinal scar extended a full inch and a half down into the trachea, the contraction of which had diminished the calibre of that part of the tube very sensibly. The right ventricle was totally obliterated, and on different spots about the superior part of the trachea there were several small pale depressed cicatrices, evidently the results of former sores that had been open at different periods at which she had been in the hospital. The only ulcer that existed at the time of her death was a very small one, with ragged irregular edges, situated midway between the natural position of the right ventricle and the root of the epiglottis."

The softer tissues of the larynx are also occasionally liable to gangrene, circumscribed—confined to the organ itself and not exhibiting any tendency to spread. Of this I have as yet seen but one example, and that one under circumstances that rendered it doubtful whether the disease should not be considered as sympathetic

with a similar affection of the lung. It was the case of a man who died in hospital of gangrene of the lung supervening on acute pneumonia. Seven days before his death he was attacked with symptoms of laryngeal disease, hoarseness, with difficult and laborious breathing, which gradually increased until the voice was nearly lost and respiration quite stridulous. After death, besides the gangrene of the lung, a gangrenous ulcer was found, involving the chordæ vocales at the left side: its surface was about the size of a shilling, and of a dirty green colour; its edges quite sloughy, and its centre excavated to a considerable depth: the mucous membrane around highly vascular and covered with a pellicle of lymph.

3. The cartilages of the larynx are subject to very important diseases, some of which seem to be peculiar to fibro-cartilage in this particular situation, and all of which are attended with inconvenience and danger by reason of their interfering with the function of the organ. I shall commence with that which I believe to be the most frequent, the most important, and the most fatal; indeed, when allowed to run its own course it is always destructive, and when the patient's life is preserved by art, it is with the alternative of breathing for ever afterwards through an artificial aperture. In consequence of the similarity of symptoms between this and phthisis pulmonalis, it has obtained the name of phthisis laryngea.

The exact manner in which this disease commences and the causes that lead to its production have not yet been so accurately ascertained as to admit of no farther doubt or question; for instance, Mr. Ryland seems to think that "in most instances it is secondary to some inflammatory affection of the laryngeal mucous membrane or its subjacent tissue," whereas I have ventured to believe that the original morbid action was set up in the cartilage itself and was proper and peculiar to it; at the same time it must be confessed that I have seen it apparently produced by the presence of an abscess in the immediate vicinity, and I believe there can be no doubt of its being an occasional sequela of typhus fever. The essence of the disease seems to be a change of structure in some of the cartilages, followed by the death and disorganization of the newly formed material, and an attempt at its removal by abscess and ulceration. Thus on a post-mortem examination of one of these cases an abscess is always found in the situation of some of the cartilages—very generally of the broad posterior part of the cricoid: and this abscess has burst by one or more openings, one of them being very frequently just behind and above the rima. On cutting into the cavity of the abscess, besides the matter, which is greenish, putrid, and abominably fetid, particles of a grey or white earthy material are found, and there are always portions of bone, thin, ragged at the edges, white and perfectly dead. When the disease has so far progressed, there is always other and more extensive mischief; the exterior parts in the neighbourhood are swelled and thickened, the mucous membrane ulcerated; the arytenoid cartilages often detached; and the

epiglottis, in every case that I have seen, more or less removed by ulceration. The whole configuration of the organ is lost or spoiled, and scarcely bears a resemblance to the natural shape and appearance of a healthy larynx. We cannot even form a conjecture of the causes that occasion this formidable disease, or of the circumstances that dispose to its production. At some time beyond the middle period of life the cartilages of the larynx, except the epiglottis, and often of the trachea also, become converted into bone, and from the circumstance of carious bone being so constantly found in these abscesses, it would appear that it is either during the process of ossification or immediately afterwards that the disease commences. I have always imagined that it was at the former of these periods, and that the affection was produced by some imperfection or irregularity in, or deviation from, the ordinary and natural process—in a word, that this earthy unorganized material was formed instead of healthy bone. I had once an opportunity of seeing a case which I regarded as an example of the commencement of this disease, in the person of a man who, having suffered from laryngeal symptoms for some months, suddenly died in the Meath Hospital, apparently from the effects of spasm. "On slitting up the larynx, the cricoid cartilage appeared to be highly vascular and organised. Its substance was internally as red as blood, and in three or four places there were specks of an earthy white substance that crackled under the knife, and was evidently of the same nature with that usually found in caries of the laryngeal cartilages." I am aware that one case can prove but little, particularly in pathological science, but opportunities of seeing the incipient stages of such an affection as this must be very rare, and every case ought to be recorded that will in any manner tend to throw light on a disease the etiology of which is so extremely obscure.

However occasioned, this earthy degeneration of the laryngeal cartilages is an extremely insidious disease, its approach being so gradual as scarcely to alarm the patient, and its progress slow. There is usually sore throat and difficulty of swallowing, although this latter is not necessarily a constant symptom; hoarseness, and at first but triflingly impeded respiration. These inconveniences in the commencement are not such as to produce much distress; for I have known one patient suffer for three months and another nearly nine, before either applied for relief, and in both the disease had a fatal termination. Afterwards, however, the symptoms become much more aggravated, the difficulty of breathing is exceedingly distressing, and there are exacerbations that bring the patient to the point of death by suffocation. I have already noticed one case in which dissolution took place at a very early period, and when the occurrence could only be explained by the suddenness and severity of the spasm. At length, as the dyspnoea becomes extreme, the patient suddenly experiences some partial relief; his cough, which was before teasing and troublesome, now becomes softer, and the expectoration free and copious. This latter has all the characters of purulent

matter, and there are, mixed with it, particles of that white, gritty, earthy substance already described. Occasionally, pieces of the size of a pea of this unorganised substance are coughed up, and when they appear they leave very little doubt of the nature of the complaint. Towards the latter end of the disease the breathing becomes loud and sonorous, with a whistling noise, so as to be heard at a considerable distance. The cough is incessant; the expectoration copious, with a peculiarly fetid gangrenous smell; the patient's breath has this odour also, which may also be regarded as an unfavourable symptom. There is at all times convulsive struggling for breath, with occasional exacerbations. In most cases, but not in all, the chest becomes affected; there is pain in some one part of it or other, with a sensation of tightness round the thorax as if the patient could not draw a full inspiration. His strength seems to give way rapidly under these symptoms; his body becomes emaciated; he has night sweats accompanied with excessive restlessness; and at last he sinks exhausted in the struggle and dies.

Throughout the entire progress of the disease there is seldom any well-marked paroxysm of fever, although the pulse is never much under 100; however, this may be attributed to the constant irritation under which the patient labours. The tongue is usually clean; the appetite good—in some instances ravenous; and the general functions of the body, with the exception of respiration, seem to suffer but little. The countenance is always pale, with that sickly dirty hue that characterises hectic fever. The expression evinces great anxiety; and this is so remarkable that patients suffering under this species of cyananche often seem to bear a strong resemblance to each other.

It is now familiarly known to surgeons that even this dreadful condition is not utterly divested of hope, and patients in whom this disease had wrought such ravages as to render the larynx quite unfit for the performance of its functions, nevertheless survived for years after an artificial opening had been practised in the trachea. Some of these patients have since died, and thus in a limited degree afforded opportunity for examining the extent of destruction produced, as well as proving the all-important practical fact, that ulcerations here, however extensive, are capable of being cicatrized if the organ is only left in a state of repose. In the Museum of the Royal College of Surgeons in Ireland is the larynx of a patient who lived for more than two years after having been operated on by Mr. Purdon of Belfast, and the following are the appearances exhibited by the preparation. About half the epiglottis had been carried away, and the edge of the remnant is cicatrized. The space between the root of the epiglottis and the rima, rough on its surface, irregular and warty. The ventricles altered in shape, diminished in size, but not obliterated. The dimensions of the rima greatly diminished. The canal of the larynx is not more than one-third of its natural size, and is lined by a thick uneven membrane, evidently

the product of cicatrization, and the place which should have been occupied by the broad portion of the cricoid cartilage exhibits an empty cavity, as if that structure had been removed by absorption or some other process, and nothing deposited in its room. One of the patients on whom I operated in the year 1829 died about a year since in the Fever Hospital, and the larynx was examined by the surgeon of that institution, Mr. Trant; it presented appearances so nearly similar to the above as not to require particular detail, and quite sufficient to shew that the original destruction had been such as totally to preclude the possibility of the organ ever being capable subsequently of performing the ordinary function of respiration.

The cartilages of the larynx are also liable to mortification following on inflammation, and apparently produced by the causes that induce gangrene in other structures. I suppose this affection to be extremely rare, as I have met with but two cases, and have not heard of its being observed by others. In one of these cases a large abscess existed in front of the larynx and upper part of the trachea, in which the thyroid cartilage lay like a foreign substance entirely denuded, mortified, and abominably offensive, its appearance resembling that of wetted rotten leather. The front of the cricoid cartilage and of the two upper rings of the trachea had been removed by mortification also. The lining membrane of the larynx was thickened, corrugated, and had a granular appearance; part of it was ulcerated, through which the abscess had communicated with the pharynx. The remnant of this larynx is preserved in the pathological collection of the School in Park-street, and shews that at least five-eighths of the organ had been totally and entirely destroyed. It proves that such a disease must be utterly hopeless and irremediable, and that, quite independent of the constitutional derangement that must lead to its formation and accompany its progress, no chance could exist of cicatrization and subsequent recovery.

Occasionally, though I should suppose very rarely, the cartilages of the larynx are the subjects of an alteration of structure strongly resembling the ordinary product of scrofula. Of this I have seen but one specimen, for which I am indebted to the kindness of my friend Dr. Benson. December, 1838. A man, æt. 39, was received into the City of Dublin Hospital, under the care of Dr. B. for the treatment of what was considered to be chronic rheumatism. It was soon discovered that the pains were not rheumatic, but most probably depended on cerebral disease. The larynx presented a firm tumour externally, and there was an almost total loss of voice. He died, and after death scrofulous tubercles were discovered in the brain. The larynx was of a healthy structure in every part except in the thyroid cartilage, the alæ of which were converted into a firm scrofulous mass, about the size of a large chestnut on each side. The scrofulous or tubercular matter appeared to have been deposited originally in the centre of each ala. The margins and cor-

nua of the cartilage were unaltered, and the cartilaginous structure seemed to lose itself insensibly on the surface of the tumour.

This very interesting preparation is preserved in the Museum of the Royal College of Surgeons in Ireland.

Besides these deviations from the ordinary healthy conditions of the cartilages of the larynx, it is certain that one at least of them presents appearances of abnormal changes both of size and shape. Morbid thickening or hypertrophy of the epiglottis, as well as its opposite state of contraction or shrivelling, have been spoken of by authors, but I have never been fully satisfied that the former of these was not rather the result of a thickened condition of the mucous membrane than of the cartilage itself, and I believe the latter never is seen unless as the consequence of previous ulceration. A deviation from its usual shape is by no means very uncommon in this cartilage, most instances of which are trivial and unimportant, and are probably congenital; but in some few instances the change is more remarkable. One of these has been noticed by Dr. Stokes in the chapter of his work which treats of diseases of the larynx and trachea, and by him it is termed the leaf-like expansion of the epiglottis. He describes it thus: "This has not been described by any author, but a most remarkable preparation of the disease exists in the Museum of the School of Anatomy and Medicine in Park-street. The epiglottis is thinned and singularly elongated, and its form so altered as to represent the shape of a battledore, the narrow extremity being next the glottis. In the preparation alluded to it is fully two inches in length, and coincides with double perforating ulcers of the ventricles. Nothing is known as to the history of the case, but I have seen more or less of a similar alteration in other cases of laryngeal disease."

In a paper professedly devoted to abnormal anatomy, I know not whether I am warranted in noticing derangements of function, unattended by any lesion of structure discoverable by dissection, yet there are some of these exhibited by the epiglottis which seem deserving of the attention of the physiologist. The use ascribed to this cartilage of protecting the larynx during the process of deglutition is well known, yet observation has furnished us with examples of exceptions to this use, both positively and negatively; for, as when this valvular structure is altogether removed (by experiment in animals and by disease in man), the larynx is nevertheless often found able to protect itself, and the subject to swallow both liquids and solids without much, and occasionally without any inconvenience, so, on the other hand, it is a fact which cannot be controverted, that the epiglottis sometimes seems to be deprived of its protective sensibility, and permits the free introduction into the windpipe of substances attempted to be swallowed. This latter fact I first noticed in the case of a Wapiti deer which was bronchotomized by Sir Philip Crampton: it frequently discharged portions of its food through the wound, and yet after death the larynx in all its

parts was found apparently perfect in its organization. But not to rely on observations made on the inferior animal, a case soon afterwards occurred in the Richmond Surgical Hospital, of a young female wounded in the trachea rather low down in the neck. From this wound portions of the ingesta frequently escaped, and yet after death the larynx was found healthy, its organization complete, and no unnatural communication whatever between the œsophagus and windpipe in any part or situation whatever. I have since had a precisely similar case under my care in the Meath Hospital. These are instances in which the epiglottis seems inert, and the larynx is left patulous and unprotected; there are other cases in which it appears to be morbidly active, although it is difficult to explain the agency by which such activity is produced. In prosecuting some experiments on the subject of asphyxia, a stout middle-sized dog was let down into a brewing vat that had been emptied of the fermenting liquor about ten minutes previously; he was to all appearance perfectly dead in two minutes. After allowing the body to remain thus for twenty minutes, it was examined: the glottis was found to be of a very pale colour, and the rima completely shut up by the close approximation of the arytenoid cartilages. *The epiglottis was shut down like a lid upon a box, so as perfectly to close the superior aperture of the larynx:* this latter was a curious appearance, and I know not what muscles could produce the effect, but the fact was witnessed by Dr. Hart, now one of the professors of practical anatomy in the College of Surgeons, by Dr. Young, and others. I am also ignorant as to whether a similar condition of the epiglottis obtains in men who have been suffocated by carbonic acid; human subjects are seldom examined so soon after falling into a state of asphyxia as to allow of the immediate appearances being observed, and yet information on this point would be of great value in determining the suitable means for attempting resuscitation.

The most difficult part of the pathology of the larynx to contend with is that which has reference to muscular organization, and unfortunately it is that which has been least examined, or on which examination has thrown the faintest and most unsatisfactory light. Firmished with an exquisitely delicate and beautiful arrangement of muscle, the normal actions of which are exemplified in the production of the different sounds of the voice, and in giving force to the exit of the air in coughing, sneezing, &c. it would appear only reasonable to suppose that the functional derangements of the larynx should be accompanied by some appreciable corresponding lesion of its muscular apparatus; yet such does not seem to be the case, at least not invariably, and we sometimes find the voice impaired or perhaps lost, the muscles of the organ exhibiting their ordinary appearance, and again remarkable and seemingly important lesions without much injury to voice or respiration. Under these circumstances we must speak of the morbid appearances that have been ob-

served in the first instance, and consider the irregularities of function afterwards.

The muscles of the larynx are sometimes found in a state of extraordinary development amounting almost to hypertrophy. I know not how far this may be considered to be an abnormal condition, or whether it may not be the natural result of great and constant employment of the organ: reasoning from analogy this latter seems more probable, but dissection has hitherto thrown no light upon the subject.

They are likewise subject to atrophy or wasting, the fibres appearing thin, pale, and attenuated. Andral mentions cases of loss of voice in which he sometimes found the fibres of the thyro-arytenoid muscle wonderfully atrophied, and sometimes separated from each other by some morbid secretion, either of pus or tubercular matter. I have been informed by Sir P. Crampton that he has seen in the Museum of the Veterinary College in London, several preparations illustrative of the disease termed "roaring" in the horse, which seems to be produced by an atrophy of the arytenoid muscles. A relaxation is thus effected which allows to the arytenoid cartilages an unnatural degree of mobility. Whilst the animal is at rest or moving slowly, the current of air passes gently, and there is no "roaring;" but when he is put to greater speed and respiration becomes more hurried or more forced, the little valves are acted on, the rima is proportionably closed, the breathing becomes stridulous, and that peculiar noise so well known to persons conversant with horses is produced.

Lesion of function in the muscles of the larynx exhibits itself in the opposite conditions of atony and spasm. Examples of the former are to be found in some cases of partial paralysis where the patients become totally incapable of uttering any sound, however indistinct and inarticulate; in the hoarseness and sometimes loss of voice that suddenly attacks young persons, particularly females, from exposure to cold and damp; and perhaps frequently in the sympathetic aphonia that precedes or attends on phthisis. On the pathology of these affections morbid anatomy has thrown but little light, nor is it surprising that the subject has attracted a minor degree of attention, when it is recollected that the more severe laryngeal symptom, that of difficult respiration, is seldom or never present. I have had two cases of aphonia attended with pain and soreness in the larynx, which, under an idea that the disease was either gout or rheumatism, I treated with colchicum with apparently favourable results. I know not whether the supposition that the larynx may be the seat of either of these painful affections is correct or not, but I see no reason why it should enjoy so fortunate an exemption. However, although atony of the muscles of the larynx may not be attended with much peril, a spasmodic action of them is always eminently perilous, sometimes destroying life with a rapidity that almost precludes the possibility of assistance. There can, therefore, be few subjects more interesting to the practitioner, and

although, as might be expected, the causes that produce these terrific affections have not been explained, yet it may be desirable to examine into the symptoms and some of the circumstances that occasionally precede or accompany them.

Spasm of the glottis is either idiopathic or symptomatic.

The idiopathic occurs, as far as I know, only in children, as in the "spasmodic croup," or laryngismus stridulus, unless we also choose to include within this class the hysteric dyspnoea that occurs in young females.

The symptomatic occurs as indicative of, or in connexion with,

1. The application of some deleterious substance to the larynx, as carbonic acid, boiling-water, or steam.
2. The application of some irritating material, as a particle of salt.
3. The presence of a foreign body within the trachea or bronchial tubes.
4. The presence of a foreign body in the œsophagus.
5. The existence (occasionally) of an aneurism of the aorta.
6. The existence of any other disease within the larynx or trachea. Any of these latter may be present in the adult or the child indifferently.

Few diseases have attracted more attention than the spasmodic croup of children; few have been more accurately described as to symptoms, and in none is our pathological information more deficient; a fact that may almost be proved by the number of different names by which it has been designated. It is the asthma of infants of Millar; the cerebral croup of Pretty; the spasm of the glottis of Marsh; the spasmodic croup of other writers; and the laryngismus stridulus of Mason Good and Ley. It occurs in very young children, with a peculiar difficulty of breathing, attacking for the most part suddenly, accompanied by a crowing sound, and oftentimes with a suspension of respiration for several seconds. This difficulty of respiration varies in intensity from a single crow to a more prolonged paroxysm threatening suffocation, and terminates when in recovery by a long deep-drawn respiration, with a peculiar stridulous noise; when in death, by such convulsive struggles as might lead, and indeed have led, to a belief that the cerebrum was engaged. Pallid and exhausted, the child falls lifeless upon the nurse's arm, and is then generally said to have died in a fit. In these cases there is no cough; no rauca sound of voice; no continued stridulous breathing, except an occasional mucous rattle heard only while the infant sleeps be considered as such; there is no fever; and on examination after death no trace of inflammation, nor indeed any deviation from the ordinary healthy appearance of the organ, can be discovered. Under these circumstances, pathologists had no method of explaining the phenomena but by spasm, an irregular and involuntary contraction of the muscles of the larynx closing up the rima glottidis to a greater or less

extent, and in proportion to such closure interfering with and obstructing respiration.

But what is the cause of this spasm? Some have supposed it to have an intimate connexion with a hydrocephalic tendency, because it has been sometimes seen in children with large heads and sluggish dispositions, and because signs of cerebral congestion have been discovered after death; but I have seen the disease prove fatal to the liveliest and apparently most healthy children, and the congestion may just as well be the consequence as the cause of the closure of the glottis. Others again have referred it to the general constitutional irritation that proceeds from painful dentition, and doubtless cases have occurred in which the crowing respiration was relieved by successive scarifications of the gums, according as each tooth became prominent underneath; but this, although teaching an important practical lesson, leaves the pathological connexion between the facts in as much obscurity as ever. According to others there is a constitutional tendency to this disease in some children, a fact which it must be conceded has been painfully exemplified in more families than one; but this hereditary disposition to disease, although abundantly obvious, is too imperfectly understood to be discussed with any thing approaching to pathological accuracy. Lastly, improper or unwholesome food, indifferent clothing, a close and tainted atmosphere, and exposure to vicissitudes of climate, have been regarded as influential exciting causes, and change of circumstances in these respects has often produced an almost magical amendment in the condition of our little patients; but still we are at a loss to discover the immediate *modus operandi* of these pernicious influences, or why they should be determined to the larynx in the form of an involuntary spastic contraction of its muscles.

Other causes have been assigned for the production of this disease, some of which are eminently deserving of attention; at the same time it may be observed that its being attributed to such a number of influences shews that its real exciting cause is probably still unknown. For instance, either this disease or an affection bearing a strong resemblance to it, has been described by Dr. Kopp, and afterwards by Dr. Hirsch of Königsberg, under the name of thymic asthma, and by them attributed to an hypertrophied condition of the thymus gland, which by its weight and volume presses on the heart, the lungs, the large arterial and venous vessels, and prevents the free exercise of their functions. Dr. Montgomery has published an interesting paper on this subject, in which he attributes the sudden death to an enlargement of this gland, whether that arises from hypertrophy of its substance or an alteration of its structure from scrofula or other disease; and explains how agitation or excitement may suddenly distend and increase the size of the organ in such a manner as to affect materially the condition of the surrounding parts. Again, in the work by Dr. Ley already referred to, a different explanation has been offered. Apparently relying on the experi-

mental researches of Magendie and Le Gallois, he supposes that, if the recurrent nerves are compressed to such an extent as to have their functions impaired, the glottis, under the influence of the superior laryngeal branches, would become and continue fast closed. The cause of the disease then, according to him, will be found in some tumour, scrofulous or otherwise, so situated as to create an injurious degree of compression on the recurrent nerves. That an enlargement of the thymus gland may, from its situation, produce great and serious inconvenience, it would be absurd to question, and perhaps there is sufficient evidence to shew that it may occasion the symptoms and results of this very disease: but it is far from being proved that spasm of the glottis may not occur, and even prove fatal in cases where no such enlargement existed. Alterations of size, shape, and structure, even if rapid, take place gradually, and their results should be gradual also, whereas this disease has been known to destroy its victim in its first and only paroxysm; and moreover, if structural change in the gland was its sole exciting cause, it would be difficult to account for its sudden disappearance on the removal of the child to the country and its diet being changed. Whilst therefore it may not be denied that hypertrophy of the thymus can occasion the phenomena by others attributed to spasm of the glottis, there is not sufficient proof of its being the general or even frequent cause of this peculiar disease. I shall have occasion to notice the supposed consequences of pressure on the recurrent nerves hereafter.

It is questionable how far spasm occasioned by the contact of noxious or irritating substances can justly be termed sympathetic, for they are the results of an application of a direct stimulus: it is immediate in its effects, and more or less complete according to the nature or quality of the exciting cause. Death from total submersion in carbonic acid gas occurs so quickly as almost to seem instantaneous, and the spasm entirely occludes the glottis. The mildest form of spasm seems to be that occasioned by the accidental admission of some particle of food which is usually expelled again very quickly by a cough sufficiently distressing but seldom dangerous: yet instances have been known of the apparently trifling occurrence of the introduction of a particle of salt being attended by a fatal result.

However, when spasm is, or appears to be produced by the presence of a foreign body in the œsophagus or the trachea, or by the pressure of an aneurismal tumour, it is evidently sympathetic, and it may be interesting to inquire into the evidence by which such relation of cause and effect is established.

I had formerly entertained the opinion that spasm of the glottis should be the consequence of some irritation applied to the larynx itself, and not external to or at a distance from it, and therefore that the presence of a foreign body in the œsophagus ought not to hold a place amongst its exciting causes. I have since, however, altered my views on the subject, and indeed, when we consider the number of cir-

cumstances under which this morbid action may occur, we cannot be justified in denying it in this case in opposition to most respectable testimony. Mr. Kirby has published a case in the Dublin Hospital Reports, in which death was apparently produced by spasm of the glottis in consequence of the lodgment of pieces of meat and bone in the œsophagus: and Dr. Stokes saw an instance in which a piece of money was lodged in the œsophagus and where croupy breathing and other laryngeal symptoms were manifestly the result. In this latter instance the foreign body was not lodged in the fauces or pharynx. I have myself seen cases to corroborate the above, but it is needless to swell this article with proofs of a pathological fact that will probably not be called in question.

It is probably a new observation—at all events it is one of great pathological interest, that spasm of the glottis may be produced by the presence of a foreign body lodged within the bronchi. In the month of May, 1836, a child was brought from the country and placed under the care of my friend Mr. Cusack: his father's account of the case was that he had swallowed a small pebble, was instantly seized with a violent paroxysm of cough, had croupy or sonorous breathing ever since the accident with occasional remissions and exacerbations, but was sometimes brought to the verge of suffocation. The stethoscopic indications were that the foreign body was loose and mobile within the trachea. I assisted Mr. C. in performing the operation of tracheotomy on this child; but, although the aperture in the windpipe was made very large, no stone was expelled, and the size of the organ did not admit of the employment of any forceps with which we were furnished. Immediately on the opening into the windpipe being perfected the croupy breathing disappeared, neither was there a severe paroxysm of cough experienced afterwards, and the father, either doubting that the foreign body had ever obtained admittance, or dissatisfied at its not being removed, carried him off to the country contrary to the wishes and advice of his medical attendants. We afterwards heard that the little pebble had been coughed up in about three weeks after he left town, but have not been informed as to the ultimate termination of the case.

On the 13th of September, 1839, a child, aged three years and a half, was brought to the Meath Hospital: he had, half an hour previously, swallowed a small stone, and was instantly seized with a violent cough which continued up to the period of admission. His breathing was quite stridulous—countenance expressive of great distress—face and lips lived—efforts at respiration hurried and gasping. The left side of the chest heaved violently, the right was comparatively quiet: respiration very weak and interrupted in the right lung, in the left loud and puerile: no dulness over either lung on percussion. I performed the operation of tracheotomy, but no foreign body was expelled, and yet the little patient experienced the greatest relief. The

trachea was too small to allow of the introduction of any instrument for the extraction of the offending substance if such was there, so I merely satisfied myself with keeping the wound open, in the hope of its being coughed up. Whenever from any accident the wound in the throat became obstructed, the breathing became dreadfully oppressed, but he obtained instant relief when it was opened again and cleaned. Such were the phenomena of the case generally up to the 6th of October, when it was found that the wound had gradually closed and healed so as to leave the artificial opening very small, and on that day, in consequence of the increased difficulty of breathing, I was obliged to open up the whole wound anew. This second operation afforded immediate relief. On the 6th of December the wound being again nearly healed, in a desperate fit of coughing he expelled a small stone about half an inch long by about two lines broad, through the rima glottidis.

There were many other interesting facts connected with this case, which I omit here, my object being only to show that the difficult respiration which rendered the operation necessary was not caused by the mechanical occlusion of the bronchi by the presence of the stone, but had its seat in the larynx. The child had always repose when not called upon to employ the rima in respiration, although the stone was present in one or other of the bronchi, and in this case it was remarkable that it shifted its position, as proved by stethoscopic evidence.

It is sufficiently well known that the pressure of an aneurism, and of course of any other tumour, on the trachea or bronchi will produce difficult respiration to such an extent as to simulate laryngitis and to place the patient's life in imminent peril. This has been supposed to proceed from the mechanical obstruction given to the passage of the air by the compression of the tumour, and I shall not deny that this cause may occasion inconvenience, but still may be allowed to doubt that it produces the stridulous breathing and other laryngeal symptoms—at least in the majority of cases. In the month of July, 1837, I was requested by another practitioner to see a case of acute laryngitis and to operate if I deemed it necessary. The case appeared to be seriously urgent: the man seemed to be on the point of suffocation; and having made some inquiries as to the history, and particularly as to the condition of the chest as ascertained by auscultation, I operated immediately. The relief was as marked and as decided as I had ever seen in any laryngeal affection; and, after allowing the patient two or three hours' repose, I had him removed to the Meath Hospital, in order to be under my own immediate care. He died on the fourth day afterwards from the bursting of an aneurism of the aorta within the chest, and on examination the larynx was found in a perfectly healthy and normal condition; yet was it evident, from the relief experienced on the opening being made below it, that the obstruction to respiration that existed during life

had been caused within this organ. Those who, with Le Gallois and Magendie, explain spasm of the glottis by a compression exercised on the recurrent nerves, may possibly consider that the aneurism in this case produced such pressure, and I am not in a condition to deny it, because the sac was collapsed and empty, and I could not say what pressure it might have created directly or indirectly when tense and full of blood. But the sac in no situation lay in contact with the nerve, or seemed to hold any relation to it that would lead to such a conclusion. I may add, incidentally, that I have seen aneurismal tumours which must have implicated this nerve, in which the spasmodic difficulty of breathing did not exist, and therefore whilst I believe that spasm of the glottis may be produced in consequence of, or in connexion with, the existence of some tumour compressing the trachea or bronchi, I cannot (in the present state of our knowledge) yield to the opinion that refers it so entirely to a compression of the recurrent nerve.

The ligaments of the larynx are, of course, liable to disease. Thus, during life, we argue on the possibility of an abnormal state of tension or relaxation, from observing certain alterations of the tone of voice which are thus supposed to be capable of being explained: but the most frequent morbid appearance found after death is ulceration, although there is no evidence of its ever commencing in these structures. In all cases of *plithisis laryngea*, the ligaments suffer severely and in some are actually destroyed; for the expulsion of the arytenoid cartilages by coughing is no infrequent symptom of that disease, and it could not otherwise occur. I have often imagined that this ulceration of the ligaments was one cause of the difficult respiration, particularly in cases where there is a marked difference between inspiration and expiration, by allowing to the arytenoid cartilages too great a degree of mobility, and permitting them to be thrown down on the rima. When the connexions between the cricoid and arytenoid cartilages are cut across posteriorly, it is easy to lay the latter down in such a manner as nearly to obliterate the rima; and if a similar division be effected by disease, why may not these little bodies, become loose, be acted on by the current of air and shut like a valve in every act of inspiration?

(W. H. Porter.)

LEG (REGIONS OF THE).—If the importance of a part, and the interest connected with the study of its structure and its diseases, be measured by the general amount of suffering through it entailed upon mankind, by its extreme liability to accident and injury, and by its value in the general movements and well being of the body, certainly the leg would possess claims to our consideration greater than any other portion of the system of the same extent. From the integument to the bone, and from the knee to the ankle, every part of it is the frequent subject of disease, more or less

interfering with the comfort, if not with the health, of the entire system.

It is composed of two bones, the tibia and fibula, with accompanying masses of muscles both before and behind, which act upon the foot.

If we divide the leg into anterior, external, and posterior regions, we find in the anterior the *tibialis anticus* muscle, the *extensor communis digitorum*, *extensor proprius pollicis*, and *peroneus tertius*; in the external region, the *peroneus longus* and *brevis*; and posteriorly, the two *gastrocnemii*, *popliteus*, *plantaris*, *tibialis posticus*, *flexor longus digitorum*, and *flexor longus pollicis*. Among these are running the anterior and posterior tibial and peroneal arteries, with their accompanying veins, nerves, and absorbents; all these bound together, and supported by strong fascial coverings, and enveloped in the general integument. Between this and the *fasciæ* just mentioned, is an important layer of cellular tissue, (*fascia superficialis*), enclosing the two *saphenæ* veins, major and minor, and the superficial nerves and absorbents.

It may be well to make some few observations upon the external form and characters of the leg, before describing the deeper seated parts. The leg, comprising all that part of the lower extremity between the knee above and the ankle below, is somewhat of a conoidal tapering figure, rather flattened on its anterior and outer aspect, full and round posteriorly. This shape renders permanent compression by means of a bandage very difficult. The contraction of the *gastrocnemii*, especially during walking, rarely fails in a short time to separate the turns of the bandage below, causing the lower ones to overlap each other, and producing constriction, irritation, and excoriation of the skin, above the malleoli. If this difficulty were more considered, and the importance of the bandage in diseases of the leg duly appreciated, we should see more pains taken in acquiring the art of its application than is now common; though we are happy to find that the minor operations of surgery are now beginning to receive much more attention than formerly, and to form a part of the general system of demonstrative instruction. Assuredly the aggregate amount of suffering relieved would be far greater by attention to these minutæ of surgery, than by the more striking, though not more important details of operations, which to the mass of practitioners can occur but seldom, if at all.

The projection of the muscles at the back part of the leg, produced by the two *gastrocnemii*, and known under the name of the calf, forms a characteristic peculiar to man. No inferior animal possesses it, not even the orang outang; and the feeble and uncertain gait of these animals, when in the erect position, at once demonstrates the value of the muscles of the calf of the leg, and that this position is natural only to man himself. The form and expression of this part of the leg varies much according to age, sex, and general habit. In infancy the *gastrocnemii*, in common with the

development of the whole lower extremity, are small and feeble. The upper extremities are, in early infancy, even larger than the lower; these latter do not acquire their full growth and proportions till adult age. In the female, the general form of the leg is less marked and prominent, and more rounded than in the male, while, in this last, the leg presents every possible variety of proportion, according as habits of exercise on foot, robust health, or long continued sickness, has invigorated or enfeebled the muscular system at large, or this portion of it in particular. The broad and rounded surface of the calf of the leg is contracting as it descends, and at the lower part projects like a kind of cord, representing the *tendo Achillis*. In contraction, the calf shows two portions, marked out by a double fissure, which indicates the situation where the *gastrocnemius* join the soleus, the lower elevation being formed by this last muscle, which extends lower down the leg than the *gastrocnemius*. This projection of the soleus is in some much more marked than in others, and is indicative of considerable power when it reaches lower down, much more so than when the whole prominence of the calf is high up. In persons celebrated for pedestrian powers we have observed this projection of the soleus in a marked degree.

In the anterior region of the leg, the form is considerably flatter than in the posterior, and narrows as we proceed downwards, at the lower part becoming almost round. During extension of the foot, this region is marked by longitudinal elevations and depressions, indicative of the situations of the muscles, and of the connecting portions of aponeurosis. An examination of these points will assist us in cutting down upon the arteries here, as the depressions mark the exact boundaries of the muscles, being produced by the aponeurotic processes, which dip between them.

The integument of the anterior region, generally covered with hair in man, and of a somewhat dense structure, enjoys sufficient mobility to admit of wounds being united by the first intention, provided the loss of substance be not great. Not being very extensible, abscesses, tumours, &c., have great difficulty in projecting externally in front of the limb, and consequently for the most part remain more or less flattened. The posterior part of the leg has an integument more soft and elastic, and possessing fewer hairs than the anterior, particularly on the inner side. The position of the skin, with relation to the parts which it covers, occasions a marked difference in the mode of repairing the ravages of extensive ulcerations or sloughings. On the front and outer part of the leg, where the skin is somewhat stretched over the tibia and fibula, the process of cicatrization can only draw together the sound parts to a small degree. In consequence the healing process is slower in completion, and the cicatrix less depressed in proportion than when it is situated posteriorly. On the contrary, in this latter situation, the skin being stretched only over soft parts, when a considerable portion of it has been destroyed, the contractile force of the new

skin has full opportunity to exert itself, and this it does sometimes to a degree that is remarkable, acting as a sort of ligature upon the back part of the leg. We have seen a case where, by the cicatrization of an old and very extensive ulcer, the lower part of the calf of the leg, viewed in profile, had an appearance as if more than half the entire leg had been cut away.* The most dense and strong part of the integument of the leg is over the inner side of the tibia where this forms the only covering of the bone, while at the upper and back part of the leg the skin is exceedingly thin and delicate, and devoid of hairs. We may here remark, in illustration of the properties of the integuments of the leg, important in relation to surgery, that the contractile property of the skin is usefully exemplified in amputation, when, should the flap of the integument be more extensive than we desire, even to a great degree, we always find that in the progress of the case it contracts so much as to exhibit no redundancy in the end; in fact that a large quantity of integument, however unsightly, is far less to be dreaded than the opposite defect. It is not our intention here to enter minutely upon the diseases of the parts we are now describing, but we cannot refrain from alluding to a state of disease of the integuments which we have never seen but in the leg, and of which we have met with no account in books. It consists in a soft elastic swelling, generally occupying the entire circumference of the leg, for the lower third or fourth of its length, though often much less. The skin over it is considerably redder than natural, and of a somewhat dark colour. It is not at all tender to the touch, but is exceedingly painful when the foot is down and in exercise; on pressing the finger firmly upon it no pit is left, but the skin is very white until the capillaries fill again, which they do slowly. Should the skin ulcerate, the sore is very slow in healing, and generally has a brownish unhealthy look, but the state in question often lasts for years without any ulceration occurring. The disease is very indolent, neither increasing nor diminishing in extent for many years. We have not been able to trace it satisfactorily to any cause more than too much standing. All the cases observed by us have occurred in females between the ages of twenty and forty, whose employment kept them very much on foot. It appears to us to consist in a varicose state of the capillaries of the cellular tissue and inner side of the cutis. No treatment that we have employed has had anything more than a temporary effect. Pressure, as long as it is continued, relieves it; but all the morbid symptoms return upon the remedy being omitted.

Immediately under the skin lies the cellular tissue, which is a part of the general cellular investment of the body, and is here known as the superficial fascia of the leg. It is generally pretty thick, and is easily dissected back in amputations. Placed between two solid layers, the aponeurosis and skin, it easily in-

flames and may become the seat of extensive inflammation and abscess. When the inflammation has terminated in gangrene, the sloughing process in this cellular tissue is very rapid and often very uncontrollable; and where this destruction has occurred to considerable extent, in the after process of reparation the new cellular web is so short, close, and inelastic, as to materially impede the freedom of movement in the limb. When pus has been formed, the facility which the loose texture of the superficial fascia offers for its spreading in all directions, points out the necessity for early and free incisions through the integuments; and even before this stage of the inflammation, and while it is in its most active state, the same bold practice offers us the best means of arresting its progress. This cellular layer is the seat of the effusion in phlegmonous erysipelas, anasarca, phlegmasia dolens, and partially so in elephantiasis. The distension which this tissue and the integument over it undergo in the diseases just mentioned, is occasionally enormous, and affords a striking contrast between the elastic properties of the natural and adventitious structures. When anasarca distends a leg upon which an old cicatrix exists, the newly formed cellular web of this part is so little elastic and so little admits the fluid into its cells, that a considerable depression is seen here in the midst of the general swelling.

Imbedded in this superficial fascia we find a number of veins which are various in size, none very large in the natural state, numerous, and here possessed of more surgical interest and importance than in any other superficial region of the body. They are principally arranged in two sets; one commencing about the inner ankle, and running along the inner side of the calf, terminates just below the knee by one trunk called the internal or major saphena. The other set form the saphena minor, by coming from the outer ankle, along the outer and back part of the leg, and terminating in the popliteal vein in the middle of the ham. This vein is superficial only in the lower two-thirds of the leg; after this, it passes through the layers of the aponeurosis, and runs under it till its termination. This is the more ordinary course of them, but no part of the circulating system is more various than these superficial veins in their divisions and arrangement. These veins, by becoming varicose, frequently occasion great suffering to the patient, and annoyance to the surgeon, by the difficulty of their cure. The saphena major is more liable to this state of disease than the minor; indeed few persons whose habits are to be much in the erect posture appear to attain middle age without being more or less troubled by it.

The deeper seated veins, which accompany the arteries, lie imbedded among the muscles, and from them receive considerable *passive* support, in sustaining the weight of the column of blood above them, and still more in an *active* sense, when, in contracting, the muscles swell and press against their sides, and thus assist in forcing onwards their contents. But these

* See article CICATRIX.

superficial veins are without this important help. Their sides are supported, on one hand, by the yielding layer of the fascia and muscles, and, on the other, by the integument. When, therefore, any impediment presents itself to the free transmission of the blood through the femoral, popliteal, or iliac veins, or even by the mere weight of the ascending column of blood, in persons who stand much, it is the superficial veins that suffer most, and a permanently dilated state is the frequent result.

The pathology of varicose veins has not received the attention which it deserves, and hence the conflicting opinions as to the precise nature of their origin; we must even now confess with Delpech that the nature and causes of the disease are unknown. It is quite clear that that state of disease of the veins commonly termed varicose comprehends more than one pathological condition, and probably has more than one mode of origin. Every instance of an enlarged vein cannot be considered as a varix, unless we confound under the same denomination a condition of the vessel natural and healthy except in regard to its size, neither originating nor terminating in a morbid condition, with every variety and degree of disease accompanied with enlarged capacity of the vein. We have seen the veins of the abdomen enlarged so as to fulfil the office of the vena cava inferior, which was obliterated. But there was not the slightest mark of disease in these superficial vessels. The uterine veins, also, in pregnancy become enlarged in a similar manner, thus answering to the call for the increased circulation of blood in the uterus. This state of the vessels has been aptly termed hypertrophy, and the term varix has been restricted to permanently dilated states of the veins, attended with the accumulation of dark blood, which more or less generally becomes coagulated and adherent to the parietes of the vessels. Of this latter species Andral enumerates six varieties: 1st, simple dilatation without any other change, such dilatation affecting either their whole length, or occurring at intervals; 2d, dilatation, either uniform or at intervals, with a thinned state of the veins at the dilated points; 3d, uniform dilatation with thickening of the venous coats; 4th, dilatation at intervals with thickening of the dilated points; 5th, dilatation, with the addition of septa within the vein, whereby the cavity is divided into little cells in which the blood lodges and coagulates; 6th, a similar disposition combined with perforations in the parietes of the veins, which communicate with the surrounding cellular tissue in a more or less diseased state by numerous small apertures. From repeated observation of its practical importance we should be inclined to add to this list one other variety, viz. when the varicose state had extended into, or existed distinctly in, the capillaries of the skin. We believe that in those troublesome ulcers known as varicose we shall frequently, if not generally, find this state of the minuter veins and capillaries, and we are more inclined to attribute the pain and the obstinate character of these ulcers to the pathological condition now

mentioned than to the mere vicinity of an enlarged vein as it passes through the superficial fascia. The causes of the diseased state in question have been variously stated, nor do opinions yet agree upon it, some attributing it to mechanical influence, and others supposing a morbid tendency. Both these causes probably act in different instances, or even cooperate in the same case; we shall now only mention in illustration of the effect producible by the mechanical influence of too much standing, that it is not necessary to suppose that the valves are either destroyed or even materially injured in structure to nullify their agency in supporting the column of blood above them, since ever so small a communication between the two columns, the upper and the under, is sufficient to destroy all the beneficial agency of the valves as supporters of the gravitating fluid in the veins. Therefore a dilatation of the vein merely enough to draw the opposed edges of the valve ever so little apart, or even a thickening of the valves preventing the accurate coaptation of their edges, will be sufficient to prevent their power of support to the superincumbent column, and as far through the vein as this defective state of the valves may exist, so far will the gravitating column of blood be virtually unbroken and entire, and in the same proportion will the tendency to the varicose state be increased. This reasoning will explain many, probably the majority of cases where the morbid dilatation having once begun goes on to increase rapidly by the continued operation of this exciting cause. That there are other causes capable of producing this state of the veins cannot be disputed; indeed the occurrence of it in parts not likely to be affected by the upright position, and even in several different parts of the body of the same subject, shews that there is occasionally a morbid tendency in the venous system to this particular state, which acts independently of any mechanical cause; but we believe that this predisposing cause is not necessary to the production of the disease, and that the morbid tendency, when it is met with, should be regarded rather as the exception than as the rule.

In considering the causes of the disease in question, we should not lose sight of the relative proportion of the deep and superficial venous circulations of the lower extremities, a proportion varying in almost every individual. In one, the superficial veins are large and numerous, and lie immediately under the skin; in another, they are few and small. It is obvious, that in the first case the blood retained by this route bears a large proportion to that passing through the deep set, much larger than it would in the latter case. In the first instance, therefore, these vessels will have a greater proportional weight of blood to sustain and transmit, than in the second; while, in those individuals who have the superficial circulation small, the blood is chiefly returned by the deep set, which, from circumstances before mentioned, are more equal to the task, and in such persons the diseased state in question

rarely occurs. This we conceive to be a rational and practical explanation of phenomena which are otherwise obscure.

It seems probable that that most troublesome ulcer, the varicose, is kept up, and the difficulty of its healing produced not by the irritation occasioned by the mere vicinity of the enlarged veins, but from the actually varicose state of the capillaries of the skin at that part; at least we have found such a state of the vessels frequently, if not generally, to co-exist with this species of ulcer. The depth of the cellular layer (superficial fascia) in which these veins lie should be accurately understood and borne in mind in performing the operation of passing a needle under the vein for the cure of varices, according to Velpeau's plan (a method which we have adopted with considerable success.) Should the needle be passed so deep as to reach the fascia, the inflammation would probably be severe, at any rate sufficient to complicate needlessly the operation. The thickness of the cellular layer varies in different subjects, according as it is distended more or less with fat or with accidental effusion; it is rarely, however, less than two lines in depth, thus affording abundance of room for the transmission of the needle.

The size of these veins of the leg in the healthy state is at the most not larger than a small goose-quill, but when varicose they sometimes swell to the size of the finger, and we lately saw a varicose enlargement of the saphena major a little below the knee, of the size of a large hen's egg; the quantity of blood that may in a short time be lost from them may hence be conceived. On the anterior region the veins are few, and varices but rarely occur comparatively. On the inner region the saphena major lies close upon the bone in part of its course, and even indents it deeply when distention has continued long. In cutting upon the vein in this situation, we must bear in mind the contiguity of the internal saphenus nerve, whose situation, with relation to the vein, varies much, sometimes being before, sometimes behind it. We cannot, therefore, lay down any rule for its avoidance, unless it be to open the vein parallel to its length. The saphena minor has a nerve running with it, which in phlebotomy must be avoided with the same precaution as the nerve on the inner side.

The two nerves found imbedded in this superficial layer of the leg are, 1st, the internal saphenus, which is the largest, and is passing from the inner side of the knee to the inner side of the foot, accompanying the saphena major vein; 2d, the external saphenus or *communicans tibialis* from the tibial nerve, which runs near the saphena minor through the lower part of its course.

Imbedded in the superficial fascia, we also find a set of *lymphatics*, principally on the inner side of the leg, receiving part of those from the sole and dorsum of the foot, while those absorbents which accompany the saphena minor are receiving their commencement entirely from the sole of the foot. All of these superficial lymphatics ascend to the

inner side of the thigh, and terminate in the inguinal glands. Hence diseases of the subcutaneous cellular tissue of the leg exert their influence upon the superficial glands of the groin, and are not unfrequently the cause of disease in them, which, without due inquiry, might erroneously be attributed to disease of the genital organs.

The *aponeurosis* of the leg forms an important part of its economy. It is a dense tendinous structure, which immediately invests the muscles, and partly affords them origin. In consequence of its strength and want of elasticity, it prevents swelling in deep-seated inflammations, and we are consequently obliged to divide it early and freely, particularly when suppuration already exists, and when the matter would otherwise burrow among the muscles. On the anterior region it is strong, very distinct, and tense. In its superior fifth, it gives attachment to the fibres of the tibialis anticus, extensor communis digitorum, and peroneus longus. Below, it is pierced by the anterior tibial and musculo-cutaneous nerves. It is attached above to the heads of the tibia and fibula, and along the crest of the tibia, stretching from this to the anterior edge of the fibula. At the upper third of the leg, it sends processes backwards between the muscles, to be attached to the bones, thus forming sheaths for the muscles, and affording to their fibres a greater extent of origin. At the lower two-thirds of the leg, the fascia is closely attached to the intermuscular tissue, but has here no septa from its own structure. At the lower third, it binds the tendons firmly down in their places, and by its transverse fibres opposite the ankle forms the anterior annular ligament of that part.* From the anterior edge of the fibula, this fascia passes over the two peronei muscles, and is again inserted on the posterior border of the bone, forming a sheath for these muscles, and dividing them from the soleus. The observations made above on the surgical treatment of purulent collections refer especially to this anterior portion of the fascia of the leg, on account of its greater strength, density, and inelasticity.

At the back part of the leg, the aponeurosis is a continuation of that of the ham. We may consider it as formed of two principal layers; one superficial, and the other deep. Attached to the posterior border of the fibula externally, and to the inner margin of the tibia internally, the first appears to arise from the expansion of the tendons of the sartorius, gracilis, and semi-tendinosus. Applied over the posterior surface of the calf, it is lost below in the fibro-cellular tissue surrounding the heel. This portion being thin and yielding, it allows deep-seated abscesses to become superficial with great facility. The second layer is a continuation of the aponeurosis of the popliteal cavity, and descends between the two layers of muscles; but splitting into two, at the point where the soleus detaches itself from the deep parts, one of its divisions follows the anterior surface of the

* See ANKLE-JOINT, REGIONS OF.

tendo Achillis, of which it completes the fibrous canal, formed posteriorly by the superficial layer; the other remains applied over the posterior surface of the deep muscles, and both arrive at the heel.

In its inferior third, this aponeurosis thus circumscribes three spaces. One is filled by the tendon of the muscles of the calf. The second incloses the flexor muscles of the toes, and the vessels. The third, which separates the two others, lies between the tendo Achillis and the posterior surface of the last-named muscles. The latter is remarkable, from being filled with fat and fibrous filaments, interlaced in various directions.*

We have, for convenience of description, detailed the anatomy of the superficial parts of the leg, without particular reference to the regional divisions, which become more defined, distinct, and practical as we investigate the relations of the deeper seated parts, and to which we shall therefore now limit ourselves.

In the anterior region, comprising all those muscles which rest upon the tibio-fibular fossa, we find, on dissecting the fascia from the upper part, only two muscles exposed, viz. the tibialis anticus and extensor communis digitorum. Lower down, we see in addition the extensor proprius pollicis coming out between the two last, and the peroneus tertius a slip of the outer side of the extensor communis. These four are, as it were, bound down in a canal, formed anteriorly by the aponeurosis, posteriorly by the tibia, fibula, and interosseous ligament. The direction of the tibialis anticus, its size, and boundaries should be borne in mind, as these form the surest guide for cutting down upon the anterior tibial artery. This muscle is of a prismatic form, tapering downwards, and its outer edge is indicated externally by a sulcus in the integuments made more apparent by extension of the foot. It is found more accurately by tracing a line from the middle of the space between the crest of the tibia and the fibula to the middle of the instep; and here, between this muscle and the extensor communis, the artery runs. The external muscles are the peronei longus and brevis; they are enveloped in a sheath of the aponeurosis, and are applied, for some extent, to the external surface of the fibula. They are completely separated from the extensors and from all the muscles of the posterior region by the two aponeurotic septa attached to the anterior and posterior edges of the bone. The adherence of the muscular fibres continuing until just above the outer malleolus, a transverse section, in the two superior thirds, does not entirely destroy their action upon the foot, while, lower down, it would render abduction almost impossible. We have not heard of an instance of the entire rupture of any of these muscles, nor is it an accident likely to occur, as they are not, from their situation, likely to be called upon for any very great exertion of power; but these muscles are occasionally liable to the accidental rupture

of some of their fibres, a circumstance attended with much more pain and distress in moving than the apparently slight nature of the accident might lead us to expect. We have had lately a case of this kind under our care, where the suffering and the injury to the movements of the foot were so great as at first to lead us to suspect a much more serious extent of injury than really existed. It was occasioned by attempting to push along a sack of corn with both knees, both feet being on the ground, and the heels raised, while the upper part of the sack was held in the arms.

The only artery of importance in this region is the anterior tibial. It commences from the trunk of the popliteal nearly at right angles, traverses the opening in the upper part of the interosseous ligament, close to the neck of the fibula, and below the head of the tibia. The angular curve which the artery makes at this part of its course, according to M. Ribes, accounts for the great retraction of it after amputation of the leg.* It descends upon the interosseous ligament, in the direction of a line drawn from the middle of the space between the head of the fibula and the crest of the tibia, to the middle of the instep. Through the upper part of its course it lies upon the interosseous ligament; as it descends it gradually advances upon the tibia, and runs upon the anterior surface of this bone through its lower third. It is found at the upper third of the leg, between the tibialis anticus and extensor communis digitorum; in the middle third, its course is between the tibialis anticus and the extensor longus pollicis, and about four inches above the ankle-joint it passes obliquely under the tendon of this last muscle, and then is found between its tendon and that of the extensor communis. It runs between two veins through its whole course. The nerve is on its outer side above; in front in the middle; and internal below. An extensible but resistant cellular sheath unites the whole. It is evident, that in the upper part of its course the artery will be found much deeper than at the lower, when it is lying among the tendons, but in the living subject the natural state of tension of the muscles keeps these tendons more elevated than after death, and we shall consequently find the artery, even in this situation, deeper than from dissection we might have been led to anticipate. The surgeon will find little difficulty in discovering this artery when it is required to be tied. The marks for his guidance are clear, and the situation of the vessel on the whole pretty uniform; but owing to the depth of its situation above, and to the immediate vicinity of the veins and nerve, some difficulty will be experienced in excluding these from the ligation. The only branch from it of any surgical importance is the recurrent tibial. This arises just after the trunk has passed through the interosseous ligament, and passes upwards in numerous branches to the parts below and to the outer side of the knee-joint, anastomosing freely with the inferior external articular artery. These

* See Velpéau's Anatomy of Regions, translated Hancock.

* See Velpéau's Anatomy of Regions, p. 473.

anastomoses form an important part of that system of collateral circulation by which the stream of blood is continued to the leg and foot, after the obliteration of the popliteal artery.

The anterior tibial artery may require to be tied in case of wound or aneurism. In wounds of the dorsal artery of the foot, it may be advisable to put a ligature at the lower third of the leg, when the anterior tibial is running between the tendons. Its course may be here ascertained by feeling its pulsation, or by observing the line of the tendon of the extensor proprius pollicis, on the fibular side of which it here lies. When about to tie it higher up, the incision in the integuments and fascia must be the more free in proportion as it is nearer the knee; and it may sometimes be advisable even to divide some of the fibres of the fascia transversely, to permit more freely the retraction of the muscular sides of the cut. In dissection, we so easily separate the muscles and expose the artery, that we may underrate the difficulty attending the operation of tying it. The depth at which it lies in this part, the constant contraction of the muscles, and the difficulty of retracting the sides of the incision, occasioned by the strong aponeuroses, all constitute considerable obstacles to the operation. This artery was subcutaneous in a case related by Pelletan, and is occasionally very small indeed, or even absolutely wanting. The first anomaly we have several times seen in dissection, and an instance of the latter is related by Fluguier.* In these cases a large branch of the peroneal, which had passed through the interosseous ligament a little above the ankle-joint, supplied the place of the lower part of the artery. In a case which was met with by Velpeau, he found this artery not perforating the interosseous ligament at all, but winding round the fibula just below the head of this bone, and in company with the musculo-cutaneous nerve.†

The artery is accompanied by two veins, one placed on each side, throughout its course. The anterior tibial nerve, which is a branch from the peroneal, runs on the fibular side of the artery first, and then obliquely crosses it, sometimes again passing outwards, towards the lower part of the leg. The deep-seated lymphatics following the course of the vessels, deep-seated disease of the front of the leg may produce alteration of the glands of the ham. A lymphatic gland is found in front of the anterior tibial vessels, a little below the opening of the interosseous ligament through which the vessels pass.

In the posterior region of the leg the muscles are arranged in two distinct layers, the superficial, composed of the gastrocnemius, soleus, and plantaris; the deep, of the popliteus, the tibialis posticus, the flexor communis digitorum, and flexor longus pollicis. The gastrocnemius becomes tendinous, considerably higher in the calf than the soleus, sending off

its broad thin tendon about the middle of the leg, to unite with that of the soleus, about the junction of its middle and lower thirds. The soleus, beginning its origin lower than the last muscle, from the bones of the leg, continues its muscular fibres lower in proportion, in this respect varying considerably in different subjects.

These two muscles, arising above by their distinct heads, and having but one insertion below, form in fact but one muscle, which Meckel has named the *triceps sura*. Their common tendon is of a strength proportioned to that of the muscles themselves, and is therefore exceedingly powerful. Notwithstanding, the combined action of the muscles is occasionally too much for the tendon, and in leaping, dancing, or other similar movements, it is sometimes ruptured. After this accident, the difficulty of cure results, not so much from the injury done to the tendon itself, as from the difficulty of bringing the two ends into apposition. In fact, complete union never occurs, the utmost extension of the foot never bringing the lower portion so high as the upper is retracted by the muscles. The union, however, which is of a cellular structure, becomes sufficiently strong to be perfectly serviceable. Boyer speaks of a partial rupture of the tendo Achillis, and describes with precision the symptoms, but we apprehend this form of the accident is very rare.* The pathology of club-foot, which has only of late years been clearly understood, shows that permanent retraction of the muscles of the calf, either primary or secondary, is its most frequent cause, and the division of the tendo Achillis and the other tendons of this part has in consequence been resorted to with great success.† The plan of operating which our experience leads us to prefer, is to insert a sharp-pointed bistoury through the skin, and pass it behind the tendon with its flat side towards it, till having reached its farther side, the edge is turned, and the tendon is divided in the withdrawal, without more division of the skin than the mere puncture. If the tendon is kept tense during the operation by the forcible flexion of the foot, and is not quite divided at one stroke, the undivided tendinous fibres are pulled and stretched, and partially torn from their lateral attachments, which occasions a sort of hissing noise, which is not heard when the force is not applied, till after the entire division of the tendon. The union here takes place in the same manner as in rupture of the tendon, but the treatment proceeds upon a somewhat different principle, since it is in this latter case the intention to keep the divided ends apart, and the foot is therefore placed at right angles, while, in the ruptured tendon, the foot is extended, in order to approximate the ends as much as possible. The extreme contraction of the muscle, in club-foot, leaves no possibility of further retraction of the upper part of the

* See Velpeau's *Anatomy of Regions*, p. 474.

† See Velpeau's *Médecine Opératoire*, tom. iii.

* See Boyer's *Maladies Chirurgicales*, tom. ii. p. 95.

† See Liston's *Practical Surgery*, p. 154.

tendon, therefore the whole separation, after the division, is performed by the moving of the lower part.

The powerful muscles, now described, are never known to be ruptured themselves, the tendon, as we have seen, yielding first, but a partial rupture of their fibres is not very uncommon, and is indicated by the same painful symptoms as were alluded to in speaking of the anterior muscles. It is worth remarking, on the great power of these muscles, that, great as is the force required, to elevate the whole body, by acting upon the heel, yet the muscles of the calf are not nearly so soon fatigued in walking as those on the front of the leg, whose labour is merely the elevation of the foot and toes, and of this every one must be sensible after unusually long exercise on foot.

Between the gastrocnemius and the soleus is the plantaris tendon, a long slender slip, which, after crossing between the muscles, runs on the inner side of the tendo Achillis, to its insertion. The belly of this little muscle is under the outer head of the gastrocnemius, close to the origin of which it arises. Authors describe the symptoms attendant upon rupture of this tendon, but the diagnosis of injury to so small and deep-seated an organ must be so uncertain, that we should be much more inclined to refer them to an injury of some of the fibres of the great muscles of the calf, especially when we compare the power of the plantaris with that of its tendon, the passive strength of the latter appearing greatly superior to the active force of the former.* Between the lower part of the tendo Achillis and the tendons of the deep layer of muscles, there is a considerable layer of cellular tissue, containing fat, and this is often the seat of troublesome chronic inflammation; and if suppuration follows, the abscess is often very difficult of healing, from the constant movement of the tendon, and the result is a troublesome sinuous ulcer, which can only be healed by keeping the foot entirely at rest.

The deep muscles, bound down in the posterior interosseal space, by the inter-muscular layer of the aponeurosis, are found lying in this order; the flexor digitorum communis, placed innermost, upon the back of the tibia; the flexor longus pollicis, on the fibula, and the tibialis posticus between them, and partly concealed by them. Upon this last muscle are situated the posterior tibial vessels and nerves. As they all of them have to pass nearly behind the inner ankle, the two outermost are gradually approaching to the flexor communis, as they descend, till they are nearly in contact one with the other. As all these tendons, either primarily or secondarily, act upon the ankle-joint, their action is retained after rupture or division of the tendo Achillis, so that the power of extension of the foot still remains, though in a feeble degree.

The arteries of this region are the posterior tibial and peroneal, and are given off from the termination of the popliteal. The anterior ti-

bial also has here a course of a few lines, from its origin, till it perforates the interosseous ligament. The posterior tibial may be considered as the continuation of the trunk of the popliteal. It commences about an inch below the origin of the anterior tibial, and where the popliteal divides into this artery and the peroneal. The course of the posterior tibial may be defined by a line drawn from the middle of the ham, to a spot half an inch behind the inner malleolus. In this course it is accompanied by two veins, one on either side, also by the posterior tibial nerve; in the upper part of the leg, this nerve lies to the inner or tibial side of the artery; it soon, however, passes over it, and inferiorly it lies to its outer or fibular side.

The posterior tibial artery is covered, in the upper and middle thirds of the leg, by the gastrocnemius and soleus muscles, but in the lower third only by the integuments, and by the superficial and deep fasciæ of the leg. In the upper third of its course, this artery rests upon the tibialis posticus muscle, in the middle third upon the flexor digitorum communis, and in the inferior third some fat and cellular membrane separate it from the tibia, and from the internal lateral ligament of the ankle-joint.

In the inferior third of the leg, the posterior tibial artery runs nearly parallel to the inner edge of the tendo Achillis; between the os calcis and malleolus internus, it lies nearly in contact with the sheath of the flexor digitorum communis.* The only branch of surgical interest given off by this artery in the leg is the nutritious artery of the tibia, which comes off about its upper third, and in amputation at this part sometimes bleeds freely.

In putting a ligature upon this artery, the difficulties attendant upon the operation vary according to the situation at which we seek for it. It is favourably circumstanced for operation in the inferior third of its course, being covered in the two upper thirds by the muscles of the calf. It may require to be tied for a wound in the sole of the foot, or for one behind the inner ankle. In either of these cases the artery may be found and tied with facility behind the inner malleolus. (See ANKLE-JOINT, REGION OF.) When, however, it is deemed desirable to tie it at the lower third of the leg, it will be readily found by an incision of from two to three inches in length, performed midway between the inner border of the tibia and the tendo Achillis. After the division of the integuments, the superficial fascia, and the deep fascia, the artery will be met with directly under the incision. Its accompanying veins sometimes completely conceal it; the nerve is here on the fibular side of it.

In case of secondary hæmorrhage after this operation, or in case of aneurism of the posterior tibial artery, forming in consequence of a wound of the artery in this situation, it may be necessary either to tie this vessel higher up in the leg, or to tie the popliteal femoral artery itself; it has been deemed prudent to give the patient the chance of success from the former

* See Dictionnaire des Sciences Medicales, article Jambe.

* See article ANKLE-JOINT, REGION OF.

operation, before having recourse to so severe and hazardous a measure as that of tying the femoral or popliteal artery.

The operation of tying the posterior tibial artery in the middle of the leg will be found much more difficult than either of the other situations mentioned, as this vessel here lies at such a depth from the surface, and is covered by the gastrocnemius and internal head of the solens, which in this situation is attached to the tibia. To expose the artery here, the leg should be bent, the foot extended, and both laid on the outer side. The incision must be of considerable length, not less than four inches, along the inner edge of the tibia. The integuments and fascia being divided, (care being at the same time taken to avoid the saphena vein,) the edge of the gastrocnemius muscle will be exposed; this will be easily raised and drawn to one side. The soleus must next be divided from its attachment to the tibia, and at the bottom of this incision will be discovered some dense aponeurotic fibres, which are part of the deep fascia of the leg. The muscular fibres in the incision must now be held wide apart, and carefully separated from this deep fascia preparatory to its division, and immediately underneath this fascia lies the artery, with its accompanying veins, one on each side, with the nerve on its inner or tibial side, and here situated about an inch from the edge of the tibia.

On the dead subject this operation is not attended with much difficulty; in the living, however, the case is very different; the muscles are then rigid and unyielding, and when the fascia which covers them is divided, they leave their natural situation, and become much elevated, so as to make the situation of the artery appear as a deep cavity, at the bottom of which the vessel is placed. The contraction of the muscles has been found in some cases so great an impediment to the operation, as to require the transverse division of part of the muscle. The operation of cutting directly from behind, through the fibres of the gastrocnemius, is obviously still more objectionable, from the cause just mentioned.

The second terminating branch of the popliteal artery is the peroneal. This is situated deeply, along the posterior part of the leg, taking the direction of the fibula; hence it is sometimes called fibular. It commences about an inch or two below the lower border of the popliteus muscle, after perforating the tibialis posticus at the commencement of its course, and descends, almost perpendicularly, towards the outer ankle. In this course, it lies close upon the fibula, between the flexor proprius pollicis and flexor digitorum communis. On reaching the lower extremity of the interosseous ligament, it divides into two branches, the anterior and posterior peroneal, the first of which passes through the aperture at this part of the interosseous ligament, and both of these run to the outer side of the foot. This artery is so small and so deeply seated, that its wounds are rare and unimportant. Hence but little has been said of its ligature, which

would be very difficult, and could only be performed at the middle of the external side of the leg. We should then divide the same parts as for the tibial, but on the opposite side, and as it is enveloped in the fibres of the flexor longus pollicis, we must also detach this muscle from the fibula.

Each of these arteries of the posterior region is accompanied by two veins, which frequently overlap the artery so as to conceal it from view, in the operation of securing it; they are also so adherent to its coats as to occasion some difficulty in separating them, so as to avoid including them in the ligature, particularly where the artery, as in the present instance, is deep-seated. The best mode of accomplishing this is to insinuate the aneurismal needle first on one side, and then upon the other, not attempting to bring it out on the opposite side of the artery, till, by this means, the lateral attachments are separated.

The deep nerve which accompanies the posterior tibial artery is the tibial, and is of considerable size, being the continuation of the trunk of the popliteal. It is situated, at first, to the outer side of the artery, and lower down it runs nearly behind it, and so close to it, that without care it may be injured, included in the same ligature, or even tied for that vessel.

It may not be amiss here to observe on the distinctive marks by which the nerve may be recognized, when passing the ligature under the artery, that besides the most essential, the absence of pulsation, which may occur even to the artery itself from accidental causes, the inexperienced operator will find considerable assistance from the following, viz. the firm, round, cord-like feel of the nerve, while the artery has a flattened yielding feel when pressed between the finger and thumb, and the whitish, somewhat glistening, and prominent round appearance of the nerve, the artery having a somewhat reddish colour, and a flattened, thick, and riband-like appearance, as it is raised upon the aneurismal needle. When the cut extremities of the two are seen together, after an amputation, of course the round open mouth of the one, and the prominent stump of the other, like a tight packet of thread cut across, are readily recognizable.

The lymphatics of these deep parts accompany the bloodvessels, and pass to the glands of the ham; hence diseases occurring in the parts beneath the aponeurosis of the leg exert their influence on the glands of the popliteal space.

The two bones of the leg united by the interosseous ligament form an elongated fossa in front which is closed in by the aponeurosis, and is larger at the union of its two superior thirds than at its extremities. The muscles being imbedded here are difficult to cut in circular amputations, at the same time that its depth prevents the formation of a good flap. Posteriorly, they form a gutter, or fossa, larger than the preceding, but also much more shallow, excepting at the lower part. Hence the deep muscles are easily comprehended in the

flap in amputation. In the circular operation the section of the flesh, which can only be effected by passing the point of the knife transversely over the bottom of the interosseous fossa, is equally difficult in the flap method, in making the anterior flap, in consequence of the depth of the space in which the muscles are lodged. The difference of size of the two bones and the posterior relative situation of the fibula renders some precaution necessary in dividing them with the saw. The foot must be turned in, so as to bring the fibula a little forward, and care must be taken to commence the section upon the tibia as being the longest and strongest, but to finish the section of the fibula first, since it is too thin and mobile to support the movements of the saw without breaking at the termination. In amputation above the tubercle of the tibia, it has been held advisable to remove the head of the fibula from its joint, since this small portion of the bone is of no advantage to the stump and by its mobility may be some hindrance in the after treatment. (See *KNEE-JOINT*.)

The small size and moveable nature of the fibula constitutes some difficulty in the treatment of fractures of the leg, since the application of the ordinary bandages, &c., would have a tendency to press the bone inwards against the tibia, and we not infrequently see, in old united fractures of these bones, this deformity to have been produced, in all probability, from want of due precaution in the application of bandages. The defect may be obviated by proper care, that neither the splints nor the cushions should take any bearing upon the fibula itself except at its two extremities, and great assistance may be derived from proper pressure, before and behind, upon the muscles, gently forcing them against the interosseous ligament and bearing outwards the bone attached to it.

After amputation of the leg, the tibia presents a triangular surface, having the apex forwards. As the skin covering it is hereby invested with the subcutaneous layer, it may, by pressure against this projection, ulcerate, or slough, and thus expose the bone. The great means for obviating this accident is to have a good supply of integument in the flap, so that, in bringing the parts together afterwards, they may not be drawn too tight over the bone. While this rule is attended to all will go on well, whereas when the integument is left scanty, nothing can prevent unpleasant consequences. It may often, however, be advisable to remove with the saw the projecting angle of bone, and as a matter of precaution we generally do this, though not attaching much importance to it.*

In amputating above the tuberosity of the tibia, we run the risk of opening into the knee-joint, as the synovial membrane is sometimes prolonged thus far. According to M. Lenoir the synovial cavity of the knee is continuous with that of the superior tibio-fibular articulation, once in four times.† There are always

three principal vessels to be tied in this operation: first, the anterior tibial, which is found, with its collateral nerve, close upon the interosseous ligament; secondly, the posterior tibial, in contact with the deep layer of the aponeurosis, and having its nerve to its outer side; and, thirdly, the peroneal, which is found imbedded in the flexor longus pollicis muscle, and may be readily tied without fear of injuring any nerve. These three arteries sometimes retract so far into the flesh after amputation, that to secure the anterior tibial it is necessary to cut through the interosseous ligament to the extent of some lines. This probably arises principally from the attachment of the muscles to the whole parietes of the interosseous fossa, while the vessels, enveloped by elastic cellular tissue, retract considerably.

It must be borne in mind, that in whatever situation the amputation may be performed, if it be the flap operation the arteries of the flap are much more difficult to be found and secured, owing to the oblique nature of the section, than where, as in the circular operation, the muscles and vessels are cut transversely through.

When the amputation is just below the tuberosity of the tibia, the nutritious artery has here sometimes a volume sufficient to require a ligature. With the exception of this last, the arteries to be tied will be nearly the same, in whatever part of the length of the leg the amputation is performed. The muscular branches seldom occasion much inconvenience from hæmorrhage.

It may not be out of place here to remark on the subject of amputations of the leg, that the division of the bones high up may often save the knee, and thus give a good bearing for a wooden leg, but that we are too often apt to act upon the principle that, in amputations below the knee, this joint must necessarily be the bearing point; whereas we are convinced that a much more useful stump is gained by saving as much as possible of the leg, at least as far as half of its length, with the view of applying the wooden leg to the stump itself, and so preserving entirely the use of the knee-joint. We have now adopted this plan, with the most perfect success, in several instances, and always to the great comfort and satisfaction of the patient. Indeed, the loss of the limb, which is thus remedied, is really little felt, when compared with the great inconvenience of making the knee the bearing point, and thus taking away all the benefit of it as a joint. The reason why this mode of operating has not been more generally adopted, appears to us to consist in the fear that the cicatrix of the stump is ill able to bear the weight of the body in walking, when pressed between the ends of the two bones and the artificial leg. But besides that by the flap amputation in the middle of the leg, (the best possible situation for this operation, when practicable,) a soft cushion of muscle can be added to the integumental covering to obviate the effects of pressure, the fact is that in the application of the artificial leg to this stump, the bearing is not entirely

* See Bell's Operative Surgery, vol. ii. p. 22.

† See Velpeau's Anatomy of Regions, p. 484.

upon the stump itself, but it is divided between this and some part of the anterior surface of the leg, generally falling most powerfully about the tubercle of the tibia. The bearing on the anterior part of the leg is so strong, that unless the precaution is taken of well padding that part of the wooden box, the pain occasioned by the pressure entirely prevents the use of the wooden leg; but by the use of this precaution all inconvenience is obviated, and by this support to the weight of the body a valuable help is found for the prevention of injury to the cicatrix of the stump.

The French surgeons used to recommend this mode of applying the artificial leg, but only in cases of conical stump, or at least where the integuments were from excess of inflammation after the amputation closely adherent to the bones.* But we have found it applicable to every case of amputation below the knee. The superiority which this wooden leg gives to amputations below the knee over all those at the ankle and through the joints of the foot is obvious. Besides saving the extra pain and risk of inflammation, it affords a much better point of support than the mutilated foot can form.

The anterior surface of the tibia being subcutaneous, and not covered by any artery of importance, indicates the region which should be chosen for exposing, when we would remove a portion, trephine, extract sequestra, balls, &c. Superiorly, as its external region is only covered by the origin of the *tibialis anticus* muscle, it is favourable to the same operation. This consideration is the more important since the publication of the very valuable observations of Sir B. Brodie on abscess in the cancellated structure of the tibia, a disease which till then was little understood and scarcely at all described, and which, from our own experience, we are inclined to think has not unfrequently cost the patient a limb, which by a more correct knowledge of the disease might have been saved.†

The periosteum of this anterior surface is the subject of troublesome inflammation more frequently than that of the other parts of the bone, in consequence of its greater exposure. Common inflammation of it is often productive of abscess, necrosis, &c., or in a scrofulous diathesis, of caries; while syphilitic inflammation is here showing itself in the form of nodes, occasioning great trouble to the surgeon and suffering to the patient, and generally leaving some permanent thickening. These nodes, which, as we have said, generally occur on the anterior surface of the bone, are sometimes thrown out upon the external and posterior parts, and when they do thus occur are doubly embarrassing to the surgeon from their deep situation among the muscles, and from the general similarity of the symptoms to muscular rheumatism; the extreme tenderness of

the periosteal inflammation, much more acute than that of rheumatism, and the more circumscribed nature of this tenderness, are signs which will facilitate the diagnosis, a subject, however, upon which it is not here the place to dilate.

In the fœtus, the tibia presents merely a slight curve anteriorly, which appears to be augmented in the adult by the weight of the body. The posterior muscles, stronger and more numerous, acting on the flexible bones, concur to the same end. Thus, in fractures, particularly from indirect causes, the angle formed by the fragments of the tibia is almost always in front, and the limb bends in the situation of the fracture.

Experience proves that the two bones of the leg are more frequently broken together than singly, a fact ascribed by Boyer to the strength of the knee and ankle-joints. The direction of an oblique fracture of the tibia is generally from below upwards and from within outwards, a circumstance due to the form of the bone. The end of the upper fragment then presents itself under the skin, at the front and main part of the leg. The most frequent situation of fracture of either of the bones of the leg is at the lower third; this, in the tibia, is readily accounted for by its being here more exposed to injury and being smaller and weaker than elsewhere; in the fibula, on the contrary, this part is not weaker, but is here placed more superficial, the upper part being completely covered and much defended by a cushion of muscle. Fractures of the tibia at its upper part are less liable to displacement than lower down on account of the greater thickness of the bone, but the vicinity to the knee-joint here increases the danger of a fracture considerably. In consequence of the thickness of the bone at this point, fractures here are ordinarily transverse, while the abundance of spongy tissue causes them to unite quickly and easily. The tibia is more frequently broken by itself than the fibula because it alone sustains the whole weight of the body, while the fibula has nothing to support. In fact if the fibula is generally broken at the same time with the tibia, the injury to the fibula is but subsequent to the other, and takes place because this slender bone is not capable of bearing the weight of the body, the impulse of external violence, or even the action of the muscles, after the tibia has given way.*

There is rarely much displacement, as regards the length of the bones, at whatever point their fractures may have occurred, unless the cause has continued to act after the solution of continuity. This appears to result from the muscles being inserted over the whole of the bony surfaces.

When the fibula alone has been broken, there is very little deformity resulting, as the principal support of the limb still remains, particularly if the injury has resulted from external violence. When however the cause

* See Dictionnaire des Sciences Médicales, Art. Jambe.

† See also some excellent practical observations on the subject in Liston's Elements of Practical Surgery, p. 95.

* See Cooper's Surgical Dictionary, article Fracture.

of the fracture is found in a violent twist of the ankle with dislocation, the deformity occasioned by this state of the joint is more or less considerable, according to the degree of this displacement.

(A. T. S. Dodd.)

MUSCLES OF THE LEG.—The muscles lying on the bones of the leg, both before and behind, are, with the exception of one, properly muscles of the ankle-joint and foot, since their primary action is exclusively upon these parts. (See article FOOT, MUSCLES OF.) For the convenience, however, of description they will here be demonstrated according to their situation.

The muscles of the leg may be classed into anterior, external, and posterior. The anterior lying in the space between the tibia and fibula are four in number, consisting of *tibialis anticus*, *extensor proprius pollicis*, *extensor longus digitorum*, and *peroneus tertius*. The *tibialis anticus* and *extensor longus* alone are seen at the upper part of the leg on removing the deep fascia; the *extensor proprius pollicis* emerging from between these muscles about one-third down the leg, and the *peroneus tertius* shewing itself as a separate slip of the *extensor longus*, about the same height, and at its fibular side.

1. *Tibialis anticus* lies upon the fibular and anterior surface of the tibia; *arises*, principally muscular, from the fibular side of the tibia, through its two upper thirds, from its tuberosity and spine, and from a small portion of the interosseous ligament, from the fascia of the leg, and from an aponeurotic septum placed between it and the *extensor digitorum longus*. The muscle is larger above than below; its fleshy fibres converge to a strong tendon which crosses from the outside to the fore part of the tibia, passes through a distinct ring of the annular ligament near the ankle, runs over the astragalus and os naviculare, and is *inserted* into the upper part of the os cuneiforme internum, and base of the metatarsal bone of the great toe. The insertion of the tendon is concealed in part by the adductor and flexor brevis of the great toe. Between the tendon of this muscle and the os cuneiforme we find a small bursa mucosa. This muscle is covered in front by the fascia of the leg, to which it adheres superiorly; behind it is in contact with the tibia and interosseous ligament, on the fibular side with the *extensor digitorum communis*, and *extensor proprius pollicis*. Its action is to flex the foot upon the leg by elevating the anterior part of the foot.

2. *Extensor longus digitorum*.—This muscle occupies the fibular side of the tibio-fibular fossa, as the last filled the inner side. This is a tapering muscle also; it *arises* tendinous and muscular from the fibular or outer part of the head of the tibia, from the head of the fibula, and from the anterior angle of that bone almost its whole length, and from part of the tibial side of it also; it also takes origin from the interosseous ligament, from the fascia of the leg, and from the aponeurotic

septum situated between this muscle and the last. Below the middle of the leg it splits into four tendons. These pass under the anterior annular ligament in one common sheath with the *peroneus tertius*. They then run along the dorsum of the foot, spreading as they go, and are *inserted* into the root of the first phalanx of each of the four smaller toes. Towards their termination each of the tendons expands into an aponeurosis, covering the upper surface of the phalanges, and this is strengthened by the tendons of the *extensor brevis* and gives attachment to the *lumbricales* and *interossei*.

This muscle is covered in front by the fascia of the leg, the annular ligament and the integument; posteriorly it rests upon the fibula, the interosseous ligament, and the tibia; externally it is in relation with the *peronei* muscles, internally with the *tibialis anticus*, and *extensor proprius pollicis*; along its lower and fibular border lies the *peroneus tertius*. On the dorsum of the foot its four tendons cross obliquely over those of the *flexor brevis digitorum*.

Action. To extend all the joints of the four smaller toes, and to bend the ankle-joint.

3. *Extensor proprius pollicis* lies between the two last muscles. Its origin is hidden by them. It commences about one-third down the leg, from the smooth surface of the fibula, between the anterior and tibial angles of that bone, of which surface it occupies part, through the middle third of its length, also from the lower two-thirds of the interosseous ligament. The fleshy fibres run obliquely forward into a tendon placed at the anterior border of the muscle, which after passing beneath the anterior annular ligament, and along the dorsum of the foot, is inserted into the bases of the first and second phalanges of the great toe.

Action. To extend the great toe, and to bend the ankle.

By its fibular side this muscle is in relation with the *extensor digitorum communis*; by its inner side with the *tibialis anticus* and anterior tibial vessels. The anterior border is covered by these two muscles, as low as about the middle of the leg, and inferiorly by the anterior annular ligament, under which it passes in a separate groove, and by the integuments. The posterior border rests upon the fibula and interosseous ligament, and it crosses in its course over the lower end of the tibia the ankle-joint, the anterior tibial vessels, and dorsum of the foot.

4. *Peroneus tertius*.—This, which is in fact a mere slip of the *extensor digitorum communis*, and is situated on its fibular side, is so closely connected with it at its origin that it can with difficulty be separated. It *arises* from the lower third of the fibula, being attached to the anterior border and inner surface of the bone; also from the interosseous ligament, and from an aponeurosis which connects it on the outer side with the *peroneus brevis*. It is inserted by a flat tendon into the fibular side of the base of the metatarsal bone of the little toe. Its action is to assist in flexing the foot upon the leg.

It is in contact with the fascia of the leg

anteriorly, with the fibula and interosseous ligament posteriorly, with the peroneus brevis on the fibular side, and with the extensor communis on the tibial side. Its tendon passes in the same sheath with that of the common extensor, under the annular ligament.

A very slight effort of the extensor communis and extensor proprius pollicis extends the digital phalanges, and, if their action be continued, they will be made to bend the foot upon the leg. This they are enabled to do by the manner in which their line of direction is altered by the annular ligament of the ankle-joint, as it gives them all the mechanical advantage of a pulley. The tibialis anticus and the peroneus tertius are the direct flexors of the foot on the leg, and if either act separately, it will give a slight inclination towards the corresponding side, and thus the last-named muscle forms one of that important set whose action is, by elevating the outer side of the foot, to throw the weight of the body on the inner side.* In the erect position these muscles take their fixed point below, and, by drawing on the bones of the leg, keep them perpendicular on the foot.

The external muscles of the leg are two, the peroneus longus and brevis. They occupy the whole length of the outer side of the fibula, and are placed between the extensors and flexors.

1. *Peroneus longus* is a long powerful muscle, arising from a small portion of the fibular side of the head of the tibia, from the upper third of the outer side of the fibula, and from the fascia of the leg and its intermuscular processes. Proceeding obliquely downwards, the fibres are attached to a strong tendon, which passes, in contact with the peroneus brevis, along a groove at the back of the outer malleolus, enclosed in a synovial sheath. The tendon then passes through a deep sulcus in the cuboid bone, behind the base of the metatarsal bone of the little toe, winding obliquely across the sole of the foot, covered by the muscles of this part, till it is inserted into the internal cuneiform bone and base of the metatarsal bone of the great toe. In the tendon opposite the cuboid bone, is usually found a sesamoid bone. A bursal sheath encloses it in its passage across the foot. The action of this important muscle is to assist in extending the foot upon the leg, but principally to elevate the outer side of the foot, and thus regulate the bearing of the leg so as to throw the principal part of the weight upon the great toe.†

This muscle is in contact on its outer side with the fascia of the leg. Indeed this aponeurosis almost invests it, dipping between it and the flexor behind and extensors before. The peroneus is in contact with the fibula on its inner side above, lower down it rests upon the peroneus brevis. When passing across the foot it lies close to the bones, and consequently is covered by all the muscles of the sole.

2. *Peroneus brevis* is situated at the outer

side of the leg, but lower down as to its attachments than the preceding muscle. It arises fleshy from the lower half of the outer side of the fibula to near the outer malleolus. It sends off a roundish strong tendon, which passes in the same groove behind the outer malleolus, and in the same synovial sheath as the preceding muscle, but after passing the malleolus it has a sheath proper to itself. It is inserted into the base of the metatarsal bone of the little toe. Connected on its outer side to the peroneus longus, on the inner side to the fibula, anteriorly to the common extensor and peroneus tertius, and posteriorly to the flexor longus pollicis.

The action of these two muscles is peculiar. By the change in their direction, after turning behind the outer ankle, they are enabled to draw the foot back, and so extend it on the leg.

The peroneus tertius is on the contrary a flexor; it lies before the fibula, and combines in this action with the tibialis anticus to assist the flexor. When, however, the three peronei act together, and without the other flexors, their combined action is to evert the sole of the foot, and thus counterbalance the effect of the feebleness of the outer side of the foot by transferring the superincumbent weight to the inner side. This action is particularly exemplified in skating, but it is essential to every movement of ordinary progression. (See article FOOT, MUSCLES OF.) When the foot is the fixed point, the peronei act by keeping the fibula and the whole leg steady, and thus, as in the act of standing on one foot, counteracting the tendency of the body to fall inwards.

The posterior region of the leg comprises seven muscles, six of which are acting on the foot and toes, and one is proper to the knee-joint. We shall examine them as they are met with in dissection, and shall therefore describe them as forming two layers, superficial and deep. The first contains three muscles: 1. gastrocnemius; 2. soleus; 3. plantaris.

1. *Gastrocnemius*.—This is situated immediately under the aponeurosis, and is a powerful muscle, broad and flat anteriorly, and convex posteriorly, and forming the greater part of what is called the calf. It arises by two distinct heads from the back and upper part of the two condyles of the femur, of which the inner is the longer, and somewhat larger. These heads have between them a broad sulcus, which forms the lower part of the popliteal space. They unite a little below the knee-joint, in a middle tendinous line, and below the middle of the tibia send off a flat tendon which unites with the tendon of the soleus, a little above the ankle.

The posterior surface is covered by the fascia of the leg; anteriorly it rests upon the popliteus, soleus, and plantaris, and popliteal vessels. When its heads pass over the condyles of the femur, they are guarded by synovial bursæ.

2. *Soleus*.—This is the second portion of that great muscle of the leg which has been

* For further observations upon the action of the peronei muscles, see article FOOT, MUSCLES OF.

† See also Quain's Manual of Anatomy.

named by Meckel the *triceps suræ*. It is seen immediately on raising the last muscle. It arises from two distinct situations; first, from the upper and back part of the head of the fibula, and from the posterior surface and outer edge of that bone for some way down. Second, from the oblique ridge on the posterior surface of the tibia, just below the popliteus, and from the inner edge of that bone during the middle third of its length. From these two attachments the muscle almost immediately forms a thick fleshy belly, which descends lower than the gastrocnemius before it sends off its tendon. This, which is flat and strong, soon unites to the tendon of the gastrocnemius to form the tendo Achillis, and is then passing to be *inserted* into the upper and back part of the projecting portion of the os calcis. At its insertion there is a small bursa between the upper part of the bone and the tendon.

The soleus is in contact with the gastrocnemius posteriorly; below its fleshy fibres appear on each side of the tendon of that muscle. Between its two origins the posterior tibial vessels and nerve are passing, defended from pressure by the tendinous expansion which is on the under side of the muscle, and which spreads across from tibia to fibula. This muscle is also in contact with the plantaris, the tendon of which crosses it obliquely from without to within. In front it rests upon the deep layer of muscles and upon the posterior tibial vessels.

The tendo Achillis is the thickest and strongest tendon in the body; it tapers downwards nearly to the heel, and before its attachment expands again a little. It lies immediately under the skin, and between it and the bones is a considerable layer of cellular tissue containing fat.

The action of the two last described muscles is to elevate the os calcis, and thereby to lift up the whole body. When this is done on one foot in the act of progression, the other is capable of being carried forward unimpeded by the irregularities of the surface. When the foot is the fixed point, the soleus by acting on the tibia and fibula fixes the leg, while the gastrocnemius fixes the femur, or by acting further, draws it backward so as to bend the knee and lower the body.

3. *Plantaris*.—This little muscle is entirely covered by the outer head of the gastrocnemius. It *arises* from the upper part of the external condyle of the femur, and from the posterior ligament of the knee-joint. Its muscular structure is only about two inches in length, and it sends its long slender tendon downwards and inwards, between the two great muscles of the calf, emerging from between them just where their two tendons unite; it then passes down in contact with the edge of the tendo Achillis, to be *inserted* into the heel at the inner side of that tendon.

The action of the plantaris is to assist the great extensors of the foot, and to draw upon the capsule of the knee-joint, so as to prevent any ill effects upon that ligament from the

motions of the knee-joint. It is occasionally deficient.

The deep layer of muscles consists of four: 1. popliteus; 2. flexor longus digitorum; 3. flexor longus pollicis; 4. tibialis posticus. They lie in close contact with the bones, and the last three of them are covered by the deep fascia of the leg.

This membrane is a thin expansion, dense in structure, connected on each side with the borders of the bones, and towards the ankles with the sheaths of the tendons; and if traced along the interval between the inner ankle and the heel, it will be found to cover the vessels and to terminate at the internal annular ligament. Immediately underneath it we find the deep layer of muscles now under consideration.

1. *Popliteus* is situated below and behind the knee-joint, is flat and somewhat triangular, being broader below than above. *Arises* within the capsular ligament of the knee-joint, by a round tendon, from the under and back part of the outer condyle of the femur; adheres to the posterior and outer surface of the external semilunar cartilage; perforates the back part of the capsular ligament, and forms a fleshy belly which runs obliquely downwards and inwards. It is covered by a thin tendinous fascia from the tendon of the semi-membranosus; *inserted* broad, thin, and fleshy into an oblique ridge on the posterior surface of the tibia, a little below its head, and into the triangular space above that ridge. *Action*, to bend the knee-joint, and when bent, to roll it so as to turn the toes inwards.

2. *Flexor longus digitorum* is thin and pointed at its commencement, but gradually increases, and then diminishes again as its fibres end in a tendon. *Arises* fleshy from the posterior flattened surface of the tibia, between its internal and external angles, below the attachment of the soleus, and continues to arise from the bone to within two or three inches of the ankle. The fibres run obliquely into a tendon, which is situated on the posterior edge of the muscle. This tendon runs in a groove of the tibia, behind the inner ankle, and then passing obliquely forwards into the sole of the foot, receives in its passage a strong slip from the tendon of the flexor longus pollicis. It then divides into four tendons, which pass through the slits in the tendons of the flexor brevis digitorum, and as they run along the under surface of the toes they are bound down by strong fibrous sheaths, within which there are also little accessory ligaments assisting in fixing them. They are *inserted* into the bases of the extreme phalanges of the four lesser toes. The action of this muscle is to flex all the four smaller toes, and to assist in elevating the foot upon the toes.

Previously to its division, the tendon of the flexor longus gives insertion to an accessory muscle of considerable power (*flexor accessorius*), which connects it to the calcaneum, and materially modifies the direction of its action upon the toes. Close to the point of division, the tendons give origin to four small

muscles (lumbricales), which may also be considered as accessories to the flexor longus.

When passing behind the inner malleolus, this tendon is in contact with that of the tibialis posticus, which lies close to the bone. They are inclosed in separate sheaths of synovial membrane. In the leg this muscle is bound down by the deep fascia, and covered partly by the posterior tibial vessels which separate it from the soleus; its anterior surface rests against the tibia, and overlaps the tibialis posticus muscle; in the foot, its tendon lies between those of the flexor longus pollicis which are above it, and the flexor brevis digitorum which lies beneath it.

3. *Flexor longus pollicis* is shorter but stronger than the former muscle. It is situated the outermost of the three deep muscles of the leg, in contact with the fibula. It arises tendinous and fleshy from the lower half of the posterior surface and outer edge of the fibula, with the exception of the undermost portion. The fleshy fibres terminate in a tendon which passes behind the inner ankle, through a groove in the tibia; next through a groove in the astragalus; crosses in the sole of the foot the tendon of the flexor longus digitorum, to which it gives a slip of tendon; passes between the two heads of the flexor brevis pollicis, and then runs in a sheath of tendinous structure which binds it to the under surface of the phalanx, and is inserted into the base of the last phalanx of the great toe. The relations of this muscle in the leg are, posteriorly it is covered by the deep fascia, which separates it from the soleus; anteriorly it is in contact with the fibula, and overlaps the tibialis posticus muscle and the peroneal artery. Its connections in the foot have been explained above. The action of the flexor longus pollicis is not confined to the great toe; by means of the slip of tendon, which it gives to the flexor longus digitorum, it acts also upon all the toes, and secondarily upon the foot itself, assisting powerfully in the elevation of the heel in progression. But the mode of action of this muscle, and its complicated relations with the other muscles of the foot, are too curious to be passed over with a slight examination; in fact, we think it may clearly be shewn that there is here one of the most curious and beautiful arrangements and successions of muscular action to be met with in the whole system. We have elsewhere shewn that, from the peculiar form of the foot, the action of the peroneus longus is essential to transmit the burden of progression from the weaker to the stronger side of the foot. (See article FOOT, MUSCLES OF.) Let us now follow on the progress of the foot in the act of walking, and we shall readily perceive the succession of action of its different parts, and the functions which each muscle performs. It is evident that the smaller toes being shorter than the large one, and nearer to the heel, they will, in the act of elevating the heel and propelling forward the body, come to their bearing on the ground somewhat before the great toe, their action being, in fact, by the breadth of base which

they give to steady the onward progress of the body, and to deliver over accurately and securely the weight to the great toe, the main organ of propulsion of the body. In order to accomplish this to the best effect, it is necessary that the succession of actions should be accurate and complete, and that the muscles of the smaller toes should exert themselves before that of the great toe. To this end the flexor longus pollicis gives a slip to the flexor of the toes, and by the commencement of its action, which merely firmly plants the great toe against the ground, rouses the muscles of the other toes, assisting them to complete their part of the process, while its own labour continues and is at its height when theirs is necessarily accomplished and at an end. Thus, by a beautiful combination and series of actions, the powerful effort of the great extensors of the foot is controlled and guided to its proper end, first by the peronei, next by the flexors of the smaller toes, assisted by the long flexor of the great toe; and the body propelled onwards and balanced on this toe, the action is completed by the further effort of this one powerful muscle. The economy of muscular power is here not less striking than the combination of action, for the flexor longus pollicis being inserted into the last phalanx of the great toe, its own proper action is not called for till after the muscles of the other toes have performed their part; this muscle, therefore, considerably the most powerful of all this deep layer, were it not for the simple expedient of the slip of communication to the other flexors, would be comparatively useless until the last moment of the propulsion onwards of the body. But now it lends its powerful assistance to the weaker muscles previous to its own peculiar effort, and when all its power is called for, the collateral demand has ceased.

4. *Tibialis posticus* is situated on the back of the leg between the last-named muscles. It arises fleshy from the posterior surface both of the tibia and fibula, immediately below the upper articulations of these bones with each other. Between the two portions of this attachment is an angular opening through which the anterior tibial vessels are transmitted. The muscle also arises from the whole interosseous ligament; from the angles of the bones to which that ligament is attached, and from two-thirds of the flat posterior surface of the fibula. The fibres run obliquely towards a round tendon, which passes behind the inner ankle, through a groove in the tibia. It is here situated close to the bone enclosed in a separate synovial sheath. It is inserted into the tubercle on the plantar surface of the os naviculare, sending tendinous filaments to most of the other bones of the tarsus, and to the metatarsal bones of the second and middle toes. This muscle is covered at the lower part of its origin by the flexor longus digitorum and flexor longus pollicis, and cannot be seen till those muscles are separated. But superiorly it is covered by the soleus only, and here the posterior tibial vessels rest upon it. Its anterior surface is in contact with the interosseous liga-

ment, the tibia and fibula. Its tendon runs close to the inner ankle and tarsal bones, and where it slides under the astragalus, is thickened by a cartilaginous or bony deposit within its fibres, analogous in force and use to the sesamoid bones in other situations. Its action is to extend the foot upon the leg, and to turn the sole of the foot inwards.

(A. T. S. Dodd.)

LIFE.—Few abstract terms have been employed in a greater variety of significations, or more frequently without any definite meaning at all, than the one now to be considered. And there is none regarding which it is more essential to possess correct ideas, in order to attain the fundamental truths of physiological science. The prevalence of what we deem very erroneous notions on this subject, will oblige us to follow a different plan in its treatment, from that which we should have adopted if our duty had been merely to give an exposition of the present state of our knowledge respecting it. We shall commence by offering a short statement of our own views, in order that we may, in the brief historical summary which it will be proper to include in this article, more concisely indicate what we regard as the errors and inconsistencies of the principal theories which have obtained credit at various times. We shall subsequently consider more in detail some of the questions which require fuller discussion.

I. GENERAL VIEWS.—We shall define LIFE to be the *state of action peculiar to an organised body or organism*. This state commences with the first production of the germ; it is manifested in the phenomena of growth and reproduction; and it terminates in the death of the organised structure, when its component parts are disintegrated, more or less completely, by the operation of the common laws of matter. This definition differs but little from that given in many physiological works—"Life is the sum of the actions of an organised being;" and we apprehend that we are more in accordance with the common usage of the term, in employing it to designate rather the *state or condition* of the being exhibiting those actions, than the actions themselves. In this sense alone it is properly contrary to *Death*, the condition of an organised body in which not only have its peculiar actions ceased, but its distinguishing properties been abolished (see DEATH); and it is then also contradistinguished from *dormant vitality*, a state frequently observed, in which living actions are suspended, but the vital properties of the organism retained, so as to be capable of again exhibiting them when the requisite conditions are supplied.

Life or vital activity, then, manifests itself to us in a great variety of ways,—in all those phenomena, in short, which it is the province of the physiologist to consider. The changes exhibited by any one living being, in its normal condition at least, have one manifest tendency,

the preservation of its existence as a perfect structure; by these it is enabled to counteract the ever-operating influence of chemical and physical laws, and to resist, to a greater or less extent, the injurious effects of external agencies. The first inquiry, then, which we have to make, in the inductive study of physiology, is into the *conditions* of these phenomena; and as in this process we follow precisely the same track as that over which the physical philosopher has already passed, we may advantageously avail ourselves of his guidance in it.

In seeking to establish the laws by which the universe is governed, or, in other words, to obtain general expressions of the conditions under which its changes take place, the enquirer first collects, by observation or experiment,* a sufficient number of instances having an obvious relation to one another, with the view of determining the circumstances common to all. The facility with which this process is performed will obviously depend upon the simplicity of the phenomena, and the readiness with which they admit of comparison. Where their antecedents are uniformly the same, they only need to be associated a sufficient number of times, for the mind to be satisfied of the constancy of the relation; and the general law of the effects is easily deduced. Thus, the law of gravitation is ascertained by the comparison of a number of corresponding but not identical phenomena; and the numerical ratio is established which governs the attracting force. To extend the application of this law, however, to phenomena that seemed beyond its pale, required the almost superhuman genius of a Newton; but the idea, once conceived, was easily carried out when the requisite data were attained. But what is the nature of the *law* of which we have just spoken as regulating the attractive force? It is simply an expression of the *property* with which the Creator has endowed all forms of matter, that its masses shall attract or tend to approach each other in a degree which varies in a certain ratio to their mass and distance. This property, it must be recollected, is *only* assumed to exist, as the common cause of the actions constantly occurring under our notice. If none of these actions were witnessed by man,—if, for example, but one mass of matter existed in the universe,—it might be endowed with this and every other property which we are accustomed to regard as essential to matter; and yet, from gravitation never being called into action, the mind would remain ignorant of the attribute.

Such a common cause, the conditions of whose action are so simple and uniform that we can account for, and even predict, by a process of deduction, all the phenomena which it can operate to produce, may be regarded for a time as an *ultimate fact*. It may still, however, be capable of union with other facts of a

* For the proper distinction between these modes of research, and their respective applications to physiology, see Brit. and For. Med. Review, April 1838, pp. 320 *et seq.*

similar order, under a still more comprehensive expression.* But it is not in every department of science that the same facility in the attainment of general laws exists. Where the phenomena are of such a complex nature that the operation of the real cause is, as it were, masked by the influence of concurrent conditions, or where (as often happens in physiology) the effects of the same apparent cause are totally different according to the instruments through which it operates, it is obvious that there will be great difficulty in the first stage of the inductive process—that of the classification of phenomena,—so great, indeed, that it may be regarded as one of the principal obstacles to the advancement of those branches of science in which it presents itself. Of all the branches of physical science, that of meteorology is the most obscure and apparently uncertain, and bears most resemblance to physiology. The changes which it concerns are daily and hourly occurring under our observation; and the general laws which govern them are tolerably well ascertained; yet the mode in which their actions are combined is so peculiar, as hitherto to have baffled the most persevering and penetrating enquirers, in their attempts to explain or predict their operation. But no one thence feels justified in assuming the existence of any new or unknown cause, capable of controlling or subverting the influence of the rest; and such a proceeding would not be justifiable, until all their possible modes of action have been ascertained and put aside, leaving certain residual phenomena not otherwise to be accounted for.

The peculiar difficulties which beset the investigation of the laws of *vital action* have greatly retarded our acquaintance with them, and have even led to the belief that the inductive process is not applicable to them. These difficulties have arisen, in the first place, from the obstacles in the way of the collection of phenomena; secondly, from the peculiarly complex nature of these phenomena; and, thirdly, from the vague hypotheses which have prevented them from being classed as simple facts on which generalisations are to be erected, or effects whose sources are to be ascertained, but which have clothed them in the delusive aspect of laws or causes. Until, therefore, the principles of philosophical induction are thoroughly understood, the peculiar combinations in which vital phenomena present themselves to our notice, their apparent dissimilarity from the changes which we witness in the world around, and their obvious adaptation to particular ends, might lead us astray into the labyrinth of unprofitable speculation with regard to the presiding agencies by which they are governed; and the retrospective view which we shall presently take will afford many examples of this error, even in recent times, and will in fact show that the legitimate objects of investiga-

tion, and the true mode of pursuing them, are only now beginning to be understood.

When we observe the circumstances under which vital actions occur, we perceive that at least two conditions are required for their production. The first is a structure in that peculiar state which is termed *organised* (see ORGANISATION); the second is a *stimulus* of some kind fitted to act upon it. Now this is no more than what we observe in the world around, where every action involves two conditions of a corresponding character. When water is changed into steam, for example, it is by the *stimulus* of heat. When a stone falls to the ground, it is by the attraction which the mass of the earth exercises over its own. The difference consists in the *peculiarity* of the actions exhibited by living beings, which are not identical with those elsewhere presented to us, and which we cannot imitate by any physical or chemical operations. Whilst the mechanical philosopher, then, refers to the *property* of gravitation as the cause of the effect just mentioned, the physiologist refers to the capability of exhibiting vital actions, when excited by certain stimuli, as the *property* of the tissue which manifests them. Thus, when he witnesses the contraction of a muscle, under the stimulus of innervation or of galvanism, &c. he regards the effect as due to a property of *contractility* inherent in the muscle, and standing in precisely the same relation to its organic structure, as gravity to matter in general. So far, however, the advance in our inquiry is more apparent than real; since it may fairly be said that, to speak of contractility as the character of a body exhibiting contractions, is merely a change in words without absolute gain. But, having done this, we are led to inquire the conditions under which this contractility operates; and to analyse a number of phenomena apparently dissimilar, so as to attain the general law of its action. In this manner we proceed in regard to other classes of phenomena; and we shall thus acquire (when our data are sufficiently precise and extensive) a knowledge of the properties of all the tissues or organised structures which compose the living body, and of the phenomena which their single or combined operation will produce, under the influence of their respective stimuli.

But the physiologist will not stop here. He will seek to inquire to what these properties are due, which are so different from anything exhibited by the same matter before it had become a part of the organised system. And, if he consider the matter in all its bearings, with a total dismissal of prejudice, he will be unable, we think, to arrive at any other conclusion than that they are due to the act of organisation, which, in combining the inorganic elements into new compounds, and giving them a peculiar structure, calls out or develops in them properties which had previously existed in a dormant state, but required these circumstances for their manifestation. To this question, however, we shall presently return, when

* Such would seem to be the tendency of certain recent speculations in regard to gravitation, molecular and electrical attraction, and chemical affinity.

considering other views which have been entertained respecting it. We shall now take a retrospective glance at the

II. HISTORY OF OPINIONS.—In the earlier ages of the world, before the true method of philosophising on any subject was understood, it was considered as a sufficient explanation of any phenomenon to apply to it some abstract term, expressing a vague idea of a property inherent in the body which exhibited it, without attempting to ascertain the conditions of its operation.* Thus, all the phenomena of the movements of the heavenly bodies were attributed to the agency of a “principle of motion,” the laws of which were scarcely even sought for. In like manner, the simple optical fact—that, when the sun’s light passes through a hole, the bright image, if formed at a considerable distance from it, is always round, instead of imitating the figure of the aperture,—was attributed by Aristotle to the “circular nature” of the sun’s light; whilst the mere consideration that the rays of light travel in straight lines, would, if properly applied, have explained this phenomenon, not only as regards the sun, but in the case of any other round luminous body placed at a sufficient distance. It is not wonderful, then, that the still more intricate nature of the phenomena exhibited by living beings, the obvious tendency of those presented by each individual towards the same end, and the seductive simplicity of the hypothesis, should have induced the philosophers of that age to regard all vital actions as the immediate results of one common cause; but that such a belief should have maintained its ground, with but little alteration, to the present day, can only be regarded as a proof of the lamentable deficiency in truly philosophical views among the cultivators of physiology.

To the supposed *cause* of vital phenomena the term *Life* was applied by the older philo-

sophers, who regarded it as a distinct entity or substance, material or immaterial, residing in certain forms of matter; and the cause, both of their organisation, and of the peculiar actions exhibited by them.* Every sect had its own notion of the origin and nature of this entity; some regarding it as a kind of fire; others as a kind of air, ether, or spirit; and others, again, merely as a kind of water. The fable of Prometheus embodies this doctrine in a mythological form, the artist being described as vivifying his clay statues by fire stolen from the chariot of the sun. Whatever was the idea entertained as to the character of this agent, all regarded it as universally pervading the world, and as actuating all its operations in the capacity of a life or soul; whilst a special division of it—a *divina particula aurea*—regulated the concerns of each individual organism. The opinions of Aristotle on this subject are very interesting, as presenting evidence of the tendency of his powerful mind to elevate itself above the level of his age, and as showing how completely even *he* was bound down by the prevalent tendency to hypothetical speculation, which seemed to offer so easy a solution to all the mysteries of Nature. “In considering what holds the fabric of the universe together, and forms out of the discordant elements a harmonious whole, he infers from analogy that it must be something similar in kind to that which forms and holds together an organised body, namely, a principle of life; and that this principle, from the appearance of order and design displayed in the universe, must also have intelligence.” “Besides this supreme animating principle ($\Phi\upsilon\sigma\iota\varsigma$), the author and preserver of all, there are many others which, by delegated powers, organise the bodies of animals and plants, so that all organised bodies whatever are to be considered as constructed by and constructed for their animating principles, which, like the great animating principle, from being invisible to mortal eyes, indicate their existence, their energies, and their species, only through the medium of the structures which they form. Now, of these structures they are not only the efficient causes but, in his opinion, the formal and the final; the causes of their motions, growth, and nutrition; the causes which give them a character and form; the causes on whose account they exist; and even the causes of their being afterwards liable to corruption, as nothing is corrupted but what has been nourished, and has some time or other partaken of life. But, besides being causes of organised structures in these different senses, they are subordinate to a higher power, which prescribes their operations, not merely with reference to their separate and individual plans, but with a reference at the same time to that general and comprehensive

* This mode of philosophising has been very happily ridiculed by Fontenelle. “Let us imagine,” he says, “all the sages collected at an opera—the Pythagorases, Platos, Aristotles, and all those great names which now-a-days make such a noise in our ears—let us suppose that they see the flight of Phaeton as he is represented carried off by the Winds; that they cannot perceive the cords to which he is attached, and that they are quite ignorant of everything behind the scenes. It is a secret virtue, says one of them, that carries off Phaeton.—Phaeton, says another, is composed of certain numbers which cause him to ascend. A third says, Phaeton has a certain affection for the top of the stage; he does not feel at his ease when he is not there.—Phaeton, says a fourth, is not formed to fly; but he likes better to fly than to leave the stage empty; and a hundred other absurdities of this kind, that would have ruined the reputation of antiquity, if the reputation of antiquity for wisdom could have been ruined. At last come Descartes and some other moderns, who say, Phaeton ascends because he is drawn by cords, and because a weight more heavy than he is descending as a counterpoise. Thus to see nature as it really is, is to see the back of the stage at the opera.”—Quoted in Brown’s Lectures on Mental Philosophy, Lect. v.

* The term $\Psi\upsilon\chi\eta$ was applied by the Grecian philosophers to designate this animating principle, which included, with what is now known as the vital principle, the sensory and intellectual faculties. To the series of vital actions which, by many modern physiologists, is spoken of as *Life*, the term $\Sigma\omega\eta$ was given by the Greeks.

plan on which the universe itself is constructed. It is under the influence of such a power that every particular species of soul regularly constructs a system of organs adapted to its functions; and every species of soul appears uniformly to have its own species of body."* Now it is a little singular that, whilst the tendency of modern philosophy has been to explode the idea of any secondary existence acting beneath the Creator on the constitution and actions of the universe, but to refer all its phenomena to the continued operation of the laws which He first impressed on matter, physiologists, neglecting the obvious analogy between the actions of the universe and those of any single organised being (the Macrocosm and Microcosm) pointed out by Aristotle, should have retained, with but little modification, his opinion regarding the second; and should still attribute the phenomena of life to a secondary agency existing in each being and modifying the ordinary laws of matter to its purposes. This subject, however, we shall dismiss for the present, to return to it hereafter.

The mode of explaining vital phenomena which has been adduced as an example of early speculation on the subject, appears to have resulted from two tendencies that may be observed to characterise the unenlightened mind both in past ages, and at the present time. The first is that which may be considered as natural to man in the infancy of philosophy,—to regard all matter, at least the grosser forms of it, as essentially inert, and therefore to attribute all spontaneous motion to a union of the thing moved with some substantial moving cause. Now, although modern science has given a more correct explanation of the causes of motion in the inorganic world, and has shown that, so far from being inert, every particle of matter is capable of exhibiting actions of various kinds when placed in certain relations to others,—the superficial enquirer still regards matter as inert *quoad* vital actions, and is unwilling to attribute them to any possible operation of its properties. And in this mode of reasoning he would seem borne out by the peculiar history of organised beings,—the phenomena of their origin, growth, decline, dissolution, and decay,—the contemplation of which, with the desire of accounting for them, occasions the second tendency to which we have alluded; that, namely, to infer from this history the existence of an unknown *something*, which during the living state preserves the integrity of the body, and the loss of which occasions the disintegration of the fabric. Thus it has happened that the doctrine of the animating principle has retained its hold over the public mind from the earliest ages of the world to the present day; and the vestiges of the opinions of the early Greek philosophers may be traced in the expressions, vital spark, vital spirit, breath of life, and others which are still prevalent.

The chief modification which these doctrines have undergone, in their transit to modern physiologists, has been the separation of the vital principle—the entity which is supposed to effect the organisation of the body, and to employ that organism as the instrument of its operations—from the soul or mental principle, which is concerned in a series of actions entirely distinct. It is somewhat singular, however, that even Aristotle regarded the *vous* or reasoning faculties as separable from the remainder of the *ψυχη*, and as capable of existing independently of the body; and a subdivision of this kind was adopted by the Roman philosophers, who designated the vital and sensitive principles by the term *Anima*, whilst to the rational they applied the name of *Animus*. We shall not follow these doctrines through all the modifications which resulted from the unfathomable profundity of some systems of philosophy, and the pretending shallowness of others; but shall proceed at once to the more modern opinions, which are either openly professed at the present time, or lurk in the unilluminated corners in which the heterogeneous relics of former systems find a hiding place, whose darkness is congenial to their disunited formlessness.

The ancient doctrine of the identity of the vital with the mental principle was revived by Stahl in a somewhat altered form. This philosopher maintained that the *rational soul* is the *primum movens* of organisation; that it is the ultimate and sole cause of organic activity; and that by its operation, according to certain fixed laws, it preserves the body from decay and cures the effects of disease. Still, however, a distinction was drawn by him between the acts of the *animus* and the *anima*, which was not observed by his followers, who have regarded him as wishing to identify them. He looked upon them as the common effects of one principle; and his great error was in supposing that any analogy or parallelism existed between them. Now it is necessary to bear this doctrine constantly in mind when reading the works of many of the physiologists of the last century, otherwise their meaning will be greatly misunderstood. In the writings of Whytt, for example, we constantly find actions referred to the *soul* as their cause, when it is perfectly evident that the author did not mean that the *mind* (as it is now termed) was at all concerned in them. This was the case with his whole class of vital and involuntary motions, to the production of which, he expressly states, *consciousness* is not always necessary. Although there are few if any philosophers who would avow such a doctrine as that of Stahl at the present time, we trace its effects very evidently exerted upon popular opinion. We have known it maintained by many well-informed persons, that the phenomena of life and mind are obviously so closely connected, that, to refer one class to the operation of the properties of matter without an independent controlling entity,—in other words, to set aside the doctrine of a vital principle,—necessarily implies the relinquishment of the idea of mind as a

* Barclay on Life and Organisation, pp. 429-433.

distinct existence. Nothing, however, can be more absurd than such a dogma. The two classes of phenomena are not connected otherwise than by a very remote analogy. All the phenomena of Life (putting aside, of course, those psychical changes with which we are contrasting them) concern matter only, and consist in its actions and reactions, and there is nothing in them related to feeling or consciousness; it is but reasonable, then, to refer them to the laws of matter if we can do so. But the phenomena of mind are universally allowed to be of a very different character; there is nothing tangible or material about them; and, whether we regard them as causes or results of material changes, our reasons must have a very different basis than the existence or non-existence of a vital principle. On this point all the most intelligent of modern writers are fully agreed.*

The doctrine of "the vital principle," which is at present very commonly received under some form or other, may be regarded as having been first put forth in a distinct form by Barthez, who invented this term to signify something distinct from either mind or body, but nevertheless capable of existing by itself. The *vis medicatrix nature*, which figures so prominently in the theories of Hoffmann and Cullen, is nothing more than the same hypothetical agent under a different name; for by this term was denoted a "sort of in-dwelling guardian of the body," which "presides over its functions in the state of health; and, when any accidental cause of disturbance has given rise to a temporary disorder in the system, exerts itself to the best of its ability, with a sort of instinctive effort, often well directed, though sometimes liable to mistake, to restore the healthful and regular condition."† No one can have observed the phenomena of Life in morbid conditions of the body without witnessing examples of the *tendency* to reparation in the various parts which have suffered from the ravages of disease or injury; but this tendency results, like their ordinary operations, from their original constitution as parts of an organised system, and not from any independent agent whose existence can be demonstrated; so that if the common phrase, "the healing power of Nature," be employed at all, it should

only be used as a general term for the expression of this tendency. Precisely the same may be said of the "Nisus Formativus," or *Bildungstrieb* of Blumenbach. If it be employed merely as a general expression of phenomena evidently directed by their unknown cause or causes towards the same end, it is unobjectionable; but care must be taken lest it be supposed that something has been gained by such a generalisation, which, in fact, merely refers to the *final cause* and not to the *efficient cause*, and does not, therefore, carry us forward one step in the inquiry into the latter. If, on the other hand, it is intended thus to designate an agent whose operations produce these phenomena, it cannot be distinguished in any way from that commonly spoken of as the vital principle. Of a similar character would seem to be the "organic agent" of Dr. Prout, the "organic force" of Müller and other German physiologists. If by them are intended any *entities* separate from matter, or any forces distinct from those which the action of its properties creates, they evidently come under the same category.*

We arrive, then, at last at the doctrine of the vital principle, which, since the time of Hunter, has prevailed in Britain, especially amongst his disciples, until a comparatively recent period, when its unphilosophical character, its inability to explain the phenomena of Life, and the absence of any valid evidence for such an hypothesis, have been made apparent. It is not easy to discover, however, from his writings, what were the precise opinions of Hunter upon this topic; for the inquirer is constantly perplexed by the peculiar vagueness of his expressions, which, if taken in a rigid sense, would indicate ideas quite opposed to one another. Thus, we find him at one time speaking of the brain as itself the *materia vita* in a concentrated state, and speculating that "something similar to the materials of the brain is diffused through the body, and even contained in the blood." But he elsewhere intimates his opinion that the principle of life is independent of organisation, a something superadded to the organised structure, as magnetism to iron, or electricity to various substances with which it may be connected. This view was warmly espoused by Mr. Abernethy; so warmly, indeed, that he almost transforms the *analogy* into *identity*, maintaining that "if the vital principle of Mr. Hunter be not

* Thus Mr. Abernethy, in his Exposition of Hunter's Theory of Life, contended against confounding perception and intelligence with mere vitality. Dr. Prichard remarks (Review of the Doctrine of a Vital Principle, p. 71), that the conscious principle or mind and the vital principle, "supposing for a moment that both really exist, are entirely distinct in their nature and attributes." And Dr. Alison's authority fully coincides with those already quoted. "Whatever notion we may entertain respecting the existence of a vital principle, it has no connexion with our notion respecting the existence of mind." (Outlines of Physiology, p. 3.) These three physiologists may be regarded as fairly representing three different classes of opinions regarding the vital principle; the first being a zealous partizan of its claim to be considered a distinct entity, the second as zealous in opponent of the doctrine, and the third taking an intermediate position.

† Prichard, op. cit. p. 17.

* Such expressions, says Rudolphi, (Translation by How, p. 216,) may be approved of "when it is wished briefly to mention the unknown cause of life; but it is extremely objectionable to presume that they have thereby explained anything. Authors generally commence at first with the modest declaration that they mean, by the word *vital power*, no more than the unknown origin of life; but this mask of modesty is presently thrown aside, and they proceed as if the thing had been quite clearly proved. It is now become a *something* which is imparted to the body in a certain quantum; and they talk of increased and diminished, exalted and fallen vital power, &c., and thus they have a *Deus ex machinâ* which must help them through all obstacles. In such a case was Brown with his Excitability."

electricity, at least we have reason to believe it is of a similar nature, and has the power of regulating electrical operations."

We shall now inquire into the precise import attached to the term by those who continue to employ it. It has been well remarked by Mr. Mayo that the word *principle*, "characteristic of a less advanced state of science, has been generally employed (as the final letters of the alphabet are used by algebraists) to denote an unknown element, which, when thus expressed, is more conveniently analysed." Thus, it has been customary to speak of the principle of gravity, of electricity, or of magnetism, as the unknown causes of certain phenomena, whilst these are imperfectly comprehended. In so far, however, as the laws of these phenomena are understood, they terminate in referring all the results to simple properties of matter, from which they may be deduced by demonstrative reasoning, just as geometrical theorems from the postulates on which they are founded. But in the science of physiology the term has been employed in a less justifiable sense. It must be admitted on all hands, that the conditions of vital phenomena are not yet determined with sufficient precision to enable us to refer all observed facts, through the medium of general laws, to simple vital properties; and there would be no objection, save the probability of its abuse, to the employment of the term "Vital Principle," like "Nisus formativus" or "Organic Force," as a convenient expression for the sum of the unknown powers which are developed by the action of these properties. But to this limit physiologists have unfortunately not restricted themselves. They have regarded it as a distinct entity endowed with properties of its own, in virtue of which it acts upon matter,—removing its particles from the pale of physical and chemical laws,—transforming them into organised tissues,—endowing these tissues with new properties,—prompting their actions,—preserving their composition in defiance of external influences which would tend to disintegrate them,—and finally quitting them, or being itself worn out with them, so as to leave the framework without its protecting influence, deprived of which it speedily falls to decay.

Of the character of this principle, its expositors leave us very much in the dark. Of all modern writers, Dr. Prout is probably the one who has most plainly expressed himself on it. In his *Gulstonian Lectures** he informs us that, "In all cases it must be considered an ultimate principle, endowed by the Creator with a faculty little short of intelligence, by means of which it is enabled to construct such a mechanism, from natural elements, and by the aid of natural agencies, as to render it capable of taking further advantage of their properties, and of making them subservient to its use." The fallacies involved in this supposition have been elsewhere so ably exposed† that we shall not here stop to discuss it; but in our survey

of the nature and causes of vital actions, we shall take occasion to inquire whether any such hypothesis is called for, or whether it is not worse than useless by complicating what is otherwise readily explicable on simple and philosophical principles.

III. NATURE AND CAUSES OF VITAL ACTION.

It has been already pointed out that all the changes in the external world are the results of the properties of inorganic matter, called into exercise by the means appropriate to excite or stimulate each to activity; and we may further observe that these means are different for each property. Thus, to develop the dormant property of gravitation in any mass of matter, we should only have to bring it within the sphere of attraction of any other mass. But to develop the dormant electrical property of a loadstone, a mass of iron alone would serve. Every operation in chemistry is founded upon the same principle, each substance acted upon being capable of responding, in a manner peculiar to itself, to the influence of agents brought to bear upon it. Now, however familiar this idea may seem, it has been too much neglected in the investigation of vital phenomena; and notwithstanding that we always find a similarity of action, when the organised structure, on the one hand, and the stimuli which call its properties into activity, on the other, are identical—and a difference in either of these conditions always producing a difference in the result,—physiologists have been in the habit of looking to some other agency for the cause of the variation. It is true that we occasionally meet with instances in which the result is different, without our being able to detect any change in either of the conditions; but, knowing as we do how very slight an alteration in the structure of a tissue or organ will at once destroy or entirely change its vital properties, we cannot wonder that they should undergo important modifications without their sources being perceptible to our present means of research; and, as will hereafter be more fully shown, every extension of our powers of observation renders this doctrine more probable.

When we analyse the mass of phenomena which are presented to us by the vital actions of the organised world, we find that they are susceptible of reduction into distinct classes, by which the study of them is much facilitated. Thus, all living beings introduce into their own structure alimentary materials derived from external sources; and all likewise submit their fluid ingredients to the influence of the element they inhabit, in such a manner that a reciprocal change occurs between them. In this mode we arrive at the notion of the distinct *functions* of living beings, each of which may be regarded (in its simplest form) as a group of phenomena of similar character and referable to the same causes. Thus, the function of respiration, when stripped of all the acts sometimes associated with it, is essentially the same throughout the whole organized world;* and the simplicity of the changes involved in it,

* *Medical Gazette*, vol. viii. p. 261.

† *Roberton on Life and Mind*, p. 36 et seq.

* See *Prin. of Gen. and Comp. Phys.* ch. ix.

together with the facility with which it may be made the subject of experiment, render our knowledge of its character and conditions nearly complete.

When we have analysed these groups of vital phenomena and satisfied ourselves of the conditions under which they occur, we are brought to the conclusion that for each a particular organ or species of structure is appropriated in the organized system, and that its action is dependent upon the excitation of its properties by agents external to it, just as in the inorganic world. This dependence of life upon external stimuli has been completely overlooked by the advocates of the vital principle; and it is probably to Brown, with all his faults and absurdities, that we owe the first prominent enunciation of the fact. When these stimuli are withdrawn, vital action ceases; though, under favourable conditions, vitality or the vital properties of the organism may be retained. (Sect. VI.)

Every class of organs in the living body may be said to require its particular stimulus for the display of its properties. Thus, regarding the whole structure as a series of *assimilating* organs—capable of converting nutrient materials into structures like their own, and of thus causing them to exhibit vital properties—we may say that the supply of these nutrient materials in a fluid state is the stimulus to their action. Again, to the *excretory* organs the required stimulus is the presence of certain superabundant and therefore injurious elements in the nutritious fluid. To the action of the muscular system the excitement of innervation, or the application of a physical stimulus, is necessary. In all classes of living beings we find these functional changes performed under conditions which are essentially the same; and hence we are enabled to arrive at the laws which regulate each.

These are not the only conditions required, however; for others of a still more general nature are constantly, and therefore imperceptibly, operating. All vital actions, for example, require a certain amount of *heat* for their performance, and the amount varies in different cases. This is no more, however, than what we meet with in the inorganic world; for many chemical and physical operations can only take place within certain limits of temperature, and these sometimes very circumscribed. The presence of *light*, again, is essential to many others, especially in the vegetable kingdom; but this, again, finds its parallel in the inorganic world, many chemical decompositions (which indeed bear a remarkable analogy with the changes which this agent produces in the green parts of plants when exposed to an atmosphere containing carbonic acid) being due to its influence. And although, with regard to *electricity* as a vital stimulus, our absolute knowledge is still less, what we do know leads to the belief that it is an agent of at least as much importance in the vital economy as in the operations of inorganic nature.

There is nothing, then, in the nature or conditions of vital actions considered individually,

which need cause us to reason upon them in any other way than we do upon the phenomena of the inorganic world; and it is obviously unphilosophical to *assume* an agency which is not required to account for them. It must be recollected, too, that the *onus probandi* rests with those who make the assumption, and not with those who maintain the analogy in the character of vital phenomena to those of the universe at large. The assumption may be easily shown to be not only useless, but insufficient to explain phenomena without calling to its aid the very principles which have been shown to be themselves competent. Thus, the physiologist who traces the operation of the vital principle in the function of secretion, is compelled to allow that, as by one principle so great a variety of products are eliminated by the various glands from one material, the difference in the results must be due to some difference in the structure of the organs respectively concerned. And it may then be fairly inquired of him, "If the difference in the glandular structure and action is capable of giving rise to so great a variety in the products, with the cooperation of this one vital principle, how can it be proved that this difference in the glandular structure and action may not be capable of giving rise to the same result by itself, and without the aid of any such adjunct at all?"* A similar question might be put with regard to any other class of actions, in which, under the same general conditions, the results are modified by the peculiar characters of the instruments or organs respectively employed; and, as a negative reply must be given equally to all, it may be safely affirmed that no reasoning can deduce the doctrine of a vital principle from the phenomena of life separately considered.

But the advocates of the doctrine rely much upon the peculiar adaptation of the various changes taking place in each being to the purposes of its existence; and assume that this adaptation can only result from the control of a subordinate presiding agent constantly exercised over each. Here, again, we find such a doctrine not only unsupported by, but manifestly inconsistent with, the analogies of nature. No reflecting mind has any doubt that this earth and its inhabitants form a system, of which every part is perfectly adapted to the rest, (so that we might almost call it an *organised* one, if the idea of a particular structure were not involved in the term,) and of which all the actions and changes, however in appearance contrary, have one common tendency—the ultimate happiness of the creatures of Infinite Benevolence. The same may be said of it in regard to its relations with the system of which it forms a part; and probably of that system with regard to the universe in which it is but a speck. So far as we can understand the working of the laws by which that universe is governed, we see them all mutually adapted to the same ends, whether we consider the welfare of the whole system, or of our own comparatively insignificant planet, with

* Prichard on the Vital Principle, p. 100.

its countless living inhabitants. Have we, then, any more reason to assume that a vital principle or organic agent governs the concerns of each of these beings, than to suppose that the Creator has delegated to a subordinate the care of each individual globe? Or is it not more consistent to suppose that upon the elements of *all* He impressed those simple properties, from whose mutual actions, foreseen and provided for in the laws according to which they operate, all the varieties of change which it was His intention to produce, should necessarily result?

By another illustration of a different character we hope to set this point in a still clearer light, and to be able to dismiss the subject without entering upon it as an abstract question. We shall suppose a young physiologist, entirely ignorant of physical science, but educated in implicit faith in the vital principle, witnessing for the first time the action of a steam-engine. Here he would perceive a machine composed of a number of dissimilar parts connected together, and moving by some secret agency which he desires to unveil. We may imagine him trying various experiments upon its functions,—such as shutting off the communication between the boiler and the cylinder, or between the cylinder and the condenser,—or applying cold where heat should be, and kindling a fire under the cold-water cistern. Hence he may arrive at the just conclusion that the actions performed by each part, when the machine was in regular operation, have all a tendency towards one common object—the maintenance of its moving power. He will also perceive that these actions are as dissimilar as the structure of the parts exhibiting them; and he will not escape being surprised that the opposite influences of heat and cold should be essential to their production. Hence he may safely conclude that the whole series of phenomena is due to one presiding agency—a “steam-engine principle,”—by the operation of which upon the material structure, its actions are produced, and made to harmonize with each other, and with their ultimate object. And this conviction would be very much strengthened if he saw the machine endowed (as we may, for illustration, imagine quite possible) with the means of supplying its own wants,—regularly adding fuel to its fire, and cold water to its condensing cistern,—and even repairing for itself the loss it sustains by wear of material. Would such a person, entirely unacquainted with the properties of steam, be acting more unphilosophically in entertaining this notion, than in attributing the actions exhibited by living beings to the operation of a vital principle? We think not. In each case the machine or organism is framed to take advantage of the properties with which the Creator first endowed matter; and the difference is that, while the design of man constructed the first to bring into operation those properties which alone he can control, the design of Omnipotence constructed the second, and adapted it to develop properties of matter, which can only be exercised under the condi-

tions which a living being supplies, and of which man, therefore, cannot avail himself.

We may conclude, then, that if we can refer vital actions to the *properties* of the organs which exhibit them, called into operation by their appropriate stimuli, we do not require any other explanation of their mutual adaptation and dependence than the original design of the Creator. “No agent,” it has been well remarked, “can be required to adjust and regulate the actions which ensue from this mutual adaptation, since they are, like all other phenomena in the universe, under the control of laws inseparable from their very existence.” But the question next arises, by what means have organised bodies become possessed of these peculiar properties? It is, as we have before remarked, a mere verbal alteration to attribute the vital actions of an organ to its peculiar properties; since we understand by these properties only the *capability* of giving rise to the changes which we witness, and we only know of their existence by the observation of these changes. The real *causes* of the phenomena must be sought for in the events which were concerned in the formation of the structure, and its first endowment with the properties which it exhibits; and this leads us to consider,

IV. THE CONNECTION BETWEEN VITALITY AND ORGANISATION.—When our enquiry into the laws of Physics terminates in referring any of its phenomena to the action of one of the *universal* properties of matter, we feel satisfied that we can trace the operation of second causes no higher; and that the existence of this property as inseparable from matter, and therefore as essential to our idea of it, is the immediate result of the will of the Creator. But in a great variety of instances we cannot do so; and we observe properties restricted to and inseparable from certain forms of matter, the laws of whose action, however, are as definite as in the first case. Such properties, therefore, form a part of our notion of those particular forms of matter; thus, the magnetic properties of iron, or the energetic attraction which potassium has for oxygen, are characteristics of these substances, which combine with others to distinguish them in our minds from other forms of matter possessing many properties in common with them. But these properties will not be manifested except under peculiar conditions; and according to the rarity of the occurrence of those conditions will be the probability of our remaining ignorant of the property. We are obliged to admit, therefore, that every form of matter with which we are acquainted may have properties of which we know nothing, simply because it has not been placed in the circumstances adapted to call them into activity; since it is only by an *action* of some kind that the mind can become cognisant of their existence. We see, then, that it is very possible that all matter, or at least all those forms of it capable of becoming organised, may be possessed of properties which shall give rise to the actions termed *vital*, when they are placed in certain conditions; and that the mere absence of any mani-

festation of these, while the substance remains in the condition of inorganic matter, is no proof that they do not appertain to it.

We find nothing, then, in our fundamental ideas of matter, to oppose the doctrine that vital properties are developed in it by the very act of organisation. But we shall consider the question in another point of view. We are constantly witnessing examples of the *total change* effected upon the properties of certain forms of matter by their entrance into new combinations. Thus, how completely different are the properties of a salt from those of the acid and alkali which unite to form it. And we are not obliged to have recourse to chemical union for cases of such a change; since there are examples in which mere mechanical admixture of the particles of different bodies will produce the same. How different, for instance, are the properties of gunpowder from those of any of its ingredients. They are all combustible it is true; but in a manner as unlike it as each other. Does any one think of assigning any other cause to these changes than the act of combination or admixture? Does he seek for it in the operation of a saline property *superadded* to the compound of acid and alkali; or of a combustible *principle* presiding over the combined actions of the nitre, sulphur, and charcoal, and directing them to one common object? If not, why should he adopt a different course in regard to vital properties?

In our investigation of natural phenomena, we *never* observe a substance endowed with new properties, without it has undergone some change in its own condition, of which altered state these properties are the necessary attendants. Unless, therefore, an instance could be produced in which the *same* form of matter shall at one time evince properties of which it is proved to be destitute at another, we have no right to speak of any *property* as *distinct* from the matter which exhibits it, or as capable of being *superadded* to it or subtracted from it. It may be desirable for us to pause here, in order to examine a case in which it has been alleged that such an addition takes place, and which has been used as an analogical argument in support of the doctrine of a vital principle. It has been commonly said that a living body, in assimilating and organising the nutrient matter by which the changes essential to its existence are maintained, *superadds* or communicates to it by a separate act, those vital properties of which it was itself previously possessed; and there is no more difficulty, it has been argued, in conceiving how vital properties may be communicated to organised matter, than in understanding how magnetic properties may be *superinduced* upon iron. But the analogy is based upon a false conception of the latter process, which is really conformable in character to those by which gravitation or any other properties of matter are brought into action. For the so-called communication of magnetic properties to iron is nothing more than the production of a change in the conditions of the metal, by which its electric properties are manifested in a manner peculiar to itself, and caused to give rise to magnetic

powers. If, then, an analogy exists between the two processes, (which can scarcely be denied,) it leads us to the belief that, just as magnetic powers are developed in iron, when the metallic mass is placed in a condition to manifest them, so the very act of organisation develops vital powers in the tissues which it constructs. For no one can assert that there does not exist in every uncombined particle of matter which is capable of being assimilated, the ability to exhibit vital actions when placed in the requisite conditions; in other words, when made a part of a living system by the process of organisation. It is only the complexity of the conditions required to manifest it, which prevents our recognising this capability as a common property of matter, or at least of those forms of it which we know by experience to enter into the composition of organised structures.

Such are the conclusions to which we are led by the general comparison of vital phenomena with those of the external world; and it would be difficult, we might say impossible, to prove that there is anything in the former which removes them from the pale of such reasoning. In fact, it appears to us that observation of them alone would lead to similar inferences. We perceive organisation and vital properties simultaneously communicated to the germ by the structures of its parent; those vital properties confer upon it the means of itself assimilating, and thereby endowing with vitality, the materials supplied by the inorganic world. It is very true that in this germ we cannot perceive a single trace of the future being, the various organs and structures of which are evolved during its development. But these are not evolved in any other way than by the progressive extension and complication of the parts of the original germ. If we witnessed the aggregation of inorganic matter to form a head in one place, a trunk in another, and limbs in a third, and the subsequent union of these, we might be disposed to suspect the existence of some invisible agent which directed and controlled the operation; but we can trace nothing in the real process but the effect of the properties with which the structure of the germ is endowed at the same time and by the same act that it is organised by the parent. Nor is there anything in the subsequent life of the being that opposes such a view; on the contrary, much that confirms it. As long as each tissue retains its normal constitution, renovated by the actions of absorption and deposition by which that constitution is preserved, and surrounded by those concurrent conditions which a living system alone can afford, so long, we have reason to believe, it will retain its vital properties, and no longer. And just as we have no evidence of the existence of vital properties in any other form of matter than that denominated organised, so have we no reason to believe that organised matter can retain its regular constitution, and be subjected to its appropriate stimuli, without exhibiting vital actions. The advance of pathological science renders it every day more probable that derangement in

function always results, either from some structural alteration (although this may be of a kind imperceptible to our senses), or from some change in the character of the stimuli by which the properties of the organ are called into action. There is no difficulty, therefore, in accounting on this view for the death of the whole system on the cessation of any one function; since any perturbation in the train of vital actions will not merely disturb the regularity of all, but, if sufficiently serious, will check those nutrient processes on the uninterrupted continuance of which the vital properties of the several parts depend; the degree of that dependence being proportioned to their respective tendencies to spontaneous decomposition if not thus renewed. Still, the vital properties of individual parts may be retained for a considerable period after general or *somatic* death (see DEATH) has taken place; and vital actions may continue, as already stated, so long as the conditions which they require in the living body are supplied. So far from a dead body having "all the organization it ever had whilst alive," as has been often maintained by the upholders of a separate vital principle, it will be found, on a more minute survey, that no single portion of it is existing under the same circumstances in these two states;* and there is good reason to believe that those agents which destroy life with the least apparent organic change, produce structural alterations which are not the less important because more minute. Some instances of this kind will be presently noticed (Sect. V.). We must confess ourselves at a loss to understand how the *gradual* death of individual parts of the body can be explained upon the doctrine of the vital principle, without supposing that it may be split into as many individual existences as there are organs in the system; such an idea would then coincide with that of the *superadded properties* of which we have endeavoured to show the fallacy, and all the arguments derived from the unity of its operations would fall to the ground.

One often repeated objection to the doctrine that vitality results from organisation may, we think, be easily disposed of, as it is more specious than real. It is considered by some to be a sufficient disproof of this doctrine, to refer to the universally-admitted fact, that the existence of organisation implies a previous existence of life; and thence to infer that life cannot be at the same time the *cause* and the *consequence*. But this is a sort of paradox which reminds us of the question that puzzled the profound casuists of yore—"Whether does the bird spring from the egg or the egg from the bird?" It is evident that the life of any individual being may be the consequence of the action of stimuli upon its organism, just as the bird is produced by warmth from the egg; and yet that the organisation of its structure may be the result of the previous existence of life in the parent, just as the egg is produced by a bird. We are only referred backwards, therefore, in our enquiry into the efficient cause of

the development of vital properties, to the first creation of each organism. Here some would maintain that the Creator formed a vital principle or organic agent, and then set it to organise the body. But we apprehend that this is an assumption which we have no right to make; and that it is more philosophical, because more consistent with what we elsewhere witness, to suppose that the Creator, in first forming matter, endowed it with properties in virtue of which it became capable of exhibiting vital actions or life, when first combined by Him into an organised structure; and that the Parent of all thus impressed upon the elements of which each created being was composed, the spirit^o of the laws which should in future govern its growth and reproduction, just as He impressed upon the bodies composing the planetary system that mode of action whose subsequent continuance has given us the notion of the laws of gravitation and of motion. To account for the perpetuation of the race, we require nothing but the continued operation of those laws; in other words, the continuance of the same mode of action, by which particles of inorganic matter are successively organised, and, *quâ* organised, become capable of performing vital actions, a part of which consists in the production of corresponding changes on other materials.

The actions performed by living beings are not all, however, immediately dependent upon the operation of the *vital* properties of their organs; since many are evidently conformable to physical laws, and the properties of the organs by which they are performed are common to them with many kinds of inorganic matter, and are exhibited by dead as well as by living organised substances, as long as no obvious change takes place in their composition. Of this kind are the property of *elasticity* in various tissues, especially certain of a ligamentous character; and that by which *endosmose* takes place through certain membranes. It may be observed, however, that the existence of such properties in the tissues of the living body obviously depends upon a certain arrangement of their ultimate molecules, which can only be maintained by the exercise of their nutrient functions; and that any irregularity in the latter, still more their entire cessation, will speedily impair the properties, by giving free course to the constant tendency to decomposition in the tissues which exhibit them. And further, it may be remarked that in most instances these properties are dependent for their excitement to action in the living body, upon those truly vital processes which no mechanical contrivances or chemical operations can produce or imitate.

Between these two extreme classes of phenomena,—the purely physical, and the purely vital—there is a third, of a very peculiar and perplexing character. We allude to the actions concerned in preparing the *materials for organisation* out of the aliment received into the system. Many are disposed to regard these as of a *vital* character, and to consider that, as

* See Prichard on the Vital Principle, p. 117.

* Herschel's Preliminary Discourse, p. 37.

soon as the living body has begun to change the composition of the substances upon which it acts, it endows them with a new set of affinities, contrary to those which it before possessed when subject to the operations of chemistry. Others, again, are content to refer the operations in question at once to the ever-ready vital principle, which, according to them, produces and directs these changes in the organism, and, so long as it resides there, keeps in check the natural tendency of its structure to decay. We are inclined to believe, on the other hand, that the operations in question are *immediately* due to the agency of the same laws as those which preside over inorganic matter, operating, however, under conditions which the living organism alone can supply. We shall now examine what evidence may be produced in favour of this opinion, and how far it is consistent with the general phenomena of life.

V. CHANGES IN COMPOSITION.—The elementary materials which serve as the food of the living organism, cannot be appropriated by its several tissues, and rendered like themselves in structure and properties, until they have undergone certain changes in composition, by which the *proximate principles* are produced. It is by the *organisation* of these compounds, that the constant disintegration of the elementary parts of the living system is compensated, and those vital properties maintained, the exercise of which forms an essential part of the circle of actions involved in life. Another class of changes in composition consists in the production, from the same materials, of the peculiar ingredients which characterise each secreted product; some of these may be regarded as directly eliminated from the nutritious ingredients of the blood, in the same manner as are the solid tissues themselves; whilst others would rather seem to result from the new combination of the disintegrated elements, which are taken up and removed by the current of the circulation, and carried to organs destined to separate them entirely from the living portions of the system. All these changes are frequently said to be effected by a *vital chemistry*; or (to speak in more precise language) to result from the operation of *vital affinities*, of a different character from those ordinary *chemical affinities* which produce the well-known changes in the inorganic world. In conformity with the Newtonian direction to avoid unnecessarily multiplying *causes*, we shall briefly examine the grounds upon which this hypothesis is based, and enquire whether it is requisite for the explanation of phenomena, or even gives us any assistance in our researches.

The chief ground for the assumption of a distinct set of *vital affinities* appears to be, that the mode of union of the elements of the organic compounds is essentially different from that which prevails in the inorganic world; and that the chemist, who has the power of effecting or controlling those changes which are produced by physical laws, and can therefore imitate to a great extent the immense variety of combinations which the mineral kingdom affords, is unable to effect or control the action of

similar materials, so as to produce any of the class of organic compounds or proximate principles. It has, until very recently, been regarded as a distinctive character of organic compounds, that their elements are combined in *ternary* or *quaternary* arrangements of complex nature, in which each ingredient is equally united with all the rest; whilst all inorganic substances admit of being ultimately resolved into simple *binary* combinations. Thus *fibrin* is regarded as composed of 6 parts of carbon, 2 of oxygen, 5 of hydrogen, and 1 of nitrogen; and these elements are imagined to form a quaternary compound, all having a mutual attraction for each other; whilst *carbonate of ammonia*, which consists of 1 carbon, 2 oxygen, 3 hydrogen, and 1 nitrogen, is a binary combination of two other binary compounds, carbonic acid and ammonia. ~~But~~ on this it may be remarked, that there are undoubtedly some *proximate principles*, (that is to say, the simplest forms to which organic compounds can be reduced, without altogether disuniting them into their ultimate elements,) which consist of *two* elements alone, and which exist in this simple form in living bodies. Such are some of the compounds of carbon and hydrogen. Further, the rapid progress of analytic research is leading to the belief that the complex arrangements just referred to may be resolved into those of a binary character; so that most organic compounds may be regarded as resulting from the union of others of simpler nature, just as a salt is formed by the union of an acid and an alkali. The discovery of cyanogen, and of its capability of acting as a *compound radical*,—uniting, like chlorine or iodine, with hydrogen to form an acid, and even occasionally serving, like oxygen or sulphur, in combination with some metals, as the base or alkali to such an acid,—was the first step in a career of brilliant discoveries, which, even at the present day, may be regarded as scarcely commenced. When cyanogen combines with a metal, the combination is in reality a *ternary* one, although in all its properties it has a binary character. Thus, the cyanuret of silver (whose ultimate composition is 1 part of the metal, with 2 carbon, and 1 nitrogen,) will form a salt, in which it acts as the acid or negative ingredient, with the cyanuret of potassium; and the soluble cyanurets will form salts with the chlorides or iodides of the metals, thus establishing their claim to a binary character. But still further;—cyanogen in combination with iron appears itself to act as a *compound radical*, combining as a *simple* body with other elementary substances.* From the analogy afforded by this and other instances, many chemists are now disposed to look upon the combination of the oxy-salts in a new light. It is suspected that, when sulphuric acid and soda are brought together, the resulting compound is not formed by the union of an atom of the acid with an atom of the alkali, but by the generation of a new compound radical, *sulphatoxygen*, consisting of 1 part of sulphur with 4 of oxygen, which unites

* Liebig, in Turner's Chemistry, 6th ed. p. 776.

as a simple body, like chlorine, iodine, or cyanogen, with the metal sodium.*

It will be seen, then, that the tendency of modern researches in inorganic chemistry is to prove, that the mode of combination which characterises the union of its elements, is not by any means so simple as it has been usually supposed; but that a binary, a ternary, and perhaps even a quaternary compound, may perform the part of an element, combining with other elements which are really simple, to form what are regarded as simple binary compounds. We shall now enquire what reason there is for believing that the compounds with which organic chemistry supplies us, have a similar constitution. We must be content, however, with selecting one or two examples from among the vast number which the industry of analytic chemists is constantly bringing to light. The vegetable *alkaloids* have been generally regarded as *proximate principles*, not to be separated into simple compounds without an entire disunion of their elements. They all contain one equivalent of nitrogen; and there is good reason to suspect that this element is not equally combined with all the rest, but exists in union with hydrogen in the form of ammonia, to which the alkaline power of these substances is due. Again, camphor was long considered a proximate principle of ternary composition; but it is now found to be an oxide of *camphene*,—a compound radical consisting of carbon and hydrogen, which will unite, like cyanogen, with simple bodies; forming camphoric acid with another equivalent of oxygen, and entering with chlorine, &c. into other compounds. Lastly, *urea* may be mentioned, in which the four elements that compose it may be regarded as existing in several forms of binary combination. It contains these elements in the following proportions:—2 oxygen, 4 hydrogen, 2 carbon, and 2 nitrogen. These may be considered as existing in the form of cyanic acid, ammonia, and water; one equivalent of each of these forming cyanate of ammonia; and, in fact, by the artificial union of these compounds, *urea* has actually been produced. It is by no means certain, however, that these compounds exist *as such* in urea; and various ideas of its composition are entertained by chemists, on which this is not the place to comment. Our object is simply to show the analogy in the composition of the products of vital chemistry with that of the artificial compounds whose formation is subject to none but physical laws. Why the chemist is not more successful in imitating in his laboratory the operations of the living economy, will presently become subject for consideration.

An argument employed by many physiologists for the existence of a distinct set of vital affinities, is founded upon the evident truth, that the tissues and fluids which maintain a certain composition when possessed of vitality, speedily resolve themselves into new combinations when this has become extinct. Hence it is inferred that the affinities which hold toge-

ther the elements during life, are of a different nature from those which operate in producing their subsequent separation. Now, it may be objected to this inference, that no solid or fluid compounds which have a disposition to spontaneous decay after death, can continue to exist without change during life; that the activity of the processes of interstitial absorption and reposition seems to bear a pretty constant ratio, in every case, with the natural tendency to decomposition; and that the maintenance of the original combination is not so much owing to anything peculiar in the affinities which hold together its elements, as to the constant removal of particles in a state of incipient decay, and their replacement by others freshly united. Thus, we find that all the most permanent parts of the animal frame, such as the massive skeletons of the polypifera, the calcareous tegument of the mollusca, or the bony scales of fishes, to the possible duration of which geologists scarcely dare to assign a limit, are extravascular in the living animal, undergoing scarcely any interstitial change when once formed. Next to these in order of durability are the osseous structures of animals, and the woody fibre of plants, whose connection with the circulating system appears rather adapted to meet the exigencies of growth, injury, or disease, than to maintain a constant change required by the tendency to decomposition. When we examine the softer tissues, on the other hand, we find that the rapidity of interstitial change fully compensates for the increased tendency to decay; and that the perfect exercise of their respective functions imperatively demands the constant maintenance of their normal constitution. Moreover, there are many organic compounds which are as permanent as those formed in the laboratory of the chemist; of this kind are gum, sugar, and many other proximate principles, which simply require for their preservation such external conditions as are necessary to prevent the spontaneous decomposition of many inorganic bodies. The degree in which these are subject to ordinary chemical operations will be presently mentioned. It appears, then, to be an inference better founded on fact than that first mentioned, that the preservation of the normal constitution of organic compounds in the living body, is dependent on the continuance of the vital actions of the economy, rather than due to its mere possession of the property of vitality. In fact, *that* may be reasonably maintained as an inference from these phenomena, which we have already attempted to prove on other grounds;—that the vitality of each tissue, that is to say, its possession of vital properties, is dependent on the perfect condition of its organisation, and that, so far from preserving the organism from decay, it merely remains until decay has commenced. These inferences are, we think, fully borne out by the two following facts. When life is being extinguished by starvation, the whole body exhales a putrid odour even before the occurrence of death, and rapidly passes into putrefaction afterwards: here it would seem that the process of spontaneous decomposition, which we have

* See Graham's Chemistry, p. 158 et seq.

represented as constantly occurring in the tissues, has been unbalanced by the reposition of nutrient materials; and that it has therefore manifested itself in the body even during life. Again, when spontaneous gangrene occurs from obstruction to the circulation, decomposition slowly supervenes in the part from which the supply of nutrient fluid is cut off; and coincident with its progress is the extinction of the vital properties, constituting molecular death. (See vol. i. p. 791.) Corresponding changes may result in the whole body when the nutritive functions are interrupted, not by obstruction to the motion of the circulating fluid, but by deprivation of its character; and we then perceive the vital properties of each tissue impaired in a degree correspondent to the dependence of the integrity of its structure upon the constant renewal of its elements.

The presumed impossibility of forming, by the chemical combination of their elements, any of the class of *organic compounds* or *proximate principles*, is regarded by many physiologists as in itself a sufficient ground for the assumption that the affinities which act in the living body are different from those which we recognize in the inorganic world. The fact, however, which we have already noticed regarding the artificial production of *urea* is one which powerfully opposes such an assumption.* This is slurred over by Müller, with the remark that it can scarcely be considered as organic matter, being rather an excretion than a component of the body—a distinction which does not remove it from the pale of the operation of the supposed laws of vital affinity. Seeing the vast progress which organic chemistry has made during the last few years, and the rapid increase of our knowledge regarding not merely the composition but the mutual relations of the class of bodies under consideration, we cannot but think it premature to assert that other compounds may not be produced in a similar manner. Be it observed, however, that the doctrine for which we are now arguing only concerns the production of those compounds which are destined either to be thrown off from the system, or to undergo subsequent organisation; and cannot apply to those in which the process of organisation, and the consequent development of vital properties have already commenced. This distinction is a very important one, and may, we think, by being kept steadily in view, save much unsuccessful because mis-directed labour. If, for example, our view be correct, it may be possible for the chemist to produce the gum or sugar which he finds in the ascending sap of plants; but he can never hope to imitate the latex or elaborated sap, which already shows traces of organisation and of the possession of vital properties. In like manner the formation of albumen may be a worthy object of his endeavours, whilst these would be totally fruitless if directed to the production of fibrin,

which differs from it but little if at all in chemical constitution, but which is endowed in its fluid state with properties that nothing but the influence of a living system can generate.

But quitting these speculations, we shall inquire what positive evidence may be produced of the operation of chemical affinities in the changes of composition that form so important a part of vital action. Many facts might be collected which favour such a belief; but the following must here suffice. In the progress of vegetation we have frequent occasion to observe the conversion of gum and of fecula, which consists of gum enclosed in vesicles, into sugar. This takes place in germination, in the budding of the potato and other fleshy stems, in flowering, in the ripening of fruit, as well as in many other instances; in all these in which fecula is the subject of the change, it would seem that ~~this~~ product, having been stored away out of the current of the circulation against the time of need, is to be again brought into use, and to supply the pabulum of young or rapidly-growing parts by conversion into sugar. These changes are effected in various modes. Where gum is the subject of the conversion, we commonly find an acid employed to produce it, as in the ripening of fruits, where lignin as well as gum seems to undergo this change. The chemist can produce the same effect by digesting gum or lignin with an acid at a certain temperature. Again, where the conversion of fecula into sugar takes place as one of the ordinary processes of the vegetable economy, it is effected by the production of a secretion termed *diastase*, which occasions both the rupture of the starch-vesicles and the change of their contained gum into sugar. This diastase, which is abundantly stored up in the neighbourhood of the eyes or buds of the potato, may be separately obtained by the chemist; and it acts as effectually in his laboratory as in that of the vegetable organism. Further, he can imitate its effects by other chemical agents; for, by the joint operation of heat and acid, he can produce the same transformation.

These are among the remarkable instances of the *catalytic* action recently described by Berzelius,* which is common to organic and inorganic operations, and which is not yet found to be comprehensible within the known laws of chemical affinity. The peculiarity of the action consists in the production by one body, A, of a change in the composition of another, B C, without itself undergoing any alteration. Thus, the peroxide of hydrogen, which is readily decomposed by any substance having an affinity for oxygen, is also decomposed by some which themselves undergo no change, such as the metals and the fibrin of the blood; these produce in it a state analogous to fermentation, oxygen escaping and water being left. Again, not only decompositions but new combinations may be effected in this manner. Thus, most metals at high temperatures, and platinum in a state of minute division at low temperatures, as well as various porous sub-

* We do not quote any others reported to possess the same character, such as the production of fatty matter by Berard and Hatchett, because they still require confirmation.

* Edinb. Phil. Journal, vol. xxi.

stances slightly heated, produce the union of oxygen and hydrogen in an explosive mixture. The action of sulphuric acid on alcohol in producing ether, without itself undergoing change, appears referable to the same class along with those just described. We may consider it proved, then, that many substances possess the power of exercising upon compound bodies an influence essentially distinct from what is known as chemical affinity—an influence which consists in the production of a displacement and new arrangement of their elements, without themselves directly participating in it. Assuredly such a power, which is capable of effecting chemical reactions in inorganic substances as well as in organised bodies, though still too little known to be accurately explained, must play a far more important part throughout nature than we have hitherto been led to suppose. "In defining it a new power," says Berzelius with philosophic caution, "I am far from wishing to deny that some connexion exists between its influences and the electro-chemical ones with which we are familiar. On the contrary, I am very much disposed to recognize it as a peculiar manifestation of these same influences."*

Another interesting series of facts, which seem to confirm the theory of the operation of chemical affinity in the living body, is that which relates to the evolution of electricity during the ordinary processes of growth both in plants and animals. The late researches of Dr. Faraday have fully proved the identity of electrical attraction with chemical affinity, and have shown that all chemical changes are attended with a disturbance of electric equilibrium. If, therefore, the changes occasioned by the growth of organised systems are immediately governed by laws similar to those which preside over inorganic matter, we should expect to find that electricity is constantly being developed by them in the same manner as we obtain it by chemical decomposition or recombination. There is no deficiency of evidence that such is the case, as the results of late inquiries most abundantly testify.†

That chemists have not been more successful in imitating the operations of vital chemistry, by the artificial production of organic compounds, is due not only to their ignorance of the composition of such bodies, but to their want of acquaintance with the *form* or *condition* in which they must be brought together, in order to enter into the desired union. Every one conversant with chemical operations is well aware of the important influence thus exerted. A slight change of temperature, for example, often reverses the affinities of a body; and many elements are susceptible of particular actions when in a *nascent* state (*i. e.* when in the act

of being freed from some other combination) which in their ordinary condition could not be so affected. When it is considered, therefore, how little we know of the operation of such conditions in the laboratory of life, no surprise will be felt that its results should often appear contrary to what might have been anticipated. No reasonable ground has yet been adduced for supposing that, if we had the power of bringing together the elements of any organic compound in their requisite states and proportions, the result would be any other than that which it is found to be in the living body; for the agency of vitality, as Dr. Prout justly remarks, "does not change the *properties* of the elements, but simply combines them in *modes* which we cannot imitate."

It is hoped that the foregoing statements will have established the probability (which is all that the present state of our knowledge on these subjects will allow us to assert) that the affinities which hold together the elements of living bodies, and which govern the elaboration of organic products, are the same as those constantly operating in the world around. It would seem, at any rate, premature to assert that the operations of vital chemistry are directed by distinct laws and due to new forces. The designations *organic* and *vital affinity* seem to have been employed by some writers to express only the peculiarities of the circumstances and conditions under which these laws usually operate, rather than any real difference in the nature of the powers themselves. And others appear to use them as *provisional* terms only, referring those effects to the operation of vitality which chemistry is not yet in a condition to explain. In the former sense it is manifest that such employment of the term is injurious as leading to misconception. In the latter it is harmless, if it do not check inquiry and create a prejudice against the reception of new facts. The period when all difficulty shall have vanished from the application of chemical laws to the phenomena of the vital economy may be very far distant; and in the mean time "we must be content with gathering a few indications which occasionally break out from the clouds of mystery in which the subject is obscured." But it must not be left out of view that every fresh discovery adds to the number of these indications, and that they all point in the same direction; so that the probability of the universal operation of chemical affinity in the living body becomes every day more strong, and the difficulty in proving the existence of a distinct set of vital affinities is constantly becoming less easily surmounted.

VI. VITALITY IN A DORMANT OR INACTIVE CONDITION.—There are many organised beings at particular periods of whose existence all *vital action* seems to be suspended; and this may result either from the absence of the stimuli necessary to maintain it, or from some change in the organism itself, by which it becomes for a time less capable of responding to these stimuli. When vital action is suspended from the deficiency of external stimuli, one of two things must happen; either the vitality of the organism will be destroyed by the disin-

* This eminent chemist has been quoted as an advocate of the doctrine of vital affinities. If such was formerly held by him, it is evident, from the tenor of the communication here referred to, that he has abandoned it.

† See the Author's essay on the laws regulating vital and physical phenomena, in *Edinb. Philos. Journal* for April 1838; and *Principles of General and Comparative Physiology*, p. 379 *et seq.*

tegration of its tissues; or it may be preserved in consequence of the absence of those agents which ordinarily excite decomposition. The occasional suspension of vital action from a change in the organism itself, appears usually to result from a general law of *periodicity*, which affects, more or less, all organised beings, producing the phenomena of sleep, hybernation, &c.; but it may also arise from particular causes operating within the system, as in syncope. Each of these cases will now be separately considered.

Dormant vitality of seeds, eggs, &c.—The condition of organised beings of which we have first to treat—that in which *vital action* is suspended from the absence of the stimuli necessary to maintain it, and *vitality* nevertheless preserved—is manifested in the most remarkable manner by the reproductive germs which are periodically separated from plants and animals, and which are endowed with the power of developing themselves into new individuals when the requisite conditions are supplied to them. In the lowest classes of each kingdom, it would appear that these germs are liberated from the parent unprovided with any means for the continuance of their development; and that from the first, therefore, they rely upon the surrounding elements for *all* the conditions of their active existence. It is beautifully provided that, in proportion to the probable deficiency of some of these, should be the tenacity with which the apparently lifeless germs retain their vitality. The sporules of the fungi, which can only subsist on decaying organised matter, seem universally diffused through the atmosphere, and ready to vegetate with the most extraordinary rapidity whenever a fitting nidus is afforded for their development. This, at least, appears the only feasible mode of explaining their appearance in the forms of mould, mildew, &c. on all decaying surfaces; and that there is no improbability in the supposition itself is shown by the estimate of Fries, who states that a single individual of *reticularia maxima* will emit above 10,000,000 of these germs, so minute as when collected to be scarcely visible to the naked eye, rather resembling thin smoke, and so light as to be wafted by every movement of the atmosphere, so that, he remarks, “it is difficult to conceive a place from which they can be excluded.” It seems more than probable that in a similar manner is to be explained the appearance of infusorial animalcules in all situations adapted to their existence; and that their germs are constantly and universally diffused through the air, ready to commence the active exercise of their dormant properties whenever they meet with the stimuli to their development afforded by warmth, moisture, and decomposing organic matter.*

We have no means of ascertaining the length of time during which this dormant vitality may be preserved. It would be difficult to assign a limit to it, since it is scarcely conceivable that any change can occur in the struc-

ture of these minute desiccated points which they do not undergo during the first few hours of their aerial residence; and we have no reason to believe that vitality can be destroyed without change of structure. With regard to the seeds of phanerogamic plants, we have more certain evidence, and this of a very interesting character. It is to be remarked, however, that in them, as in the eggs of higher animals, there is, besides the germ itself, a reservoir of nutriment supplied by the parent, which enables the germ to continue its development up to the point at which it becomes fit to maintain its own existence, without any other than the ordinary assistance of vital stimuli. The germination of a seed, for example, requires only warmth, moisture, and the access of air, and is further accelerated by the absence of light; and the hatching of an egg is dependent only on a temperature more or less elevated and the presence of air. Hence the necessity for so great a tenacity of vitality as that possessed by the germs of the simpler classes does not exist, and although under favourable circumstances the vitality of seeds may be prolonged for an almost indefinite period, they are more susceptible of the injurious influence of external agents, and their fertility is destroyed by changes of condition which would have no effect in the former case; whilst the eggs of animals appear still less tenacious of vitality, although in a few instances capable of retaining it for some time, even under considerable disadvantages, as will be presently noticed.

The seeds of most plants which inhabit temperate climates are adapted to remain dormant during the winter, and may be preserved in dry air and moderate temperature for a considerable time. Some of those which had been kept in the Herbarium of Tournefort for upwards of a century were found to have preserved their fertility. But with regard to those which are brought from tropical climates there is greater uncertainty, and unless they have been carefully excluded from the contact of air and from variations of temperature, a large proportion are usually unproductive. Cases are of no unfrequent occurrence in which ground that has been turned up spontaneously produces plants dissimilar to any in their neighbourhood. There is no doubt that in some of these the seed is conveyed by the wind, and becomes developed in spots which afford congenial soil, in the same manner as the germs of fungi and infusoria. Thus it is commonly observed that clover is ready to spring up on soils which have been rendered alkaline by the strewing of wood-ashes, or the burning of weeds; and it is stated by Professor Graham that after any hill-pasture in Scotland has been laid dry and limed and the surface broken, white clover always makes its appearance. But there are many authentic facts which can only be explained on the supposition that the seeds of the newly-appearing plants have lain for a long period imbedded in the soil, at such a distance from the surface as to prevent the access of air and moisture, and that, retaining their vitality under these circumstances, they

* For an important experiment on this subject recently performed by Schultz, see Edinburgh Philosophical Journal, Oct. 1837.

have been excited to germination when at last exposed to the requisite conditions.*

Most physiologists, at least, are content to adopt this explanation, seeing that it is conformable to what is otherwise known of the persistence of vitality in seeds; but it has been recently maintained that in such instances a *spontaneous production* takes place, similar to that which many philosophers have supposed to occur among the lower tribes of organised beings.† This is not the place to discuss such a theory, of which it would not perhaps be very difficult to show the absurdity; but the following case furnishes, we apprehend, a very satisfactory proof that seeds may preserve their vitality for an unlimited time, when the external conditions are such as to prevent either the active exercise of their properties or the disorganisation of their structure. "I have now before me," says Professor Lindley,‡ "three plants of raspberries which have been raised in the gardens of the Horticultural Society, from seeds taken from the stomach of a man, whose skeleton was found thirty feet below the surface of the earth, at the bottom of a barrow which was opened near Dorchester. He had been buried with some coins of the Emperor Hadrian, and it is probable, therefore, that the seeds were sixteen or seventeen hundred years old."

In regard to eggs, no such examples are, we believe, on record; nevertheless, there are some tribes of animals whose eggs are capable of being preserved for a considerable length of time, and of undergoing very severe treatment without loss of their vitality. Most insects deposit their eggs sufficiently early in the summer for the larvæ to be hatched and attain their full growth before the autumn deprives them of their supply of food, and these pass the winter in the pupa state. But there are some which do not begin to lay until the activity of vegetation has nearly ceased, and their eggs remain undeveloped until the ensuing spring arouses both the animal and vegetable creation into life. The curious instincts which lead these insects to choose secure places for the deposition of their eggs, and to use other means of protecting them against cold and moisture, are described by Mr. Kirby;§ and the same author points out the beautiful correspondence between the temperature required for the development of the buds of the plant and of the larvæ that prey upon them. It has been mentioned in a former article|| that the eggs of the slug are capable of enduring a temperature of 40°, and of being completely desiccated, without losing their fertility; and it can scarcely be doubted, therefore, that these might preserve their vitality like the seeds of plants for an un-

limited period, if neither aroused into activity nor disorganised by decomposing agents.

It will scarcely be denied that the agents which are known to destroy the vitality of seeds and eggs are such as are calculated to produce important changes in their structure and composition, even though these be of a kind inappreciable by our present means of research. Thus most seeds are killed by a temperature of 160°, which is that at which rupture of the vesicles of fecula takes place, and the application of heat sufficient to destroy the vitality of an egg coagulates its albumen. An electric shock is well known to be a powerful means of instantaneously extinguishing the vital properties of eggs or seeds; and although the precise alterations which it effects in the structure or composition of their parts is not understood, it cannot be doubted that important organic changes are produced by so powerful an agent. Cold, in like manner, probably acts injuriously on most eggs and seeds as upon plants, by causing the rupture of the cells of their tissues through the expansion of the contained fluids in the act of freezing. We do not mean to say that *other* changes are not also produced by such agents, but we mention these as evidences of the position with which we started—that vitality is not destroyed by the influence of external agents without a structural change of some kind being induced by their operation.

But it is not during their embryo state merely, that the vital actions of living beings may be suspended by the deficiency of external stimuli, and yet their vitality be preserved. Both the vegetable and animal kingdoms afford numerous examples of such an occurrence at all periods of existence, especially among their lower tribes. Mosses, for instance, often appear completely desiccated in dry weather, and seem as if dead; whilst, on the application of moisture, they revive in all their pristine beauty. The curious *Lycopodium* of Peru exhibits this torpor in a still more remarkable manner. When desiccated by drought, it folds in its leaves and contracts its roots so as to form a ball, which, apparently quite devoid of animation, is driven hither and thither by the wind; as soon, however, as it reaches a moist situation, it sends down its roots into the soil, and unfolds to the atmosphere its leaves, which, from a dingy brown, speedily change to the bright green of active vegetation. The rose of Jericho is the subject of similar transformations. Instances exactly parallel are furnished by the animal kingdom. The common wheel-animalcule is one of the most remarkable, being capable of desiccation so complete as to splinter if touched with the point of a needle, and still preserving its vitality so as to revive when moistened.* In animals reduced to a

* For several cases of this kind related on the authority of Professor Graham, see Dr. Prichard's *Physical History of Man*, third edit. vol. i. p. 39, &c.; and for a very curious instance communicated to the author of this article, see his *Principles of General and Comparative Physiology*, p. 141.

† See Dr. Weissenborn's papers in the *Philosophical Magazine* for 1838.

‡ Introduction to Botany, p. 298.

§ Kirby and Spence's *Entomology*, vol. ii. p. 443.

|| *Vol. ii. p. 402.*

* This fact has been denied by some naturalists; but the author can positively assert it from his own experience. See *Principles of Gen. and Comp. Physiology*, p. 90, note. From experiments subsequent to the one there related, he is inclined to believe that of two species of *Rotifer*, so nearly allied as to be usually considered the same, one is thus revivifiable, and the other not.

state of torpidity by cold, some vital action usually continues; and such cases cannot therefore be adduced under the present head. But instances are by no means rare in which the whole body has been frozen, and vital action has of course been completely suspended, yet without the destruction of the power of renewing them under more favourable circumstances. Lister first noticed that he had found caterpillars so frozen, that when dropped into a glass they chinked like stones, but nevertheless revived; and this statement has been confirmed by Bonnet and others. The *Papilio Brassicæ* has been produced from a larva which had been exposed to a frost of 0° Fahr., and which had become a lump of ice. Fishes are occasionally found imbedded in the ice of arctic seas; and some of these revive when thawed. This tenacity of life appears greater, however, in the species which are confined to shallow lakes or ponds, and which have not the power, therefore, of escaping from the effects of cold. This is perhaps the proper place to mention those undoubted cases in which insects have been apparently killed by immersion in water or spirit, continued for a long period, and have yet revived on exposure to the air and sun.

Without multiplying facts, then, it may be safely affirmed that many organised beings may retain their vital properties, in some instances to an unlimited duration, while all vital activity or life is completely suspended, through the absence of the stimuli necessary to maintain it; and that this preservation of vitality bears so close a relation to the resistance offered, by the structure and composition of the substance possessing it, to the influence of disintegrating agents, that it may reasonably be considered as a *result* of the maintenance of its normal constitution. The physiologist is not yet in a condition to explain those differences in structure and composition which enable some organisms to offer a much greater resistance to such injurious influences than others; but he considers himself entitled to assume that such exist in all, since there are many instances in which he is able to detect them.

Suspension of vital action under other circumstances.—We have next to consider those cases in which vitality is rendered for a time dormant, by causes originating in the system itself, rather than by the withdrawal of external stimuli. Under this head we may place all those phenomena to which the name of *hibernation* is usually given; but which, as will presently be seen, cannot be appropriately designated by that term. The greater number of plants indigenous to temperate climates undergo an annual series of phases, in which their vegetative processes exhibit every gradation from a torpor apparently complete to the most surprising activity. In many, indeed, this series of phases constitutes the whole of life; the individual ceasing to exist as soon as it has been once performed, and a new generation called into existence. In many more, a total suspension of activity appears to take place, as may be observed in plants whose stems die annually, whilst the roots retain their

vitality. This condition exactly resembles that of certain animals which pass the winter in a state of profound torpor. In those, however, whose stems are woody and persistent, vital action does not seem to be completely checked even by a frosty atmosphere; as late experiments show that a movement of sap takes place, though to a trifling degree, in the depth of winter. And, lastly, in evergreen plants, these changes of condition are less complete; the activity of the vegetative processes being diminished by the partial withdrawal of their appropriate stimuli, but not being altogether suspended. Now although it is unquestionable that this series of changes is greatly *influenced* by the successive alterations in the external conditions of the beings, which the revolution of the seasons induces, it does not admit of doubt that it is originally *dependent* on the peculiar constitution of the organism, by which a *periodical* diminution of its activity is occasioned. For nothing will prevent a plant from shedding its leaves nearly at its usual time; and although by artificial heat, or by removal to a warmer climate, a new crop may be brought out within a short interval, this can only be effected by keeping in a state of activity the processes which ought to be at rest, so that an injurious influence is exerted on the general system like that which results from artificially-prolonged watchfulness in animals. When a plant is reduced, by the periodical decay of its stem and leaves, to the state of a bulb or root, it seems almost to revert to that remarkable condition already described as peculiar to seeds; the vitality of the structure being capable of remaining dormant for a considerable time, and of being then aroused into full activity by the appropriate stimuli. We are not aware of any authentic facts which fix the limit to the duration of this condition. Instances have been related of the growth of bulbs unrolled from the envelopes of Egyptian mummies; but there is reason to believe that deception has been practised on this point upon the too-ready credulity of travellers. However, there can be no doubt that, under favourable circumstances, bulbs and roots may be preserved for many years; the conditions necessary for this object being such as neither excite the vitality of the structure to action, nor occasion the disintegration of the latter and the consequent loss of its properties.

The animal kingdom presents us with conditions very analogous to those just alluded to. In a large proportion of those inhabiting temperate climates, there is a periodic diminution of vital activity during the colder part of the year; but this, in the higher tribes at least, scarcely amounts to an absolute suspension, since the circulation, and the functions of nutrition and secretion which depend on it, are carried on, though feebly. (See *HYBERNATION*.) It is easy to understand why this must be the case. The softer portions of the animal frame, which are most concerned in the processes of organic life, are not periodically cast off and renewed like the corresponding parts of plants; and, if their integrity were not maintained by the circulation of nutritious fluid during their

inactive state, their normal constitution would be soon affected by their proneness to decomposition, and their peculiar properties be consequently lost. Amongst cold-blooded animals, however, we find instances of more complete suspension of vital actions, which may even be prolonged for a considerable period. Thus, Spallanzani kept frogs, salamanders, and snakes, in a torpid state, in an ice-house, where they remained three years and a half, and readily revived when again exposed to the influence of a warm atmosphere. Insects, in their pupa state, may be regarded as analogous to plants reduced to bulbs. Although the duration of this torpid condition is ordinarily determinate for each species, and although some changes occur during its continuance which scarcely warrant us in characterising the state as one of entire inactivity, there are some instances which prove that it may be prolonged for an almost indefinite period, under particular circumstances. The degree of temperature to which pupæ are exposed seems to have the same kind of influence over them as on the eggs of insects. Thus Reaumur found that pupæ, which would not naturally have been disclosed until May, might be caused to undergo their metamorphosis in a fortnight during the depth of winter, by the influence of artificial heat; and, on the other hand, that their change might be delayed a whole year beyond its usual time, by the prolonged influence of a cold atmosphere. We can scarcely imagine, however, that temperature is the *sole* agent in accelerating or retarding the final metamorphosis. If the caterpillar of *Papilio Machaon*, one of those which has annually a double brood, becomes a pupa in July, the butterfly will appear in thirteen *days*; if not until September, it will not make its appearance until the June following, that is, not in less than nine or ten *months*. Here it is evident that the torpor has been prolonged from some cause inherent in the system itself, for the purpose of preventing the disclosure of the butterfly at too early a period of the season. A still more curious proof of this tendency to prolonged torpidity during the pupa state is the following. If a number of the pupæ of the *Eriogaster lanestris*, a moth whose larvæ are common on the blackthorn in June, be selected at the same time, and placed in the same circumstances, the greater number of them will disclose the perfect insect in the February following; some not until the February of the year ensuing; and the remainder not before the same month in the third year. The same has been observed of the *Arctea mendica*, of which thirty-six pupæ, grown from eggs laid by the same parent, produced twelve perfect insects in each of the three following seasons.* The *final cause* of this curious tendency may be, as surmised by Mr. Kirby, to secure the race from being cut off by unfavourable seasons, or by some extraordinary increase of its natural enemies. But its *efficient cause* can only be looked for in some modification of the properties of

the organism analogous to that which produces the phenomena of hibernation in other animals. The same *periodicity*, manifesting itself, not in obedience to a diminished temperature, but at the season of greatest heat, is observed in tropical climates. Many tribes of insects in the torrid zone seem to retire to places of retreat during the parching droughts of summer, and make their appearance again during the rainy season, when vegetation is in the highest luxuriance. We here trace the same beautiful adaptation of the phases of animal and vegetable life as in the former instances; but the efficient cause which induces these changes must be different.

Our limits do not allow us to dilate upon one very interesting department of this subject—the prolongation of dormant vitality under particular circumstances in frogs and other reptiles. Many marvellous stories of this kind are on record;—such as the inclosure of these animals in solid blocks of granite or other igneous rocks, which no well-informed person can credit. There are, however, a sufficient number of authentic cases to prove, in the estimation of those who have fairly examined them, that toads and other reptiles may be enclosed in masses of rock *apparently* solid, or in the substance of the trunks of trees, and that they may preserve their vitality under such circumstances for a very long period. In the former instances, it would appear that the animal has fallen into a chink or crevice, which has been gradually filled up by the washing-in of gravel or other materials disposed to solidify; and that thus the appearance of a solid mass has been given, when in reality some communication has existed between the cavity and the external air. It is by no means impossible, moreover, that these animals might be found imbedded in the sandstones at present in course of formation in many localities; these rocks possessing considerable hardness, but being at the same time sufficiently porous to allow of the slow passage of air through their substance. Where toads have become imbedded in crevices of trees, and been surrounded by new layers of wood, it is evident that a direct communication with the atmosphere will probably exist by means of the original crevice, although it may be much narrowed; but even if this be not the case, the porosity of the wood will furnish the required condition. Some amount of access of air would seem, from the experiments of M. Edwards and Dr. Buckland, to be essential to the prolonged vitality of toads enclosed in solid masses; and this will probably maintain a very feeble respiratory action upon the blood through the general surface, just sufficient to prevent the decomposition of the body. Vital action cannot, therefore, be regarded as so completely extinct under these circumstances as in some of the cases formerly mentioned, where the application of cold has not only completely checked it, but has also done away with the necessity for it, by completely subduing the tendency to decomposition.

In the human economy, as in that of other

* Kirby and Spence's Entomology, vol. iii. p. 266.

non-hibernating animals, it is only occasionally that anything approaching to this suspension of vital action can occur. That which takes place during sleep only relates to the sensorial functions; the organic changes experiencing but little diminution in activity. The closeness of the connection between their vital operations, and the immediate dependence of these upon external stimuli, involve the destruction of life when they are totally withdrawn; and it is only under peculiar conditions of the organism itself, that we ever witness a suspension of vital action without the speedy supervention of death. Indeed it may be fairly questioned whether such suspension can ever *completely* take place; and whether the changes which occur in the periphery of the circulation are not continuing, however feebly, even when no action can be detected at the centre. This condition is termed *syncope*; and its phenomena will be more fully detailed hereafter. (See *SYNCOPE*.) We are inclined to think that, where a state of apparent death has continued for some days, vital action was never entirely suspended; though perhaps its cessation may be more complete where the syncope is but transient. Such would seem to be the case where individuals have recovered from a submersion under water, which has been prolonged beyond the few minutes that suffice to produce asphyxia. It is generally supposed, and we think with reason, that the mental emotion experienced at the moment of submersion produces a state of syncope; and that the organism, being in that state less dependent on external stimuli than when in a more active condition, can bear privations which would be otherwise fatal, just as is known to be the case with hibernating animals, the pupæ of insects, &c. The well-known case of Col. Townsend appears to us to prove that an apparent cessation of vital action does not imply its entire extinction; since when no changes could be detected by his medical attendants, he was voluntarily acting on his system both to retard and renew its usual functions. Dr. Cleghorn of Glasgow knew an individual who could control the action of his heart, so as to be able to feign death at pleasure.

Although in these cases we may be disinclined to admit the *total* suspension of vital action, there can be no doubt that it may occur in *portions* of the human body under the influence of cold, and that, if carefully treated, it may be again renewed. Nay more;—there is undoubted evidence that portions of the body, after being totally separated from it, may be reunited and made again to form integral parts of the structure, if no disorganisation has taken place in the interval. That such an occurrence is perfectly consonant with the doctrines which we have maintained regarding the connection between vitality and organisation—will be at once evident; but we do not see how it can be satisfactorily explained by the advocates of the doctrine of a separate life or vital principle. Does the finger or nose which has been cut off carry with it a chip or off-shoot of the parent vital principle or organic agent? If so, when does that quit its material tenement? There

is no evidence of its existence in the separated part, which is completely dead to the general structure, and which nothing prevents from speedy decay, if its vital actions be not soon renewed. And if it be supposed to remain, it must again become merged in its parent principle, when re-union of the divided parts has taken place, or must submit to it like a dutiful child. There is no end to the absurdities in which those may be involved, who adhere with pertinacity to a doctrine so useless and so unphilosophical as that of a single controlling agent or power, presiding over the affairs of each organism.

It is with much satisfaction that the author of the foregoing article (which was written above a year ago) refers his readers to the recently published *Supplement on the Atomic Theory*, by Dr. Daubeny, for a full discussion of the question briefly considered in § V. The conclusions at which the learned Professor has arrived are of precisely the same character as those for which the author has here argued, and are expressed in almost the same language. The following passages may be extracted from among many of great interest.

“There is little doubt that it will eventually appear, that all the secretions or excretions of animals and vegetables are only so far dependent upon life, inasmuch as, in consequence of the favourable temperature which it sustains, the constant circulation of the fluids it occasions, and their exposure to external agents in vessels of different shapes and dimensions, a mechanical separation of the ingredients of the blood is effected in some instances, and a chemical change produced in its composition by catalytic action in others.” “The putrefaction of vegetable and animal matters appears to be produced, not by any sudden cessation of those affinities which had previously bound their respective elements together, but by the predominance over them of the natural forces, which we may without much difficulty conceive to have been controlled under the circumstances in which the living body is placed; nor does there seem any sufficient reason for calling in the intervention of an occult principle to explain that, to the solution of which by known causes, every fresh advance in chemical knowledge seems to bring us into closer approximation.” “It is now certain that the same simple laws of composition pervade the whole creation; and that, if the organic chemist only takes the requisite precautions to avoid resolving into their ultimate elements the proximate principles upon which he operates, the results of his analysis will show that they were combined precisely according to the same plan as the elements of the mineral bodies are known to be.”

BIBLIOGRAPHY.—Besides the systematic Treatises on physiological science by Haller, Cullen, Blumenbach, Dumas, Richerand, Treviranus, Rudolph, Magendie, Bostock, Tiedemann, Mayo, Adelon, Burdach, Alison, Roget, Fletcher, Dunglison, Arnold, Müller, Carpenter, and others,—the following, among the almost innumerable writings on the subject, may be advantageously consulted.

Aristotle, Opera. *Cicero*, Quæst. Tusc. lib. i. *Idem*, De nat. deorum. *Lucretius*, De rerum naturâ. *Bacon*, Historia vitæ et mortis. *Harvey*,

De generatione animalium, Lond. 1651. *Glisson*, De vitâ naturali, Lond. 1672. *Stahl*, De vitâ, Halle, 1701. *De Gorter*, De actione viventium particulari, Anstel. 1748. *Hoffman*, Dissertatio vitæ animalis, Halle, 1731. *Bonnet*, sur les corps organisés, Amst. 1776. *Brown*, Elementa medicinæ, Edinb. 1780. *Priestley*, On matter and spirit, Birn. 1782. *Hunter*, On the animal economy, Lond. 1786. *Darwin*, Zoonomia, Lond. 1794. *Cuvier*, Leçons d'anat. comp., Paris, 1799. *Bichât*, Sur la vie et la mort, Paris, 1802. *Oken*, Abriss des Systems der Biologie, Goett. 1805. *Wolf*, Ideen über Lebenskraft, Altona, 1806. *Abernethy*, On Hunter's Theory of Life, Lond. 1814. *Lawrence*, Lectures on physiology, &c. Lond. 1816. *Philip*, On the laws of the vital functions, Lond. 1817. *Pring*, On the laws of organic life, Lond. 1819. *Barclay*, On life and organisation, Edinb. 1822. *Good*, Study of medicine, Lond. 1825. *Prichard*, On the vital principle, Lond. 1829. *Bell*, Bridgewater treatise, Lond. 1833. *Prout*, Bridgewater treatise, Lond. 1834. *Robertson*, On life and mind, Lond. 1836. *Clark*, Report on physiology to Brit. Assoc. 1834. *Reil*, Von der Lebenskraft, in Archiv. I. B.

(W. B. Carpenter.)

LIVER, NORMAL ANATOMY.—Syn. Gr. *ἥπαξ*; Lat. *hepar*, *hepar*; Fran. *foie*; Germ. *Leber*; Ital. *fegato*. The liver is a conglomerate gland of large size, appended to the alimentary canal, and performing the double office of separating certain impurities from the venous blood of the chylopoietic viscera, previously to its return into the general circulation, and of secreting a fluid necessary to digestion—the bile.

It is situated in the abdomen, in the right hypochondriac region, and extends across the epigastrium into the left hypochondriac region. Superiorly it ascends to a level with the sixth or seventh rib, diminishing the cavity of the chest on the right side, and inferiorly it approaches by its anterior border, the lower margin of the thorax.

The general form of the liver is flattened, being broad and thick towards the right extremity, and narrow and thin towards the left. *Glisson* compared its shape to the segment of an ovoid cut obliquely in the direction of its length, and *Dr. Alexander Monro* to the hoof of an ox rounded superiorly. Its superior surface is convex; the inferior irregularly concave; the posterior border is thick and rounded, and the anterior thin and sharp.

Its position in the abdomen is oblique, the convex surface, in the erect posture of the body, being directed upwards and forwards, and the concave downwards and backwards. The broad border is posterior and superior, and the thin margin anterior and inferior. If the trunk be inclined forwards the free edge of the liver may be felt, extending below the margin of the thorax.

It is in relation by its convex surface, superiorly with the diaphragm, which separates it from the under surface of the right lung and from the heart; anteriorly with the diaphragm and transversalis muscle, and with the sheath of the rectus and linea alba at the epigastrium; and on the right side with the diaphragm and transversalis muscle, which are interposed between it and the seven or eight lower ribs. Its inferior or concave surface is in relation

with the anterior aspect of the stomach, the ascending portion of the duodenum, the transverse colon, the right supra-renal capsule, and the right kidney, and sometimes by its left extremity with the upper end of the spleen. The posterior border rests against the diaphragm, which intervenes between it and the vertebral column, and is in contact with the inferior vena cava, œsophagus, and right pneumogastric nerve. The anterior border is free and in relation with the transversalis muscle, which separates it from the cartilages of the lower ribs, with the round ligament at the notch, and with the sheath of the rectus and linea alba at the epigastrium.

The liver is retained in its place by duplicatures of peritoneum which pass between its convex surface and posterior border and the diaphragm, and by a fibrous cord which crosses from the linea alba to the inferior vena cava. These are the ligaments of the liver; they are five in number, the broad, the two lateral, the coronary, and the round ligament.

Fig. 32.



The upper or convex surface of the liver.

No 1, the right lobe; 2, the left lobe; 3, a part of the lobus Spigelii seen projecting beyond its posterior border; 4, 4, the anterior or narrow border; 5, the notch in the anterior border that gives passage to the round ligament; 6, 6, the posterior or rounded border; 7, the broad ligament; 8, the left lateral ligament; 9, the right lateral ligament; 10, the point of separation of the layers of the right lateral ligament to inclose the oval space, 11, 11; 12, the round ligament; 13, the fundus of the gall-bladder projecting beyond the anterior margin of the liver. The notch upon the anterior margin corresponding with the gall-bladder is also seen; 14, the inferior vena cava emerging from the liver in the centre of the oval space of the coronary ligament. The small vessels seen ramifying upon the surface of the organ are superficial lymphatics.

The broad ligament, (fig. 32, 7) (falci-form, longitudinal, l. latum, l. suspensorium hepatis) is an antero-posterior duplicature of peritoneum which extends from the notch on the anterior margin of the liver to the superior part of its posterior border. It is broad in front where it incloses the round ligament, and becomes narrow as it passes backwards; hence its synonym, *falci-form*. It serves to connect the convex surface of the liver with the linea alba and diaphragm.

The lateral ligaments (fig. 32, 8, 9)

Fig. 33.

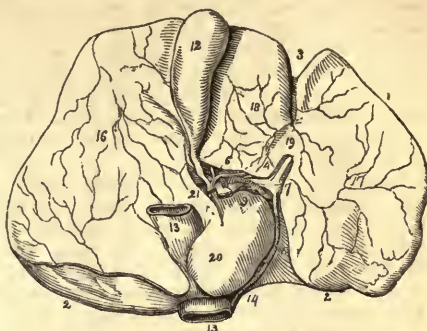

The under or concave surface of the liver.

Nos. 1, 1, the anterior border; 2, 2, the posterior border; 3, the notch upon the anterior border; 4, 4, the longitudinal fissure containing the fibrous cord of the round ligament; 5, the fissure for the ductus venosus; 6, the transverse fissure; 7, the point of union of the three fissures, the longitudinal, the transverse, and that for the ductus venosus; 9, the portal vein in the transverse fissure, the hepatic artery, and the trunk of the ductus communis choledochus; 11, the cystic duct; 12, the gall-bladder; 13, 13, the inferior vena cava passing through its fissure; 14, the cord of the ductus venosus, joining the inferior cava as that vessel emerges from the substance of the liver; 15, part of the oval space on the posterior border of the liver; 16, the right lobe; 17, the left lobe; 18, the lobulus quadratus; 19, the pons hepatis; 20, the lobus Spigelii; 21, the lobus caudatus.

cates with the portal vein. This is an indication of the natural inosculature subsisting between these two vessels during intra-uterine existence.

The *transverse fissure* (fig. 33, 6) (sulcus transversus, sulcus vena portæ) is short and deep and about two inches in length; it commences near the middle of the under surface of the right lobe and passes transversely inwards to join the longitudinal fissure. It is the hilus of admission to the vessels of the liver, and gives passage to the hepatic artery, portal vein, and hepatic ducts, as well as to the lymphatics and nerves. The transverse fissure is bounded before and behind by the elevated borders of the lobus quadratus and lobus Spigelii. These lobes were named by the older anatomists the portal eminences, and were considered as the pillars which flanked the entrance to this great portal of the liver.

The *fissure* or rather the *fossa* for the gall-bladder is the shallow angular depression which lodges the biliary sac. It is broad in front and generally marked by a notch upon the anterior border of the liver, and narrows as it passes backwards. It is situated in the right lobe and runs parallel with the longitudinal fissure, while posteriorly it opens into the commencement of the transverse fissure.

The *fissure for the vena cava* (fig. 33) is situated in the same longitudinal line with the preceding, but upon the posterior border of the liver. It commences at the under surface of the organ and terminates upon the upper part of the posterior border at about the middle

(triangular) are two triangular folds of peritoneum which commence at each extremity of the posterior border of the liver and converge towards the termination of the broad ligament. They are broad near the extremities of the organ, and permit of a certain degree of motion in the right and left lobes, but become narrow as they approach the middle line. The two layers which compose the right lateral ligament separate as they pass inwards, and partly inclose an oval space (11, 11) of variable size, which is uncovered by peritoneum and in close contact with the diaphragm; the remainder of the space is bounded by the division of the layers of the broad and left lateral ligaments. The peritoneum surrounding this space, with the contained cellular tissue, which is large in quantity and connects the posterior border of the liver firmly with the right leaflet of the central tendon of the diaphragm, constitutes the *coronary ligament*. The inferior vena cava (14) emerges from the liver at about the middle of this space previously to its passage through the quadrilateral opening in the tendon of the diaphragm. The left lateral ligament, near to its extremity, advances a little upon the upper surface of the left lobe.

The *round ligament*, (fig. 33, 12) (ligamentum teres, umbilicale) is a rounded fibrous cord resulting from the obliteration of the umbilical vein of the fœtus. It is contained in the anterior margin of the broad ligament, and may be traced forwards along the linea alba to the umbilicus, and backwards through the notch in the anterior border of the liver and along the longitudinal fissure to the posterior border, where it is connected with the coats of the inferior vena cava.

Turning to the under surface of the liver we have to examine certain *fissures* which divide this aspect of the organ into lobes; the fissures are five in number; the longitudinal, the fissure for the ductus venosus, the transverse, the fissure for the gall-bladder, and the fissure for the vena cava.

The *longitudinal fissure*, (fig. 33, 4, 4) (sulcus longitudinalis, umbilicalis, horizontalis) extends, as its name implies, longitudinally across the concave surface of the liver from the notch on the free margin of the organ to its posterior border. At about two-thirds from the anterior border it is met by a short fissure, the transverse, which joins it at right angles. The longitudinal fissure up to this point is deep and is generally covered in by an arch of variable breadth (*pons hepatis*, fig. 33, 19) which connects the adjoining sides of the right and left lobes; beyond this point it is shallow and takes the name of *fissure for the ductus venosus* (5) from containing the fibrous cord into which the ductus venosus is converted after the cessation of fœtal circulation. The longitudinal fissure marks the division of the liver upon its under surface into a right and left lobe, and contains the fibrous cord of the round ligament, which is the degenerated umbilical vein of the fœtus. Opposite the extremity of the transverse fissure the fibrous cord is often partially dilated and communi-

of the oval space inclosed by the coronary ligament. This fissure is always very deep and surrounds the vena cava for two-thirds or three-fourths of its cylinder. Sometimes it is converted into a canal by a thin layer which is stretched across it from the lobus Spigelii to the contiguous border of the right lobe. The hepatic veins pour their blood into this portion of the vena cava.

These five fissures taken collectively, namely, the longitudinal fissure and fissure for the ductus venosus on the left, the fissures for the gall-bladder and vena cava on the right, with the transverse fissure passing between them, are represented by Meckel as resembling the letter II, whereof the transverse bar is placed nearer to the posterior than to the anterior extremity. Viewing them in this way the two anterior branches are, the longitudinal fissure on the left and the fossa for the gall-bladder on the right; and the two posterior are, the fissure for the ductus venosus on the left, and the fissure for the vena cava on the right.

The existence of these five fissures upon the under surface of the liver causes its division into as many portions, which are named lobes, viz. the right, the left, the lobus quadratus, the lobus Spigelii, and the lobus caudatus.

The *right lobe*, (*fig. 32, 1, fig. 33, 16*.) (lobus major) is the largest division of the liver, and forms the whole of the bulky right extremity of the organ. It is convex upon its upper surface and irregularly concave below; at its right extremity and behind it is thick and rounded, and thin and sharp in front. It is separated from the left lobe on its convex surface by the broad ligament; beneath by the longitudinal fissure and fissure for the ductus venosus, and in front by the notch on the free margin of the liver. The transverse fissure and the fissures for the vena cava and gall-bladder are situated on the under surface of this lobe and serve to limit the boundaries of the three minor lobes; the lobus quadratus, Spigelii, and caudatus. Upon this surface it is marked by three depressions, one in front, of large size, for the right extremity of the transverse colon, and two behind, one for the right supra-renal capsule and another for the right kidney.

The *left lobe* (*fig. 32, 2, fig. 33, 17*.) (lobus minor) is four or six times smaller than the right; flattened in form, and thinned towards its circumference into a sharp margin. It is divided from the right lobe by the broad ligament above, by the notch in the anterior margin of the liver in front, and by the longitudinal fissure and fissure for the ductus venosus below. Superiorly it is convex and in relation with the diaphragm, to which it is connected by the left lateral ligament, and inferiorly it is concave, and presents a broad and shallow depression which rests upon the anterior surface of the stomach. By its extremity it sometimes touches the spleen, and by its posterior border corresponds with the termination of the œsophagus and with the right pneumogastric nerve.

The *lobus quadratus* (*fig. 33, 18*.) (ante-

rior portal eminence) is a quadrilateral and slightly elevated division situated upon the under surface of the right lobe near to the middle line of the liver. It is bounded anteriorly by the free margin of the organ, posteriorly by the transverse fissure, to the left by the longitudinal fissure, and on the right by the fossa for the gall-bladder.

The *lobus Spigelii* (*fig. 33, 20*.) (posterior portal eminence) is a prominent conical lobe, smaller than the preceding, and situated near the posterior border of the liver, behind the two layers of the lesser omentum. Its base is triangular, and bounded in front by the transverse fissure; on the left side by the fissure for the ductus venosus, and on the right by the fissure for the vena cava and lobus caudatus, which last connects it with the under surface of the right lobe. By its anterior border it is in relation with the portal vein, by its left border with the fibrous cord of the ductus venosus, and by the right with the vena cava. Its posterior extremity is received into the angle of communication between the fibrous cord of the ductus venosus and the vena cava.

The *lobus caudatus* (*fig. 33, 21*.) is a tail-like appendage to the lobus Spigelii. It is extremely diversified in form, being sometimes well developed and a distinct lobe; at other times a mere vestige recognisable only to the eye of the experienced anatomist. Sometimes it is a slight ridge, merging into the surface of the liver on either side, and at other times is marked by a fissure on one side or even on both. Ordinarily it is an angular projection two or three inches in length, commencing by a narrow isthmus from the lobus Spigelii, passing obliquely outwards and forwards by the side of the gall-bladder, and subsiding at its extremity into the surface of the right lobe. The depression on the under surface of the right lobe, in front of this process, is for the reception of the curve of the ascending colon, and the posterior depressions for the right supra-renal capsule and right kidney.

The *coverings* of the liver are twofold, a serous investment, which is obtained from the peritoneum, and a proper fibrous capsule derived from the capsule of Glisson. The *peritoneum* encloses the whole of the liver with the exception of that part of the posterior border which constitutes the oval space (*fig. 32, 11, fig. 33, 15*.) and is surrounded by the coronary ligament, of the fossa for the gall-bladder, the fissure for the vena cava, and the transverse fissure. The *proper capsule* is most apparent upon those parts of the organ which are left uncovered by the peritoneum, particularly on the oval space upon its posterior border.

The *color* of the liver varies considerably, both with the period of life and with the greater or smaller proportion of blood or bile contained within its vessels. Thus in infancy it presents a light red colour, which deepens into a reddish brown in the adult, and increases in depth of shade with the age of the subject. If the individual have died from hæmorrhage, the liver appears bleached and presents a yellowish grey tint; if from general congestion,

it may assume a chocolate or purplish brown or a slate colour, and if from obstruction to the bile-ducts, a variable shade of yellow. Its texture is firm and dense, but extremely fragile, the fracture presenting a granular appearance.

The dimensions of the liver are very considerable, as may be inferred by recollecting that this is the largest organ in the body. Through the longest diameter from the extremity of the right to the edge of the left lobe, it measures about twelve inches; from before backwards, through the transverse diameter of the right lobe, about seven inches, and through the thickest part of the right lobe, in a vertical direction, about four inches. These measurements, however, can only be received as an approximation to the average, for the size of the organ varies in different individuals; thus it is larger in males than in females, and is more bulky in persons of sedentary habits than in those who are robust and active. Its weight is about five pounds; its relative weight to the entire body, as 1 to 36; and the specific gravity one half heavier than water.

Chemical analysis of the human liver has shown that in 100 parts, there are, of

Water	61.79
Solid matters	38.21

Of 100 parts of the solid matters,

71.18 are soluble in water, hot or cold, or alcohol; and consist of, osmazome, stearine, elaine, resin, oleic and margaric acids, gelatine, and saline.

28.72 are insoluble.

2.034 are salts; viz. chloruret, phosphate of potash, phosphate of lime, and oxide of iron.

Bullocks' liver, analysed by Braconnot, is, according to Berzelius, analogous to the preceding, the differences being dependent solely upon a difference of manipulation. 100 parts contain,

55.50 water.	
44.50 solid matters, composed of,	
Vessels and membranes ..	18.94
Soluble matters	25.56

100 parts of the pulp of liver contained,

58.64 water.
20.19 dry albumen.
6.07 matter very soluble in water; slightly in alcohol; containing little nitrogen.
3.89 fat.
0.64 chloruret of potash.
0.47 phosphate of lime containing iron.
0.10 salt of potash combined with a combustible acid.

Varieties in the liver may be referred to one of two heads—varieties in form, and varieties in position.

Varieties in form occasionally occur, but they are more rare in the liver than in almost any other organ of the body. I have seen the left lobe so small as to appear but a mere appendage to the right, being connected to it only by a thin and narrow isthmus. Cruveilhier records an instance in which the left lobe was

attached to the right merely by a vascular pedicle about half an inch in length; the extremity of the lobe being adherent to the upper part of the spleen. Deep and narrow grooves are occasionally seen upon the convex surface of the right lobe running in an antero-posterior direction; they correspond with projecting fasciculi of the diaphragm, and occur generally in women who have laced tightly. This surface is also marked frequently in females with deep channels, which are formed by the pressure of the ribs, and are also the result of tight lacing. The liver is sometimes constricted in the middle from this cause, and a dense fibrous band, produced by thickening of the fibrous capsule, extends around it like a belt. The lobes are occasionally divided by deep fissures into several additional lobes; the liver in this case presents a character which is normal amongst the lower animals. In a few instances the fossa for the gall-bladder has been found excavated so deeply as to render the fundus of the sac apparent through an opening on the upper surface of the liver, a peculiarity which is also normal amongst some of the lower tribes of animals.

Varieties of position are more frequent than those of diversity of form. During utero-gestation the liver is usually pressed considerably above its ordinary plane, so as to impede more or less the action of the diaphragm and produce embarrassed respiration. In an extremely fat subject I once saw the diaphragm raised by the liver to a level with the fourth intercostal space, measured near to the sternum. In its natural position the thin margin of the liver scarcely reaches the border of the thorax, but in women who have laced tightly during youth nothing is more common than to find this edge forced several inches below the base of the thorax, and altered in its form. In these cases the direction of the aspects of the organ are likewise changed; the convex surface looks directly forwards, instead of upwards and forwards, and lies in contact with the abdominal parietes. The concave surface is directed backwards in place of downwards and backwards, and the posterior border is forced upwards. In a sketch from the subject, now before me, the greater part of the convex surface of the organ is in contact with the abdominal parietes, and the free margin extends into the umbilical and lumbar regions. In another sketch, as a result of the enormous magnitude of the stomach from the same cause, the liver is raised almost perpendicularly, the extremity of the left lobe being in contact with the diaphragm, and the right lobe in the right iliac fossa. A part of the liver has been found in the sac* of inguinal and umbilical hernia. Various peculiar appearances are observed in the liver of the fœtus arising from arrest of development. Thus, for instance, the entire organ, or a part of it, may be situated in the chest, or from absence of development of the abdominal parietes the liver may form part of

* Gunzius de Herniis, in Portal's Anatomie Médicale.

an exabdominal tumour, and be uncovered excepting by the membranes of the ovum. But the most interesting and unexplained form of altered position is that in which the whole of the viscera of the body are transposed, and the liver becomes placed on the left instead of the right side. These cases are generally perfect, and the peculiarity does not seem to interfere with the life or functions of the subject. The liver presents its natural form and size, and with the simple exception of left for right, precisely the same relations. The aorta, of course, occupies the right side, and the venæ cavæ the left, while the stomach is transferred to the right. Sir Astley Cooper has preserved the viscera of an adult who was the subject of this transposition. And a few years since I had the opportunity of examining a similar case in the body of Smithers, a man who was executed for committing arson accompanied with loss of life in Oxford-street. The viscera of this man were perfectly healthy, the liver finely formed, and the general fabric robust.

The *gall-bladder* (fig. 33, 12,) (cystis fellea) is a membranous sac of a pyriform shape, situated in the shallow fossa upon the under surface of the right lobe, and lying parallel with the longitudinal fissure. For convenience of description it has been customary to divide it into a body, fundus, and neck (cervix), although no precise mark of division subsists between these parts. The *body* is the middle portion; the *fundus* the expanded extremity, which approaches the notch in the free border of the liver, and frequently extends beyond it; and the *neck* the narrow and tapering portion of the sac which enters the right extremity of the transverse fissure and forms the cystic duct.

The sac is in *relation* by its upper surface with the substance of the liver, and by the under part with the pylorus and ascending duodenum. The fundus corresponds with the right border of the rectus muscle, and may be felt in that situation when filled with gall-stones.

The *coats* of the gall-bladder are three:—1. an external or serous covering derived from the peritoneum, which covers all that portion of the sac which is not in contact with the substance of the liver. The gall-bladder is sometimes completely surrounded by the peritoneum, and hangs loosely connected with the liver by a duplicature of that membrane. 2. A fibrous layer* (nervous) composed of cellulo-fibrous tissue intermingled with tendinous fibres; and, 3. a mucous coat which lines the interior of the sac, and is continuous through the cystic and hepatic ducts with the mucous lining of the biliary structure of the liver, and through the ductus communis choledochus with the mucous membrane of the duodenum and alimentary canal. The internal surface of the mucous layer is raised into innumerable small ridges and folds (rugæ) by the ramifications of the cystic artery and its capillaries, which give

* In the ox, according to Monro, this coat is distinctly muscular.

to it a peculiarly reticulated appearance, and the interspaces of the rugæ are depressed into numerous small muciparous follicles. In the neck of the sac the mucous membrane is produced into from six to twelve small folds, forming a kind of spiral valve by means of which the bile is regulated in its descent into the duodenum, and assisted in its entrance into the gall-bladder. The existence of this peculiar valvular apparatus gives to the neck of the gall-bladder a sacculated appearance. The mucous membrane is but loosely connected with the fibrous coat, and the cystic artery with its branches ramify between them.

The excretory duct of the gall-bladder is the *cystic*, (fig. 33, 11); it is about an inch and a half in length, and in diameter about equal to the cylinder of a crow's quill. It is generally somewhat tortuous in its course, and appears sacculated from the continuation into it of the spiral valve. Upon entering the transverse fissure it unites with the excretory duct of the liver, the *hepatic duct*, and the junction of the two constitutes the ductus communis choledochus. The *ductus communis choledochus*, about three inches in length, descends through the right border of the lesser omentum, lying in front of the portal vein, and to the right of the hepatic artery, and opens into the duodenum by passing for some distance obliquely between its coats. It is united to the other vessels in its course by the cellular tissue of Glisson's capsule, and near to its termination is considerably constricted.

The excretory ducts of the liver and gall-bladder have three coats, an external or cellular coat, a middle or fibrous, and an internal mucous. A question exists among physiologists as to the probable muscularity of the middle coat in man; it is undoubtedly contractile, and in some few instances of obstruction has presented an appearance very closely resembling muscular fibres. Cruveilhier thinks the structure analogous to the dartos. In some animals, as in the horse and dog, this coat is clearly muscular.

Varieties in the gall-bladder.—The sac is sometimes enormously dilated without any apparent obstruction in its ducts. Occasionally in acephalous and anencephalous fetuses it is altogether absent. In a preparation now before me of the liver of a fœtus at the full period, which lived for several hours after birth, and which presented, in anatomical structure, several peculiarities dependent upon arrest of development, the most careful dissection has failed to discover the slightest indication of gall-bladder. Among the lower mammalia, as in cats, a double or accessory gall-bladder is by no means uncommon. Kiernan has observed several instances of this variety. I myself have seen two, and have one at present before me. In the kinkaju an accessory gall-bladder is the normal character, and in the liver of a small animal preserved by Hunter in the Museum of the College of Surgeons, there are three gall-bladders.

Structure of the liver.—The liver is composed of lobules, of a connecting medium

called Glisson's capsule, of the ramifications of the portal vein, hepatic duct, hepatic artery, hepatic veins, lymphatics and nerves. For an accurate knowledge of these different structures, anatomy is indebted to the labours of Mr. Kiernan, to whose paper on "The Anatomy and Physiology of the Liver," contained in the Philosophical Transactions for 1833, I shall have constant occasion to refer.

The small bodies (lobules, acini, corpuscula, glandular grains, granulations) of which the liver is composed were discovered by Wepfer in the liver of the pig, about two years previously to the appearance of Malpighi's celebrated work, "De Viscerum Structurâ Exercitatio Anatomica." Malpighi, unacquainted with Wepfer's discovery, examined and described these bodies, both in animals and in man, under the name of *lobules*; and the lobules he found to consist of smaller bodies, which he named *acini*. From some want of precision in Malpighi's descriptions, these two names have been confounded by the majority of succeeding anatomists; the term *lobules*, with its distinctive application, has been disregarded and forgotten, and the term *acini* has been applied to those minute bodies of which the liver appears to be formed when examined beneath the microscope with a moderate power,—the acini of Malpighi. So great, indeed, is the confusion of terms even in 1838, that we find a justly celebrated authority in minute anatomy, Müller, in speaking of Kiernan's discovery, using the following words. "He" (Kiernan) "describes the lobules of the liver (which by other anatomists are termed acini)," and further on he observes: "his description of their form is indeed similar to that which we have given above of the acini of the macerated liver of the polar bear." Now, setting aside the anachronism of discovery contained in the above quotation, which, as it appears to me, should have been, *our description of the acini of the polar bear is similar to his description of the form of the lobules*, inasmuch as Kiernan's discovery was published in 1833, and Müller's description of the macerated liver of the polar bear in 1835, I cannot but feel somewhat surprised in observing that Müller draws no line of distinction between the lobules and their supposed constituents the acini. Nay, that he would seem to imply that all anatomists were acquainted with the lobules, but that they assigned to them a different name. To prove that this is not the case, I quote a passage from his work upon the glands, published in 1830, in which he expresses himself unable to distinguish the elementary structure of the liver either in man or in numerous other mammalia, for he says, "In homine, ut in plurimis mammalibus, in hepatis superficie certa quædam particularum elementarium sive acinorum conformatio conspicui non potest." Now the question to be decided, is the meaning which he assigns in this quotation to the word *acinorum*; does he mean by that word the lobules or the acini of Malpighi? The solution is simple; we have it in his own words, and exhibited in a figure in

which his peculiar views of the anatomy of the organ are clearly illustrated. In this figure, (*fig. 217*, page 485,) he says, "Observantur fines ductuum biliferorum elongati, seu cylindriciformes acini, in figuris ramosis et foliatis variè dispositi." So that the acini of Müller in 1830 are the terminations of the biliferous ducts, corresponding therefore with the acini of Malpighi, and the lobular biliary plexus of Kiernan. In 1835, as instanced in the "macerated liver of the polar bear," the acini of Müller are the lobules of Malpighi and Kiernan.

Now seeing this indecision of opinion upon a subject of so great importance in relation to the proper understanding of the minute anatomy of the liver, I have deemed it my duty, in the service of anatomy, to place before my readers this cursory sketch of the history of the anatomy of the organ, and to establish the meaning of the terms I shall have occasion to use in describing its intimate structure. By the word *lobules* I shall mean, not the acini of anatomists, "which are anything or everything or nothing as the case may be," but the lobules of Malpighi and of Kiernan;—by the word *acini* I shall indicate the smaller bodies of which the lobules appear to be composed (acini of Malpighi and of all writers); but which have been shewn by Kiernan to be the meshes of a plexus of biliary ducts, the "lobular biliary plexus."

The *lobules* are small granular bodies of about the size of a millet-seed, of an irregular form, and presenting a number of rounded projecting processes upon their surface. When divided longitudinally (*fig. 34*) they have a foliated appearance, and transversely (*fig. 35*)

Fig. 34.

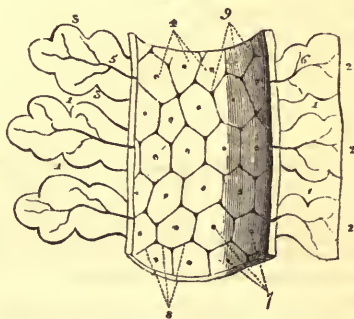

A longitudinal section of a sub-lobular vein.

Nos. 1, 1, longitudinal sections of lobules, presenting a foliated appearance. 2, 2, superficial lobules terminating by a flat extremity upon the surface of the liver; 3, 3, the capular surface of a lobule; 4, the bases of the lobules seen through the coats of the vein and forming the canal in which the sub-lobular vein is contained; 5, the intra-lobular vein commencing by minute venules at a short distance from the capular surface of the lobule; 6, the intra-lobular vein of a superficial lobule commencing directly from the surface; 7, the openings of the intra-lobular veins which issue from the centre of the base of each lobule; 8, the interlobular fissures seen through the coats of the sub-lobular vein; 9, interlobular spaces.

an irregularly pentagonal or hexagonal outline with sharp or rounded angles in proportion to the smaller or greater quantity of Glisson's capsule contained within the liver. Each lobule is divided upon its exterior into a base and a capsular surface. The base (fig. 34, 4) corresponds with one extremity of the lobule, is flattened and rests upon an hepatic vein, which is thence named *sub-lobular*. The *capsular surface* (fig. 34, 3, 3) includes the rest of the periphery of the lobule, and has received its designation from being inclosed in a cellular capsule derived from the capsule of Glisson. In the centre of each lobule is a small vein, the *intra-lobular* (fig. 34, 5, 6, fig. 35, 3) which is formed by the convergence of six or eight minute venules from the rounded processes situated upon the surface of the lobule. The intra-lobular vein thus constituted takes its course through the centre of the longitudinal axis of the lobule, pierces the middle of its base, and opens into the sub-lobular vein. The circumference of the lobule with the exception of its base, which is always closely attached to a sub-lobular vein, is connected by means of its cellular capsule with the capsular surfaces of surrounding lobules. The cellular interval between the lobules is the *interlobular fissure* (fig. 34, 8, fig. 35, 2), and the angular interstices formed by the apposition of several lobules are the *interlobular spaces* (fig. 34, 9, fig. 35, 1).

Fig. 35.

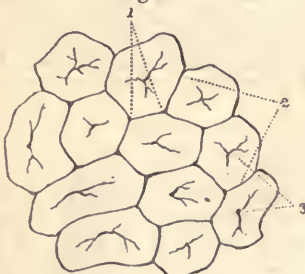

Angular lobules in a state of anæmia. From Kiernan's paper.

No. 1, interlobular spaces, containing the larger interlobular branches of the portal vein, hepatic artery and duct; 2, interlobular fissures; 3, intra-lobular veins formed by minute venules which converge towards the centre of the lobules.

The lobules present considerable variety of form dependent upon their situation and upon the manner in which they are examined. For instance, the section of a lobule divided transversely has an irregularly pentagonal or hexagonal figure, and longitudinally a foliated appearance. The lobules of the centre of the liver are angular and smaller than those of the surface, on account of the pressure to which, from their position, they are submitted by surrounding lobules. They are also more angular in some animals than in man. The surface of the liver of the cat, in which the portal vein is injected, has a beautiful reticulated appearance produced by angular meshes of an hexagonal figure; the hexagonal outline being

formed by the interlobular fissures, reddened by the injection in the minute branches of the portal vein, and the included area by the lobule viewed upon its transverse diameter. In a section of the liver made from the free margin to the posterior border in the direction of the hepatic veins, the lobules are found to be larger than in a section made transversely to those vessels. The lobules of the exterior, particularly on the concave side and posterior border, are for the same reason larger from lying obliquely to the surface and corresponding in direction with the course of the sub-lobular veins. They are also more rounded from the absence of compression by surrounding lobules. But one appearance described by Kiernan is peculiarly characteristic of the lobules which form the surface of the liver, the *superficial lobules*. The word *surface* in this instance does not refer simply to the periphery of the organ, but also to the various canals channelled through its interior for the passage of the portal vein, hepatic ducts, and hepatic artery, and also for the main trunks of the hepatic vein, "all these canals being" as it were "tubular inflections inwards of the superficies of the liver." The superficial lobules (fig. 34, 2, fig. 35) are not terminated by a rounded extremity like those of the centre, but are flat and apparently incomplete, and as though cut across by a transverse incision. This peculiar form gives to the anatomist a natural surface which affords all the advantages for observation of a transverse section, and enables him to detect by external examination the relative condition of both the central portion and surface of the lobule. In these lobules also the intra-lobular hepatic vein, instead of being entirely concealed within the lobule, commences directly from the flat surface. A knowledge of this structure, says Kiernan, "enables us in injecting the hepatic veins to limit the injection to this system of vessels, which is effected by withdrawing the syringe when the injection appears in minute points upon the surface of the liver." Occasionally double lobules, or lobules having two intra-lobular veins, are seen upon the surface.

"Each lobule," according to Kiernan, "is composed of a plexus of biliary ducts, of a venous plexus formed by branches of the portal vein, of a branch (intra-lobular) of an hepatic vein, and of minute arteries; nerves and absorbents, it is to be presumed, also enter into their formation, but cannot be traced into them." "Examined with the microscope, a lobule is apparently composed of numerous minute bodies of a yellowish colour, and of various forms, connected with each other by vessels. These minute bodies are the acini of Malpighi." "If an uninjected lobule be examined and contrasted with an injected lobule, it will be found that the acini of Malpighi in the former are identical with the injected lobular plexus of the latter, and the bloodvessels in both will be easily distinguished from the ducts."

GLISSON'S CAPSULE is the web of cellular tissue which envelops the hepatic artery, portal vein, and ductus communis choledochus during their passage through the right border of the lesser

omentum, and which accompanies them along the portal canals and interlobular fissures to their ultimate distribution in the substance of the lobules. It forms for each of the lobules a distinct capsule which invests it on all sides with the exception of its base, and is then expanded over the whole of the exterior of the organ, constituting the *proper capsule* of the liver. Glisson's capsule serves to maintain the portal vein, hepatic artery, and hepatic ducts in connection with each other, and attaches them also to the surface of the portal canals; it connects the trunks of the hepatic veins to the surface of the canals in which they run; it supports the lobules and binds them together, and by its exterior expansion it invests and protects the entire organ. But Glisson's capsule, observes Kiernan, "is not mere cellular tissue; it is to the liver what the pia mater is to the brain; it is a cellulo-vascular membrane, in which the vessels divide and subdivide to an extreme degree of minuteness; which lines the portal canals, forming sheaths for the larger vessels contained in them, and a web in which the smaller vessels ramify; which enters the interlobular fissures, and with the vessels forms the capsules of the lobules, and which finally enters the lobules, and with the bloodvessels expands itself over the secreting biliary ducts. Hence arises a natural division of the capsule into three portions, a vaginal, an interlobular, and a lobular portion."

The *vaginal portion of the capsule* is loose and abundant; it occupies the portal canals and incloses the portal vein, hepatic duct, and hepatic artery. In the larger canals (fig. 36, 3,) it completely surrounds these vessels, but in the smaller ones (fig. 37,) is situated only on that side of the portal vein upon which the duct and artery are placed, the opposite side of the vein being in contact with the capsular surfaces of the lobules. It constitutes a medium for the ramification of the vaginal plexus formed by the vein, artery, and duct, previously to their entrance into the cellular interval of the interlobular fissures.

The *interlobular portion* forms the cellular capsule for each of the lobules and the bond of union between their contiguous surfaces. It supports the plexiform ramifications of the portal vein, hepatic artery, and duct, and is the medium of vascular communication between all the lobules of the liver.

The *lobular portion* forms sheaths for the minute vessels which enter the lobules, and a cellular parenchyma for the substance of those bodies.

The *portal vein* is formed by the union of the venous trunks which return the blood from the chylipoietic viscera, viz., the superior and inferior mesenteric, the splenic, and gastric veins. Commencing behind the pancreas where all these veins converge, the portal trunk ascends along the right border of the lesser omentum, lying behind the hepatic artery and ductus communis choledochus to the transverse fissure. At the transverse fissure it bifurcates into two trunks which enter the right and left lobes, and divide and subdivide as they take their

course through the portal canals, until they are ultimately lost in the substance of the lobules. The branches of the portal vein are accompanied throughout their course by branches of the hepatic duct and hepatic artery, and they are inclosed and connected to the capsular surfaces of the lobules forming the portal canals, by Glisson's capsule. The branches of the portal vein are divisible into vaginal, interlobular, and lobular.

The *vaginal branches* (fig 36, 3, fig. 38, f) are the small veins which are given off by the portal trunks during their passage through the portal canals, and which are intended to convey

Fig. 36.

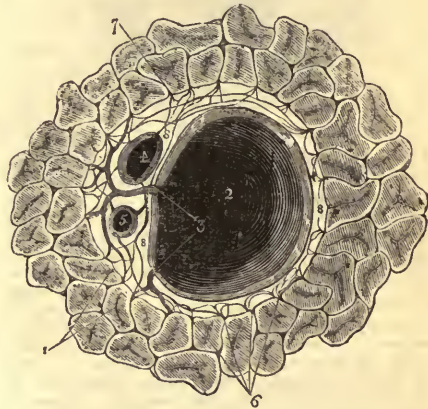

A transverse section of a large portal canal and its vessels. The lobules are in a state of general congestion, their central portions being more congested than their marginal portions. — From Kiernan's paper.

No. 1, Superficial lobules forming the parietes of the canal. In some the intra-lobular vein does not extend to the surface of the canal; this appearance depends upon the direction in which the incision is made. 2, The portal vein. 3, Vaginal branches arising from the vein and dividing into interlobular branches which enter the interlobular spaces. 4, Hepatic duct. It is seen to give off vaginal branches which divide into interlobular ducts, the latter enter the interlobular spaces. 5, The hepatic artery; it is seen giving off vaginal branches which divide into interlobular branches, and the latter enter the spaces with the branches of the portal vein and hepatic duct. 6, Three interlobular vessels, a duct, vein, and artery, entering each interlobular space. 7, A part of the vaginal plexus. 8, 8, Glisson's capsule, which completely surrounds the vessels.

their blood into the substance of the lobules. In the cellular sheath of Glisson's capsule which surrounds the portal vein, they inosculate freely with each other and form, together with the vaginal branches of the duct and artery, a vascular plexus, named from its situation the *vaginal plexus*. This vaginal plexus establishes a communication between the vaginal veins throughout the portal canals, and serves to equalise the supply of blood to the lobules. Opposite each interlobular space an interlobular vein is given off, which enters between the lobules and ramifies in the interlobular fissures. In the larger portal canals (fig. 36,) the vaginal plexus completely surrounds the portal vein, hepatic duct

and hepatic artery, and the interlobular spaces are supplied solely with branches which are derived from its ramifications. But in the smaller portal canals (fig. 37, fig. 38) the capsule of Glisson, upon which the plexus chiefly depends, is

Fig. 37.

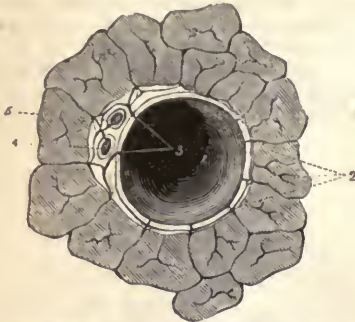

A transverse section of a small portal canal and its vessels. The lobules are in a state of general congestion. From Kiernan's paper.

No. 1, The portal vein; the greater part of its cylinder is in contact with the portal canal. 2, Interlobular branches of the vein entering directly the interlobular spaces, with branches of the artery and duct, without ramifying in the canal. 3, Two vaginal branches arising from the vein, and forming a vaginal plexus on that side of the vein, which is separated from the canal by Glisson's capsule. From the plexus the interlobular branches arise. 4, The hepatic duct giving off vaginal branches. 5, The artery giving off vaginal branches. Glisson's capsule is situated on one side only of the canal.

situated only upon that side of the vein, on which the duct and artery are placed, and the vaginal plexus consequently follows the same disposition. On the opposite side the portal vein being in contact with the lobules, gives off interlobular branches directly to the spaces. If the portal vein (fig. 38) be laid open in this situation, the form of the lobules bounded by the interlobular fissures will be distinctly apparent through its coats, and the openings of the interlobular veins will be found to correspond with the interlobular spaces.

The interlobular veins enter the intervals of the lobules through the interlobular spaces and divide into numerous minute branches, which ramify in the capsules of the lobules and then enter their substance. They cover with their ramifications the whole external surface of the lobules with the exception of their bases, and of those extremities of the superficial lobules which appear upon the surfaces of the liver. The interlobular veins communicate freely with each other and with the corresponding branches of adjoining lobules, and establish a general portal anastomosis of the freest kind throughout the entire liver. When the portal vein is well injected, these veins form a series of insculations which surround all the lobules and give to the surface of the organ the appearance of a vascular network composed of irregularly pentagonal and hexagonal meshes. If the vein be only partially injected the interlobular vein in the interlobular space is alone filled, and the branches which it sends off into the neighbour-

Fig. 38.

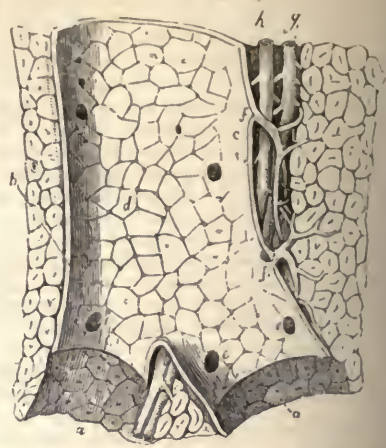

Longitudinal section of a small portal vein and canal. The lobules are in a state of anæmia.—After Kiernan.

a, Portions of the canal from which the vein is removed to show that it is formed by lobules which present the same appearance with those upon the external surface of the liver. b, The side of the portal vein which is in contact with the canal. c, The side of the vein which is separated from the canal by the hepatic artery and duct, by the Glisson's capsule surrounding them, and by the vaginal plexus. d, The internal surface of the portal vein, through which is seen the outline of the lobules, and the openings of the interlobular veins which correspond with the interlobular spaces. Upon the opposite side (c), the portal vein being separated from the portal canal there are no interlobular veins. e, The openings of smaller portal veins. f, Vaginal veins giving off branches in the portal canal and forming a plexus. g, The hepatic artery giving off vaginal branches. h, The hepatic duct giving off vaginal branches.

ing interlobular fissures not proceeding so far as to insculcate and form meshes, have a radiated appearance and resemble a number of minute stellæ; these are the *stellated vessels* of anatomists.

The lobular veins are derived from the interlobular veins; they form a plexus within the lobule, and converge from the circumference towards the centre, where they terminate in the minute branches of the intralobular vein. "This plexus, interposed between the interlobular portal veins and the intralobular hepatic vein, constitutes the venous part of the lobule, and may be called the *lobular venous plexus*." (fig. 39). The irregular islets of the substance of the lobules seen between the meshes of this plexus by means of the microscope are the acini of Malpighi, and are shown by Kiernan to be portions of the lobular biliary plexus.

The portal vein collects the venous blood from the chylopoietic viscera, and then circulates it through the lobules; it likewise receives the venous blood which results from the distribution of the hepatic artery to the structures of the liver; these two sources of supply constitute the two origins of the portal vein, the *abdominal origin* and the *hepatic origin*.

Fig. 39.

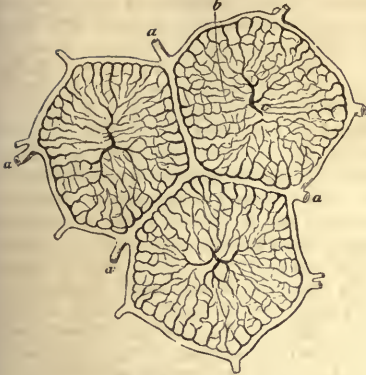

Two lobules, in which the portal venous plexus is seen. After Kiernan.

a a, Interlobular veins. The appearance of venous circles formed by these veins is that which is afforded by a common lens; when examined with a higher power the interlobular fissure is seen to be filled by a vascular plexus. *b*, The lobular venous plexus. The circular and ovoid spaces seen between the branches of the plexuses are occupied by portions of the biliary plexus; they are the acini of Malpighi. *c*, The intralobular vein in the centre of each lobule, collecting the blood from the lobular venous plexus.

The hepatic duct bifurcates in the transverse fissure into two branches, which enter the right and left lobes of the liver and subdivide into smaller branches, and the smaller branches accompany the divisions of the portal vein and hepatic artery through the portal canals to their ultimate distribution in the lobules. The branches of the hepatic duct, like those of the portal vein, are divisible into the vaginal, interlobular, and lobular ducts.

The vaginal ducts pass transversely through the capsule of Glisson, by which they are enveloped in common with the portal vein and hepatic artery, and divide into numerous small branches which assist in forming the vaginal plexus. From the plexus of ducts two kinds of branches are given off, the interlobular, which run along the margins of the interlobular fissures and enter the interlobular spaces to be distributed upon the capsular surfaces of the lobules; and the lobular, which enter the substance of those lobules which form the parietes of the portal canals. In the smaller portal canals the vaginal branches and plexus are situated only on the portal side of the canal, the interlobular branches, on the side nearest the duct, passing directly into the interlobular spaces. "The transverse branches and those which arise immediately from them do not anastomose with each other, but the smaller branches sometimes appear to do so; I cannot, however," says Kiernan, "from dissection, affirm that they do, for those which appear to anastomose are exceedingly small vessels and meet each other at the spaces, hence it is difficult to ascertain whether they really anastomose or enter the spaces together without anastomosing."

The interlobular ducts ramify upon the capsular surface of the lobules with the branches of the portal vein and hepatic artery. Kiernan finds these ducts to communicate freely with each other, for he says, "If the left hepatic duct be injected with size or mercury, the injection will return by the right duct without extravasation and without passing into other vessels, and the injection will be found in the interlobular and vaginal ducts as well as in the trunks. This communication between the two ducts does not take place like that which exists between the right and left arteries through the medium of the vaginal branches of the transverse fissure, the injection being found in interlobular branches arising from the right duct. From this experiment, which I have frequently repeated with the same result, it appears that the right and left duct anastomose with each other through the medium of the interlobular ducts. This experiment does not always succeed, which probably arises from the quantity of bile contained in the ducts."

The lobular ducts entering the lobule by its circumference divide and subdivide into minute branches which anastomose with each other and form a "reticulated plexus," the lobular biliary plexus (fig. 40). This plexus consti-

Fig. 40.



Two lobules in which the lobular biliary plexus is shown. After Kiernan.

a a, Interlobular ducts giving off branches which form the plexus within the lobules. The central portion of the lobules is uninjected. *b b*, The ramifications of the intralobular veins. With regard to this figure Kiernan observes, "No such view of the ducts as that represented in this figure can be obtained in the liver. The interlobular ducts are in the figure seen anastomosing with each other. I have never seen these anastomoses, but I have seen the anastomoses of the ducts in the left lateral ligament, and from the results of experiments related in this paper, I believe the interlobular ducts anastomose. I have never injected the lobular biliary plexuses to the extent represented in the figure."

tutes the principal part of the substance of the lobule, and seen through the meshes of the portal venous plexus, gives rise to the appearance of acini or of coecal terminations of ducts. The ultimate terminations of the ducts have not yet been seen; they are imagined by Müller to end in "short pannicle-like tufts closely interwoven together," and he supports his opinion by citing the circumstance of the ducts in the embryo of the fowl and larva of

the frog ending in twig-like terminations. Kiernan inclines to the opinion that they terminate in loops, although he says nothing which could lead us to suppose that he rejects the possibility of their terminations being caecal. Both authors agree that they end by closed extremities. It is this plexus which constitutes the true glandular portion of the liver.

Müller, in reference to the terminations of the ducts in anastomosing plexuses, states, that the history of the development of the organ is opposed to the belief in the existence of anastomoses. Certainly, if we are to credit the principle which he himself has established for the development of glands, viz. that "however various the form of the elementary parts, all secreting glands without exception follow the same law of conformation," the same process must take place in all; and analogy would lead us to infer that a plexiform anastomosis would be the arrangement of the terminal ducts in so complicated a gland as the liver of the adult, whatsoever it may happen to be in the undeveloped organ of the embryo. That there is nothing irrational in this opinion we would turn for proof to another page of his Physiology, where he observes, "in the scorpion, as I have discovered, the tubes (of the testis) *anastomose*, forming loops." Again, he says, "Lauth has but once seen a seminal canal ending with a free extremity in the human testis. Krause has seen such free ends of the tubuli seminiferi frequently, and confirms the opinion of their terminating in that way as well as by anastomosis. Lauth attributes the circumstance of free extremities of the tubes being so seldom seen to their uniting with each other so as to form loops. He describes the division and reunion of the tubes to be so frequent that in a small portion which he spread out, and in which there were about forty-nine inches of tube, he found about fifteen anastomoses. It is, however, only towards their extremities that the seminal tubes anastomose thus freely. The discovery of the anastomoses of the seminal tubes is perfectly original." Krause observes the same fact also with regard to the uriniferous ducts. Now I would ask why, if the ducts of the seminal gland and uriniferous gland anastomose so freely, the ducts of the biliary gland should not do the same? And why, if the anastomoses of the seminal ducts be a discovery *so original*, the less easily demonstrable fact of the anastomoses of the biliary ducts, discovered by Kiernan, may not be equally original? I speak from laborious research upon this subject, and surely there cannot be a comparison between the difficulty of unravelling the simple ducts of the testis and the complicated and minute masses of the biliary ducts, an aggregation so intricate that Müller acknowledges it "difficult to decide the question." The above facts of the anastomoses of the seminal and uriniferous ducts would, in my mind, were other evidence wanting, be a circumstance powerfully aiding my belief in the anastomoses of the biliary ducts; but the subject is not without its proofs, and these, as it appears to me, from careful examination, incon-

testible. "The left lateral ligament," says Kiernan, "may be considered as a rudimental liver, in which this organ presents itself to our examination in its simplest form. From that edge of the liver connected to the ligament, numerous ducts emerge, which ramify between the two layers of peritoneum of which the ligament is composed." "These ducts, the smallest of which are very tortuous in their course, divide, subdivide, and anastomose with each other. They are sometimes exceedingly numerous, two or three of them in such cases being of considerable size; some of them, as Ferrein" (by whom they were discovered) "says, frequently extend to the diaphragm and ramify on its inferior surface. They sometimes extend only half way up the ligament, where they divide into branches, which forming arches (*fig. 41.*) return and descend towards the liver,

Fig. 41.

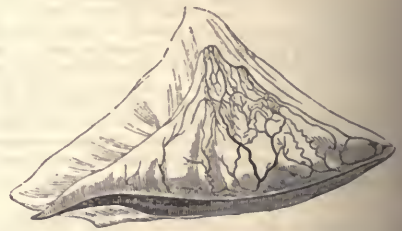

The left lateral ligament, in which are seen the injected biliary ducts with their anastomoses. After Kiernan.*

anastomosing or being continuous with other ducts issuing from it. The spaces between the larger or excreting ducts are occupied by plexuses of minute or secreting ducts." "Branches of the portal and hepatic veins, with arteries and absorbents, also ramify in the ligament, which, including between its layers a plexus of secreting and excreting ducts, with bloodvessels ramifying on their parietes, admirably displays the structure of the liver." The same appearances are seen in the bands which sometimes arch over the vena cava and longitudinal fissure, when they are sufficiently thin.

The hepatic ducts are extremely vascular, and in a well-injected liver are always completely covered with the ramifications of the hepatic artery. The rugæ upon their internal surface are formed by large vessels, "arteries as well as veins," which are distributed beneath the mucous membrane. This membrane, seen beneath the microscope, appears plaited over every part of its surface by innumerable laminated papillæ of a semilunar form. The vessels distributed upon these papillæ consist of an artery which ascends upon each side of the lamina, and divides into a beautiful network of capillaries which are collected after their distribution into a small vein and returned to the portal vein. "It is," says Kiernan, "to the rupture of the delicate vessels forming these

* I have carefully examined this preparation and pledge myself to its accuracy.

papillæ that is to be attributed the facility with which Söemmering and other anatomists injected the ducts from the arteries and veins, and not to any direct communication between the vessels and the ducts."

The mucous lining of the ducts is provided with a considerable number of muciparous follicles which mingle their secretion with the bile during its passage along the excretory tubes. These follicles have been described by all anatomists as existing in the larger ducts, but they were not known to be present in the smaller branches until they were discovered and figured by Kiernan. In the larger ducts they are irregularly dispersed, but in the smaller tubes are found arranged in two longitudinal rows upon opposite sides of the ducts. Hence the vascularity of the hepatic ducts is intended to perform a higher function than the mere nutrition of those tubes; it provides an important secretion as an auxiliary to the composition of the bile.

The *hepatic artery* arises from the cœliac axis and ascends through the right border of the lesser omentum to the transverse fissure of the liver, where it bifurcates into two branches for the right and left lobes. The right and left hepatic arteries ramify in the portal canals, and give off branches which accompany each twig of the portal vein and hepatic duct. Their branches, like those of the vein and duct, are the vaginal, the interlobular, and the lobular.

The *vaginal arteries* arise from the hepatic arteries in the portal canals, and assist in forming the vaginal plexus in the capsule of Glisson, from which the interlobular branches are given off to accompany the interlobular portal veins and ducts. In the larger canals the plexus completely surrounds the portal vessels, but in the smaller canals the plexus is situated only on the side opposite to the cylinder of the artery, and in the tissue of Glisson's capsule. This vaginal plexus has the effect of supplying the lobules which are the most distant from the vessel to which they belong, as certainly, as those which are in immediate contact with its cylinder. The vaginal arteries anastomose so freely with each other, that if the hepatic artery of one side be injected, the injection will return by that of the opposite side.

The *interlobular arteries* enter the intervals of the lobules through the interlobular spaces and ramify upon the capsular surface of the lobules. They are distributed principally to the interlobular ducts, around which they form a vascular net-work. The question of the insosulation of these vessels is very difficult to decide by dissection on account of their extreme minuteness; but analogy would lead us to infer that they must communicate.

The *lobular arteries*, "exceedingly minute and few in number," so as to be demonstrable with much difficulty in the structure of the lobules, enter the circumference of these bodies with the lobular ducts upon which they are distributed. They are the nutrient vessels of the lobules, and terminate in the lobular venous plexus formed by the portal vein.

The mode of distribution of the hepatic ar-

tery is a subject upon which some difference of opinion subsists between Müller and Kiernan. Kiernan states that the hepatic artery is distributed chiefly upon the coats of the ducts and gall-bladder, upon the coats of the other vessels to which it forms the vasa vasorum, and to the substance of the lobules. The ducts are highly vascular, and are abundantly supplied, the lobules sparingly, but "few" vessels, and those "exceedingly minute," being traceable into them. From the capillaries of the ducts and vessels, the blood having become venous during its circulation is returned into the portal vein, and thence conveyed onwards to the lobules, where it is distributed through the lobular venous plexus. The blood of the terminal lobular arteries also becomes venous in the substance of the lobules, and is likewise poured into the lobular venous plexus. So that, according to this author, the whole of the blood distributed through the hepatic artery is received by the portal vein, either in the course of that vessel, or at its termination in the lobular venous plexus, and therefore, that all the blood circulating through the plexus must necessarily be *venous*. He likewise affirms that no part of the blood of the artery is poured directly into the hepatic vein. "The intra-lobular veins," he says, "convey the blood from the lobular venous plexus, and not from the arteries." These views are the results of the evidence of numerous experimental injections. With regard to the vascularity of the lobules, he observes, "These bodies cannot be coloured with injection from the artery, even in the young subject; in the adult, after the most successful injection, when the arteries of the cellular capsule, those of the excreting ducts and gall-bladder, and the vasa vasorum are minutely injected, a few injected vessels only are detected entering the lobules. I have frequently tied the thoracic aorta in living animals, thereby cutting off all supply of blood from the abdominal viscera; and in these animals, when injected from the aorta below the ligature forty-eight hours after death, the integuments, the secreting portions of the kidneys, the spleen, pancreas, intestines, and pelvic viscera were coloured in a remarkable degree by the injection; on the surface of the liver a few vessels only could be discovered, this organ presenting a curious contrast with the surrounding coloured viscera. The gall-bladder and ducts were, however, equally well injected with the intestines; the vasa vasorum were also well injected." Perceiving in the progress of his experiments that the injection thrown into the artery passed freely into the portal vein by means of the capillary communication existing between these two vessels on the coats of the ducts, and through the vasa vasorum of the vessels, he imagined that the injected fluid might in this way be diverted from the lobules, and that this must be the cause of his want of success in filling the lobular arteries. To ascertain if such were the case, he injected the portal vein in the first instance with blue, and then the arteries with red. "On dissection, branches of the two sets of vessels were found in the coats of the

vessels, and in those of the excreting ducts and gall-bladder; the lobules were coloured with the blue injection; the red was confined to their circumference, and appeared in points only. This experiment was varied by injecting the portal vein and its branches as far only as the entrance of the latter into the lobules, the lobules thus remaining uninjected. The injection propelled through the arteries had now free access to the uninjected lobules, and no exit by the injected portal vein; and the artery having no communication with the hepatic veins, the injection had no exit by these vessels: the lobules however were not better injected in this than in the preceding experiments. From these experiments I conclude, that the secreting part of the liver "is supplied with arterial blood for nutrition only. As all the branches of the artery of which we can ascertain the termination, end in branches of the portal vein, it is probable that the lobular arteries terminate in the lobular venous plexuses formed by that vein, and not in the intralobular branches of the hepatic veins, which cannot be injected from the artery." Müller, who published upon this subject previously to the discoveries of Kiernan, and was therefore not aware of the exact distribution of the vessels, was deceived by this free communication between the hepatic artery and portal vein. He conceived, with the older anatomists, that the arterial blood was mixed with the venous blood of the *vena portæ*, in a capillary network, "*vascula ultima reticulata*," common to the three bloodvessels of the liver, the hepatic artery, portal vein and hepatic veins. Observing, moreover, in the injected preparations of Lieberkühn,* that the "*vascula ultima reticulata*," the lobular venous plexus of Kiernan, appeared as well filled when the injected fluid was forced into the hepatic artery, as when introduced through the portal or hepatic vein, he at once decided that the artery must pour its blood directly into this plexus. Hence he writes, "*Vascula ultima reticulata sanguinem tam ab arteriis quam a venâ portarum accipere, venisque hepaticis reddere, ex hisce argumentis concludo: Post injectionem in arteriam hepaticam non minus quam in venam portarum aut venas hepaticas factam, eadem communia vasculorum minimorum retia replentur, quod ex injectionibus exsiccatis Lieberkühnianis, Berolini asservatis, facile quisquis sibi persuadebit.*" Having recourse himself to an extremely imperfect experiment, the injection of water into the hepatic artery, and finding that this fluid returned by the portal vein, and possibly by the hepatic vein, he became convinced of the communications of all the vessels in the "*vascula ultima reticulata*," and added another argument to the injections of Lieberkühn in favour of his opinion; for he says, "*Injecti liquores co-*

lorati ex alio vasorum ordine facile in alium transeunt, qualis frequens Halleri veterumque, Walteri, denique et Rudolphi cel. extat experientia. Ipse equidem transitum aquæ limpidae et coloratæ sæpius observari." Now with regard to the injections of Lieberkühn, I can only repeat with Kiernan, that *if* the lobular venous plexus or "*vascula ultima reticulata*" were filled, actually, from the artery, the only route which the injection could have taken must have been through the capillaries of the excretory ducts and *vasa vasorum*, and then through the portal vein. But with regard to the water experiment, I am quite satisfied of its utter inadequacy to elucidate so delicate a point as that under discussion. In my own experiments, made with a view of assuring myself of the nature of these plexuses, I have not been content with my injection unless I could distinctly trace with the aid of the microscope each capillary vessel from the interlobular vein to the intralobular vein, and this I have never failed to do in a successful injection from the portal vein; or in the opposite course when the hepatic veins have been filled. But in the most successful injection from the artery, when the capsular arteries have been beautifully filled, I have never observed more than a few red points in the circumference of the lobules. There is, however, in the consideration of this question, one circumstance which appears to have been altogether overlooked by Müller, but which seems to me to be fatal to the opinion which he entertains with regard to the distribution of the arterial blood. The ducts are abundantly supplied with blood from the arteries; indeed to so great an extent, that in a well-injected liver their coats appear to consist almost wholly of the ramifications of minute vessels. Now if the aggregate of the surface formed by the ducts, which is thus covered with vessels supplied from the artery, be considered, it must be evident that very little can be left for the "*vascula ultima reticulata*." And if conjointly with this fact, the difficulty of injecting the lobules from the artery be considered, it must be admitted that Müller carries his dogma somewhat too far, in asserting without limitation "that the arterial blood of the hepatic artery and the venous blood of the *porta* become mixed in the minute vessels of the liver."

The *hepatic veins* return the whole of the venous blood from the liver to the general venous circulation. They commence in the centre of each lobule by means of a small vein, the *intralobular*, which collects the blood after its circulation through the lobular venous plexus. The intralobular veins pour their current into the *sublobular* veins, and these latter unite to form the hepatic trunks, which terminate in the inferior *vena cava*. The hepatic differ from the portal veins in being more immediately in contact, and more closely connected with the substance of the lobules. Thus the intralobular veins are embedded in the substance of each lobule, and the sublobular inclosed in canals formed by the bases of the lobules, and therefore by that part which is uninvested by the lobular capsule. The hepatic trunks differ

* Having, through the kindness of Mr. Liston, had an opportunity of examining with the microscope some of the injections of Lieberkühn of different tissues, I can bear testimony to their beauty and wonderful minuteness, and can fully appreciate the deservedly high estimation in which they are held among the physiologists of Germany.

from the preceding in being lodged in canals formed by the capsular surface of the lobules, the *hepatic venous canals*, which are analogous to the portal canals excepting in the absence of a proper investment of Glisson's capsule. It follows from this circumstance, that there are no vessels in connection with the hepatic veins at all resembling the vaginal branches and plexuses of the portal vein. The general course of the hepatic veins is from the two surfaces and free margin of the liver towards the vena cava in the posterior border; that of the portal vein radiates from the transverse fissure in the centre of the under surface to all parts of the circumference; hence the two veins cross each other in their course, the former proceeding from before backwards, and the latter from the centre towards the circumference. In examining either of these sets of vessels, we should, therefore, be guided in the direction of our section by this peculiar arrangement. There is another mode by which we arrive at a knowledge of the means of discriminating between the two veins in a section. The hepatic vein being closely adherent to the lobules forming the canal in which it is lodged, remains open, and retains the form of its cylinder upon the face of a section; it may also be recognised by being solitary. The portal vein, on the contrary, being surrounded by the loose, vasculo-cellular web of Glisson's capsule, is permitted to collapse; it is also characterised by being associated with a branch of the hepatic artery and duct. In the consideration of the hepatic veins I shall describe, first, the intralobular, next the sublobular, and then the hepatic trunks.

In the centre of each lobule is situated an *intralobular vein* (fig. 34, 5) which is formed by the convergence of from "four to six or eight" minute venules, from the processes upon the surface of the lobule. In the superficial lobules, the intralobular vein commences directly from the surface, and the minute venules by which it is formed may be seen in an ordinary injection converging from the circumference towards the centre. The vein then takes its course through the centre of the longitudinal axis of the lobule, and piercing the middle of its base opens into the sublobular vein. The intralobular veins have no direct communication with the portal vein or with the hepatic artery, and they simply serve to collect the blood which has circulated through the lobular venous plexus, and convey it into the general current of the hepatic veins.

The *sublobular veins* (fig. 34) are named from their position at the base of the lobules. They are lodged in canals which are formed by the bases of all the lobules of the liver. They are extremely thin and "delicate in texture," and lie in close contact with the substance of the lobules, so that upon laying open one of these veins, the bases of the lobules may be seen distinctly through its coats. In the centre of the base of each of the lobules will be observed the opening of the intralobular vein, so that the whole internal surface of the vein is pierced by these minute openings. In the

smaller portal veins, on the other hand, where a number of small foramina were seen upon the internal surface of that side of the vessel which lay in contact with the canal, and where the outline of the lobules was also perceptible, it was observed that the small openings corresponded with the interlobular spaces, and were the entrances of the interlobular veins.

The *hepatic trunks* receiving the blood from the sublobular veins take their course along the "hepatic venous canals," and terminate by two large openings corresponding with the right and left lobes in the inferior cava, at the point where that vessel is lying deeply imbedded in the posterior border of the liver. A number of minor hepatic veins also terminate in the cava at this part of its course. The *hepatic venous canals* resemble the portal canals in being formed by the capsular surfaces of the lobules, lined by a prolongation of the proper capsule. The hepatic trunks are thick and dense in their structure, and their external coat is composed of "longitudinal bands." From the thickness of their texture the outline of the lobules is not apparent through their coats, nor have they any intralobular veins opening into them.

The coats of the hepatic veins are supplied with blood by the hepatic artery, and the venous blood is returned to the ramifications of the portal vein.

The *lymphatic* vessels of the liver are divisible into the deep and superficial. The former take their course through the portal canals, and through the right border of the lesser omentum, to the lymphatic glands situate in the course of the hepatic artery, and along the lesser curve of the stomach. They are easily injected (by rupture of course) from the hepatic ducts, and Kiernan remarks, that "injection sometimes passes from the arteries and portal veins into the lymphatics. I have frequently seen them in the right border of the lesser omentum, when distended with injection, as large as small veins. The *superficial lymphatics*, (figs. 32 and 33,) are situated in the cellular structure of the proper capsule, over the whole surface of the liver. Those of the convex surface are divided into two sets; 1st, those which pass from before backwards; and 2d, those which advance from behind forwards. The former unite to form trunks, which enter between the folds of the lateral ligaments at the right and left extremities of the organ, and of the coronary ligament in the middle. Some of them pierce the diaphragm, and join the posterior mediastinal glands; others converge to the lymphatic glands situated around the inferior cava. Those which pass from behind forwards consist of two groups; one ascends between the folds of the broad ligament, and perforates the diaphragm to terminate in the anterior mediastinal glands; the other curves around the anterior margin of the liver to its concave surface, and from thence to the glands in the right border of the lesser omentum. The lymphatic vessels of the concave surface are variously distributed according to their position; those from the right lobe terminate in the lumbar glands;—those from

the gall-bladder, which are large and form a remarkable plexus, enter the glands in the right border of the lesser omentum; and those from the left lobe converge to the lymphatic glands situated along the lesser curve of the stomach.

The *nervus* which supply the liver are derived from the systems both of animal and organic life; the former are filaments of the right phrenic and two pneumo-gastric nerves, and the latter of the solar plexus. The branches from the right phrenic nerve descend by the side of the inferior cava, to unite with the hepatic plexus in the right border of the lesser omentum. Swan describes a small ganglion, to which filaments converge from the right semi-lunar ganglion and right phrenic nerve, as being the medium of communication between the phrenic nerve and the hepatic plexus. The branches of the pneumo-gastric nerves pass between the two layers of the lesser omentum to its right border, and pursuing the course of the hepatic artery are distributed with the hepatic plexus to the gall-bladder and along the portal canals. The *hepatic plexus* proceeds from the solar plexus and surrounds the hepatic artery to the transverse fissure; its filaments then accompany the branches of that vessel to their ultimate termination, and some few are observed to ramify upon the portal vein.

Progressive development of the liver in the animal series.—The liver in its simplest condition is a mere inflection of the mucous lining of the alimentary canal, forming a small cœcal recess or follicle. The capillary vessels ramifying upon the parietes of this follicle pour their secretion upon its internal surface, and it is thence conveyed to the alimentary canal to be mingled with the ingesta. In this its most rudimentary form the liver would appear to be present in the *Laginella*, a small cilio-brachiate polypus described and figured by Dr. Arthur Fare.* Upon the stomach of the *Laginella* are seen several minute cœca which open into its cavity; they are usually empty when the animal has been for some time without food, but become filled with a brownish fluid after a meal. The next most elementary form of the hepatic cœcum is seen in the single lengthened follicle discovered by Owen in the *ascaris haliensis*. This follicle opens into the alimentary canal at about one-third from its oral extremity. Among the *Annelida*, as in the medicinal leech (*fig. 69*, vol. i.) the liver is represented by numerous simple cœcal pouches appended to each side of the digestive canal. The next step in the complication of the organ is observed in the lengthened filiform tubuli which are connected with the sides of the canal in the *Aphrodita*. These are narrow and constricted at their commencement, dilating gradually as they proceed farther from the intestine, and terminating by a small oval sac. In other species of the same genus and in the *Arenicola* (*fig. 70*, vol. i.) they display a tendency to ramify, by developing small cœcal pouches

from their sides. In these terminal saeculi Pallas discovered a "bitter fluid, of an olive-brown or greenish-black colour," which he conceived to be the juices of marine plants which had gained admission into the tubuli through their openings of communication with the intestine, but which, it is more than probable, was the proper biliary secretion of the tubes themselves. In the class *Insecta* the hepatic cœca vary in progressive development upon the digestive canal of the *Lampyrus splendidula*, or the simple cœcal tubulus of the carnivorous *Cicindela*, to the numerous cœcal follicles of the *Dytiscus*, or to the more lengthened tubuli of the *Blatta orientalis*. Throughout the whole of the class the character of the liver is tubular, the development and extent of the tubuli depending upon peculiarities in the food or habits of the animals. In *Arachnida*, the cœcal follicles are short, and terminate at their extremities in a cluster of numerous rounded vesicles, which give to the organ a lobulated appearance. They are seen in the Scorpion, in *fig. 83, c, c*, page 204, vol. i. In the class *Crustacea*, the hepatic organ assumes a higher and more complicated character; the simple cœcal follicle of *Insecta* becomes branched and ramified, of which we have a good example in the *Argulus foliaceus*, delineated by Müller. In the *Astacus fluviatilis* (*fig. 214*, page 483, vol. i.) the hepatic follicle is more branched than in the *Argulus*; and in the *Pagurus striatus* (*fig. 215*, page 484, vol. i.) the liver is composed of an extraordinary assemblage of ramified follicles. In the hepatic organ of the *Squilla* mantis we perceive a remarkable transition from the simple branched and ramified follicle of the lower *Crustacea* to the higher forms of the organ in the molluscan classes. Upon the exterior it is lobulated, and each lobe is composed of a congeries of minor lobules which appear like granulations upon its surface. Examined in its interior it presents a primary dilated sac of considerable size, from which branch off a number of secondary sacs of smaller dimensions, and these latter are studded over every part of their surface with minute cœcal follicles of a rounded form. In the subregnum *Mollusca* the liver is of large size, and approaches in external form to the solid and lobulated organ of vertebrata. In internal conformation we may still trace among the lower classes a close analogy with the ramified tubuli of *Articulata*. Thus in the class *Gasteropoda* the gland is composed of cœcal pouches, which divide and subdivide into smaller and smaller follicles and terminate in small dilated sacs. They may be compared in their disposition to the stem, branches, twigs, and fruit of a cluster of grapes. A liver of this kind is seen in the *Helix pomatia*. In the *Murex* triton the follicular structure of the organ would appear to be lost. The external surface presents a lobulated form, but the interior is composed of a delicate spongy tissue, consisting of larger and smaller cells, which may all be inflated from the excretory duct. This seeming difference in the structure

* Philosophical Transactions, 1837.

of the organ is, however, more apparent than real, for the numerous cells may be considered as so many follicles from which smaller follicles are developed. The cellular character of the organ depends upon the more extensive subdivision of the follicles, their assemblage in greater numbers, their consequent compression, and the adhesion of their parietes. In the *Sepia* family the spongy structure of the hepatic organ is still more distinct. It is channelled into numerous canals, from which smaller canals branch off in various directions; from these branches cells are developed, and the parietes of the cells are every where surrounded by smaller and smaller cells, the entire texture being very similar in arrangement to the cellular lung of the higher reptilia.

The liver in *Vertebrata* is more close and complex in its structure and less amenable to the observations of the anatomist than in the inferior series. We observe nothing, even in the lowest fishes, which bears any direct comparison with the cellular structure of the liver of *Cephalopoda*. The general character of the organ in fishes is loose and flabby, shewing that, although difficult to demonstrate, its internal texture evidently contains numerous tubuli. If the efferent duct of the liver of a fish be inflated, the whole organ appears distended; hence we might infer that the primitive structure of the organ is precisely the same, consisting in the ramifications of the hepatic tubuli or ducts, the increased wants and higher position of the animal demanding an augmented extension of surface. This is the great principle in the development of all glandular organs—extension of surface. The simple follicle is sufficient for an animal so low in the scale as a cavitary entozoon, but as the functions of the animal increase, its simple follicle must be extended to a greater length, or branched or ramified; and as high in the animal scale as the *Vertebrata* these subdivisions have attained so great a degree of minuteness that they are demonstrable to the practised eye only through the aid of the highest microscopic powers.

Müller arranges the glandular system into *simple* and *compound* glands. The former he divides into two groups: 1. "*simplest glands*," which "are mere recesses of greater or less dimension in the surface of a membrane;" and 2. "more complicated forms," in which several of the recesses are assembled together and open by so many distinct mouths, or they unite and form a common duct which terminates by a single opening. The "*compound glands*" he likewise subdivides into two groups: 1. those which "ramify with a certain degree of regularity, the principal trunk giving off branches laterally at certain intervals, these sending out in the same way side branches, which in their turn afford a third set." This disposition constitutes lobulated glands, and is the type of conformation of the liver in *Invertebrata*. 2. "The second group of the glands with ramified secreting tubes consists of those in which the ramification is irregular, and in which there is no division and subdivision of

the gland into" secreting "lobules. The liver of *Mammalia* belongs to this group."

The form of the liver in *Fishes* corresponds with the direction of the long axis of the body; thus, for instance, it is elongated, and consists of a single lobe in the eel, while in the skate it is broad and extends into each lateral half of the abdominal cavity. In other fishes it is variously divided into lobes, and is often placed altogether on the left side of the body. In the class *Amphibia*, the liver also corresponds with the form of the body of the animal: in the frog it is short and divided into two primary lobes and several lobules; in the lengthened forms it is long and less divided. In the class *Reptilia* the liver is large, and bears an equal relation to the form of the visceral cavity. It is long and undivided in *Ophidia*, and short and divided into a right and a left lobe in *Sauria* and *Chelonia*, the two lobes being spread out over the intestines. In *Birds* there is great uniformity in the form and size of the liver. It is smaller in proportion to the bulk of the body than in *Reptilia* and *Fishes*, and larger than in *Mammalia*. It is situated in the middle line of the visceral cavity, and receives the heart into a depression upon its under surface. In the class *Mammalia* the liver is very much reduced in size, and is more compact and firm than in the lower vertebrata. In animals with simple stomachs it is situated in the middle line of the abdomen. In others, with large or compound stomachs, it is pressed towards the right side. The number of lobes does not depend upon a greater or less division of the liver into parts in accordance with the activity and mobility of the animal, but obeys a law in the animal economy, by which new parts are superadded in proportion to the increase of the wants of the creature. Man is placed at the foot of the scale in the progressive complication in external form of the liver of vertebrata; the entire organ may be considered in him as a central lobe, the lobus Spigelii being the rudiment of a second or right lobe. The liver of the orang offers the same character. Ruminants have also a liver which presents the most rudimentary form of division. The liver of man is the type of the central or principal lobe, to which are added upon each side, in the animal scale, a right and a left lobe, and from these latter are developed a right lobule and a left lobule. This most complicated form of liver, consisting of five lobes, is met with among *Carnivora* and *Rodentia*; and throughout *Mammalia*, the successive additions and subtractions from this normal type form a constant and generic character. Besides this real division of the liver into five lobes, fissures of various depth are constantly met with, as in man, which give the appearance of a much greater subdivision. These secondary portions are to be looked upon as the mere results of separation, and have no relation with the primitive type. A most extraordinary form of liver is met with in a small rodent animal from Cuba, the *Capromys*, in which the whole surface is divided by deep fissures into small masses of a triangular and quadrangular form, like the kidney of a bear.

A similar arrangement is seen upon the visceral surface of the liver in the Llama.

The *gall-bladder* is absent in all invertebrata, the efferent ducts of the biliary organ terminating for the most part by several openings in the digestive stomach. In *Fishes* the gall-bladder is observed for the first time in the animal series, but it is not by any means constant in its existence. It is absent in many genera, and in these cases is frequently replaced by a dilatation upon the hepatic duct and by several efferent tubes. In the class *Reptilia* it is invariably present, and varies considerably in form, in the different genera. In serpents it is placed at the extremity or even beyond the liver, and occupies the space formed by the pyloric contraction of the stomach. The cystic duct is consequently extremely long. Among the *Chelonia* the gall-bladder is enclosed within the substance of the liver, and receives its secretion through the medium of cyst-hepatic ducts. Some of these ducts unite also with the cystic duct and constitute a *ductus communis choledochus*. In *Birds* the gall-bladder is occasionally absent, as in Pigeons, Toucans, &c. without supplying to the comparative anatomist a sufficient reason for the peculiarity; being present and absent in the same natural genera and under precisely the same circumstances of food and climate. The bile is formed from the liver by two ducts, a cyst-hepatic duct which opens into the gall-bladder, and a hepatic duct which terminates in the duodenum near to the cystic duct. When the gall-bladder is absent, both hepatic ducts terminate in the duodenum. There is no instance in the whole class of a *ductus communis choledochus*. In *Mammalia*, the gall-bladder is by no means constant; it is deficient as a general rule, to which there are several exceptions, in herbivorous animals, as in the horse, stag, elephant, peccary, tapir, whilst it is present in the ox, sheep, goat, antelope, &c. In the first giraffe examined in this country by Owen it was absent; in the next he found two. Upon the hepatic duct in the elephant, near to the duodenum, there is a remarkable dilatation. In the cat and seal the *ductus communis choledochus* is dilated in the same situation. It is not uncommon to find a double gall-bladder or two gall-bladders in the cat; in the kinkajou this is supposed to be the normal condition; and in the Museum of the Royal College of Surgeons there is a preparation, preserved by Hunter, of the liver of a small animal in which are three gall-bladders.

Throughout Invertebrata the bile is secreted from arterial blood. In *Fishes* the portal vein is formed by veins returning from the tail and occasionally from the air-bladder and genital organs. In *Reptiles* a part of the blood from the lower extremities unites with that from the alimentary canal to constitute the portal circulation. In *Birds* the portal vein also receives a part of its blood from the tail and lower extremities by means of its communication with the pelvic veins. (*Fig. 171, u, v, z*, page 338, vol. i.) Injections of the portal vein carefully conducted, as well as injections from

the internal iliac vein, have shewn that a venous communication subsists between the smaller branches of the two systems in the large intestines, even in man. In support of this communication Müller, in his *Physiology*, quotes the observations of Retzius: "Professor Retzius, of Stockholm, however, has informed me that he has discovered in man some minute communications between the veins of the intestines and the branches of the vena cava. When he injected the vena cava and vena portæ with fine injection of different colours, he found that the whole meso-colon and colon sinistrum were injected with both colours, and veins belonging to the two systems at several places formed anastomoses. The veins of the colon and meso-colon, which belonged to the system of the vena cava and entered the left renal vein, lay superficially, while those which belonged to the vena portæ lay for the most part nearer the mucous membrane. The external surface of the duodenum also had received injection from the vena cava. M. Breschet too has filled the inferior mesenteric vein from branches of the inferior cava, and Schlemm has discovered distinct communications of the inferior mesenteric vein with branches of the inferior cava about the anus." Besides these communications between the two systems occurring in the pelvis, Kiernan points to another most important communication upon the surface of the liver. "The capsular veins," he says, "are branches of the portal vein; these vessels communicate freely with branches of the phrenic veins. In some cases of atrophy of the liver, and in cases in which the circulation through the liver has been for some time obstructed, a collateral circulation is established by means of the communications which take place between the capsular branches of the hepatic artery and portal vein and those of the phrenic artery and vein." In diving animals, as in the otter and seal, in which large venous reservoirs exist upon the inferior cava, for collecting the returning blood during submersion, the hepatic veins are muscular. Kiernan observes with regard to the hepatic veins of the seal that they "differ in many respects from those of any other animal I have examined. The intralobular veins at their exit from the lobules do not as in other animals terminate immediately in the hepatic veins: these vessels enter the hepatic venous canals, where they unite into branches, which, like the vaginal branches of the portal vein, are connected by a fine cellular tissue, with which they form around the hepatic veins a cellulo-vascular sheath precisely similar to that surrounding the branches of the portal vein. The structure of the two sheaths is similar, but their uses are different. That of Glisson's capsule has been explained; the capsule of the hepatic veins in the seal appears destined to admit of the muscular contractions of these vessels." "The external coat of the hepatic veins is composed of circular fibres which in the larger vessels form a complete tunic. In the smaller vessels the fibres are arranged in the form of circular fas-

culi, which are connected with each other by oblique intermediate fibres. All the fasciculi do not extend completely round the veins; some, dividing into two portions, unite with fibres from those above and below, and form other fasciculi." "In the porpoise the hepatic veins are connected to their canals; no circular fibres are seen in their coats. Their external surface is reticulated, the ridges corresponding to the interlobular fissures, where the interlobular cellular tissue is continuous with the cellular coat of the veins. The mouth of an intra-lobular vein occupies the centre of each space circumscribed by the ridges."

The distribution of the vessels in the liver in the three great classes, Reptilia, Aves, and Mammalia, has been ascertained to be the same with that which has been so completely illustrated in the discoveries of Kiernan. In Fishes but few observations have been made, but analogy would lead us to infer that the general arrangement must be the same.

Development of the liver in the embryo.—The development of the liver in the embryo commences so early in Mammiferous animals, hurries so rapidly through its different phases, and is completed so soon, that it has hitherto been impossible to obtain any connected and precise information with regard to its progress. The observations of eminent physiologists made from time to time have, however, shewn that the mode of its development is in all respects similar to the development of the liver in the chick. Indeed, the egg of the bird is in the highest degree favourable to anatomical examination, both on account of its large size and the facility with which the incubated egg may be obtained from hour to hour, and from day to day. The principle of development therefore being the same in the ovum of the bird as in Mammifera, I shall here trace the progress of the liver in the chick according to the most recent researches of Baer.

In the embryo of the fowl at the commencement of the third day, the common vein of the body is embraced by two pyramidal cœcal pouches which communicate by their bases with the intestinal canal, and which shoot forwards so as to carry before them a fold of the vascular layer of the germinal membrane, in which they begin to ramify by giving off cœcal branches from their sides and extremities. These two cœcal tubuli with their corresponding ramifications form two flattened processes, which represent the two lateral lobes of the liver. By the end of the third day the two processes resemble folds of the vascular layer in which the tubuli are seen ramifying; they have increased in size and almost surround the vein. On the fourth day the liver has the appearance of two flattened processes which enclose the vena portæ. The hepatic tubuli have become lengthened and further removed from the intestine, and have ramified more freely in the vascular layer. By their bases the hepatic tubuli approach nearer to each other, and at the end of the fourth day they coalesce and form a common tube. On the fifth day the liver has attained considerable size; its two

lobes have become thick and appear to possess a spongy texture in their interior. The hepatic ducts are connected with the intestine by a common duct, the ductus communis choledochus; and the portal vein gives off large branches which are distributed among the ramifications of the ducts. On the sixth and seventh days the liver receives an abundance of blood and is nearly as red as the auricle of the heart. The left lobe is sensibly smaller than the right. On the eighth, ninth, and tenth days the liver has lost its great redness and presents a yellowish brown tint; the vessels have diminished in calibre, while the parenchyma has increased, and the gall-bladder has become apparent. The succeeding days augment the size of the organ, and mould it to the form which it possesses after the escape of the chick from the egg; it begins to secrete bile; and the gall-bladder assumes the pyriform shape which it retains in after-life.

In the human ovum the formation of the embryo commences visibly at about the third week of intra-uterine existence; the parietes which separate the embryo from the ovum begin to be developed, and rudiments of the intestinal canal, the liver, and the heart soon become distinctly visible. Upon its earliest appearance the liver is of large size, and between the third and the fifth week is one-half the weight of the entire body, divided into several lobes of a reddish grey colour, and receives a large proportion of blood from the omphalo-mesenteric vein. From the fifth to the eighth week the liver extends as low as the margin of the pelvis; it is soft, almost pulpy, and greyish in colour. The gall-bladder is developed in the form of a lengthened filiform cord, having an extremely minute canal through its centre. By the third lunar month the liver extends nearly to the pelvis and almost fills the abdomen, and the right lobe has increased somewhat beyond the left. The texture is more firm and of a redder colour, and the gall-bladder is long and conical. At the fourth lunar month the liver is still prolonged nearly to the margin of the pelvis, but the left lobe is evidently shorter than the right. The gall-bladder is elongated, straight, and vertical in direction, and contains a little mucus. Upon its internal surface a few rugæ begin to be perceived; it receives no bile, although a small quantity of that fluid is secreted by the liver and poured into the intestine. By the fifth lunar month the liver has acquired an increased consistence and deeper colour. It no longer descends so low as the pelvis, but appears to have diminished in bulk in proportion with the size of the abdomen. The gall-bladder assumes a more horizontal direction, and the contained mucus has a yellowish green tint. The openings of the ductus choledochus and pancreatic duct, at first placed at a considerable distance from each other, approximate and produce less projection of the mucous membrane. By the sixth lunar month the descent of the liver is still more curtailed, the fœtus increases in development from before backwards, and the organ becomes more horizontal. By the seventh lunar month

the gall-bladder contains bile, and the mucous membrane becomes rugous and reticulated. At the eighth month, and during the ninth and tenth months, the liver becomes still more horizontal in position and of a deep red colour. The bile is more abundant and of a clear green tint. At the tenth month, that is, at birth, the relative proportion of the liver to the rest of the body is as 1 to 18 or 20; the average in the adult being as 1 to 36. After birth the size and weight of the liver diminish until the end of the first year, for, according to Meckel, the liver of the newly born infant weighs one-fourth heavier than at the age of eight or ten months. The borders of the liver are rounded in the fœtus, and the inferior surface is convex. The lobes are nearly equal until birth, after which the left diminishes in size, the right remaining stationary or growing but little, and at the age of one year the left lobe is scarcely one-half so large as at birth. The texture of the liver in the fœtus is soft and fragile and apparently homogeneous in structure; during the earlier periods its colour is a light brownish grey; at about the mid-period it becomes deeply red, and after birth loses a portion of its colour from a diminution of the quantity of blood circulating through it.

Uses of the liver.—The liver performs two most important functions in the animal economy:—1, it separates from the venous blood of the chylopoietic viscera certain elements which are needful to digestion; and, 2, it de-purates the venous blood. The first of these functions constitutes the secretion of bile. The second is evinced in a comparative examination of two of the great depurating organs, the lungs and the liver, in the various classes of animals, where the latter will be constantly found in exact relation with the development of the respiratory organ, and with the necessity for the removal of a larger quantity of hydrogen and carbon from the blood. Thus, in herbivorous animals, the liver is small; it is small also in monkeys and in man. It is large, and has reached its highest development amongst Mammiferous animals in Carnivora. In birds it is larger in proportion than in Carnivora, from the greater necessity of a highly oxygenated blood in that class of animals. In Reptiles, with cold blood and a low degree of respiration, it is large; it is large also and for the same reason in Fishes; and very large amongst the Invertebrata.

Secretion of bile.—The bile, which would appear, from the existence of follicular recesses in the alimentary canal, to be produced in all animals from the lowest to the highest, is secreted in man and in vertebrata from the blood during its circulation through the lobular venous plexus in the lobules of the liver. Hence it becomes a question of importance to physiology to decide from what kind of blood it is eliminated. If, according to Kiernan, all the arterial blood of the hepatic artery become venous previously to its passage into the lobular venous plexus, *the bile must be secreted from venous blood*; that venous blood being

derived from the capillaries of the chylopoietic organs, and from the capillaries of the hepatic artery. I have given Kiernan's reasons for the belief that this is the truth; and in corroborating the results of his injections I must also add my own testimony to his view of the secretion of the biliary fluid. Müller, entertaining, as I have already shewn, a different opinion with regard to the distribution of the vessels of the liver, believes that the bile is secreted from a *mixed arterial and venous blood*, resulting from the termination of both the hepatic artery and portal vein in the "vascula ultima reticulata," or lobular venous plexus. From the undecided manner in which he expresses this opinion, I am tempted to give the quotation in which it is contained, that my readers may judge how far he be really in earnest in his assertion. "It is known that injection thrown either into the hepatic artery or into the portal vein, fills the same capillary net-work, from which, on the other hand, the hepatic veins likewise arise."

Since reading the above paragraph I have injected twelve livers for the purpose of deciding the question, in my own mind, of the ultimate termination of the hepatic artery; but I have in no instance succeeded in forcing injection into the lobular venous plexus, although every other part of the organ has been beautifully injected. I have therefore been forced to the conclusion that some mistake must exist with regard to this passage, and that, although perfectly true when confined to the portal vein, Müller cannot mean that the capillary network (lobular venous plexus) from which the hepatic veins arise, is actually filled from the *hepatic artery*. But he continues, "It appears, therefore, that the arterial blood of the hepatic artery, and the venous blood of the porta, become mixed in the minute vessels of the liver, and that the secretion of bile *probably* takes place from both." Now, with deference to Müller's judgment, the question, with our present knowledge upon the exact anatomy of the liver, ought not to be one of probability or surmise;—does it? or does it not? But he appears far from satisfied, in relying for the support of his argument upon his own peculiar theory of the arrangement of the hepatic vessels, and, as if distrusting its efficiency, he exclaims in another page of his Physiology, "But the possibility of bile being secreted from arterial blood is demonstrated by the cases in which the vena portæ enters the vena cava directly instead of being distributed through the liver. Mr. Abernethy observed this anomalous structure in a male child ten months old; and Mr. Lawrence has detailed a case in which the same malformation existed in a child several years of age. In Mr. Abernethy's case however the umbilical vein was still pervious and branched out in the substance of the liver; it is possible therefore, as Mr. Kiernan remarks, that the arterial blood, after having nourished the liver, was poured into the branches of the umbilical vein, just as it is in the normal condition, according to his opinion, poured into

branches of the portal vein, and the secretion of bile therefore might still have been derived from venous blood."

"M. Simon and Mr. B. Phillipps have inferred from experiments which they performed, that the bile is secreted from the blood of the portal vein. But Mr. Phillipps found that after the vena portæ had been tied the secretion of the bile still continued, though in diminished quantity; and he concludes, therefore, that it is formed both from arterial and venous blood. He perceived no change in the biliary secretion when the hepatic artery was tied."

The cases recorded by Wilson, Abernethy, and Lawrence are interesting, but they do not appear to me to affect in the slightest degree the arguments on either side of the present question. It is true that it might be asserted in behalf of Müller's opinion, that the blood sent to and circulating in the liver was arterial, and that from this alone bile was secreted, for in both cases bile was found in the gall-bladder, while the vena porta emptied itself into the vena cava. On the other hand it was ascertained by Kiernan in the only one of the three cases in which the liver was preserved, that the umbilical vein (hepatic portal) was pervious, of considerable size, and ramified as usual through the portal canals and terminated as usual in the lobular venous plexus. Now, although the hepatic portal vein (umbilical) did not obtain its accustomed supply of blood after the placental circulation was arrested, from the abdominal portal vein, yet there is no reason for supposing that it did not collect the venous blood from the capillaries of the arteries supplying the coats of the excretory ducts and other vessels. Again, the transmission of the remaining portion of the arterial circulation through the vaginal, the interlobular, and lobular arteries must have seriously affected its arterial character if it have not indeed altogether converted it into venous blood. Although Mayo, who took part in the examination of this liver, observed upon this point that "it cannot be supposed that the arterial blood, in its passage through the vasa vasorum into the branches of the umbilical (hepatic portal) vein underwent the usual change into venous blood; and it was still, he contended, arterial blood, though less pure in character, which was conveyed through venous canals into the secreting part of the liver."

Now it may be fairly presumed that blood which is not arterial must be venous; but it must at the same time be admitted that the normal degrees of arterialisation are various in individuals, and different in different regions of the body at the same moment; so that no satisfactory argument can be sustained upon an assumption of the sub-arterial character of the blood. I would rather suggest another train of reasoning. The abdominal portal vein returning blood possessed of peculiar properties from the chylopoietic viscera terminates in a rare anomaly in the inferior cava, so that the portal blood is mingled with the general venous current of the system. The lungs receiving

this blood exert their appropriate influence in separating from it a portion of the noxious elements with which it is combined; but it cannot be supposed that this blood will return to the heart as pure in character as that which has circulated in the usual way through the other depurating organ, the liver. No; it still contains the elements from which bile may be secreted, and a larger portion than usual is therefore sent to the liver, that this secretion may be eliminated. Hence we cannot treat the blood thus flowing into the liver from the aorta in a much larger current than natural ("in ordinary cases one principal artery is found in each canal; in this case two, and in some places three arteries of equal calibre were found in each canal") as mere arterial blood destined for nutrition alone; but we must regard it as a fluid bearing in its course the elements of the bile; and therefore, whether it be poured through the capillary channels of the lobular venous plexus, or through those of its own developing in the substance of the lobules, it is nevertheless an abnormal influence which cannot be tested by man's decision, but is part of the compensating principle so admirably displayed by nature in all her operations.

With regard to the evidence of experimental operations upon living animals, this must at all times be unsatisfactory and inconclusive from the difficulty of observing and appreciating the consequences of the experiment, and from the morbid condition impressed upon the animal by the serious nature of the operations themselves. Those which have been performed are favourable to the conclusion that the bile is separated from the blood of the portal vein. But I have little faith in such experiments;—after the ligature of the portal vein, the animal lives but a short period; the blood arrested in its current is conveyed through the medium of inoculations into the general venous circulation, and then, as I have above suggested, if the animal survive sufficiently long, the bile may be secreted from the fluid which contains it, viz. from the arterial blood.

Cuvier entertains the opinion, that the bile is secreted from venous blood, as may be perceived in the following passages:—"Le foie des animaux vertébrés a en effet un caractère qu'il ne partage avec aucune autre glande; c'est que sa sécrétion est alimentée par du sang veineux; par du sang qui a déjà circulé, et qui n'est pas retourné au cœur, ni par conséquent au poulmon. Cette circonstance a lieu, non-seulement dans des animaux à circulation double, où tout le sang doit repasser par le poulmon, avant de se rendre aux parties, le foie excepté; mais encore dans les animaux à circulation simple (les reptiles), où une si grande portion du sang artériel n'a point retourné au poulmon, et tient par conséquent de la nature veineuse; c'est presque alors du sang deux fois veineux qui se rend dans le foie." May we not, therefore, from the powerful arguments afforded by anatomical investigation, and from our knowledge of the compensating energies aroused by nature in cases of anomaly,—may we not, at least until weightier reasons to the contrary shall be

developed by the progressive discoveries of our improving science, conclude that *the bile is secreted from venous blood?*

The *quantity of the bile* is a question difficult to decide accurately; it would appear to be secreted most abundantly during digestion, when the augmented activity of the stomach would seem to be communicated to its neighbouring organ, the liver. Certainly it is evacuated from the gall-bladder into the digestive canal at that period. In animals which have been kept long fasting the gall-bladder is always greatly distended. Schultz observed, in an ox which had been kept for some time without food, from twelve to sixteen ounces of bile in the gall-bladder, and in another, after digestion, from two to four ounces only. In a dog which had not eaten for some time he found five drachms, in another, after digestion, about two drachms. In a case of abscess of the liver communicating with the gall-bladder and lung, recorded by Dr. Monro, the whole of the bile flowed through the fistulous canal and was discharged by coughing, "in proof of which," he says, "the fæces were of the same whitish colour and had a little smell as those of a person deeply jaundiced. The quantity of bile discharged by coughing was different at different times. It was *always greater after meals*, and especially for an hour or two after dinner. The quantity expectorated could not be measured with great accuracy from being mixed with mucus and saliva. The whole quantity in twenty-four hours was from ten to fifteen ounces; and, in this case, I had an opportunity of observing the effects of certain articles of food, and in particular of acids, of wine, and of different fruits, in increasing the quantity of bile."

Expulsion of the bile.—This process I have just shewn takes place more abundantly during digestion than at any other period. In all carnivorous and in most herbivorous animals there exists a peculiar provision for the collection of the bile during the period of abstinence, in a membranous reservoir, the gall-bladder. Some herbivorous animals, deprived of a distinct gall-bladder, have a compensating dilatation upon the hepatic duct. The use of this organ is to retain the bile until digestion demands its excretion. Those animals, therefore, that are provided with it are such as perform the function of digestion at variable intervals. But in those whose digestion is continuous, as is the case in many herbivora, the bile flows as it is secreted into the alimentary canal; being very probably provided more abundantly under the stimulus of a full stomach than during the abstinence from food or during sleep. In the contracted state of the duodenum the small and oblique opening of the ductus communis choledochus is closed to the passage of the fluid; it therefore regurgitates along the cystic duct into the gall-bladder. In the slight ascent along this tube it is facilitated by the spiral valve, which also serves to restrain its too sudden emission during spasmodic action of the abdominal muscles. As soon as the duodenum becomes filled with the chyme from the stomach, the opening of the ductus

communis choledochus is less compressed. The distension of the stomach, but more particularly the passage of the chyme along the pylorus into the upper part of the duodenum, causes a gentle pressure upon the coats of the gall-bladder which favours its emission; its contents are gradually expressed, and flowing along the ductus communis choledochus are mingled with the pulpy mass in the duodenum. This explanation of the process seems to have been entertained by Haller, and to have arisen in his mind from the consideration of the anatomy of the serpent, where the gall-bladder is far removed from the liver and is situated in the space formed by the contraction of the pylorus and its termination in the small intestine. Neither do I consider its truth invalidated by those cases in which the gall-bladder is partly imbedded in the liver, for in such instances that portion of the liver is compressed which immediately covers the fundus of the gall-bladder, or a part of the gall-bladder is exposed against which the duodenum may exert an equal compression. Müller conceives that the efferent ducts of glands are surrounded by "an extremely thin layer of muscular substance," which, although not demonstrable anatomically, he thinks to be placed beyond dispute by physiological observations. "The contractile power of the ductus choledochus in birds was known to Rudolphi. By irritating mechanically or by galvanism the ductus choledochus of a bird just dead, I have frequently produced a very strong contraction of it, which continued some minutes, after which the duct resumed its previous state. I have often excited strong local contractions of the ureters likewise, both in birds and rabbits, by the application of a powerful galvanic stimulus. Tiedemann also has seen motions of the vas deferens of a horse ensue on the application of a stimulus. It appears indeed that periodic vermicular motions are performed by the efferent ducts, at least by the ductus choledochus, in birds; for I have once observed in a bird just killed, contractions of the duct occurring regularly in pauses of several minutes, the tube dilating again in the intervals; and what was remarkable, the contractions took place in an ascending direction, namely, from the intestine towards the liver: and this seems to throw some light on the mode in which the bile at certain times, instead of being expelled into the intestines, is retained and driven into the diverticulum of the duct, namely, the gall-bladder; the complete closure of the mouth of the duct contributes perhaps to this effect. The discharge of the bile from the gall-bladder during digestion results probably from the mere pressure of the surrounding parts, and the action of the abdominal muscles, while the mouth of the duct is open: for I doubt if the gall-bladder is contractile; I could produce no contraction of it in mammalia and birds even with the most powerful stimulus of a galvanic battery." Dr. Monro considers the middle coat of the gall-bladder in man to contain muscular fibres; the muscular coat in the gall-ducts of the dog and horse are, he observes, quite distinct, and upon irritation he has seen the gall-bladder contract

in a living animal so as to resemble an hour-glass. Andral thinks that he has perceived muscular fibres in the hypertrophied coats of the gall-bladder, and Ferrus records a case as occurring to Amussat where, in obstruction to the ductus choledochus by a gall-stone, the middle coat of the gall-bladder and ducts above the impediment was evidently muscular. This preparation was seen by Kiernan at the time that it occurred. The bile during its stay in the gall-bladder becomes inspissated by the removal of the fluid part of the secretion, which is most probably taken up by the numerous lymphatics which cover its surface.

The *uses of the bile* are threefold; 1. it acts chemically upon the chyme and produces the separation of the chyle; 2. it combines with the residuum and forms the *faecal matter*; 3. it stimulates the mucous surface of the canal and promotes its secretion, and the contractile action of the muscular coat.

Red and yellow substances of Ferrein.—Since the period when anatomists were divided in their considerations of the liver by the two great contending opinions of Malpighi and Ruysch, the former maintaining its composition of glands, and the latter of minute vessels, the majority of observers have adopted the views proposed by Ferrein, who was the first to vindicate the existence of two distinct substances, which he named cortical and medullary. It was reserved for Kiernan in our own day to prove that “the structure of all the lobules is similar;” that “each lobule is the same throughout;” that “one part of a lobule is not more vascular than another;” and that “there is, therefore, no distinction of red and yellow substances in the liver; the red colour results from congestion only.” This doctrine being now established as an undisputed truth, it is not surprising to observe that anatomists and pathologists differed in opinion with regard to the relative position and appearance which these two imaginary substances occupied in the respective livers which they chanced to examine, and upon which they established their decision. Thus we find that Ferrein described the medullary substance as being red in colour, and of a pulpy consistence, and the cortical as friable in its structure, and of a yellowish red colour. Autenrieth, on the contrary, found the red substance to be cortical and the yellow medullary. Mappes having obtained a liver in a different state of congestion, conceives that the yellow substance might be named *granulated*; he describes it as forming convolutions, one while like intestines, and another while branched, flat, or rounded; and the spaces between the convolutions as being rounded, or resembling oblong fissures filled with a brownish and loose substance. Meckel coincides with Mappes in the relative position of these parts; they are not, he says, placed as in the brain, one on the exterior, the other in the interior, but they alternate throughout the entire organ, the yellow substance forming the mass of the liver, and the brown filling the interspaces. Rudolphi objects to the terms medullary and

cortical. Bouillaud asserts that the yellow substance presents itself in the form of granulations having the figure, colour, and arrangement of the secreting granules of the bile known, as he remarks, under the name of acini. These granules, he says, are surrounded by the brown substance, which therefore assumes an angular appearance; it is composed of a vascular network, and may be compared to erectile tissue. Andral, in his *Anatomie Pathologique*, says, “Lorsqu’on examine avec quelque soin un certain nombre de foies, l’on y reconnaît l’existence de deux substances: l’une rougeâtre, où se ramifie surtout le système capillaire de l’organe; l’autre blanche ou jaunâtre, qui semble surtout destinée à l’accomplissement de la sécrétion biliaire. Dans l’état normal ces deux substances sont distinctes.” The opinion of Ferrein is opposed by Portal and Cruveilhier: the former anatomist, after reproving certain modern authors who wished to combine the views of Malpighi and Ruysch by admitting that the liver was formed both of glands and of a prodigious number of vessels, contents himself by asserting that Ferrein’s idea of the composition of the glands of the liver of two substances was gratuitous. To Cruveilhier the distinction of two substances appears ill founded, for he observes that the two colours when they exist, which is not constantly the case, do not belong to two distinct granulations, but to one and the same, which is yellowish in the centre where the bile predominates, and of a brownish red in the circumference where the blood is situated. Kiernan ranks Müller among the authors who entertain an opposite opinion to that of Ferrein, but I find upon referring to his work upon the glands, that he distinctly admits a kind of double substance although he objects to its designation, medullary and cortical; hence he observes:—“*Diversam substantiam hepatis, utpote medullarem et corticalem, quæ per hepar totum undique obveniunt, qualem Autenrieth, Bichat, Cloquet, Mappes, atque etiam J. Fr. Meckel admittunt, eadem neque in historia evolutionis amphibiorum et avium, neque in hepate adutorum microscopice observato conspexi. Historia evolutionis hanc questionem evidentissime illustrat. Systema nimirum ductuum biliferorum in embryone amphibiorum et avium liberis finibus in superficie hepatis prominulis conspicuum. Sarmentula illa foliatum et paniculatim divaricata, colore e gilvo candido nitent, magnopere ab interstitiis sanguinolentis distincta. Hinc sane duplicis substantiæ species exoritur, quoniam circum ductuum biliferorum a tela conjunctiva expleantur, quæ ex subtilissimis fere conata vasculorum sanguiferorum retibus, in quibus arteriæ et venulæ adhehentes in revehentes venas transeunt. Atque hæc sola est utriusque substantiæ notio. Sed in omnibus organis glandulosis fere idem obvenit.*” In his *Physiology* he is disposed to modify his previous idea of two substances, for he says, “From my researches, however, it results that there is but one kind of *real* hepatic substance, formed of agglomerated biliary canals; but the ramified divisions of this sub-

tance being connected by a *vascular cellular tissue*, which is often of a dark colour, a contrast between this and the yellow substance of the acini is produced. A similar relation of the constituent parts of the liver exists in the embryo of the bird; in it the yellowish twig-like ramifications of the biliary canals are seen on the surface of the organ rising out of a reddish vascular tissue."

M. Dujardin, in an article entitled, "*Recherches Anatomiques et Microscopiques sur le Foie des Mammiferes*,"* has advanced some opinions which he conceives will throw a doubt over the labours of Kiernan. My space will not permit an analysis of his paper, but it will be obvious to all who may be disposed to read it, that he has not advanced a single new fact, but on the contrary has confessed the most imperfect and inadequate means of examination. Thus, he observes, "with an injection sufficiently fine we can inject the portal vein as far as the capillaries which surround the lobules." Therefore, according to him, the interlobular veins are capillaries, and we need not wonder that with such injection he gets no further, but denies the existence of vessels in the lobules altogether. The lobules, he says, are composed of glutinous corpuscles or globules, which leave channels between them, through which the corpuscles of the blood pass without alteration; at the same time by an action analogous to the phenomena of absorption and assimilation in the lower animals, these lobules separate from the serum the excrementitious particles which are excreted upon the surface of the lobule. The blood of the portal vein is transmitted through the lobule by a kind of "*filtration organique*," and from it the resinous matters of the bile are eliminated; the arteries, on the contrary, secrete the alkaline substances, which in the first instance dissolve the resinous substance, and afterwards constitute the true agents of digestion. M. Dujardin concludes his theoretical but ingenious speculations with an excuse for being obliged to give them to the world in their present imperfect state, and promises to renew his researches with perseverance. I feel pleasure in recording his promise, and have no doubt that by better directed injections in the human liver, using size and vermilion in place of oils and varnish, he will be induced to modify his views with regard to this most interesting organ.

PATHOLOGICAL ANATOMY OF THE LIVER.—

If we consult the works of pathological writers upon this subject, we shall observe at every step of our progress the greatest ambiguity and difference of opinion to exist. The reasons for this want of consent upon the true nature of the diseases of so important an organ are not to be ascribed either to want of talented observers or of excellent observations, but solely to the ignorance which has hitherto prevailed with regard to the exact anatomy of the organ. I have shewn that the most celebrated authors found it necessary in starting with their in-

quiries to establish for their guidance a theory of the structure of the liver; this theory was based upon imagination or upon deceptive appearances; and upon this frail basis the crumbling superstructure of their pathological deductions is supported. The hypertrophy or atrophy of the white or of the red substance, and the wild speculations of pathological theorists, have now fallen into the shade before the light which recent discoveries have thrown upon the anatomy of the liver. Intimately associated with that anatomy, and with the knowledge of the distribution of the vessels, is the explanation of the mode in which the circulation is performed, and the elucidation of the causes which may give rise to impediment in its course; in other words, the principles of congestion. Indeed, so closely allied is that condition with the natural circulation, that Kiernan, in his paper upon the Anatomy and Physiology of the Liver, has deemed it a part of the subject to explain the various congestions to which the organ is liable, and the manner in which they may be imitated artificially. Upon this point we have, therefore, precise information, and the history of congestion we may regard with a feeling of satisfaction. The same observations, with the exact anatomy of the liver as a basis, have not as yet been extended to its diseases; our knowledge of these is therefore necessarily imperfect. Kiernan concludes his paper with a paragraph of much importance to this branch of pathology:—"While engaged in the examination of the natural structure of the liver, I have not been inattentive to the changes produced in it by disease; and, with the permission of the Society, I propose submitting to its consideration a paper on the morbid anatomy of this organ." Now this was written in 1838, and I trust that the time is not far distant when the additional labours of that excellent observer will be placed in the hands of the profession.

In the arrangement of the diseases of the liver I have adopted a physiological order, and shall consider its morbid conditions under the seven following heads:—

1. Diseases of the serous membrane.
2. Diseases of the mucous membrane.
3. Disorders of the venous circulation.
4. Disorders of biliary excretion.
5. Diseases of the parenchyma.
6. Disorders of function.
7. Entozoa.

1. *Diseases of the serous membrane.*—The serous covering of the liver, like serous membranes in other parts of the body, is liable to *acute inflammation*. The effects of this inflammation are also similar; the capillary vessels become over-distended and lose their power of contraction; coagulable lymph is effused upon the surface of the organ, and causes its mechanical cohesion to the contiguous serous membrane; the coagulable lymph becomes organised by the development of new capillary vessels from the meshes of the old, and the adhesions are traversed by vessels of larger size, and constitute a permanent bond of

* *Annales Françaises et Etrangères d'Anatomie et Physiologie*, 1838.

union between the peritoneum proprium and the peritoneum reflexum. In this state, adhesions are not uncommonly met with upon the convex surface of the liver, but not so frequently upon its concave side. The inflammatory action is confined to the peritoneum of the organ itself, and that of the parietes of the abdomen immediately in contact with it, and seldom extends to the serous membrane of neighbouring viscera. This is the *membranous hepatitis* of pathological writers, and is accompanied by considerable local uneasiness, and by sympathetic pains in various parts of the body, dependent upon the communication of its proper nerves with the nerves of other regions, as with the phrenic nerve, giving rise to pain in the right shoulder and chest, with cough; with the pneumogastric nerve, producing uneasiness at the cardia, pain along the œsophagus, dysphagia and nausea; and with the solar plexus and lesser splanchnic nerve, causing pain in the right kidney, &c. This disease is usually associated with chronic congestion of the substance of the liver, but exists, sometimes, quite independently of any internal morbid action.

As a consequence of *chronic inflammation*, the serous membrane is sometimes thickened and opaque and dense in its consistence; at other times it is less resisting than natural and easily broken.

Depositions are occasionally found in the subserous tissue of the liver as a result of chronic inflammation of the serous membrane. They consist most frequently of an atheromatous substance, and occasionally of thin plates, having a cartilaginous density and appearance. The gall-bladder is not unfrequently thickened in its coats by the deposition of fat, of tuberculous, or of calcareous substance. The latter has been described as ossified gall-bladder.

2. *Diseases of the mucous membrane.*—Inflammation of the mucous membrane of the liver is acute or chronic, and is more frequent than that occurring in the serous membrane. Being continuous with the mucous membrane of the duodenum, the lining of the biliary ducts and gall-bladder is constantly subject to sources of irritation from disorders of digestion, improper aliment, and stimulating substances taken into the alimentary canal, or from any cause giving rise to undue action in the intestinal mucous surface. Almost all the chronic diseases of the liver are to be referred to this prolific source, and it is also by means of this direct continuity that many of the therapeutic remedies exert their alterative influence. The effects of inflammation on the mucous membrane, are

- a. Thickening.
- b. Softening.
- c. Hæmorrhage.
- d. Suppuration.
- e. Deposition.

a. *Thickening* of the submucous tissue is the most frequent consequence of irritation of the mucous membrane; the calibre of the ducts is in this way diminished; actual stricture and

obliteration of the tubes occurs, and the bile, at first but partially impeded, becomes altogether obstructed. The gall-bladder is sometimes enormously thickened, particularly where the irritation is kept up by the presence of several or a single large gall-stone. The coats are usually very much condensed and contracted, and their structure appears lost; occasionally they are dilated. In a case which occurred to Amussat,* wherein the ductus communis choledochus was obliterated, and the gall-bladder and ducts were very much distended, the middle coat presented all the characters of muscular fibres.

b. *Softening* of the mucous membrane may occur in the biliary ducts, but more particularly in the gall-bladder, and from the same causes which produce it in other mucous surfaces. I have seen two instances in the gall-bladder in which patches of the surface were converted into a softened pulp, which gave way upon the distension of the sac with air.

c. *Hæmorrhage.*—The gall-bladder has been observed filled with blood, having its source in the capillaries of the mucous membrane. In these cases intestinal hæmorrhage had occurred before death, and upon examination, no congestion or lesion could be found in the mucous membrane other than that which was seen in the gall-bladder.

d. *Pus* has likewise been found in the gall-bladder, and in the larger hepatic ducts, sometimes pure, but generally mingled with the bile.

e. *Abnormal deposits* in the submucous cellular tissue are occasionally seen. They are most frequent in the gall-bladder, and consist generally of calcareous accretions.

3. *Disorders of the venous circulation.*—Under this head I have to describe the various forms of congestion of the liver. It has been customary hitherto to consider hepatic congestion as a pathological condition, and in compliance with that custom I have given it a place under the above title, although I shall have occasion to shew that it is not in itself a disease, but the mere result of diseased actions occurring in other parts, and wholly dependent upon the peculiar anatomical structure of the organ. Andral, in his excellent work on pathological anatomy, observes, “L’hyperémie du foie est un des états morbides que présente le plus fréquemment cet organe. Tantôt cette hyperémie est générale, alors le foie est partout d’un rouge uniforme; son volume est augmenté et sa consistance peu changée, lorsque l’hyperémie est simple. Cette hyperémie est souvent partielle; alors, en un certain nombre de points, on trouve comme des taches rouges variables en forme et en grandeur, qu’entoure un parenchyme plus pâle.

“Trois espèces d’hyperémie du foie doivent être admises, relativement aux conditions de l’économie dans lesquelles elles surviennent.

“Une première espèce d’hyperémie est celle

* Dictionnaire de Médecine, article Foie. Mr. Kiernan was the pupil of Amussat at this period, and saw this interesting case. He informs me that the appearance was distinctly muscular.

qui résulte d'un travail d'irritation dont le foie est devenu le siège. Cette irritation est tantôt idiopathique, et tantôt elle est la suite d'une irritation primitivement fixée sur le tube digestif.

"Une seconde espèce d'hyperémie, dont le foie me paraît susceptible, est celle dans laquelle le sang s'accumule d'une manière toute passive au sein du parenchyme hépatique, comme il s'accumule dans les gencives des scorbutiques.

"Enfin le troisième espèce d'hyperémie du foie est purement mécanique; elle s'observe dans les cas où un obstacle quelconque s'oppose à la libre entrée du sang dans les cavités droites du cœur; le sang stagne alors dans les veines sous-hépatiques, et *engorge* le foie."

Now the researches of Kiernan have proved that "in consequence of its double circulation, the liver is naturally in a state of sanguineous congestion" after death, and that author has also pointed out the various forms of congestion which are observed in the organ. "Sanguineous congestion of the liver," he observes, "is either general or partial."

a. *General congestion* affects the whole of the substance of the liver, which presents a generally diffused red colour; the central portions of the lobules having usually a deeper hue than the marginal portions.

Partial congestion is of two kinds,

Hepatic venous congestion.

Portal venous congestion.

b. *Hepatic venous congestion* may exist in two stages. "In the first and most common stage (*fig. 42*) the hepatic veins, their intralobular branches, and the central portions of the lobular venous plexuses are congested. The congested substance is in small isolated patches of a red colour, and occupying the centres of the lobules is medullary; the non-congested substance is of a yellowish white, yellow, or greenish colour, according to the quantity and quality of the bile it contains; it is continuous throughout the liver, and forming the marginal portions of the lobules is cortical."

Fig. 42.

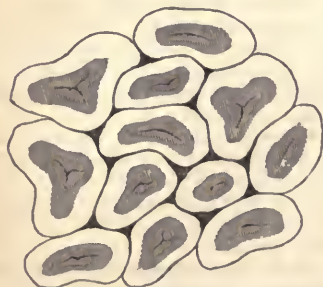

Rounded lobules in the first stage of hepatic venous congestion, as seen upon the surface of the liver. After Kiernan.

"This is the usual and natural state of the organ after death," and arises from arrest in the circulation of the hepatic veins, while the cur-

rent of blood in the minute branches of the portal vein is still in motion.

"In the second stage (*fig. 43*) the congestion extends through the lobular venous plexuses to those branches of the portal vein situated in the interlobular fissures, but not to those in the spaces, which being larger there and giving origin to those in the fissures, are the last to be congested; when these vessels contain blood the congestion is general, and the whole liver is red. In this second stage the non-congested substance appears in isolated circular and ramous patches, in the centres of which the spaces

Fig. 43.

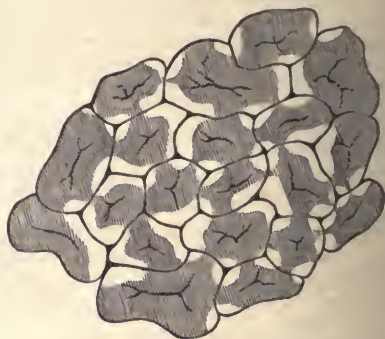

Lobules in the second stage of hepatic venous congestion, as seen on the surface of the liver. The dark centres of the preceding stage have become conjoined at the interlobular fissures, while the uncongested parts encircle an intralobular space.

and fissures are seen. This form of congestion "very commonly attends disease of the heart and acute-disease of the lungs or pleuræ; the liver is larger than usual in consequence of the quantity of blood it contains, and is frequently at the same time in a state of biliary congestion, which probably arises from the sanguineous congestion. Although in the first stage the central portions of the plexuses, and in the second the greater portion of each plexus, and those branches of the portal vein occupying the fissures are congested, and although the plexuses are formed by the portal vein, yet as this form of congestion commences in the hepatic veins and extends towards the portal vein, and as it is necessary to distinguish this form from that commencing in the portal vein, the term of hepatic-venous congestion will not probably be deemed inapplicable to it." The second stage of hepatic venous congestion, generally combined with biliary congestion, gives rise to those various appearances which are called *drain-drinkers'* or *nutmeg liver*.

c. "Portal venous congestion is of very rare occurrence; I have seen it in children only. In this form, the congested substance never assumes the deep red colour which characterises hepatic-venous congestion; the interlobular fissures and spaces and the marginal portions of the lobules are of a deeper colour than usual; the congested substance is continuous and cortical, the non-congested substance being me-

Fig. 44.

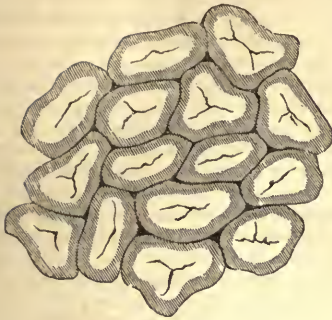

Lobules in a state of portal venous congestion, as seen on the surface of the liver. The congested part occupies the margins of the lobules, the uncongested portion their centres. After Kiernan.

dullary and occupying the centres of the lobules."

The causes of congestion are all such as tend to interfere with the circulation in the liver or with the general circulation; for instance, impediment to the circulation of the blood through the capillaries of the lungs, diseases of the valves of the heart, aneurism, &c. A slighter degree of obstacle produces congestion of the hepatic veins only, the venous turgescence being limited by the lobular venous plexus. If the obstruction be greater, the lobular venous plexus itself is congested; if the cause continue, the congestion extends through the interlobular fissures into the neighbouring lobules, and in a more advanced degree the congestion spreads itself throughout the whole of the lobules, and becomes general. From the liver the congestion extends to the alimentary canal, and gives rise to intestinal hæmorrhages, hæmorrhoids, ascites, &c.

The variety of appearance in the vascularity of the lobules in congestion, and the constancy of its occurrence, have deceived those pathologists who maintain the existence of two substances, and the difference of position and form of the congested and uncongested portions has given cause for the diversity of opinion with regard to its situation. For a perfect elucidation of these difficulties, physiology is indebted to the genius and perseverance of Kiernan. The mode in which the attention of this author was drawn to the subject forms part of the history of hepatic congestion, and deserves to be detailed in his own words. "My attention," he observes, "was first directed to the anatomy of the liver by the study of the admirable works of M. Andral. In the first organs I examined I found the small branches of the hepatic veins ramifying exclusively in the red, and those of the portal vein in the yellow substance. I concluded that the liver was composed of two venous trees, a portal and an hepatic tree, the former having a cortex of yellow, the latter of red substance; and with M. Bouillaud, I thought it probable that the red substance was the organ

of the function imagined by Bichat. I next ascertained the lobular structure, and concluded with Ferrein, that the red substance was medullary and the yellow cortical. Subsequent dissections, in which I found branches of both the portal and hepatic veins ramifying in the red substance, tended to unsettle the opinions I had formed respecting the anatomy and physiology of the two substances, and these opinions were finally overturned by the examination of a liver in which I found the branches of the portal vein alone ramifying in the red, and those of the hepatic veins in the yellow substance. The only conclusion that could be drawn was, that the red colour resulted from congestion; that it was medullary, occupying the centre of each lobule, when the hepatic, and cortical forming the circumference, when the portal vein was congested."

Müller, in the eleventh figure of plate 11 of his admirable work on the glands, has made a singular error with regard to the structure of the liver, and the arrangement of the ultimate biliary ducts. In the description of this figure he says, "Segmentum hepatis Sciuri junioris, microscopio simplici visum. Observantur fines ductuum biliferorum elongati, seu cylindri-

Fig. 45.

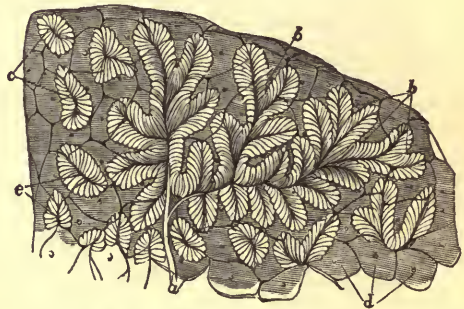

A part of Müller's 11th figure of plate 11, which he considers to represent the distribution and arrangement of the ultimate biliary ducts. The liver in this section is in a state of hepatic venous congestion in the second stage. The congested portion corresponds generally with the central or hepatic part of the lobules, and the uncongested portion with the interlobular fissures, in which are situated the branches of the portal vein.

a, A small branch of the portal vein giving off twigs to the various interlobular spaces. If these twigs be continued so as to unite with each other, the form of the lobules will be apparent; as at b, b. The angles formed by the giving off of the twigs from the portal vein are the interlobular spaces. c, Irregularly oval patches of uncongested lobules; the dark spot in the centre is an interlobular space, from which the portal vein radiates in various directions, so as to surround the various lobules by whose conjunction the space is formed. d, d, Lobules entirely congested. In the centre of the lobules of this section I have marked the situation of the intralobular vein, although it may not be apparent, or but slightly so, in the congested liver. The small spaces, e, e, generally mistaken for intralobular veins in this form of congested liver, are interlobular spaces.

formes acini, in figuris ramosis et foliatis variè dispositis." Now the truth is, that this section is in the second stage of hepatic venous congestion, and the "figuris ramosis et foliatis" are simply the uncongested portions of the lobules, of a lighter colour than the rest, and presenting the foliated and ramos appearance which is common to this form of congestion. The "fines ductuum biliferorum elongati seu cylindriciformes acini" are obviously imaginary. The dark lines in the centre of the foliated ramifications are small branches of the portal vein lodged in interlobular fissures. If the twigs given off by these branches be made to unite with each other, we shall then have the true form of the lobules. This has been done in *fig. 45*, upon a part of Müller's drawing, for the purpose of shewing how the error has arisen, and how the form of the lobules may be restored. This appearance of the congested liver is by no means unfrequent in occurrence, and I subjoin a careful and accurate drawing of a similar arrangement in the human liver, (*fig. 46*), for the purpose of comparison with that of Müller.

Fig. 46.



Section of a portion of liver exhibiting hepatic venous congestion in the second stage, carefully delineated from nature by Bagg, and intended to be compared with Müller's figure.

a, The portal vein in an interlobular fissure, giving off small twigs to adjoining fissures, and surrounded by the uncongested portion of the liver. *b*, The form of a few of the lobules is shewn. *c*, Irregular patches of uncongested liver, as in Müller's figure; the space in the centre of each being an interlobular space. *d*, Interlobular spaces. *e*, The congested portion of the liver.

Coming from so high an authority as Müller, this figure has been copied without hesitation by several writers, together with the explanation given of it by the author. Mr. Grainger has introduced it into his article upon the glands in this *Cyclopædia*, *fig. 217*, page 485, and Mr. Carpenter has also given it a place in his recent excellent work* on physiology. In his text,

the latter gentleman observes with regard to the figure:—"In the squirrel indeed these prolongations may be distinctly seen, the blind sacs being cylindrical in form, and closely packed together."

Hepatic venous congestion in its most common form, viz., in the second stage, is the great stumbling-block of all anatomists who have engaged in the investigation of the minute anatomy of the liver; and it is under this head that I must now consider the views of Cruveilhier with regard to the supposed normal anatomy of this organ. Isolated from the distribution of the vessels in the liver, he has described the form and arrangement of the lobules with sufficient accuracy; but then it must be remembered that his description was written subsequently to the publication of the researches of Kiernan. But his conception of the structure of the lobules is completely erroneous, for after combating the common error of the existence of two distinct substances, he says:—"Les deux couleurs jaune et brune quand elles existent, n'appartiennent pas à deux granulations distinctes, mais bien à la même granulation qui est jaune au centre, où se trouve le bile, et rouge-brun à la circonférence, où se trouve le sang." Now Kiernan has distinctly proved that the structure of the lobules is the same throughout, and their colour is also uniform. Cruveilhier must therefore have founded his opinion and his description upon a liver in the second stage of hepatic congestion, in which there exists a delusive indication of lobules having the appearance of small oval and variously shaped patches, of a yellowish colour, situated at regular intervals, and surrounded by a reddish brown substance. These yellowish spots are seen in *figs. 43, 45 & 46*. They are the clusters of terminal biliary ducts of Müller,—the central portions of the lobules of the liver of Cruveilhier; but if they be examined carefully, their true nature will become clearly apparent. They are actually the uncongested portions of the lobules of a liver in the second stage, and have each an interlobular space for a centre. In the next passage Cruveilhier observes:—"Le foie humain, excepté dans les cas de développement considérable des granulations, se prête difficilement à leur étude vu leur petitesse." Here again in the words "développement considérable," we perceive an idea founded upon the same erroneous impression with regard to the structure of the lobules. The real lobules are as nearly as possible of the same size in the liver of every individual, but these imaginary lobules of Cruveilhier, having uncongested portions of the hepatic substance for centres, necessarily vary in size and form with the degree of congestion, and hence have given rise to the idea of an increased development of the lobules. Again, the true lobules are not so small in the human liver as to render their examination difficult; they may be seen distinctly with the naked eye, and with the commonest lens may be examined accurately. But in the congested

* Principles of General and Comparative Physiology, 1839.

state of the organ they are more obscure, as may easily be inferred when we perceive such distinguished authorities as Müller and Cruveilhier, from want of making the liver the subject of especial investigation, deceived by such appearances. That Cruveilhier has actually mistaken the uncongested patches seen on the surface of a congested liver for the lobules, is clearly proved by a succeeding paragraph:—"Du reste, le volume des grains glanduleux présente beaucoup de variétés suivant les individus, et ce volume est tout-à-fait indépendant du volume du foie lui-même. Les médecins qui s'occupent d'anatomie pathologique ont souvent noté ce développement, sous le titre d'*hepar acinosum*. Il est une maladie caractérisée par la coincidence de l'atrophie du foie, qui est réduit à la moitié, au tiers de son volume, et du développement considérable des grains glanduleux." Now the *hepar acinosum* is without question a liver in the second stage of hepatic venous congestion, and presents several varieties in the precise form of the uncongested patches.

Starting with erroneous data such as these, what can be expected as the result of an experimental injection of the liver made by Cruveilhier, those who are thoroughly informed upon the exact anatomy of this organ will have no difficulty in anticipating; but to those who are only imperfectly acquainted with it, his conclusions must appear startling:—"Le foie ainsi injecté soumis à divers agens chimiques a présenté les resultats suivans: 1, l'injection bleue, c'est-à-dire celle de la veine cave, avait pénétré dans la partie centrale des grains glanduleux, partie qu'on appelle substance jaune du foie. Au milieu de la partie centrale était l'injection jaune, c'est-à-dire l'injection du canal biliaire. Autour de l'injection bleue, était l'injection rouge, c'est-à-dire, l'injection de la veine porte, et de l'artere hépatique, qui occupait toute la substance dite rouge du foie. Il suit de là que chaque grain glanduleux présente un appareil vasculaire ainsi disposé: 1, au centre, un canal biliaire; 2, sur un plan plus excentrique, un cercle vasculaire formé par les ramifications de la veine hépatique; 3, un cercle vasculaire concentrique au précédent, formé par les ramifications de la veine porte et de l'artere hépatique." Thus in the centre of *his* lobule, Cruveilhier* found the yellow colour of the ducts, most probably effused and colouring the whole of the yellow portion of his lobule. Next came a circle of blue, and then a circle of red, formed conjointly by the portal vein and hepatic artery. Now we have shewn that the centre of Cruveilhier's lobule is an uncongested patch formed by the contiguous margins of several adjoining hepatic lobules, and having an interlobular space for a centre;—where, therefore,

could we expect to find the yellow but in the interlobular space, and diffused immediately around it, so that the colouring matter would obscure the red injection of the portal vein and artery of that immediate point. Around the uncongested patch and in the congested substance we should find the intralobular veins of three or four or five surrounding hepatic lobules, (hence the variable size of Cruveilhier's lobules,) embracing by a kind of zone the yellow centre; and externally to the vein, the surrounding interlobular fissures would display the red injection of the portal vein and hepatic artery.

4. *Disorders of biliary excretion*.—Biliary congestion may be produced by various causes; the most frequent is temporary thickening of the mucous lining of the ducts from inflammation or capillary congestion; this will simply diminish the calibre of the ducts or produce a complete stricture. The obstruction may endure for a shorter or longer period; the swelling of the membrane may subside and the tube be restored to its original dimensions, or it may become chronic and be a permanent impediment to the free current of the bile. Another cause of congestion of the bile-ducts is hepatic venous congestion, which acts by producing pressure upon the lobular biliary plexus and interlobular ducts. This is usually a chronic cause. Congestion of the bile-ducts may likewise depend upon the impaction of a gall-stone in the larger biliary ducts or ductus choledochus, obliteration of one of the ducts by the pressure of a tumour, disease of the pancreas, or thickening of the mucous membrane of the duodenum. In each of these cases the ducts are loaded with bile, which gives a yellowish or greenish hue to the whole substance of the liver. Biliary congestion in a chronic form is usually accompanied with more or less of hepatic venous congestion.

When one of the bile-ducts is obliterated or obstructed by a biliary concretion, the ducts become dilated above the constriction, and considerable reservoirs are formed in the substance of the organ. If the impediment exist in the ductus choledochus, the gall-bladder becomes greatly distended as well as the biliary ducts. The irritation caused by the pressure of the bile has given rise to inflammation and ulceration of the coats of the gall-bladder or of the ducts, and the bile has been effused into the peritoneal cavity and produced death. When the cause of the obstruction is a biliary calculus of moderate size, the pressure of the column of the bile will sometimes force it onwards into the duodenum, and thus remove the impediment. In other cases, when the obstruction occurs in the cystic duct, the bile ceases to enter the gall-bladder, the sac becomes thickened and diminished in size, and filled with a colourless viscid mucus.

5. *Diseases of the parenchyma*.—The diseases of the substance or parenchyma of the liver may be referred to the following heads:—*a*, inflammation; *b*, hypertrophy; *c*, atrophy; *d*, softening; *e*, induration; *f*, fatty degene-

* These injections were not made by Cruveilhier himself, but by his assistant M. Bonami, as we are informed by M. Dujardin, in his paper "sur le foie, &c." The material used for the purpose was spirit varnish, and the results were not always successful.

ration; *g*, pus; *h*, tubercle; *i*, scirrhus; *k*, medullary sarcoma; *l*, fungus hæmatodes; *m*, melanosis.

a. Inflammation.—The tissue of the liver is liable to inflammation,—hepatitis, or the lobular hepatitis of some writers. The symptoms, like those detailed in the consideration of inflammation of the serous membrane, are severe and prominent, and clearly indicative of the nature of the disease. The pathologic appearances are deep redness, softness, general congestion, and enlargement of the organ from distension with blood. This condition is but rarely observed, from the circumstance of inflammation of the liver having no direct tendency to cause death, but being rather the precursor of the various other forms of disease which affect the organ. All the changes which occur in the liver are preceded or accompanied by inflammation acute or chronic, but more frequently by the latter, and in most instances by derangement of the venous circulation, and, occasionally, of the biliary excretion, giving rise to a complication of venous and biliary congestion.

b. Hypertrophy of the liver is increase of bulk of the organ, not depending, as in congestion, upon the quantity of blood circulating through it, but upon actual augmentation of the tissues of which it is composed. This state of enlargement of the liver may be general, or it may be confined to a part, as to a single lobe. Its predisposing cause is probably irritation of the mucous membrane of the ducts which gives rise in the first instance to retarded circulation and venous congestion, or it may be impediment either in the circulation through the heart, or through the rest of the venous system; or, again, it may depend upon diminution of the general powers of the system, as in a scrofulous constitution. The lobules are always in a state of partial congestion, resembling the second stage of hepatic venous congestion; the congested portion presents a deep red tint, and the uncongested part is ramose or convoluted in appearance, of a dirty white, greyish, yellowish, or greenish hue, in proportion to the condition of the biliary apparatus and to the quantity of bile contained within the liver. Sometimes the organ is pale, and appears deficient in its supply of blood; at other times it has a generally diffused redness, or the congestion may be greater in some situations than in others. The consistence of the liver in hypertrophy is equally variable with its colour: sometimes it is softer than natural, at other times it is dense and apparently granulated, the uncongested part projecting from the surface, and the congested portion sinking beneath its level. Hypertrophy of the liver is generally associated with chronic disease of the lungs, scrofula, and rickets, and often exists as a cause in ascites. It has been observed fifteen, eighteen, thirty-five, and even forty pounds in weight, and to have produced the displacement of the other abdominal viscera by its enormous size.

c. Atrophy of the liver is a condition of the nutritive functions of the organ which may succeed chronic inflammation or even hyper-

trophy; it occurs more rarely than hypertrophy, to which its comparative frequency has been estimated by Portal as 5 to 95. The substance of the liver diminishes in bulk, the lobules become indistinct and variously congested, and they appear intermingled and pressed upon by the cellular structure with which they are surrounded. Sometimes the proper structure of the liver is entirely removed and replaced by a loose or condensed cellular tissue. At other times the entire substance of the organ appears to have been absorbed by an enormous abscess, which has evacuated its contents into the intestinal canal, and the parietes have afterwards contracted and degenerated into an atrophied mass. Lieutaud gives an account of a liver that was shrivelled into a mass not larger than his fist. Portal found the liver in a case of ascites not bigger than an apple of ordinary size. Partial atrophy of the liver conjoined with hepatic venous congestion is not an infrequent consequence of the practice of tight lacing. I have before me a very interesting specimen of this affection. The surface of the liver is marked by deep fissures into irregular polygonal divisions resembling very strikingly the lobulated appearance of the fetal kidney. In one situation the stages of this change are distinctly apparent; a certain portion of the organ, about half an inch in breadth, has become partially atrophied from the pressure of two adjoining and protuberant portions of the liver, and in the lobulated portion the hepatic substance of this atrophied mass has been completely removed by absorption, leaving a kind of condensed cellular cicatrix extending like a septum for some distance into the organ. It is in this way that many of the grooves and fissures upon the convex surface of the liver are formed.

But the most interesting form of atrophy of the liver is that which was named by Laennec cirrhosis. In cirrhosis, the liver is diminished in volume to the extent of one-half or one-third of its natural bulk, the relative size of the right and left lobes is destroyed, and the surface is rendered shapeless by the projection of a number of ridges or granular points. The entire organ appears wrinkled and shrivelled, and of a yellow or greenish colour, varying in tint from a bright chrome to a yellowish or greenish brown. Upon dividing it with a knife it is observed to be more dense than usual, and the surface of the section presents a number of patches of variable size and of a roundish form, which resemble granules; hence this condition of the organ is named by the French authors "*foie granuleux*." In an advanced stage it is accompanied with jaundice and ascites, and is frequently preceded by some disease, either of the lungs or heart.

Kiernan is, I believe, the first pathologist who distinguished the true nature of cirrhosis, which he called *atrophy of the liver*. A very interesting case of this disease occurred in St. Bartholomew's Hospital, under the care of Dr. Latham, in 1832, an account of which was published in the *Lancet* in November of that

year. The patient died with jaundice and ascites. The liver, a portion of which I possess, presented a fine specimen of granulated cirrhosis; it "was diminished to one-half its natural size, and Mr. Kiernan on injecting it, discovered that a collateral venous circulation had been established by way of the diaphragm." In another case in a woman who had been tapped ninety times, Kiernan upon injecting the liver found that the same kind of collateral circulation had been formed. The circulation through the liver had been impeded by the development of condensed cellular tissue, and the greater part of the blood of the portal vein had made its way through dilated vessels upon the surface of the organ to the diaphragm, and from thence into the general venous circulation. In this case there were numerous bands of adhesion between the liver and diaphragm, and between the intestines and the walls of the abdomen, and these also were traversed by large veins conveying blood from the portal vein into the general venous current.

With regard to the pathological nature of the disease many opinions have been entertained by different writers. Laennec, dazzled by an ingenious theory deduced from his observations upon the nature and progress of scrofulous tubercle, saw in the mottled and granular section of cirrhosis only a "morbid deposit," a special accidental tissue existing in the two states of crudity and softening. But I quote the words of this author as detailed by Ferrus,* for while he errs in his speculations with regard to the nature of the disease, he draws an excellent picture of its general characters and appearance. "Les cirrhons existent dans l'état de crudité et de ramollissement. Dans le premier de ces états elles présentent un tissu d'une couleur fauve plus au moins foncée, qui quelquefois tire un peu sur le verdâtre; on ne peut s'en faire une meilleure idée qu'en la comparant à celle qu'offrent les capsules surrénales chez l'adulte. Ce tissu, quoique fort consistant, a une sorte de flaccidité que je ne puis mieux comparer qu'à celle de certains fungus, ou d'un cuir mou. Le tissu des cyrrhoses est d'ailleurs compact, assez humide et très-détié. On n'y distingue aucune trace de fibres, quoiqu'il présente en certains cas des divisions en forme de squames. Les cyrrhoses prennent en se ramollissant une couleur plus brunâtre."

"M. Laennec admet trois sortes de cyrrhoses: 1°. cyrrhoses en masses; 2°. en plaques; 3°. en kystes. Lorsqu'il existe, dit-il, des cyrrhoses dans le foie, elles forment ordinairement de petites masses dont le volume ne surpasse jamais celui d'un noyau de cerise, et quelquefois égale à peine celui d'un gros grain de millet. Ces masses sont toujours extrêmement nombreuses, et tout le tissu du foie en est par-émé. Leur petitesse fait que lorsqu'on incise un foie dans lequel il en existe un grand nombre, son tissu paraît au premier coup d'œil homogène et d'une couleur jaune fauve. Mais si on examine plus attentivement le tissu hépatique, on s'aperçoit facilement qu'il est rempli

* Dictionnaire de Médecine, Art. Foie.

d'une innombrable quantité de corpuscules assez semblables, pour l'aspect à ces lobules de graisse durcie et rousseâtre que l'on trouve communément dans le tissu cellulaire sous-cutané de la cuisse et de la jambe des sujets atteints d'anasarque. Ces petites masses sont quelquefois unies très-intimement au tissu du foie; mais assez souvent elles en sont séparées par une couche mince de tissu cellulaire qui leur forme une enveloppe tenue, et alors ils se détachent assez facilement. La surface extérieure du foie devient flétrie, rugueuse, et ratatinée à-peu-pres de la même manière qu'une pomme flétrie."

Bouillaud* considers this condition of the liver a dissociation of the two natural elements of the organ: "les masses jaunes fauves constituant le tissu accidentel, appelé cirrhose, ne sont autres chose que les granulations secretaires se desorganisant graduellement par l'effet de l'obliteration du lacis vasculaire, et de l'obstacle à la circulation hepaticque qui en résulte." We have already combatted the existence of two substances, and further remark upon this subject must be quite unnecessary.

Andral † sees, in the cirrhosis, atrophy of the red substance and hypertrophy of the yellow substance. Of all modern authors, Cruveilhier approaches nearest to the true condition of the organ, but from his misapprehension of the exact nature of the lobules, even his opinion cannot be accepted without limitation. Cirrhosis, says this author, ‡ is "atrophie du plus grand nombre des grains glanduleux, et hypertrophie avec coloration jaune des grains glanduleux restans." Now cirrhosis is undoubtedly a partial atrophy of the liver with hypertrophy of the cellular structure; complete atrophy of some of the lobules, partial atrophy of others, and biliary congestion without atrophy or hypertrophy of the rest. Those small yellow grains varying in size from a millet-seed to a pea or to a hazel-nut, are not distinct lobules in a variable state of hypertrophy, but small uncongested patches composed of parts of several adjoining lobules, and having a single or several interlobular spaces for a centre. Hence it is, as we have before shown, that Cruveilhier § has observed the "partie centrale de chaque granulation repond au radicule biliare, et consequemment est souvent teinte en jaune et que la partie excentrique repond à l'element vasculaire et consequemment est plus rouge que la partie centrale."

d. Softening of the liver may accompany any of the changes resulting from acute inflammation. The degree of softening is very variable, the organ having at one time a simple abnormal degree of friability when pressed by the hand, and at others constituting a pulpy mass scarcely retained in its form by the cellular framework of its vessels and Glisson's capsule. Softening may be unaccompanied by any marked change in the bulk of the organ, but is always associated with a variable intensity of venous congestion. Biliary

* Mémoire de la Société Médicale d'Emulation.

† Anatomie Pathologique, vol. ii. p. 565.

‡ Anatomie Descriptive, vol. ii. p. 568.

§ Anatomie Pathologique, livraison 12.

congestion is also frequently present, and tinges the substance of the organ with a variable hue of yellow, green, &c. Portal observes that the liver of patients who have died of scurvy is often so much softened that it appears in a state of decomposition, has a reddish brown colour, and resembles the lees of red wine. Baillie remarks that softening of the liver is not uncommon in old persons, that it approaches in consistence to the texture of the spleen, and is of a brownish red colour.

e. Induration of the liver is occasionally attendant upon hypertrophy or atrophy of the organ, but it may also exist with a normal size of the liver without other apparent change than the brownish red tint which it receives from venous congestion, or the various shades of yellow, green, or brown induced by biliary congestion. The density and hardness acquired by the liver in a state of atrophy are sometimes truly astonishing. In a case detailed by Morgagni the organ resisted the knife, and several such instances are to be met with among the writings of the older pathologists.

f. Fatty degeneration of the liver.—Upon referring to the section upon the chemical analysis of the liver, it will be observed that a certain proportion of oily matter is one of its natural constituents. Under the influence of diseased action this quantity is greatly augmented, and increases to such an extent as completely to take the place of the normal structures. Vauquelin has published an analysis of a fatty liver, from which the quantity of oily matter present may be fairly estimated thus; in 100 parts he found,

Oil	45
Parenchyma	19
Water	36
	100

The fatty matter is usually distributed equally through the organ, being apparently infiltrated into the cellular texture of the parenchyma. At other times it is deposited in a mass or forms several collections in different parts of the liver. The fatty liver is greasy upon the surface, and when cut into has the appearance of a section of yellow soap. The vessels seem pressed upon and are scarcely perceptible, while the greasy deposition is divided into angular masses by a coarse and compressed cellular tissue.

Fatty liver is generally consistent and solid in its texture, but sometimes the fat exists almost in a fluid state. Portal has observed the liver quite white and softened almost to the fluidity of melted fat, where no hepatic symptoms existed during life; and he particularly records the case of a woman suffering under a severe form of syphilis in which this condition of the liver existed.

From the name which has been given to this disease by pathologists, *fatty degeneration*, we might be led to infer that the texture of the organ was actually converted into this oily substance. This, however, is quite inconsistent with our knowledge of pathological phenomena. The fatty deposition is obviously an undue

secretion of a normal constituent, but whether resulting from irritation from whatever cause, or from absence of vital energy, is a question upon which I am unwilling, without further investigation, to hazard an opinion. With regard to the causes of fatty liver Andral observes, "Les causes sous l'influence desquelles le foie devient le siège d'une sécrétion de matière grasse sont encore inconnues. On n'a émis qu'une hypothèse lorsqu'on a dit que la dégénération graisseuse du foie était le produit d'une irritation de cet organe. Car on pourrait tout aussi bien soutenir que cette dégénération graisseuse, loin d'avoir été précédée par un état d'irritation du foie, est survenue parce que la nutrition de cet organe est devenue moins active; et cette dernière hypothèse serait d'autant plus soutenable, qu'elle se déduirait d'une grande loi de l'économie en vertu de laquelle, toutes les fois qu'un organe tend à s'atrophier, une matière grasse vient à se sécréter autour de cet organe ou à la place même de ses molécules."⁷

Fatty liver is most frequently observed in persons who have died from scrofulous tubercles in the lungs; in those, says Andral, in whom the blood has not been efficiently arterialised, and in whom the pulmonary exhalation is greatly diminished. Can it be, he inquires, from the absence of the due separation of hydrogen from the lungs that this compound of hydrogen, fat, becomes deposited in the parenchyma of the liver? This question is well deserving the attention of pathologists, and its solution might lead to important information. The disease has also been observed in some cancerous disorders and in dartrous diseases of the skin.

g. Pus. Abscess in the liver occurs in two principal forms, either as a single abscess of large size inclosed in a cyst, or as numerous small collections of matter, bounded by the substance of the liver or diffused amongst its lobules. In the first form it constitutes idiopathic abscess of the liver, a disease of tropical countries, and rare in our temperate climates. Abscess is generally preceded by acute inflammation and more rarely by chronic inflammation, and attains an enormous size, engrossing the whole of the right lobe and sometimes converting the entire organ into one huge cyst. The cyst may be thin or thick, and more or less organised. Andral and Louis conceive that its internal surface is analogous to a mucous membrane. The quantity of pus contained in one of these abscesses varies from a few ounces to several pints. My friend Dr. Macnaught, who has seen much practice in the West Indies during a residence of twenty-two years in Jamaica, has observed that abscess in the liver occurs more rarely in the West than in the East, and, moreover, that this disease affects the Europeans and not the Negroes. During the whole of his experience he never saw a single case of abscess in the liver in the Negro, and among the white population of his district only four well-marked instances.

* Anatomie Pathologique, vol. ii. p. 597.

The irritation of abscess causes the effusion of lymph and adhesion to the abdominal parietes or to the adjoining viscera; ulceration follows, and the contents of the cyst are discharged through the artificial opening. The situations in which the matter escapes from the cavity of the abscess are various. 1. It may burst externally, making its way either between the ribs or upwards towards the axilla. In a case observed by Dr. Macnaught the abscess pointed at the epigastrium and was opened by the surgeon in attendance. 2. It may become adherent to the diaphragm and burst into the pleura. 3. It may cause adhesion between the serous membrane of the liver and of the diaphragm, and between the latter and the pleura pulmonalis, and the matter may escape into the lung and be coughed up, as in the case already detailed, which occurred to Dr. Munro. 4. In rare cases the pus has been effused into the cavity of the peritoneum. 5. The abscess may become adherent to the stomach, duodenum, or colon, and the matter be discharged into the alimentary canal. A well-marked case of abscess discharging its contents into the stomach occurred to myself in the case of a woman who has since perfectly recovered. About two pints of matter were vomited by the patient. In a similar case observed by Dr. Macnaught the patient recovered. In two other cases, where the matter was poured into the intestines, the patients died. 6. Abscess has been seen to open into the gall-bladder, and the pus to be conveyed thence through the ductus communis choledochus into the duodenum. 7. In one case the matter was discharged into the vena cava; and in another, 8, described by Dr. Smith, into the pericardium; and in a case detailed by Dr. Graves,* the abscess opened both into the stomach and pericardium.

Besides the preceding form of abscess, which is idiopathic in its origin, abscess may occur in the liver from external injury, as from a blow. The inflammation attending upon this injury is much slighter than that which gives rise to idiopathic abscess; the collection of matter is generally smaller, and terminates either by discharging its contents or by absorption.

The second variety of abscess in the liver, that in which numerous purulent collections exist, depends for its cause upon the occurrence of wounds or of surgical operations. The succession of abscesses in the liver from wounds, particularly of the head, has long since been admitted as a well-established fact, for the explanation of which numerous theories have been invented. Theory, however, has now yielded before facts,—facts, too, of the most interesting and satisfactory kind, for which pathology is indebted to the genius and industry of Cruveilhier. The experimental researches † of this excellent author, published in 1826, enabled him to establish a law of the utmost importance in the consideration of the phenomena of disease, viz. that “tout corps

etranger introduit en nature dans le systeme veineux determine lorsque son elimination par les emonctoires est impossible des abscess viscéraux entièrement semblables à ceux qui succèdent aux plaies et aux opérations chirurgicales, et ces abscess sont le resultat d'une phlebitis capillaire de ces mêmes visceres.”* These experiments consisted in the introduction of metallic mercury into the veins of an animal, say of the lower extremity. In the course of twelve, eighteen, or twenty-four hours the animal experienced much difficulty of breathing, and soon expired. Upon inspection globules of the mercury were found in the lungs. If a smaller quantity of mercury were introduced the animal would live for several days or weeks, and upon examining the lungs at different periods the globules were at first seen to be surrounded by a red induration and afterwards by pus. This experiment was varied by pouring the mercury into the medullary cavity of a bone with precisely the same results; in one instance he placed a single globule in the medullary cavity and found it again at the end of a month in the lungs, divided into several minute globules, each of which formed the centre of a small tuberculous abscess. Cruveilhier then injected a small quantity of mercury into one of the omental veins of a dog—the subject of umbilical hernia; the dog was killed in the third month after the operation, being reduced to a state of marasmus. Upon inspection the liver was found filled with small abscesses, each surrounding a small globule of mercury. Having by means of these experiments satisfied himself that the lungs were the barrier to all foreign matters introduced into the general circulation, as was the liver of those admitted into the abdominal circulation, he proceeded to another series of experiments. Opening a vein in the hinder extremity of a dog he introduced into it a long piece of stick, which gave rise to phlebitis and the secretion of pus. The pus thus produced being carried into the circulation excited, in the first instance, abscesses in the lungs, and, secondly, in the liver. Upon these facts and upon a multitude of excellent observations Cruveilhier founds his opinion that abscess in the liver from wounds and surgical operations is always preceded or accompanied by purulent collections in the lungs, and always results from the same cause, viz. from capillary phlebitis, consecutive upon phlebitis in the neighbourhood of the wound, and immediately produced by the irritative action of globules of pus brought from the diseased veins to the capillaries of the structures in which the secondary suppuration is developed.

In every case of secondary abscess in the liver, following wounds of the head, or after amputation or operations upon bones, Cruveilhier has found phlebitis of the vessels situated in the structure of the bones. Hence he establishes an important general proposition, that “le phlébite des os est une des causes les plus fréquentes des abscess viscéraux suite des plaies et des opérations chirurgicales dans

* Dublin Medical Journal, January 1839.

† Recherches sur la siege immed. de l'inflammation. Nouv. Bibl. Med. vol. iv.

* Anatomie Pathologique, liv. xi.

lesquelles ces os ont été intéressés." The removal of hæmorrhoids and operations upon the uterus are sometimes followed by abscess of the liver, a circumstance which is easily explained upon the principles so clearly demonstrated by this author.

An excellent instance of secondary abscess of larger size than usual has been kindly furnished to me by my friend and colleague Mr. Rutherford Alcock, who, from his official position in Spain and Portugal during the recent struggles, has had much experience in injuries to the head. A man received a bayonet wound in the scalp, and died upon the fourteenth day after his admission into the hospital. Upon inspection there was observed thickening of the dura mater and a small quantity of matter upon the pia mater. No pus was discovered in the lungs, but a large abscess was found occupying the greater part of the right lobe. A statistical report from a work upon gun-shot wounds by the same author is also interesting. "Of scalp wounds, with and without abrasion, there were sixty-one; two only died, and one only presented disease of the liver; the other died from an attack of erysipelas."

The pathological changes which take place in the liver in these cases are, in the first instance, effusion of blood and lymph and induration around the inflamed vein; secondly, a secretion of a yellow concrete pus into the minute veins and among the lobules, giving to the liver, as Cruveilhier remarks, a granite-like appearance. In the next place the pus collects into small abscesses lodged in irregular cells, which increase in size by continued secretion and by communication with other cells. All these collections of matter are surrounded by a congested circle, which gives them a peculiar and characteristic appearance. After having existed for some time Cruveilhier has observed that the pus becomes converted into a concrete mass, very closely resembling the matter of scrofulous tubercle.

h. Tubercle in the liver is a disease of rare occurrence, and has seldom been observed independently of the existence of similar depositions in the lungs and other organs of the body, and of general indications of a scrofulous diathesis. When present, it exists in the form of small rounded tubercles, generally numerous, and varying in size from that of a millet-seed to a hazel-nut. They are composed of the soft cheesy or curdy deposit which is characteristic of this disease, and have a tendency to a brownish colour. The tuberculous matter is deposited in the tissue of the lobules by infiltration, and the lobules immediately surrounding the tumours are compressed and congested. The obstruction to the circulation in the organ being general on account of the number of the tubercles, the entire liver is more or less congested.

i. Scirrhous.—Carcinoma affects the liver under a variety of forms, but appears most frequently as tubercles of different size and consistence. These tubercles are more frequent than those of scrofulous origin, and are generally accompanied by symptoms denoting

a cancerous diathesis, and by the existence at the same time of similar tumours in other parts of the body. In their earliest development in the liver nearly all carcinomatous tumours present the same characters, resembling small, whitish, semi-opaque patches, occupying the tissue of one or of several of the lobules. As they increase in size they put on certain peculiar appearances, which have gained for them a subdivision into species and varieties. I do not intend in this place to enter into the arrangements proposed by authors, but will briefly describe the most striking varieties that have fallen beneath my own examination. The simplest of these tumours has been termed *scirrhous tubercle*, a name which appears particularly applicable from its resemblance in characters and structure to the same form of tumour occurring in other parts of the body. Commencing like the carcinomatous tumour generally in a semi-opaque patch, the outline of the lobules is for some time distinctly perceptible through its area, but at a later period the centre of the patch becomes quite opaque, and presents a cartilaginous hardness and creaking sound when divided with the knife. The circumference is gradually diffused in the surrounding textures, and the progressive increase of the tumour seems to take place by the secretion of a milky albuminous fluid into the meshes of the lobular venous plexuses. The circulation in these plexuses is at first unimpeded, but by the increase and induration of the secretion it is gradually arrested, and the vessels obliterated. The obliterated vessels give rise to the appearance of small cells, in which the carcinomatous matter is deposited, and the larger areae are produced by the tissue of the capsules of the lobules variously distorted from their original form by the increased deposition. As the tumours become more and more large, white lines, formed by compressed cellular tissue, are observed radiating from the centre towards the circumference. When seen upon the surface of the liver, the scirrhous tubercle appears flat, or very slightly depressed towards the centre. In a preparation of this form of tubercle now before me, the whole tumour is slightly raised above the surface; it presents no central depression, is cartilaginous in appearance, and has an irregular outline. Its section is dense and hard like cartilage, with no appearance of vessels, and of that pearly and semitransparent whiteness which is generally observed, in scirrhous tubercle, particularly in the variety which this preparation illustrates. Sometimes these tubera are small and very numerous, of a yellowish or brownish colour, and have a great activity of increase; the cells in which they are contained are thick and of larger size, and the albuminous secretion less firm than in the preceding variety. Occasionally they are reddened in the centre by the effusion of blood, from the congestion of unobliterated vessels, and sometimes by the continuation, through the tumours, of dilated vessels, which supply them with nutrition. In their enlarged state they frequently coalesce and give rise to an irregular

compound mass, which assumes the form of the particular part of the organ in which it is placed, and is divided into compartments, marking its original multiple form by septa of condensed Glisson's capsule supporting dilated vessels. It would appear to be this form of tumour which has been described by Farre as the first variety of his *tubera diffusa*; he gives them the following character. "Tubera, elevated at the surface of the organ, but not uniform in their figure, some rising with a regular swell into a round form, others acquiring a margin by being gradually depressed towards the centre, forming tumours without cysts, almost pulpy in their consistence, cellular in their structure, and containing an opaque white fluid."

Another form of the albuminous carcinomatous tumour is the "large white tubercle" of Baillie, the *tubera circumscripta* of Farre, by whom they are thus admirably described: "Their colour inclines to a yellowish white, and their projecting surfaces, slightly variegated with red vessels, deviate from a regular swell by a peculiar indentation at or near their centres, which are perfectly white and opaque. They vary much in size, which depends on the duration of each tuber, for at its first appearance it is very minute, but during its growth it assumes the character above described, and at its maturity exceeds an inch in its diameter. They adhere intimately to the liver, and their figure is well defined. They commonly remain distinct at the surface of the liver, but internally they ultimately coalesce and form immense morbid masses which pervade its substance. They possess so close a cellular structure that the section of them at first view appears solid and inorganic; but on the edge of the knife, by which they have been dissected, an opaque white fluid of the consistence of cream is left, and a fresh portion of this fluid is gathered on it at each time that it is repressed over the surface of the section. Their cellular structure becomes more apparent after long maceration."

The depression in the centre of carcinomatous tumours, although generally met with, is not a necessary character of cancer. Its mode of formation has been ably pointed out by Dr. Carswell, in his beautiful work on pathological anatomy: "The depression is not observed unless when the tumour is divided or is situated on the surface of an organ, as the liver, where tumours of this kind are generally met with. In the former case the depression arises from the softer substance, after the division of the tumour raising itself by its elasticity above the unyielding nucleus; in the latter it is produced by the peritoneum adhering to the surface of the tumour when small, and preventing its development in that direction. If the tumour does not come in contact with the peritoneum until it has acquired a considerable size, it presents no such depression, or only a very small one. Hence the reason why, in carcinoma of the liver, we meet with some tumours having a smooth globular surface, and others with a central depression of greater or less extent."

Another variety of carcinomatous tumour is named the gelatiniform cancer, from the existence of a firm and jelly-like deposit which occupies the cells of the tumour in place of the albuminous secretion common to the preceding forms. I have before me an interesting specimen of gelatiniform tubercle. The liver contains a considerable number of these tumours of variable size, and dispersed through every part of its structure. The smallest resemble the small patches described above as the incipient stage of carcinomatous tumour generally; the largest are equal in size to a walnut. They are distinctly circumscribed, and the lobules immediately surrounding them are flattened and compressed. In the smaller tubercles the form of the lobules is quite distinct, but in the larger the lobules have yielded to the peculiar characters of the disease. On the surface the centre of the tubercle presents an oval or circularly indented ring, around which the tumour swells suddenly and then subsides to the circumference. On making a section of one of these tumours, I found a central area of about two lines in diameter, transparent, dense, and apparently gelatinous, and distinctly bounded by a white marginal line; the marginal portion of the section forming the bulk of the tumour was elastic, and rose above the central area to subside gradually in the marginal line of the circumference. The whole section bore a striking resemblance to the conjunctiva affected with chemosis, only that it was paler in its colour, or to a beautiful flower with a single large and expanded circle of petals. On examining a thin section with a lens of low power a number of minute parallel injected capillaries were seen traversing the marginal portion of the tubercle towards the boundary line of the area, but no vessels could be traced beyond that line into the central portion. The resemblance to the petals of a flower was produced by white lines which radiated from the boundary line of the area to the circumference, and divided the marginal portion of the tumour into six or eight compartments. From careful examination it appeared to me that the central area was a single lobule expanded by the gelatinous deposition with which its tissue was infiltrated, and the marginal compartments presented a similar character.

k. Medullary sarcoma.—Another form of tubercle, associated with the cancerous diathesis and belonging to the carcinomatous family, is medullary sarcoma, or encephalosis. The tumours produced by this disease are larger than scrofulous tubercles, and more regular in form and fewer in number than scirrhus tumours. Developed originally in the same way with scirrhus, by infiltration into the tissue of the lobules, or into the vessels themselves, of the peculiar greyish white and opaque substance of which they are composed, they increase in size and obstruct the circulation in the surrounding lobules. Their internal structure is a loose cellular base, filled with a soft and brain-like matter, frequently coloured with blood, or containing coagula in various stages of softening, resulting from hæmorrhagic extravasation.

Sometimes these tumours present a certain degree of consistence, but as they increase in size they become more and more softened and pulpy. Baillie describes a large tumour in the liver which he considers scrofulous from being softened in the centre, and containing a fluid resembling pus; this is most probably a tumour of the kind I am now describing. Another tumour, of which he expresses himself at a loss to understand the nature, soft, of a brownish colour, and of about the size of a nut, appears to be also referable to the same species.

The second and third varieties of the tubera diffusa of Farre present characters resembling this disease. V. 2. "Tubera, elevated at the surfaces of the affected organ, encysted, or having distinct cells, formed by the growth of a fungus, which separates in flakes, and is composed of a fine reticular texture, containing an opaque white fluid." V. 3. "Tumours rising with a regular swell from the surfaces of the affected parts and yielding to the touch, composed of a very delicate reticular texture, pulpy in its consistence, varying in its colour even in the same subject, charged with an opaque fluid, and growing from cysts or cells."

Cruveilhier considers the venous capillary system as the seat of origin of carcinoma, particularly of the form which I am now considering; hence he observes, "Ayant exprimé d'une coupe faite à un foie cancéreux une matière d'un blanc-rougeâtre, encéphaloïde qui se mouloit à la manière du vermicelle, et qui pouvait acquérir en se tordant une grande longueur, j'aperçus sur cette coupe un orifice plus considérable que les autres; j'incisai cet orifice et je parvins dans un vaisseau très volumineux qui me parut être une des ramifications de la veine porte. Alors je disséquai avec beaucoup d'attention cette veine, et je ne fus pas peu étonné de voir que cette veine, depuis les plus grandes jusqu'aux plus petites divisions, était remplie par cette matière encéphaloïde, adhérente aux parois et tout-à-fait semblable à celle qu'on exprimait par les coupes faites au foie. Il me fut facile de suivre les ramifications extrêmement dilatées de la veine jusque dans l'aréole des coupes. L'altération était bornée à la veine porte, les veines hépatiques et leurs ramifications étaient parfaitement saines."

L. Fungus hæmatodes is the term applied to all carcinomatous tumours which have a tendency to the unnatural development of new vessels and to effusions of blood into their tissue. In the same organ, hard and cartilaginous scirrhous tumours may exist with those of a softer texture, and of a medullary form, and both of these may be mingled together in the soft, elastic, and bleeding mass which constitutes fungus hæmatodes. The tumours of fungus hæmatodes are often of very large size, and by their frequent hemorrhagies give rise to extreme symptoms and the speedy death of the patient. Farre arranges this form of carcinoma among his tubera diffusa, of which it forms the fourth variety, which he thus defines: "Tu-

mours elevated at the surfaces of the liver and inclining to a round figure; pulpy in their consistence, being charged with a thick and opaque fluid, variegated in their colour, chiefly white mingled with red, the former prevailing in their incipient, the latter in their advanced stages, composed of a very vascular and reticular texture, attached either to distinct pouches or to the substance of the liver, and so unlimited and rapid in its growth as to burst or destroy the peritoneal tunic of this organ and to protrude in the form of a bleeding fungus."

m. Melanosis.—Melanosis exists in the liver, as in other structures of the body, 1st, as a melanic secretion infiltrating the cellular structure of the organ, and giving a diffused general blackness to the substance of the lobules; 2d, as a morbid tissue composed of an areolar cellular network, in which the black carbonaceous matter is deposited; or 3dly, as a melanic pigment accompanying carcinoma or tubercle, and imbuing the abnormal tissue with its peculiar colour. The colour of melanosis in the liver varies from a deep chocolate-brown to a rich black. Sometimes it is diffused in patches through the substance of the organ, at other times it exists in the form of rounded circumscribed tubercles of variable size and number. Laennec considers melanosis as an accidental tissue without analogue among the animal tissues; he classes it with cancerous degenerations, and describes it as existing in his two favourite conditions of crudity and softening. But the researches of Cruveilhier have shewn that in many instances melanosis is to be received as a mere pigment, resembling the pigmentum nigrum of the choroid, which impresses its peculiar colour upon natural and morbid tissues, and he has also proved, in opposition to the view entertained by Laennec, that the softened state or state of infiltration very frequently precedes the more dense and encysted form. Melanosis rarely exists in the liver without being at the same time found in various other structures of the body, as in the brain, eye, lungs, heart, spleen, kidney, mucous membrane, muscles, skin, &c.

6. DISORDERS OF FUNCTION.—The principal function of the liver being the secretion of bile, we shall have to consider under this head the changes which may occur in the secretion of this fluid and in the fluid itself, in consequence of derangement of function in the organ. These disorders may be divided into three kinds:—

a. Suppression of the bile.

b. Alterations in the physical properties of the bile.

c. Alterations in the chemical qualities of the bile.

a. Suppression of secretion of the bile, like suppression of urine, occasionally occurs in the liver. This disease appears to have been known to Darwin,* who calls it "paralysis of the secretory vessels" of the liver; the patients, he says, "lose their appetite, then their flesh and strength diminish in consequence, there appears no bile in their stools nor in their urine,

* Anatomie Pathologique, liv. 12.

* Zoonomia, vol. ii, p. 5.

nor is any hardness or swelling perceptible in the region of the liver." Kiernan, who has observed several cases of this disease, informs me that the symptoms are sudden jaundice, depression of the powers of the system, and speedy dissolution; upon dissection he found complete absence of bile in the biliary ducts, the mucous membrane of which appeared bleached.

b. Alterations in the physical properties of the bile.—The changes to which the bile is liable are in no wise referable to any particular alteration in the liver. In cases where this organ has been considerably diseased, the secretion of the bile has been found natural and healthy; and in other cases, where a slight degree of congestion was all the apparent pathological derangement, the secretion has assumed a morbid appearance, or has been deficient or superabundant in quantity. Gall-stones are sometimes found in the gall-bladder without any admonitory symptoms during life, and icterus may be a frequent and even a fatal malady without any obstruction appearing in the course of the biliary tubes after death, or without any satisfactory indications of diseased action in the liver. "I have been sometimes astonished," says Andral, "on seeing the enormous quantity of bile which distended the alimentary canal in cases where the slightest degree of congestion existed in its coats, and when the liver appeared in no wise altered." Nay, it has been proved both by observation and experiment that the bile is materially changed in appearance, quantity, and consistence by the mere alteration of diet. Experiments made upon living animals have long since shewn that bile taken from different individuals is capable of producing very different effects upon the animals into whose bodies it has been introduced; thus some will give rise to a trifling irritation, while others will occasion more or less serious symptoms and even rapid death. Some bile may be touched and even tasted without inconvenience, while other bile, precisely similar in appearance, will produce pustular eruptions and ulcerations upon the tongue and upon the lips. "Here then," says Andral, "are serious changes in the bile which are wholly imperceptible to the investigation of anatomy."

The colour of the bile differs very considerably, being sometimes hardly distinguishable from serum, and at other times presenting a variable tint of amber, orange, green, brown, olive, and even black. In consistence it is equally various, being one while limpid and diffuent, and another while black, viscous, and grumous.

b. Alterations in the chemical properties of the bile.—In chemical composition, the alterations in the bile are not less numerous than in its physical properties. In fatty liver the bile has been found composed almost wholly of albumen and water. Under other circumstances the natural constituents are greatly altered in their relative proportion.

The formation of biliary calculi may be referred to disproportionate secretion of the na-

tural elements of the bile, the increased quantity of certain of its constituents giving rise to the deposition and accretion of these substances in a form corresponding with the cavities in which they are produced. Gall-stones have been found in the smaller biliary ducts in the substance of the liver, in the excretory ducts both within and external to the organ, and in the gall-bladder. They have also been met with inclosed in a cyst, formed most probably by the obliteration of one of the hepatic ducts, and adherent to the organ or suspended from it by a pedicle. Malpighi found gall-stones in the small biliary ducts and considered them as petrified lobules. The size of biliary concretions is very various, being sometimes exceedingly small, and at other times of considerable bulk. When small they are generally numerous; I have counted upwards of a hundred, and instances are recorded where more than a thousand were found in the gall-bladder. When they are large they are few in number, and frequently single. I have seen the gall-bladder filled with three, two, and even one large calculus. A large oval gall-stone now before me equal in size to a pigeon's egg I removed from the ductus choledochus. Their form is equally various with their size and other physical characters. I have now before me gall-stones with a flattened shape, triangular, and tuberculated on the angles and on the surface; others have three equal facets with sharp or flattened or rounded angles; others again are irregular in their outline and would seem to be moulded to the canals and cavities from which they have been withdrawn. Being stained by the colouring matter of the bile, their colour varies with the predominant tint of the secretion in which they have been formed, hence some are reddish brown or black; others are yellow, and others again white; some are mottled yellow and black, or white and black with various shades of green.

In chemical composition there are, according to Andral, five principal varieties of biliary concretions; they are, 1. of yellow colouring matter; 2. of resin; 3. of cholesterine; 4. of picromel; 5. of phosphate of lime. The first kind appears very ill founded, for yellow is a prevailing tint among gall-stones, and is the mere pigment by which cholesterine and the other substances are coloured. By far the largest proportion of gall-stones are formed of cholesterine, either pure, when it presents a white semitransparent mass beautifully crystallized in its interior, or variously tinted with brown, yellow, or orange, and radiating from the centre towards the circumference or from a small central nucleus. The smaller calculi also exhibit upon fracture the same radiated appearance. The gall-stones of resin and picromel may be classed together and considered as biliary concretions formed of inspissated bile probably accreted through the agency of cholesterine. The calculi of salts of lime are less frequent; they are found in the gall-bladder or in the ductus communis choledochus. I have observed them to present two varieties, firstly, incrustations of phosphate of lime upon

the surface of calculi of cholesterine; and secondly, laminated calculi composed of concentric layers of phosphate and carbonate of lime variously coloured and having a central nucleus. The latter form is, I believe, rare; I possess but one specimen; it is of large size, and rough and irregular upon the surface.*

7. *Entozoa*.—The Entozoa met with in the human liver are hydatids or acephalocysts; they are inclosed in a fibrous cyst and are contained in a single parent hydatid vesicle. The internal surface of the vesicle is soft and often pulpy, and covered by minute hydatids which are adherent to its sides. Besides these the parent vesicle is usually filled with a great number of smaller vesicles of variable size. The hydatid cyst generally occupies the right lobe of the liver and increases to a prodigious size, producing absorption of the structure of the organ, and forming adhesions with the neighbouring viscera. The existence of acephalocysts may sometimes be detected during life by the presence of a large tumour in the region of the liver, which forms a projection of the abdominal parietes, is soft and yielding to examination by the hand, and unaccompanied with symptoms denoting cancerous disease. Occasionally the cyst is hardened by deposits of cartilaginous or bony plates. Contracting adhesions with surrounding parts, the hydatid cyst has discharged its contents externally through the abdominal parietes; more frequently, however, it opens into the alimentary canal, as into the stomach or colon. Occasionally it bursts into the cavity of the abdomen, and in one case opened into the lungs, and many of the smaller hydatid sacs were ejected by coughing.

Some small cysts have sometimes been observed in the liver containing a calcareous deposit, mingled with membranous substance resembling fragments of hydatid sacs. These cysts are supposed to result from the spontaneous cure of acephalocysts.

Small intestinal worms have now and then been found in the biliary ducts; these are imagined to have gained admission into those tubes from the duodenum through the ductus communis choledochus.

BIBLIOGRAPHY. — Normal anatomy. — *Bianchi*, *Historia hepatica*, Taurin. 1616, 4to. 1710, 8vo. *Cortesius*, *De hepate*, 1630. *Rolfinkius*, *Dissertatio de hepate*, &c. Jena, 1653. *Glisson*, *Anatomia hepatis*, London, 1654. *Sylvius de la Boe*, *De bile et hepatis usu*, Lugd. Bat. 1660. *Malpighi*, *De viscerum structura*, Bologna, 1666, Lond. 1699. *Bidloo*, *Anatomia corp. humani*, Amstel. 1685. *Hoffmann*, *De venâ portæ*, Altonf, 1687. *Reverhorst*, *De motu bilis circulari*, Lugd. Bat. 1692. *Stahl*, *De venâ portæ, porta malorum*, Halle, 1698. *Pozzi*, *Commentariolo epist. pro gland. hepat. et Glissoni caps. &c.* *Fanton*, *Brev. manducatio*, hist. anat. corp. hum. Taurin. 1699. *Weyfer*, *De hepate*, 1700. *Hartmann*, *De bile*, in Halleri diss. anat. 1700. *Helvetius*, *De structurâ hepatis*, Lugd. Bat. 1711. *Fuchs*, *De venâ portæ*, Argent. 1717.

Salzmann, *De venâ portæ*, in Halleri diss. anatom. vol. iii. *Vater*, *Reply to Berger de novo bilis diverticulo circa orificium ductus choledochi ut et valvulosâ colli vesicæ constructione*, Viteb. 1720. In Halleri disp. anatom. vol. iii. *Huber*, *De bile*, Basle. 1733. *Wainwright*, *Anatomical treatise on the liver with diseases*, &c. Lond. 1737. *Günz*, *De venâ cavâ, venâ umbilic. et anastom. har. venar. in hepate*, Leipsic, 1738. *Ruyssch*, *Opera omnia*, Amstel. 1739. *Walther*, *De venâ portæ*, Lips. in Halleri diss. anatom. vol. iii. 1739-40. *Seeger*, *De ortu et progressu bilis cystic.* Lugd. Bat. in Halleri diss. vol. iii. 1739-40. *Morgagni*, *Adversaria anatomica*, Lugd. Bat. 1741. *Moeser*, *De vesiculâ fellcâ*, Argent. 1742. *Westphal*, *De existentiâ ductuum hepatico-cysticorum in homine*, Gryphie, 1742. *Juncker*, *Singularia quadam ad vesicam felleam ejusque bilem spect.* Halle, 1745.

Woertmann, *De bile utilisimâ χυλοποιουσῆς instrumento*, Ultraj. 1745. *Bertrandi*, *Dissert. anat. de hepat. et oculo*, Turin. 1746-48. *Franken*, *Hep. historia anatomica*, Lugd. Bat. 1748. *Ferrien*, *Sur la structure des visceres nommés glanduleux et particulièrement sur celle des reins et du foie*. In Mem. de Paris, 1749. *Haller*, *Disputationes anatomicae*, 1750. *Ramsey*, *On the bile*, Edinburgh, 1757. *Schroeder*, *Experimenta ad viciorem cysticæ bilis indolem declarandam capta*, Gottingen, 1764. *Spielmann*, *Resp. J. M. Roederer experimenta circa naturam bilis*, Argentor. 1767. *Maclury*, *Experiments on the human bile*, Lond. 1772. *Utendorfer*, *Experimenta nonnulla et observationes de bile*, Argentorat. 1774. *Ambodick*, *De hepate*, Strasburg, 1775. *Lobstein*, *Reply to Ambodick's diss. de hepate*, Argentorat, 1775. *Walter*, *Observationes anatomicae*, 1775. *Sabatier*, *Traité d'anatomie*, Paris, 1781. *Van der Leuw*, *De bilis indole ejusque in chylicatione utilitate*, Groning. 1783. *Goldwitz*, *Neue versuche zu einer wahren physiologie der Galle*, Bamberg, 1785. *Walter*, *De structurâ hepatis et vesiculæ fellcæ*, Annot. Acad. Berlin, 1786. *De polyp. uteri et hepate*, Berlin, 1787. *Richter*, *Expl. circa bilis naturam*, Erlangen, 1788. *Bleuland*, *Icon hepatis factû octimestrîs*, 1789. *Thilow*, *De vasis bilem ex receptaculo ad renes ferentibus*, *Ploucquet*, *Reply to Bolley, exp. circa vim bilis chylicæ*, Tubingen, 1792. *Saunders*, *A treatise on the structure, &c. of the liver, bile, and biliary concretions*, Lond. 1793. *Sammering*, *De corporis humani fabrica*, vol. vi. 1794. *Niemeyer*, *Comment. de commercio inter animi pathemat. hepar bilemque*, &c. Gottingen, 1795. *Murray*, *Reply to Froelich, delineatio sciagraphica venæ portæ*, Upsal, 1796. *Metzger*, *Anatomia hepatis comparatæ specimen*, Regiom. 1796. *Domling*, *Ist die Leber Reinigungsorgan?* Vienna, 1798. *Bichat*, *Anatomie descriptive*, Paris, 1801. *Portal*, *Cours d'anatomie médicale*, Paris, 1803. *Hoelieu*, *Descript. anat. syst. ven. port. &c.* Francfort, 1810. *Schumann*, *Diss. de hepatis in fetu magnitud. caus. ejusd. functioni*, Vratisl. 1817. *Mappes*, *Dissert. de penitiori hepatis humani structura*, Tubingen, 1817. *Bermann*, *Diss. de struct. hepatis ven. port.* 1818. *Felici*, *Osservaz. fisiologiche. sopra le funzioni della milza, vena portæ, del fegato, &c.* Milan, 1818. *Walther*, *Diss. de psychica hepatis dignitate*, Halle, 1818. *Bichât*, *Anatomic generale*, Paris, 1818. *Mascagni*, *Prodromo della grande anatomia*, Firenze, 1819. *Beltz*, *Quædam de hepatis dignitate*, Berlin, 1822. *J. F. Meckel*, *Manuel d'anatomie, générale, descriptive, et pathologique*. Translation by Jourdain and Breschet, 1825. *Dictionnaire de Médecine*, art. *Foie*, 1828. *Autenrieth*, *Ueber die Rindsstanz der Leber*. In Reil's Archiv. vol. vii. *Roose*, *Physiol. untersuch. Ist Galle im Blute?* *Wolf*, *De vesiculâ pellcæ humanæ ductus*, &c. In Act. Acad. Petrop. vol. iii. *Platner*, *Super vulgari doct. de funct. hepat. &c.* *Questiones Physiol. vol. ii.* *Müller*, *De glandularum secret. struct. penit.* Berlin, 1830. *Voisin*, *Nouvel aperçu sur la physiologie du foie et*

* [Mr. Taylor has recently described a specimen of gallstone, consisting essentially of *stearate of lime*. Lond. and Edin. Phil. Mag. 1840.—Ed.]

sur l'usage de la bile, Paris, 1833. *Kiernan*, Philosophical Trans. 1833. *Crueilhier*, Anatomie descriptive, Paris, 1834. *Burdach*, Physiologie; translation by Jourdan, Paris, 1838.

Morbid anatomy.—*Fernelius*, Medicina anatomia pathology. &c. Paris, 1554. *Kulbel*, Diss. de hepatitide, Erford, 1718. *Fischer*, Reply to Kulbel in Halleri disp. patholog. vol. v. *Kaltschmied*, De vulnere hepatis curato cum disquisitione de lethali. vulnere hepatis, Jena, 1735, et Haller, Disp. chirurg. vol. v. *Wainwright*, Anatomical treatise on the liver, with diseases, &c. Lond. 1737. *Jacconi*, De quibusdam hepatis, &c. affect. Bonon. 1740. *Teichmeyer*, De calculis biliariis, Jena, 1742. *Haller*, Disp. patholog. vol. iii. *White*, Essay on diseases of the bile, York, 1771. *Lysons*, Practical essays upon intermitting fevers, dropsies, diseases of the liver, &c. Bath, 1772. *Crawford*, On the nature, cause, and cure of a disease incident to the liver, &c. Lond. 1772. *Thienillier*, Ergo dubio hepatis in abscessu permittanda incidendi loci perforatio, Paris, 1744. *Haller*, Disp. Chir. vol. iv. *Coe*, A treatise on biliary concretions, &c. Lond. 1757. *Conradi*, Experimenta cum calc. vesic. fell. human. Jena, 1775. *Haase*, Reply to J. S. Lieberkühn, de abscessibus hepatis, Lips. 1776. *Schroeter*, Commentatio de pthisi hepatica, Gottingen, 1783. *Matheus*, Observations on hepatic diseases incidental to Europeans in the East Indies, Lond. 1783. *Frank*, De larvis morborum biliosis, Gottingen, 1784. *Weissenborn*, Von den Eitergeschwuren der Leber durch einen merkwürdigen Fall erlautet, Erfurt, 1786. *Audree*, On bilious diseases, &c. Lond. 1788. *Goldwitz*, Neue Versuche ueber die pathologie der Galle, Bamberg, 1789. *Leake*, A practical essay on diseases of the viscera, Lond. 1792. *Saunders*, A treatise on the structure of the liver, bile, and biliary concretions, Lond. 1793. *Saemmering*, De concrementis biliariis corporis humani, Francfort, 1795. *Baillie*, Morbid anatomy of the human body, Lond. 1797. *Gibson*, A treatise on bilious diseases, indigestion, &c. Lond. 1799. *Powel*, Observations on the bile and its diseases, Lond. 1801. *Schwarze*, Diss. de sympath. inter cerebrum et hepate, Lips. 1811. *Furze*, Morbid anatomy of the liver, Lond. 1812. *Portal*, Observations sur la nature et le traitement des maladies du foie, Paris, 1813. *Ballingall*, Pract. obs. on fever, dysentery, and liver complaints as they occur amongst European troops in India, Edinburg, 1818. *Mahlendorf*, De ictero, Berlin, 1818. *Mills*, Enquiry into the effects produced on the brain, lungs, &c. by diseases of the liver, Lond. 1819. *Thilenius*, Ueber Leberentzündung und ihre Behandlung, &c. *Hufeland's Journal*, vol. xviii. *Ackermann*, Von Entzündung der Leber und deren Endigung in Vereiterung, Ackermann's Bemerkungen, vol. vi. *Vater*, Reply to Schimmer, De calculi in vesicula fellea generatione; in Haller Disp. Path. vol. vii. *Betzold*, De cholelitho; in Haller Disp. Path. vol. iii. *Haller*, De calculis felleis, Opusc. Path. *Morgagni*, De calculis felleis, in Opusc. Misc. *Percival*, On a new means of decomposing gall-stones. *Beitrag*, Zur Geschichte der Gallensteine von Eisefeld; in Isenflamms und Rosenmüllers Beytrag, vol. i. *Pemberton*, A practical treatise on the diseases of the abdominal viscera, Lond. *Chestons*, Pathological enquiries; abscess in the liver. *Pouteau*, Des ulcers de la foie à la suite de blessures de la tête, Œuvres, vol. ii. *Löffler*, Ueber die Leberentzündung bei Schwängern und Wochnerinnen. *Bichat*, Anatomie pathologique, par Beclard, Paris, 1825. *Hope*, Principles and illustrations of morbid anatomy, &c. Lond. 1834. *Mayo*, Outlines of human pathology, 1836. *Carswell*, Pathological Anatomy. *Crueilhier*, Anatomie pathologique du corps humain.*
(*W. J. Erasmus Wilson*.)

LUMINOUSNESS, ANIMAL. (*Phosphorescence*.) An evolution of light from the bodies of living animals, independent of the reflection of incident light.

The animals which possess the property of thus emitting light are almost entirely invertebrate, and chiefly marine. We have accounts from several naturalists of certain fishes having been seen to give out light while in their native element, and some have conjectured,—but on insufficient grounds,—that all fishes do so. The turtle and a species of toad inhabiting Surinam have been reported to have the same property; and the eyes of some carnivorous mammals appear to emit flashes of light. But we find this function constantly and distinctly manifested only by certain mollusca, insects, crabs, annelida, acalaphæ, and zoophytes. These are the following:—

MOLLUSCA

Pholas dactylus
Salpa zonaria
telesii, &c.
Pyrosoma atlanticum
giganteum, &c.

CRUSTACEA

Cyclops brevicornis
Gammarus pulex
Cancer fulgens, &c.
Scyllarus ———?

INSECTA

Lampyris noctiluca
splendidula
italica
ignita
phosphorea
nitidula
lucida
hemiptera
japonica
Elater noctilucus
ignitus
phosphoreus
lampadion
retrospiciens
lucidulus
lacernula
speculator
janus
pyrophanus
laminosus
lucens
extinctus
cucujus
lucifer
Buprestis ocellata
Chiroscelis bifenestrata
Scarabæus phosphoricus
Pausus sphaerocerus
*Fulgora lateraria**
serrata

* Doubts have been expressed by several observers with regard to the luminousness of this insect. In travelling in the countries of South America where it occurs, they have never seen it shine; but the testimony of other naturalists is so decided in favour of it being luminous, that we are constrained to suppose that the animal may give out light in certain seasons of the year and not in others. There can be no doubt, at least, that its congeners above-named are truly luminous.

* [See also Dr. Bright's admirable paper on Abdominal Tumours and Intumescence, in Guy's Hosp. Reports, No. xi.—ED.]

Fulgora pyrrhorhynchus
candelaria
Pyralis minor
Acheta gryllotalpa?

MYRIAPODA

Scolopendra electrica
phosphorea
morsitans
Julus ————?

ANNELIDA

Nereis phosphorans
noctiluca
cirrigeria
mucronata

Planaria retusa

ECHINODERMATA

Asterias ————?
Ophiura teluctes
phosphorea

ACALEPHÆ. Almost all the species of *Medusa*,
Beroe, *Physalia*, *Rhizophora*, *Stephanomia*,
 and *Physophora*.

ZOOPLYTA

Pennatula phosphorea
grisea
rubra
argentina

INFUSORIA. Many species belonging to the
 genera *Cercaria*, *Volvox*, *Vibrio*, *Trichoda*,
Lincophæa.

With regard to fishes, the statements of naturalists are so contradictory that we still hesitate to admit any of them on the list of truly luminous animals. The sharks, more frequently than other fishes, are reported as luminous. The light given out by them is said to proceed from their abdominal surface. When large shoals of fishes are swimming rapidly, flashes of light, broad and deep, are sometimes seen about them and are supposed to be emitted by the fishes themselves. These appear occasionally at very great depths. They have been traced in the British seas to shoals of herrings and the coal-fish; and Dr. McCulloch enumerates also the pollack, the pilchard, the sardine, the whiting, the mackarel, and the gar, as being sometimes accompanied by these lights.*

The common earth-worm is not included in the above list, although several observers have reported it as luminous, because the fact of its being so is not sufficiently determined. It is said to give out light only during the period of propagation.

Some voyagers, as Peron, have stated that they have seen *sertulariæ*, *gorgoniæ*, *alcyonia*, and sponges give out light immediately after being dredged from the bottom of the sea; but we suspect that in most of these instances the light proceeded not from the zoophytes, but from some light-giving annelids parasitical upon them. This is frequently met with in the British seas.

II. *Characters and properties of animal light.*—It is only in its most obvious qualities that animal light has hitherto been the object of scientific research. In colour and intensity it varies very much at different times in the same animal, and still more in different animals.

With regard to colour the following varieties occur. In *pholas dactylus* the light is bluish-white; in *lampyris noctiluca* it is greenish with a shade of blue; in *l. italica*, bright blue; in *Elater noctilucus*, brilliant green, with spots of "the most beautiful golden blue;" in *Fulgora pyrrhorhynchus*, deep purple and scarlet; in marine animals generally it is white with various shades of blue. Doubtless these differences depend chiefly upon the various colours of the integuments through which the light is seen.

In *lampyris italica*, there are alternate emissions and extinctions of the light, which take place with some degree of regularity and seem to be synchronous with the pulses of the circulating current, visible in the wing-cases of this beetle.*

The fire-fly (*Elater*) shows two kinds of light; one constant, like that of the glow-worm, but more feeble; the other a vivid white light suddenly intermitted. Its illuminating power seems to be greater than that possessed by any other animal; the light emitted from its two thoracic tubercles is so great that the smallest print may be read with it; and in the West Indies, (particularly in St. Domingo, where they are abundant,) the natives use them instead of candles in their houses. They also tie them to their feet and heads in travelling at night to give light to their path through the forest. The intermitting of the light in this insect is such as to give an observer the idea of a membranous veil being suddenly drawn over the source of light, and then as suddenly withdrawn.

In a species of cancer seen by Smith in the Gulf of Guinea, the light (which seemed to be emitted by the brain) was of a deep blue colour when the animal was at rest; but when it moved, bright coruscations of silvery light were darted from it in all directions. The light of some centipedes inhabiting the islands of the Pacific is of a beautiful emerald-green colour. It is connected with a mucous matter covering the animal, which may be rubbed off by the fingers, and communicates to them a smell not unlike that of muriatic acid.

Sometimes the light proceeding from the sea is so white and dull as to give the effect of a sea of milk. This is frequently seen in the Gulf of Guinea, and seems to be caused sometimes by the presence of numerous *Salpa* and *Scyllari*, at other times by the admixture of the debris of fishes and other marine animals recently dead.

An extraordinary series of phenomena connected with a particular display of the luminousness of the sea, is reported by Mr. Henderson as having occurred in the Atlantic, (lat. 2° long. 21° 20' W.) on the 5th March, 1821. About 9 p.m. the sea appeared unusually luminous. Every person who kept his eye fixed upon it for but a short time was immediately affected with giddiness, headache, pain in the eyeballs, and slight sickness. Although these symptoms varied in intensity amongst the

* A species of *lampyris* lately found in New Holland is said also to shine in rhythmical pulses. Isis, vol. ii. p. 245.

spectators, yet there was not one on board who did not feel some degree of them; and all imputed them to the effect of the light proceeding from the surface of the ocean. Mr. Henderson remarks: "For my own part, the headach, &c. which followed immediately my looking at the water, was particularly severe, nor did it go off until morning. The effects I experienced were like those produced by smoking too much tobacco."*

There have been recorded some accounts of very intense light produced over a great extent of the ocean's surface by luminous animals, but it does not appear that any other voyagers have experienced physical effects from the light such as are described by Mr. Henderson. The great intensity with which it is occasionally produced by marine animals, however, is well illustrated by the descriptions that are given of the moral emotions with which it inspires the beholders. Witness, for instance, Mr. Bonnycastle's description of a scene which he met with in the Gulf of St. Lawrence, (7th Sept. 1826.) While it was very dark, a brilliant light, like that of the Aurora, was seen to shoot suddenly from the sea, in a particular quarter. It spread thence over the whole surface of the water between the two shores of the Gulf; and shortly there was presented "one blazing sheet of awful and most brilliant light." "Long tortuous lines of light showed many large fishes darting about as if in consternation at the scene." The light was sufficient to enable one to see the most minute objects on the ship's deck. On drawing up a bucketful of the water, and stirring it with the hand, it presented "one mass of light, not in sparkles as usual, but in actual coruscations."†

Messrs. Quoy and Gaimard state that in handling luminous marine animals while alive, they have always been sensible of an odour proceeding from them similar to that which is perceived around a highly charged electrical apparatus.

The only observation with which we are acquainted that seems to indicate the evolution of heat in connexion with the light of animals, is that reported by Macartney, who states that he found the thermometer raised by two or three degrees when placed in contact with a group of living glow-worms shining, or even with their light-giving sacs cut off. The repetition of this experiment, however, has not produced the same result in the hands of others: they saw no rise of the thermometer.

III. *Circumstances in which light is given out, and by which its intensity is affected.*—It is not known whether there be any luminous animals that give out light in all circumstances, and at every period of their existence, in their natural situations. So far as observation extends, certain *mollusca*, and some of the species of *elater* appear to shine without intermission. But most of the other light-giving animals with which we are acquainted use their peculiar function only occasionally, and that, for the most part, under some kind of excitement or irritation, natural or artificial. In the

absence of more direct means of investigation, we may, perhaps, attain to some measure of acquaintance with the nature and analogies of animal light by inquiring into those sources of irritation under which it is given out. Here, however, we are met by the difficulty of finding contradictory statements of facts made by different observers. So that our exact knowledge on the subject is still insufficient to admit of any satisfactory conclusions being drawn. What is known on this point may be conveniently considered under the two following heads.

I. Circumstances essentially connected with the state of nature in which the animals are placed when they give out light.

II. Circumstances artificially produced affecting the emission of light.

I. *Natural circumstances* in which light is emitted by living animals. The luminousness of animals in their natural state is affected by, 1. Changes in the state of the medium in which they live, whether air or water, in regard to its temperature and electricity. 2. By solar light. 3. By abrupt collision with other bodies. 4. By loud noises. 5. By the internal movements of the animals themselves, amongst which may be included the exercise of the animal's will.

1. *Temperature, &c.*—By far the greater number of luminous animals with which we are acquainted are natives of warm climates; but those inhabiting the ocean are seen in almost all latitudes, even in the coldest; although in these they are not so numerous, and give less light. No aerial insects give out light, in ordinary circumstances, excepting at a temperature of about 50° Fahr. and upwards; and the higher the natural temperature, the brighter is the light emitted.

In temperate climates the *Lampyridæ* shine only in summer and autumn. *L. noctiluca* appears in this country between June and September; *L. splendida*, in Germany, is luminous in May; and *L. hemiptera* so early as in the end of April.

The light of *pholus dactylus* is strongest in summer; and that of marine animals in general is increased before storms.

2. *Solar light.*—It is said that *Scolopendra* does not shine at night excepting it has been exposed during the day to solar light. A short time of exposure to the sun's rays seems to be sufficient to refresh its luminous power, as (like all other light-giving animals) it secretes itself as much as possible during the day. It is stated by Burmeister,* with regard to the *Lampyris Italica*, that if it be kept some days in the dark it entirely loses its luminousness, but regains it on being again placed in the sunshine.

3. *Lunar light.*—Macartney remarked that luminous *medusæ* generally retreat from the surface of the water at moon-rise.

4. *Abrupt collision with other bodies.*—Marine luminous animals very readily emit their light on being struck by any moving body; so that one of the most commonly observed phenomena connected with this subject is the

* Trans. Med. and Phys. Soc. of Calcutta, i. 107.

† Trans. of Lit. and Hist. Soc. of Quebec.

* Manual of Entomology, transl. by Shuckhard, p. 494.

sparkling of the minute *medusæ* and other animals, swimming on the surface of the sea, when they are dashed against the sides of a ship, struck by an oar, or tossed on the foamy crests of the waves; and this even while no other light is seen excepting just at the points where the water is agitated. In experimenting with *Medusæ*, Macartney found that, when kept in a glass vessel in a state of perfect rest, they gave out no light, but that, on the slightest movement of the vessel, a brilliant flash was emitted, which was brightest when the animals swam near the surface. Macculloch remarks, "Very often we have found the water crowded, even with the largest *medusa*, yet scarcely betraying themselves by an occasional twinkle, when the dash of an oar or any accidental agitation was sufficient to involve the whole water in a blaze of light."

5. *Loud noises*.—When any loud noise is made near a luminous insect while shining, it frequently ceases to give out its light.

6. *Internal movements of the animals themselves*,—*will, &c.*—With regard to insects, we have many concurrent testimonies to the fact that more light is emitted during the season of procreation by most of the species than at other times. So strikingly is this the case in the *Lampyridæ*, that the light given out by the female has been generally regarded, (although without sufficient reasons,) as destined *only* to attract the attention of her mate. After the eggs are deposited, the light gradually decreases in intensity.

While it is obvious that, for the most part, the emission of light is altogether independent of any voluntary effort on the part of the animal itself, yet it appears probable that, through some means or other, the animal has the power of varying the intensity of the light at pleasure. We cannot, for instance, imagine that sound can have any direct effect on the light-giving organs themselves, so as to cause them to shine less brightly when loud noises are made near them. Such effect must be communicated through the animal's sensorium. It is supposed by some physiologists that variations in the intensity of the light given out by insects depend on the quantities of *air* admitted through the tracheæ in respiration, over which quantities the animal's will seems to exercise some control. In observing the luminousness of the elater, Spix concluded that this control is so perfect, as to admit of the light being wholly extinguished by the animal's preventing the admission of air; and this view is adopted also by Treviraus. These changes, however, are explained by others, (as by Müller and Murray,) by supposing that, when the light seems to fade, the organs are merely withdrawn behind opaque parts, or, as it were, veiled by a curtain.

In general the light is increased when the animal is in motion; and in insects, particularly during flight. Macartney observed of the *berocæ*, that when it swam slowly near the surface of the water, its whole body became occasionally illuminated in a slight degree; but that, during its contractions, a stronger light issued from the ribs, and that when a sudden

shock was communicated to the water in which it was swimming, a vivid flash was given out.

That the luminous function is in many animals directly under the control of their will, seems to be proved by the fact, that while under any sudden irritation calculated to alarm them, they, at first, emit light strongly, yet on the frequent repetition or continuance of the same kind of irritation, they extinguish their light, and cannot be excited to shew it again for a considerable time.

II. *Artificial circumstances* in which light is emitted by living animals, or by which the emission of it is affected.

Light-giving animals being removed from their natural situations, and subjected to artificial processes and agents, are found to have their luminousness affected by being exposed to, 1. the effects of accumulated electricity and electrical currents; 2. immersion in various fluid and gaseous media; 3. pressure of their bodies; 4. removal of their luminous organs, and mutilation of these and of other organs; 5. exposure to various degrees of heat and moisture; 6. immersion *in vacuo*; 7. removal from all foreign sources of light.

1. The effects of *accumulated electricity and electrical currents*. In experimenting on marine luminous animals, Macartney passed a shock through water in which they were swimming; immediately their light was extinguished for an instant, but afterwards became brighter than before. In reporting the result of a similar experiment, Humboldt merely says that the luminousness of the animals was increased after the shock. Macaire subjected glow-worms to the action of galvanism, and found that when one wire was forced through the body of the insect as far as the luminous organs, while the other was applied to the surface slightly moistened, the light became brilliant. One galvanic pole produced no effect; but when insects not shining at the time were placed in a galvanic circle they always began to give out light. This result was not obtained *in vacuo*, but whenever the air was admitted, the light reappeared. No effect whatever seemed to be produced by common electricity, howsoever applied.

2. *Immersion in various fluid and gaseous media*.—Luminous marine animals, when removed from their native element, and plunged into fresh water, give out their light for a time more vividly and more steadily, but afterwards it gradually fades and becomes extinct. Mineral and vegetable acids, alcohol, potassa, and solutions of corrosive sublimate, and the salts, all produce nearly the same effect; only that by these the light-giving property is more speedily destroyed. Observers differ in their accounts of the effects produced by immersion in various gases. Most of those who have experimented in this way have seen the light of the glow-worm very rapidly extinguished in hydrogen gas; also in sulphuretted and carburetted hydrogen, carbonic acid, chlorine and nitrogen gases; but Sir H. Davy found that hydrogen gas produced little or no change in the state of the light; the same was the result of Murray's experiments, who also found

the glow-worm continue to shine in carbonic acid gas. Immersion in oils of all kinds destroys the light-giving property in most of the insects endowed with it; but in *Lampyrus italica*, Carradori found that the light continued to be emitted when the luminous part of the body was plunged into oil.

3. *Pressure of their bodies.*—It has been observed that shortly after the death of the insect, the light-giving organs of *elater* emit light freely when the body is bruised, and in general mechanical irritations of all kinds cause a certain degree of increase in the intensity of the light given out. Some animals, as *pennatula*, seem to emit their light rarely, excepting in such circumstances.

4. *Removal of the luminous organs, and mutilation of these and of other organs.*—The luminous organs may be cut out from the bodies of glow-worms and fire-flies without the peculiar property of the organs being immediately destroyed. The emission of light can for some time be re-excited by slight mechanical irritations; as by touching the organs with the point of a pin. Those of the glow-worm have been seen to shine for two or three days after excision, when slightly moistened with water, heated or electrified. In experimenting on the same insect, Todd found that the light was extinguished within six minutes after the head was cut off; as also when the luminous rings were cut into, but was renewable by the application of heat. Sheppard removed the luminous matter from a glow-worm; the wounds healed within two days, and the body became again filled with new light-giving substance.*

5. *Exposure to various degrees of heat and moisture.*—Light-giving insects in general do not shine at any temperature below that of 53° Fahr. Macaire took some glow-worms that had been kept for some time at a temperature of 50° Fahr., plunged them into water at 55°, and gradually raised the temperature. Light was emitted for the first time at 77°, and increased in intensity until the water was at 105°. At this temperature the animals died, but the light continued until the temperature had reached 134° 5, when it wholly disappeared. When glow-worms are thrown alive into water heated to 110° and upwards, they die instantly, but at the moment emit a brilliant light. When they are exposed to an artificial cold suddenly, they perish at any degree below the freezing point of water; but the light may be partially restored by a temperature of 70°, although the animals shew no other sign of vitality. When the insects are dried artificially, the light is extinguished, but it may be restored by their being again moistened.

6. *Immersion in vacuo.*—When glow-worms are placed in *vacuo*, their light fades, but re-appears on admission of air.

7. *Removal from all foreign sources of light.*—If luminous insects be confined in a dark place, they shine little in the early part of the day, but long before night they begin to do so;

although generally, in their native situations, they do not emit light until the twilight. If the confinement in a dark place be protracted, they do not shine so brightly as after having seen the sun during the day.

IV. *Seat of luminousness in different animals.*—In most of the luminous animals that inhabit the ocean, a great part of their surface seems to be endowed with the property of forming, and pouring out, a mucous fluid, which contains the luminous matter, and is frequently miscible with water and other fluids. This sometimes so entirely covers the whole animal as to cause it to emit light from every point of its surface; but more generally when the animal is swimming, the light is seen to proceed only from certain regions. Some of the *meduse*, even of the largest size, emit light from a very small point, particularly when the luminous organ is placed in the central parts of the body. When the light is vivid, it seems to be larger than it really is, from the refracting power of the gelatinous tissues through which it passes. Occasionally the luminous point has not a diameter equal to the 1-200th of that of the animal itself. In *cydippe pileus* and *oceania pileata* of the Baltic, Ehrenberg finds that the light issues solely from the vicinity of the ovaries, and in *oceania hemispherica*, from the bases of the cirri. *Pholas dactylus* gives out light most strongly from the internal surface of its respiratory tubes. The luminous mucus is sometimes poured out even by very small animals in such quantity as to leave a luminous wake behind them, as in an instance mentioned by Quoy and Gaimard. These observers saw such luminous lines formed in the paths of certain extremely small creatures, so transparent that their forms could not be distinctly made out. The positions of their bodies were marked in the water by bright spots, which were followed in their course by luminous wakes, at first about an inch in breadth, but afterwards by the movements of the water spread out to the breadth of two or three inches. This luminous mucus is supposed to be the seat also of the remarkable stinging property possessed by many of the *acalephæ*. It retains its luminousness in some instances for a day or two after being emitted by the animal, but loses it whenever putrefaction commences.

But although this luminous mucus be so generally secreted and emitted by marine animals, it is evident that the light given out by many of them has its seat in certain organs more or less internal, whence it proceeds in gleams and momentary flashes that seem to depend only on the movements of some imponderable agent. The exact position and relations of these organs can seldom be satisfactorily discovered, but in some crabs and minute crustaceous animals that emit light, it is observed to proceed from the central organs of the nervous system. In other crustacea the whole body seems to be full of light, which is emitted, as at so many windows, through the translucent membranes interposed between the segments of the crust. Dr. Macculloch con-

* Kirby and Spence's Entomology, ii. 426.

cludes from his numerous observations on this subject, that, in marine animals generally, the coats of the stomach and intestines are the light-giving organs.

In insects the seat of luminousness is more satisfactorily ascertained, and is found to vary very much in different species and tribes. The eggs of the *lampyrides* are said to be frequently seen luminous, and to continue so for several days after being deposited. In the states of larva and chrysalis also, the same insects emit light most vividly when touched, chiefly from the posterior segments of the body. On being much irritated, the whole of the chrysalis seems to shine in a slight degree, and for a short time.

In the perfect female glow-worm of this country, the light is emitted chiefly from the inferior and lateral surfaces of the two or three last segments of the abdomen. The male of the same species presents only two small luminous points on the sides of one of the segments. When the light-giving surfaces of the female *lampyris noctiluca* are narrowly examined, it may be seen that, on the penultimate and antepenultimate segments, they present bands of a bright greenish-yellow light, which are abruptly terminated towards the trunk by an irregularly wavy line; and that from the rest of the same segments there issues a fainter light of a pale green colour. There is also a little light given out by the posterior extremity of the dorsal line. In *L. italica*, the two last segments are wholly and nearly equally luminous. Most of the glow-worms in displaying their light recurve their tails upon their backs, so as to bring their luminous surfaces into view.

Elater noctilucus gives out light principally from two points of the thorax, which are somewhat raised, and of an oval shape; but it has also two light-giving organs situated beneath the wing-cases, which are not seen except when the insect is flying. Light is also emitted from the internal parts through the interstices between the abdominal segments.

In *bupestris ocellata*, the light is emitted from certain yellow spots upon the *elytra*: in *scarabæus phosphoricus* from the belly: in *chiroseclis bifenestrata*, (a New Holland insect) from two oval, hairy, reddish spots on its second ventral segment; while, in *pausus sphaerococcus*, a dim phosphoric light issues from its singular hollow globular antennæ.

Macartney says that he always observed the shining of *scelopendra electrica* to be accompanied by the appearance of an effusion of a luminous fluid upon the surface of the animal, particularly about the head. On touching this, his finger and other bodies received on their surface a phosphoric light, which continued to shine for a few seconds, and then died away; and yet he could not see any actual moisture, even upon smooth glass, although examined immediately and attentively.

The researches of Treviranus have led him to conclude that there is no special luminous organ in insects; but that the generally diffused fatty matter is the seat of the function,

by which the luminousness is produced. He concludes, therefore, that, when the air has free access to the interior of the body through the respiratory tubes, the whole of the internal organs give out light; and that this is not seen, excepting at certain points of the surface, merely because the integuments are not translucent.

V. *Anatomy of light-giving organs.*—The accounts of examinations of these organs that have hitherto been published are rather imperfect. This appears to be owing chiefly to the fact that the organs themselves are of very simple structure and furnish no materials for lengthened description. So much so are they in insects, that one would be inclined readily to conclude with Treviranus, that they are nothing but the common fatty or interstitial substance which fills up the bodies of insects, slightly modified by the presence of some phosphoric matter, were it not for the fact, particularly observed by Macartney, that, in the glow-worm, the luciferous organs are absorbed after the season for their use is past, and their places supplied by the fatty substance. The following are the results obtained by this naturalist and by Spix from their dissections of the glow-worm, the fire-fly, and the lantern-fly.

In the glow-worm, there is spread over the internal surface of the segments of the abdomen a yellowish substance of the consistence of paste, which is thickest in the middle of each segment, and terminates near each margin by a wavy outline. It is of a closer texture than the fatty matter, but otherwise resembles it. Besides this substance, the last segment is furnished internally, just beneath the most transparent part of its integument, with two small round bodies, lodged in depressions, which contain yellow matter of more close and homogeneous texture. Müller and Murray describe these round bodies as "two small ovate sacs, composed of thready membranes, and filled with a soft yellow pasty matter." Under the microscope, they appeared to Macaire to be composed of numerous branching filaments, with minute granules adhering to them. It is from points of the surface corresponding to the situation of these round bodies that the light is most constantly and most brightly emitted. When dry, these luminous organs have somewhat of the appearance of gum. The dried matter is translucent and yellowish, becomes darker on being kept, and appears to be granular in its structure. Its specific gravity is a little greater than that of water.

In the fire-fly, the internal concavities of the yellow spots of the corselet, whence the light proceeds, are filled with a soft yellow substance, oval in shape, and of very uniform consistence and density. This, under the microscope, appears to be formed of a large number of very minute parts or lobules, closely pressed together. Around these oval bodies, the fatty matter of the corselet is arranged in a radiated manner. Spix describes the same organs as "yellowish glandular masses, into which many branches of the trachea enter."

In *elater ignitus* the masses of luminous substance are extremely irregular in their figure; they are situated close to the posterior angles of the corselet, and are more loose in their structure than the same parts in *elator noctilucus*.

The luminous proboscis or snout of the *fulgora* is hollow, and has a free communication with the external air by a narrow slit situated near the base of the organ. Its cavity is lined with a fine membrane, between which and the outer translucent corneous crust, there is interposed a soft tissue of a pale reddish colour, arranged in lines longitudinally, which is supposed to be the seat of luminousness in this insect.

In several instances it has been found that the light-giving substance has continued to shine for a considerable time after being removed from the body of the insect. In such cases it has been observed that there appeared to be no diminution either in the weight or the bulk of the luminous organs, excepting what was obviously produced by evaporation of the fluids.

VI. *Geographical distribution of luminous animals.*—In almost all seas, in every latitude from 60° S. to 80° N., have light-giving animals been seen; but they are more abundant, and shine with greater brilliancy, in the tropical than in the colder climates. In general, it is observed by voyagers, the luminous mollusca and *acalephæ* occur in greatest numbers not far from land; and that they are particularly plentiful in the seas surrounding groups of small islands within the tropics.

The luminous insects are met with chiefly in the warmer climates of the temperate zones and within the tropics. We are not aware of any having been met with beyond the latitude of 58°.

VII. *Theories of animal luminousness.*—Very numerous have been the theories formed by philosophers with regard to the nature of the luminous matter which produces the phenomena now under review. From the facts stated above, it appears that we are not yet in a position to determine with certainty whether or not animal luminousness has its source in the operations of any agent already known. At least it appears to us that facts enough have been accumulated to set aside the assumption of most of the theories hitherto promulgated. The following are some of these.

1. That light is imbibed from the sun's rays by luminous animals and given out in the dark. (Beccaria, Mayer, &c.)

2. That the light is owing to a kind of combustion maintained by the oxygen of the air. (Spallanzani.)

3. That light is swallowed with the food, and disengaged by peculiar organs. (Brugnattelli.)

4. That the light-giving matter is composed of phosphorus and albumen; and that the variations in the intensity of the light depend on the more or less complete coagulation of the albumen, by some internal means placed under the control of the animal's will. (Macaire.)

5. That a fluid containing phosphorus is secreted by the luminous organs, and shines on its being exposed to the oxygen of the air introduced by respiration. (Darwin, H. Davy, Heinrich, Treviranus, and Burmeister.)

6. That the luminous organs concentrate and modify the nervous influence so as to form it into light; so that, according to this theory, animal luminousness is an effect *solely of vital power.* (Macartney and Todd.)

7. Tiedemann thus expresses his opinion: "Animal luminousness would seem to depend on a matter, the product of the changes of composition accompanying life, and, to all appearance, secreted from the mass of humours by particular organs. This liquid probably contains phosphorus or an analogous combustible substance, which combines with the oxygen of the air or of aerated water at a medium temperature, and thus produces the disengagement of light. The preparation and secretion of this substance are acts of life, which change, augment, or decrease by the influence of external stimulants, whose action on the animals modifies their manifestations of life. But the phosphorescence itself depends on the composition of the secreted matter and cannot be regarded as a vital act; because, on certain occasions, it continues for whole days and even after the death of the animal."*

This opinion seems to coincide pretty nearly with that of Darwin, Heinrich, and others, stated above (5); and we must admit that it appears to harmonize the facts better than any of the other theories that have been propounded. But, while it seems satisfactorily to assimilate many of the phenomena to others more familiar to us, and more within the reach of our investigations, and thus appears to furnish future inquirers with a key to the elucidation of what yet remains obscure, it is obvious that it leaves some of the phenomena unexplained, and that several of these seem to be quite irreconcilable with the theory of the phosphorescence being essentially dependent on the composition of secreted fluids. In some of the extremely delicate *acalephæ*, for instance, from which the brightest radiance is so frequently emitted in momentary fitful flashes, it is difficult to conceive why, if the light mainly depended on the nature of some matter poured out by certain organs at the instant of the flash, the light should not continue for at least a few seconds. The circumstance of its doing so in some instances, and even mixing gradually with the surrounding sea-water, certainly proves that there is such a fluid as this theory supposes in certain animals; but does not remove the difficulty presented by the facts we have alluded to.

We feel ourselves constrained by these and other such facts to believe (with Macartney and Todd) that in many, perhaps in all, luminous animals, both terrestrial and marine, the light emitted is the consequence of an evolu-

* Comparative Physiology, translated by Drs. Gully and Lane, i. 270.

tion of an imponderable agent by the nervous systems of the animals, just as the electrical fishes give their shock without the interposition of any visible or ponderable secretion. In this view we may regard the luminous organs as playing the same part in relation to the evolution of light as the electrical organs of the torpedo do to the production of the shock. The single fact of luminousness continuing in the organs or in their effused fluids, after they have been removed from the body of the animal, seems to point to a great difference existing between the two classes of phenomena which we have just compared, in certain animals; but it may be that the difference is more apparent than real; for this fact may be explained by supposing that a phosphoric substance really does enter into the composition of the light-giving organs; and yet we may with great probability conjecture that it is not the chief agent in causing the phenomena of luminousness. It remains, then, for future inquirers to determine the chemical composition of the luminous organs, and the fluids emitted by the animals, the phenomena of whose luminousness seem to be irreconcilable with the idea of their being dependent on the nature of these fluids; if they be found to contain phosphoric matter, it may be concluded that, as this does not appear to be essential in them to the production of the phenomena of luminousness, so neither may it be in other animals, in which it is believed to be the chief agent in the manifestation of their light-giving function.

To this theory, (which is only a combination of the two most generally received in modern times,) we do not, in the facts which have come under our notice, see any serious objection. The only argument adduced against Macartney's theory by Tiedemann and other physiologists, who have carefully considered the facts of the case, is founded on the circumstance of the light continuing, in a certain degree, for some time after the death of the animals, which, of course, cannot be supposed to be owing to the continued operations of the nervous system. This posthumous light, however, may depend on the phosphorescence of the luminous organs or their effused fluids in virtue of their composition, while the full evolution of light during life may be produced chiefly by the play of imponderable agents in and from the nervous system, independently, in some cases, of the chemistry of the fluids; in other cases, aided and modified by the nature of these and by the structure of peculiar organs.

It is scarcely necessary to take particular notice of the various other theories that have been suggested, as the facts stated in the preceding part of the article are sufficient to set them aside.

VIII. *Uses of animal luminousness.*—We know nothing certainly with regard to the uses of the light-giving function; but as almost all observers have remarked that male insects seem to be attracted towards their mates by the brilliancy of the light emitted by the latter, it

has been generally supposed that the luminousness is subservient to the generative function. Although it may be so to a certain extent, it is obviously not essentially connected with it, even in the glow-worm; for the light endures long after the season of love is past. Some have conjectured that the light may sometimes be the means of preserving its possessors from the destructive attacks of enemies. Thus Sheppard observed a large beetle running round a shining *scolopendra*, as if wishing to attack it, but seeming to be scared by the light. We may imagine, also, that the light enables its possessors to see surrounding objects at night, and so to thread their way in safety through the darkest places.

Considering that, in the ocean, there is absolute darkness at the depth of 800 or 1000 feet, at least that, at such depths, the light of the sun ceases to be transmitted, Macculloch has suggested* that, in marine animals, their luminousness may be "a substitute for the light of the sun," and may be the means of enabling them to discover one another, as well as their prey. He remarks, "It seems to be particularly brilliant in those inferior animals which, from their astonishing powers of reproduction, and from a state of feeling apparently little superior to that of vegetables, appear to have been in a great measure created for the supply and food of the more perfect kinds."

IX. *Luminousness of animals not innate, and other allied phenomena.*—We have accounts of the surface of the human body appearing luminous in consequence of phosphoric matter being largely mixed with the sweat in the course of various diseases. The urine also both of men and several of the lower animals is occasionally luminous under similar circumstances. It is said that the urine of *Viverra mephitis* and *V. putorius* is always so.†

The eyes of human albinos, almost all the mammalia which possess a *tapetum lucidum*, as also those of some birds of prey, serpents, and insects, seem to shine in a feeble light from the reflexion and concentration of the rays falling upon them from external objects. Pallas thought that this light was developed in the *retina*, and regarded it as an electrical phenomenon. But it has been plainly proved by Prevost, Gruithuisen, and Esser,‡ that the shining of the eye depends, in most cases, on reflexion of light. They found that there was no appearance of luminousness in absolute darkness; and that the eyes of dead animals gave the same effect as those of the living, when placed in similar circumstances.§

It would appear, however, from some observations made by Rengger on the eyes of a certain South American ape, (*Nyctipithecus trivirgatus*.) that there is reason to believe in

* Edin. Encycl. art. "Phosphorescence."

† Langsdorf, Reise. ii. 184.

‡ Edin. New Phil. Jour. ii. 164.

§ See also Hessenstein, de Luce ex quorundam animal. oculis prodeunte, atque de Tapeto lucido. Jenæ, 1836.

the emission of light from the eyes of some animals, independently of the reflexion of incident light. The ape in question is nocturnal. The luminousness of the eye was seen by Rengger only when there was total darkness; and then the light was so brilliant that objects at the distance of a foot and a half from the eye were distinctly seen.* In commenting on this statement by Rengger, Treviranus remarks,† "that the intensity of light may be increased by the brilliant *tapetum* of the eye, while it is concentrated as in a concave mirror, cannot be doubted. But it is impossible that a feeble light so concentrated should illuminate objects placed at the distance of a foot and a half from the eye of this ape, in a dark place." The same physiologist seems to be satisfied that some dogs also have a similar power of generating light within their eyes. In these, he states, the light is seen only when an impression on the sight or hearing arouses the animal's attention, or when he is excited by the operation of some instinct or passion.

We are, therefore, constrained to conclude that this subject is still open for elucidation by future inquirers. If it should be proved that some of the higher animals really do emit light from their eyes, independently of the incidence and reflexion of that from without, it will go far to render it probable that, in luminous animals generally, the development of light depends more upon the movements of some imponderable agent in and from their nervous system, than upon the nature of the composition of the fluids poured out by the luminous organs.

Another series of phenomena, intimately connected with, and illustrative of, those previously considered, demands notice here, namely, the shining of fishes, and other animal bodies shortly after death. The luminousness of dead fishes is a very common subject of observation, but not on that account the less worthy of particular attention. It has been ascertained that the light is given out from every part of the body, external and internal, that is exposed to the air; and that on the surface of the luminous parts there is a slight moisture, or solution of the tissues of the animal, which can be scraped off, or diffused in water, and continues luminous for a short time after being so removed. When pieces of the skin or muscle of a fish are placed in a little water, the luminousness appears only on the surface when the water is at rest; but whenever it is agitated the light is diffused through the whole body of water.

In some fishes, as the whitening, this luminousness appears within a very short time after death; in others, not for some days; but in all it ceases before the truly putrefactive process has commenced. It is observed that those fishes which most quickly putrefy, are also those which give out light the soonest.

From the circumstance mentioned above, that this luminous fluid formed on the bodies of dead fishes is miscible with water, and re-

tains its luminousness for a short time after being so mixed, it has been concluded that the beautiful phenomenon of the phosphorescence of the sea may be frequently owing to the presence, in great quantity, of the remains of fishes recently dead. It is certain that the most careful observers sometimes fail to detect any entire living animals in sea water taken up from a brilliantly luminous sea; and find only abundance of small fibres and shreds of what seem to be broken-down animal tissues. Professor Smith* concluded from his own observations made in the Atlantic, that, while the bright sparkling light of the surface of the ocean is always emitted by living animals, that duller diffused luminousness, which is frequently seen over a vast extent of the sea, giving it the appearance of milk, is given out by "a dissolved slimy matter, which spreads its light like that proceeding from phosphorus." Under the most powerful microscope, Smith saw nothing in such water but "the most minute glittering particles, having the appearance of solid spherules." Humboldt saw a great extent of the surface of the sea rendered almost gelatinous by the admixture of numbers of dead *dagysæ* and *medusæ*.

It may, therefore, be regarded as probable, at least, that the luminousness of the ocean is sometimes caused by dead matter; but it is certain that, in the great majority of instances, it is entirely owing to the presence of living animals, possessed of the light-giving property.† In attempting to examine these, so as to determine their forms and habits, it is important to keep in mind that they are sometimes extremely small, so as to be distinguished with considerable difficulty, even with the aid of the best microscopes. And when they are larger, they are frequently so transparent as to elude notice.

BIBLIOGRAPHY.—Canton, Phil. Trans. 1769. 446. Macartney, Phil. Trans. 1810. 2. Spallanzani, Mem. della Soc. Ital. vii. 271. Macaire, Mem. sur les Lampyres, in Jour. de Physique, xciii. 46. Humboldt, Reise i. 109. Todd, Journal of Science, 1826. 241. Murray, Experimental researches, 1826. Kirby and Spence, Intro. to entomol. ii. 256. Quoy and Gaimard, Ann. des Sc. Nat. iv. 1. Tiedemann, Comp. physiol. i. 257. Macculloch, Phosphorescence, in Edin. Encycl. xvi. 1823. Burmeister, Manual of entomol. by Shuckhard, 494. Muller, Physiology, by Baly, vol. i. ed. 2, 1839.

LUNG.—See PULMONARY ORGANS.

LYMPHATIC AND LACTEAL SYSTEM.—(Fr. *Système lymphatique*; Germ. *Saugadersystem* oder *Lymphgefäßsystem*.)

* Tuckey's Voyage, 258.

† Martin, Canton, Hulme, and others supposed the luminousness of the sea to be caused by a phosphorescent oil, generated during the putrefaction of animals. Silberschlag regarded it as phosphoric. Mayer, Beccaria, Monti, Brugnatelli, and others, believed it to be owing to the giving out of light imbibed from the sun's rays. Bajon, Delaperriere, and Gentil imputed it to electrical agency, because it is excited by friction. Foster supposed it to be sometimes electric, and sometimes putrefactive.

* Rengger's Naturgesch. der Saugthiere von Paraguay, s. 393.

† Biologie, i. 439.

Syn. *Absorbent system.*)—The lymphatic system is composed, in the first place, of the vessels which collect and convey the lymph from all parts of the body and the chyle from the intestines, and ultimately deposit them in the veins. Secondly, of the small fleshy bodies called conglobate, lymphatic, or absorbent glands, which are found connected with this system of vessels in various parts of their course.

The lymphatic system is confined to the class Vertebrata. It is the least complicated in Fishes, and consists in them simply of pellucid valveless vessels. In Reptiles, also, it is composed of these vessels only, but which are armed with more or less perfect valves. In the two higher orders of Vertebrata, Birds and Mammalia, to the vessels containing very numerous and perfect valves, the conglobate glands are superadded: in all, however, the termination of the system is in the veins, and its origin and general arrangements are probably in all essentially the same.

The different parts of the lymphatic system had escaped the notice of anatomists until the middle of the sixteenth century, and the entire system was not discovered till the middle of the seventeenth. I must here except the lymphatic glands, which from their large size must have been observed by the earliest anatomists, and we accordingly find them alluded to by Hippocrates, who classed them with the other glandular organs.

The first isolated discovery in the vascular part of this system was made by Eustachius in 1563, who saw and described accurately the thoracic duct in a horse. He called it the *vena alba thoracis*, and traced it downwards from the left subclavian vein to the lumbar vertebra, where he noticed the dilatation now called the receptaculum chyli; he however had no conception that it formed the trunk of a separate system of vessels, but conceived it to be a vein of a peculiar kind. Fifty-nine years afterwards, in the year 1622, Asellius was fortunate enough to discover the lacteal vessels on the mesentery of a dog; and although on the following day he was much disappointed in not being able to see them in another dog inspected for the purpose, by continuing his researches he soon convinced himself of their existence in most animals. He also attributed to them their proper function, having remarked that whenever there was chyle in the intestines, these vessels also contained a white fluid, and could then only be seen. He failed, however, to connect the *vena alba thoracis*, the discovery of Eustachius, which had probably been forgotten, with his own, and mistaking the lymphatics of the under surface of the liver for the continuation of his vessels, was led into the error of supposing them to terminate in the liver. Asellius, who died in 1626, had not seen the lacteals in man, but inferred and asserted their existence. According to Haller, Veslingius was the first who saw these vessels in the human subject, in the year 1634; but Breschet informs us, in his *Système Lymphatique*, page 4, that, “en 1628, les lymphati-

ques du mésentère furent aperçus pour la première fois chez l'homme. Peiresc, Sénateur d'Aix, informé par Gassendi de la découverte qu'avait faite Aselli, distribua plusieurs exemplaires de l'ouvrage de ce professeur aux médecins de sa connaissance, et leur abandonna un criminel condamné à mort, pour vérifier le fait sur son cadavre. On fit bien manger cet homme avant de le conduire au supplice, et une heure et demie après sa mort, l'ouverture du bas ventre montra le mésentère tout couvert de vaisseaux lactés pleins de chyle.”

The thoracic duct was rediscovered in the year 1649, by Pecquet, who published a description of it in 1651. Haller ascribes this discovery to Veslingius: “Ideo Veslingius, nisi plurimum fallor, primus post Eustachium, contra omnes cœtaneos, relictus anno 1649, vidit vas lacteum grande, in pectus ascendere; cum reliqui incisores, partim ab Asellio persuasi, et partim a lymphaticis vasis hepatis ducti, chylicos ductus ad hepar ducerent.”

It now became evident that the thoracic duct was the trunk of the *vasa lactea*, and that the chyle was not conveyed to the liver, as Asellius supposed, but was poured into the venous system at the union of the subclavian and internal jugular veins of the left side. The lymphatics of the under surface of the liver were soon after shewn by Glisson and Veslingius to have their valves so arranged as to convey their contents from, and not to this organ.

In the two or three following years the rest of the lymphatic system was discovered by Rudbeck in Sweden, by Bartholin in Denmark, and by Jolyffe in this country; nor was it long before the function of absorption was ascribed to it by Glisson, in 1654, and by Hoffmann. Since this period, we have been indebted for various details of the arrangement of this system of vessels in man and other Mammalia, in Birds, in Reptiles, and Fishes, to numerous investigators, Nuck, Ruysch, Albinus, Meckel, Hunter, Monro, Hewson, Cruickshank, Sæmmerring, Mascagni; and in the present day to Fohmann, Lauth, Lippi, Rossi, Panizza, and other continental anatomists.

The lymphatic vessels in the human subject are exceedingly delicate and transparent tubes, numerous but small, existing in most if not in every part of the organism, crowded with valves, and terminating, after passing through the glandular bodies, in two principal trunks, through which the contents of the whole system are emptied into the circulating venous blood at two corresponding points not far distant from the heart, viz. at or close to the angles of union between the subclavian and internal jugular veins. The two trunks of the lymphatic system are by no means symmetrical. That which enters the veins on the left side measures as much as sixteen or eighteen inches in length in the adult human subject. It commences in the abdominal cavity by a slightly marked dilatation, the *receptaculum chyli*, into which the chyloferous vessels pour their contents; it then passes through the thorax to reach its termination in the neck. This trunk is usually termed the *thoracic duct*; it may

be said to receive the lymph of three-fourths of the body, together with the whole of the chyle. The right lymphatic trunk is about two lines in diameter, very short, corresponding in situation and length to the last half-inch of the left trunk; consequently it will only be found at the root of the neck, close to the point of its termination. This trunk receives the remaining fourth of the lymph, viz. that collected from the right upper fourth of the body. Professor Lippi published a work on the lymphatic system in the year 1825, in which he described in the human subject many terminations of the lymphatics in other parts of the venous system, especially in the vena cava inferior, the vena portæ, and the principal branches by which these vessels are formed, but subsequent observers have not corroborated his views. The vessels which Professor Lippi saw joining other large venous trunks were evidently the returning veins of the conglobate glands, into which the injection received by the lymphatics had passed during its transit through the glands:—a fact of extreme interest, and to which we must recur in speaking of the structure of the glands, but which has been observed by every anatomist who has had much practical experience in injecting the lymphatic system. Lippi would have been perfectly correct, however, had he confined his statement to what takes place in Birds, Reptiles, and Fishes.

The lymphatic vessels resemble the veins in possessing valves, and in conveying their contents from branch to trunk; moreover their internal tunics are continuous where the one set of vessels joins the other. In their mode of distribution also throughout the body the analogy between the two systems is considerable. Eustachius, when he first saw the principal trunk of the lymphatics, from its being filled with chyle, at once described it under the name of the vena alba thoracis, and many have considered the lymphatic vessels as an appendage to the venous system, rendering it more perfect. Although we are warranted in saying that the lymphatic vessels convey their contents from branch to trunk, by which is generally understood from smaller and more numerous to larger and less numerous vessels, as is the case with the veins; yet is there another principle apparently of an opposite kind observed in their distribution, by which the influence of capillary attraction is engaged in the important service of moving onward their contents, at the same time that these are exposed to a larger surface of the containing vessels, from which in all probability they derive some essential modification. This admirable and simple provision is especially evident in the lower extremities, where the greatest resistance from gravity is to be overcome. A vessel on the instep, for instance, of half a line in diameter, instead of emptying itself into a larger one as it proceeds upwards, bifurcates into vessels of equal diameter with itself; each of these again will in a similar manner subdivide, until at length by a series of dichotomous divisions, although some reunions may take place, this single vessel has multiplied

itself by the time it reaches the inguinal region into as many as fifteen or more branches, each of the same diameter or nearly so as the original branch on the instep. Indeed, throughout the lymphatic system, we scarcely find a branch of more than an inch in length whose diameter is not within the range requisite for the production of capillary attraction. The thoracic duct itself, which is two or three lines in diameter, may be said to form an exception, but the onward progress of its contents is specially provided for by its juxtaposition to the aorta, from which circumstance it is subjected during life to an alternating pressure of considerable force, and fully competent in a vessel provided with valves to ensure the advance of its contents.

The principal lymphatics in any part of the body may be said, taken collectively, to equal the capacity of the arteries or veins of the same part; thus, in the inguinal region the sum of the diameters of the lymphatic vessels may equal the diameter of the main channel by which the venous blood is returned from the lower extremity; but by this simple subdivision of the outlet for the lymph into numerous branches, that almost universal, and, in its effects, wonderful power, by which the nutrient fluid throughout the vegetable creation is carried from the lowest fibril of the root to the highest living point in vegetable existence, is made available in the progression of the lymph in animals towards the centres of the system. This disposition of the lymphatic vessels throughout their course necessitates a greater uniformity in point of size, than we find to hold good with the artery or vein, and indeed constitutes their chief peculiarity in distribution when compared with the other divisions of the vascular system. The arborescent appearance, except on the surface of the liver and spleen, is scarcely to be met with in the lymphatics; they almost always form a net-work of vessels, the meshes of which vary both in form and size in the different organs and in different parts of the body; as a general rule, when the vessels have a short course to run, the spaces they enclose are small and more nearly equilateral; but when the contrary is the case, as occurs in the extremities, the meshes are very large and much elongated, so that the vessels run nearly parallel with each other, and the net-work arrangement is scarcely perceptible; there is, however, still less appearance of arborescence.

In this respect the lymphatics may be said to resemble more the capillary bloodvessels, which in the web of the frog's foot, or in the vesicular lungs of the salamander, toad, or frog, are so plainly seen to form a net-work of nearly equal-sized vessels, and, indeed, to cease to be capillaries when they become arborescent.

Another peculiarity in the disposition of the lymphatic vessels occurs at their approach to a conglobate gland, through which their contents are to be conveyed. The vessels leading to a gland which are termed the *vasa inferentia* or *afferentia* of the gland, vary in number, being seldom less than two, and rarely amounting to

more than five or six. They maintain their ordinary size and appearance to within a quarter of an inch of the gland, where they suddenly branch out, artery-like, into several exceedingly minute vessels which plunge into the gland, thus conveying the lymph, in a minutely divided state through this organ to emerge again from it by a converse arrangement of equally small vessels, which at a quarter of an inch from the gland, are collected like so many small veins into one or more trunks, called the *vasa efferentia* of the gland; not unfrequently there is but one of these vessels passing from a gland, and rarely more than two or three; they are, however, generally larger than the *vasa inferentia*, and often double their size. (Fig. 52.) A similar arrangement in the bloodvessels before entering or passing from their appropriate glandular organs may be noticed in the spleen and kidney, but the only instance in which a bloodvessel collecting its contents from branches assumes the opposite function of distributing them into narrow streams occurs in the *vena porta*, where the blood is to be passed through the liver to be subjected to its action. The same object, it is true, is effected at the heart with the blood of the *venæ cavæ*, together with the lymph and chyle, when conveyed in capillary streams through the lungs to be converted into arterial blood; the right side of the heart, however, here intervenes between the collecting vessels and those which have to redistribute the blood; the latter also are called arteries though they convey the same venous blood to the lungs which the former vessels brought to the heart.

The *vasa inferentia* are by most authors described as entering that edge of the gland which is farthest removed from the trunks of the system, and the *vasa efferentia* that nearest to them. This I find not to be the case; the vessels usually plunge into and emerge from the broadest surfaces of the gland; sometimes it is the deeper surface, sometimes the more superficial, and frequently both. The *vasa inferentia* may enter one surface, and the *vasa efferentia* pass from the same or the opposite surface of the gland. The *vasa efferentia*, as they proceed onward, become the *vasa inferentia* of succeeding glands; thus the lymph is often made to traverse several glands before it is received by the trunks of the system. This is so much the case in the neighbourhood of the thoracic duct, especially in the pelvic and abdominal cavities, that the lymphatic system assumes altogether a different aspect; the network appearance, the uniformity in point of size, are lost sight of in the numerous large short *vasa efferentia* and *inferentia*, intervening between the closely set glands. The appropriate lymphatic vessels of the viscera and walls of these cavities, nevertheless maintain the ordinary disposition, the apparent irregularity depending upon the circumstance, that the large lymphatics of the lower extremities, are interrupted by numerous glands in their passage to the thoracic duct.

The lymphatic vessels are distributed throughout the body on two planes, one superficial, the

other deeply seated. The vessels of the two planes where they approach each other communicate freely. A similar arrangement takes place partially in the venous system; and it is interesting to remark that where this occurs, the veins, like the lymphatics, are armed with valves. We cannot fail to recognize here a double provision to facilitate the progress of the contents of a vessel towards their proper destination; while the valves prevent effectually any retrograde movement, the double plane of vessels, by increasing the number of channels, lessens the liability to arrest from the various causes of obstruction. The superficial lymphatics accompany more or less the superficial veins where these occur, but in other parts of the body they assume various appearances peculiar to each viscus or organ; the superficial lymphatics, of the liver, spleen, kidney, and lungs, for instance, differ materially from each other in arrangement and appearance. The deep-seated lymphatics every where follow the course of the large bloodvessels. They are fewer in number and perhaps rather larger than the superficial. The superficial and deep lymphatics communicate with each other in the lymphatic glands as well as in different parts of their course.

The chief peculiarity of the coats of the lymphatic vessels is their remarkable thinness and transparency; in other respects they bear considerable resemblance to the coats of the veins; indeed in some of the lower animals the veins are nearly as thin, and when empty of blood, as transparent as the lymphatics. All anatomists admit the existence of two coats in the lymphatics, an internal serous lining, which at intervals is thrown into folds to form the valves, and an external thicker fibrous covering; to these is added by some anatomists, with whom I am disposed to coincide, a third, analogous to the cellular tunic of the bloodvessels, which conveys to them their *vasa vasorum*, and by which they are connected to the surrounding structures.

The inner tunic is extremely fine and delicate, probably less elastic and extensible than is generally imagined, and is the first to give way under distention from forced injections. It appears to possess a much closer texture than the fibrous tunic, to which it is firmly adherent, and whose contractions and dilatations it is compelled to follow. The epithelium scales are distinguished with difficulty on the inner surface of this tunic, but I have satisfied myself of their existence. On placing an opened lymphatic in the field of the microscope after the bloodvessels have been minutely injected, the *vasa vasorum* may be very distinctly seen; but it is difficult, from the perfect transparency of this tunic, to say whether these vessels reach it, or are only seen through it. The *vasa vasorum* of the lymphatics do not appear to affect any constant or fixed arrangement; they are by no means numerous, and I have never been able to detect any on the valvular folds.

The fibrous tunic, like the internal, is transparent; it is very elastic, and admits of considerable distention without rupture. There is

great variety of opinion with respect to the nature of its tissue. Breschet and many other anatomists describe this tunic as resembling the cellular coat of the bloodvessels, and are under the impression that the lymphatics are altogether deficient in that which is analogous to the middle or fibrous coat of the arteries and veins. Mascagni and Rudophi have not been able to detect muscular fibres in it. Cruveilhier conceives it to be composed of the *tissu jaune elastique*, or *tissu dartoide*. Schreger thinks he has seen circular muscular fibres in the thoracic duct of man and of large animals, and Sheldon states that he has distinctly seen muscular fibres in the thoracic duct of the horse. By placing a portion of the thoracic duct or large lymphatic laid open with the lining membrane uppermost, on a piece of glass, and by scraping off the internal membrane, the fibrous tunic will be exposed; if it be now moistened with a drop of water, and a piece of talc placed over it, it may be readily examined under the microscope. I have several times examined portions of the thoracic duct and of the larger lymphatics taken from the horse, and from the human subject, and have invariably found the tunic exposed on removing the lining membrane, to be composed of fibres passing principally in the longitudinal direction; these fibres are uniform and cylindrical, and resemble in these respects the organic muscular fibre as described by Schwann; they lie for the most part parallel with each other, and are occasionally seen to form a large fasciculus, somewhat analogous to the longitudinal muscular bands of the large intestine. These fibres measure from 1-5000th to 1-6000th of an inch in diameter, and present at intervals, a sudden zigzag inflection; several fibres collected together into a sort of primitive fasciculus are bent together at the same points. These abrupt deviations from the straight line do not occur at equidistant points; the intervals between them differ greatly; they average 1-400th of an inch in length. Under the lining membrane some few fibres may be distinguished taking a transverse course, others may be seen in an oblique direction, but the great majority are arranged longitudinally. The primitive fibre of cellular tissue is freely mixed with the peculiar fibres just described. The physiological fact that the lymphatics have the power of contracting and emptying themselves of their contents, has not been disputed; but with respect to the nature and form of the fibre in virtue of which they possess this faculty, there has been and still exists great uncertainty. No one can have examined the lacteal or lymphatic vessels in a recently killed animal without having observed the rapidity with which this system will empty itself of the fluid it contains; and if the trunk of the system be ligatured, it will be found that this power remains for an hour or more after death, as may be proved by puncturing the duct within this period below the ligature, or by puncturing a distended lymphatic, which will be instantly evacuated of its contents, and will refill again and again when pressure is made below the orifice.

Lymph hearts.—I must not here omit to allude to the

lacteal system, discovered by Müller in frogs, toads, salamanders, and lizards, and by Panizza in serpents. In frogs, Müller describes two pairs, one situated just under the skin in the ischiadic region, the other more deeply seated over the third cervical vertebra. Their pulsations he describes as about 60 in a minute and not synchronous with those of the heart. The lower pair propel the lymph into the ischiadic vein; the upper, into the internal jugular.* I have seen these transparent pulsating bodies in the frog, where they may be easily exposed by removing the skin from either side of the rudimentary tail, but have not examined them sufficiently to pass any opinion upon them.

External to the fibrous tunic is situated a delicate and loose cellular tissue, which performs the same offices for the lymphatic, which the cellular tunic does for the artery and vein, viz. it conveys to it the *vasa vasorum* for its nutrition, and connects it to the surrounding tissues. The supply of nerve to the lymphatic has not hitherto been detected; there can however be no doubt but that it possesses its proper degree of sensibility, and its contractile power is in all probability regulated by nerve.

Fig. 47.



a and b, lymphatics laid open longitudinally to shew the arrangement of the valves in their interiors. (After Breschet.)

The valves of the lymphatics resemble in their mode of formation and in their appearance the same structures in the veins; they are however more frequent and more universal in the lymphatic system; indeed, in the more perfect animals they are found every where except in the incipient networks of this system. It has already been stated that in fishes and in some amphibious animals the lymphatic system is either entirely deficient in valves, or is only supplied with them in a partially developed state. The valve is composed of two semi-lunar flaps, so arranged that the reflux of the fluid within, forces them away from the sides of the vessel towards its centre, where the two flaps meet and completely close it, while the fluid passing in its proper direction

* Professor Weber has described one of these hearts in a large serpent, the *python bivittatus*. It measured nine lines in length, and four in breadth; it had an external cellular, a middle muscular, and an internal serous tunic. See *Phil. Trans* 1833, Müller's *Archiv.* for 1835, and *Valentin's Repertorium*, Bd. 1, p. 294. [Müller has subsequently described similar lymphatic hearts in the Chelonian Reptiles. *Archiv.* 1840, p. 1-4.—ED.]

simply presses the flaps back against the sides of the vessel, and thus no obstruction is offered to its onward course. The flap of a valve consists of a fold of the inner coat of the vessel, which, where a valve is to be formed, ceases to

Fig. 48.



a, b, and c, lymphatic vessels inverted, giving three different views of the valves formed by the lining membrane. (After Breschet.)

line the vessel, and is reflected towards its interior; having reached half-way across, it is doubled upon itself, and returns to the side of the vessel, which it continues to line as if it had never been interrupted. The two layers of this fold adhere very firmly together so as to form a very delicate transparent semilunar flap. It presents a convex attached, and a straight or slightly concave unattached edge; the former corresponds to a semilunar line on the interior of the vessel, the horns of which look towards the trunks of the system, where the lining membrane was reflected from and returned to the side of the vessel; the latter to the line of doubling

Fig. 49.



a, a front view of a valvular flap. b, a profile view of a lymphatic vessel and valvular flap; the lower half of the flap, or that nearest the base, is represented thicker than the rest. According to Lauth and Breschet, this thicker portion is formed of all the coats of the vessels; the thinner portion, of the lining membrane only. (From Breschet.)

of the membrane upon itself; thus a little pouch is formed between the flap and the side of the vessel, which can only be filled by the fluid passing in one direction; and as a valve is constituted of two such pouches, when they are filled the vessel is completely closed. Some anatomists conceive that a lamina of fibrous tissue intervenes between the layers of the fold. Breschet, in his "Système Lymphatique," adopts Lauth's view of the structure of the valve. He describes the flap of a valve as composed of two parts, one thicker and situated at the base of the fold, the other forming the rest of the flap more thin and delicate. It is this latter part which he conceives is formed by

a doubling of the lining membrane only, while the thicker part, near the base, he has assured himself is produced by a prolongation which the fibrous coat sends inwards between the folds of the inner tunic. I have not been able to verify this description of the structure of the valve, but I have distinctly observed circular constrictions in the more bead-like lymphatics seen in the neighbourhood of some of the lymphatic glands, into the formation of which the fibrous coat does appear to enter. On laying open one of these vessels previously distended with quicksilver and dried, opposite the external constrictions, which were numerous, and not more than a line apart, valvular folds, differing from those hitherto described, were seen to project into the interior of the vessel; they did not completely close its cavity, but left a circular or oval opening, through which the contents of the vessel might pass in either direction. These valvular constrictions resembled much the dried pyloric valve (*fig. 50, B*); and I am inclined to believe, from their thickness, that they contain circular fibres derived from the middle coat, by which during life they may be able to close their vessels as perfectly as the pyloric valve closes the communication between the stomach and duodenum. In very many places there occur two semilunar folds (*fig. 50, A*), apparently formed of the lining membrane only, like the flaps of the ordinary valves, from which they differ, however, in having their attached and unattached edges, as well as the flaps themselves, on the same plane, consequently not forming pouches, but a transverse though incomplete septum across the vessel. Each of these flaps extends only one-third across the vessel, and terminates by a crescentic edge, by which arrangement an elliptical opening is left in the central third of the vessel, between the two folds. This form of valve would appear to offer a partial obstruction to the passage of the lymph in either direction, as no provision is manifest by which these flaps would be made to fall against the sides of the vessel, either by the onward or retrograde course of its contents. I have frequently noticed a combination of the circular constriction with the semilunar flaps here described (*fig. 50, C*), by which mechanism, supposing the former to be endowed with a vital contractility, the latter might be brought in contact, so as completely to close the elliptical opening that would otherwise be left in the centre of the vessel.

At the entrance of the lateral branches into the thoracic duct, or of one lymphatic into another, a valve will be found, of a somewhat different form to those already described. It is composed of two semilunar flaps, seldom of equal size, arranged somewhat like the ilio-cæcal valve. One flap is occasionally so slightly developed that there appears but one large semilunar fold at the entrance of the vessel. At the union of some of these vessels with others, especially of those which lie nearly parallel with each other, no valve will be found, but simply a defined curved line, marking the orifice of communication. The valves in the lymphatic system are very closely set together. The distance between them varies much. In vessels of a line

Fig. 50.

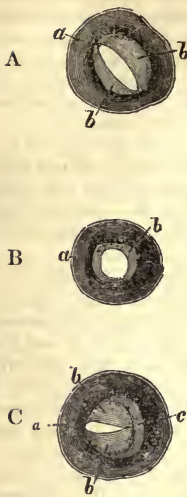

Exhibits three forms of valves of very frequent occurrence in the lymphatics, especially in the neighbourhood of glands, and which are not described in works on Anatomy. (Taken from specimens prepared for the microscope.) Magnified ten diameters.

A. *a*, the interior of the vessel. *b, b*, the valvular flaps composed of the lining membrane only. The attached, the unattached edges, as well as the surface of these flaps, are on the same plane; they do not perfectly close the vessel.

B. *a*, the interior of the vessel. *b*, the valvular flap of a circular form, resembling the dried pyloric valve of the stomach; apparently composed of the fibrous as well as the inner tunic.

C represents a combination of the two former. *a*, the interior of the vessel. *b*, valvular flaps resembling those of A. *c*, a third fold resembling the circular fold of B.

in diameter they are frequently not more than a line apart, while in others of half that magnitude there may be an interval of an inch between them. It has been observed that they are more frequent and closer together in the larger lymphatics than in the smaller; this is not always the case; for instance, the lymphatics of the upper extremity, which are much smaller than those of the lower, have less intervals between their valves; and in the neck, where the vessels are still smaller, the valves are less distant apart. It appears to me that the valves are much more approximated to each other in the neighbourhood of the glands, and this observation applies to the vasa afferentia as well as to the vasa efferentia, but especially to the latter; from which circumstance the notion may have arisen, that the valves are more frequent the larger the vessel. The valves recur less frequently in the thoracic duct than in any other part of the system. It is not uncommon to find in this vessel an interval of two or three inches in extent without a valvular fold.

Mode of origin of the lymphatics.—The plan I have hitherto adopted in describing the lymphatic vessels has been to present to the reader, first, that which is most readily

understood, because easily recognizable by our senses, and about which there could be little difference of opinion; but I have now to direct attention to a part of our subject which has hitherto baffled the efforts of all inquirers, viz. the mode of origin of the lymphatic vessels, concerning which the sight, aided by the most powerful glasses, has failed to supply us with satisfactory and demonstrable information. The numerous opinions and conjectures on this subject, only present us with so many instances, of the vain struggles of the human mind, to advance in a strict science of observation, beyond the limits assigned to our senses, and of the unwillingness, even in the philosopher and man of science, to acknowledge the weakness and limited range of his faculties.

When we consider the transparency of the coats of the lymphatic vessels, as well as of their contents, the small size of their secondary branches, and the numerous valves they every where present, we cannot feel surprised that their precise origin should be involved in much obscurity. From the opaque nature of the chyle, it might be imagined that while the vessels were distended with this fluid, the anatomist would be enabled to trace them to their commencing branches, but unfortunately, it is almost impossible to prevent the onward motion of the chyle in the vessels first receiving it, while the valves offer a complete barrier to any retrograde movement. Added to which, the opacity of the coats of the intestine renders it extremely difficult to follow these vessels from the peritoneal surface of the outer, to the villous surface of the inner tunic, even when distended with chyle. Transparency of the coats of the intestine may be obtained by drying, but the chyle becomes transparent at the same time. Various modes of investigation have been adopted by anatomists to overcome these difficulties, the principal of which it may be necessary here to mention. Injections of quicksilver or coloured fluids have been thrown into the arteries, by which means the injection has occasionally made its appearance in the lymphatic vessels: this result occurs, according to Panizza, in a particular organ in an animal of one species, while in another the experiment will succeed, not in the same, but in some other organ. Thus he succeeded in filling the lymphatics from the arteries, in the intestines of the dog and pig; in the liver of man, the horse, and dog; in the testicle of the dog and bull; in the penis and spleen of the horse. He was unsuccessful in the intestines of man, the horse, birds, the salamander, and the tortoise; in the liver of reptiles; in the spleen of man, the dog, and the pig; in the kidneys of mammalia and birds; in the penis of man and the dog.

Breschet is of opinion that injections by the veins pass more readily into the lymphatic system. I have now in my possession two preparations where the lymphatics have been accidentally injected from the veins; one in the mesentery of the turtle, the other in the kidney of man; and I have undoubtedly observed this occurrence much more frequently after in-

jections by the veins than by the arteries. Every anatomist who has had much experience in injecting the lymphatic vessels has been incommodated by the injection passing unexpectedly into some large vein, and on looking for the communication, he has found the veins from a lymphatic gland conveying the injection into one of the nearest large venous trunks. This has occurred to me frequently in the human subject, where the common iliac veins and the cava inferior have received the quicksilver from the veins of the neighbouring lymphatic glands. I have also seen the same occurrence lately in the horse, and have the specimen shewing the fact now in my museum. It was these veins conveying the injection from the lymphatics into the venous trunks, which Lippi mistook for the vasa efferentia of the glands, and which induced him to publish his work describing many terminations to the lymphatic system in mammalia, hitherto unknown to anatomists. This error was the more excusable, inasmuch as his opinion appeared to be confirmed on the investigation being pursued by himself and others in the remaining classes of vertebrate animals, where various communications do actually take place between the lymphatic trunks and the veins.

Coloured fluids have been thrown into the cavity of the pleura and peritoneum in living animals for the purpose of bringing the lymphatic vessels into view, and of tracing if possible their extreme branches after absorption had taken place. In this way it is said that minute vessels anastomosing with each other, and forming a delicate net-work, may be made apparent on the surface of the serous membrane, and that the trunks of the neighbouring lymphatics may be seen filled with the coloured fluid. In post-mortem examinations also, the absorbent vessels have been observed distended with a fluid of a yellow or red colour, where effusions of pus or blood had taken place during life. In all these instances we probably first notice the injection in the larger lymphatic vessels which are easily recognized by their numerous valves, and on tracing these back to their commencing branches we only discover an intricate net-work of minute vessels apparently continuous with each other. It is exceedingly difficult to distinguish these from equally small branches of artery and vein, filled probably with the same coloured injection. You look in vain for the channel by which the injection has entered these vessels; no continuity of lymphatic with the minute twigs of the other sets of vessels can be detected; no open orifice belonging to either can be distinguished. Many anatomists have endeavoured to fill the commencing branches of the lymphatic system by forcing the injection, thrown into them, in a retrograde direction, and in fishes where there are no valves, with the effect of shewing very numerous lymphatic vessels destitute of orifices, but not so universally distributed as has been imagined.

Fohmann, Breschet, and others have simply made a puncture in the tissues, and by forcing quicksilver into the wound, have occasionally

succeeded in filling a minute net-work of lymphatics. Cruickshank and Hewson employed ligatures to the thoracic duct, to the larger lymphatics, or simply round the limb immediately previous or subsequent to the death of the animal, for the purpose of distending the radicles of the system. Lastly, the microscope has been had recourse to by most observers. But the prevailing physiological opinions of the day have had more influence than all our anatomical investigations in determining our notions of the mode of origin of the lymphatic vessels. Indeed, so much has this been the case, that I shall find it convenient, in treating the subject of the origin of these vessels, to refer to the physiological views of the periods during which the successive opinions have been broached. The only other observation I shall make on entering upon this difficult and still obscure subject is, that the chyle seen on the coats of the intestine, contained in its proper vessels, so near to the villous tunic, has tempted anatomists to confine their observations perhaps too much to this one-absorbing surface, with the fixed intention of applying the information thus gained, to the whole system; whereas the fluid contained in the chyloferous vessels differs so much from that of the rest of the system, that it is not very improbable that the former which admit particles of matter should possess orifices, while the latter should receive its contents by imbibition without perceptible orifices, which, in fact, is the opinion held by two eminent physiologists, who have paid considerable attention to the subject, Magendie and Cruveilhier. The first opinion with respect to the mode of origin of the lymphatic vessels which I shall consider is that by open orifices.

Many investigators at various periods have attributed open orifices to the radicles of the lymphatic vessels; indeed, this has been the prevailing opinion till within the last few years. Asellius, the discoverer of that part of the system which is connected with the intestines, imagined that his "vasa lactea" commenced by open mouths from the interior of the intestine. His words are, "ad intestina instar hiant spongiosis capitulis." The first discoverers of the rest of the system, the "vasa lymphatica," did not attribute to them the function of absorption, but regarded them as destined to assist the veins in returning the circulating fluids to the heart. They supposed them, therefore, to be continuous with those arteries which admitted a colourless fluid only, while the veins in a similar way received their contents from the arteries conveying the red blood. The lymphatics properly so called were not considered to possess open orifices at their origin, until they were generally recognized as sharing with the lacteals, the important office of absorbing fluids, as well as conveying them towards the heart. It was not fairly established until the time of the Hunters, that these vessels formed part of the absorbent system, although Glisson and Hoffmann had expressed their opinion to this effect, a few years after the discovery of the lymphatic vessels. But to do justice to this part of our subject, it will be

necessary to enter more fully into the Hunterian theory of absorption.

The Hunters, Monro, and their followers Cruickshank, Hewson, and Sheldon, conceived that the lacteals and lymphatics formed one great system of vessels by which alone absorption was effected in the living body, either for the purpose of collecting new materials, or for the removal of the old; consequently, that these vessels were essential agents in the growth and habitual nutrition of the structures;—that whenever any of the solid or fluid components of the body, whether of a healthy or morbid character, disappeared, their removal was effected by the lymphatic vessels; this included the ulcerative process, which they considered as exclusively carried on by these vessels. Many ingenious experiments were performed to disprove absorption by the veins. Fluids of various colours impregnated with musk and other odours were thrown into the intestines of living animals, and were afterwards detected in the lacteals, but not in the veins, and imbibition was considered impossible in the living structures. These views were generally received throughout Europe, and have been acquiesced in almost to the present day. Our phraseology, written or oral, whether in reference to Pathology, Physiology, or Anatomy, is evidently still imbued with them. This theory of the functions of the lymphatic system necessitated a corresponding anatomical disposition in the mode of origin, as well as in the general arrangement of these vessels. They were required to be universal for the purposes of growth and nutrition; wherever there was the artery to deposit, there must be lymphatic to absorb; and as imbibition was inadmissible, they were endowed, as a matter of necessity, with open mouths, by which they were said to commence from all serous and from all mucous surfaces, including the interior of all the visceral cavities, the serous linings of the arteries, veins, and even of the lymphatics themselves, the synovial surfaces of the joints; the surface of the skin, the mucous linings of the alimentary canal, of the aerial, urinary, and other passages, of the excretory ducts, and from the interstitial cellular tissue of the whole organism. It was admitted that the orifices of the lymphatic vessels could not be shewn; that they eluded our senses by their transparency and extreme minuteness; but on the villi of the intestine, the commencing lacteals were supposed to be detected, turgid with chyle, and their mode of origin by patent orifices was described by more than one anatomist. An analogous arrangement at their commencement was adjudged to the lymphatics, without any further investigation directed specially to these vessels. Cruickshank thus describes the appearance of the supposed lacteal orifices on the villi, seen in a female who died suddenly seven or eight hours after a full meal. "In some hundred villi, I saw a trunk of a lacteal forming or beginning by radiated branches. The orifices of these radii were very distinct on the surface of the villus, as well as the radii them-

selves, seen through the external surface passing into the trunk of the lacteal; they were full of a white fluid. There was but one of these trunks in each villus." He states also that Dr. Hunter examined them under the microscope, and counted as many as fifteen to twenty orifices to each villus. According to Lieberkuhn, the lacteal commences on the apex of each villus by one or more orifices leading to an ampullula situated near the apex of the villus, from whence one lacteal branch proceeds through the centre to the base of the villus. The ampullula, he states, is lined by a spongy cellular tissue, which he conceives is subservient to absorption. With respect to the orifices, his words are: "*Quod autem unum saltem adsit foraminulum in cujusvis ampullulæ apice, certo examine mihi constat: interdum tamen, licet rarissime, plura ut in papillis mammarum, vidisse memini.*" Sheldon admits Lieberkuhn's description of the orifice of the lacteal vessel, and of the ampullated appearance of its commencement from the villus; but it appears to me, on looking at Sheldon's plates, and reading his description of the ampullulæ, that he as well as Lieberkuhn, whose plates he has copied, have mistaken the mucous follicles of the intestines for the ampullated villi. Speaking of the ampullulæ, Sheldon says, "I have seen them of different forms, most commonly bulbous, as represented by Lieberkuhn. I have also seen a number of ampullulæ filled with chyle, sometimes forming clusters, as represented in plate I., while in other parts of the small intestines I have found them solitary, and projecting beyond the villi, as may be seen in several of the figures in plate I." Hewson has seen a network of lacteals as well as of bloodvessels on the villus, but no ampullulæ; he states that the orifices of the lacteals can only be discerned when the villus is rendered turgid and erect by the fullness of the bloodvessels. In reference to these orifices, he says: "It might be here objected that these were only lacerations of the villi, but I am persuaded they were not, from having, on repeatedly examining them, observed the pores or orifices very distinct and empty; whereas, were they lacerations, I think I should have seen the injection in them, as the villi were so much injected by it." These are the data upon which has been founded the opinion that the lacteals and lymphatics arise every where by open mouths. I have myself examined under the microscope the villi of various animals destroyed at different periods after a meal, for the purpose of detecting the mode of origin of the lacteal vessels. I have looked at them for hours together before and after the bloodvessels had been filled to great minuteness, but have never been enabled to discover orifices on the apices, or on any other part of the villus, and I can adduce the names of a host of modern observers of considerable celebrity, Rudolphi, Panizza, Haasse, Lauth, Fohmann, Breschet, Müller, Treviranus, and others, who deny the existence of any such orifices. Magendie and Cruveilhier conceive that the chyle must enter the lacteals by ori-

fices on account of the material particles of which this fluid is composed; the lymph they suppose enters the vessels by imbibition through their coats.

Before alluding to the other opinions on the subject of the origin of the lymphatic vessels, it may be as well to premise the changes which have taken place in our physiological notions with respect to the function of absorption since the time of the Hunters and their immediate successors. Magendie has proved by numerous convincing experiments, that imbibition does take place in the living as well as in the dead body, not only through the coats of the lymphatics and bloodvessels, but through all the tissues. It has been equally well established by Magendie, Delille, Segalas, Mayer, Emmert, and other physiologists, that we can no longer exclude the veins from participation in the important function of admitting new and foreign matters into the animal system. With respect to imbibition, I will select one of many experiments instituted by M. Magendie. He exposed the external jugular vein in a dog, and having separated it from its cellular attachments, placed a piece of card underneath the vessel so as to isolate it from the surrounding parts. He now applied to the centre of the vein a watery solution of the spirituous extract of *nux vomica*. In four minutes the symptoms of poisoning made their appearance. If then it be admitted that imbibition takes place in the living textures, there can be no longer an absolute necessity for open mouths to the origins of the absorbing vessels, and it follows that the lymphatics cannot be the sole agents in the process of absorption.

I will now adduce some experiments conducted by different physiologists, proving the entrance of various substances into the living animal system by other channels than the lymphatics. Magendie divided all the structures of the hind leg of a living dog, with the exception of the femoral artery and vein, through which the circulation was carried on. He then inserted the upas tieuté poison into the foot of the mutilated limb. The animal was poisoned in the usual space of time required for this substance to take effect. He repeated the same experiment with the additional precaution of placing inert tubes into the artery and vein, and afterwards dividing these vessels, leaving the limb connected to the trunk by the tubes only, through which the blood passed to and from the limb; the same effect followed on the introduction of the poison.

Mayer injected a solution of prussiate of potash into the lungs of an animal: in from two to five minutes after the injection, the serum of the blood, tested by a salt of iron, gave evidence of the presence of the prussiate of potash by the usual green or blue precipitate. It was detected in the blood long before it could be perceived in the contents of the thoracic duct, and in the left side of the heart before it appeared in the right. It was therefore evident that the pulmonary veins and not the lymphatics had first received the prussiate of potash and conveyed it to the heart. Segalas

included a piece of intestine between two ligatures in a living animal, and tied all the bloodvessels leading to it excepting one artery; the lacteals were left uninjured and pervious; an aqueous solution of *nux vomica* was now injected into the piece of intestine and there secured for an hour without producing any symptoms, but on removing the ligature from one of the veins, the poison took effect in six minutes. The converse of this experiment was performed by Magendie and Delille. A portion of intestine of a living animal was included between two ligatures; the lacteals proceeding from it were ligatured and divided, the bloodvessels being left pervious. A solution of *nux vomica* thrown into this piece of intestine destroyed the animal in six minutes. Emmert applied a ligature to the abdominal aorta in a dog, and afterwards inserted prussic acid into the foot of one of the hind legs; no ill effects followed in seventy hours; the ligature was then removed, and in half an hour symptoms of poisoning appeared.

In addition to simple imbibition, Dr. Dutrochet has shewn that fluids situated in contact with animal membranes permeate them in obedience to certain laws. When two fluids of different densities are in contact with the opposite sides of a membranous septum, they both permeate it, but with different degrees of rapidity. The more rapid current takes place from the rarer to the denser fluid; to this he applies the term of Endosmosis: the slower current from the denser to the rarer fluid he calls Exosmosis. These remarkable powers must be continually in action in the animal machine, composed as it is of solids and fluids, and cannot for the future be lost sight of in considering the subject of the absorption and deposition of fluids in a living animal, or the arrangement of the structures by which these important functions are accomplished. Taking these facts into consideration, and bearing in mind the experiments above detailed, we are led to the conclusion, that the capillary bloodvessels and even other tissues imbibe indiscriminately fluids brought in contact with them, and apparently in obedience to the physical or mechanical laws regulating imbibition, rather than in virtue of any new and essential agency with which they may be endowed as living structures; while the lymphatic system is left in possession of a higher grade of absorption accompanied with an elective power (especially manifest in the lacteals) existing only with life, and if not entirely independent of mechanical or physical laws, at any rate frequently at variance with them; by this elective power they are enabled, to a great extent, to refuse materials injurious to the economy of the animal, and to select those alone which may be made subservient to the nutrition of the system.

These physiological considerations will prepare us better for the examination of the remaining theories on the mode of commencement of the lymphatic vessels. We shall next enter upon that which ascribes to them an origin from the cellular tissue. Fohmann has

injected the lymphatic vessels from the cellular tissue, and most anatomists have remarked that when an injection thrown into the bloodvessels has extravasated into the cellular membrane, it has occasionally entered the lymphatic vessels. I have several times injected Fohmann's so called lymphatic cells of the umbilical cord, and have preserved a specimen shewing them, but cannot acquiesce in the opinion that they form a part of the lymphatic system. These cells, which readily receive the quicksilver introduced into a puncture made in the cord, vary in diameter from 1-100th to 1-250th of an inch, and communicate freely with each other; they have a very regular and organized appearance, but can only be injected after putrefaction has commenced. Fohmann describes them as situated between the lymphatics of the placenta, which terminate in them, and those of the fetus, which commence from them. I have never succeeded in pressing the injection from the cells of the cord into the lymphatics of the fetus or of the placenta. Treviranus conceives that the lymphatics everywhere commence by elementary cylinders of cellular tissue, and that in the villi of the intestines these elementary cylinders are so arranged as to have one of their extremities terminating in a lacteal vessel situated in the centre of each villus, while the other reaches the periphery of the villus, on the surface of which they present little vesicular projections, in whose centre he thinks he perceives a minute orifice. Arnold also observed a similar arrangement of the cellular tissue of the orbit into minute cylinders, which he supposed to be an incipient net-work of lymphatic vessels. Cruveilhier considers it probable that the cellular tissue and the serous membranes are formed of lymphatic vessels; and Mascagni makes a more sweeping assertion that all the white textures and the whole cellular web of the body is composed of these vessels.

The opinion that the lymphatic system commences by a plexus or net-work of vessels larger than the capillary bloodvessels, and which can always be seen by the unassisted eye when injected, appears to be the best supported by evidence, and to be that more generally received by modern investigators. These incipient plexuses are considered to be destitute of orifices either on the villi or elsewhere, and in this respect to resemble the peripheral branches of the arteries, veins, and excretory ducts, which, according to the more recent views in minute anatomy, nowhere present open mouths. The splendid injections of Mascagni, Fohmann, Lauth, and Panizza, shewing these vessels in various parts of the body, on the interior of mucous membranes, on the surface of particular portions of the skin, on the serous membranes, especially that part covering the solid viscera, on the lining membrane of the heart and bloodvessels, and of the excretory ducts of the glandular viscera, offer a body of evidence which can scarcely be resisted. In none of these situations can open orifices be discovered by the aid of the microscope or by means of

urging on the injection. On the surface of the liver, where the lymphatics may be injected with great facility, by pressing in a retrograde direction the injection may be forced beyond the valves, and by continuing the force some extremely minute globules of mercury may be made apparently to pass through the coats of the vessels. Haase has also, by the same procedure, forced the mercury through a net-work of lymphatics on the surface of the skin; but these circumstances can hardly warrant the supposition of lateral organized pores. These primary networks of lymphatic vessels are said to be deficient in valves in some situations. The meshes of the networks are of various forms and sizes: sometimes they are nearly equal-sided, at others oblong or irregular; in some places the vessels are so closely set that the spaces between them can scarcely be seen; in others they are larger and very distinct. The plan adopted by Fohmann to display these vessels, though liable to some objections, ap-

Fig. 51.

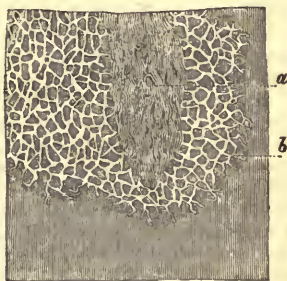

Shows an incipient plexus of lymphatic vessels.

(From Breschet.)

a, the more superficial plexus formed of very minute valveless vessels. *b*, a deeper plexus formed of larger valveless vessels, which receive the contents of the former, and which terminate in lymphatic vessels armed with valves.

pears to be the most successful. He pierces the part to be injected with a sharp-pointed lancet, held nearly horizontally, so as to produce a very superficial wound, the lymphatic net-work being generally nearer the surface than the capillary bloodvessels; into the wound thus effected the pipe of the mercurial injecting tube is inserted, and the quicksilver is made to enter some of the vessels opened in the incision, either by the weight of the column of the mercury or by urging it on with the handle of a scalpel. On the glans penis this method scarcely ever fails to fill the lymphatics, which are of large size. In the skin of the scrotum, and in the neighbourhood of the nipple, success will occasionally attend the attempt to shew these vessels; but in other parts of the integument, the endeavour has with me always been fruitless, so much so that I cannot help doubting their universal existence on the surface of the true skin. Breschet's description of a network of lymphatics brought into view by piercing the cuticle only, with a capillary tube of glass connected with a column of mercury, I am convinced is deceptive: his words are—

“ Il consiste (ce procédé) à percer superficiellement le tissu cutané avec l'extrémité d'un tube capillaire en verre ou en acier, de façon à n'intéresser que l'épiderme, pour arriver au réseau vasculaire situé entre cet épiderme et le chorion. On obtient ainsi l'injection de réseaux admirables de vaisseaux lymphatiques.” I have frequently produced the appearance here alluded to in all parts of the body: a foetus answers best for the purpose, but the proper lymphatics are never filled from these supposed net-works of lymphatic vessels. They are clearly nothing more than the spaces around the bases of the papillæ of the skin, from which, as putrefaction commences, the cuticle separates more readily than from their apices, consequently little canals are left around the papillæ, which communicate with each other and form a pretty exact resemblance to vessels filling rapidly as the mercury runs around the bases of the papillæ. The appearance can only be produced at a certain stage of putrefaction when the cuticle is about to separate. On removing the cuticle, the pretended vessels immediately disappear; but on the glans penis, on the scrotum, and on the skin of the nipple the removal of the cuticle will not disturb the net-works of vessels which may be there injected; moreover from these the lymphatic trunks can always be filled. I am also disposed to think, contrary to the received opinion, that the serous membranes do not universally present this superficial network of lymphatics; there are at any rate parts of these membranes where I have never seen these vessels injected, while there are others in which anatomists invariably succeed in shewing them; and for the mere purpose of absorbing the fluid secreted by the serous sacs, there appears to me nothing extraordinary in the supposition, that those portions of the membrane only which are most conveniently situated for the purpose should be endowed with the proper organization to effect it. The mode of procedure, however, adopted by Fohmann and others to display the incipient lymphatic net-works is open to serious objections, and calculated without great circumspection to lead into error. The capillary blood-vessels will often be implicated in the wound required to pierce the lymphatic net-work, consequently the injection may be found in the arterial and venous as well as in the larger lymphatic branches leading from the part. To succeed to any extent many punctures may be required, and in all probability some of these will conduct the injection into the three sets of vessels; but I have several times by the first puncture succeeded in injecting a net-work of vessels on the glans penis, which has conveyed the injection at once into the lymphatic branches on the body of the penis, and into these vessels only. The cellular tissue will also readily receive the injection, and where the cells are very small and uniform, as is the case with the umbilical cord, they resemble very much a net-work of vessels distended with quicksilver; and although Fohmann admits these to be cells, yet from their regularity he has been led to consider them a part of the

lymphatic system. In the same category may be classed the supposed lymphatic cells of the cornea observed by Arnold and by Müller. The submucous cellular tissue also is frequently arranged in little cylindrical cells which communicate with each other, and these cells on receiving the mercury put on the appearance pretty exactly of a net-work of vessels, but lymphatic vessels are not found conveying the injection away from them to the nearest lymphatic glands, which I imagine should be the proof required before we admit any vessels or cells to belong to the lymphatic system, however beautifully displayed by our injections. The subserous tissue is open to the same remark, and I can hardly offer a better instance of what appears to me to be an error arising from this source, than by quoting Fohmann's own words in reference to what he describes as the lymphatics of the brain. “ Les vaisseaux lymphatiques des enveloppes des masses centrales du système nerveux sont très faciles à démontrer, surtout au cerveau et au cervelet. Lorsqu'on enfonce une lancette entre la pie-mère et l'arachnoïde, et qu'on insuffle le canal que l'on vient de pratiquer, on voit paraître un réseau lymphatique interposé entre ses deux tuniques, réseau formé de rameaux d'un calibre plus considérable que dans les autres tissus du corps; cependant leurs parois sont si foibles qu'elles se déchirent presque aussitôt qu'on y introduit le mercure.” With respect to the universal net-work of lymphatics attributed to the lining membrane of the heart, and to that of the arteries and veins, I cannot admit, that the injections of a few minute canals with quicksilver on the lining membrane of the heart in the horse, by Lauth, and similar injections by Cruveilhier and Bonamy, can be received as demonstrative: the injection was not traced from them to a distinct lymphatic vessel, armed with valves and pursuing its course towards a lymphatic gland; these minute canals might have been capillary blood-vessels, or, as Breschet observes in his explanation of the plate which he gives from Lauth of these supposed vessels, “ Nous pensons qu'ils sont uniquement constitués par des lacunes du tissu cellulaire.”

In concluding what I had to say of the origin of the lymphatic vessels, a subject so inextricably mixed up with our preconceived physiological notions, I ought, perhaps, to offer some apology for advancing in an article of this nature any opinion peculiar to myself; I mean in reference to curtailing the extent to which the lymphatic system will be found to exist in the organism. My own mind has been forced to this conclusion after some years of attention to the subject, both from anatomical and physiological considerations.

It has appeared to me in the first place, that anatomists who have especially devoted their time to this interesting subject of late years, have not yet fairly freed themselves from the influence of the Hunterian views with respect to the part performed by the lymphatic vessels, as well as by the arterial capillaries, in effecting the growth and habitual nutrition of the

structures. To support the Hunterian theory the lymphatic was required to be present with every molecule of the organization, there with open mouth (for imbibition in the living body was not admitted as possible) to remove the old material in order to make room for the new, which was supposed to be deposited by the open mouths of capillary arteries. Now, although physiologists no longer admit that the arteries any where terminate by open mouths, but consider all nutrition to take place by the transudation of the liquor sanguinis through the delicate tunics of the capillary blood-vessels, and although venous absorption, as well as lymphatic, is acknowledged to take place, consequently that the ubiquity of the lymphatic ceases to be a matter of necessity, still it appears to me that physiologists have not yet shaken off the old impression, that every particle of the organization must have its lymphatic vessel, and I cannot help thinking that the continuance of this impression is misleading us in our notions of the arrangement of the system.

There are also some additional anatomical considerations which have had their weight in leading me to the opinion that the lymphatic system is less extensive than is generally supposed. It is not, I believe, known to anatomists that the lymphatic vessels admit readily of dissection in their uninjected state; these vessels do not easily give way under traction, and by using the forceps to hold them, and a blunt but pointed instrument to detach them from the surrounding cellular membrane, to which they are but loosely attached, they may be dissected with equal facility as the cutaneous nerves, for which they are not unfrequently mistaken by the young dissector. I have in this way several times dissected the lymphatics of the upper extremity, from the glands in the axilla to the fingers, and in the lower, from the inguinal glands to the toes. In proceeding thus to trace these vessels, scarcely a single lateral branch can be detected in the leg and thigh, by which the supposed universal net-work of the surface of the skin could have been connected with the rest of the system. When the subcutaneous lymphatic vessels are injected with quicksilver, every anatomist must have remarked the absence of lateral branches; this has always been accounted for by supposing a valve at the termination of each lateral branch into the larger longitudinal vessels; but in dissecting these vessels in their uninjected state, the lateral branches if present ought to be met with, which is not the case. I am fully aware that Haase, and other investigators, have succeeded in getting the injection to pass in a retrograde direction from the subcutaneous lymphatics of the lower extremity into a net-work of vessels of small extent situated close to the surface of the skin: this has occurred to myself on two occasions, in the skin over the tibia, and in the inguinal region, but in both these instances it was in a portion of skin presenting a cicatrix; the net-work was circumscribed, and left the impression on my mind of an abnormal rather than of a normal

condition of these vessels. The entire profession have adopted the notion that the process of ulceration is effected by the lymphatic vessels, consequently that, as every structure may ulcerate, so it must have its lymphatic vessel. But I may be permitted to ask pathologists to consider, whether they are not still influenced by the Hunterian theory, viz. that the countless open mouths of the lymphatics (which modern anatomists do not allow them to possess) effect the removal of the textures disappearing by ulceration, rather than by the few facts and observations bearing upon this important question. I would ask whether the occasional instances, of inflamed lymphatics containing pus, being found leading from an ulcerated surface, are sufficient to establish the opinion, that the whole process is effected by this set of vessels; or whether the occurrence is not more satisfactorily accounted for, by the supposition that the ulcerative process has implicated a lymphatic vessel, and that the pus has entered the vessel by an opening thus effected in its paries, or that the pus has been formed in the lymphatic itself, as the result of inflammation affecting its interior; more particularly when it is borne in mind, that the pus globule is much too large to have entered these vessels by imbibition, and that open mouths are denied to them. The parts of the body in which I have seen pus in the lymphatics, have been on the surface of the lung, on the mucous membrane of the intestines, on the penis when ulcers had occurred in these organs, also in the subcutaneous lymphatics after suppuration and sloughing of the cellular tissue,—situations in which every anatomist has seen lymphatics, and where the ulcerative or sloughing processes might readily have effected an opening into them.

The *lymphatic or absorbent glands*, called also *conglobate glands* by Sylvius, and *lymphatic ganglia* by Chaussier, are small fleshy bodies of a flattened form, rounded or oval in outline, varying from the size of a millet-seed to that of an almond; so situated in various parts of the body as to intercept the lymphatic vessels in their course towards the trunks of the system. They are generally clustered together, but occasionally are found single or isolated. The isolated glands are usually very small; the large ones clustered together. The lymphatic glands are well protected from pressure. In the limbs they are principally situated in the cellular spaces at the flexures of the joints, and enjoy the same protection as the main bloodvessels, close to which they are generally located. The loose cellular tissue in which they are for the most part imbedded, allows them great freedom of motion, by which they are enabled to elude pressure.

The lymphatic glands are most developed in childhood, least so in old age, and are intermediate in this respect in adult life. They are not found in Amphibia and Fishes, and in Birds only in the cervical region: intricate plexuses of large lymphatic vessels occur frequently in those animals which are destitute of lymphatic glands.

The colour of the lymphatic gland, depending apparently on the contents of its bloodvessels, is of a pale rose pink, resembling in this respect the colour of the salivary glands or of the egeritious matter of the brain; the exceptions to this observation will be found in the mesenteric glands while the chyle is passing through them, when they assume a whitish colour; the lymphatic glands in the neighbourhood of the liver and gall-bladder have been observed to possess a slight yellow tinge, but this is to be considered a post-mortem appearance. The black colour of the bronchial glands is remarkable and not easily accounted for; the lymph passing from the lung to them being always perfectly transparent and colourless.

The lymphatic gland has a capsule of condensed cellular tissue, which surrounds it and firmly adheres to it, appearing to send cellular prolongations into its substance; the outer surface of this capsule is connected to the surrounding textures by a loose cellular tissue. The capsule appears to serve the purposes of conveying the bloodvessels to the interior of the gland, of isolating it from the surrounding parts, and of preventing its over-distension by the lymph conveyed to it.

The bloodvessels of the lymphatic glands are large and distinct; frequently more than one artery is traced to a gland; the returning veins do not generally correspond either in direction or number with the arteries. The veins are much larger, but have appeared to me fewer in number than the arteries.

Nerves of considerable size pass to the lymphatic glands and can generally be traced through them, from which circumstance it has been doubted whether any filaments are left in the gland; but if acute sensibility to pain from undue pressure or from disease be admitted as dependent upon a proper supply of nerve, undoubtedly they possess it. The exact mode of arrangement of the bloodvessels in the interior of the gland is not well known. After a successful injection of these vessels the gland assumes the same colour as the injection itself.

Our knowledge of the structure of the absorbent glands rests mainly upon the information obtained by throwing injections of mercury or coloured wax into the lymphatic vessels. In this mode of investigating their texture, the walls of the canals or cavities containing the injection, which appear, as in the kidney and testicle, to form the parenchyma of the organ, are compressed, and when dry become transparent. The arrangement of the minute bloodvessels on the lining membrane of these canals has not been sufficiently investigated, and until this has been effected, our knowledge of the structure and function of the lymphatic gland must be considered very unsatisfactory, and as consisting of little more than conjecture. The great point of controversy has been, whether the injection thrown into the gland by the afferent lymphatic vessels was contained in cells or in convoluted vessels, which if decided would throw but little light upon the office performed by the gland—a desideratum in physiology of considerable importance, and without which

we are left in the dark at the very threshold of our investigations with respect to the first changes effected in the lymph and chyle, in advance towards sanguification. On examining

Fig. 52.

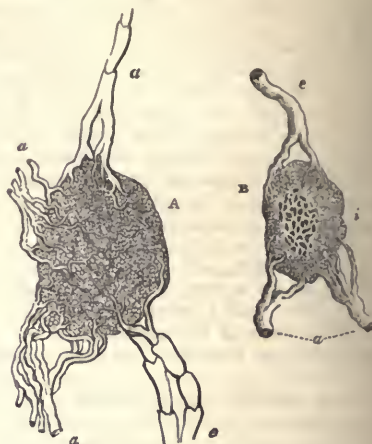

Lymphatic glands injected with mercury.
(After Mascagni.)

A, gland injected and dried. *a, a*, vasa afferentia. *b*, vasa efferentia.

B, gland injected and laid open to show the apparent cells. *i*, apparent cells; *e*, vas efferens; *a*, vasa afferentia.

the glands thus distended with injections, the vasa inferentia are seen reaching the gland from various sources, and on their approach to it they may be observed to subdivide into extremely minute branches, which disappear by plunging into its substance: equally minute vessels may be observed emerging from its opposite side or surface, which soon unite to form the vasa efferentia of the gland; the gland itself, which is intermediate in position between these vessels, when injected, presents a granular surface, and at first sight an observer would generally conclude that he was looking upon minute cells filled by the injection; in making a section also into the substance of the gland and allowing the mercury to escape, the appearance on a superficial inspection is still that of cells; proceeding, however, with more attention to examine these supposed cells, especially after making a section as close to the surface of the gland as possible, by the aid of the microscope it will be evident that tubes closely set together and adherent to each other, have been laid open, passing in various directions, and in their interior many valvular constrictions and thread-like intersections may be seen; in fact the gland appears to be entirely composed of a convoluted vessel, the sides of which as they come in contact are firmly held together by cellular membrane derived from the capsule.

This convoluted tube forming the gland is not always cylindrical, but is occasionally dilated, and looks flattened near the surface where pressed by the capsule; the size of this tube

is much larger than that of the branches of the vasa afferentia and efferentia, a fact that has been too much overlooked by anatomists, and which leads me to conjecture that these vessels enter and arise from its convolutions by open mouths; be this as it may, we know that the injection conveyed into the gland by the vasa afferentia readily passes from it by the vasa efferentia. I should not here omit to mention a circumstance already adverted to of considerable interest, viz. that the injection conveyed to a gland by an afferent vessel is occasionally received by the veins of that gland, and to all appearance without rupture or extravasation. The occurrence itself is admitted by all; but physiologists differ much in their explanations of the channel by which the injection has entered the vein. Some explain it by an extravasation into the cellular tissue from an injury by which both sets of vessels have been opened; others, who conceive that a minute net-work of lymphatics exists on the interior of the veins and arteries, will have no difficulty in imagining a rupture of this net-work; the vasa vasorum of the lymphatics, which may be distinctly seen on their interior after a minute injection, may be supposed to have given way and to have admitted the injection from the interior of the lymphatics. But these opinions will not explain why this communication should take place within the gland only, and invariably with the vein, never with the artery. The general opinion is that this communication takes place accidentally, and not by any real continuity of canal. Fohmann stands almost alone in asserting that a natural communication does exist between the lymphatics and veins within the glands, especially in those situations where in birds, reptiles, and fishes, the lymphatics have been proved to terminate directly in the veins. Fohmann even ventures an opinion as to the mode in which the lymphatic joins the vein; not, he conceives, by continuity of peripheral branches, but by an efferent lymphatic opening into the side of a vein before the latter emerges from the gland. Without committing myself to the exact mode of union, I must confess I agree with Fohmann that a natural communication does exist in some of the glands between the lymphatics and the veins. It has been observed hundreds of times. It has occurred to every anatomist who has engaged himself with the injection of these vessels; I have met with at least twenty such instances myself, while a similar communication between a lymphatic and artery within a gland has never been observed. I am entirely at a loss, therefore, to account for these occurrences without admitting a natural channel to exist between the one set of vessels and the other.

I have before observed that the exact arrangement of the bloodvessels in the interior of the canals of which the glands are constituted, is not known; but we are equally in the dark with respect to the vascular supply received by other minute tubes, such as the seminiferous, uriniferous, and lactiferous tubes, from the capillaries of whose lining membranes, however, we admit that their appropriate secretions are de-

rived. As far, then, as organisation is concerned, there is nothing to forbid our ascribing a secreting function to the interior of the canals of the lymphatic glands, or of the lymphatic vessels generally. There can be little doubt but that the lymph and chyle undergo modifications in their passage through the absorbent glands, although we are not at present prepared to state the nature of that modification. It has been observed that the chyle included between two ligatures in its own vessel before it has reached a gland will not coagulate, although after it has passed the gland coagulation readily takes place. Müller remarks from this circumstance that the glands of the mesentery appear to have the power of changing part of the albumen of the chyle into fibrin. At any rate we are warranted, from the little we do know of the structure of the absorbent gland, in asserting, that the chyle and lymph collected from various sources must be mingled together in the glands, that they must be divided into extremely minute streams on their entrance into or exit from a gland, that they must be submitted to a great extent of surface of their containing vessels, and subjected to considerable delay in their passage through the gland. Mr. Gulliver's observations on the fluid contained in the absorbent glands would almost lead us to conclude that their proper office was to fabricate the peculiar globule of the lymph and chyle; my own observations on these fluids before and after reaching the glands would not bear out this opinion; but as I have next to consider the characters, physical, microscopical, and chemical, of these fluids, I shall shortly enter more fully into this subject.

Lymph is a transparent fluid, slightly opaline, of a light straw colour; its specific gravity is 1022·28, water being 1000·00; its odour, which is slight, varies, and is peculiar to each animal; it is alkaline, and has a saline taste. I collected in an ounce-phial about three drachms of lymph from a large lymphatic in the axilla of a horse, by inserting a small silver tube into it. In about ten minutes the whole had coagulated into a jelly-like mass; in half an hour a separation had taken place into a fluid and solid part: the latter formed a soft tremulous clot modelled to the form of the phial. A drop of this lymph placed on a piece of glass, and covered by talc, was submitted to inspection under the microscope, immediately after its removal from the vessel. A number of colourless spherical globules were observed in it having a granular surface, and precisely resembling those described by Mr. Gulliver as belonging to the mesenteric, lymphatic, and thymus glands. I am not aware whether Mr. Gulliver considers these globules as belonging exclusively to the glands, or whether he thinks them distinct from or identical with the lymph and chyle globule. My own observations lead me to state that they are found in the lymph or chyle before and after passing the glands, as well as in their transit through them. I am also disposed to assert that these globules remain colourless, and that whenever the lymph possesses a slightly red tint, it obtains that tint from the

presence of blood corpuscles which have accidentally entered it. After coagulation had taken place, the lymph was again examined under the microscope, the globules were all found entangled in the clot; scarcely one remained in the transparent fluid. The clot, when disturbed, torn, and pressed, contracted to less than one-twentieth of its original bulk, and the few blood corpuscles it contained, being now approximated closely together in the contracted clot, gave it a slightly red tint. On examining the serum of this lymph under the microscope a week afterwards, when putrefaction had commenced, numerous exceedingly minute animalcules were seen diffused through it in active motion.

Müller gives an account of a fluid which makes its appearance after a portion of the skin of a frog is removed from the muscles; this fluid he considers to be pure lymph; he describes it as perfectly transparent and colourless, having a saline taste, but void of smell. Under the microscope he detected in it a number of colourless and spherical globules, about one-fourth of the magnitude of the elliptical blood corpuscule of the same animal, a few of which were unavoidably mixed with this lymph. Müller also describes what he considers to be human lymph, obtained from a small fistulous opening on a man's foot, the remains of a wound received on the instep; by pressure from the great toe towards the opening a transparent fluid could be made to transude; this fluid also contained colourless spherical globules, much smaller than the blood corpuscles. It, as well as that obtained from the frog, coagulated spontaneously, and appeared to possess the other properties of lymph. After coagulation had taken place in the fluid obtained from the man's foot, he observed that the globules were partly found in the clot, while some remained in the fluid surrounding the clot. In the horse's lymph examined by myself, all the globules were entangled in the clot.

The red colour of the contents of the thoracic duct, especially in the horse, has been remarked by most observers, but the cause of this redness has not been well ascertained. Breschet says, in his *Système Lymphatique*, page 160: "Ce qu'il eût été intéressant surtout de déterminer, c'est si la matière colorante qui teint quelquefois le chyle, et même la lympe, y est dissoute, ou si elle affecte soit toujours, soit au moins quelquefois, la même disposition que celle des globules du sang." I have frequently examined microscopically this reddish fluid of the thoracic duct, and have invariably found it to depend upon the presence of red corpuscles of precisely the form and size of those of the blood. I believe that these red corpuscles are extraneous to the lymph, that their presence is accidental, and should be considered as a post-mortem occurrence. I would attribute their existence in the contents of the thoracic duct to the circumstance that very many lymphatics must be divided with the other structures, before the thoracic duct or indeed any large lymphatic can be exposed; these divided lymphatics must

necessarily have blood applied to their cut extremities; the vessels being open receive the blood corpuscles, and convey them from all parts to the thoracic duct. This is not mere conjecture. I have seen the blood enter the divided vessels in the following experiment made for the purpose. On the under surface of the liver of a horse recently killed I observed some large lymphatics filled with a beautifully transparent fluid. I made an incision into the liver over these vessels, of course dividing them, and in a few seconds saw them conveying a reddish fluid towards the thoracic duct.

The lymph bears great resemblance to the liquor sanguinis both in its physical and chemical characters. Müller, who had observed that the blood of frogs will not coagulate when they are kept out of water in summer for eight or ten days, mentions the coincidence that when this is the case, the transparent fluid which he obtained by removing a piece of skin from a living frog, and which he conceived to be the lymph of the animal, was also incapable of spontaneous coagulation.

Leuret and Lassaigue give the following analysis of lymph obtained from the lymphatics of the neck in a horse:—

Water	925
Albumen	57·36
Fibrine	3·30
Chloride of sodium	} 14·34
Chloride of potassium	
Soda	
Phosphate of lime	
	<hr/>
	1000·00

Salivary matter, ozmazome, carbonates, sulphates, muriates, and acetates of soda and potash, with phosphate of potash, have in addition been detected in the lymph by Tiedemann and Gmelin.

Chevreul analysed some lymph procured by Magendie from the thoracic duct of a horse after five days' abstinence. Its composition was as follows:—

Water	926·4
Fibrine	4·2
Albumen	61·0
Muriate of soda	6·1
Carbonate of soda	1·8
Phosphate of lime	} 5
Carbonate of magnesia	
Carbonate of lime	
	<hr/>
	1000·0

M. Magendie and M. Collard de Martigny have examined the lymph in animals, after depriving them altogether of sustenance; up to the tenth or twelfth day the lymph was found in greater abundance, appeared to have more of the red tinge, and to be more consistent; but after this period it diminished in quantity, became more watery and had less of the rose tint. The latter physiologist rejects altogether the opinion entertained by some, that the lymph would assume a redder colour the longer the animal fasted.

The lymph is said to coagulate more readily after passing through the lymphatic glands, and the nearer it approaches the thoracic duct. I have not found this to be the case in so marked a degree as has been stated. I have collected lymph from the lymphatics of the intestines before they reached the glands, and from various parts of the body in which no glands are situated, and have invariably found the fluid to coagulate spontaneously, although if in small quantity it may shortly return to the liquid state.

The fluid contained in the lacteal vessels in Mammalia is of a white colour like milk, and is called chyle; it has a marked saline taste, is slightly alkaline, and has no perceptible odour. I have now before me several specimens of recent chyle collected carefully from the lacteal vessels, before they reach the glands, from the glands themselves, from the vasa efferentia of the glands, and from the thoracic duct. These specimens were taken from a donkey killed for the purpose, seven hours after a full meal of oats and beans. About half a drachm was obtained from the vasa inferentia, and a drachm from the mesenteric glands themselves in watch-glasses; from the vasa efferentia about three drachms were procured in a test-tube, and from the thoracic duct in a phial nearly an ounce. All were of a pure milk-white colour except that from the thoracic duct, which had a slight pink tint. They all jellied spontaneously in from five to ten minutes; that from the vasa inferentia again liquified in about half an hour, and remained in this state; on other occasions I have known it retain its solidity. I have also seen the chyle from the glands, and from the vasa efferentia, return to the liquid state after having been coagulated for a short period. I have observed the same occurrence in lymph before and after it had traversed a gland. In about half an hour, with the exception already noticed, these specimens of chyle separated into a kind of serum and clot, the latter forming by far the greater portion, at least four-fifths of the whole. This clot, however, on being broken up and pressed, contracted to one-twentieth part of its former bulk; both the serum and the clot retaining their white colour. In the specimen obtained from the thoracic duct the pink tint was confined to the clot, and the serum was whitish or whey-coloured. It ought here to be stated that chyle, before it has reached the receptaculum, will not always separate into a fluid and solid portion, but will remain of the consistency of a soft white jelly, from which, however, by breaking it up, a white fluid may be obtained.

I find great error and confusion in the descriptions hitherto given of the microscopical appearances of the chyle. Müller and Breschet both state, that the white colour of the chyle depends upon its globules, which they then proceed to describe; they both quote Prevost and Dumas as estimating the diameter of the chyle globule at 1-7199th of an inch, or about half that of the blood globule in man. Müller says that in the cat he finds them of the same size as the blood cor-

puscules, and in the rabbit some of them were larger; in the calf, the dog, and the goat he found them much smaller than the blood corpuscles of the same animal. Breschet, in his work on the lymphatic system, published in 1836, acknowledges the unsatisfactory state of our knowledge with respect to the globules of the chyle and lymph. Tiedemann and Gmelin, in their elaborate work on digestion, distinctly state they consider the white colour of the chyle to depend upon fatty particles, which form a sort of emulsion with the serous portion of the chyle. Mr. Gulliver has given by far the most correct description of the microscopical appearances of the chyle that I have met with; he is the first who has noticed the extremely minute particles which constitute the characteristic microscopical appearance of the chyle, for the larger globules, noticed by most observers, are found also in the lymph. Mr. Gulliver has not, however, corrected the statement of Müller, Breschet, and others that the white colour of the chyle depends upon these larger globules; but I doubt not he would acquiesce with me in opinion that the white colour depends altogether upon the more minute particles. With these preliminary remarks I shall proceed to describe the microscopic characters of the chyle from my own observations.

Every one is aware that the lacteals, when not conveying chyle, contain a transparent fluid not to be distinguished by the eye from the lymph of other parts of the system; to this fluid is added, during the digestion of a meal, myriads of extremely minute particles, twenty or thirty times less in size than the lymph or blood globules of the same animal, and which can scarcely be distinguished by a glass of less power than one-eighth of an inch focus, upon which undoubtedly the white colour of the chyle depends; when these particles are very numerous, the chyle is perfectly white and opaque; when less so, it will be whey-coloured or semitransparent. These particles are peculiar to the chyle, and I have been in the habit, for the last two years, of calling them the chyle granules, in contradistinction to the globules of different kinds which are also found in this fluid. The chyle granules, when allowed to dry on a piece of glass, measure from 1-20,000th to 1-10,000th of an inch in diameter, and are larger and more distinct in carnivorous than in graminivorous animals. The most remarkable peculiarity, which I believe I am the first to notice, of these chyle granules, is their continual vibratory or oscillatory motions. On viewing under the microscope a drop of chyle taken from the lacteal of a carnivorous animal, and placed between a piece of glass and talc, the motions of the chyle granules will be seen to be so constant and ceaseless, that the observer would at first sight be led to consider the chyle as a moving mass of restless animalcules; but on noticing the limited range, as well as the sameness, and apparent want of object, in these to and fro movements, he will probably feel inclined to attribute them to some unknown attraction and repulsion, influ-

encing inert and unorganized particles. It is assuredly a striking fact, and one fraught with great interest, that the new molecules on their first introduction into the living system, should possess one of the most conspicuous attributes of vitality, viz. motion.* Mr. Ansell, who has paid great attention to the animal fluids, has frequently examined these moveable granules with me, and is inclined to consider their motions, as indicating the first obvious impress of vitality which the new material has received from its association with living matter. Besides the granules, there exist in the chyle numerous spherical globules colourless and granular on the surface, averaging 1-5000th, but ranging between 1-3000th and 1-7000th of an inch in diameter, resembling in every particular the lymph globule, with which they are probably identical. These globules I conceive are not derived from the interior of the intestine as some have supposed, nor from the glands, as I presume is Mr. Gulliver's opinion, but I would rather say are formed in the chyle and lymph by the aggregation of similar particles, probably fibrinous. Globules of oily or fatty matter are also found in the chyle; these may be readily distinguished by their circular and even outline, by their smooth and apparently flat surfaces, and by the great variety of their size, some being as small as the chyle granule, while others exceed the globule in diameter; in many respects they resemble the milk globule in appearance. Blood corpuscles will of course be frequently seen mixed with the chyle, as it is exceedingly difficult to collect it free from them. In the chyle the blood corpuscle loses its circular outline, its ordinary flattened form, its concave or cupped surface, and assumes a corrugated or wrinkled appearance, a spiked or serrated edge; the blood corpuscles, when thus corrugated, are less in diameter than the surrounding chyle globules, and have frequently been mistaken for them. On examining the blood taken from a living animal after a recent flow of chyle into it, this appearance of the blood corpuscle will also be readily distinguished. The corrugations alluded to on the blood corpuscle may be mistaken for spots on it; and when the corpuscle is revolving or vibrating, they may even appear like particles moving within it. I was for a short time misled by this deceptive appearance into the belief that the chyle granule, when received into the blood, entered the envelope of the blood corpuscle to form its nucleus. This erroneous notion, however, was soon corrected on finding that other fluids produced the same appearance in the blood corpuscles. It will be observed then, that I am induced to think that the chyle is never perfectly free from lymph; that in fact the lymph is termed chyle when it is rendered white by the addition of the moveable chyle granules from the interior of the intestine, to which are

added from the same source the oily or fatty particles.

If the clot and serum of the chyle be examined separately under the microscope, they will both be found to contain the chyle granule in sufficient quantity to render them white; the chyle globule, or any blood corpuscle that the specimen may have contained, will be entangled in the clot, while the oily particles will be principally found in the serum. If the coagulation has been incomplete, or the specimen has been agitated, some chyle globules and blood corpuscles will of course be mixed with the serum.

The chyle has been analyzed by Reuss and Emmert, by Vauquelin, by Marcet, Prout, and Brande, by Leuret and Lassaigue and by Tiedemann and Gmelin, but in a science so rapidly progressive as chemistry it is desirable to adduce the most recent information bearing on the subject. I shall therefore select the analysis given by Berzelius, (taken from the translation of his treatise on Chemistry by Me. Eslinger, published at Paris in 1833,) who adopts some of the opinions of Tiedemann and Gmelin, and with whose analysis of the chyle his pretty exactly agree^s.

In 100 parts of chyle, taken from the thoracic duct of a horse during the digestion of a meal of oats, he obtained, after breaking up and pressing the clot, 96.99 parts by weight of serum and 3.01 of clot: the former was reduced by desiccation to 7.39 parts and the latter to 0.78; consequently, after evaporation, the proportions in 100 parts stood thus—

Desiccated clot	0.78
Desiccated serum	7.39
Water	91.83
	<hr/>
	100.00

The dry clot softened when digested in distilled vinegar, but without being dissolved by it to any perceptible extent. A small quantity of a brownish-yellow oil was obtained from it by the action of boiling alcohol.

One hundred parts of the desiccated serum contained—

Brown fatty matter	15.47
Yellow fatty matter	6.35
Osmazome, lactate of soda, and chloride of sodium	16.02
Extractive matter soluble in water, insoluble in alcohol, with carbonate and a little phosphate of soda	2.76
Albumen	55.25
Carbonate with traces of phosphate of lime	2.76
	<hr/>
	98.61

It has been generally stated and believed that a sufficient quantity of chyle for chemical analysis could not be obtained from the lacteals before they reached the thoracic duct, consequently, that which has hitherto been submitted to chemical examination has been taken from the trunk of the system, where it must of necessity have been mixed with a greater or less

* [Wagner has depicted in his *Icones Physiologicae* minute granules, which he designates "*Moleculæ minores, cujusmodi in liquore chyli natant, procul dubio chyli granula futura.*" Tab. xiii. fig. 11.—Ed.]

quantity of lymph; the comparison therefore between chyle and lymph has never been fairly instituted. Regretting with others the deficiency in our knowledge of the relative compositions of these important fluids, which, though derived from such different sources, enter in combination the already circulating blood, I performed some experiments, which need not here be described in detail, for the purpose of ascertaining the quantity of chyle that might be procured from the vasa efferentia of the mesenteric glands, and found that by a little care and contrivance as much as half an ounce of perfectly pure chyle might be procured from a horse after a full meal. I now applied to Dr. G. O. Rees, well known to me as an able and zealous investigator of the too much neglected science of animal chemistry, and requested him to undertake the analysis of the unmixed chyle and lymph, and to institute the desired comparison between them. Dr. Rees kindly acquiesced in my proposal, and has published the result of his inquiry in one of the late numbers of the London Medical Gazette, from which I transcribe his analysis with some of his observations, the whole of which are well worthy of perusal. The fluids in question were procured from a donkey, killed seven hours after a full meal of oats and beans.

Analysis of chyle and lymph before reaching the thoracic duct, by Dr. G. O. Rees—

	<i>Chyle.</i>	<i>Lymph.</i>
Water	90·237 ..	96·536
Albuminous matter	3·516 ..	1·200
Fibrinous matter	0·370 ..	0·120
Animal extractive matter soluble in water and alcohol } ..	0·332 ..	0·240
Animal extractive matter soluble in water only } ..	1·233 ..	1·319
Fatty matter	3·601 ..	a trace.
Salts. { Alkaline chloride, sulphate and carbonate, with traces of alkaline phosphate, oxide of iron }	0·711 ..	0·585
	100·000	100·00

Dr. Rees describes the albuminous matter of chyle as possessing a dead-white colour, which he attributes to the admixture of a substance of a peculiar character, and upon which he conceives it probable that the white colour of the chyle depends. Will further investigation prove this peculiar substance to be derived from the chyle granule? or is the chyle granule formed of a combination of this substance with fatty matter?

This peculiar matter, Dr. Rees states, is readily obtained by agitating chyle with æther, when the mixture speedily separates into three distinct strata, the centre stratum being the substance in question; a similar matter, he observes, may be obtained from saliva by treating it in the same way. He found it to react as follows:—

“ It was insoluble in alcohol, both hot and cold—insoluble in æther—miscible with water,

and soluble in liquor potassa. When it had been dried on platinum foil, the addition of water made it pulpy, and it was found still to be miscible with that fluid, from which, however, it separated in flakes on the addition of diacetate of lead.”

I have now examined each part of the lymphatic system in detail, and on reviewing it as a whole, with the mind fully emancipated from the old erroneous views in physiology, and with a full conviction of the truth of the modern discoveries with respect to imbibition, endosmosis, and exosmosis, including venous absorption, as established by Magendie, Dutrochet, Segalas, Delille, and others, and admitted by Müller, Panizza, Fohmann, Lauth, Breschet, and all the modern investigators in this interesting and intricate field of inquiry, in which I regret not to be able to mention the name of one of our own countrymen since the time of Cruickshank, Hewson, and Sheldon—in bringing, I say, with our present improved state of knowledge in physics and physiology, the mind to bear upon the subject of the lymphatic system, it appears to me that we are justified in materially modifying our opinions, both with respect to the functions exercised by this system of vessels, as well as with regard to its anatomical arrangement, which has been made to depend so much upon the preconceived physiological notions respecting it. I venture then to suggest that we are going too far in attributing to the lymphatic (since the veins also absorb) the important and universal function of interstitial absorption of the old material, previous to the deposition of the new, in the process of growth and nutrition; that it is without sufficient proof that we admit the ulcerative process to be carried on solely through the agency of the lymphatic system, or that the removal of all morbid growths or depositions is effected by the one order of absorbent vessels unassisted by the other; and indeed that there would be nothing repugnant to sound reasoning, or at variance with the present improved state of our knowledge, were we to confine the functions of the lymphatic system more within the bounds ascribed to the lacteal vessels during the process of digestion, viz. to select and prepare nutritious materials for the purpose of sanguification, and to deposit them in the already circulating current.

Descriptive anatomy.—I now proceed to describe the exact course which the lymphatic vessels take in the different parts of the body, the position and number of the absorbent glands which they traverse, and the precise direction, mode of commencement, and termination of the two principal trunks, into which they pour their contents.

This part of our subject, the descriptive anatomy, neither requires nor admits of that rigid exactness which is absolutely necessary in tracing out the ramifications of the blood-vessels. In the first place, the surgeon, in the performance of his operations and in the treatment of wounds, scarcely finds it necessary to take the lymphatic vessels into consideration. To relieve the stricture in strangulated femoral

hernia, he unsparingly divides the principal lymphatics and glands in the inguinal region. In the next place these vessels vary so much in number, and consequently in position in different individuals, while there exist so many parts, where their presence is rather presumed than demonstrated, that a general outline of their course is all that can be required or depended upon. In the distribution of these vessels two principal objects are specially provided for; the conveyance of the lymph to its appropriate glands, and afterwards from them to the two trunks of the system. We, consequently, first notice an evident tendency of the vessels from the structures in which they take origin towards the glands which intervene between them and the trunks of the system; secondly, their necessary course from these glands to the trunks themselves.

With this key to the distribution of these vessels, I propose to describe, first, the position of the glands, then to treat of the trunks of the system; and, lastly, having these two fixed points, to trace the vessels throughout their course.

In the lower extremities the conglobate glands are chiefly found in the inguinal region, where they are divided into a superficial and deeper seated cluster; a few small glands are situated in the popliteal space surrounding the bloodvessels. We rarely meet with one between the popliteal space and the inguinal region, and they are only occasionally met with below the knee, and then isolated and extremely small. In the upper extremity the large and clustered lymphatic glands are only found in the axillary space; a single gland is generally located just above the internal condyle of the humerus; below this point a distinct gland is rarely met with.

In the cervical region the principal lymphatic glands are situated in two cellular intervals, found at the upper part between the omo-hyoid and sterno-cleido-mastoid muscles, and below between the latter muscle and the trapezius. The glands in these positions are ranged in a line so as to form a sort of chain of glands, hence the term *glandulæ concatenatæ* as applied to them.

On the head and face the glands are few, small, and isolated. One may be pretty constantly met with behind the ear over the mastoid process of the temporal bone, another in front of the ear in the neighbourhood of the parotid gland. One or two will be found under the margin of the lower jaw, both in the median line and also more laterally situated. A small lymphatic gland will usually be distinguished amongst the numerous but small buccal and labial glands.

In the cavity of the cranium no lymphatic glands have been discovered, but in the abdominal and thoracic cavities they are very numerous. In the abdomen they are chiefly situated in the neighbourhood of the larger bloodvessels. In the pelvic region they form clusters, or rather chains of glands accompanying the external, internal, and common iliac vessels, and in the lumbar region they are similarly arranged on

either side of the aorta, as high as the point of origin of the superior mesenteric artery.

The absorbent glands which intercept the lacteals in their course towards the *receptaculum chyli* are large and numerous; they are situated between the folds of the mesentery, and accompany the trunk and some of the branches of the superior mesenteric artery; they are usually termed mesenteric glands. The remaining lymphatic glands of the abdominal viscera, though numerous, are smaller and more isolated; they will generally be found close to the arteries of the viscera to which they belong, and consequently between the folds of the peritoneum. Of this description may be considered those accompanying the hepatic and splenic vessels: the coronary and gastro-epiploic arteries of the stomach, the small glands of the mesocolon or epiploon, those associated with the renal or spermatic arteries.

The largest absorbent glands of the thoracic cavity are those which receive the lymphatics from the lungs; they are situated at the roots of the lungs, pretty closely attached to the bronchi; they are generally of a dark colour and are called bronchial glands. Those associated with the lymphatic vessels of the heart are few and small; two or three may generally be noticed of the size of millet-seeds on the aorta and pulmonary artery, where these vessels are invested by the pericardium. In the posterior mediastinum close to the thoracic duct three or four large lymphatic glands are usually met with, as well as several smaller ones in the intercostal spaces, not far from the thoracic duct. In the anterior mediastinum also some small glands may be observed imbedded in loose cellular tissue in the neighbourhood of the internal mammary vessels. Occasionally a small gland may be seen on the convex surface of the diaphragm.

In the substance or parenchyma of the different organs no lymphatic glands have been detected. They have never been seen in the brain, spinal marrow, in the lungs, liver, spleen, kidney, or testicles, in nerve, muscle, or bone.

Having given this general outline of the position of the lymphatic glands, I shall now proceed to describe the trunks of the system.

The thoracic duct, (*fig. 53.*) or principal trunk of the lymphatic system, generally commences on the body of the second lumbar vertebra pretty exactly in the median line, concealed behind the root of the right emulgent artery, bounded on the right by the right crus of the diaphragm, and to the left by the aorta, to which it is connected by cellular tissue. It may be said to be formed by the union of the lymphatics of the lower extremities with the trunks of the lacteals proceeding from the intestines. At the conflux of the principal vessels from these three sources,—and there may be more than one from each,—a dilatation is sometimes found, which has been called the *receptaculum chyli*. From the body of the second lumbar vertebra the thoracic duct ascends into the thorax between the aorta and vena azygos. In the thorax it is situated behind the right pleural fold of the posterior medias-

Fig. 53.

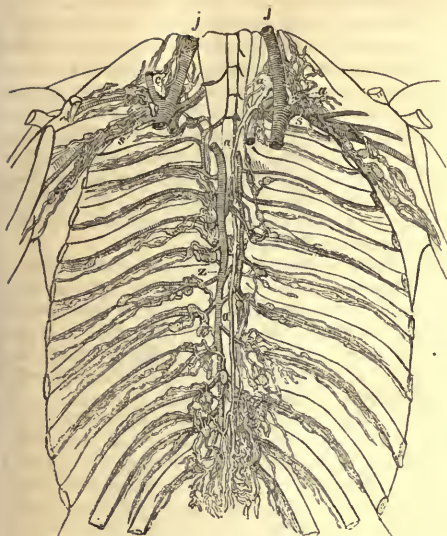

The thoracic duct and right lymphatic trunk.
(After Mascagni.)

- a, Thoracic duct.
- b, The right lymphatic trunk.
- c, The trunk of the cervical lymphatics entering separately the internal jugular vein.
- s, Subclavian vein.
- j, Internal jugular vein.
- z, Vena azygos.

tinum, having the aorta to its left, the vena azygos to its right, and the œsophagus in front. In this position it ascends as high as the fourth or third dorsal vertebra, at which level, continuing its course upwards, it turns from right to left, passing behind the descending portion of the arch of the aorta, above which it appears a little external to the root of the left subclavian artery, from whence continuing to ascend it passes between the latter and the left common carotid artery, lying on the longus colli muscle; it now mounts into the cervical region in front of the vertebral artery and vein to the level of the seventh cervical vertebra, opposite to which it begins to form a curve, first forwards and outwards, then downwards and inwards, striding over the subclavian artery to reach the angle of union between the subclavian and internal jugular veins, at which point it empties itself into the venous system either by one or more branches.

The thoracic duct is not uniform in diameter throughout its course; besides the occasional dilatation at its commencement, it generally presents another on the fourth dorsal vertebra just below its passage behind the descending thoracic aorta. Its narrowest part usually corresponds to the sixth or seventh dorsal vertebra. The duct is frequently tortuous and rarely single throughout. It often splits into two or more branches, which after a longer or shorter course reunite; this division and reunion may be two or three times repeated, and it may ultimately terminate by two or three branches instead of one.

The principal irregularities in the arrangement of the thoracic duct, which have been recorded by anatomists, are—a double duct, one terminating in the left, the other in the right side of the neck; a bifurcation of the duct at a higher or lower level, one branch terminating in the angle of union of the subclavian and internal jugular veins of the left side, the other emptying itself either into the corresponding point on the right side or joining the right lymphatic trunk, close to its termination; a single trunk terminating altogether on the right side of the conflux of the internal jugular and subclavian veins, in which case a short lymphatic trunk is found on the left side similar to that which usually exists on the right, constituting a partial lateral inversion or transposition confined to the trunks of the lymphatic system.

Besides the lymphatics of the lower extremities and the lacteals, the thoracic duct receives directly or indirectly the lymphatics of the remaining abdominal viscera (except a few from the right lobe of the liver), those from the exterior and interior of the lower half of the trunk; also the lymphatics of the left upper extremity, and left side of the head and neck, those from the left lung, the left side of the heart, and from the exterior and interior of the left upper half of the body.

The right lymphatic trunk nearly equals the thoracic duct in diameter; it is, however, not more than half an inch in length. Its situation is in the neck at the level of the lower edge of the seventh cervical vertebra, where it will be found lying upon of the subclavian vessels close to the inner edge of the scalenus anticus muscle, and opposite to the union of the subclavian and internal jugular veins, at which point it terminates in the venous system.

The right lymphatic trunk receives the lymphatics of the right upper extremity and of the right side of the head and neck, those from the right lung and right side of the heart, some few from the right lobe of the liver, and from the exterior and interior of the right upper half of the body.

Some of the principal branches which ordinarily empty themselves into the right lymphatic trunk occasionally terminate separately in the internal jugular or subclavian veins close to their junction. When these vessels all enter the veins separately, then the right lymphatic trunk is said to be deficient.

Having described the position of the trunks of the lymphatic system as well as the situations of the conglobate glands in the various parts of the body, I now proceed to trace the vessels themselves.

I shall commence with the description of the lymphatics of the lower extremities, as being the most remote from the trunks of the system. They are divided, as in all other parts of the body, into a superficial and deep-seated set, which latter accompany the principal bloodvessels. They are associated successively with the digital arteries, the internal, external plantar, and dorsal arteries of the foot; in the leg with the anterior, posterior tibial, and fibular vessels.

Fig. 54.



Superficial lymphatics of the lower extremity.
(After Mascagni.)

- a, Saphena major vein.
- b, Inguinal glands.
- c, Commencing branches.
- d, e, f, g, The continuations of the vessels similarly marked in the former wood-cut.

At least two lymphatics, which are united frequently by short branches crossing from one to the other, accompany each of these arteries, and all are ultimately conducted by the blood-vessels to the popliteal glands, in which they terminate. The vasa efferentia of these glands, from two to six in number, entwine around the

popliteal and femoral vessels, having frequent communications with each other by short cross branches, until they reach the inguinal region, where they terminate for the most part in the deep-seated cluster of inguinal glands; one or more, however, may reach the superficial glands or even those accompanying the external iliac artery above Poupart's ligament. The deep-seated lymphatics in their course are joined by branches which have accompanied the principal ramifications of the bloodvessels; they also at various points form communications with the superficial lymphatic vessels.

The superficial lymphatics of the lower extremities may be divided into two groups; one consisting of numerous vessels which follow more or less the course of the saphena major vein and terminate in the inguinal glands; the other composed of but few vessels, which, accompanying the saphena minor vein, join the popliteal glands. The latter take origin from the dorsal surface of the little toe and from the outer edge of the dorsum and sole of the foot; they proceed with the branches of the saphena minor vein in the direction of the external malleolus, from thence to the outer edge of the tendo Achillis, where they glide with the vein under the fascia of the leg to reach the centre of the gastrocnemius muscle, between the heads of which they dip to join the popliteal glands. The superficial lymphatics which accompany the saphena major vein commence on the dorsal surface of the toes, where they communicate with the digital lymphatics. On the dorsum of the foot they ascend in from three to six branches; the most internal mount over the internal malleolus with the branches of the saphena major vein to the inside of the knee; the most external pass over the external malleolus and outer side of the leg, at a higher or lower level however, they are directed inwards and pass over the spine and inner surface of the tibia to join the former, at the inner side of the knee; those from the centre part of the dorsum of the foot ascend in front of the tibia; these also soon tend inwards to be associated with the rest.

Another set take origin from the sole of the foot and proceed upwards on the back of the leg superficial to the fascia, having communicated freely with the lymphatics accompanying the saphena minor vein. These also sooner or later turn inwards to gain the inside of the knee. From these sources some twelve or fifteen branches may be enumerated, which continue to ascend on the inside of the thigh with the saphena major vein. Some few pass under the fascia lata to join the deep-seated vessels. From the back of the leg and thigh they receive an accession to their numbers of several vessels; the most of these reach them from the inside, but some few from the outside of the limb. They ultimately terminate in the superficial cluster of glands in the groin. Some few, however, may dip down to join the deep-seated glands and to unite with the deep-seated lymphatics. One may occasionally be seen to pass the inguinal glands to reach those accompanying the external iliac artery.

The inguinal glands also receive the super-

Fig. 55.



Superficial lymphatics of the lower extremity.
(After Mascagni.)

- c, c,* Commencing branches.
- d,* Lymphatic vessels passing from the outer to the posterior part of the leg to gain its inner surface.
- e,* Vessels passing from the outer to the posterior part of the thigh to gain its inner surface.
- f,* Vessels passing from the outer to the anterior part of the leg to gain its inner surface.
- g,* Vessels passing from the outer to the anterior part of the thigh to gain its inner surface.

ficial lymphatics from the genitals, from the lower half of the anterior and posterior part of the trunk, from the perineal and gluteal regions. The lymphatics of the scrotum collect into one or two branches, which take their course with the superficial pudic veins to reach the glands in the groin. Those of the penis commencing on the glans and prepuce proceed generally in three principal branches on the body of the organ, two of which are situated laterally, and the third on the centre of its dorsal surface. These three vessels not unfrequently unite near the root of the penis into one vessel, which immediately divides right and left into branches, which also accom-

pany the superficial pudic veins to the inguinal glands. In the direction of the superficial epigastric and circumflexa ilii veins there are several lymphatics derived from the anterior and lateral parts of the abdomen, which empty themselves in the inguinal glands. The superficial lymphatics from the perineal and gluteal regions, some from the loins and posterior and upper part of the thigh, stream round the outer part of the limb in the neighbourhood of the trochanter major to terminate in the same glands.

The vasa efferentia of the inguinal glands, three or four in number, are much larger than the vasa inferentia; they receive the contents of all the lymphatics hitherto described, and pass under Poupart's ligament with the femoral artery and vein to become the vasa inferentia of the glands associated with the external iliac artery. From the anterior and lateral muscular paries of the abdomen, the lymphatics accompany the epigastric and circumflexa ilii arteries, and terminate in the external iliac glands. The external iliac glands are also joined by the vasa efferentia from the glands accompanying the internal iliac artery. These latter receive the lymphatics, associated with the gluteal, ischiatic, and obturatoria arteries, which enter the pelvis by the same openings as the arteries which they accompany. The lymphatics from the prostate gland and vesiculæ seminales, from the bladder and rectum, from the vagina and uterus, those accompanying the internal pudic vessels derived from the interior of the penis and clitoris, and those from the walls of the pelvis, all terminate in the internal iliac glands.

The glands accompanying the common iliac artery, on the one hand, receive their efferent vessels from the internal and external iliac glands, and on the other give their efferent vessels to those, associated with the aorta, which constitute the lumbar glands.

The lymphatics of the testicle, of the kidneys, and renal capsules, those accompanying the lumbar arteries, the lymphatics of the rectum, sigmoid flexure and descending portion of the colon, all terminate in the lumbar glands. Those from the testicle are derived from the interior as well as from the surface of the organ; they take their course upwards with the spermatic arteries and veins in several branches, to reach the renal and lumbar glands.

The lymphatics of the kidneys emerge from its substance at the fissure of the organ, having taken their course with its bloodvessels, where they are joined by the superficial vessels; they pass through the small renal glands, and ultimately reach the lumbar glands.

The lymphatics of the renal capsules unite chiefly with those of the kidneys, but also on the left side with those of the spleen, and on the right with those of the liver. They are at length conducted to the lumbar glands. The lymphatics accompanying the lumbar arteries receive their branches from the structures supplied by those arteries, and empty themselves into the lumbar glands. The lymphatics from the descending colon, from its sigmoid flexure,

and from the rectum, take somewhat the course of the inferior mesenteric artery and its branches; they pass through their appropriate glands, and are ultimately received by the lumbar glands.

The vasa efferentia of the lumbar glands cannot be said to receive the contents of all the vessels and glands hitherto described; they, in fact, empty themselves into the principal lymphatics by whose union the thoracic duct is formed, or into the duct itself soon after its formation. The principal lymphatics above alluded to may be traced more or less distinctly from Poupart's ligament to the second lumbar vertebra, where they usually unite to form the thoracic duct, the vessels of opposite sides communicating freely with each other.

Their position and arrangement will be well understood by the accompanying wood-cut.

Fig. 56.

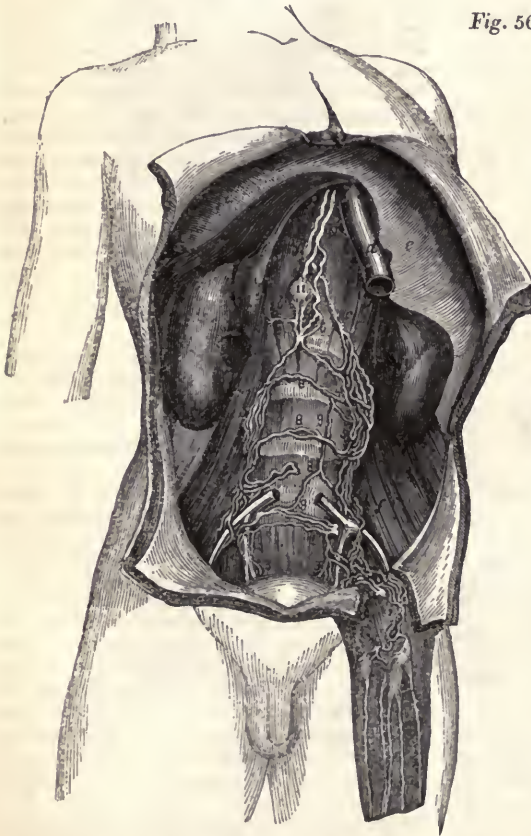

psœ muscles, to communicate freely by cross branches, and opposite to about the third lumbar vertebra to pass inwards, on the right side behind the cava, on the left behind the aorta to unite into one vessel on the body of the second lumbar vertebra, behind the root of the right renal artery, and thus to form the commencement of the thoracic duct. In the subject from which the drawing was taken the branches did not unite in the abdominal cavity. Two nearly equal-sized vessels ascended into the thorax, which, however, soon coalesced. The union generally takes place opposite the abrupt dilatation marked No. 11, and which would be termed the receptaculum chyli, although the lacteals generally enter above this point.

The lacteals, properly so called, take origin from the small intestines. During the process of digestion they contain a white fluid, the chyle, but at other times their contents are colourless like those of the rest of the lymphatic

Fig. 56. *Shewing the principal lymphatic branches of the inguinal, iliac, and lumbar regions, into which the vasa efferentia of the glands of these regions empty themselves, and by the convergence and union of which the thoracic duct is generally formed on the body of the second lumbar vertebra. Shewing also in this instance an abrupt globular dilatation in the position of the receptaculum chyli, and a double thoracic duct.*—(From a dissection.)

- a, The body of the second lumbar vertebra.
- b, The right crus of the diaphragm.
- c, The left crus of the diaphragm.
- d, The abdominal aorta displaced.
- e, The diaphragm.
- f, Psoas muscle.
- 1, Vasa efferentia of the inguinal glands.
- 2, Their vasa efferentia.
- 3, The principal branches associated with the internal inguinal glands.
- 4, Those accompanying the external and common iliac glands.
- 5, Those accompanying the lumbar glands.
- 6, The convergence of the vessels of opposite sides.
- 7 and 10, The trunks from the left and right sides, which in this instance did not unite (as is usually the case) to form the thoracic duct, but passed separately into the cavity of the thorax.
- 8, Transverse communications between the vessels of opposite sides.
- 9, A communication between the transverse branches in the vertical direction.
- 11, The receptaculum chyli, in this instance remarkably abrupt, and of a globular form.

In the dissection from which this wood-cut was taken, the injection did not pass freely into the glands, from which circumstance the vessels are more distinctly seen, as it permitted the glands which partly concealed them to be removed without causing extravasation. These vessels, after taking somewhat the course of the external, internal, and common iliac arteries, may be seen to ascend pretty close to the inner edges of the

lymphatic system; they are joined by the lymphatics of the caput coli, the ascending and transverse colon; they also communicate with the lymphatics of the liver, spleen, pancreas, and stomach. The more modern opinion is, that the lacteals commence from the villi and from the spaces between the villi in the small intestines, not by open mouths, but by a delicate network of vessels, through the coats of which

the chyle is supposed to enter by imbibition. This incipient net-work of lacteals terminates at the roots of the villi in branches, which perforate the muscular coats of the intestines, the trunks of which may be easily distinguished under the serous coat, taking a transverse course to gain the cellular interval between the layers of the mesentery. These are what may be termed the deep-seated lymphatics of the intestines which alone contain the chyle, but there are superficial lymphatics belonging to the intestines situated immediately under the peritoneal coat, which take a longitudinal course and join the deep-seated vessels. From the intestine the principal branches pass in nearly straight lines between the layers of the mesentery, where they traverse the mesenteric glands to accumulate from every portion of the small intestine around the trunk of the superior mesenteric artery. The lymphatics from the cœcum, the ascending and transverse colon, which have passed through their appropriate glands and have accompanied more or less the ilio-colic and colic arteries between the layers of the meso-colon, now join the lacteal vessels. The vasa efferentia from the mesenteric glands form two or more trunks, which, conducted by the root of the superior mesenteric artery, reach the thoracic duct, into which they empty their contents just above its commencement.

The lymphatics of the stomach chiefly accompany the bloodvessels. Those associated with the vasa brevia and with the left gastro-epiploic vessels, having passed through their glands unite with the lymphatics from the spleen. Those accompanying the right gastro-epiploic vessels having traversed their glands communicate behind the pyloric extremity of the stomach and at the commencement of the duodenum, with the lacteals, and with the lymphatics from the liver. At the upper curvature of the stomach, the lymphatics take their course from the cardiac to the pyloric orifice accompanying the branches of the coronaria ventriculi arteries, they pass through the glands there situated, and join the lymphatics descending from the liver in the capsule of Glisson.

The lymphatics of the pancreas near the head of the organ communicate with the lacteal vessels from the duodenum; the rest empty themselves into the lymphatics coming from the spleen.

At the hilum of the spleen the deep-seated lymphatics which have accompanied the bloodvessels in the substance of the organ are joined by the superficial vessels. The principal branches having in their course received lymphatics from the stomach and pancreas, and having traversed the splenic glands, accompany the trunks of the splenic artery and vein, and unite with the lymphatics of the liver in their course to the thoracic duct.

The deep-seated lymphatics of the liver accompany the ramifications of the portal vessels throughout the substance of the organ; they emerge with the hepatic ducts at the transverse fissure of the liver, where they are joined by the lymphatics of the gall-bladder and by the superficial lymphatics from the

under surface of the liver. They pass through the glands situated in the capsule of Glisson, receive free communications from the splenic and gastric lymphatics, and ultimately terminate in the thoracic duct either separately or in conjunction with the lacteal trunks.

The superficial lymphatics of the upper surface of the liver form three or four fasciculi, which enter the thorax without joining the trunks of the deep-seated vessels. One set streams from the upper surface of the right, another from that of the left lobe to gain the suspensory ligament of the liver, between the folds of which the larger branches, six or eight in number, pass upwards and enter the thorax between the attachment of the diaphragm and the ensiform cartilage to gain the anterior mediastinum, where they join the large lymphatic vessels accompanying the arteriæ mammariæ internæ. From the right and left lobes in the neighbourhood of the lateral ligaments, and chiefly, though not entirely, from the upper surface of the organ, two other streams of superficial lymphatics tend towards the lateral ligaments, between the layers of which the principal branches pass. They perforate the diaphragm to gain its upper surface, some of them passing backwards to reach the thoracic duct in the posterior mediastinum, while others form a large vessel which creeps upon the thoracic surface of the diaphragm under the pleura and near the margin of the ribs, to gain the anterior mediastinum, where on each side it unites and terminates with those vessels which have arrived at the same point from between the folds of the suspensory ligament. The lymphatics of the left lateral ligament often, however, pass downwards to the abdominal cavity, joining the lymphatics of the under surface of the liver or of the cardiac extremity of the stomach.

The thoracic duct receives but four branches during its passage through the thorax; the lymphatics of the lungs and of the heart, as well as the large branches accompanying the mammariæ internæ vessels, make their exit from the thoracic cavity, to empty themselves into the two lymphatic trunks in the cervical region. The intercostal lymphatics accompanying the intercostal bloodvessels, traverse the little glands situated near the necks of the ribs, take their course to and enter the larger glands in the posterior mediastinum. These same glands also receive the œsophageal lymphatics, and even some communications from the bronchial glands; their vasa efferentia, four or five in number, enter the thoracic duct at different levels.

The large lymphatics accompanying the mammariæ internæ arteries collect their branches from various sources; those from the liver have been already noticed; some pass through the intercostal spaces close to the edges of the sternum: some have accompanied the intercostal branches of the mammariæ internæ vessels; others are received from the thymus gland and pericardium and pleura. The greater part of these vessels pass through the little glands situated in the anterior mediastinum before they

are received into the principal branches. These latter pass upwards in front of the transverse vein, to empty themselves on the left side into the termination of the thoracic duct; on the right, into the right lymphatic trunk, or they join the large veins separately, close to the entrance of the two trunks of the system.

The lymphatics of the lungs are of large size, and are divided, as in other parts of the body, into a superficial and deep-seated set. The latter accompany the ramifications of the bloodvessels and air-tubes throughout the texture of the organ, and communicate at various points with the superficial vessels. The principal branches escape from the lung at its root, where they are joined by the superficial vessels, and pass with them through the large bronchial glands. The superficial lymphatics of the lung are larger than those of any other viscus; they are situated in the interlobular fissures immediately under the pleura, and are injected with greater facility than the lymphatics of other parts of the body; their principal branches pass from the surface of the lung towards the inner edge and root of the organ, where they unite with the deep-seated vessels, and pass with them through the bronchial glands. The vasa efferentia of these glands having communicated with the glands in the posterior mediastinum pass upwards on the trachea, where they meet with other glands with which they interchange branches; having entered the cervical region with the trachea, they unite freely with other lymphatics, especially with those of the thyroid gland, and ultimately terminate, on the left side, in the thoracic duct; on the right, in the right lymphatic trunk, or separately in the large veins.

The lymphatics of the heart are neither large nor numerous; they proceed both from the substance and from the surface of the organ accompanying the principal bloodvessels; their appropriate glands are chiefly situated on the ascending thoracic aorta and trunk of the pulmonary artery; where these vessels are covered by the pericardium, they ascend in front of the arch of the aorta, pass between the sternum and transverse veins, communicate freely with the large vessels of the anterior mediastinum, and terminate with them on either side in the trunks of the system, the greater number, however, passing on the left sides to the thoracic duct.

The deep-seated lymphatics of the upper extremity successively accompany the digital arteries, the superficial and deep palmar arches, the radial, ulnar, and interosseous arteries. At least two lymphatic vessels accompany each artery; they communicate by short transverse branches with each other, and also at different points with the superficial lymphatics. At the bend of the elbows they unite into three or four vessels which pass up the arm with the brachial artery to gain the axillary glands, into which they empty themselves. The small glands which not unfrequently may be found accompanying the brachial artery, and even, but more rarely, the ulnar or radial vessels do not generally intercept the deep lymphatic

Fig. 57.

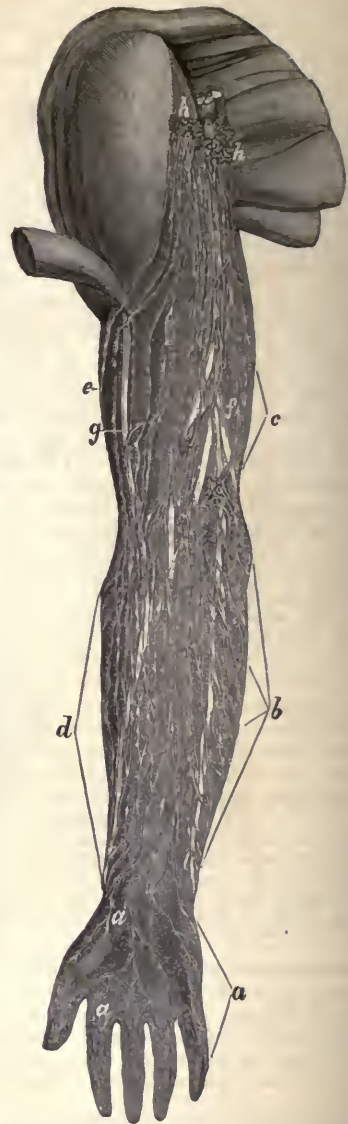

Superficial lymphatics of the upper extremity.
(After Mascagni.)

a, a, Commencing lymphatic vessels ascending in the forearm with branches of the median vein.

b, c, d, The continuations of the vessels similarly marked in the former woodcut.

e, A vessel passing from the posterior to the anterior surface of the arm over its outer edge.

f, Branches of the basilic vein.

g, Cephalic vein.

h, Axillary glands.

i, Two small glands situated above the internal condyle.

vessels, but the latter rather receive the efferent vessels from these glands, they having collected their afferent vessels from the surrounding textures.

Fig. 58.

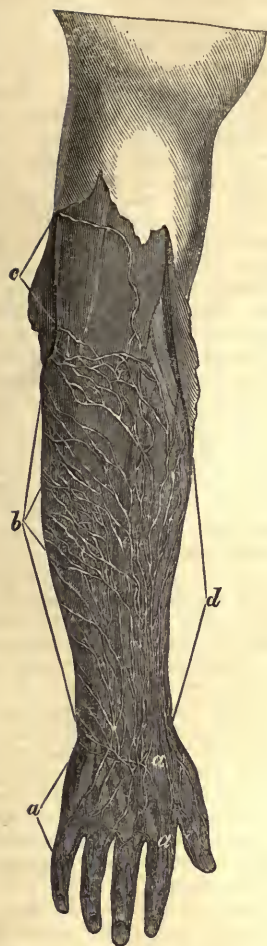

Superficial lymphatics of the upper extremity.
(After Mascagni.)

a, a, Commencing lymphatic vessels which accompany the branches of the cephalic and basilic veins.

b, Lymphatic vessels passing from the posterior to the anterior surface of the forearm over its inner edge, with branches of the basilic vein.

d, Lymphatic vessels passing from the posterior to the anterior surface of the forearm over its outer edge, with branches of the cephalic vein.

c, Lymphatic vessels passing from the posterior to the anterior surface of the arm over its inner edge.

The superficial lymphatics of the upper extremity in their passage to the axillary glands follow more or less the course of the subcutaneous veins. Those which accompany the cephalic and basilic veins commence on the dorsal surface of the fingers, where they communicate with the digital lymphatics; from thence they proceed over the metacarpus to the posterior surface of the forearm, tending with their accompanying veins towards its ulnar and ra-

dial edges, over which, sooner or later, they pass to gain the anterior surface, and at the bend of the elbow they have all collected in the neighbourhood of the internal condyle. The lymphatics accompanying the median vein take origin from the palmar surface of the fingers, where they communicate with the digital lymphatics; they take their course upwards first on the palm of the hand, then on the anterior surface of the forearm, and at the bend of the elbow join those already traced to the same point. The great majority of these vessels now continue their course upwards over the internal condyle to the inner side of the arm, some of them traversing the little gland or glands situated just above the internal condyle; from thence they take the nearest route to gain the axillary glands, of which they form the principal vasa inferentia. Some three or four of the lymphatics, which in the forearm were associated with the branches of the cephalic vein as far as the bend of the elbow, separate themselves from the rest, and ascend with this accompanying vein on the outer side of the biceps, and in the interval between the deltoid and pectoralis major muscles, where they meet with a gland which they traverse and ultimately pass with the vein over the pectoralis minor muscle to gain the deep-seated lymphatics accompanying the axillary artery.

The axillary glands collect their vasa inferentia also from the upper half of the anterior, posterior, and lateral surfaces of the trunk. From the anterior surface those on the abdomen above the umbilicus ascend; those on the upper part of the chest, joined by some from the cervical region, descend; those on a level with the axilla from the pectoral muscles and the glands of the breast take a transverse direction—all in short converging towards the axilla, where the glands in which they terminate are situated. From the posterior surface of the trunk in a similar way they concentrate from the lumbar, cervical, and dorsal regions to pass over the posterior border of the axilla to reach the same glands.

The vasa efferentia of the axillary glands, four or five only in number, but of large size, receive the lymph conveyed to these glands from the various sources just described; they pass associated with the axillary vessels under the subclavius muscle, unite into one or two branches, which usually pass over the subclavian vein, to terminate either separately in this vein, close to its union with the internal jugular, or else join the lymphatic trunks.

The lymphatics of the head and face may be divided as in other parts of the body into the superficial and the deep-seated. They all have to pass through the glands situated in the cervical region. The superficial accompany principally the veins of the head and face. Those from the head form two groups: one anterior associated with the temporal veins, descends in front of the ear, joins the small glands situated at the root of the zygoma, and in the substance of the parotid gland; it passes with the temporal vein through that gland and below the angle of the jaw continues to

follow the course of the vein over the digastric and stylo-hyoid muscles, where it meets with lymphatic glands which it enters; the posterior group accompanies the occipital and posterior auricular veins, traverses the glands behind the mastoid process, and afterwards those situated at the back and upper part of the neck. The facial lymphatics, like the facial veins, receive branches from the forehead and eyelids, pass from the inner canthus of the eye along the side of the nose and over the buccinator muscle, where they meet with one or two small glands; they then gain the anterior edge of the masseter, from whence they pass below the margin of the jaw, to traverse the glands there situated. These three groups of vessels communicate freely with each other in the cervical glands, and are joined by some of the deep-seated lymphatics. These latter may be divided into those of the cranium and those of the face; the former as well as the lymphatics of the interior of the orbit are not sufficiently known to admit of our stating the exact course which they take. Fohmann and Mascagni both conceive that they have discovered the lymphatics of the brain and its membranes and have had them delineated in their published plates; but they differ so materially from each other, and their descriptions are so far from satisfactory that we must be content to say that we are ignorant not only of the course they take but even of their existence. Fohmann represents them to be very large and numerous, situated principally between the arachnoid membrane and pia mater, while Mascagni figures them on the pia mater as exceedingly small and as accompanying some of the veins; others are also depicted as associated with the meningeal vessels; the trunks of these vessels are supposed to descend with the carotid, vertebral, and meningeal arteries and with the internal jugular veins; while Fohmann throws out a hint that they may terminate in the venous system within the cranium.

The deep-seated lymphatics of the face are associated with the bloodvessels; those accompanying the internal maxillary arteries enter the gland or glands in the substance of the parotid, and join the temporal lymphatics. The rest accompanying their bloodvessels reach the upper cervical glands, and communicate freely with the superficial lymphatics already traced to the same glands; the further progress of the lymphatics in the neck is regulated by the position of the glands, which it will be remembered form two groups, one situated between the sterno-mastoid muscle and the trachea, and associated more with the internal jugular vein, the other located in the cellular interval between the sterno-mastoid and trapezius muscles in the neighbourhood of the external jugular. The former receives the lymphatics from the tongue, pharynx, and larynx, and lower down from the thyroid gland, trachea, and œsophagus; while the latter collects them from the muscles of the posterior region of the neck and of the shoulder. The afferent and efferent vessels of these two

series of glands have frequent communications with each other. At the root of the neck they unite freely with the lymphatics emerging from the chest and with those of the upper extremities, until ultimately one large vessel is formed on either side, which receives the contents of the whole, and which terminates either by opening separately into the internal jugular vein close to the entrance of the lymphatic trunk, or into that trunk itself.

(S. Lane.)

LYMPHATIC SYSTEM, ABNORMAL ANATOMY.—The congenital variations from the normal distribution of the lymphatic system which have naturally most attracted attention are those of the thoracic duct, or of the right lymphatic trunk; the remainder of the system lying too minute for general investigation, and the mode of its examination being within the scope of only a few.

The thoracic duct frequently varies as to the precise point at which it opens into the venous system, sometimes opening into the subclavian vein, at others into the jugular. A very striking departure of it from its usual arrangement is when it is found opening into the veins on the right side, just as it ordinarily does on the left. I saw an instance of this during the winter of 1834, in the body of a child dissected by Mr. Skey. The duct followed its usual course as high as the fifth dorsal vertebra; it then inclined to the right side, and opened into the angle between the right jugular and subclavian veins. It was remarkable that in this subject the right subclavian artery was abnormal in its mode of origin; it arose from the extreme left portion of the arch of the aorta, and passed to its destination behind the trachea and œsophagus. A similar transposition of the thoracic duct occurs in cases of general transposition of the viscera.

The thoracic ducts have been found sometimes both terminating on the same side, sometimes on opposite sides. It has also been found dividing into two large trunks which pass upwards parallel to each other for a considerable distance, and then unite again. Varieties have been observed as regards its mode of opening into the jugular and subclavian veins. Instead of terminating as a single trunk, it has been found to subdivide into two or three branches, which open separately into the subclavian or jugular veins. At its termination the duct experiences generally some degree of dilatation—in some instances I have seen this so considerable as to have the appearance of an aneurismal enlargement. The duct has likewise been found to empty itself into the vena azygos. In the pig, according to Panizza, a communication between the duct and this vein is constant and normal.

The varieties in the course and distribution of the lymphatic vessels and in the number and position of the glands are doubtless as numerous as those of the veins.

The diseased states of this system may be examined, first, as regards the lymphatic and lacteal vessels; secondly, with reference to the

absorbent glands; and, thirdly, with respect to the nature of the contents of the system.

Inflammation of the absorbent vessels has long been known to practical men. A number of red lines appearing through the skin, and giving to the touch the sensation of round and hard cords immediately underneath the skin, taking the direction and occupying the position of the superficial lymphatics, are seen to proceed from some point of irritation, as a poisoned wound or a syphilitic sore, towards the nearest set of absorbent glands. There are much tenderness and pain on the least pressure in the whole course of these lines, and the glands to which they go are more or less swollen, and the skin over them is of a reddish colour. These lines correspond to the inflamed absorbents, which, at first isolated, soon excite inflammation in the surrounding cellular tissue, and the hard cords above described are lost in the thickened and infiltrated subcutaneous tissue. When an incision is made into such an inflamed surface, the lymphatics, according to Gendrin, are seen upon the margins of the incision as red fibres, having the irregular, knotted appearance which those vessels exhibit when injected with mercury and converging towards the inflamed tissue of a gland.

It may be fairly presumed that the anatomical characters of these vessels in a state of inflammation are the same as those of the inflamed thoracic duct, examples of which have occurred to Gendrin and Andral. The vessels of its coats (*vasa vasorum*) are much injected, and the coats themselves thickened and rendered friable—the inner coat red, soft, and swollen—sometimes with lymph poured out upon it, which tends to obstruct and obliterate the canal, giving rise to dilatation below the obstructed point, or with pus effused, which also occasions the vessels to be dilated. Sir A. Cooper found adhesion and ulceration of the valves of the thoracic duct in a body in which he could not succeed in injecting that vessel.

In the body of a phthisical patient Andral found the lacteal vessels on the surface of the intestine, corresponding to the situation of an ulceration of the mucous membrane, remarkably white and hard, and so dilated at intervals as to resemble a string of rounded nodules. On examination these nodules were found to be caused by thickening of the coats of the lacteal vessels.

Irregular dilatations or varicosities of the absorbent vessels, but especially of the thoracic duct, have been very frequently observed. These most frequently arise from some pressure impeding the circulation of the fluid in them, as a tumour or aneurism pressing on the thoracic duct in some part of its course. Mr. Cruikshank delineates a thoracic duct, remarkable for its great size. It was found in a man 40 years of age, but the cause of the dilatation was not apparent, as no obstruction existed either at the entrance of the vessel into the veins or in any part of its course. The great trunks of the absorbents accompanying the large arteries in the extremities were en-

larged also, but the cutaneous absorbents were of their usual size. The case referred to by Dr. Baillie, in which the duct is said to be as large as the vena azygos, is probably the same.

The morbid changes of the absorbent glands are much more familiar to us than those of the lymphatics themselves, as being more appreciable if not of more frequent occurrence. Inflammatory states of these bodies are very often met with, either in conjunction with inflamed lymphatic vessels or alone. In inflammation the absorbent glands become enlarged, very vascular, and painful to the touch, and the surrounding cellular tissue participates in the inflammation, so that if several glands be inflamed a tumour of some size and hardness will be formed. The tissue of the absorbent glands themselves is not prone to run into suppuration, but pus will often speedily form in the surrounding and connecting cellular tissue, which by-and-bye accumulates, forms an abscess, is discharged, and leaves the glands, with the intervening cellular tissue, dissected away by the suppurative and sloughing process. It is thus that a bubo will originate from one or more inflamed inguinal or axillary glands, and when the constitution is enfeebled and favourable to a phagedenic action, we frequently find these glands exposed by the destruction of the skin and cellular tissue. Sometimes, however, little collections of pus form in the glands themselves, and, according to Gendrin, the fluid in the glands differs remarkably from that in the cellular tissue, the latter being thick, opaque, viscid, and of a greenish hue, whilst the former is clear, transparent, and almost colourless. Gendrin infers from his observations that the lymphatics which permeate the inflamed glands become obliterated; but Dr. Bocher, a German anatomist, quoted by Andral, affirms that he repeatedly injected with mercury lymphatic ganglions presenting different forms of morbid alteration, and that he invariably found the injection pass freely through all the convolutions of vessels, whence he concludes that in diseases of these ganglions the lesion is, at least in the great majority of cases, confined to the cellular tissue that unites the convolutions of the vessels, or to the coats of the vessels, but that there is no obstruction of their cavity. The lymphatic glands are also liable to be chronically inflamed, or to be hypertrophied, and under both conditions put on the same anatomical characters, viz. redness, increased size, induration. In children, of both sexes, the glands at the angle of the jaw and those of the neck frequently afford examples of these morbid states. The bronchial and mesenteric glands likewise present similar enlargements. Atrophy of the absorbents occurs very commonly in old persons.

Various deposits are met with in the absorbent glands. Of these the most frequent is tubercle, or a cheesy curdy matter of a yellowish hue, which bears much resemblance to tubercle. This matter is deposited in isolated spots in the glands, or else appears to be infiltrated throughout their substance. In phthisical subjects, in scrofulous patients, these deposits

are usually met with. The cervical, bronchial, and mesenteric glands are those most frequently affected, but all the absorbent glands are very often engaged. Louis states that in phthisis* the relative frequency of tuberculization of these glands is as follows,—the mesenteric, meso-cœcal, meso-colic, cervical, lumbar, and axillary glands, and that the bronchial glands are as often affected as the mesenteric.

The glands affected in children observe nearly the same order as regards the relative frequency of the affection. They are always much enlarged, and frequently closely adherent to each other or neighbouring textures; and the cheesy matter either infiltrates the tissue or is deposited in small portions in the glands. In an infant, which I had lately under my care in conjunction with Mr. Holt, it was found, upon post-mortem inspection, that the severe cough with remittent dyspnœa, under which the child sunk, was owing to a mass of enlarged bronchial glands, of the size of a hen's egg, filled with cheesy matter, pressing on the primary bronchi and on the pulmonary plexus of nerves.

Cancer, melanosis, and encephaloid matter are frequently found in these bodies, especially when other organs have been similarly affected. Deposits of calcareous matter are likewise often met with in them, and as far as my experience goes, in none more frequently than in the bronchial glands; these deposits occur generally in old subjects; they consist of phosphate of lime. It has been suggested that this calcareous phosphate might be derived from the earthy matter of the bones; and Andral relates two remarkable cases in which there was a coincidence between the deficiency of a certain quantity of osseous matter where it should naturally be deposited and its deposition in the lymphatic system. In one, a boy æt. 16, the bronchial, mesenteric, and pelvic glands were occupied by calcareous concretions, and his lungs also contained them; there was also an abscess in one of the iliac fossæ, with erosion and destruction of the os ilii. In a second case, a woman, æt. 33, who died of acute pleuritis, supervening upon a chronic pulmonary affection, the bodies of six vertebræ, the last dorsal and five lumbar, were found destroyed, and calcareous concretions were found in the cervical, thoracic, bronchial, abdominal, pelvic, axillary, and inguinal glands.

The black matter which is so often found in the bronchial glands must not be confounded with melanoid matter. We seldom examine a body that has passed adult age without finding more or less of this matter in the bronchial glands, derived doubtless from the pulmonary black matter, which is conveyed to these glands by the pulmonary lymphatics.

The changes which occur in the lymph itself have not as yet received any attention from pathologists. This fluid is, however, occasionally either mixed with or replaced by others in the lymphatic vessels. Cases are on record (Majendie, Dupuytren) in which it is stated that

the lymphatics in the neighbourhood of sanguineous effusions into the pleura and peritoneum have been filled with blood, and that pus had been absorbed into them from a neighbouring abscess. Such cases require confirmation with our present improved means of observation, as it is difficult to understand how particles so large as the blood corpuscles, or the globules of pus, could have permeated the coats of the absorbent vessels. In future the microscope must be brought to our aid in the examination of such cases. Authors relate likewise that bile has been found in the lymphatics of the liver and in its neighbourhood, in cases where the flow of that fluid has been obstructed, (Mascagni, Saunders;) and Tiedemann states that in dogs, in which he had tied the hepatic duct, the biliary secretion likewise made its way into the lymphatics. Earthy matter, as in the glands, has also been found in the vessels themselves, and the tubercular, encephaloid, or cancerous matter has likewise been met with stopping up these vessels.

For *Bibliography*, see that of ABSORPTION.

(R. B. Todd.)

MAMMALIA.—(Lat. *Mamma*, a teat; Ger. *Säugethiere*; Fr. *Mammifères*; Eng. *Mammals*.)—The most highly organized class of animals, distinguished outwardly by a total or partial covering of hair, and generally by having external teats or mammæ, whence the name. Mammals always possess mammary glands, and suckle their young; the fœtus is developed in the womb; their leading anatomical character is to have lungs composed of a highly vascular and minutely cellular structure throughout, and suspended freely in a thoracic cavity, separated by a muscular and tendinous septum or diaphragm from the abdomen.

Mammals, like birds, have a heart composed of two ventricles and two auricles: they respire quickly, and have warm blood; inspiration is performed chiefly by the agency of the diaphragm: the right auriculo-ventricular valve is membranous, at least never entirely fleshy; and the aorta bends over the left, never over the right bronchial tube. The primary branches of the aorta are given off, not immediately after, but at a little distance from its origin, and there is less constancy in the order of their origin than in birds: the phrenic arteries, the cœliac axis, and the superior mesenteric artery are always branches of the abdominal aorta, which terminates by dividing beyond the kidneys into the iliac arteries, from which spring both the femoral and ischiadic branches. The caudal or sacro-median artery, which in some long-tailed Mammals assumes the character of the continued trunk of the aorta, never distributes arteries to the kidneys or legs, as in birds. The kidneys are nourished, and derive the material of their secretion, exclusively from the arterial system: their veins are simple, commencing by minute capillaries in the parenchyma, and terminating generally by a single trunk on each side, in the abdominal

* Dr. Cowan's translation, p. 73.

vena cava : they never anastomose with the mesenteric veins.

The kidneys are relatively smaller, and present a more compact figure than in the other vertebrate classes ; their parenchyma is divided into a cortical and medullary portion, and the secreting tubuli terminate in a dilatation of the excretory duct called the pelvis. The tubuli uriniferi are slightly branched, and the ramification takes place in the dichotomous, and not pinnatifid manner : they are convoluted in the cortical, and straight in the medullary portions of the kidney, and with a few exceptions terminate upon valvular prominences, called mammillæ. The ureters convey the urine to a urinary bladder situated anterior to the rectum, and to the genital tubes or cavities. The liver is generally divided into a greater number of lobes than in birds. The portal system is formed by veins derived exclusively from the spleen and chylipoietic viscera. The cystic duct, when it exists, always joins the hepatic, and does not enter the duodenum separately. The pancreatic duct is commonly single.

The mouth is closed by soft flexible muscular lips. The upper jaw is composed of palatine, maxillary, and intermaxillary bones, and is fixed ; the lower jaw consists of two rami, which are simple, or formed by one bony piece, and are articulated by a convex or flat condyle to the base of the zygomatic process, and not to the tympanic element of the temporal bone ; the base of the coronoid process generally extends along the space between the condyloid and the alveolar processes. The jaws of Mammals, with few exceptions, are provided with teeth, which are arranged in a single row ; they are always lodged in sockets, and never ankylosed with the substance of the jaw ; in most cases they present different forms in the same individual, and the molars have two or more fangs. Never more than two teeth succeed each other in the vertical direction, and in this case the fang of the deciduous tooth is always completed before it is shed. The tongue is fleshy, well developed, with the apex more or less free. The posterior nares are protected by a soft palate, and the larynx by an epiglottis ; the rings of the trachea are generally cartilaginous and incomplete behind : there is no inferior larynx. The œsophagus is continued without partial dilatations to the stomach, which varies in its structure according to the nature of the food, or the quantity of nutriment to be extracted therefrom. An epiploon of greater or less extent is continued from the great curvature of the stomach. The termination of the duodenum is generally tied closely to the spine, above the root of the mesentery. The colon is suspended generally by a distinct duplicature of peritoneum, called the meso-colon : the *cæcum coli* when present is usually single. The rectum commonly terminates by an aperture distinct from that of the urinary or genital canals.

The female generative organs consist of two ovaries, which with very few exceptions are equally developed ; there are always two ovi-

ducts or Fallopian tubes, a simple or more or less completely bifid uterus, a vagina, which is commonly single, and a clitoris. The essential element of the ovum, the germinal vesicle, acquires a surrounding granular stratum (tunica granulosa), a small vitelline mass, and a vitelline membrane, before it quits the ovisac. The ovisacs or Graafian vesicles, consisting of an ovarian vesicle and a vascular layer of the condensed cellular tissue, or stroma of the ovary, are never pendent, and rarely racemose.

The male organs consist of two equally developed testes, commonly situated in an external tegumentary pouch or scrotum : the vasa deferentia form an epididymis at their commencement, and frequently communicate with the ducts of vesiculæ seminales at their termination, and the semen is conveyed outwardly along a complete urethral canal, where it is mingled with the secretion of certain accessory glands, of which those called "Cowperian," or "preprostatic," are constant ; there are also generally prostatic and in many cases vesicular glands. The penis is always perforated by an urethral canal, along which, with very few exceptions, the urine as well as the semen is conducted from the body.

The true vertebræ of Mammalia have their bodies ossified from three centres, and present for a longer or shorter period of life a compressed epiphysis at each extremity. They are articulated by concentric ligaments with interposed glairy fluid, forming what are called the intervertebral substances ; the articulating surfaces are generally flattened, but sometimes, as in the neck of certain Ruminants, they are concave at one end and convex at the other ; such a vertebra, however, may be distinguished from a vertebra of a Reptile, with a similar ball-and-socket structure of the articular surfaces, even when found in a fossil state, and when the test of the articulating medium cannot be applied, by the constant ankylosis or confluence of the annular with the central part or body. The cervical vertebræ, with one or two exceptions, are seven in number, neither more nor less ; the Monotremes, which are the instances commonly opposed to other generalizations, form no exception to this rule. The lumbar vertebræ are more constant and more numerous than in other classes of vertebrate animals. The atlas is articulated by concave articular processes to two convex condyles, which are developed from the ex-occipital elements of the last cranial vertebra. The tympanic element of the temporal bone is restricted in function to a subserviency to the organ of hearing, and never enters into the articulation of the lower jaw. The frontal bones are developed each from a single centre ; there are no anterior or posterior frontals. The olfactory nerves escape from the cranial cavity through numerous foramina of a cribriform plate. The optic foramina are always distinct from one another, and generally from the fissuræ lacæræ anteriores, and consequently give passage only to the optic nerves and ophthalmic arteries. The carotid canals do not intercommunicate. The cranial bones, in regard to the

number and persistency of their sutures, are intermediate in character to those of Birds and Reptiles. The anterior extremity of the skull is always formed by both the upper and lower jaws. The scapula is generally an expanded plate of bone; the coracoid, with two exceptions, appears as a small process of the scapula: the clavicle is inconstant as to its presence; the sternum consists of a narrow and usually simple series of bones; the sternal portions of the ribs are generally cartilaginous, and fixed to the vertebral portions without the interposition of a distinct articulation; there are no abdominal ribs or abdominal sternum. The pubic and ischial arches are generally complete, and united together by bony confluence on the sternal aspect, so that the interspace of the two bony pelvic arches is converted into two holes, called *foramina obturatoria*, or *thyroidea*.

The brain in Mammalia consists of cerebral and optic lobes, cerebellum and medulla oblongata, but the optic lobes are placed on the upper part of the crura cerebri, are solid, are always divided by a transverse fissure, and are generally concealed by the cerebral lobes, in consequence of the large relative size of these masses; the decussation of the corpora pyramidalia is always distinctly marked: the tuber annulare and lateral lobes of the cerebellum have a correspondingly conspicuous development; the ventricles of the cerebrum are large, and contain a corpus striatum and cornu ammonis; the fornix is always well developed, but the following aphorisms in Cuvier's celebrated abstract or condensation of M. Serres' prize essay are applicable only to the placental Mammalia, viz. "The corpus callosum as well as the pons Varolii are peculiar to Mammalia. The corpus callosum is developed in direct proportion to the size of the corpora striata and hemispheres. It increases progressively from Rodentia to Man. The corpus callosum is developed in direct proportion to the development of the tuber annulare."

In the Marsupial Order, as in the Kangaroo and Wombat, the cerebral hemispheres are relatively larger and more complicated with convolutions than in any Rodent, yet the transverse commissure which represents the rudiment of the corpus callosum connects only the hippocampi majores; it is not separated from the fornix by any septum lucidum; and, upon divaricating the cerebral hemispheres, the lateral ventricles are as much exposed as when, in placental Mammalia, the corpus callosum has been removed. The tuber annulare, however, exists in the Marsupial as in the Placental Mammalia, and illustrates its correlation with the lateral lobes of the cerebellum. The class Mammalia is the only one in which the cerebral hemispheres are observed to have their vascular superficies multiplied or increased by convolutions, which arrive at their maximum of development in Man.

The olfactory nerves of mammals are soft, and divide into numerous branches in the cranium, which pass out by the orifices of the cribriform plate of the ethmoid.

The *nervi vagi* principally supply the larynx,

form a plexus around the œsophagus, and do not unite into a single trunk before passing to the stomach. The left recurrent nerve, and not the right, bends round the trunk of the aorta.

The cervical portion of the sympathetic nerve passes along the neck on the sternal aspect of the transverse processes of the vertebræ; and its trunk in the thorax and abdomen is not immediately connected with the ganglia of the spinal nerves. The splanchnic nerves form large ganglia before giving off the visceral plexuses.

The sclerotic coat of the eye is a fibrous membrane, and never contains bony plates. In the quantity of aqueous humour and the convexity of the lens, Mammals are generally intermediate to Birds and Fishes; but they have no marsupium or pecten, nor any choroid gland.

The organ of hearing is characterized in Mammalia by the full development of the cochlea with a lamina spiralis; there are three distinct ossicles in the tympanum; the membrana tympani is generally concave externally, and the *meatus auditorius externus* often commences with a complicated external ear, having a distinct cartilaginous basis.

The external apertures of the organ of smell are provided in Mammalia with moveable cartilages and muscles, and the extent of the internal organ is increased by accessory cavities or sinuses which communicate with the passages including the turbinated bones.

The tongue is always soft and fleshy, and its gustatory surface is provided with conical, fossulate, and fungiform papillæ; it is supplied by a large proportion of the third division of the fifth pair of nerves, as well as by the ninth and glosso-pharyngeal.

Classification.—The Mammalia were first separated from other four-footed animals and distinguished as a class or particular group (*genos*) by Aristotle, the founder of natural history, by whom they were denominated *Zootoka*, or Viviparous animals. The Greek philosopher divided the *Zootoka*, according to the nature of their locomotive organs, into three sections: 1st, *Dipoda*, or bipeds; 2d, *Tetrapoda*, or quadrupeds; and 3d, *Apoda*, or impeds, which comprehends the Whale-tribe. The second of these primary divisions,—the quadrupeds,—which includes by far the largest proportion of the class, and in common parlance is considered as the class itself, is subdivided by Aristotle into two great natural groups, according to the modifications of the organs of touch. In the first of these groups, the extremities of the digits are left free for the exercise of the tactile sense, the nail or claw being placed on one side only (*Unguiculata* of Ray); in the second group, the digits are inclosed in hoofs (*Ungulata* of Ray). For the convenience of treating of the different forms of the Unguiculate quadrupeds, Aristotle employs for their further subdivision another system of organs, viz. the teeth. His first group or family is composed of those Unguiculates which have the front teeth trenchant, or terminating in a cutting edge, and the back teeth

genera in their elongated muzzle, but differ from them in the form and disposition of the teeth: the Tamandua, indeed, is altogether destitute of teeth: the remaining two anomalous species have the muzzle shortened."

Linnæus defines the Class Mammalia, as follows:—

Heart, with two auricles and two ventricles.

Blood, warm.

Lungs, respiring reciprocally (" *Pulmones reciprocantes* reciprocæ.")

Jaws, incumbent, covered; armed with teeth in most.

Penis intrans.

Generation, viviparous; lactiferous.

MAMMALIA.	{	Unguiculate....	{	Front teeth, none in either jaw	BRUTA.
				Front teeth, <i>cutters</i> 2, <i>laniaries</i> 0.	GLIRES.
				Front teeth, <i>cutters</i> 4, <i>laniaries</i> 1.	PRIMATES.
				Front teeth, <i>piercers</i> (6, 2, 10), <i>laniaries</i> 1.	FERÆ.
		Ungulate	{	Front teeth, in both upper and lower jaw	BELLUÆ.
				Front teeth, none in the upper jaw	PECORA.
Muticate		Teeth variable	CETE.		

(From the ' *Systema Naturæ*, ed. xvi. Holmiæ, p. 24.)

On comparing the three preceding systems, it will be found that the most important errors of arrangement have been committed, not by Aristotle, but by the modern naturalists. Both Ray and Linnæus have mistaken the character of the horny parts enveloping the toes of the elephant, which do not defend the upper part merely, as is the case with claws, but embrace the under parts also, forming a complete case or hoof.

With respect to Linnæus, however, it must be observed, that although he has followed Ray in placing the elephant in the unguiculate group of quadrupeds, he has not overlooked the great natural divisions which the latter naturalist adopted from Aristotle, as is evident from the Table above quoted. He erred, perhaps, in not giving names to those primary divisions.

From the manner in which Linnæus has arranged his Orders in this Table, it would seem that he had the circular progression of affinities in view. The Walrus among *Bruta* connects the commencement of the chain with *Cete*, which forms the last link; but whether or not he had perceived the affinity of *Elephas* to the *Glires*, and intended it as a transitional genus to that Order, as Cuvier has subsequently shown it to be, is less certain.

Pallas* divides the Class Mammalia into seven Orders, viz.

- I. FERÆ. II. SEMIFERÆ. III. GLIRES.
- IV. RUMINANTIA. V. ANOMALOPODA.
- VI. BELLUÆ. VII. CETACEA.

Order I. FERÆ.

The FERÆ are characterized by *incisors*, small; *laniaries* very powerful; *molars* trenchant and tricuspid, (*lacero-tricuspidatos*); *clavicles* minute suspended in the flesh, almost obsolete and functionless; *vertebral column* elongated and flexible; *muscular force* im-

Senses, tongue, nostrils, eyes, ears, tactile papillæ.

Covering, hairs; few in tropical; very sparing in aquatic mammals.

Support, four feet, except in those which are entirely aquatic, in which the posterior feet are bound together in the fin of the tail. A tail in most.

With respect to classification, Linnæus, like Aristotle and Ray, founds his primary divisions of the Class Mammalia on locomotive organs; but his secondary divisions or orders are taken chiefly from modifications of the dentary system. The following is the scheme of his arrangement:—

mense; *asophagus* and *alimentury canal* wide, short, with a very short cæcum and colon; *digestive power* so active as to reduce even bones to chyme; *penis* supported by a bone; *prolific virtue* not very great; *young* born blind; *skin* pretty flexible, and *fat* soft, sometimes oily.

The genera included in the Order thus philosophically characterized are

- 1. *Felis*. 2. *Canis*. 3. *Ursus*. 4. *Meles*.
- 5. *Viverra*. 6. *Mustela*. 7. *Phoca*.

Order II. SEMIFERÆ.

"All preconceived opinion being laid aside, the following genera," says Pallas, "seem to be linked together by an uninterrupted series of affinities and to constitute a strictly natural family, viz. *Simia*, *Lenur*, *Vespertilio*, grouped together by Linnæus under the name of Primates—with these, *Didelphys*, *Talpa*, *Sorex*, and *Erinaceus*, which he classed without any stable character with the *Feræ*. These differ from the Order *Feræ* in the continuity of the dental series, generally also in the number of incisors and in the less elongated canines; in the multifarious and singular structure of the pentadactyle feet, the perfect clavicles, and in short in their habit, food, and general nature."

Order III. GLIRES.

"This Order," says Pallas, "is so natural and clear in its characters that it did not escape the older Zoologists. All the genera composing it agree in their bifid or hare-lip, their rosorial incisors generally two in number, their perfect clavicles, sub-bipartite stomach, large cæcum, and great apparatus of the male generative organs, exceeding that of any other order. They produce a blind offspring, as in the *Feræ* and *Semiferæ*." It must be observed, however, that the perfect clavicles and large cæcum are not, as Pallas states, constant characters of the Glires.

* Zoographia Rosso-Asiatica, 1831.

Order IV. RUMINANTIA.

The Ruminantia, or the natural Order recognized by Aristotle under the name of *Μρυμάζοντα*, subsequently adopted by all Zoologists, have their external and internal characters alike conspicuous and cogent. These, according to Pallas are, *incisors* wanting in the upper jaw; *hoofs* bifid; *habit* of the whole body; *stomach* quadruple; *intestines* very long with a *cæcum*; *suet* for fat; *cotyledons* in place of placenta. The genera included in this order are *Camelus*, *Moschus*, *Cervus*, *Ægoceros*, *Bos*, *Antelope*.

Order V. ANOMALOPODA.

The genera grouped together by Pallas under this name differ, he observes, from each other in their dental apparatus and the structure of their feet, yet nevertheless are linked together by natural affinity (“*sed tamen inter se naturali affinitate coherent*”). Thus *Hippopotamus* is allied to *Equus*, the horse to *Rhinoceros* and its congener *Hydrochaerus*, and these to the genus *Sus*. The following characters are common to the whole order: *molars* truncate, triturating; *feet* ungulate, supported on the digits; *stomach* a macerator, with enormous colon and *cæcum*; *clavicles* wanting; *produce* perfect; *food* vegetable.

The genera which Pallas exemplifies in this Order, which corresponds with the *Pachyderma* of Cuvier (the Proboscideans being excepted), are *Equus*, *Sus*, *Rhinoceros*, *Hippopotamus*.

Order VI. BELLUÆ.

In this Order,—characterized by *incisors* none; *canines* projecting from the upper jaw only, composed of ivory; *molars* few; *mamma* pectoral (in which the Belluæ mainly differ from the *Anomalopoda*); *feet*, with connate digits forming a shapeless sole;—Pallas includes the genera *Elephas* and *Rosmarus*, rejecting therefrom the *Trichecus* or Manatee, as having the hind-feet coalescing with the tail, and therefore more rightly to be referred to the Cetaceous Order. In this latter view Cuvier agrees with Pallas. As to the rest it is scarcely necessary to say that the tusks of the Elephant differ from those of the Walrus in being implanted in the inter-maxillary bones instead of the maxillaries, and are therefore regarded as *incisors*.

Order VII. CETACEA.

Pallas observes that since the Cetacea differ from the other *Lactantia* chiefly in having their boneless posterior extremities blended with the cartilaginous tail (“*quod artus posticos exosses, in caudam cartilaginibus fultam coadunatos obtinent*”), the *Manatus* and *Trichechus* rightly fall under this Order, although they approach more to the nature of Quadrupeds. Both the *Manatus* proper and the *Rytina*, which is the *Manatus Borealis* of Pallas, agree, however, with the true Cetacea in having no other rudiments of posterior extremities than some small pelvic bones.

We shall now proceed to the arrangement

of the Mammalia proposed by Cuvier in the last edition (1829) of the ‘*Règne Animal*,’ and this is the more interesting, as, in giving the outline of his method, he develops the principles on which the divisions of the class are founded.

“The characters by which Mammalia differ most essentially one from another are derived from the organs of touch, from which results their degree of dexterity, and from the organs of mastication, which determine the nature of their food; and, as a corollary to these, depends not only every thing which is connected with the digestive functions, but a variety of other circumstances relative even to their degrees of intelligence.

“The perfection of the organs of touch is estimated by the number and mobility of the digits, and the extent to which they are inclosed in a claw or in a hoof. A hoof which completely incloses that part of the digit which touches the ground, precludes the exercise of it as an organ of touch or of prehension. The opposite extreme is where the nail, in the form of a simple lamina, covers only one side of the end of the digit, leaving the other side in possession of all its delicacy of tact.

“The kind of food is indicated by the molar teeth, to the form of which the articulation of the jaws invariably corresponds.

“For cutting flesh, the molar teeth must be trenchant and serrated; and the jaws fitted together, so as to move like the blades of a pair of scissors, simply opening and closing in the vertical direction.

“For bruising grains and roots, the molar teeth must have flattened crowns, and the jaws a horizontal motion: and further, that the grinding surface may be always unequal, like a millstone, the teeth must be composed of substances of different degrees of density, and consequently wearing down in different proportions.

“The ungulate quadrupeds are all of necessity herbivorous, or with flat-crowned molars (*fig. 59*), because the conformation of their feet does not permit them to seize living prey.

Fig. 59.

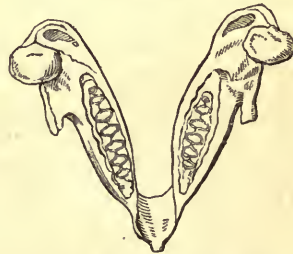

Lower jaw, African Elephant.

“The ungulate animals are susceptible of more variety. They are not limited to one kind of food; and, besides the consequent variation in the form of their molars, they differ materially from each other in the mobility and sensibility of their digits. There is, moreover, a characteristic which prodigiously in-

Fig. 60.



Fig. 63.



Skull of a Rodent.

Fig. 61.



Hind extremity, Ape.

Fig. 64.



Hind leg, Antelope.

Fig. 62.



Hind extremity, Lion.

Fig. 65.



Skull of the Giraffe.

fluences their dexterity, and gives variety to their modes of action: it is the faculty of opposing a thumb to the other fingers, so as to seize the smallest objects, which constitutes a *hand*, properly so called. This faculty is carried to its highest degree of perfection in man, in whom the whole anterior extremity is free, and can be exclusively employed in prehension. These different combinations, which strictly determine the nature of the several mammiferous animals, have formed the grounds for their distribution into the following Orders.

“Amongst the Unguiculate animals, the first is *MAN*, who, in addition to his peculiar privileges in every other respect, is distinguished zoologically by possessing hands on the anterior extremities alone; the posterior extremities being destined to sustain him in the erect position. (Fig. 60.)

“The Order which comes nearest to Man, —that termed *Quadrumana*,—has hands on the four extremities. (Fig. 61.)

“Another Order, termed *Carnivora*, has not the thumb free and opposable on either the anterior or posterior extremities. (Fig. 62.)

“These three Orders possess likewise severally the three kinds of teeth, viz. molars, laniaries, and incisors.

“The quadrupeds of the fourth Order, viz. the *Rodentia*, have the digits differing little from those of the *Carnivora*; but they want the laniary teeth, and have the incisors of a form and disposition altogether peculiar to themselves. (Fig. 63.)

“To these succeed the animals whose digits now become much cramped, being sunk deep in large and, most commonly, crooked claws. They are further defective in the absence of

incisor teeth; some of them even want the laniaries, and others are altogether destitute of dentary organs. We shall comprehend them under the term *Edentata*. (See fig. 33, vol. ii. p. 49.)

“This distribution of unguiculate animals would be perfect, and would form a very regular chain, if New Holland had not lately furnished us with a small collateral chain, composed of the *Marsupial* animals, all the genera of which, while they are connected by a general similarity of organization, at the same time correspond in their dentition* and diet, some to the *Carnivora*, others to the *Rodentia*, and a third tribe to the *Edentata*.

“The Ungulate animals are less numerous, and present fewer variations of form.

“The *Ruminantia*, by their cloven feet, (fig. 64,) their want of upper incisors, (fig. 65,) and their complicated stomach, form a very distinct Order.

“All the other quadrupeds with hoofs might be united into a single Order, which I would call *Pachydermata* or *Jumenta*, (fig. 66,) the elephant excepted, which might form an Order of itself, having some remote affinities to the Order *Rodentia*. The *Pachyderms* have commonly incisors in the upper as well as the lower jaw. (Fig. 67.)

“Last of all come the *Mammalia* which have no hinder extremities, and whose fish-like form and aquatic life would induce us to form them into a separate Class, if their œconomy

* In the article *MARSUPIALIA* it will be shown how much more essential are the points of resemblance between the dentition of the different Marsupial animals than between any of these and the placental genera, with which they correspond in diet.

Fig. 66.



Hind leg, Rhinoceros.

Fig. 67.



Skull of the Rhinoceros.

12. CANIS. 13. FELIS. 14. VIVERRA. 15. MUSTELA. 16. URSUS. 17. DIDELPHIS. 18. TALPA. 19. SOREX. 20. ERINACEUS.

IV. GLIRES.

Front teeth cutting, two in each jaw. Food, bark, roots, vegetables, which they erode or gnaw. 21. HYSTRIX. 22. LEPUS. 23. CASTOR. 24. MUS. 25. SCIURUS. 26. NECTILIO.

B. Ungulata.

V. PECORA.

Fore teeth cutting, many in the lower jaw, none in the upper jaw. Feet bisulcate. Four stomachs. Food, herbs, which they pluck, and afterwards ruminates. 27. CAMELUS. 28. MOSCHUS. 29. CERVUS. 30. CAPRA. 31. OVIS. 32. BOS.

VI. BELLUÆ.

Fore teeth obtuse. Tread heavy. Food, vegetables. 33. EQUUS. 34. HIPPOPOTAMUS. 35. SUS. 36. RHINOCEROS.

C. Mutica.

VII. CETÆ.

Teeth in some horny, in others bony. In place of Feet they have pectoral fins without claws; and a horizontal flattened tail. Nostrils terminating in one or two fistulous apertures at the anterior and upper part of the head. Food, mollusca and fish. 37. MONODON. 38. BALÆNA. 39. PHYSETER. 40. DELPHINUS.

The System of Mammalia of Cuvier, according to the 2nd Edition of the ' Règne Animal.'

A. Unguiculata.

Sect. a. With three kinds of teeth.

I. BIMANA.

1. HOMO.

II. QUADRUMANA.

1. Simie, incisors four in each jaw, erect; nails flattened.

Fig. 68.

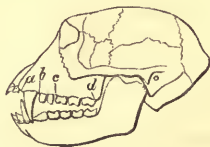

a, Incisors; b, canine or laniary; c, false molars, premolars, or bicuspidis; d, true molars.

α. Inhabiting the Old World; molars five on either side of each jaw. PITHECUS, &c.

β. Inhabiting the New World; molars six on either side of each jaw. CEBUS, &c.

2. Lemurini, incisors more than four either in the upper or lower jaw, procumbent. LEMUR, &c.

III. CARNIVORA.

1. Cheiroptera, with membranous expansions between the fingers, and laterally between the extremities.

α. Vespertiones, with the bones of the anterior extremity disproportionately elongated. PTEROPUS, &c.

was not in every other respect the same as in the Class in which we shall leave them. They are the warm-blooded fishes of the ancients, or the Cetacea, which, combining the powers of other Mammalia with the advantage of being sustained upon the watery element, include the most gigantic forms to be found in the whole animal creation."—Règne Animal, 2nd edit., p. 65.

Having thus given a brief exposition of the principles which have guided five of the most original writers on Natural History in their primary arrangement of Mammalia, we shall next subjoin a short tabular view of the genera or minor groups included by Linnæus and Cuvier in their respective Orders.

The System of Mammalia of Linnæus, from the 12th edition of the ' Systema Naturæ.'

A. Unguiculata.

I. PRIMATES.

Fore teeth cutting; upper ones parallel, four; laniaries solitary. Teats pectoral, two. Food, fruits, except a few which use animal food. 1. HOMO. 2. SIMIA. 3. LEMUR. 4. VESPERTILIO.

II. BRUTA.

Fore teeth none in either jaw. Feet with large nails. Food mostly vegetables. 5. ELEPHAS. 6. TRICHECUS. 7. BRADYPUS. 8. MYRMECOPHAGA. 9. MANIS. 10. DASYPUS.

III. FERÆ.

Fore teeth conical, usually six in each jaw; laniaries long; molaries pointed, conical. Food, carcasses and living prey. 11. PHOCA.

β . Galeopithecæ, with the fingers and toes of the same length. GALEOPITHECUS.

2. *Insectivora*, without lateral membranous expansions; molars cuspidated.

α . With two long anterior incisors, the rest short, the laniaries small. ERINACEUS, &c.

β . With the incisors small, the laniaries large. CENTETES, &c.

3. *Carnivora*, incisors six in each jaw; molars, some of them sectorial or trenchant.

Fig. 69.



Dentition of Bear.

a , Incisors; b , laniary; c , false molars; d , sectorial molar or carnassial; e , tuberculate or true molars.

- α . Plantigrada. URSUS, &c.
 β . Digitigrada. CANIS, FELIS, &c.
 γ . Pinnigrada. PHOCA, &c.

Fig. 70.



Hind extremities, Seal.

IV. MARSUPIALIA.

1. Incisors small; laniaries long; posterior molars cuspidated. DIDELPHIS, &c.

2. Lower incisors two, long; upper ones six. Upper laniaries long and pointed; lower ones small. PHALANGISTA, &c.

3. Lower laniaries wanting; no thumb on the hind feet. HYPSPRYMNUS.

4. No laniaries. MACRUPUS.

5. Lower incisors two, no laniaries: upper incisors six; two small laniaries. PHASCOLARCTOS.

6. Two long incisors in each jaw; no laniaries. PHASCOLOMYS.

Sect. *b*. Without laniaries; two large incisors distant from the molaries.

V. RODENTIA.

1. With clavicles.

α . Sciuridæ, anterior digits four, posterior five; tail cylindrical and bushy.

β . Muridæ, tail cylindrical, not bushy.

γ . Pedetidæ, anterior digits five, posterior four.

δ . Spalacidæ, anterior digits five, posterior five.

ϵ . Castoridæ, tail flat and scaly,

2. With imperfect clavicles, or none.

α . Hystricidæ, body covered with spines.

β . Leporidæ, two small incisors behind the two superior large ones.

γ . Caviadæ, no character in common.

Sect. *c*. Without incisor teeth.

VI. EDENTATA.

1. *Tardigrada*; with a short muzzle. BRADYPUS, &c.

2. Typical *Edentata*; with an elongated muzzle. DASYPUS, &c.

3. *Monotremata*; with marsupial bones and a cloaca. ORNITHORHYNCHUS, &c.

B. Ungulata.

a. Not Ruminants.

VII. PACHYDERMATA.

1. *Proboscidea*; with a proboscis: incisors projecting; feet pentadactyle. ELEPHAS, &c.

2. Typical *Pachydermata*; feet tetra-, tri-, or di-dactyle. HIPPOPOTAMUS, &c.

3. *Solipeda*; feet monodactyle. EQUUS, &c.

b. Ruminants.

VIII. RUMINANTIA.

1. Without antlers or horns. CAMELUS, &c.

2. With antlers. CERVUS, &c.

3. With horns. ANTILOPE, &c.

C. Mutica.

IX. CETACEA.

1. *Herbivora*; teeth fitted for mastication. MANATUS, &c.

2. Typical *Cetacea*; teeth unfitted for mastication, or wanting. DELPHINUS, &c.

The ideas that have been broached respecting the affinities and classification of the Mammalia after Cuvier, and which are most remarkable for their novelty and boldness, are those which have emanated from the naturalists of the English Quinary school. The founder and the most talented of this sect—Mr. W. S. Macleay—thus enunciates his views of the analogies observable between the principal groups of Mammalia, and those into which the class of birds is resolvable. "Every Mammiferous animal," he says, "may be reduced to these five orders; that is, may be assimilated, in a greater or less degree, to one or other of the following typical forms; viz. Man, the Lion, the Horse, the Whale, and the Mouse. I shall show hereafter how these five orders form a continued series returning into itself, so as to be a natural group. In the mean time, I must recall to the attention of the reader the orders of Birds as defined and arranged by Mr. Vigors; and to which definitions and arrangement I have just applied so severe a test, only to corroborate their accuracy, and to make them display additional harmony.

"When we have heard the Parrot or Maimate speaking; when we have witnessed the former feeding itself as it were with a hand; when, in short, we have reflected on the remarkable intelligence and development of brain throughout the whole order of *Insectores*, to which both birds belong,—there has been no one, perhaps, dull enough not to compare them to *Primates*. . . . I allow, indeed, that it is diffi-

cult to follow the opinion of the great naturalist of France, who, ignorant of the true nature of relations of analogy, imagined that the Psittaceous tribe of Birds ought to occupy the first step in the scale of nature below Man; but we cannot help adopting the notion of Linnæus in the '*Systema Naturæ*,' that although not near him in construction, they are yet analogous to him in various important respects. And, adopting this notion, we must place the whole order of *Insectores*, to which *Psittacus* belongs, opposite to the *Primates*, of which Man forms the type.

"The analogies existing between birds of prey and carnivorous quadrupeds having been noticed by Aristotle, who called both groups *Gampsonucha*, were enlarged upon by Plutarch. Among a host of moderns who have been struck with the resemblance, I may particularly mention Linnæus, who in his '*Systema Naturæ*' has expressly called his Accipitres '*Feris analogi*;' and Buffon, who has treated the subject at length and with his usual eloquence. I conceive, therefore, that no one can object to the propriety of my placing the *Feræ* opposite to the *Raptores*.

"The analogy between Aquatic Birds and Aquatic Mammalia scarcely requires the mention of the authority of Linnæus to make it be granted. It is indeed so evident, that Hermann, according to his custom, takes it for a relation of affinity. In both orders the anterior appendages of the vertebral axis dwindling into fins, and the two undivided posterior appendages being placed so far behind on the axis as to show that both were intended for motion in the water rather than on land, are circumstances of themselves sufficient to authorize the placing of the *Cetacea* opposite to the *Natatores*.

"Two orders still remain in each class to be considered: the *Glires* and *Ungulata* among the Mammalia; and among Birds, the *Rasores* and *Grallatores*. The relations of analogy pointed out by Linnæus between Mammalia and Birds are, as Hermann has observed, not always correct; and his errors have arisen from the misfortune of his not detecting the natural group of Aristotle and Ray, which the latter has called *Ungulata*.* Having only been able to seize Aristotle's subdivisions of this group, he lost the parallelism of analogy, and fell, as I shall hereafter show, into very glaring mistakes. In the '*Systema Naturæ*,' however, he has mentioned that very striking analogy which appears between his groups of *Grallæ* and *Bruta*; that is, according to the parallelism of analogy, between the orders of *Grallatores* and *Ungulata*, since the *Bruta*, as we have seen, do not form an order, but only a natural subdivi-

vision of the *Ungulata*. That this analogy is demonstrably true, I deduce from the following facts. Of their respective classes, the orders of *Ungulata* and *Grallatores* contain examples of the longest legs in proportion to the body,—witness *Camelopardalis* and *Hæmantopus*. Both orders present us, in groups not exactly aquatic, with instances of the toes soldered together, as in the Horse; or connected together by a web, as in the Flamingo. Both orders present us with the greatest elongation of muzzle or facies,—witness *Myrmecophaga*, or *Antilope* (particularly *A. Bubalus* L.), and *Scolopax*; and also with the most depressed form of muzzle,—witness *Hippopotamus* and *Platalea*, which genera also afford us the truest specimens of Wading *Vertebrata*. In both orders we have the most elongated claws,—witness *Megalonyx* and *Parra*. Both orders afford us the swiftest animals in running,—as the Horse and *Tuchydromus*; and the most pugnacious on account of love,—as the Bull and *Machetes*. The Bull moreover and the *Butor* (or *Bostaurus*, for hence comes the bird's name,) afford us the loudest and hoarsest voice of their respective orders: where we have also the most remarkable instances of the upper and under mandibles touching each other merely at their base and point; as *Myrmecophaga*, or the whole of the *τα μεν ουκ αφοδοντα* of Aristotle, and *Anastomus* Illig. Both orders exhibit ornamental appendages to the head,—as the antlers of the Stag and the crown of the Crane; and both orders afford us the only instances of true horns,—as *Bos* or *Rhinoceros*, and *Palamedea* L. To see a hundred instances of resemblance, it is only necessary to walk into a museum. I shall therefore only further say, that both orders contain polygamous animals, are generally gregarious, and more graminivorous than granivorous, being essentially inhabitants of marshes and savannahs. Thus then, with Linnæus, I place the *Bruta*, or rather the whole order of *Ungulata* to which they belong, opposite to the *Grallatores*.

"Four orders in each class being now disposed of, it follows by parallelism of analogy, that the *Glires* ought to be placed opposite to the *Rasores*. But setting theory aside,—is this position true in fact?*

"Linnæus, from the above-mentioned error in his series of affinity, considered the *Rasores* to be analogous to his group of *Pecora*. But this group, according to Aristotle and Ray, is only a subdivision of *Ungulata*, which have, I consider, been now proved to be analogous to the *Grallatores*. If, therefore, Linnæus be right in making his *Bruta* analogous to the order of Wading Birds, it follows that his *Pecora* must be so also.

* In making this assertion, Mr. Macleay appears to have overlooked the tabular arrangement prefixed by Linnæus to the more extended characters of his orders of Mammalia. The only fault in the construction of his *Ungulata* is the exclusion of the elephant from that division; for with respect to the edentate *Bruta*, Linnæus and Cuvier correctly interpreted nature in placing them among the Ungulate Mammalia.

* "The ancient name of *Struthio Camelus*, as well as the form and habits of the Ostrich, show indeed a relation of analogy to the Camel; but then we are to recollect, in the first place, that the Ostrich is at the osculant point or confines of the orders of *Grallæ* and *Rasores*; and secondly, that such slight variations of the parallelism of analogy often appear, although I think it possible that even these are subject to rule."

“The analogy of the *Rasores* to the Ruminating Animals was first, I believe, mentioned by Linnæus in the ‘*Systema Naturæ*.’ It has since his days been copied and copied, until now it almost becomes a sort of heresy to inquire into its accuracy. I am not, however, aware that any reason for this analogy has ever been assigned, beyond the fact,—that one order affords the principal part of those birds which are domesticated by man for purposes of food; and the other, the principal part of quadrupeds which are destined to the same purpose. Now, granting even this domestication not to be the work of art, but to be an analogy really existing in nature, I would observe,—setting the whole family of *Anatidæ* aside,—that the *Glires* afford us many eatable or domesticated animals, such as the *Capromys* and Rabbit; and the *Grallatores* afford us similar instances in the Snipe and *Psophia*. If some *Rasores* be said, like the *Pecora*, to have ornamental appendages to the head, so it must be remembered has the Crowned Crane; whereas no rasorial bird is truly horned, like the *Palamedæa*. But it may be worth while to take into consideration successively the grand characteristics of the *Rasores*, as given by ornithologists to distinguish them from all other birds.

“The *Rasores* are, properly speaking, frugivorous birds; by which I do not mean eating fruits only, but all manner of seeds or grain. Now this character of being frugivorous applies much more to the *Glires* than the *Ungulata*, which are truly herbivorous, and only feed on grain in an artificial or domesticated state. To begin, then, with the rasorial or scratching powers of gallinaceous fowls; these are certainly the most burrowing of frugivorous birds: now the most burrowing of frugivorous quadrupeds are certainly not the *Ungulata*, but the *Glires*. These birds are characterised by the shortness of their wings and the weakness of their pectoral muscles. Now if we inquire whether it is among the *Glires* or *Ungulata* that we find the corresponding appendages of the vertebral axis,—that is, the fore-feet most shortened,—the answer will be, certainly not among the *Ungulata*; where, on the contrary,

the Giraffe has them extraordinarily lengthened: but among the *Glires* we have the Jerboa, in this respect almost a bird. In general, moreover, this latter order is distinguished, like the *Rasores*, by the strength of those muscles of the two posterior appendages of the vertebral axis or hind-feet, that contribute to locomotion. Gregarious habits distinguish the most of the *Rasores*; so they do in a still more extraordinary manner the *Glires*. Many are insectivorous in both orders, and some are omnivorous. The muzzle or facies of *Glires* is short and round, very like that of *Feræ*, there being a direct relation between the two orders. The facies of *Rasores* is also short and round, very like that of *Raptores* (the order analogous to that of *Feræ*); and there is also a direct relation between these two orders. Many *Rasores* perch and nestle on trees; so do many of the *Glires*. The *Rasores* generally feed on hard grain, which they pick up with their hooked beak, and masticate in a triturating gizzard: the *Glires* feed also on hard substances, which they gnaw with their strong hooked incisors, and masticate with their grinders. In both orders the thumb is very often rudimentary. In both orders the tail varies from an extraordinary length, as in the Squirrel and Pheasant, to being very short, as in the Hare and Partridge. No orders in their respective classes present the tail so spread out and flattened as the *Glires* and *Rasores*,—witness the Beaver and Peacock. In both orders the sense of hearing is much developed. In both orders we find animals, such as Squirrels and Pigeons, with their toes perfectly free; and others, as *Hydromys* and *Phasianus*, which have them united at the base by a membrane. *Castor* is an aquatic animal, having some relation to *Cetacea*; *Struthio* is a terrestrial animal, approaching to the *Natatores*. And so on relation comes so fast upon relation, that I know not how we can for a moment hesitate to place the *Glires* opposite to the *Rasores*.

“I conceive it now to be demonstrated, that so far as relates to the analogies existing in nature between the orders of *Mammalia* and *Aves*, we ought to place them thus:—

Animals typically.

1. FERÆ Carnivorous	1. RAPTORES.
2. PRIMATES Omnivorous	2. INSESSORES.
3. GLIRES Frugivorous	3. RASORES.
4. UNGULATA Frequenting the vicinity of water	4. GRALLATORES.
5. CETACEA Aquatic	5. NATATORES.”

The additional knowledge of the organization of the Mammalia, and especially of the Marsupialia, which has been acquired since the time of Cuvier, has led to corresponding improvements in their classification. A primary binary division of the class based on modifications of the generative function has been established chiefly by the proofs that have been adduced of their co-existence with characteristic conditions of the nervous and vascular systems, as well as of the generative organs themselves. These primary groups or sub-classes I have named PLACENTALIA and IMPLACENTALIA,

indicative of the adherence of the ovum to the uterus in the one, and its non-adherence, as in the ovo-viviparous reptiles, in the other group.

Taking the orders as they are defined and characterised by Cuvier, the progression of their affinities, so far as they can be given in a linear series, seems to be as follows:*

Class.—MAMMALIA.

Sub-Class.—PLACENTALIA.

Orders.—I. *Bimana*. II. *Quadrumana*.

* See the excellent Catalogue of the Mammalia in the Museum of the Zoological Society, by George Waterhouse, Esq. Curator.

III. *Cheiroptera*. IV. *Insectivora*. V. *Carnivora*. VI. *Cetacea*. VII. *Pachyderma*. VIII. *Ruminantia*. IX. *Edentata*. X. *Rodentia*.

Sub-Class.—IMPLACENTALIA.

XI. *Marsupialia*. XII. *Monotremata*.

The aim of the subjoined table is to express

the mutual affinities and inter-dependencies of the several orders of Mammalia, and the points at which they are most nearly related to the inferior classes of the vertebrate animals. The annectant genera, some of which are extinct, are printed in italics, the orders and classes in Roman capitals.

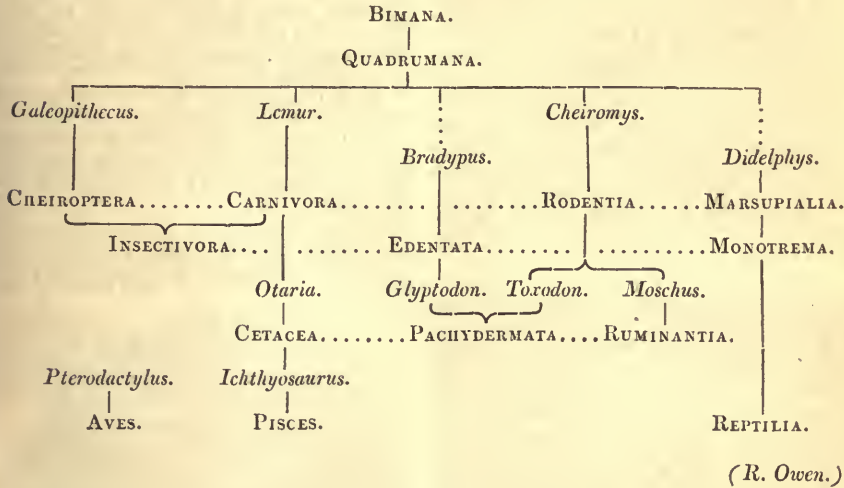

MAMMARY GLANDS.—Syn. *Les glandes mammaires*, Fr., *Die Milch, die Brust-drüsen*, Germ. These important organs of secretion are the peculiar characteristic of the highest division of the animal kingdom, *Mammalia*. In a physiological point of view they should be regarded as uterine appendages, as a portion of that series of instruments which Nature has provided in greater or less number, according to the ultimate perfection of the animal, for its gradual development. Their close proximity to the ovarian apparatus in some Mammalia, the cetacea for instance, and their peculiar structure and function in the Marsupialia, confirm this view of their physiological character. It is interesting to trace how gradually they have been removed from their caudal position to the atlantal portion of the body, so that in the human species, where the instincts are subjugated to the control of reason, and the helplessness of the infant has been made the means of moral training to the mother, these organs are brought towards the anterior, the nobler portion of the body.

It must not, however, be supposed that this change of position is sudden, any more than any other step in the scale of progressive development of organized beings. Formerly it was supposed that the re-connection of the ovum to the mother through the medium of blood vessels collected into a placenta was as universal throughout the class Mammalia as the presence of these glands; but the careful researches of Professor Owen have proved that the Marsupialia and most probably some of the Monotremata form an exception to this rule. The fact is interesting in reference to the present subject from the greater importance which is

given to the mamma in consequence of the absence of this vascular connection, and the addition of accessory structures which are absent in the more perfect mammalia.

The arrangement of the secreting membrane of mammary glands has been universally found to be vesiculated, the only difference in different classes of animals consisting in the extent of secreting surface, owing to differences in the size of the cells, and their greater or less concentration within a circumscribed space. This vesiculated structure was described in 1751 by Duvernoi* in the hedgehog (Trans. of the Petersburg Academy), and in the human species it was discovered by Cruikshank, and described in his work on the absorbent glands, the second edition of which was published in 1790. At page 209 his words are, "The acini are small vesicles like Florence flasks in miniature; in these, the arteries secreting the milk terminate; and from these the excretory ducts, or the tubes carrying off the milk take their origin. The existence of such vesicles has been doubted; Dr. Hunter doubted till my injections convinced him of the fact." He then goes on to explain his method of injecting, and concludes by saying that preparations exhibiting this fact may be seen in the anatomical collection in Great Windmill-street, which he had made fifteen years previously.

Müller, to whom the above fact was known, states that Mascagni recognised and demonstrated the vesicular ends of the lactiferous tubes and the absence of all direct communication with the bloodvessels, in his *Prodromo della Grande Anatomia*, Firenze, 1819.

* Müller de gland. &c.

He refers also to the observations of Buffon on the vesicles of the mamma of the horse, ox, and goat; to those of Von Baer on the vesicles in the mamma of the *Delphinus Phocaena*, to those of Van Hoesen and Vrolik in the same, and in the *Balana rostrata*, and of Meckel in the *Ornithorhynchus*, adding original observations and illustrations of his own, which demonstrate the same vesiculated structure in the hedgehog and rabbit.

During the course of the present year, 1840, the anatomy of the human breast has been described in a manner by Sir A. Cooper that leaves us nothing to desire, and the minuteness and accuracy of his descriptions are only equalled by the beauty and fidelity of the plates which represent the interesting results of his labours. In our description, therefore, of the human breast we shall do little more than draw from this deep well of instruction.

Human mamma.—The position of the human mamma upon the pectoral muscles is too well known to require any detailed account.

The nipples project forwards and outwards with a slight turn upwards, a direction which is beautifully adapted to the position of the infant when lying in its mother's arms; and the abundance of the lactiferous tubes at the lower portion of the breast, as will be more particularly described hereafter, forms a soft cushion for the head of the child to rest upon.

"The margins of the breast," says Sir Astley Cooper,* "do not form a regular disc, but the secreting structure often projects into the surrounding fibrous and adipose tissue so as to produce radii from the nipple of very unequal lengths, and a circular sweep of the knife cuts off many of its projections, spoils the breast for dissection, and in surgical operations leaves much of the disease unremoved."

At the age of puberty and for some time after, if the breasts are not called upon to perform their office, they present to the touch a dense, compact, smooth, and equal surface; but the distension of the cells in lactation stretches and relaxes the uniting cellular and fibrous membrane, and separates it into "small bodies with indentations around them." This lobulated character does, however, supervene even in childless women upon the cessation of the sexual secretion.

Following the arrangement of Sir A. Cooper, we shall consider the individual parts of the breast from without inwards.

The *nipple* is not placed in the centre of the breast, but nearer the abdominal margin of the gland. In the virgin it is a rounded cone and nearly smooth until puberty, but in the lactating woman forms a flat surface, cribriform with the lactiferous tubes in the centre. "At 16 years it is slightly wrinkled; at 17 it has small papillæ upon its surface; from 20 to 40 years the papillæ are large; from 40 to 50 the nipple becomes wrinkled; from 50 to 60 the nipple is elongated; and in old age it usually has a warty appearance."

This alteration in form during lactation, the

extremity becoming the broadest part, renders the adhesion of the child's mouth firmer and more complete.

The nipple or mammilla consists of the common integuments, fascia, milk-tubes, blood-vessels, nerves, and connecting cellular membrane.

The *cuticle* offers no peculiarities except the processes which it sends into the lactiferous tubes, which may be drawn out after continued maceration. Its extreme delicacy is well known to the medical practitioner.

Sir A. Cooper states that the *rete mucosum* "enters with the cuticle into the lactiferous tubes." This may be better seen in the larger quadrupeds, where they terminate a few lines from the extremities of the tubes, forming a fringed edge.

"*Cutis of the nipple*—This forms a considerable portion of the mammilla, and it is divided into two surfaces when the breast is in a state of lactation.

"The first forms the disc or circumference of the nipple, and the second its broad, flat, truncated apex, in which the terminations of the milk-tubes may be seen in numerous orifices.

"The disc is composed of a great number of papillæ, which produce a vascular and sentient surface, and which form its erectile and highly sensitive tissue.

"The direction of these papillæ is from the base towards the apex of the nipple, so that they are pushed back as the mammilla enters the mouth of the child, and thus greater excitement is produced.

"They lap over the truncated extremity of the nipple, forming a foliage upon its apex. This foliated character is one of the consequences of gestation.

"They form in their arrangement upon the nipple broken portions of circles, but when the nipple is elongated and dried they appear to be spiral.

"They form flaps, which are at their edges divided into numerous projections, with serrated depressions between them.

"They are directed forwards towards the apex of the nipple, and the papillæ of the child's lips passing from within outwards, meet them in sucking, are received between them, intermix with them, and produce considerable adhesion and sensation.

"They are very numerous and large for the size of the part, and rather spongy at their extremities.

"They are very vascular bodies, and I have given a figure of them injected. The minute arteries which pass from the base towards the apex of the nipple send numerous branches to the papillæ cutis, which divide into little bushes of vessels in each papilla and terminate in veins.

"The veins also are very numerous, and they will be seen injected, forming bushes similar to the extremities of the arteries.

"The application of the child's lips, the drawing of the nipple in the motions of the child's head, and the suction produced by its mouth,

* Page 13.

produce so much excitement as to occasion erection of the nipple."

The nipple is carefully connected with the gland by means of a firm fascia encircling the lactiferous tubes derived from the general fibrous tissue of the breast and thorax.

The areola.—This term has been applied to the coloured circle which surrounds the nipple. It is smooth until the period of puberty, when it becomes slightly tuberculated. Its diameter in a child is about half an inch; at puberty and in young women double that size, and during lactation is as much as two inches or more, not again changing except in very old age, when it almost disappears.

The change of the colour of the areola from a reddish tint to a dark brown as the result of impregnation is well known to the practitioner. The cuticle is thin as in the nipple. Speaking of the cutis of the areola Sir A. Cooper observes, that "when the areola is examined with attention after the separation of the cuticle

and rete mucosum, its surface is found to be covered with papillæ like those of the nipple, but of smaller size, although still extremely distinct. They are smallest at the circumference of the areola, but gradually increase in size as they approach the nipple. They are disposed in circles, their bases fixed in the cutis, and the apex of each is directed towards the nipple, so that they are opposed to the papillæ of the lips of the child. They are very vascular and sensitive bodies". (See fig. 71.) The whole structure of the areola points to it as a continuation of the nipple.

The nipple and areola are lubricated by the secretion of especial mucous follicles which surround them, called by Sir A. Cooper *the tubercles of the areola*. "These glands are extremely vascular, lobulated, and cellular. Each orifice opens into an arborescent vessel or vessels." (See fig. 72).

Fig. 71.

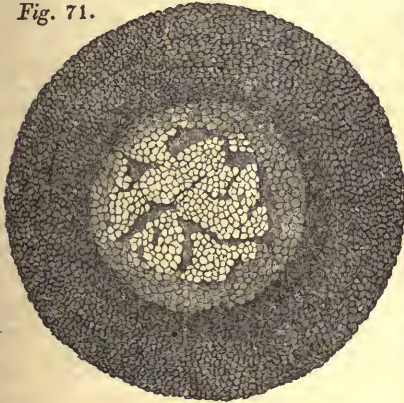

A front view of the nipple and areola, shewing the foliated appearance of the papillæ and the numerous but smaller papillæ of the areola.

This and the following figures are all taken from Sir A. Cooper's work.

Fig. 73.

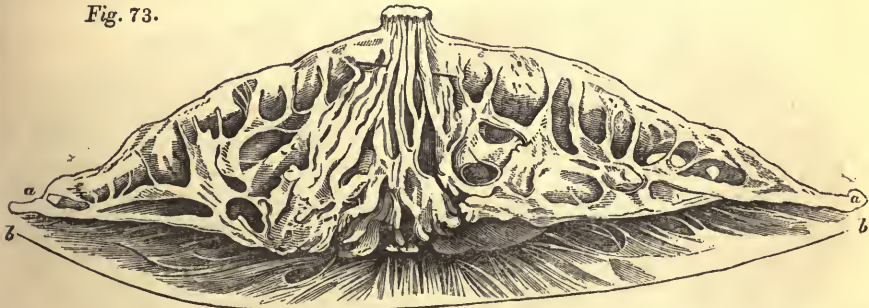

A section of the mammary gland through the nipple, shewing the ducts over a bristle unravelled, and proceeding to the posterior part of the gland. The ligamenta suspensoria may be seen passing from the anterior surface of the gland to the skin, supporting the folds or processes of the former, and leaving considerable cavities between them, in which the fat is contained in its proper membrane. The fascia may be observed passing to each extremity of the gland and dividing into two portions; the anterior proceeding upon the surface of the gland to form the ligamenta suspensoria; the posterior behind the gland, sending processes between which a smaller quantity of fat is contained; and both these layers assist in producing the fibrous tissue of the gland. It also sends processes of fascia backwards to join the aponeurosis of the pectoral muscle, b, b, forming the line from one extremity of the gland to the other. The section, therefore, clearly shews the various cords by means of which the breast is slung and sustained. a, a, the fascia.

Fig. 72.



A tubercle filled with yellow injection and twenty-three times magnified. These are the tubercles which have been supposed by anatomists to produce milk, and to have communication with the lactiferous tubes, from which, however, they are separate and distinct. They secrete a mucous fluid, which has more the appearance of gruel than milk.

We must next direct our attention to the internal structure of the breast, first as regards the protective arrangements.

The fascia enveloping the breast, like the tunica albuginea of the testicle, sends in processes to support and protect the secreting membrane of the gland and suspend it in its situation. These processes are all denominated by Sir Astley the *ligamenta suspensoria*, (fig. 73). "The ends of these ligaments are spread out and incorporated with the posterior surface of the skin, and give it whiteness and firmness."

The secreting portion of the gland consists of the minute cells which were referred to at the commencement of this article, and we learn from Sir A. Cooper that "their size in full lactation is that of a hole pricked in paper by the point of a very fine pin; so that the cellules, when distended with quicksilver or milk, are just visible to the naked eye." (Fig. 74.) They are rather oval than round,

Fig. 74.



Shows the origin of the ducts from the milk cells, (injected with quicksilver and magnified four times.)

being slightly elongated where the bunch of the lactiferous tubes springs from them; but they appear more rounded to quicksilver, and

when distended with milk than when filled with wax."

These minute cells or cellules are bound up together so compactly as to form little bodies or "glandules," varying in size from a pin's head to that of a small tare. When separated from the rest of the gland but attached to the mammary duct, which originates in separate branches from its cellules, it presents a racemose appearance.

From the *cellules* the milk-tubes originate in a radiate form by small and numerous branches. They increase in size by repeated unions, and terminate by five or six branches in dilatations—the "reservoirs" of Sir Astley. "These receptacles are of a conical form (see fig. 75) like the mammillary tubes, and they begin from the extremities of the larger branches of the milk-tubes and terminate in the straight ducts of the nipple."

In most other classes of the Mammalia these reservoirs are much larger than in man, where they hardly deserve the title, and in the cow they are so capacious as to be capable of containing at least a quart.

The different ducts of these reservoirs take a straight course, diminishing in size, through the nipple to its extremity, where they terminate in a cribriform manner, with very contracted orifices, varying in size from those of a bristle to a common pin. Their number is about twenty.

Arteries.—The mamma receives its supply of blood from branches of the internal mammary, axillary, and intercostal arteries. Sir Astley divides them into anterior and posterior, the former passing from the axillary artery and the latter from the internal mam-

Fig. 75.



A view of the preparation of six milk tubes, injected from the nipple.
a, a, a, the straight or mammillary tubes, proceeding from the apex of the nipple.
b, b, b, the reservoirs or dilatations of the ducts.
c, c, c, the branches of the mammary ducts.
d, d, d, their glandules.

mary, and there is generally a large vessel entering the pectoral or costal surface of the breast and sending its branches through the gland to meet the others upon the surface of the organ. The branches from the axillary are given off by the superior and long thoracic arteries; those from the internal mammary are either derived directly from that vessel or from its intercostal branches. "The arteries upon the cutaneous surface of the breast are lodged in the festoons formed by the ligamenta suspensoria, and proceed to the nipple. There their extreme branches pass each other at the base of the nipple. They send branches forwards from the base to the apex of the nipple, which are parallel to each other and divide into very minute branches which supply the papillæ and the ducts. They also send branches from the base of the nipple backwards into the gland at its centre, and they freely anastomose with those arteries which enter the back of the gland, and they then distribute their ramifications to its substance."

Veins.—"The branches of the veins arising from the nipple pass from its papillæ in parallel branches to its base, and then form radii in an ellipse behind the areola at its margin." Their minute divisions in the papillæ with the corresponding divisions of the artery constitute the erectile tissues. From the ellipsis of veins four principal branches proceed, beside others which are less important: these are distributed on the fore part of the breast, forming a net-work by their free anastomoses.

They terminate, 1st, by two large branches in the axillary vein, and by several branches in the vein accompanying the arteria thoracica longa; 2d, in the cephalic; 3d, in the internal mammary vein by branches which pass between either the first and second or the second and third ribs; 4th, by a deep-seated vein which enters the fourth mammary intercostal vein; 5th, a plexus of veins passes over the clavicle to terminate in the external jugular and subclavian veins.

Nerves.—These are derived from the dorsal division of the spinal cord. The third dorsal nerve descends upon the vessels which are distributed to the nipple and gland, the fourth and fifth are distributed directly to the breast, and the sixth sends some filaments upon the extremities of those arteries which have passed the nipple, but which send branches into the gland. It also receives a supply from the grand sympathetic nerve.

Absorbents.—These vessels are described by Sir Astley Cooper as follows:—

"These vessels always exist in great numbers in the breast, and when the gland is in a state of lactation they are readily injected and demonstrated.

"They are divided into a superficial and deep-seated order. The first are cutaneous and are most connected with the nipple and the mucous glands of the skin, and the second arise from the interior of the glandular and secretory structure of the mamma.

"The superficial arise from the nipple,

and they pass principally upon the surface of the gland, behind the skin, on its axillary side.

"In my injections I find them as follows:—

"First, they pass upon and then under the superficial fascia, and between it and the aponeurosis of the pectoral muscle. They are next continued over the intercostal muscles.

"Here they enter the absorbent or cribriform opening, or sometimes there are two openings in the fascia axillæ, as it there passes from the edge of the pectoralis major to that of the teres major and latissimus dorsi muscles, and which fascia shuts up and forms the floor of the axilla.

"Having passed through this fascia into the axilla they enter the first set of axillary absorbent glands, and form a considerable plexus of absorbent vessels between them.

"They then rather descend to the third and fourth ribs to enter another set of absorbent glands, which are placed between the third and fourth ribs and second and third intercostal spaces, and they then ascend to the second rib.

"Here they form a large and elaborate plexus upon the axillary vein, from one to two inches below the clavicle, and reaching the first rib they again enter absorbent glands.

"From these glands, situated upon the first rib, an absorbent trunk is formed, of the size of a large crow-quill, which is placed close to the inner side of the axillary vein and between the first rib and the clavicle, and this absorbent trunk terminates at the angle formed between the right jugular and right subclavian vein, where the absorbents of the right arm and those of the right side of the neck also end in the veins.

"There is an opening formed for this vessel under the costo-clavicular ligament with a distinct margin on each side.

"The place of termination of the absorbents in the vein is a little above and behind a line drawn from the middle of the clavicle above the first rib.

"On the left side the absorbents of the breast form a similar absorbent trunk, which terminates at the angle of the left jugular and subclavian veins, at which angle the thoracic duct also ends.

"Besides this course of the absorbents from the breast and through the axilla there are other absorbent vessels which pass behind the axillary vein, artery, and axillary plexus of nerves to join the absorbents of the arm. They also pass through several absorbent glands, and ascending before the axillary plexus of nerves, they mount behind the clavicle and before the axillary bloodvessels, to terminate on each side at the angle of the jugular and subclavian veins.

"Thus there are two courses of the absorbents from the breast through the axilla; one internal to the bloodvessels and between them and the ribs; the other, which is more external, joins the absorbents of the arm, and passing behind the vessels and nerves of the arm, then crosses

the nerves and the axillary artery to enter the angle of the jugular and subclavian veins.

"If, therefore, the absorbent glands in the axilla are obstructed by disease of the breast, other absorbent vessels carry their fluid into the absorbents from the arm, and when their glands are obstructed other absorbent or lymphatic vessels are found to pass behind the scapula from the axilla to enter the cervical glands above and behind the clavicle.

"The absorbents of the sternal side of the nipple principally take two courses.

"The first accompany the vein and the artery to the second intercostal space between the second and third cartilages of the ribs, and penetrating the intercostal muscles, they pass to the anterior mediastinum, where they accompany the internal mammary artery and vein, and enter some absorbent glands.

"A set of absorbent vessels from the sternal side of the breast, placed lower down, enter the intercostal muscles between the fourth and fifth cartilages of the ribs, and join the former in the anterior mediastinum.

"After entering the anterior mediastinum a part of those which pass from the right breast join some vessels from the convex surface of the liver, and are continued into the angle of the right jugular and subclavian veins, whilst those absorbents of the left breast which enter the anterior mediastinum pass to the angle of the left jugular and subclavian veins.

"The deep-seated absorbent vessels which can be best injected from the ducts and milk celledules whilst the breast is in a state of lactation, arise from the mucous membrane of the lactiferous tubes and milk-cells, and form a plexus of great beauty in the interior of the gland.

"These numerous absorbents, as seen in the preparation, unite into two principal vessels, which pass into the axilla, and there enter the same absorbent glands as those which receive the superficial absorbents.

"Those on the sternal side of the nipple pass into the anterior mediastinum, though some of them turn round above the nipple and enter the axillary glands.

"The deep-seated absorbents, many of them, join the superficial upon the convex or cutaneous surface of the breast, and after passing through the glands in the axilla terminate with them at the angle of the jugular and subclavian veins.

"But the absorbents of the concave or costal surface of the breast take a different course. They penetrate the intercostal muscles behind the breast and enter absorbent vessels which accompany the aortic intercostal arteries on the axillary side of the breast, but on the sternal side they join the internal mammary intercostals; the former pass into the thoracic duct in the posterior mediastinum; the latter enter those vessels in the anterior mediastinum which I have already described."

The effect of age upon the mamma is to absorb its glandular structure, to load the ducts with mucus, to obliterate the milk cells, to excessively ossify the arteries, and to thin and

wrinkle the nipple, and at length in a great degree to absorb it. But the deposition of fat occupying the place of the glandular structure, the general contour of the breasts in fat persons is maintained.

On the mammary glands in the male.—The credit of discovering the intimate structure of this gland in the male is entirely due to Sir Astley Cooper; nothing, we believe, whatever having been known on the subject previous to his researches. Its size varies in different individuals; it is largest in men of light complexion and effeminate appearance. "The largest male glands which I have seen," says this author, "were found in a man whose testes were remarkably small."

In some persons it is no bigger than a large pea, in others an inch and a half or even two inches. There are papillæ on the nipple and in the areola of the male as in the female, only they are more minute and much less vascular. The cutaneous glands and tubercles are very similar in both sexes.

"The gland is constituted of two parts:—first, of very minute cells, and, secondly, of small conical ducts which divide into numerous branches in the glands, and terminate in straight ducts which end in very minute orifices at the nipple. In their form, in their divisions, and in their course through the nipple, they all form a miniature resemblance of the gland and vessels of the mammary gland in the female." (*Fig. 76.*) The whole is supported by a firm fascia, as in the female.

Fig. 76.



Five ducts of the male gland, injected with quicksilver, exhibiting its ramifications and cells. The ducts divide much in the same manner as those of the female.

Murat and Patissier, in the article *Mamma*,* refer to a case related by Dr. Renault of an individual whose mammae were equal in size to those of the female and emitted a serous fluid having the appearance of milk. The organs of generation were diminutive, the testicles about the size of a small nut, and his penis like a mere tubercle, and, even in a state of erection, only an inch and a half in length. Nevertheless he was given to venereal intercourse and all the usual habits of men.

This discovery of the glandular structure of the male breast explains, most satisfactorily, the cases which are on record of the sustenance of the infant by the male parent after the death of the female, the most authentic of which is related by Humboldt in his travels.†

* *Dict. des Sciences Méd.*

† *Vol. iii. p. 58.*

Although the usual number of mammae in the human species is only two, still there are exceptions and instances on record of more having been developed. One of the best authenticated and most recent of these cases is related by Dr. Lee, in the Transactions of the Medical and Chirurgical Society for 1837.*

In this instance "the inferior or pectoral mammae were fully developed and in the natural situation, and their nipples, areolæ, and glands presented nothing unusual in their appearance. Near the anterior margin of the axilla, a little higher up on each side, was situated another mamma, about one-sixth of the size of the others. The nipples of these were small and flat, but when gently pressed, a milky fluid which had all the external characters of the milk secreted by the other breasts, flowed copiously and readily from several ducts which opened on their extremities. When milk was drawn from the lower breasts, a small quantity usually escaped from the nipples of the superior breasts, and when the draught came into the former, the latter invariably became hard and distended." The flatness of the nipples prevented her suckling her children by them. Dr. Lee, in the above paper, quotes five other cases from foreign authors of quadruple mammae, also stating that "in some women only one breast has been developed; others have had two nipples placed on one mamma; and a few individuals have had three breasts, two in the natural situation and a third situated in the middle of the two others. Only one case has been recorded of five mammae in the human subject."†

Comparative anatomy.—In considering this division of our subject we shall especially direct our attention to those points in the anatomy of the mammae of animals which possess a physiological interest, omitting minute anatomical details unless they bear upon general principles. These organs in the Kangaroo, one of the Marsupialia, as we have already hinted at, are peculiarly formed, for the young of these animals, when first removed from the uterine cavity of its parent, is more like an earth-worm in its appearance than the active animal by which it is produced. So helpless is the condition of this young animal that it has not been inappropriately called a *mammary fetus*, for the mammae, in this instance, act at first like a true placenta as a permanent conductor of nutriment, and not, as in the higher Mammalia, a mere storehouse to be resorted to occasionally. Indeed, so close is the union between the parent and its offspring, and so imperfect the power of the fetus to abstract nourishment by suction, that Geoffroy St. Hilaire had recourse to the hypothesis that there was some vascular connexion. But the imperfect power of the fetus is compensated by the addition to the breast of a muscular apparatus, which propels forwards the nutritious juices of the mother into the alimentary cavity of the helpless

young one. From the interesting account which Mr. Morgan has given of these glands* in the Kangaroo, we shall extract the following particulars.

In this animal there are four teats, two of which, in the virgin state, are at the bottom of a narrow pouch in which they lie hid. It is to one of these teats that the marsupial fetus is attached immediately after its removal from the uterus, and their size, at first small in accordance with the minute mouth of the animal, increases with its growth. The muscular apparatus above alluded to embraces both the teat and the gland, and acts from the marsupial as its fixed point. The teat is further provided with a true vascular erectile tissue.

The upper or smaller gland is perfectly similar in its organization to the larger, and, notwithstanding the doubts which Mr. Morgan expresses regarding its use, Mr. Owen observed in the instance which he has so carefully recorded in the Philosophical Transactions for 1834, that the fetus was attached to the upper and not the lower nipples, and "that the nipple in use by the young one of the previous year was the right superior or anterior one." With regard to their minute structure it would appear from the figures of Mr. Morgau that the lacteal tubes originate in plexuses and not in cells, but the text is not very precise on this point.

The consideration of the existence of these organs in those bird-like Mammalia, the Ornithorhynchi, or duck-billed moles of Australia, is interesting. For the beak-bearing mouth of the adult would not lead us to expect the existence of a gland, the secretion of which is usually obtained by the action of a soft mouth convertible into a sucking apparatus.

Nevertheless a distinct mammary gland was described and figured by Meckel in 1826; and an organization of the lips and tongue of the young animal to correspond with it was subsequently described by Professor Owen in the Trans. Zool. Society, vol. i. p. 228, 1834.

According to Meckel this gland is placed on the side of the abdomen between the panniculus carnosus, to which it adheres loosely, and the obliquus descendens abdominis, stretching from the anterior and external margin of the pectoral muscle and inferior extremity of the sternum to the thigh. Its great size is merely one among the many instances which we meet of the comparative want of concentration of individual organs in the lower as contrasted with the higher animals, for the secreting surface itself is much less extensive than in those animals in whom the whole organ is much less.

The mammary glands of the Ornithorhynchus are peculiar for the absence of the nipple, a deficiency which is not met in any other class. In the Cetacea it is so completely buried and concealed that it has been described as absent, but it exists perfectly formed, buried in its protecting fissure. The deficiency in the first and concealment in the last

* Page 266.

† Dict. des Sciences Méd. tom. xxxiv. p. 529.

* Linn. Trans. vol. xvii. 1828.

has a relation to the aquatic mode of life, the whole surface of the body being constructed with the view of avoiding friction. The mammary gland in the *Ornythorhynchus* consists internally of pyriform cœcal pouches, with their bases turned towards the skin, their apices communicating with short excretory ducts; the walls of these pouches are thick and the cavities narrow. As regards simplicity of the internal arrangement of the gland, that in the common porpoise, where the cells and milk tubes are large and diffused, may be placed next in order to the *Ornythorhynchus*.

There is no reason for supposing that there is any essential departure from this kind of arrangement of the secreting portion of the gland in dif-

Fig. 78.



One of the clefts a little open, to shew the end of the mamillæ buried in it.

Fig. 79.

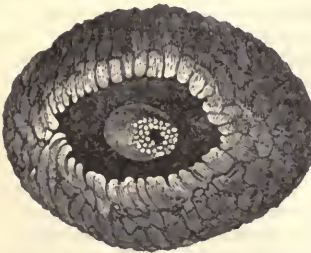

Shews the cleft more open, exhibiting the nipple and its orifice projecting into it. These clefts are placed in their natural direction in the long axis of the animal, but fig. 77 is not.

ferent animals, the cellular or vesicular having been met with in all instances where this gland has been carefully injected and unravelled. But the efferent ducts vary considerably. We learn from Sir A. Cooper that the cow, the ewe, the goat, the guinea-pig, and the porpoise, have only one tube in each teat. The pig has two, the rhinoceros has twelve, and the hare and rabbit and the cat and bitch several. "In the Graminivora the reservoirs are enormously large, in the Carnivora comparatively small. In the pig there is scarcely any reservoir; in the porpoise the great enlargement of the milk-tube is a substitute for the reservoir."

Fig. 77.

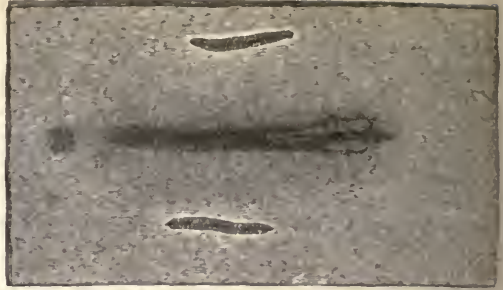

Shews the situation of the clefts in the skin of the Porpoise which contain the mamillæ, and which are placed on each side of the anus and os externum vaginae. They are considerably smaller than nature in this drawing, but figs. 78 and 79 are of the natural size.

Morbid anatomy.—It must be clearly understood by our readers that we do not intend to give more than a mere outline of its diseases, and must refer them for more ample information to the admirable works of Sir A. Cooper and others. The diseases of the breast have been divided by Sir A. Cooper into three classes; "first, those which are the result of common inflammation, whether it be acute or chronic. Secondly, into complaints which arise from peculiar or specific action, but which are not malignant, and do not contaminate other structures. Thirdly, into those which are not only founded on local, malignant, and specific actions, but which are connected with a peculiar and unhealthy state of the constitution."

Simple inflammation of the breast, like inflammation in every organ where its progress would rapidly prove destructive to its essential structure, is attended with excessive and inordinate pain, and thus gives such warning of the danger that it cannot be disregarded by the sufferer. The fibrous protective covering of the gland, like that of the testicle, prevents inordinate swelling, but occasions greater hardness to the touch. This inflammatory action, usually very unequivocal in its appearance, very rapidly develops pus; the abscess following is troublesome and extremely obstinate in cure; chronic abscess does, however, occasionally occur, and absence of all the usual symptoms of inflammation masks the character of the disease and gives rise to the suspicion that it is a malignant tumour requiring extirpation. Sir Astley relates some cases which came under his notice in which the sense of fluctuation indicated to him the true character of the disease, and others in which the extirpating knife of the surgeon was only arrested by the flow of pus. This same author describes such occasional distension of one of the lactiferous tubes caused by chronic inflammation and obliteration of its aperture as to simulate chronic abscess. The breast is liable to what has been called hydatid disease, of which there are four kinds, one of a malignant nature; the other three are not so. The first has been designated by Sir A. Cooper cellulous hydatids; the second is the sero-cystic tumour of Sir B. Brodie; the third is the ani-

mal or globular. Cellulose hydatids are simple bags containing fluid. "The breast gradually swells," says Sir A. Cooper,* "and in the beginning is entirely free from pain or tenderness; it becomes hard, and no fluctuation can then be discovered in it; it continues slowly growing for months and even years, sometimes acquiring very considerable magnitude, the largest I have seen having weighed nine pounds; but in other cases, although the bosom was quite filled with these bags, yet it never exceeded twice the size of the other breast." After a time fluctuation may be felt and the cutaneous veins enlarge, but the breast continues free from pain and the constitution does not suffer. The tumour is moveable and pendulous, in some cases involving the whole gland, in others only a small portion.

"When the swelling,† and the breast in which it is situated, are examined, it is found, upon a careful dissection, that the interstices of the glandular structure itself, and the tendinous and cellular tissue connecting it, are in a great measure filled with fibrous matter, poured out by a peculiar species of chronic inflammation, but in some instances a bag is formed into which a serous, or glairy, or sometimes a mucous fluid is secreted, according to the degree of inflammation attending it, and this fluid, from its viscosity and from the solid effusion which surrounds, as well as from the cyst being a perfect bag, cannot escape into the surrounding tissues; but by its quantity, its pressure, and by the gradual yielding of the bag, it becomes of a very considerable size; and vast numbers of these cysts are found to occupy each part of the breast, producing and supporting a continued but slow irritation, and occasioning an effusion of fibrous matter, by which the breast forms an immense tumour consisting of solid and fluid matter. Within these bags of fluid, hydatids hang by small stalks." "The size of these cells varies from the head of a pin to that of a musket-ball." "When the tumour requires removal for this disease, it is necessary to take away all the hardened and swollen parts of the breast, for they have cysts, or cells, formed in them; and if any cyst be suffered to remain, it will still continue to grow, and the remaining part of the breast to form an hydatid tumour. The great solace to the patient in this disease is, that as it does not contaminate other structures, there is no danger of its extending by absorption, of its producing any complaint beyond the breast, or of its affecting other parts of the body; nor have I seen it seated in both breasts at the same time."

Sir B. Brodie‡ has pointed out an important feature in the development of certain cysts in the breast, which are different from the true hydatid. This consists in the generation of a morbid growth or excrescence from their interior, which becoming organized sometimes

entirely fills the cyst so as to convert it into a solid tumour, which ultimately protrudes externally as a fungous growth, and presents a new and formidable appearance. "In this last stage of the disease,* it is evident that spreading ulceration, sloughing and hæmorrhage, the usual results of an ulcer occurring in a diseased structure, must ensue, and that no remedy is likely to be of any service to the patient, except the removal of the affected parts by surgical operation." The operation is not recommended in the early stages of the disease, as these cysts sometimes become absorbed previously to the development of the fibrous tissue. As the disease is merely local the operation is wholly unattended with danger. The term by which Sir B. Brodie designates these tumours is that of "sero cystic tumour of the breast." It appears probable that the *bladder scirrhus* of Dr. Benedict is nothing more than this form of hydatid disease.

"The third species of hydatid† which is found in the breast is the animal or globular, and which consists of a bag containing a fluid, which has no vascular connection with the surrounding parts; and it produces within its interior a multitude of bags similar to itself. It is in fact a true entozoon similar in every respect to that found in the brain of sheep and in many other organs of the human frame."

"When one of these hydatids,‡ says Sir A. Cooper, "is produced in the breast, an inflammation is excited by it, and a wall of fibrine surrounds it, it feels hard, and from the small size of the hydatid a fluctuation cannot be discovered; but as the hydatid grows, although the quantity of solid matter increases, yet as the fluid in the hydatid becomes more abundant, a fluctuation in the centre of the tumour may be ultimately perceived."

The disease is not malignant, and if a simple puncture and evacuation of its contents should not prove effectual in dispersing it, may be removed without danger.

The *chronic mammary* tumour occurs early in life and unconnected with any diseased state of constitution. "It grows," according to Cooper, "from the surface of the breast rather than from its interior, and it therefore generally appears to be very superficial, excepting if it spring from the posterior surface of the breast, when it is deep-seated and its peculiar features are less easily discriminated." These tumours are unconnected with the glandular structure of the breast. Dr. Warren§ relates a case in which he removed one of these tumours from a young woman, who four years after the operation nursed an infant from the same breast. They are extremely moveable, frequently begin without pain, and continue many years without exciting any uneasiness. They vary in size, have a lobulated character, and are invested in a fibrous membrane. "Although these tumours are not in their commencement malignant, and

* Illustrations of the Diseases of the Breast, by Sir A. Cooper, 1829. Part i. p. 21.

† Page 22, op. cit.

‡ Medical Gazette, Feb. 21, 1840.

* Page 842, loc. cit.

† Page 45, op. cit.

‡ Loc. cit. page 48.

§ Surgical Observations on Tumours, Boston, 1837, p. 211.

they continue for many years free from the disposition to become so, yet if they remain until the period of the cessation of menstruation they sometimes assume a new and malignant action.* The breast is not exempted from the deposit of either cartilaginous or ossific matter, and tumours of this character are occasionally developed in its substance.

The breast is occasionally enlarged by hypertrophy of the adipose tissue. A tumour of this kind, removed by Sir Astley Cooper, is preserved in the Museum of St. Thomas's Hospital, which weighed 14 lbs. 10 oz. The whole structure of the mamma also has been found hypertrophied and the breasts enormously increased in dimensions without being apparently the subject of any disease. That all-pervading poison of some constitutions—the scrofulous tubercular matter—does not leave the mamma exempt from its influence. Sir Astley says that these tumours “can only be distinguished from the simple chronic inflammation of the breast by the absence of tenderness, and by the existence of other diseases of a similar kind in the absorbent glands of other parts of the body.” They produce no dangerous effects, and do not degenerate into malignancy.

“The breast is liable to become irritable without any distinct or perceptible swelling, as well as to form an irritable tumour composed of a structure unlike that of the gland itself, and which therefore appears to be of a specific growth.” “When the complaint affects the glandular structure of the breast, there is scarcely any perceptible swelling, but one or more of its lobes becomes exquisitely tender to the touch, and if it be handled the pain sometimes continues for several hours.” “There is no external mark of inflammation, as the skin remains undiscoloured.” “Besides this irritable and painful state of a whole or part of the breast, a tumour sometimes is found distinctly circumscribed, highly sensitive to the touch, acutely painful at intervals, more especially prior to menstruation, very moveable, often not larger than a pea, seldom exceeding the size of a marble; generally one only exists, but in other cases there are several similar swellings.”

“Although they continue for years they vary but little in size. I have never seen them suppurate. They sometimes spontaneously cease to be painful, and sometimes disappear without any obvious cause. Upon dissection they are found to be composed of a solid and semi-transparent substance, with fibres interwoven with it, but without any regular distribution, and I have not been able to trace any large filament of a nerve into them.” “The pain with which this tumour is accompanied, its tenderness to the slightest touch or to pressure of any kind, the suffering which succeeds examination, distinguish it from the hydatid, the chronic mammary tumour, and the scirrhous and fungous tubercle.”

The malignant or incurable diseases of the breast may be classed under two heads, scirrhous carcinoma or cancer, and fungus hæmatodes.

Scirrhous has been again subdivided into

genera by different authors, some in relation to their external appearances and situation, others in accordance with their internal structure. Dr. Benedict, Professor in the University of Breslau,* in giving the following arrangement has rather pursued the former plan:—1st. Cutaneous cancer. 2d. True scirrhous; consisting of—1. Nodulated scirrhous; 2. Lard-like scirrhous; 3. Bladder scirrhous.

Müller, in his late work on cancer, which has been translated by Dr. West, describes the different kinds of carcinoma to which the breast, in common with other organs, is liable, not in reference to their seat whether cutaneous or glandular, but in accordance with their intimate structure; and to scirrhous, medullary sarcoma, carcinoma alveolare, and carcinoma melanodes of former authors, has added carcinoma reticulare and fasciculatum. To these we shall return a little further on, dwelling previously on a form of cancer which is not very common but highly important in a practical point of view to the surgeon.

“Cutaneous cancer of the breast,” says Dr. Benedict, p. 39, “deserves to be particularly noticed, because most surgeons frequently confound it with the common cancer, from which it, however, materially differs. It never springs in the substance of the organ, but always and solely in the surface of the skin, and most probably from fat and adipose glands of the same. Its form is similar to that of cancer in the face and eyelids, and arises in the same way. At first there is nothing but a little knot, wart, or hard little spot somewhere upon the skin of the breast. This place begins gradually to redden and then passes into a stage of ulceration. The swelling which has hard edges and a hard base spreads out, increasing both in depth and width so as to advance from the skin into the substance of the gland, not passing far, and only very gradually destroying the breast. The glands of the axilla are not attacked so early as in carcinoma of the gland itself, and the hectic fever which ultimately destroys the patient develops itself after a much longer period.

Mr. Travers (Med. Chir. Trans. vol. xvii.) also describes this cutaneous cancer in the following words: “There is a cancerous tubercle of the skin which appears upon the breast as in other parts, connected with a remarkable change in the texture of the skin. The affection of the skin is, I believe, primary. It consists of a brawning induration with extension of the areole, a coarseness such as this texture presents when viewed through a magnifier, and which gives it a resemblance to pig's skin. Isolated tubercles of various sizes appear at considerable distances apart: the texture of the subjacent cellular membrane is enormously thickened and has a cartilaginous hardness; and the breast when the skin undergoes this change upon that organ is early and immovably fixed to the chest.” I have drawings of two cases of the kind: one which occurred in the practice of

* Bemerkungen über die Krankheiten der Brust- und Achsel-Drüsen. Breslau, 1825, 4to. p. 59.

Mr. Travers, at St. Thomas's Hospital, the other in the private practice of Mr. South; the former I inspected in company with that gentleman. The post-mortem appearances were interesting from the immense crop of white hard tubercles which were found studding the pleura costalis.

Dr. Benedict considers that "the primary skin disease can be removed almost always with a favourable result if the operation is performed previous to enlargement of the neighbouring glands, disease of the parenchyma of the mamma, or constitutional fever."

The ordinary scirrhus of the mamma in its early stages usually presents itself to the surgeon as a hard tumour, situated *in* not *on* the glandular substance of the breast. At first it is comparatively moveable, but it cannot be moved independent of the structure which surrounds it, and in the progress of development it soon contracts adhesions by means of root-like prolongations with the whole mamma. Its surface varies, not decidedly nodulated nor yet uniformly smooth; not tender to the touch, though it may be the seat of sharp lancinating pains. As the tumour increases, its adhesions extending on all sides, the nipple becomes drawn in, and its most prominent surface assumes a dusky hue. The constitution now begins to suffer, the glands in the axilla enlarge, and at this period there is no difficulty in distinguishing the nature of the disease. In its early stage it might be confounded with a tumour which Mr. Travers in his paper just referred to has thus described: "There is a tumour met with in the breasts of young women, more like a shelled walnut in point of size and nodosity than any thing to which I can compare it. It is of a stony hardness, and it is not reduced by regulated equal compression, mercury, iodine, or blisters. It is an enlargement and partial cohesion of the lactiferous-tubes in a cluster, in one or more places, and which disposition in a less degree pervades the ducts throughout the organ." The absence of lancinating pains, constitutional disturbance, and the peculiar countenance attendant on malignant disease, assist the surgeon in his diagnosis. The earlier period of life at which it makes its appearance is also a circumstance worthy of attention.

Müller describes scirrhus, or carcinoma, simplex (syn. carcinoma fibrosum) as "irregular in form,* not lobulated, hard and resisting the knife, and presenting, when divided, a greyish appearance which has but very little similarity to cartilage. Whitish bands are not invariably present. Scirrhus of the mammary gland occasionally shews, here and there, whitish filaments, some of which are hollow, and contain a colourless, whitish or yellowish matter. Probably this appearance of white filaments is the result of thickening of the walls of the lactiferous tubes and lymphatics, and this idea is confirmed by the absence of these filaments from scirrhus of non-glandular parts. The mass of scirrhus is composed of two substances,

the one fibrous, and the other grey and granular." The fibrous substratum is composed of a very irregular net-work of firm bundles of fibres. The grey consists of microscopic, formative globules, but slightly adherent to each other; they are transparent hollow cellules, from 0.0048 to 0.00166 or 0.00130 of an English inch in diameter, some of them exhibiting a distinct nucleus. They have no connection with the fibrous structure."

Carcinoma reticulare, Müller says,* "occurs more frequently than carcinoma simplex. On making a section of it, it may be immediately distinguished from the latter by the white reticulated figures intersecting the grey mass, which are perfectly evident to the naked eye. It acquires a large size more readily than carcinoma simplex, and is further distinguished from its tendency to assume a lobulated form. It sometimes approaches the consistence of scirrhus, at other times it is softer and more nearly resembles fungus medullaris." Though its consistence varies, its structure always remains the same, and with the exception of cancer alveolaris, no form of carcinoma can be so readily distinguished.

Carcinoma alveolare, though usually found in the stomach, occasionally attacks the breast, and a very good specimen of it is deposited in the museum of St. Thomas's Hospital. This disease, like the former one, consists of innumerable white fibres and lamina crossing each other in all directions, and having their interspaces occupied by cells which vary in size from that of a grain of sand to that of a large pea. For the history of the development of this and other forms of cancer see PRODUCTS, MORBID.

Soft cancer, fungus hæmatodes, and medullary carcinoma, are one and the same disease. It forms a soft elastic swelling, giving something of the sensation to the fingers of deep-seated fluid, increases rapidly, and is seldom confined to any single organ in the body. It occurs earlier in life than scirrhus, and is more decidedly a constitutional disease. "The tumour with which alone this is liable to be confounded," says Mr. Travers, "is the hydatid breast, as it is called, and there is sufficient resemblance in the rounded outline, the elastic resistance, the absence of glandular affection, the distressing inconveniences of size, weight, and distension, the turgid veins and livid discoloration of the surface, to create some hesitation. But in the medullary disease it seldom happens that the health is not affected, whereas in the hydatid breast it is undisturbed; the figure of the medullary tumour is less uniform, being marked by dark tuberosity elevations and immovably fixed to the side by the prolongations of the diseased growth in one or more parts of its circumference; whereas the hydatid tumour, notwithstanding its oftentimes enormous bulk, is globular and remains perfectly detached and pendulous. The main distinction is that the mammary gland is not, in my experience at least, the seat of the medullary or fungoid disease as it is of the hydatid.

* West's Translation, 41.

* Page 45, loc. cit.

"In proportion as the malignant fungus is recent and of small dimensions, is the difficulty of diagnosis from the hydatid cyst, for the fungus, as I have before said, ordinarily commences on the interior of a cyst containing a fluid, from the vascular lining of which it hangs like a fringe, and it is common to find more than one, often several contiguous cysts, in the early stage of the disease. As the fungi grow, the cysts burst and are blended in the same mass. From this account it will appear that there is sufficient analogy between the hydatid and fungoid disease in its incipient state to require more aids to diagnosis than those derived from manual examination. We sometimes meet with puzzling analogies in these diseases."

"The relation of medullary sarcoma," says Müller, "to scirrhus or carcinoma simplex is displayed by the fact that after amputation of a scirrhus breast, real fungoid tumours may occur in other parts, as many observations of Zäuptaft, Cruveilhier, and others abundantly shew. This affinity is further illustrated by microscopic examination, which shews that many structures comprehended under the generic term of fungus medullaris differ greatly from each other, and have nothing in common but the softness of their texture." Müller therefore employs the term fungus medullaris "as a collective name for different forms or stages of development of soft cancer, which undergo imperceptible transitions into each other." The following are the varieties for a knowledge of the minutiae of which we must refer our readers to the original.

"1. Carcinoma medullare, abounding in roundish formative globules which make up the greater part of the medullary mass, though intersected by a delicate fibrous net-work.

"2. Carcinoma medullare, with an exceedingly soft cerebriform base composed of pale elliptical bodies without caudate appendages.

"3. Carcinoma medullare, with caudate or spindle-shaped corpuscles.

"*Carcinoma fasciculatum* (syn. *hyacinum*.)—Among the structures commonly included under the name fungus medullaris, are some altogether fibrous in their texture, and which correspond with other forms of that disease only in the softness of their tissue. The fibrous structure of these growths is immediately evident on breaking or dividing them; when torn they do not crumble, but are readily rent in the direction of the fibres. If examined under a microscope they display neither the cellular globules of other varieties of carcinoma, nor the caudate corpuscles which give a fibrous appearance to some forms of fungus medullaris."

Mr. Travers, in the paper previously referred to, says that "certain anomalous morbid changes, as large fungous excrescences and deep cavernous fetid ulcers, are now and then the sequelæ of tumours in the female breast which are in a loose and slovenly classification termed cancerous. They are not so; but they are almost as incapable of being conducted to a curative termination as if they were; their

progress can scarcely be said to affect the health, being remarkable for its slowness and freedom from pain." He also describes an excoriation of the integument around the nipple gradually extending over the breast, accompanied by an ichorous exudation which remains in the same incurable state many years, and ultimately throws up a broad toad-stool fungus exquisitely irritable and much disposed to bleed. It affects neither the glands nor health."

Melanosis or black cancer has been met with in the breast, but we believe never as a primary disease, the breast having been attacked subsequently to other tissues. Breschet, in his treatise on this disease, gives a representation of it in this organ. There is a preparation of it in the museum of Bartholomew's Hospital. It is considered by Müller as "merely a variety of cancerous degeneration, and terminates in the same way as other forms of carcinoma."

"Microscopic examination," says Müller, "detects two forms of melanotic structure. In both instances the basis of the structure is formed of a fibrous network, the stroma of melanosis, within the meshes of which the melanoid matter is deposited. This matter is generally composed of cells, filled with yellowish or blackish green granules. These cells are and always continue to be free, never becoming coherent. Their forms are very various. Many, indeed most, are round, oval, or irregular; some are elongated; a few actually caudate, terminating at one or both extremities in a point or in a fibril. Still more rarely the cells present several points. They are real pigment cells." This author discovered in one of the larger cells a nucleus with its nucleolus, independently of the pigment granules. We cannot conclude this article more satisfactorily than by quoting from the same accurate observer, Mr. Travers, of whose observations we have already so fully availed ourselves.

"No description can comprehend all the varieties of tumour to which this organ is liable, nor does any share of experience enable the nicest observation to suggest an infallible clue to their nature. We have sometimes only manipulation to depend upon, which is an art imperfectly cultivated by scientific surgeons. Cases now and then arise about which the most accurate observers are liable to error. True it is this does not frequently happen in the distinction between innocent and malignant growths. The several species of innocent tumours already enumerated may all be distinguished from scirrhus with comparatively little difficulty; but if any doubt exists we must consider the age, habits, and circumstances of the patient. For example, we should ascertain if marks of scrofula are present; if the uterine functions are regular and healthy; if the tumour can be referred to violence in the commencement, which from the exposed situation of the organ is far from uncommon; if more than one lump exists in the same breast; if both breasts are infected; if painful, the character of the pain; if any absorbent glands are altered in the neighbourhood and how. How many cases of breast tumour are in the recol-

lection of experienced surgeons which have been dispersed by some one or other of the remedies in ordinary use, local or constitutional; and how many that have resisted all and remained stationary for years, the patient's mind having been tranquilized by the assurance of their innocence. Doubtless on the other hand a fatal result has sometimes administered a silent but painfully intelligible reproof to the over-confidence of the surgeon." (Samuel Solly.)

MARSUPIALIA, (*Marsupium*, a pouch,) Eng. *Marsupials*; Fr. *Marsupiaux*; Ger. *Beuteltiere*.

Essential external character.—Mammalian quadrupeds, distinguished by a peculiar pouch or duplicature of the abdominal integument, which, in the males, is everted and contains the testes; in the females is inverted, covering the mammae, and generally sheltering the young for a certain period after their birth.

Essential internal character.—In both sexes two supplementary trochlear bones are articulated to the anterior part of the brim of the pelvis, around which play the muscles embracing and supporting the testes in the male, and the mammary glands in the female; these bones, from their connexion with the pouch, are called "marsupial."

The quadrupeds associated together by the common external and osteological characters above defined, are ovo-viviparous or implantational,* the vascular layer of the allantois not being developed, so as to organize the villi of the chorion, or to form cotyledons or a placenta. The marsupial also differ from the placental Mammalia in other important parts of internal organization, as in the structure of the brain and of the heart, and in the condition of the sanguiferous and absorbent systems; and they present remarkable modifications of the genital apparatus in both sexes.

Classification.—The Marsupial animals are generally of small size; some, as the Pigmy Opossum (*Petaurus pygmaeus*), and Dwarf Phalanger (*Phalungista nana*), are less than the common mouse: the largest known existing species is the common or Great Kangaroo (*Mucropus major*). With the exception of the Virginian Opossum, all the Marsupialia are confined to the southern hemisphere of the globe, and they are principally natives of Australasia, to which part of the world several remarkable genera are peculiar, and where, with a few exceptions, as certain Cheiroptera and a few Rodent genera, as *Hydromys*, *Hupalotis*, and *Pseudomys*, all the known aboriginal mammals are Marsupial or Monotrematous.†

It is in the Australian continent that we perceive the Marsupial quadrupeds typifying, so to say, or playing corresponding parts with those allotted to the placental Mammalia in a larger theatre of the habitable surface of the

earth. The carnivorous *Thylacines** and *Dasyures*,† for example, are the pigny destructives of the country, committing occasional ravages among the sheep and poultry, but not disdaining dead animal matter or garbage.

The species of *Phascogale*, *Myrmecobius*, and *Perameles* represent the placental Insectivora. Many Marsupials which live in trees have an omnivorous or vegetable diet; these in their prehensile tail and hinder thumb typify the *Quadrumanu*; and one species, the tailless Koala, seems to represent the American sloths or the arboreal sun-bears of the Indian Archipelago.

Another species of Marsupial, the Wombat, presents the dentition which characterizes the placental Rodentia; and the Petaurists, like the flying squirrels, have a parachute formed by broad duplications of the skin extending laterally between the fore and hind legs.

The Kangaroos are the true herbivorous *Marsupialia*, and many interesting physiological conditions present themselves to the mind in contemplating the singular construction and proportions of these animals. It would appear that the peculiarities of their gestation rendered indispensably necessary the possession of a certain prehensile faculty of the anterior extremities, with a free movement of the digits and a rotatory power of the fore-arm, in relation to the manipulations of the pouch and of the embryo therein protected and matured. At the same time an herbivorous quadruped must possess great powers of locomotion in order to pass from pasture to pasture, and to avoid its enemies by flight. These powers, as is well known, are secured to the herbivorous species of the placental Mammalia by an unguulate structure of four pretty equally developed members. Such a structure, however, would have been incompatible with the procreative economy of the Kangaroo. It is, therefore, organized for a rapid course by an excessive development of the hinder extremities, and these alone serve the animal in flight, which is performed by a succession of extensive bounds. The tail, also, is of great power and length, and, in the stationary position, the body is supported erect on the tripod formed by the tail and hind legs, while in easy progression the tail serves as a crutch, upon which and the fore feet the body is sustained while the hind legs are swung forwards.

As the Australian Continent, the great metropolis of the Marsupial quadrupeds, still remains but very partially explored, and as new species and even genera of Marsupials continue at each expedition to reward the researches of the scientific traveller; and as, moreover, the recovery of two lost but distinct genera from the ruins of a former world makes it reasonable to suppose that other types of Marsupials remain still hidden in the crust of the earth, it can hardly be expected that the zoologist should be able to arrange in a natural series, with easy transitions according to the

* On the Generation of the Marsupialia, Philos. Trans. 1834, p. 333.

† The Dingo or Wild Dog is without doubt a comparatively recent and accidental introduction.

* The Hyæna of the Colonists.

† The Devil, Native Cat, &c. of the Colonists.

order of their affinities, the few and diversified forms of this implacental group which are at present known.

In the subjoined classification the modifications of the digestive system have been taken as the guide to the formation of the primary groups of the Marsupialia.

The Continent, however, in which the Marsupials exist in greatest number and variety, is characterized by the paucity of organized matter upon its surface, and consequently few of the species are nourished by a well-defined diet. No large carnivorous quadruped could without much difficulty have found subsistence in the wilds of Australia, prior to the introduction of civilised man and his attendant herds; and we find, in fact, that the native genera which are the most decidedly carnivorous do not include species larger than the dog. We can only reckon among these strictly carnivorous species the Thylacines and the Dasyures; and, on the other hand, not more than two or three Marsupial genera feed exclusively on vegetable substances. The remainder derive a promiscuous nutriment from dead or decaying animal and vegetable matter, crustacea, and the refuse of the sea-shore, insects in their perfect and larva states, live birds, young and succulent sprouts, leaves, fruits, &c. The terms, therefore, which will be given to the different primary subdivisions in the present classification of the Marsupialia must not be understood to indicate strictly or exclusively the nature of the food of the species severally included in these groups, but rather their general tendency to select for their support the substances implied by those designations.

*Classification of the Marsupialia.**

Tribe I. *SARCOPHAGA*.

The genera in this tribe are characterized by an important anatomical condition, viz. the absence of an *intestinum cæcum*.

Genus 1. *THYLACINUS*. (Fig. 80.)

Fig. 80.



Thylacinus Harrisii, one-third natural size.

Incisors $\frac{4-4}{3-3}$; canines $\frac{1-1}{1-1}$; premolars $\frac{3-3}{3-3}$; molars $\frac{4-4}{4-4} = 46$.

* Proceedings of the Zoological Society, Jan. 8,

The incisors are of equal length and regularly arranged in the segment of a circle with an interspace in the middle of the series of both jaws. The external incisor on each side is the strongest. The laniary or canine teeth are long, strong, curved, and pointed, like those of the dog tribe. The spurious molars in this as in all other Marsupials have two roots; their crown presents a simple compressed conical form, with a posterior tubercle which is most developed on the hindmost. The true molars in the upper jaw are unequally triangular, the last being much smaller than the rest; the exterior part of the crown is raised into one large pointed middle cusp and two lateral smaller cusps obscurely developed; a small strong obtuse cusp projects from the inner side of the crown. The molars of the lower jaw are compressed, tricuspidate, the middle cusp being the longest, especially in the two last molars, which resemble closely the sectorial teeth (*dents carnassiers*) of the dog and cat.

The fore feet are 5-digitate, the hind feet 4-digitate. On the fore foot the middle digit is the longest, the internal one or pollex the shortest; but the difference is slight. On the hind foot the two middle toes are of nearly equal length and longer than the two lateral toes, which are equal. All the toes are armed with strong, blunt, and almost straight claws.

The only known species of this genus,—the Thylacine (*Thylacinus Harrisii*, Temm., *Didelphys Cynocephalus*, Harris,) is a native of Van Dieman's Land, and is called by the Colonists the "Hyæna." It is the largest of the carnivorous Marsupials, equalling in size the shepherd's dog, but is of a broader build, and stands lower on its legs. Its head is of disproportionate magnitude. The principal characteristic of its colour is the transverse black bands which traverse the back. It dwells in caverns and holes in the rocks, and seeks its prey by night, devouring the smaller native quadrupeds, and at the present day committing destructive ravages on the numerous flocks of sheep which have been introduced by the European settlers into the island. Even the spines of the Echinida seem to be no defence against the destructive and voracious propensities of the powerful Thylacine, for the partly digested remains of one of these monotremes have been found in its stomach.

In confinement the Thylacine utters from time to time a short guttural cry, and appears in the daytime exceedingly inactive and stupid, presenting an almost continual movement of the nictitating membrane of the eye.

1839. The series of skulls carefully prepared by Mr. Waterhouse at the Zoological Society have afforded me the chief materials for the illustrations of the dental formulæ of the different Marsupial genera.

Genus *DASYURUS*. (Fig. 81.)

Fig. 81.

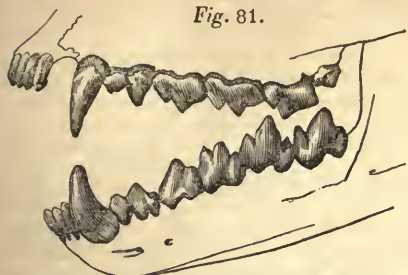

Dasyurus Ursinus, one-third natural size.

Incisors $\frac{4-4}{3-3}$; canines $\frac{1-1}{1-1}$; præmolars

$\frac{2-2}{2-2}$; molars $\frac{4-4}{4-4}$: = 42.

The eight incisors of the upper jaw are of the same length and simple structure, and are arranged in a regular semicircle without any median interval. The six incisors of the lower jaw are similarly arranged, but have thicker crowns than the upper ones. The canines present the same or even a greater relative development than in the *Thylacine*: in an extinct species of *Dasyurus** they had the same form and relative proportions as in the *Leopard*. The spurious molars have a pointed compressed triangular crown with a rudimental tubercle at the anterior and posterior part of its base. The grinding surface of the true molars in the upper jaw is triangular; the first presents four sharp cusps, the second and third each five, the fourth, which is the smallest, only three. In the lower jaw the last molar is nearly of equal size with the penultimate one, and is bristled with four cusps, the external one being the longest: the second and third molars have five cusps, three on the inner and two on the outer side; the first molar has four cusps: these are all sharply pointed in the young animal, in which the posterior tubercle of the posterior molar in the lower jaw is divided into two small cusps.

The carnivorous character of the above dentition is most strongly marked in the *Ursine Dasyure* or *Devil* of the Tasmanian Colonists, the largest existing species of the genus, and a most pestilent animal in the poultry-yard or larder.

Genus *PHASCOGALE*. (Fig. 82.)

Fig. 82.



Phascogale penicillata.

* *Dasyurus lanianus*, Owen: the fossil remains of this species were discovered with those of two gigantic species of Kangaroo in the bone-caves of Wellington Valley, Australia, by Major, now Sir Thomas, Mitchell.

Incisors $\frac{4-4}{3-3}$; canines $\frac{1-1}{1-1}$, præmolars $\frac{3-3}{3-3}$; molars $\frac{4-4}{4-4}$: = 46.

In the present dental formula may be discerned a step in the transition from the *Dasyures* to the *Opossums*, not only in the increased number of spurious molars, but also in the shape and proportions of the incisors. In the upper jaw the two middle incisors are longer than the rest, and separated from them by a brief interval; they are more curved and project more forward. The three lateral incisors diminish in size to the outermost. The middle incisors of the lower jaw also exceed the lateral ones in size, and project beyond them but not in the same degree, nor are they separated from them by an interval, as in the upper jaw. The canines are relatively smaller than in the *Dasyures*. The spurious molars present a similar form, but the third in the lower jaw is smaller and simpler than the two preceding ones. The true molars resemble those of the *Dasyures*.

The general character of the dentition of these small predatory Marsupials approximates to the insectivorous type, as exemplified in the *Shrew*, *Hedgehog*, &c. among the placental *Mammalia*, and corresponds with the food and habits of the species which thus lead from the *Sarcophagous* to the *Entomophagous* tribes.

The interval is further diminished by a lost marsupial genus which forms one of the ancient *Mammalia* that have rendered the oolitic formations at *Stonesfield* so celebrated. This genus, which I have called *Phascolotherium*, presents the same numerical dental formula as in *Phascogale*, viz.

Incisors $\frac{?-?}{3-3}$ or $4-4$; canines $\frac{?-?}{1-1}$;
 præmolars $\frac{?-?}{3-3}$; molars $\frac{?-?}{4-4}$.

But the incisors and canines are separated by vacant interspaces, and occupy a large proportional space in the dental series: the true molars resemble those of *Thylacine*.

Tribe II. *ENTOMOPHAGA*.

This is the most extensive and varied of the primary groups of the Marsupial order. In the system of *Cuvier*, the species of this tribe are united with those of the preceding to form a single group characterized by the presence of long canines and small incisors in both jaws: but in most of the *Entomophagous* genera of the present classification, the canines present a marked inferiority of development, and the species are consequently unable to cope with animals of their own size and grade of organization, but prey, for the most part, upon the smaller and weaker classes of invertebrate animals. Their intestinal canal is complicated by a moderately long and large cæcum; and while, in the *Sarcophaga*, the feet are constructed upon the plan of those of the ordinary placental *Digitigrades*, they offer in the present tribe a variety of well-marked modi-

fications, according to which the species may be arranged into gressorial, saltatory, and scansorial groups.

a. Gressoria.

Genus MYRMECOBIUS.

The only known existing representative of this family is the animal described by Mr. Waterhouse, which constitutes the type of his genus *Myrmecobius*, and of which the following is the remarkable dental formula. (Fig. 83.)

Fig. 83.

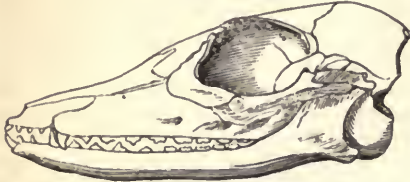

Myrmecobius fasciatus.

Incisors $\frac{4-4}{3-3}$; canines $\frac{1-1}{1-1}$; præmolars $\frac{3-3}{3-3}$; molars $\frac{6-6}{6-6}$ = 54.

From this formula it will be seen that the number of molars, eighteen in both jaws, exceeds that of any other known existing marsupial, and nearly approaches the peculiar dental formula of the extinct *Thylacotherium*,* and that which characterizes some of the existing Armadillos. The resemblance to the genus *Dasypus* is further carried out in the small size of the molar teeth, their separation from each other by slight interspaces, and their implantation in sockets, which are not formed upon a well-developed alveolar ridge or process. The molars, however, present a distinct multicuspitate structure, and both the true and false ones possess two separate fangs, as in other Marsupials. The inferior molars are directed obliquely inwards, and the whole dental series describes a slight sigmoid curve, (fig. 97.) The false molars present the usual compressed triangular form with the apex slightly recurved; and the base more or less obscurely notched before and behind. The canines are very little longer than the false molars; the incisors are minute, slightly compressed and pointed; they are separated from each other and the canines by wide intervals.

The Myrmecobians are insectivorous,† and shelter themselves in the hollows of trees, frequenting most, it is said, those situations where the Port-Jackson willow abounds. In the structure and proportions of its hinder feet, *Myrmecobius* resembles the Dasyurine family; and in the slightly developed canines, the smooth external surface of the skull, the breadth between the zygomata, and the absence of the interparietal ridges, as well as in its

* This small Insectivore, of which the marsupial character is doubtful, had twenty-four molars in each jaw.—See *Geol. Trans. New Series*, vol. vi. part 1.

† Mr. Gould informs me that they feed exclusively on ants.

general external form and bushy tail, it offers an especial approximation to the genus *Phascogale*.

β. Saltatoria.

Genus PERAMELES. (Bandicoots, fig. 84.)

Fig. 84.



Perameles nasuta.

Incisors $\frac{5-5}{3-3}$; canines $\frac{1-1}{1-1}$; præmolars $\frac{3-3}{3-3}$; molars $\frac{4-4}{4-4}$ = 48.

This dental formula characterizes a number of Marsupials commonly known in Australia by the name of *Bandicoots*; the hind legs are longer and stronger than the fore, and exhibit in a well-marked manner the feeble and slender conditions of the second and third digits counting from the inside, and the sudden increase in length and strength of the fourth and fifth, or two outer toes, which are chiefly subservient to locomotion. In consequence of the inequality of length in their extremities the mode of progression in the Bandicoots is by bounds, the hind feet being moved together, and alternately with the fore feet, as in the hare and rabbit, and the crupper is raised higher than the fore-quarter. The teeth which offer the greatest range of variation in the present genus are the external or posterior incisors and the canines: the molars, also, which originally are quinque-cuspitate, have their points worn away, and present a smooth and oblique grinding surface in some species sooner than in others.

The Bandicoots which approach nearest to the *Myrmecobius* in the condition of the incisive and canine teeth, are the *Perameles obesa* and *P. Gunnii*. There is a slight interval between the first and second incisor, and the outer or fifth incisor of the upper jaw is separated from the rest by an interspace equal to twice its own breadth, and moreover presents the triangular pointed canine-like crown which characterizes all the incisors of *Myrmecobius*; but the four anterior incisors are placed close together and have compressed, quadrate, true incisive crowns. From these incisors the canine is very remote, the interspace being equally divided by the fifth pointed incisor, which the canine very slightly exceeds in size. In *Peram. nasuta* the incisor presents the same general condition, but the canines are relatively larger, In *Per. Gunnii*, the outer incisor is closer to the others, which it also more nearly resembles in form than in the preceding species; but in *Per. Lagotis*, it is not separated from the rest by a wider interval than that which intervenes between the first and second incisor. In both

the preceding Bandicoots the canines are long and well developed, but the true molars have the grinding surface worn down flat in the full-grown specimens which I have had the opportunity of examining.

The marsupial pouch in the Bandicoots, at least in the full-grown females of *Per. nasuta*, *Per. obesula*, and *Per. Lagotis*, has its orifice directed downwards or towards the cloaca, contrariwise to its ordinary disposition in the Marsupials: this direction of the pouch evidently relates to the procumbent position of the trunk when supported on the short fore and long hind legs. In the stomach and intestines of a *Perameles obesula* I found only the remains of insects; and in the examination of the alimentary canal of a *Per. nasuta*, Dr. Grant obtained the same results. Nevertheless the *Perameles Lagotis*, lately living at the Zoological Gardens, refused meat and meal-worms, and subsisted on vegetable food exclusively.

Genus CHEROPUS.

The singular animal on which Mr. Ogilby has founded this genus, is briefly noticed and figured in Major Mitchell's Australia, (Vol. ii. pl. 38, p. 131,) and the individual described is preserved in the Colonial Museum, at Sydney, N. S. Wales, (No. 35 of Mr. Geo. Bennett's Catalogue.)

It would appear that the two outer toes of the fore foot, which are always very small in the true Bandicoots, are entirely deficient in the *Charopus*, unless some rudiments should exist beneath the skin; at all events only two toes are apparent externally; but they are so developed and armed as to be serviceable for burrowing or progression. The inner toe is wanting on the hind-foot. Dental formula:

Incisors, $\frac{4-4}{3-3}$; canines, $\frac{1-1}{1-1}$; præ-molars, $\frac{3-3}{3-3}$; molars, $\frac{4-4}{4-4}$: = 46.

All the teeth are of small size; the canines resemble the spurious molars in size and shape, and these are separated by intervals, as in *Myrmecobius*. The marsupium opens downwards in the *Charopus*, as in the true Bandicoots. The species described has no tail. The genus would seem by its dentition to rank between *Myrmecobius* and *Perameles*. Its digital characters are anomalous and unique among the Marsupialia, but are evidently a degeneration from the Saltatorial or Bandicoot type.

γ. *Scansoria*.

Genus DIDELPHYS, (Opossums, fig. 85.)

These Marsupials are now exclusively confined to the American Continents, although the fossil remains of a small species attest their former existence in Europe contemporaneously with the *Palæothere*, *Anoplothere*, and other extinct *Pachyderms*, whose fossil remains characterize the Eocene strata of the Paris Basin. The dental formula of the Genus *Didelphys* is,—

Incisors, $\frac{5-5}{4-4}$; canines, $\frac{1-1}{1-1}$; præ-molars, $\frac{3-3}{3-3}$; molars, $\frac{4-4}{4-4}$: = 50.

The Opossums resemble in their dentition the

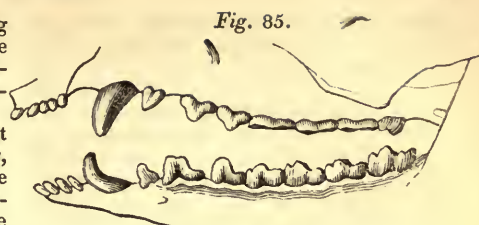

Didelphys Virginiana.

Bandicoots more than the Dasyures: but they closely resemble the latter in the tuberculous structure of the molars. The two middle incisors of the upper jaw are more produced than the others, from which they are also separated by a short interspace. The canines are well developed; the upper being always stronger than the lower. The false molars are simply conical, but are more compressed than in the Carnivorous Marsupials. The posterior false molar is the largest in the upper jaw; the middle one is the largest in the lower jaw; the anterior one is the smallest in both jaws. The true molars are beset with sharp cusps which wear down into tubercles as the animal advances in age. The crowns of the upper molars present a triangular horizontal section: the base of the triangle is turned forward in the posterior molar; and obliquely inwards and outwards in the rest. In the lower jaw the true molars are narrower and of more equal size than in the upper jaw: there are five tubercles on each, four placed in two transverse pairs, the anterior being the highest, and a fifth forming the anterior and internal angle of the tooth: the anterior and external angle seems as if it were vertically cut off.

The smaller species of *Didelphys*, which are the most numerous, fulfil in South America the office of the insectivorous Shrews of the old Continent. Their external resemblance is so close that some have been described as species of *Sorex*, but no true representative of this placental genus has hitherto been discovered in South America. The larger Opossums resemble in their habits, as in their dentition, the Carnivorous *Dasyures*, and prey upon the smaller quadrupeds and birds, but they have a more omnivorous diet, feeding on reptiles and insects and even fruit. One large species, (*Did. cancrivora*) prowls about the sea-shore and lives, as its name implies, on crabs and other crustaceous animals. Another species, the Yapock, frequents the fresh waters, and preys almost exclusively on fish. It has all the habits of an Otter; and, in consequence of the modifications of its feet, forms the type of the sub-genus *Cheironectes*, Ill. Besides being web-footed the anterior extremities present an unusual development of the pisiform bone, which supports a fold of the skin, like a sixth digit; it has indeed been described, as such, by M. Temminck: this process has not, of course, any nail. The dentition of the Yapock resembles that of the ordinary *Didelphys*. All the Opossums have the inner digit of the hind foot converted by its position and development

into a thumb, but without a claw. The hinder hand is associated in almost all the species with a scaly prehensile tail.

In some of the smaller Opossums the sub-abdominal tegumentary folds are rudimental, or merely serve to conceal the nipples, and are not developed into a pouch: the young in these species adhere to the mother by entwining their little prehensile tails around her's; and they cling to the fur of the back, hence the term *dorsigera* applied to one of these Opossums.*

Tribe III. CARPOPHAGA.

Stomach simple; cœcum very long.

In this family the teeth, especially those at the anterior part of the mouth, present considerable deviations from the previously described formulæ; the chief of which is a predominating size of the two anterior incisors, both in the upper and lower jaws. Hitherto we have seen that the dentition in every marsupial genus has participated more or less in a carnivorous character; henceforth it will manifest a tendency to the Rodent type.

Genus PHALANGISTA.

The Phalangers, so called from the phalanges of the second and third digits of the hinder extremity being inclosed in a common sheath of integument, have the innermost digit modified to answer the purposes of a thumb; and this hinder hand being associated in many of the species with a prehensile tail, they evidently, of all Frugivora, come nearest to the arboreal species of the preceding section. In a system framed on locomotive characters they would rank in the same section: with the Opossums. We shall see, however, that they differ from those Entomophagous Marsupials in the condition of the intestinal tube. Let us examine to what extent the dental characters deviate from those of the Opossums.

Fig. 86.



Phalangista Cookii.

In the skull of a *Phalangista Cookii*, of which the dental formula is accurately given in fig. 86, there are both in the upper and lower jaws four true molars on each side, each

* Few facts would be more interesting in the present branch of zoology than the condition of the new-born young, and their degree and mode of uterine development in these Opossums. Since the marsupial bones serve, not as is usually described to support a pouch, but to aid in the function of the mammary glands and testes, they of course are present in the skeleton of these small pouchless Opossums as in the more typical Marsupials.

beset with four three-sided pyramidal sharp-pointed cusps; thus these essential and most constant teeth correspond in number with those of the Opossum: but in the upper jaw they differ in the absence of the internal cusp, which gives a triangular figure to the grinding surface of the molars in the Opossum; and the anterior single cusp is wanting in the true molars of the lower jaw. Anterior to the upper grinders in this Phalanger there are two premolars of similar shape and proportions to those in the Opossum; then a third premolar, too small to be of much functional importance, separated also, like the corresponding anterior premolar in the Opossum, by a short interval from those behind.

The canine tooth but slightly exceeds in size the above false molar, and consequently here occurs the first great difference between the Phalangers and Opossums; it is, however, but a difference in degree of development; and in the Ursine and other Phalangers, as well as in the *Petaurists*, the corresponding tooth presents more of the proportions and form of a true canine.

The incisors, which we have seen to be most variable in number in the Carnivorous section, are here three instead of five on each side of the upper jaw, but their size, especially that of the first, compensates for their fewness.

In the lower jaw there is the same number of molars and functional premolars as in the Opossums; the two very minute and functionless molars, which form part of the same continuous series, represent the small premolar and canine of the upper jaw; and anterior to these there is one very small and one very large and procumbent incisor on each side. Now if this comparison be just and natural, the difference in the number of teeth between the Phalanger and the Opossum will resolve itself into the former being minus certain incisors in the upper and lower jaws: in the latter, the great development of the middle incisors seems to produce an atrophy of all the rest.

The interspace between the functionally developed incisors and molars in both jaws always contains in the Phalangers teeth of small size and little functional importance, and variable not only in their proportions but their number.

The constant teeth in the Phalangers are the $\frac{4-4}{4-4}$ true molars, and the $\frac{3-3}{1-1}$ incisors.

Fig. 87.

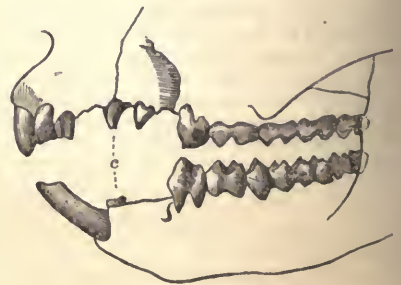

Phalangista Vulpina.

The canines (c. fig. 86 and 87,) are constant in regard to their presence, but variable in size; they are always very small in the lower jaw.

With respect to the functional premolars $\frac{1-1}{1-1}$, these are always in contact with the molars, and their crowns reach to the same grinding level; sometimes a second premolar is similarly developed in the upper jaw, as in the *Phal. Cookii*, and as in the great flying Phalangers, (*Petaurus Tuguanoides*, fig. 88) but it is commonly absent, or replaced by a very minute tooth, shaped like a canine; so that in the upper jaw, between the posterior or functional premolar and the incisors, we may find three teeth, of which the posterior is the largest, as in *Phal. Cookii*, or the smallest as in *Phal. cavifrons*; or there may be only two teeth as in *Phal. ursina* and *Phal. vulpina*, and the species, whatever that may be, which M. Fr. Cuvier has selected as the type of the dentition of the Genus.

In the lower jaw similar varieties occur in these small and unimportant teeth; e. g. there may be between the procumbent incisors and the posterior premolar, either three teeth as in *Phal. Cookii* and *Phal. cavifrons*, or two, as in *Phal. ursina*, *Phal. maculata*, *Phal. chrysorrhoeos*; or finally one, as in *Phal. vulpina* and *Phal. fuliginosa*. The most important modification is presented by the little *Phal. gliriformis* of Bell, which has only three true molars on each side of each jaw. As these modifications of the teeth are unaccompanied by any change of general structure or of habit, whilst those teeth which most influence the diet are constant, it is obvious that these differences of dentition are unimportant, and afford no just grounds for subgeneric distinctions.

The Phalangers, being provided with hinder hands and prehensile tails, are strictly arboreal animals, and have a close external resemblance to the Opossums, by which name they are generally known in Australia and the Islands of the Indian Archipelago, where alone they have hitherto been found. They differ from the Opossums chiefly in their dentition; and in accordance with this difference their diet is more decidedly of a vegetable kind.* The Australian Phalangers feed chiefly on the tender buds and the leaves of *Eucalypti*: but according to Temminck,† the Indian Phalangers are omnivorous, and combine insects with fruits and leaves. Mr. Ogilby‡ states that both "the Phalangers and Petaurists display so decided a preference for live birds, as to make it probable that these constitute a main portion of their food in a state of nature." I find, however, that the intestinal canal, and especially the cæcum, offers so great an additional development in length, as, with the corresponding predominance of the incisors, and atrophy of the canines, to indicate clearly a

natural and constant tendency in the Phalangers to a vegetable diet. Guided therefore by the totality of their organization, I am led to place them in a distinct section from that which contains the Opossums, but, in that section, they come the nearest to the true Opossums. The Phalangers of the Indian Isles have short ears and the greater part of the tail naked. To this group have been applied the names *Ceonyx*, *Cuscus*, and *Balantia*; the Australasian Phalangers have moderately long ears, and the greater part, or else the whole of the tail is covered with hair. All the species possess considerable freedom of lateral movement in the anterior digits, and in some small species, as *Phal. gliriformis*, Bell, they appear to be naturally divided into two groups, the two outer being opposed to the three inner fingers. To the hairy-tailed Phalangers exhibiting this character, Mr. Ogilby gives the subgeneric name *Pseudocheirus*, restricting the term *Phalangista* to the remaining species. With reference to the subgenera *Cuscus*, *Balantia*, *Pseudocheirus*, &c. I heartily concur in the opinion of the experienced and judicious Temminck,* that these numerous sections are perfectly useless, and a burthensome charge to the memory.

Genus PETAURUS.

There are many species of Marsupialia limited to Australia and closely resembling, or identical with, the true Phalangers in their dental characters and the structure of the feet. I allude to the Petaurists or Flying Opossums: these, however, present an external character so easily recognizable, and influencing so materially the locomotive faculties, as to claim for it more consideration than the modifications of the digits or spurious molars which we have just been considering in the *Phalangers*. A fold of the skin is extended on each side of the body between the fore and hind legs, which, when outstretched, forms a lateral wing or parachute; but which, when the legs are in the position for ordinary support or progression, is drawn close to the side of the animal by the elasticity of the subcutaneous cellular membrane, and there forms a mere tegumentary ridge. These delicate and beautiful Marsupials have been separated generically from the Phalangers under the name of *Petaurus*: they further differ from the Phalangers in wanting the prehensile character of the tail, which, in some species of *Petaurus*, has a general clothing of long and soft hairs, whilst in others the hairs are arranged in two lateral series.

Now in the Petaurists there is as little constancy in the exact formula of the dentition as among the Phalangers. The largest species of *Petaurus* (*Pet. Tuguanoides*) for example, is almost identical in this respect with the *Phalangista Cookii*, which M. Fr. Cuvier has therefore classed with the *Petauri*. Those teeth of *Pet. Tuguanoides* which are sufficiently developed, and so equal in length, as to exercise the function of grinders, or in other words, the functional series of molars, includes six teeth on each side of the upper jaw, and five

* In the stomach and intestines of specimens sent to me in spirits from Australia, I have never found any other alimentary substances but those of a vegetable nature.

† Monographies de Mammalogie, p. 3.

‡ Mag. Hist. Nat. 1837, p. 458.

* Loc. cit. p. 10.

teeth on each side of the lower jaw. The four posterior molars in each row are true, and bear four pyramidal cusps, excepting the last tooth in the upper jaw, which, as in *Ph. Cookii*, has only three cusps. In the upper jaw the space between the functional false molars and the incisors is occupied by two simple rudimentary teeth, the anterior representing the canine; but being relatively smaller than in *Ph. Cookii*, the crowns of the two anterior incisors are relatively larger. In the lower jaw the sloping alveolar surface between the functional molars and large procumbent incisors is occupied, according to M. Fr. Cuvier, by two rudimentary minute teeth, as represented in the figure (fig. 88). I have not found any trace of these

Fig. 88.

*Petaurus Taguanoides.*

in the two skulls of *Pet. Taguanoides* examined by me. In *Ph. Cookii* we have seen that there are three minute teeth in the corresponding space; but these differences would not be sufficient ground to separate generically the two species if they were unaccompanied by modifications of other parts of the body.

In *Petaurus sciureus* and *Petaurus flaviventer* the dentition more nearly resembles that of *Phalungista vulpina*. In the upper jaw the functional molar series consists of five teeth on each side; the four hinder ones being, as in *Pet. Taguanoides*, true tuberculate molars, but diminishing more rapidly in size as they are placed further back in the jaw; the hinder tooth has three tubercles, the rest four; the apices seem to be naturally blunter than in *Pet. Taguanoides*.

Between the functional præmolar and the incisors there are three teeth, of which the

Fig. 89.

*Petaurus flaviventer.*

representative of the canine is relatively much larger than in the *Pet. Taguanoides*; the first false molar is also larger and has two roots; the second, which is functional in *Pet. Taguanoides*, is here very small. The canine is more developed; the first incisor is also relatively larger and more produced. In the lower jaw the functional series of grinders consists of the four true tuberculate molars only, of which the last

is relatively smaller, and the first of a more triangular form than in *Pet. Taguanoides*. The space between the tuberculate molars and the procumbent incisor is occupied by four small teeth, of which the one immediately anterior to the molars is large, compressed, pointed, and has two roots; the remaining three are rudimentary and have a single fang; the anterior of these corresponds to the one regarded as canine in the upper jaw.

Among the species exhibiting this dental formula, viz.

$$\text{Incisors } \frac{3-3}{1-1}; \text{ canines } \frac{1-1}{1-1}; \text{ premo-}$$

$$\text{lars } \frac{3-3}{3-3}; \text{ molars } \frac{4-4}{4-4} = 40,$$

are *Pet. sciureus*, *Pet. flaviventer*, and *Pet. macrurus*.

The *Pigmy Petaurist* differs from the preceding and larger species, in having the hairs of the tail distichous, or arranged in two regular lateral series like the barbs of a feather, and in having the spurious molars large and sharp-pointed; and the true molars bristled each with four acute cusps. This tendency in the dentition to the insectivorous character, with the modification of the tail, induced M. Desmarest to separate the *Pigmy Petaurist* from the rest of the species, and constitute a new sub-genus for its reception under the name of *Acrobates*.*

To Mr. Waterhouse, however, is due the credit of having first pointed out that the *Pigmy Petaurist* had but three true molars on each side of each jaw instead of four. There seems, therefore, to be better reason for accepting this sub-generic section, although we evidently perceive a transition to this condition in the small size of the hinder or fourth molars in the *Sciurine Petaurist* and its congeners.

The description of the dentition of the *Pigmy Petaurist* in the *Régne Animal*, besides being defective in this remarkable particular, is not quite exact in other respects. In four adult specimens, two of which were males, and two females with young in the pouch, I find the following dental formula to be constant (fig. 90).

$$\text{Incisors } \frac{3-3}{3-3}; \text{ canines } \frac{1-1}{1-1}; \text{ premo-}$$

$$\text{lars } \frac{3-3}{3-3}; \text{ molars } \frac{3-3}{3-3} : 36.$$

Fig. 90.

*Petaurus pigmeus*, twice the natural size.

The three quadricuspidate grinders of the upper jaw are preceded by three large præmolars, each of which has two fangs, and a compressed triangular sharp-pointed crown, slightly but pro-

* *Ακρος*, *summus*, *βασις*, *gradior*, as frequenting the summits of trees.

gressively increasing in length as they are placed forward. An interspace occurs between these and the canine, which is long, slender, sharp-pointed, and recurved. The first incisor is longer than the two behind, but is much shorter than the canine. In the lower jaw the true molars are preceded by two functional false ones, similar in size and shape to the three above the anterior false molar, and the canine are represented by minute rudimentary simple teeth; the single incisor is long and procumbent as in the other Petaurists.

With these differences of dentition approaching more or less to one or other of the modifications of the dentition in the group of Phalangers, the Petaurists may nevertheless be readily discriminated from those Phalangers which they most resemble; for example, the *Petaurus Tuganoides* may be distinguished from the *Phalangista Cookii* by the greater relative length in the latter of the nasal and maxillary portion of the skull; while in most of the other species of *Petaurus*, the facial part of the skull is relatively shorter than in the *Pet. Tuganoides*.

Genus PHASCOLARCTUS.

The absence of anomalous or functionless premolars and of inferior canines appears to be constant in the only known species of this genus. The dental formula in three examples of this species (*Phasc. fuscus*, Desm.) is

$$\begin{array}{l} \text{Incisors } \frac{3-3}{1-1}; \text{ canines } \frac{1-1}{0-0}; \text{ premo-} \\ \text{lars } \frac{1-1}{1-1}; \text{ molars } \frac{4-4}{4-4} : = 30. \text{ (Fig. 95.)} \end{array}$$

The true molars are larger in proportion than in the Phalangers; each is beset with four three-sided pyramids, the cusps of which wear down in age, the outer series in the upper teeth being the first to give way; those of the lower jaw are narrower than those of the upper. The spurious molars are compressed and terminate in a cutting edge; in those of the upper jaw there is a small parallel ridge along the inner side of the base. The canines slightly exceed in size the posterior incisors; they terminate in an oblique cutting edge rather than a point; their fang is closed at the extremity: they are situated as in the Phalangers close to the intermaxillary suture. The lateral incisors of the upper jaw are small and obtuse; the two anterior or middle incisors are twice as long, broad, and thick as the posterior incisors; they are conical, slightly curved, sub-compressed, bevelled off obliquely to an anterior cutting edge, but differing essentially from the *dentes scalprarii* of the *Rodentia* in being closed at the extremity of the fang. The two incisors of the lower jaw resemble those of the upper, but are larger and more compressed; they are also formed by a temporary pulp, and its absorption is accompanied by a closure of the aperture of the pulp cavity, as in the upper incisors. The Koala, therefore, in regard to the number, kind, and conformation of its teeth, closely resembles the Phalangers, with which it also agrees in its long cæcum and the general conformation of its digestive organs. It has also the extremities

similarly organised for prehension; each is terminated by five digits; the hind feet are provided with a large thumb, and have the two contiguous digits enveloped in the same tegumentary fold; the anterior digits are divided into two groups, the thumb and index being opposed to the other three fingers. We have already noticed a structure approaching to this in some of the small Phalangers. The Koala, however, differs from the Phalangers and Petaurists in the extreme shortness of its tail, and in its more compact and heavy general form. It is only known to feed on the buds and leaves of the trees in which it habitually resides.

Tribe IV. POEPHAGA.

The present tribe includes the most strictly vegetable feeders; all the species have a complex sacculated stomach, and a long simple cæcum.

Genus HYPSPRYMNUS. Potoroos.

Guided by the modifications of the teeth we pass from the Koala to the Potoroos and Kangaroos—animals of widely different general form. The Potoroos, however, present

Fig. 91.

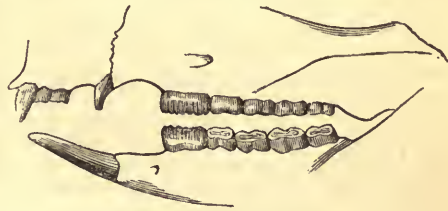

Hypsiprymnus murinus.

absolutely the same dentition as does the Koala, some slight modifications in the form of certain teeth excepted. The premolars in their longitudinal extent, compressed form, and cutting edge, would chiefly distinguish the dentition of the *Potoroo*; but the Koala evidently offers the transitional structure between the Phalangers and Potoroos in the condition of these teeth, of which one only is retained on each side of each jaw in the Potoroos as in the Koala.

The dental formula of *Hypsiprymnus*, the generic name of the Potoroos, is

$$\begin{array}{l} \text{Incisors } \frac{3-3}{1-1}; \text{ canines } \frac{1-1}{0-0}; \text{ premo-} \\ \text{lars } \frac{1-1}{1-1}; \text{ molars } \frac{4-4}{4-4} : = 30. \end{array}$$

The two anterior incisors are longer and more curved, the lateral incisors relatively smaller than in the Koala. The pulps of the anterior incisors are persistent. The canines are larger than in the Koala; they always project from the line of the intermaxillary suture; and, while the fang is lodged in the maxillary bone, the crown projects almost wholly from the intermaxillary. In the large *Hypsiprymnus ursinus* the canines are relatively smaller than in the other Potoroos, a structure which indicates the transition from the Potoroo to the Kangaroo genus. In the skeleton of this species in the

Leiden Museum, the canines have a longitudinal groove on the outer side.

The characteristic form of the trenchant premolar has just been alluded to: its maximum of development is attained in the arboreal Potoroos of New Guinea (*Hypsiprymnus ursinus* and *Hyps. dorcocephalus*), in the latter of which its antero-posterior extent nearly equals that of the three succeeding molar teeth. In all the Potoroos the trenchant spurious molar is sculptured, especially on the outer side, and in young teeth, by many small vertical grooves. The true molars each present four three-sided pyramidal cusps; but the internal angles of the two opposite cusps are continued into each other across the tooth, forming two angular or concave transverse ridges. In the old animal these cusps and ridges disappear, and the grinding surface is worn quite flat, as in *fig. 91*, which represents the dentition of the original Potoroo, described in White's Voyage.

Genus *MACROPUS*. Kangaroos.

In the genus *Macropus* (*fig. 92*) the normal condition of the permanent teeth may be expressed as follows:—

Incisors, $\frac{3-3}{1-1}$; canines, $\frac{0-0}{0-0}$; premolars, $\frac{1-1}{1-1}$; molars, $\frac{4-4}{4-4} = 28$.

The main difference, as compared with *Hypsiprymnus*, lies in the absence of the upper canines as functional teeth; the germs, however, of these teeth are always to be found in the young mammary fetuses of the *Macropus major*, and I have seen them present, but of very small size, and concealed by the gum, in the adults of some small species of kangaroos,

Fig. 92.

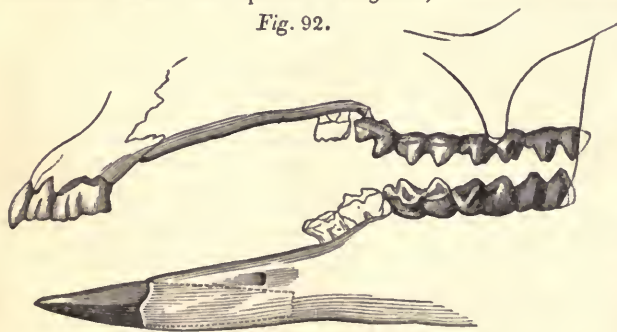

Macropus major, one-third nat. size.

as *Macropus rufiventer*, Ogilby, and *Macropus silopus*, Gould. This, however, is a rare exception; while the constant presence and conspicuous size of the canines will always serve to distinguish the Potoroo from the Kangaroo. But there are also other differences in the form and proportions of certain teeth. The upper incisors of the *Macropi* have their cutting margins in the same line, the anterior ones not being produced beyond that line, as in the *Hypsiprymni*: the third or external incisor is also broader in the kangaroos, and is grooved and complicated by one or two folds of the enamel, continued from the outer side of the tooth ob-

liquely forward and inward. In most species the anterior fold is represented by a simple groove: the relative size of the outer incisor, the extent and position of the posterior fold of enamel, and consequently the proportions of the part of the tooth in front or behind it, vary more or less in every species of *Macropus*: there are two folds of enamel near the anterior part of the tooth in *Macr. major*, and the posterior portion is of the greatest extent, and the entire crown of the tooth is relatively broadest in this species. The middle incisor is here also complicated by a posterior notch and an external groove. These modifications of the external incisors of the kangaroos were first noticed by Mr. Jourdan, and subgeneric distinctions, with names often sufficiently unmeaning, if not absurd,* have been subsequently based upon them; but such dental characters possess neither sufficient constancy nor physiological importance to justify such an application.

M. Fr. Cuvier has proposed a binary division of the genus *Macropus*, as here defined, founded on the absence of permanent spurious molars, and a supposed difference in the mode of succession of the true molars in certain species of *Kangaroo*, combined with modifications of the muzzle or upper lip, and of the tail.

The dental formula which I have assigned to the genus *Macropus* is restricted in its application by that naturalist to some small species of *Kangaroo*, grouped together under the term *Halmaturus*, originally applied by Illiger to the *Kangaroos* generally.† The rest of the *Kangaroos*, under the generic term *Macropus*, are characterised by the following dental formula:—Incisors, $\frac{6}{2}$; molars, $\frac{4-4}{4-4} = 24$.

The truth, however, is, that both the *Halmaturi* and *Macropi* of M. Fr. Cuvier have their teeth developed in precisely the same number and manner: they only differ in the length of time during which certain of these teeth are retained.‡ In the great *Kangaroo*, for example, the permanent premolar which succeeds the corresponding deciduous one in the vertical direction, is pushed out of place and shed by the time the last

* E. g. *Bettongia*, Gray, *Petrogale*, Gray, which signifies 'rock weasel.'

† *Prodromus Systematis Mammalium et Avium*, 8vo. 1811. The dental character which this excellent naturalist gives, accurately expresses the condition of the canine or laniary teeth, "Laniarii aut nulli, aut superiores 2 ambigui, minuti, in medio inter primores et molares collocati," p. 80; but there are never more than five molars in place on each side of each jaw in the Kangaroo.

‡ M. Fr. Cuvier was aware that a deciduous spurious molar existed in the great *Kangaroo* and other species of his subgenus *Macropus*, but he believed that it was peculiar to an early period of life, and then existed only in a rudimental state, or "en germe," and that instead of being displaced and

true molar has cut the gum: the succeeding true molar is soon afterwards extruded; and I have seen a skull of an old *Macropus major* in the Museum at Leyden, in which the grinders were reduced to two on each side of each jaw by this yielding of the anterior ones to the vis a tergo of their successors.

The general form of the body in the *Macropodidae* is that of an elongated cone, the broad and stout haunches forming the base, and the produced tapering muzzle the apex. The proportions of the body are, however, reduced by so elegant a gradation that they are justly considered as among the most picturesque of quadrupeds. The hinder extremities are always longer and stronger than the fore ones, but in various proportions; the difference being least in the arboreal Potoroos, and in that section of the genus represented by the *Hypsiprymnus myosurus* of Van Dieman's Land. The tail is very long in all the species, but is strongest in the great kangaroos, which make use of it as a kind of crutch or fifth extremity in their slower modes of progression. In the Potoroos the tail is more slender, and in these and some of the smaller species of kangaroo it is bent beneath the body when the animal reposes.

Tribe V. RHIZOPHAGA.

In this tribe, the stomach is simple in outward form, but complicated within by a large cardiac gland; and the cæcum, which is short and wide, with a vermiform appendage.

Genus PHASCOLOMYS, (fig. 93.)

In its heavy shapeless figure, large trunk, and short equally developed legs, the Wombat offers as great a contrast to the Kangaroos as

Fig. 93.

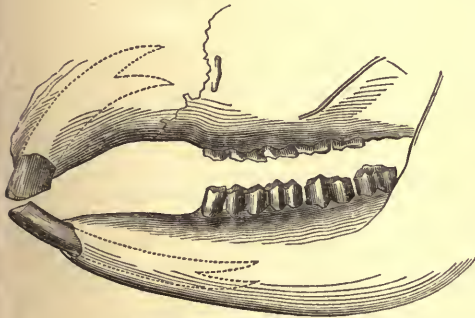

Phascolomys fusca, Geoff. one-half nat. size.

does the Koala, which it most nearly resembles in its general outward form and want of tail. But in the more important characters afforded by the teeth and intestinal canal, the Wombat

succeeded in the vertical direction by a permanent spurious molar, as in the *Halmatur*, it was displaced by the true molars, which are developed from behind forwards. I have however detected the crown of the permanent spurious molar in the jaws of the *Macropus major* in a concealed alveolus, and have observed it completely formed and in place in an individual which had nearly attained its full size.—See F. Cuvier's account of the *Halmaturus Thetis* in the "Histoire des Mammifères," folio.

differs more from the Koala than the latter does from either the Phalangers or Kangaroos.

The dental system presents the extreme degree of that degradation of the teeth, intermediate between the front incisors and true molars, which we have been tracing from the Opossum to the Kangaroos: not only have the functionless premolars and canines now totally disappeared, but also the posterior incisors of the upper jaw, which we have seen in the Potoroos to exhibit a feeble degree of development as compared with the anterior pair; these in fact are alone retained in the dentition of the present group, the representative of which possesses the fewest teeth of any Marsupial animal. The dental formula of the Wombat is thus reduced both in number and kind to that of the true Rodentia.*

Incisors, $\frac{2}{2}$; canines, $\frac{0}{0}$; premolars, $\frac{1-1}{1-1}$;
molars, $\frac{4-4}{4-4} = 24$.

The incisors moreover are true *dentes scalprarii*, with persistent pulps, but are inferior, especially in the lower jaw, in their relative length and curvature to those of the placental Glires; they present a subtriangular figure, and are traversed by a shallow groove on their mesial surfaces.

The spurious molars present no trace of that compressed structure which characterizes them in the Koala and Kangaroos, but have a wide oval transverse section; those of the upper jaw being transversed on the inner side with a slight longitudinal groove. The true molars are double the size of the premolars: the superior ones are also traversed by an internal longitudinal groove, but this is so deep and wide that it divides the whole tooth into two prismatic portions, with one of the angles directed inwards. The inferior molars are in like manner divided into two triangular portions, but the intervening groove is here external, and one of the facets of each prism is turned inwards. All the grinders are curved, and describe about a quarter of a circle: in the upper jaw the concavity of the curve is directed outwards; in the lower jaw, inwards. The false and true molars, like the incisors, have persistent pulps, and are consequently devoid of true fangs, in which respect the Wombat differs from all other Marsupials, and resembles the extinct *Toxodon*, the dentigerous *Bruta*, and herbivorous *Rodentia*.

I may add that the Wombat deviates from the other Marsupials in the number of its ribs; as these are very constant in the rest of the order, the difference in the Wombat, which has 15 pairs, instead of 13 or 12, is the more deserving

* In all the placental Rodents, which have more than three molars in each lateral series, the additional ones are placed at the anterior part of the row, and are subject to displacement by a permanent successor in the vertical direction, and consequently are essentially "premolars," or spurious molars; the Wombat strikingly manifests its marsupial character in having four true molars on each side of both jaws.

of notice. The *Koala*, like the *Phalangers* and *Kangaroos*, has 13 pairs of ribs; but this class of characters will form the subject of the following section.

OSTEOLOGY OF THE MARSUPIALIA.

Of the Skull.—The form of the skull varies much in different Marsupial animals, but it may be said, in general terms, to resemble an elongated cone, being terminated by a vertical plane surface behind, and in most of the species converging towards a point anteriorly: it is also generally more depressed or flattened than in the placental Mammalia. The skull is also remarkable in all the Marsupial genera for the small proportion which is devoted to the protection of the brain, and for the great expansion of the nasal cavity immediately anterior to the cranial cavity.

In the stronger carnivorous Marsupials the exterior of the cranium is characterized by bony ridges and muscular impressions, but in the smaller herbivorous and insectivorous species, as the *Petaurists*, *Potoroos*, and *Myrmecobius*, the cranium presents a smooth convex surface as in *Birds*, corresponding with the smooth unconvoluted surface of the simple brain contained within.

The breadth of the skull in relation to its length is greatest in the *Wombat*,* *Ursine Dasyure*† and *Petaurists*, in which it equals three-fourths of the length, and is least in the *Perameles lagotis*, in which it is less than one-half.

The occipital region, which is generally plane, and vertical in position, forms a right angle with the upper surface of the skull, from which it is separated by an occipital or lambdoidal crista. This crista is least developed in the *Myrmecobius*, *Petaurists*, and *Kangaroos*, and most so in the *Thylacine* and larger *Opossums*, in which, as also in the *Koala*, the crest curves slightly backwards, and thus changes the occipital plane into a concavity for the firm implantation of the strong muscles from the neck and back.

The upper surface of the skull presents great diversity of character, which relates to the different development of the temporal muscles, and the varieties of dentition in the different genera.

In the *Wombat* the coronal surface offers an almost flattened tract bounded by two slightly elevated temporal ridges, which are upwards of an inch apart posteriorly, and slightly diverge, as they extend forwards to the anterior part of the orbit.

The skull of the *Virginian Opossum* presents the greatest contrast to that condition, for the sides of the cranium meet above at an acute angle, and send upwards from the line of their union a remarkably elevated sagittal crest, which, in mature skulls, is proportionally more developed than in any of the placental *Carnivora*, not even excepting the strong-jawed *Hyæna*.

The *Thylacine* and *Dasyures*, especially the *Ursine Dasyure*, exhibit the sagittal crest in a somewhat less degree of development. It is again smaller, but yet well marked in the *Koala* and *Perameles*. The temporal ridges meet at

the lambdoidal suture in the larger *Phalangista* and in the *Hypsiprymni*, but the size of the muscles in these does not require the development of a bony crest.

In the *Kangaroo*, the temporal ridges, which are very slightly raised, are separated by an interspace of the third of an inch.

They are separated for a proportionally greater extent in the *Petaurists*, especially *Petaurus flaviventer*; and in the smooth and convex upper surface of the skull of *Petaurus sciureus*, *Pet. pigmæus*, *Myrmecobius*, the impressions of the feeble temporal muscles almost cease to be discernible.

The zygomatic arches are, however, complete in these as in all the other genera: they are usually, indeed, strongly developed; but their variations do not indicate the nature of the food so clearly, or correspond to the differences of animal and vegetable diet in the same degree as in the placental Mammalia. And this is not surprising when we recollect that no Marsupial animal is devoid of incisors in the upper jaw, like the ordinary Ruminants of the placental series: accordingly the more complete dental system with which the herbivorous *Kangaroos*, *Potoroos*, *Phalangers*, &c. are provided, and which appears to be in relation to the scantier pasturage and the dry and rigid character of the herbage or foliage on which they browse, requires a stronger apparatus of bone and muscle for the action of the jaws, and especially for the working of the terminal teeth. There are, however, well marked differences in this part of the Marsupial skull; and the weakest zygomatic arches are those of the Insectivorous *Perumeles* and *Acrobates*, in which structure we may discern a correspondence with the *Edentate Anteaters* of the placental series. Still the difference in the development of the zygomata is greatly in favour of the Marsupial Insectivora.

The *Hypsiprymni* come next in the order of development of the zygomatic arches; which again are proportionally much stronger in the true *Kangaroos*. The length of the zygomata in relation to the entire skull is greatest in the *Koala* and *Wombat*. In the former animal they are remarkable for their depth and straight and parallel course, as well as for their longitudinal extent. In the *Wombat* they have a considerable curve outwards, so as greatly to diminish the resemblance which otherwise exists in the form of the skull between this Marsupial and the *Herbivorous Rodentia* of the placental series, as, *e. g.* the *Viscaccia*.

In the carnivorous Marsupials the outward sweep of the zygomatic arch, which is greatest in the *Thylacine* and *Ursine Dasyure*, is also accompanied by a slight curve upwards, but this curvature is chiefly expressed by the concavity of the lower margin of the zygoma, and is by no means so well marked as in the placental *Carnivora*. It is remarkable that this upward curvature is greater in the slender zygomata of the *Perameles* than in the stronger zygomata of the *Dasyures* and *Opossums*. In the *Koala* and *Phalangers* there is also a slight tendency to the upward curvature; in the

* As 15 to 20. † As 10 to 14.

Wombat the outwardly expanded arch is perfectly horizontal. In the Kangaroo the lower margin of the zygoma describes a slightly undulating curve, the middle part of which is convex downwards.

In many of the Marsupials, as the Kangaroo, the Koala, some of the Phalangers, Petaurists,^d and Opossums, the superior margin of the zygoma begins immediately to rise above the posterior origin of the arch. In the Wombat an external ridge of bone commences at the middle of the lower margin of the zygoma, and gradually extends outwards as it advances forwards, and being joined by the upper margin of the zygoma, forms the lower boundary of the orbit, and ultimately curves downwards in front of the ant-orbital foramen, below which it bifurcates and is lost. This ridge results, as it were, from the flattening of the anterior part of the zygoma, which thus forms a smooth and slightly concave horizontal platform for the eye to rest upon.

The same structure obtains, but in a slighter degree, in the Koala.

In the Kangaroo the anterior and inferior part of the zygoma is extended downwards in the form of a conical process, which reaches below the level of the grinding-teeth. A much shorter and more obtuse process is observable in the corresponding situation in the Phalangers and Opossums.

The relative length of the facial part of the skull anterior to the zygomatic arches varies remarkably in the different Marsupial genera. In the Wombat it is as six to nineteen; in the Koala as five to fourteen; in the *Petaurus sciuroides* and *Petaurus Bennettii* it forms about one-fourth of the entire skull; in the Phalangers about one-third; in the carnivorous Dasyures and Opossums more than one-third; in the Thylacine nearly one-half; in *Perameles*, *Macropus*, and *Hypsiprymnus murinus*, Ill. the length of the skull anterior to the orbit is equal to the remaining posterior part; but in a species of *Hypsiprymnus* from Van Dieman's Land (*Hypsiprymnus myosurus*, Ogilb.), the facial part of the skull anterior to the orbit exceeds that of the remainder, and the arboreal *Hypsiprymni* from New Guinea present a still greater length of muzzle. In most Marsupials the skull gradually converges towards the anterior extremity; the convergence is more sudden in the *Petaurists*, especially *Pet. Bennettii*; but in the *Perameles lagotis* the skull is remarkable for the sudden narrowing of the face anterior to the orbits, and the prolongation of the attenuated snout, preserving the same diameter for upwards of an inch before it finally tapers to the extremity of the nose. In the Koala the corresponding part of the skull is as remarkable for its shortness, as it is in the *Per. lagotis* for its length, but it is bounded laterally by parallel lines through its whole extent. Before concluding this account of the general form of the skull, I may observe that in nearly all the Marsupials two long processes project downwards from the inferior angles of the occipital region; they correspond in func-

tion with, and have been described as the mastoids, but they are developed from the ex-occipital bones. These processes are longest in the Kangaroos and Koala; in the Wombat they co-exist with the true mastoid processes, which are of larger size. In the Opossums and Dasyures the exoccipital processes are short and obtuse; in *Acrobates* they cease to exist, but they are present in the larger *Petaurists*.

Of the composition of the cranium.—The occipital bone is developed, as in the placental Mammalia, from four centres or elements,—the basilar below, the supra-occipital above, and the ex-occipitals at the sides; but these elements remain longer separate, and in some genera do not become at any period of life united by continuous ossification.

In the skull of an aged Virginian Opossum, I found the supra-occipital still distinct from the ex-occipitals, and these not joined together, though anchylosed to the basilar element. I say not joined together, because in this Marsupial animal they meet above the foramen occipitale and complete its boundaries, as the corresponding superior vertebral laminae complete the medullary canal in the region of the spine. I find the same structure and condition of the occipital bone of an adult *Dasyurus Ursinus*, and it is exhibited in the plate of the cranium of this species given by M. Temminck.*

In the skull of the mature Wombat, of which a reduced representation is given at *fig. 94*, the ex-occipitals were still unanchylosed; the left is figured separate at *a*.

In the skull of a *Perameles nasuta* the ex-occipitals are separated by an interspace, so that a fissure is continued from the upper part of the foramen magnum to the supra-occipital element. The same structure may be observed in the great Kangaroo, and it is very remarkable in the young skulls of this species; I found this superior notch wide and well marked in *Macropus Bennettii*. In the Wombat the corresponding fissure is very wide, and the lower margin of the supra-occipital is notched, so that the shape of the foramen magnum somewhat resembles that of the trefoil leaf. In the Koala, the Phalanger, Petaurists, *Hypsiprymni*, and *Dasyurus Maugei*, the elements of the occipital bone present the usual state of bony confluence.

The temporal bone generally presents a permanent separation of the squamous, petrous, and tympanic elements. I have observed this reptilian-like condition of the bone in the mature skulls of an Ursine Dasyure, a Virginian Opossum, a *Perameles*, in different species of Potoroo and Kangaroo, in the Wombat, and in the Koala. The petrous and mastoid elements are commonly anchylosed together. So loose indeed is the connexion of the tympanic bone, that without due care it is very liable to be lost in preparing the skulls of the Marsupials. In the Kangaroo and Wombat (*fig. 94, b*) it

* Monographies de Mammalogie, pl. viii.

Fig. 94.

*Phascologomys.*

forms a complete bony tube, about half an inch in length, with an irregular exterior; it is wedged in between the mastoid and articular processes of the temporal bone. In the Potoroo the bony circle is incomplete at the upper part; in the *Perameles* and *Dasyures* the tympanic bone forms a semicircle, the posterior part being deficient, and the tympanic membrane being there attached to a descending process of the squamous element of the temporal bone. Here we have a near approach to the form of tympanic bone in Birds, but we have a still closer resemblance to its condition both in Birds and Reptiles, in its want of union with and relations to the petrous element of the temporal bone. In the Rodent quadrupeds the tympanic, petrous, and mastoid elements of the temporal bone are always ankylosed together; this condition is well shown in the skull of the Porcupine and Beaver, in which the mastoid element sends down a thin obtuse process behind the petro-tympanic portion. It is to the expansion of the petro-tympanic, and not of the mastoid portion of the temporal bone, that the enlargement of the tympanic cavity is due in the Rodentia, and this expansion forms in that

order, as is well known, a large *bullæ ossea*, which is situated anterior and internal to the mastoid process. In many of the Marsupials, as the *Dasyures*, *Petaurists*, *Perameles*, *Potoroos*, and *Koala*, there is also a large *bullæ ossea* for the purpose of increasing the extent of the auditory cavity; but, with one single exception, the *Wombat*, this *bullæ* is not formed by the tympanic or any other element of the temporal bone, but by the expansion of the base of the great ala of the sphenoid bone. In *Acrobates* and *Perameles lagotis*, in addition to the preceding *bullæ* there is also an external dilatation of the petrous element of the temporal bone, which thus forms a second and smaller *bullæ* on each side, behind the large *bullæ ossea* formed by the sphenoid. In other Marsupials the petrous bone is of small size, generally limited to the office of protecting the parts of the internal ear, and sometimes, as in the *Koala*, is barely visible at the exterior of the base of the skull. The petrous and mastoid elements are usually ankylosed together in the Marsupials, and the mastoid portion appears in the occipital region of the skull of the *Koala*, between the ex-occipital bones and squamous portion of the temporal. The petrous element of the temporal bone appears externally in the corresponding part of the skull of a young *Emeu*. In the *Kangaroos* and *Wombat* the petro-mastoid bone presents a larger size, and is visible in two situations on the outside of the skull, viz. at the usual place at the basis, where the petrous portion is wedged in between the basilar bone, ex-occipital and sphenoid, and again at the side of the cranium, where the mastoid portion appears between the squamous, ex-occipital, and supra-occipital bones. In the *Wombat* it sends outwards the strong compressed process which terminates the lateral boundaries of the occipital plane of the cranium; but this process is entirely due to the ex-occipitals in the *Koala* and other Marsupials.

The auditory chamber of the ear is augmented in the *Phalangiers*, the *Koala*, the *Kangaroos*, and *Potoroo*, by a continuation of air-cells into the base or origin of the zygomatic process; but the extent of the bony air-chambers communicating with the tympanum is proportionally greatest in the *Flying Opossums*, where, besides the sphenoid *bullæ*, the mastoid element and the whole of the zygomatic process of the temporal bone are expanded to form air-cells with very thin and smooth walls, thus presenting an interesting analogy in the structure of the cranium to the class of birds.

The direction of the bony canal of the organ of hearing corresponds, as in the placental Mammalia, with the habits of the species. The meatus is directed outwards and a little forwards in the carnivorous *Dasyures*; outwards and a little backwards in the *Perameles* and *Phalangiers*; outwards, backwards, and upright in the *Kangaroos*, and directly outwards in the *Petaurists* and *Wombat*; but the differences of direction are but slightly marked.

The squamous element of the temporal bone

generally reaches half-way from the root of the zygoma to the sagittal ridge or suture; it is most developed in the Wombat, in which its superior margin describes a remarkably straight line. The zygomatic process of the temporal bone is generally compressed and much extended in the vertical direction in the Opossum, Dasyure, Phalanger, Koala, and Kangaroo. In the Wombat it curves outwards from the side of the head in the form of a compressed and almost horizontal plate; it is then suddenly twisted into the vertical position, to be received into the notch of the malar portion of the arch.

The cavity corresponding to the sphenoidal bulla ossea in other Marsupials is in this species excavated in the lower part of the squamous element of the temporal bone at the inner side of the articular surface for the lower jaw. This articular surface, situated at the base of the zygomatic process, presents in the marsupial, as in the placental Mammalia, various forms, each manifesting a physiological relation to the structure of the teeth and adapted to the required movement of the jaws in the various genera. In the herbivorous Kangaroo the glenoid cavity forms a broad and slightly convex surface, as in the Ruminants, affording freedom of rotation to the lower jaw in every direction. In the Phalangers and Potoroos the articular surface is quite plane. In the *Perameles* it is slightly convex from side to side, and concave from behind forwards. In the Wombat it is formed by a narrow convex ridge considerably extended, and slightly concave, in the transverse direction. This ridge is not bounded by any descending process posteriorly, so that the jaw is left free for the movements of protraction and retraction. But this structure is widely different from that which facilitates similar movements in the Rodentia. In these there is a longitudinal groove on each side, in which the condyle of the lower jaw plays backwards and forwards, but is impeded in its lateral movements; these, on the contrary, are freely allowed to the Wombat, and the oblique disposition of the lines of enamel upon the molar teeth correspond with the various movements of which the lower jaw of the Wombat is thus susceptible. In the Koala the glenoid cavity is a transversely oblong depression with a slight convex rising at the bottom, indicating rotatory movements of the jaw. In the carnivorous Dasyures it forms a concavity still more elongated transversely, less deep than in the placental Carnivora, but adapted, as in them, to a ginglymoid motion of the lower jaw. In all the genera, save in the Wombat, retraction of the lower jaw is opposed by a descending process of the temporal bone immediately anterior to the meatus auditorius and tympanic bone.

The glenoid cavity presents a characteristic structure in most of the Marsupialia in not being exclusively formed by the temporal bone. With the exception of the *Petaurists*, the malar bone forms the outer part of the articular surface for the lower jaw, and in the *Thylacinus*, *Dasyurus Maugei*, *Dasyurus ursinus*, *Perameles*,

meles, *Hypsiprymnus*, and *Macropus* the sphenoid ala forms the inner boundary of the same surface; but this ala does not extend so far outwards and backwards in the Wombat or Koala.

The sphenoid bone has the same general form and relative position as in the ordinary Mammalia, but in many Marsupials it presents a similarity to that in the Ovipara in the persistence of the pterygoid processes as separate bones, as shown in the Wombat (*fig. 94, c*). It is only in the Koala that I have observed a complete obliteration of the suture joining the basilar element of the sphenoid with that of the occipital bone. In the *Thylacine* a narrow straight bridge of bone is continued from the auditory sphenoidal bulla forwards to the base of the pterygoid process, resembling the condition of the pterygoids in Birds.

The chief peculiarity in the sphenoid bone is the dilatation of the root of the great ala already alluded to. This dilatation communicates and is filled with air from the tympanum. It forms the hemispherical bulla ossea on each side of the basis cranii in the Dasyures and Phascogales, and the large semi-ovate bullæ in the *Myrmecobius*, *Cook's Phalanger*, &c.; but in the Koala the bullæ (*b, fig. 95*), are still

Fig. 95.

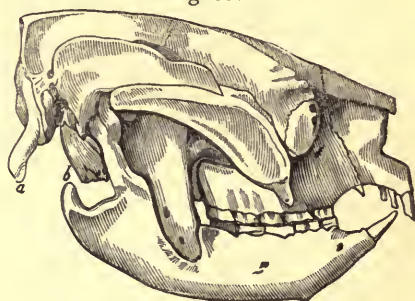

Phascolarctus.

more developed, and are produced downwards to an extent equal with the ex-occipital processes (*a, fig. 95*); they are somewhat compressed laterally, and instead of the smooth and polished surface which characterizes them in the preceding genera, terminate here in a rough ridge. The dilated air-chambers or bullæ of the sphenoid are very small in the *Thylacine*; in the Phalangers and Potoroos they are relatively smaller than in the Dasyures, and they are incomplete posteriorly in the Kangaroos and Wombat. In the Brush-Kangaroo the above process from the sphenoid joins the base of the large descending process of the ex-occipital. The pterygoid processes are relatively largest in the Kangaroo, Wombat, and Koala, and present in each of these species distinct hamular processes. In the Potoroo, Kangaroo, and Wombat the sphenoid ala combines with the pterygoid process to form a large and deep depression opening externally. In the Kangaroo, Dasyures, Koala, and Wombat the great alæ of the sphenoid articulate with the parietal bones, but by a very small portion in the two latter species: in the *Perameles*,

meles and Potoroos the sphenoid alæ do not reach the parietals.

There is little to notice in the *parietal bones* except the obliteration of the sagittal suture in those species in which a bony crista is developed in the corresponding place. They present a singularly flattened form in the Wombat, in an aged skull of which, and in a similar one in the Kangaroo, I observe a like obliteration of the sagittal suture. In the Kangaroo, Potoroo, Petaurus, Phalanger, and *Myrmecobius* there is a triangular inter-parietal bone. The corresponding bone I find in three pieces in the skull of a Wombat.

The *frontal bones* are chiefly remarkable for their anterior expansion and the great share which they take in the formation of the nasal cavity. In the Thylacine the part of the cranium occupied by the frontal sinuses exceeds in breadth the cerebral cavity, from which it is divided by a constriction. The coronal suture presents in most of the Marsupials an irregular angular course, forming a notch in the frontals on each side which receives a corresponding triangular process of each parietal bone: this form of the suture is least pronounced in the *Acrobates* and *Myrmecobius*. A process corresponding to the posterior frontal augments the bony boundary of the orbit in the Thylacine, the Ursine Dasyure, and in a slighter degree in the Virginian Opossum; it is relatively most developed in the skull of the *Myrmecobius fasciatus*, where the orbit is large; but the bony boundary of the orbit is not complete in any of the Marsupials. In the *Myrmecobius* there is a deep notch at the middle of the supra-orbital ridge. A corresponding but shallower notch is present in the skull of *Petaurus sciureus*. I have found the frontal suture obliterated in old specimens of the Thylacine, the Virginian Opossum, Cook's Phalanger, the taguanoid, and yellow-bellied Petaurists; but the frontal suture exists in *Petaurus sciureus*, *Acrobates*, and other Marsupials. The inter-orbital space is concave in the Phalangers and in the *Petaurus Taguanoides*, but is quite flat in the other Petaurists.

The *lachrymal bones* vary in their relative size in different Marsupialia. In the Koala they extend upon the face about a line beyond the anterior boundary of the orbit, and at this part they present a groove with one large and two or three small perforations. In the Wombat their extent upon the face is slightly increased; it is proportionally greater in the Kangaroos, Potoroos, Phalangers, Petaurists, and Dasyures, in which this part of the lachrymal bone presents two perforations close to the orbit. In the Thylacine, besides the two external holes there is a large perforation within the orbital margin. This carnivorous Marsupial, as compared with the Wolf, presents a greater extent of the facial portion of the lachrymal bone, and thus indicates its inferior type. In the *Myrmecobius* the lachrymal bone exhibits its greatest relative development.

The *malar bones* are very strong and of great extent in almost all the Marsupialia. They

are least developed in *Acrobates*, *Myrmecobius*, and *Perameles lagotis*. In the latter the malar bone presents a singular form, being bifurcate at both extremities: the *processus zygomaticus maxilla superioris* is wedged into the cleft of the anterior fork; the corresponding process of the temporal bone fills up the posterior notch; the lower division of this bifurcation is the longest, and in all the Marsupialia enters into the composition of the articular surface for the lower jaw, except in the Petaurists, where it just falls short of this part. The anterior bifurcation of the malar bone is not present in the Marsupials generally; the external malo-maxillary suture forms an oblique and almost straight line in the Wombat, Phalanger, Opossum, Dasyures, and Kangaroo. Owing to the inferior development of the zygomatic process of the superior maxillary in the Wombat, the malar bone is not suspended in the zygomatic arch in this Marsupial as in the placental Rodentia. It is also of relatively much larger size and of a prismatic form, arising from the development of the oblique external ridge above described. In the Kangaroos, Potoroos, Great Petaurus, and Phalangers it is traversed externally by a ridge showing the extent of attachment of the masseter; in the Koala the ridge extends along the malar bone near the upper margin, and the surface below presents a well-marked excavation.

The *nasal bones* vary in their form and relative size in the different genera; they are longest and narrowest in the *Perameles*, shortest and broadest in the Koala. Their most characteristic structure is the expansion of their upper and posterior extremity, which is well marked in the Wombat, *Myrmecobius*, Petaurists, Phalangers, Opossums and Dasyures.

In the Potoroos the anterior extremities of the nasal bones converge to a point which projects beyond the inter-maxillaries. In some Petaurists and *Perameles* the corresponding points reach as far as the inter-maxillaries, and in a skull of the *Perameles lagotis* I have found the bony case of the nasal passages to be further increased by the presence of two small *rostral bones*, resulting, as in the Hog, from ossification of the nasal cartilage.

The *inter-maxillary bones* always contain teeth, and the ratio of the development of these bones corresponds with the bulk of the dental apparatus which they support. They are consequently largest in the Wombat, where they extend far upon the side of the face and are articulated to a considerable proportion of the nasal bones, but do not, as in the placental Rodentia, reach the frontal or divide the maxillary bone from the nasal. They present a somewhat lower degree of development in the Koala, but both in this species and in the Wombat they bulge outwards and thus remarkably increase the transverse diameter of the osseous cavity of the nose. Neither in *Hypsiprymnus* nor *Macropus* do I find the incisive palatal foramina entirely in the intermaxillary bones, as is described by the author of the text in Pander and D'Alton's

Skelete der Beutelthiere; a small proportion of their bony circumference is due to the anterior extremity of the palatal process of the maxillary: the same structure obtains in the Wombat, Koala, and Opossums. In the Dasyures and Phalangers a greater proportion of the posterior boundary of the incisive or anterior palatal foramina is formed by the maxillaries; in the Petaurists they are entirely surrounded by the maxillary bones, while in the Perameles they are, on the contrary, entirely included in the intermaxillaries. They always present the form of two longitudinal fissures: the Myrmecobius agrees with the other Marsupials in this structure.

The *superior maxillary bone* in the Wombat sends upwards a long, narrow, irregular nasal process, which joins the frontal and nasal bones, separating them from the intermaxillaries; the part of the maxillary bone which projects into the temporal fossa behind the orbit presents two or three smooth tuberosities, formed by the thin plate of bone covering the pulps of the large curved posterior grinders. The corresponding part in the *Perameles lagotis* is perforated by numerous minute apertures like a cribriform plate, and this structure is presented in a slighter degree in the Potoroos and Ursine Dasyure. The antorbital foramen does not present any marked variety of size, which is generally moderate. It is much closer to the orbit in the carnivorous Marsupialia than in the corresponding placental quadrupeds. It is relatively largest in the Ursine Dasyure. It presents the form of a vertical oblique fissure in the Wombat. I have observed it double in the Kangaroo. The chief differences in the maxillary bones, independently of the teeth and their alveoli, are presented by the palatal processes, the modifications of which we shall consider in conjunction with those presented by the palatal processes of the palatal bones. The perforations and vacuities of the bony palate deserve, indeed, particular attention, as they are often specific and of consequence in the determination both of recent and fossil species.

In *Phalangista Cookii*, in *Petaurus flaviventer*, and *Petaurus sciureus*, in *Macropus major*, and some other great Kangaroos the bony palate is of great extent and presents a smooth surface, concave in every direction towards the mouth; it is pierced by the two posterior palatine foramina at the anterior external angles of the palatine bones, either within or close to the transverse palato-maxillary sutures. Behind these foramina, in the Kangaroo, there are a few small irregular perforations. The bony palate is similarly entire in the *Hypsiprymnus ursinus*. In *Macropus Bennettii* there are four orifices at the posterior part of the bony palate. The two anterior ones are situated upon the palato-maxillary suture, and are of an ovate form with the small end forwards. The two posterior foramina are of a less regular form and smaller size. In the Brush Kangaroo (*Macropus Brunii*, Cuv.) the posterior palatal foramina present the form of two large fissures placed obliquely and converging posteriorly.

They encroach upon the posterior borders of the maxillary plate. Anterior to these vacancies there are two smaller foramina, and posterior to them are one or two similar foramina.

In the Australian Potoroos, Wombat, and Koala, the posterior palatal openings are large and oval, and situated entirely in the palatal bones. In *Hyps. setosus* they extend as far forwards as the interspace between the first and second true molars; in *Hyps. murinus* they reach to that between the second and third true molars. Posterior and external to these large vacuities there are two small perforations. In the Phalangers, with the exception of *Ph. Cookii*, the palatal openings are proportionally larger; they extend into the palatal process of the maxillaries, and the thin bridge of bone which divides the openings in the Potoroo, &c., is wanting; the two perforations at the posterior external angles of the palatine bones are also present. In the Virginian Opossum the bony palate presents eight distinct perforations, besides the incisive foramina; the palatal processes of the palatine bone extend as far forwards in the median line as the third molars: a long and narrow fissure extends for an equal distance (three lines) into the palatal processes both of the palatines and maxillaries: behind these fissures and nearer the median line are two smaller oblong fissures; external and a little posterior to these are two similar fissures, situated in the palato-maxillary suture; lastly, there are two round perforations close to the posterior margin of the bony palate.

In the Ursine Dasyure a large transversely oblong aperture is situated at the posterior part of the palatal processes of the maxillary bones, and encroaches a little upon the palatines; this aperture is partly,* perhaps in young skulls wholly, bisected by a narrow longitudinal osseous bridge. In Mauge's Dasyure there are two large ovate apertures crossing the palato-maxillary sutures separated from each other by a broad plate of bone; posterior to these are two apertures of similar size and form, which, being situated nearer the mesial line, are divided by a narrower osseous bridge; each posterior external angle of the bony palate is also perforated by an oval aperture. In the Viverrine Dasyure the two vacancies which cross the palato-maxillary suture are in the form of longitudinal fissures, corresponding to the fourth and fifth grinders; the posterior margin of the bony palate has four small apertures on the same transverse line.

Now there is no carnivorous quadruped in the placental series which has a bony palate characterized by perforations and vacuities of this kind. In the Dog, the Cat, and the Weasel-tribe the bony palate is only perforated by two small oblique canals which open in or near the palato-maxillary suture. The very great interest which is attached to the fossil remains of the Stonesfield Marsupials, the only mammi-

* The large aperture in the skull of the *Dasyurus ursinus* figured by Temminck is the result of accidental injury to the bony palate. Monographies de Mammalogie, pl. viii.

ferous remains hitherto discovered in the secondary formations, will justify the minuteness, perhaps tediousness, with which I have dwelt on characters that, inclusive of the teeth, serve to distinguish the cranium of the Marsupial from that of any Placental quadruped. The structure of the bony palate in the Marsupials is interesting in other respects. Since the defective condition of this part of the cranium is one of the characteristics of the skull of the Bird, it might be expected that some approximation would be made to that structure in the animals which form the transition between the Placental and Oviparous Classes. We have already noticed the large vacuities which occur in the bony palate of nearly all the Marsupials; but this imperfectly ossified condition is most remarkable in the great *Perameles lagotis* and *Acrobates*. In the former (fig. 96) the bony

Fig. 96.

*Perameles lagotis.*

roof of the mouth is perforated by a wide oval space extending from the second pre-molars to the penultimate molars, exposing to view the vomer and the convolutions of the inferior spongy bones in the nasal cavity. Behind this space there are six small perforations, two in a transverse line midway between the great vacancy and the posterior margin of the bony palate, and four in a transverse line close to that margin. In *Acrobates* a still larger proportion of the posterior part of the palate is formed by membrane.

Cavity of the cranium.—The parietes of the cranial cavity are remarkable for their thickness in some of the Marsupial genera. In the Wombat the two tables of the parietal bones are separated posteriorly for the extent of more than half an inch, the interspace being filled with a coarse cellular diploë; the frontal bones are about two and a half lines thick. In the Ursine *Dasyures* the cranial bones have a similar texture and relative thickness. In the Koala the texture of the cranial bones is denser, and their thickness varies from two lines to half a line. In the Kangaroo the thickness varies considerably in different parts of the skull, but the parietes are generally so thin as to be diaphanous, which is the case with the smaller Marsupials, as the Potoroos and Petaurists. The union of the body of the second with that of the third cranial vertebra takes place in the marsupial as in the placental Mammalia at the sella turcica, which is overarched by the backward extension of the lesser alæ of the sphenoid. The optic foramina and the fissuræ lacerae anteriores are all blended together, so that a wide opening leads outwards from each side of the sella. Immediately posterior and external to this opening are the foramina rotunda, from each of which in the Kangaroo a remarkable groove leads to the fossa Gasseriana at the commencement of the foramen ovale; the same groove is indicated in a slight degree in the *Dasyures* and *Phalangers*, but is almost obsolete in the Wombat and Koala. The carotid canals pierce the body of the sphenoid, as in Birds, and terminate in the skull very close together behind the sella turcica, which is not bounded by a posterior clinoid process. The sphenoidal bulla, which forms the chief part of the tympanic cavity in the *Perameles lagotis*, forms a large convex protuberance on each side of the floor of the cranial cavity in that species. The petrous bone in the Kangaroo, Koala, and *Phalangers* is impressed above the meatus auditorius by a deep, smooth, round pit, which lodges the lateral appendage of the cerebellum. The corresponding pit is shallower in the *Dasyuri*, and is almost obsolete in the Wombat. The middle and posterior fissuræ lacerae have the usual relative position, but the latter are small. The condyles are each perforated anteriorly by two foramina in most of the Marsupials, the *Thylacinus* forming the exception. Of the composition and form of the foramen magnum we have already spoken: it is of great size in relation to the capacity of the cranium; the aspect of its plane is backward and slightly downwards.

In the Kangaroo and *Phalanger* a thin ridge of bone extends for the distance of one or two lines into the periphery of the tentorial process of the dura mater, and two sharp spines are sent down into it from the upper part of the cranium in the *Phalangista vulpina*. The tentorium is supported by a thick ridge of bone in the *Thylacine*; but it is not completely ossified in any of the Marsupials: in some species, indeed, as the *Dasyures*, the Koala, and the Wombat, the bony crista above described does not exist. There is no ossification

of the falciform ligament as in the Ornithorynchus.

The anterior depression or olfactory division of the cavity of the cranium, as it may be termed from its large size, is separated in a well-marked manner from the proper cerebral division of the cavity. It is relatively smallest in the Koala. In all Marsupials it is bounded anteriorly by the cribriform plate of the æthmoid bone, which is converted into an osseous reticulation by the number and size of the olfactory apertures. The cavity of the nose, from its great size and the complication of the turbinated bones, forms an important part of the skull. It is divided by a complete bony septum to within one-fourth of the anterior aperture; the anterior margin of the septum is slightly concave in the Koala; describes a slight convex line in the Wombat, Kangaroo, and Phalanger, and a sigmoid flexure in the Dasyure. A longitudinal ridge projects downwards from the inside of each of the nasal bones, and is continued posteriorly into the superior turbinated bone; this bone extends into the dilated space anterior to the cranial cavity, which corresponds with the frontal sinuses. The convolutions of the middle spongy bone are extended chiefly in the axis of the skull; the processes of the anterior convoluted bone are arranged obliquely from below upwards and forwards. They are extremely delicate and numerous in the Dasyures and Phalangers; they consist of thin laminæ of bone beautifully arranged on the convex surface of the os turbinatum, and placed vertically to that surface in the Potoroo; but the bone becomes very simple in the Kangaroo, Koala, and Wombat. The nasal cavity communicates freely with large maxillary sinuses, and finally terminates by wide apertures behind the bony palate. In the skull the nasal cavity communicates with the mouth, as before mentioned, by means of the various large vacuities in the palatal processes.

Maxilla inferior.—The lower jaw of the Marsupials is a part of their osseous structure which claims more than ordinary attention in consequence of the discussions to which the fossil specimens of this bone discovered in the oolitic strata of Stonesfield have given rise. These specimens, which are well known to the English reader by the figures of them published in the Bridgewater Treatise of Dr. Buckland, and in the Elements of Geology of Mr. Lyell, were regarded by Cuvier as appertaining to the Marsupial series of Mammalia, and to be nearly allied to the genus *Didelphis*.

This opinion of the great founder of Oryctological Science has been called in question by other naturalists, and has been more especially opposed by Professor De Blainville, who conceives it to be more probable that they belong to a genus of Saurian Reptiles than to the *Didelphis* or any genus of insectivorous Mammals. I have examined the two specimens in the possession of Dr. Buckland, the specimen formerly in the collection of Mr. Broderip and now in the British Museum, and that which is preserved in the Museum at York.

The composition of the lower jaw, each ramus of which consists of one piece of bone, the convex condyle, broad and high coronoid process, and the structure and mode of implantation of the molar teeth, sufficiently attest the mammiferous character of these remains: the size, elevation, and form of the coronoid process of the lower jaw, the process continued from the angle of the ramus, with the tubercular crowns of the molar teeth, indicate the carnivorous and insectivorous character of the species in question. In the presence of canines and the number of the incisors and molars, one of these small Insectivora (*Phascolotherium*) approaches most nearly to the smaller species of the modern genus *Didelphis*; while in the structure of the molar teeth, and in the form of the coronoid process, it very closely resembles the *Thylacinus*. The number of the molars in the other genus (*Thylacotherium*) exceeds that of any known ferine Insectivore, placental or marsupial. We have seen, however, that the marsupial *Myrmecobius* possesses nine molars on each side of both upper and lower jaws. Besides the osteological characters above alluded to, there is a peculiarity in the lower jaw of the Marsupial animals, which was first indicated by Cuvier in the genus *Didelphis*, but which is not restricted to that genus. In the carnivorous Marsupials, as the Thylacine, the lower maxillary bone resembles in general form that of the corresponding species in the placental series, as the Dog: a similar transverse condyle is placed low down near the angle of the jaw, on a level with the series of molar teeth; a broad and strong coronoid process rises high above the condyle, and is slightly curved backwards; there is the same well-marked depression on the exterior of the ascending ramus for the firm implantation of the temporal muscle, and the lower boundary of this depression is formed by a strong ridge extended downwards and forwards from the outside of the condyle. But in the Dog and other placental *Carnivora* (the seals excepted), a process, representing the angle of the jaw, extends directly backwards from the middle of the above ridge, which process gives precision and force to the articulation of the jaw, and increases the power by which the masseter acts upon the jaw. Now, although the same curved ridge of bone bounds the lower part of the external muscular depression of the ascending ramus in all the Marsupials, it does not in any of them send backwards, or in any other direction, a process corresponding to that just described in the Dog and other placental *Carnivora*. The angle of the jaw itself, in the Marsupials, is as if it were bent inwards in the form of a process encroaching in various shapes, and various degrees of development in the different Marsupial genera upon the interspace of the rami of the lower jaw. In looking directly upon the lower margin of the jaw, we see, therefore, in place of the margin of a vertical plate of bone, a more or less flattened triangular surface extended between the external ridge, and the internal process or inflected angle. This characteristic structure is

clearly exemplified in the fossil jaw from the Stonesfield oolite, in the British Museum, representing the extinct Marsupial which I have termed *Phascolotherium Bucklandii*. In the *Opossums* the internal angular process is triangular and triedral, directed inwards, with the point slightly curved upwards, and more produced in the small than in the large species. In the *Dasyures* it has a similar form, but the apex is extended into an obtuse process. In the *Thylacine* the base of the inverted angle is proportionally more extended, and a similar structure is presented by the fossil *Phascolotherium*. In the *Perameles* the angle of the jaw forms a still longer process; it is of a flattened form extended obliquely inwards and backwards and slightly curved upwards. It presents a triangular, slightly incurved, and pointed form in the *Petaurists*, in which it is longest and weakest in the pigmy species, (*Acrobates*, Desm.) It is shorter and stronger in the *Myrmecobius* (fig. 97). In the *Potoroos* and *Phalangers* the process is broad with the apex slightly developed; it is bent inwards and bounds the lower part of a wide and deep depression in the inside of the ascending ramus. In the great Kangaroo the internal margin of this process is curved upwards, so as to augment the depth of the internal depression above mentioned. The internal angular process arrives at its maximum of development in the *Wombat*, (fig. 94,) and the breadth of the base of the ascending ramus very nearly equals the height of the same part. This broad base also inclines downwards and outwards from the inflected angle, and the same peculiarity occurs in the

Fig. 97.

Lower jaw,
Myrmecobius.

jaw of the *Phascolotherium*. In the *Koala* the size of the process in question is also considerable, but it is compressed, and directed backwards with the obtuse apex only bending inwards, so that the characteristic flattening of the base of the ascending ramus is least marked in this species. There is no depression on the inner side of the ramus of the jaw in the *Koala*, but its smooth surface is simply pierced near its middle by the dental artery. The surface of the external muscular depression bounded below by a broad angular ridge, as above described, is entire in the *Dasyures*, *Opossums*, *Bandicoots*, *Petaurists*, and *Phalangers*; but in the *Wombat* the outer surface of the ascending ramus is directly perforated by a round aperture immediately posterior to the commencement of the dental canal;* the corresponding aperture is of larger size in the *Kangaroo*. But in the *Potoroos* both the external and internal depressions of the ascending ramus lead to wide canals, or continuations of the wide depressions which pass forwards into the

substance of the horizontal ramus, and soon uniting into one passage, leave a vacant space in the intervening bony septum. This structure, if it had been observed only in the jaw of a fossil Marsupial, would have supported an argument for its Saurian nature, more cogent than any that have been adduced in the discussion of the Stonesfield fossils, on account of the analogous vacuity in the jaw of the *Crocodile*.

The commencement of the dental canal in the *Potoroos* and *Wombat* is parallel with the beginning of the molar series, and it has the same relative position in the Stonesfield Marsupials; but in the other carnivorous and insectivorous species the dental foramen is placed further back. In the *Wombat* a vascular groove is continued from the foramen along the inner side of the ramus of the jaw as in the Stonesfield fossils; and a corresponding but wider groove is present in the lower jaw of the *Myrmecobius*. In the *Thylacine* and *Ursine Dasyures* and their fossil congener the *Phascolotherium*, the condyle of the lower jaw is placed low down, on a level with the molar series: it is raised a little above that level in the smaller *Dasyures* and *Opossums*, and ascends in proportion to the vegetable diet of the species.

In all those Marsupials which have few or very small incisors the horizontal rami of the jaw converge towards a point at the symphysis. The angle of convergence is most open in the *Wombat*, and the gradual diminution in the size of the rami as they approach this part is most marked and direct. The internal surface of the *symphysis menti* is almost horizontal, and is convex from side to side in the interval between the molars and incisors. The suture becomes obliterated in aged individuals. It is also wholly obliterated in the skull of a *Koala* now before me; in all the other Marsupial crania which I have examined, the rami of the lower jaw are disjoined at the symphysis; and in the *Opossum*, both the rami of the lower jaw and all the bones of the face are remarkable for the loose nature of their connection.

Vertebral column.—The vertebral column is divisible in all the Marsupials into the usual classes of cervical, costal, lumbar, sacral, and caudal vertebræ. The cervical vertebræ invariably present the usual number, seven, and the usual character of the perforation of the transverse process, or rather the presence of the upper and lower transverse processes, and the union of their outer extremities with a rudimentary rib. I found the cervical ribs of the *dentata* distinct and unanched in a mature *Perameles*. In the *Dasyures*, *Opossums*, *Bandicoots*, and *Phalangers*, the seventh cervical vertebra has only the upper transverse process, and consequently wants the character of the perforation, as in many of the ordinary *Mammalia*. In the *Petaurists*, *Koala*, *Wombat*, *Potoroos*, and *Kangaroos*, the seventh vertebra is perforated like the rest. But in the *Kangaroo* both the *dentata* and *atlas* have the transverse processes grooved merely by the vertebral

* A bristle is represented passing through this aperture in fig. 94.

arteries; and in the Koala and Wombat the atlas presents only the perforation on each side of the superior arch. In the Perameles and some other Marsupials, as the Cayopollin, an affinity to the cold-blooded Ovipara is manifested in the structure of the atlas (fig. 98),

Fig. 98.



Atlas of *Perameles lagotis*.

which exhibits a permanent separation of the neuropophyses or superior laminæ from the centre or body below. In the Koala and Wombat the body of the atlas remains permanently cartilaginous, and the lower part of the vertebral ring is completed by dried gristly substance (fig. 99). In the Petaurists, Kangaroos,

Fig. 99.

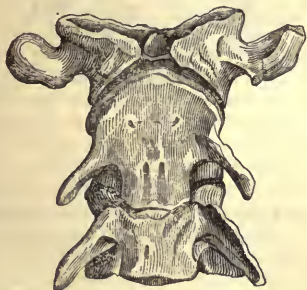

Atlas, axis, and third cervical vertebra, Koala.

and Potoroos, the atlas is completed below by an extension of ossification from the neuropophyses into the cartilaginous nucleus representing the body, and the ring of the vertebra is for a long time interrupted by a longitudinal fissure in the middle line, the breadth of which diminishes with age. This fissure is represented in figures of the atlas of a Potoroo and Kangaroo, given by Pander and D'Alton, (*Beutelliere*, fig. c, plates iii. & vii.); but in some of the skeletons of these Marsupials examined by me I find the ring completed and the fissure obliterated. In all the Marsupials the spine of the dentata is well developed both in the vertical and longitudinal directions, but most so in the Virginian and Crab-eating Opossums, (fig. 100), where it increases in thickness posteriorly; in these species also the third, fourth, and fifth cervical vertebrae have their spines remarkably long and thick, but progressively diminishing from the third (fig. 101), which equals in height and

thickness, but not in longitudinal extent, the spine of the dentata. These spines are four-sided, and being closely impacted together, one behind another, must add greatly to the strength, while they diminish the mobility of this part of the spine. I know of no other mammiferous genus which presents the same structure: in the Armadillos the corresponding spines are largely developed, but they are ankylosed together. In the Orang the cervical spines are very long and strong, but have the ordinary sub-cylindrical rounded form. Tyson, who has described and figured the above structure of the cervical vertebrae in his anatomy of the Opossum, conjectures that it is given to this arboreal animal in order "that there might be no danger of its breaking its neck should it happen to fall to the ground by chance or design;" but this teleological conjecture is invalidated by the fact that the Phalangiers, Petaurists, Koala, and other arboreal Marsupials present the usual structure of the five posterior cervical vertebrae, the spines of which are much smaller and weaker than that of the dentata, and in the Phalangiers and Petaurists almost obsolete. These do not require the neck to be strengthened to aid in overcoming the struggles of a resisting prey. I observe in the *Phalangista Cookii* that the superior flattened arches of the five last cervical vertebrae bear a ridge on each side of the spine having the same direction and form, and nearly the same size. The structure of the transverse processes of the cervical vertebrae, in the Opossum, is adapted to the strengthening and fixation of this part of the vertebral column: they are expanded nearly in the axis of the spine, but obliquely, so that the posterior part of one transverse process overlaps the anterior part of the succeeding. This structure is exhibited in a slighter degree in the cervical vertebrae of the Dasyures, Phalangiers, and Great Kangaroo. In the Petaurists, Potoroos, Wombat, and Koala, the direction and simpler form of the transverse processes allows of greater freedom of lateral motion. In the Koala and Wombat a short obtuse process is given off from the under part of the transverse process of the sixth cervical vertebra. In the Potoroos, Kangaroos, Petaurists, Phalangiers, Opossums, and Dasyures, this process is remarkably expanded in the direction of the axis of the spine. In the Bandicoots corresponding processes are observed progressively increasing in size, on the fourth, fifth, and sixth cervical vertebrae.

The number of the dorsal vertebrae is greatest in the Wombat, where it is fifteen, corresponding with the number of pairs of ribs: it is least in the Petaurists, which have twelve dorsal vertebrae.* In all the other genera there

* In the skeletons both of the *Pet. macrurus* and *Pet. sciureus* in the Museum of the College of Surgeons there are twelve pairs of ribs; but in the *Pet. macrurus* the succeeding vertebra has a short transverse process on each side, the extremity of which has the appearance of having supported a costal appendage. Cuvier, however, assigns but twelve dorsal vertebrae to this species in his table. Lec. d'Anat. Comp. 2d edit. p. 180.

Fig. 100.



Vertebra dentata, *Didelphys Virginiana*.

Fig. 101.



Third cervical vertebra, *Didelphys Virginiana*.

are thirteen dorsal vertebræ and thirteen pairs of ribs.*

In the Koala the length of the spine of the first dorsal hardly exceeds that of the last cervical, but in all other Marsupials the difference is considerable, the first dorsal spine being much longer: those of the remaining dorsal vertebræ progressively diminish in length and increase in breadth and thickness. They slope backwards towards the centre of motion, which in Mauge's *Dasyure* is shown to be at the ninth dorsal vertebra, by the verticality of its spine, towards which both the preceding and succeeding spines incline. In the *Perameles* the centre of motion is at the eleventh dorsal vertebra, in the Potoroo and Kangaroo at the twelfth, in the *Petaurists* at the thirteenth vertebra. In the *Phalangers*, *Opossum*, *Koala*, and *Wombat* the flexibility of the spine is much diminished, and the centre of motion is not defined by the convergence of the spinous process towards a single vertebra, but they all incline slightly backwards.

The lumbar vertebræ are four in number in the *Wombat*, seven in the *Petaurists*, and six in other Marsupialia; the total number of true vertebræ being thus the same in all the genera.†

The pressure which the trunk of the *Wombat* must occasionally have to resist in its extensive subterranean burrows, is probably the condition of the development of the additional pairs of ribs in that species.

The anterior oblique processes, which begin to increase in length in the three posterior dorsal vertebræ, attain a great size in the lumbar vertebræ, and are locked into the interspace of the posterior oblique processes which are double on each side, except in the *Perameles*, and in the last lumbar vertebræ of all the other genera. The transverse processes of the lumbar vertebræ progressively increase in length as the vertebræ approach the sacrum; they are most developed in the *Wombat*, where they are directed obliquely forwards. In the *Kangaroos*, *Potoroos*, and *Perameles*, they are curved forwards and obliquely downwards. The length of these and of the anterior oblique processes is relatively least in the *Petaurists*, *Phalangers*, and *Opossums*.

Sacrum.—The number of vertebræ succeeding the lumbar which are ankylosed together in the sacral region of the spine, amounts in the *Wombat* to seven (fig. 102), but if we regard those vertebræ only as sacral which join the *ossa innominata*, then there are but three. In the *Phalangers* there are generally two sacral vertebræ, but in the *Phalangista Cookii* the last lumbar assumes the character of the sacral ver-

tebræ both by ankylosis and partial junction with the *ossa innominata*.

Fig. 102.



Pelvis of the *Wombat*.

In the *Kangaroos* and *Potoroos* the impetus of the powerful hinder extremities is transferred to two ankylosed vertebræ. In the *Perameles* there is only a single sacral vertebra, the spine of which is shorter and thicker than those of the lumbar vertebræ, and is turned in the contrary direction, viz. backwards.

In the *Myrmecobius* there are four sacral vertebræ by ankylosis, two of which join the ilia. In Mauge's *Dasyure*, two sacral vertebræ are ankylosed, but it is to the expanded transverse processes of the anterior one only that the *ossa innominata* are joined. The same kind of union exists in the *Viverrine Dasyure*, but three vertebræ are ankylosed together in this species. In the *Phalangers* and *Petaurists* there are two sacral vertebræ. In *Petaurus macrurus* three are ankylosed together, though only two join the ilium. In the *Wombat* (fig. 102) the transverse processes of the numerous ankylosed vertebræ are remarkable for their length and flatness, those of the first four are directed outwards and are confluent at their extremities; the remaining ones are turned in a slight degree backwards, and very nearly reach the tuberosities of the ischia, behind which they gradually diminish in size and disappear in the three last caudal vertebræ. The transition from the sacral to the caudal vertebræ is very obscure in the *Wombat*. If we limit the sacral to the three which join the ilium, then there remain twelve vertebræ for the tail. The spinal canal is complete in all but the last three, which consist only of the body. There are no inferior spines, and as only the six posterior vertebræ, which progressively diminish in length, extend beyond the posterior aperture of the pelvis, the tail is scarcely visible in the living animal. In the *Koala* (fig. 109) the tail is also very short. In the *Chæropus* it seems to be wanting. In one species of *Perameles* I find eighteen caudal vertebræ; in

* Cuvier assigns only twelve dorsal vertebræ to the *Kangaroo Rat*, but in two different species of *Hypsiprymnus* in the Mus. Coll. Surgeons, there are thirteen dorsal and six lumbar vertebræ, and I observed the same number in the skeletons of *Hypsiprymnus ursinus* and *dorcocephalus* in the Leyden Museum. Pander and D'Alton figure thirteen dorsal vertebræ in the *Hypsiprymnus murinus*.

† In *Phal. Cookii* the sixth lumbar vertebra is joined by a part of its transverse processes to the *ossa innominata*.

another twenty-three. In two species of Potoroo there are twenty-four caudal vertebræ, but the relative length of the tail differs in these by one-third, in consequence of the different length of the bodies of the vertebræ. In *Hypsiprymnus ursinus* there are more than twenty-six caudal vertebræ. In the great Kangaroo there are twenty-two caudal vertebræ. In Bennett's Kangaroo there are twenty-four caudal vertebræ, which are remarkable for their size and strength. In the *Phalangista vulpina*, there are twenty-one caudal vertebræ. In the *Petaurus macrurus* I find twenty-eight caudal vertebræ, while in the *Pet. sciureus* there are but twenty; the bodies of the middle caudal vertebræ in both these species are remarkably long and slender. The *Myrmecobius* has twenty-three caudal vertebræ. In the *Dasyurus Maugei* I find twenty caudal vertebræ; in *Didelphis cancrivora* there are thirty-one; in the Virginian Opossum there are twenty-two caudal vertebræ. In the latter species the spinal canal is continued along the first six; beyond these the superior spinous processes cease to be developed, and the body gives off, above, only the two anterior and two posterior oblique processes, which are rudimental, and no longer subservient to the mutual articulation of the vertebræ. The transverse processes are single on the first five caudal vertebræ, and are nearly the breadth of the body, but diminish in length from the second caudal, in which vertebræ they are generally the longest. In the other vertebræ a short obtuse process is developed at both extremities of the body on either side, so that the dilated articular surfaces of the posterior caudal vertebræ present a quadrate figure.

In most of the Marsupials which have a long tail, this appendage is subject to pressure on some part of the under surface. In the Kangaroo (fig. 103,) this must obviously take place to a considerable degree when the tail is used as a fifth extremity, to aid in supporting or propelling the body. In the Potoroos and Bandicoots the tail also transmits to the ground part of the superincumbent pressure of the body by its under surface, when the animal is erect, but it is not used as a crutch in locomotion as in the Kangaroos. In the Phalangers and Opossums the tail is prehensile, and the vessels situated at the under surface are liable to compression when the animal hangs suspended by the tail. To protect these vessels, therefore, as well as to afford additional attachment to the muscles which execute the various movements for which the tail is adapted in the above mentioned Marsupials, V-shaped bones, or inferior arches (hæmapophyses) are developed, of various forms and sizes, and are placed opposite the articulations of the vertebræ, a situation which is analo-

gous to that of the superior arches in the sacral region of the spine in Birds, and in the dorsal region of the spine in the Chelonian Reptiles. The two crura of the sub-vertebral arch embrace and defend the bloodvessels, and the spinous process continued from their point of union presents a variety of forms in different genera.

Fig. 104.



Terminal caudal vertebræ.

In Cook's Phalanger I find the hæmapophyses commence between the second and third caudal vertebræ, increase in length to the fourth, and then progressively diminish to the end of the tail; the penultimate and antepenultimate presenting a permanent separation of the lateral moieties, and an absence of the spine (fig. 104.)

In the Virginian Opossum and Vulpine Phalanger they are simple, about a quarter of an inch in length where longest, and directed obliquely forwards, and diminish in size as they approach the extremity of the tail. In the Potoroos the extremity of the long anterior spines is dilated and produced both backwards and forwards; the posterior smaller ones become expanded laterally, and give off similar but shorter processes from each side, whereby the base of support is extended. In the Great Kangaroo the spine of the first subvertebral arch only is simple and elongated, the extremities of the others are expanded, and in some jut out into four obtuse processes, two at the sides, and two at the anterior and posterior surfaces. In a carefully prepared skeleton of *Macropus Bennettii* in the Museum of the Zoological Society, I found these inferior spines want-

Fig. 103.

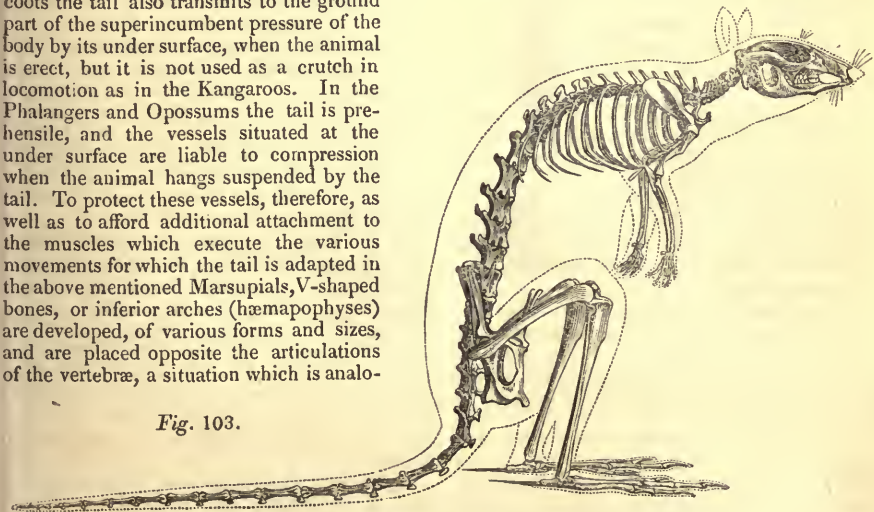
*Macropus elegans.*

ing between the last nine vertebræ of the tail. In the Petaurists, Phascogales, and Dasyures, where the tail acts as a balancing pole, or serves, from the long and thick hair with which it is clothed, as a portable blanket to keep the nose and extremities warm during sleep, the subvertebral arches are also present, but in less number and of smaller relative size. They are here principally subservient to the attachment of muscles, their more mechanical office of defending the caudal vessels from pressure not being required.

Thorax.—The ribs consist of thirteen pairs, except in the Wombat, which has fifteen, and Petaurists, which have twelve; the first is the shortest, and, except in some of the Petaurists, the broadest. In the *Pet. macrurus* the fifth, sixth, or seventh are the broadest, and the ribs generally have, both in this species and

in *Pet. sciureus*, a more compressed form than in the other Marsupials; but this character does not exist in *Petaurus Tuguanoides*. In the Great Kangaroo they are very slender and rounded, except at the sternal extremities, which are flattened for the attachment of the cartilages. In this species and the Bush Kangaroo, the seven anterior pairs of ribs articulate directly with the sternum. The cartilages of the six false pairs are long and bent towards the sternum, but do not join it, nor are they confluent, but have a gliding motion one over the other.

In the Myrmecobius there are eight pairs of true ribs; the two last pairs are floating ribs. In the Opossum there are seven pairs of true ribs, and six which may be regarded as *costæ nothæ*. In the Petaurist six pairs out of the twelve, and in the Wombat six pairs only out of the fifteen, reach the sternum (*fig. 105*).

Fig. 105.

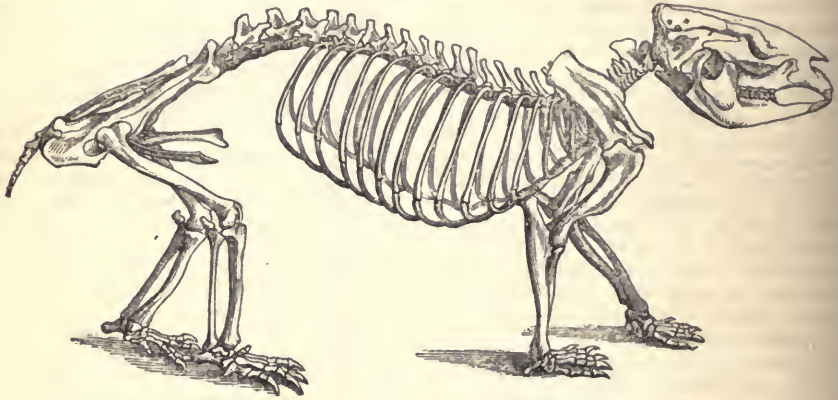

Phascolomys fusca.

The *sternum* consists of a succession of elongated bones, generally six in number, but in the *Petaurus Tuguanoides* five, and in the Wombat four.

The first bone, or manubrium sterni, is the largest, and presents in many species a triangular shape from the expansion of its anterior part, and sometimes a rhomboidal figure. A strong keel or longitudinal process is given off in many species from the middle of its inferior or outer surface; the side next the cavity of the chest is smooth and slightly concave. In the Wombat, Phalangiers, and others, the keel is produced anteriorly into a strong process, against the sides of which the clavicles abut: the first pair of ribs join the produced anterior angles of the manubrium.

In the Dasyures, Opossums, Phalangiers, and Petaurists, the manubrium is compressed and elongated, and the clavicles are joined to a process continued from its anterior extremity; the small clavicles of the Kangaroo have a similar connexion.

The cartilages of the true ribs (which frequently become ossified in old Marsupials) are articulated as usual to the interspaces of the sternal bones; the last of these supports a broad flat cartilage.

Of the Pectoral Extremities.—The *scapula* varies in form in the different Marsupials. In the Petaurists it forms a scalene triangle, with the glenoid cavity at the convergence of the two longest sides.

In the Wombat it presents a remarkably regular oblong quadrate figure, the neck being produced from the lower half of the anterior margin, and the outer surface being traversed diagonally by the spine, which in this species gradually rises to a full inch above the plane of the scapula, and terminates in a long narrow compressed acromion arching over the neck to reach the clavicle.

In the Koala (*fig. 106*), the superior costa does not run parallel with the inferior, but recedes from it as it advances forwards, and then passes down, forming an obtuse angle, and with a gentle concave curvature to the neck of the scapula; a small process extends from the middle of this curvature. In the Potoroo, the upper costa is at first parallel with the lower, but this parallel part is much shorter; the remainder describes a sigmoid flexure as it approaches the neck of the scapula.

In the Great Kangaroo, the Perameles, Phalangiers, Opossums, and Dasyures, the whole upper costa of the scapula describes a sigmoid

Fig. 106.



Scapula of Koala.

curve, the convex posterior position of which varies as to its degree and extent.

The subscapular surface is remarkable in the *Perameles* for its flatness, but presents a shallow groove near the inferior costa. In most other Marsupials it is more or less convex or undulating.

In the Great Kangaroo the supra-spinal fossa is of less extent than the space below the spine, and the spine is inclined up-

wards. In the *Perameles* and *Dasyures* the proportions of the supra and infraspinous surfaces are reserved, and the whole spine is bent downwards over the infraspinous surface. In the Potoroos and Phalangers the acromion is, as it were, bent downwards so as to present a flattened surface to the observer. In the Potoroos and Opossums this appearance is produced by a true expansion of the acromion. In the *Perameles* the coracoid process is merely represented by a slight production of the superior part of the glenoid cavity. In the Kangaroo and Potoroo it forms a protuberance on the upper part of the head of the scapula. In the other Marsupials it assumes the character of a distinct process from the same part, and attains its greatest development in the Wombat and Koala, in the latter of which it is forcibly curved downwards and inwards.

The *clavicles* are present in all the Marsupials, with the exception of the genus *Perameles*, and probably also the *Charopus*. In the clavicate Marsupials they are relatively strongest and longest in the burrowing Wombat, weakest and shortest in the Great Kangaroo. In the latter they are simply curved with the convexity forwards, and measure only two inches in length. In the Wombat they are upwards of three inches in length, and have a double curvature; they are expanded and obliquely truncate at the sternal extremity, where the articular surface presents a remarkably deep notch: they become compressed as they approach the acromion, to which they are attached by an extended narrow articular surface.

In the Koala the *clavicles* are also very strong, but more compressed than in the Wombat, bent outwards in their whole extent, and the convex margin formed, not by a continuous curve, but by three almost straight lines, with intervening angles; progressively diminishing in extent to the outermost line which forms the articular surface with the acromion. In the *Myrmecobius* the *clavicles* are subcompressed and more curved at the acromial than at the sternal end. In most of the other Marsupials the *clavicle* is a simple compressed elongated bone, with one general outward curvature.

The *humerus* in the *Dasyures* and *Thylacines* resembles that of the Dog-tribe in the

imperfurate condition of the inner condyle, but differs in the more marked development of the muscular ridges, especially of that which extends upwards from the outer condyle for the origin of the great supinator muscle. This ridge is terminated abruptly by the smooth tract for the passage of the musculo-spiral nerve.

In all the other genera of Marsupials that I have examined the internal condyle of the humerus is perforated. But in some species of *Petaurus*, as *Petaurus sciureus*, the foramen is represented by a deep notch; and in the *Phalangista Cookii*, both foramen and notch are wanting.* The ridge above the external condyle is much developed in the *Petaurus macrurus* and *sciureus*, and notched at its upper part, but this notch does not exist in *Pet. taguanoides*. I find similar differences in the development of the supinator, or outer ridge, in the genus *Perameles*; in the *Per. lagotis* it is bounded above by a groove; in *Per. Gunnii* it is less developed and less defined. In the Kangaroos, Potoroos, Wombat, and Koala (fig. 107), the outer condyloid ridge extends in the form of a hooked process above the groove of the radial nerve. In all these, and especially in the Wombat, the deltoid process of the humerus is strongly developed; it is continued from the external tuberosity down the upper half of the humerus; except in the *Petaurists*, where, from the greater relative length of the humerus, it is limited to the upper third.

The interspace of the condyles is occasionally perforated, as in the *Perameles lagotis* and Wombat. The articular surfaces at both extremities of the humerus have the usual form; but it may be observed in some Marsupials, as the Koala, that at the distal articulation the external convexity for the radius has a greater relative extent than usual, and the ulnar concavity is less deep.

Fig. 107.



Humerus of the Koala.

The bones of the fore-arm present little to detain our notice. They are always distinct and well developed, and their adaption to pronation and supination is complete. The prehensile faculty and ungulate structure of the anterior extremities appear to have been indispensable to animals where various manipulations were required in the economy of the marsupial pouch. When, therefore, such an animal is destined like the ruminant to range the wilderness in quest of pasturage, the requisite powers of the anterior members are retained and secured to it, as has been already observed, by an enormous development of the hinder extremities, to which the function of locomotion is restricted.

* In the other species of *Phalangista*, and in the *Petaurus taguanoides* and *macrurus*, the internal condyle of the humerus is perforated.

We find, therefore, that the bones of the forearm of the Kangaroo differ little from those of the burrowing Wombat, the climbing Koala, or the carnivorous Dasyure, save in relative size. They present the greatest proportional strength in the Wombat, and the greatest proportional length and slenderness in the Petaurists or Flying Opossums, in which the radius and ulna are in close contact through a great portion of their extent, and thus lend a firmer support to the outstretched dermal parachute. They are also long and slender in the Koala. In general the radius and ulna run nearly parallel, and the interosseous space is very trifling. It is widest in the Potoroos. The olecranon is well developed in all the Marsupials. In the Virginian Opossum and Petaurists we find it more bent forwards upon the rest of the ulna, than in the other Marsupials. In the Wombat, where the acromion is the strongest, and rises an inch and a half above the articular cavity of the ulna, it is extended in the axis of the bone. The distal end of the radius in this animal is articulated to a bone representing the os scaphoides and os lunare.

The ulna, which in the same animal converges towards a point at its distal end, has that point received in a depression formed by the cuneiform and pisiform bones; these are bound together by strong ligaments, and the pisiform then extends downwards and backwards for two-thirds of an inch. The second row of the carpus consists of five bones. The trapezium supports the inner digit, and has a small sesamoid bone articulated to its radial surface. The trapezoides is articulated to the index digit, and is wedged between the scapho-lunar bone and os magnum; this forms an oblique articular surface for the middle digit; but the largest of the second series of carpal bones is cuneiform, which sends downwards an obtuse rounded process, and receives the articular surface of the fifth, and the outer half of that of the fourth digit, the remainder of which abuts against the oblique proximal extremity of the middle metatarsal bone.

The five metacarpal bones are all thick and short, but chiefly so the outermost. The innermost digit, or pollex, has two phalanges, the remainder three; the ungueal phalanx of all the digits is conical, curved, convex above, expanded at the base, and simple at the opposite extremity.

In the *Perameles* the ungueal phalanx of the three middle digits of the hand, and of the two outer digits of the foot, are split at the extremity by a longitudinal fissure commencing at the upper part of the base. This structure, which characterizes the ungueal phalanges in the Placental Anteaters, has not been hitherto met with in other Marsupial genera.*

The terminal phalanges of the Koala are large, much compressed and curved; the concave articular surface is not situated, as in the cats, on the lower part of the proximal end, but, as in the sloths, at the upper. The claws which they support are long.

* It would be interesting to examine the skeleton of the *Chæropus*, with reference to this structure.

In the Great Kangaroo the first row of the carpus is composed, as in the Wombat, of three bones, but the apex of the ulna rotates in a cavity formed exclusively by the cuneiforme. There are four bones in the second row; of which the unciform is by far the largest, and supports a part of the middle, as well as the two outer digits. In the Potoroos I find but three bones in the distal series of the carpus, the trapezoides being wanting, and its place in one species being occupied by the proximal end of the second metacarpal bone, which articulates with the os magnum. In the *Perameles* there are four bones in the second carpal row, although the hand is less perfect in this than in any other Marsupial genus, *Chæropus* excepted, the three middle toes only being fully developed.

In the Petaurists the carpus is chiefly remarkable for the length of the *os pisiforme*.

It would be tedious to dwell on the minor differences observable in the bony structure of the hand in other Marsupials. I shall therefore only observe that though the inner digit is not situated like a thumb, yet that the fingers enjoy much lateral motion, and that those at the outer can be opposed to those at the inner side so as to grasp an object and perform, in a secondary degree, the function of a hand. In the Koala the two inner digits are more decidedly opposed to the three outer ones than in any other climbing Marsupial. But some of the Phalangers, as the *Ph. Cookii* and *Ph. gliriformis* of Bell, present in a slighter degree the same disposition of the fingers, by which two out of the five have the opposable properties of a thumb. I have observed a similar disposition of the digits in the act of climbing in the Dormouse, and it probably is not uncommon in other placental Mammalia of similar habits and which have long, slender, and freely moveable fingers. As a permanent disposition of the digits, the opposition of three to two is most conspicuous in the prehensile extremities of the Chameleon.

Of the Pelvic Extremities.—The pelvis (*fig. 109*) in the mature Marsupials is composed of the os sacrum, the two ossa innominata, and the characteristic supplemental bones, attached to the pubis, called by Tyson the *ossa marsupialia* or *Janitores Marsupii*.

We seek in vain for any relationship between the size of the pelvis and that of the new-born young, the minuteness of which is so characteristic of the present tribe of animals. The diameters both of the area and apertures of the pelvic canal are always considerable, but more especially so in those Marsupialia which have the hinder extremities disproportionately large; as also in the Wombat, where the pelvis is remarkable for its width. The pelvis is relatively smallest in the Petaurists; but even here the diameter of the outlet is at least six times that of the head of the new-born young.

The anterior bony arches formed by the ossa pubis and the ischia are always complete, and the interspace between these arches is divided, as in other Mammalia, into the two obturator foramina by an osseous bridge continued from

the pubis to the ischium on each side of the symphysis.

In the Kangaroos, Potoroos, Phalangers, and Opossums the ilia offer an elongated prismatic form. They are straight in the Opossum, but gently curved outwards in the other Marsupial genera. In the Dasyures there is a longitudinal groove widening upwards in place of the angle at the middle of the exterior surface of the ilium. The ilia in the Petaurists are simply compressed, with an almost trenchant anterior margin. They are broader and flatter in the Perameles, and their plane is turned outwards. But the most remarkable form of the ilia is seen in the Wombat, in which they are considerably bent outwards at their anterior extremity. In the Kangaroos and Potoroos the eye is arrested by a strong process given off from near the middle of the ileo-pubic ridge, and this process may be observed less developed in the other Marsupialia. The tuberosity of the ischia inclines outwards in a very slight degree in the Dasyures, Opossums, Phalangers, Petaurists, and Perameles, in a greater degree in the Kangaroos and Potoroos, and gives off a distinct and strong obtuse process in the Wombat, (*fig. 108.*) which

Fig. 108.

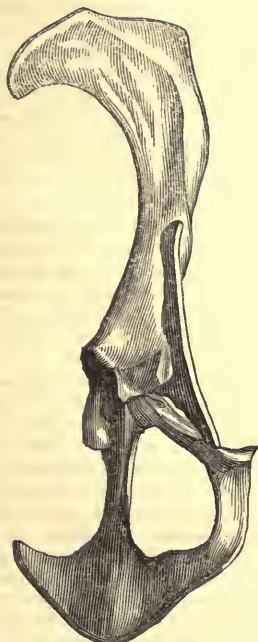

Right os innominatum and marsupial bone, Wombat.

not only extends outwards but is curved forwards. In the Potoroos the symphysis of the ischia, or the lower part of what is commonly called the symphysis pubis, is produced anteriorly. The length of this symphysis, and the straight line formed by the lower margin of the ischia is a characteristic structure of the pelvis in most of the Marsupialia.

The Marsupial bones (*a, a, fig. 109*) are

Fig. 109.

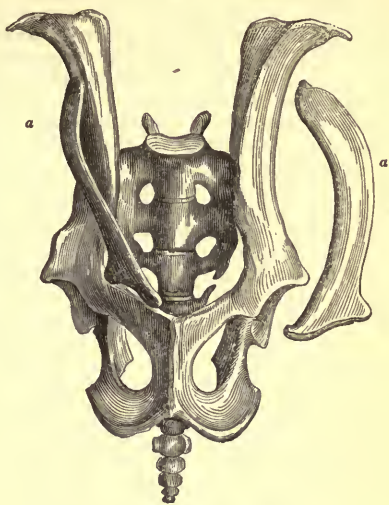

Pelvis and marsupial bones of the Koala.

elongated, flattened, and more or less curved, expanded at the proximal extremity, which sometimes, as in the Wombat, is articulated to the pubis by two points; they are relatively straightest and most slender in the Perameles; shortest in the Myrmecobius, where they do not exceed half an inch in length; longest, flattest, broadest, and most curved in the Koala, where they nearly equal the iliac bones in size. They are always so long that the cremaster muscle winds round them in its passage to the testicle or mammary gland, and the uses of these bones will be described in treating of that muscle.

With reference to the interesting question—What is the homology or essential nature of the ossa marsupialia? I entirely concur in the opinion first advanced by the able anatomist, M. Laurent,* viz. that they belong to the category of the trochlear ossicles, commonly called sesamoid, and are developed in the tendon of the external oblique which forms the mesial pillar of the abdominal ring, as the patella is developed in the tendon of the *rectus femoris*. I had arrived at this conclusion from independent researches, and unaware of any prior announcement of this view when I discussed the question before the Zoological Society in 1835.† I cannot, however, participate in the opinion of M. Laurent and the celebrated De Blainville, that the marsupial bones are superadded to the abdominal muscles to aid in an unusually energetic compression required to expel the uterine fetus. It is not in the females of those animals which give birth to the smallest

* See his note inserted in the 'Bulletin des Sciences Médicales' of Férussac, 1827, No. 77, p. 112, and the *Annales d'Anat. et de Physiologie*, 1839, p. 240.

† See the abstract of a paper on the anatomy of the *Dasyurus*, *Proc. Zool. Soc.*, January, 1835.

fœtuses that we ought to find auxiliary parts for increasing the power of the muscles engaged in parturition. The bones in question are, moreover, equally developed in both sexes: and they are so situated and attached that they add to the power of the muscles which wind round them, and not of those implanted in them. They are not, however, merely subservient to add force to the action of the "cremasteres," but give origin to a great proportion of the so-called "pyramidales."

The *osteogenesis* of the marsupial pelvis derives some extrinsic interest from the not yet forgotten speculations which have been broached regarding the analogies of the marsupial bones. These have been conjectured to exist in many of the placental Mammalia, with a certain latitude of altered place and form, disguised, e. g. as the bone of the *penis* in the Carnivora, or appearing as the supplemental ossicles of the acetabulum, which exist in the young of many of the Rodentia. In the *os innominatum* of the immature Potoroo the curved prismatic *ilium* contributes to form, by the outer part of its base, the upper or anterior third of the acetabulum; the rest of the circumference of this cavity is completed by the *ischium* and *pubis*, excepting a small part of the under or mesial margin, which is formed by a distinct ossicle or epiphysis of the *ilium*, (*a*, *fig.* 110.)

Fig. 110.



analogous to that described by Geoffroy St. Hilaire as the rudimental marsupial bone in the rabbit. Now here there is a co-existing marsupial bone: but besides the five separate bones just mentioned, there is a sixth distinct triangular ossicle, which is wedged into the posterior interspace of the ischio-pubic symphysis. How easy were it to suggest that this single symmetrical bone may be the representative of the *os penis* removed from the glans to the root of the intromittent organ! I regard it as a mere epiphysis of the *ischium*. The circumference of the acetabulum is always interrupted by a deep notch opposite the obturator foramen, which is traversed by a ligamentous bridge, and gives passage to the vessels of the Harderian gland lodged in the wide and deep acetabular fossa.

The penial like the marsupial bone is essentially an ossification of the fibrous or sclerous tissue.

The *femur* is a straight, or nearly straight, long, cylindrical bone, having a hemispherical head supported on a very short neck, especially in the Petaurists, and situated here almost in the axis of the shaft, above and between the two trochanters, which are nearly

of equal size. In the Kangaroos and Potoroos the head of the thigh-bone is turned more inwards, and the outer or greater trochanter rises above it. In other Marsupials the great trochanter is less developed. In most of the species a strong ridge is continued downwards to within a short distance from the trochanter, and this ridge is so produced at the lower part in the Wombat as almost to merit the name of a third trochanter. In the Wombat and Koala there is no depression for a *ligamentum teres*. The shaft of the bone presents no *linea aspera*.

The canal for the nutrient artery commences at the upper third and posterior part of the bone in the Koala, and extends downwards, contrariwise to that in most other marsupial and placental Mammalia.

At the distal extremity of the femur the external condyle is the largest, the internal rather the longest. The intermediate anterior groove for the patella is well marked in the *Perameles*, where the patella is fully developed, but is broad and very shallow in the Phalangiers and Dasyures, where the tendon of the *rectus* muscle is merely thickened or offers only a few irregular specks of ossification; and the corresponding surface in the Petaurists, Wombat, and Koala is almost plane from side to side; in these Marsupials and in the *Myrmecobius* the patella is wanting. I find a distinct but small bony patella in the *Macropus Bennettii*. There is a sesamoid bone above and behind the external condyle of the femur in the *Myrmecobius* and some other Marsupials.

In the knee-joint, besides the two crucial ligaments continued from the posterior angles or cresses of the semilunar cartilages—one to the outer side of the inner condyle, the other to the interspace of the condyles—there is a strong ligament which passes from the anterior part of the tibial protuberance backwards to the inner side of the fibular condyle, and a second continued from the same point along the outer margin of the outer semilunar cartilage to the head of the tibia.

The *tibia* (*a*, *fig.* 111) presents the usual disposition of the articular surface for the condyles of the femur, but in some genera, as the Wombat and Koala, the outer articular surface is continuous with that for the head of the fibula. In the Kangaroos and Potoroos the anterior part of the head is much produced, and in the young animal its ossification commences by a centre distinct from the ordinary proximal epiphysis of the bone. A strong ridge is continued down from this protuberance for about one-sixth the length of the tibia. In the Koala a strong tuberosity projects from the anterior part of the tibia at the junction of the upper with the middle third. In this species and in the Wombat, as also in the Opossums, Dasyures, Phalangiers, and Petaurists, the shaft of the tibia is somewhat compressed and twisted; but in the Kangaroos, Potoroos, and *Perameles* the tibia is prismatic above and sub-cylindrical below. The internal malleolus is very slightly produced in any Marsupial, but most so in the Wombat.

The *fibula* is complete, and forms the external malleolus in all the Marsupials. In one species of *Hypsiprymnus* and in one species of *Perameles* (*P. lagotis*) it is firmly united to the lower part of the tibia, though the line of separation be manifest externally. In a second species of each of the above genera it is in close contact with the corresponding part of the tibia, but can be easily separated from that bone. In the Great Kangaroo the fibula is also a distinct bone throughout, but it is remarkably thinned and concave at its lower half, so as to be adapted to the convexity of the tibia, with which it is in close contact and attachment. In each of these genera, therefore, in which locomotion is principally performed by the hinder extremities, we perceive that their osseous structure is so modified as to ensure a due degree of fixity and strength; while in the other marsupial genera, as *Phascolarctos*, *Phascolumys*, *Phalangista*, *Petaurus*, *Didelphis*, and *Dusyurus*, the tibia and fibula are so loosely connected together and with the tarsus, that the foot enjoys a movement of rotation analogous to the pronation and supination of the hand: This property is especially advantageous in the Petaurists, Phalangiers, Opossums, and Koala, because in these the inner toe is so placed and organized as to perform the office of an opposable thumb, whence these Marsupials have been termed *Pedimuna* or foot-handed (*fig. 111*).

It is to this prehensile power that the modifications of the fibula chiefly relate. In the Wombat, Koala, Petaurists, and Phalangiers it expands to nearly an equal size with the tibia at the distal extremity, and takes a large share in the formation of the tarsal joint; but the articular surface is slightly convex, while that of the tibia is slightly concave. The proximal extremity of the fibula is also much enlarged, but compressed and obliquely truncated, and giving off two tuberosities from its exterior surface; to the superior of these a large sesamoid bone (*c*, *fig. 111*) is articulated; I have observed the same sesamoid attached to the upper end of the fibula in a *Dusyurus macrurus* and *Petaurus taguanoides*. M. Temminck figures it in the *Didelphys ursina* and *Didelphys Philander*. This sesamoid and the expanded process to which it is attached form the analogue of the olecranon; and the correspondence of the fibula with the ulna is very remarkably maintained in the *Pet. taguanoides*, in which the proximal articular surface of the fibula is divided into two facets, one playing upon the outer condyle of the femur, the other concave, vertical, and receiving an adapted convexity on the outer side of the head of the tibia, which rotates thereupon exactly like the radius in the lesser sigmoid cavity of the ulna.

In the scansorial and gradatorial Marsupials the bones of the hinder and fore extremities are of nearly equal length, but in the saltatory species the disproportion in the development of the bones of the hind leg is very great, especially in the Kangaroos and Potoroos (*fig. 103*). However, in those singular species of *Hypsiprymnus* which inhabit New Guinea and take

Fig. 111.

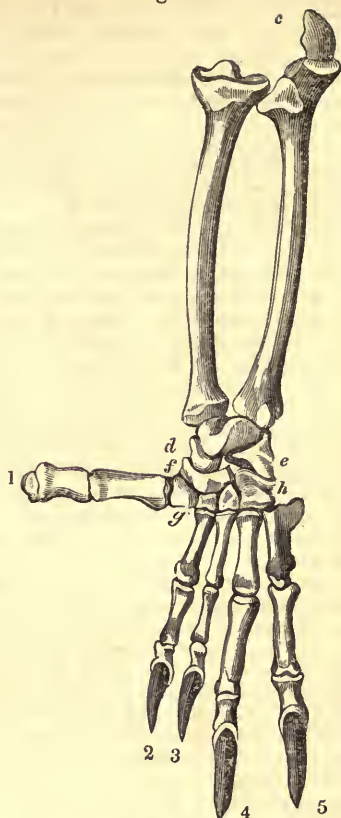
Bones of the leg and foot, *Phalangista*.

refuge in trees, the organization of the Kangaroo is modified and adapted so as to make climbing a possible and easy action. The fore and hind legs are here more equally developed, and the claws on the two larger toes of the hind feet are curved instead of straight. In a skeleton of one of these scansorial Potoroos, the *Hypsiprymnus ursinus*, in the Museum at Leyden, in which the humerus is three inches and a half long, the femur does not quite equal five inches in length: the ulna is nearly four inches, the fibula nearly five inches in length. The fibula is also less firmly connected with the tibia than in the great Kangaroo.

The following is the structure of the tarsus in the Wombat. The *astragalus* is connected as usual with the tibia, fibula, calcaneum, and scaphoides. The upper articular surface for the tibia is as usual concavo-convex, the internal surface for the inner malleolus flattened and at right angles with the preceding, but the outer articular surface presents a triangular flattened form, and instead of being bent down parallel with the inner articular surface, slopes away at a very open angle from the upper surface, and receives the articular surface of the fibula so as to sustain its vertical pressure. A very small proportion of the outer part of the inferior surface of the astragalus rests upon

the calcaneum; a greater part of the superincumbent pressure is transmitted by a transversely extended convex anterior surface to the scaphoid and cuboid bones. This form of the astragalus is also characteristic of the Koala, Petaurists, Dasyures, and the Pedimanous Marsupials (*d*, fig. 111). In the Kangaroos, Potoroos, and Perameles which have the *pedes saltatorii*, the fibular articular surface of the astragalus is bent down as usual at nearly right angles with the upper tibial surface.

The *calcaneum* in the Wombat presents a ridge on the outer surface which serves to sustain the pressure of the external malleolus which is not articulated to the side of the astragalus. The internal surface which joins the astragalus is continuous with the anterior slightly concave surface which articulates with the cuboides. The posterior part of the bone is compressed, it projects backwards for nearly an inch, and is slightly bent downwards and inwards. This part is relatively shorter in the Koala, Phalangers, Opossums, and Petaurists, but it is as strongly developed in the *Dasyuri* as in the Wombat. The anterior part of the calcaneum of the Phalangers is shown at *e*, fig. 111.

In the *Dasyurus macrurus* I observe a small sesamoid bone wedged in between the astragalus, tibia, and fibula at the back part of the ankle-joint. In the *Petaurus toguanoides* there is a supplemental tarsal bone wedged in between the naviculare and cuboides on the plantar surface. In the hand-like foot of the Phalanger the structure of the tarsus is shown in fig. 111: *f* is the naviculare, *g* the internal cuneiform, and *h* the os cuboides. In the Wombat the scaphoid, cuboid, and three cuneiform bones have the ordinary uses and relative positions.

The analogy of the carpal and tarsal bones is very clearly illustrated in this animal. The ankylosed *naviculare* and *lunare* of the hand correspond with the *astragalus* and *naviculare* of the foot, transferring the pressure of the *facile majus* upon the three innermost bones of the second series. The long, backward-projecting *pisiform* bone of the wrist closely resembles the posterior process of the *os calcis*; the articular portion or body of the *os calcis* corresponds with the *cuneiforme* of the carpus; the large carpal *unciform* represents the tarsal *cuboides*, and performs the same function, supporting the two outer digits; the three *cuneiform* bones of the foot are obviously analogous to the *trapezium*, *trapezoides*, and *os magnum*. The internal cuneiform bone is the largest of the three in the Wombat, although it supports the smallest of the toes. It is of course more developed in the Pedimanous Marsupials, where it supports a large and opposable thumb.

In the Wombat the metatarsals progressively increase in length and breadth from the innermost to the fourth; the fifth or outermost metatarsal is somewhat shorter but twice as thick, and it sends off a strong obtuse process from the outside of its proximal end. A corresponding process exists in the Phalangers (fig. 111). The innermost metatarsal of the Wombat (fig.

105) supports only a single phalanx; the rest are succeeded by three phalanges each, progressively increasing in thickness to the outermost; the ungueal phalanges are elongated, gently curved downwards, and gradually diminish to a point.

In the *Myrmecobius* the tibial or innermost toe is represented by a short rudimental metatarsal bone concealed under the skin. In the Dasyures the innermost toe has two phalanges, but it is the most slender and does not exceed in length the metatarsal bone of the second toe. In the Petaurists it is rather shorter than the other digits but is the strongest, and in *Petaurus toguanoides* the terminal phalanx is flattened and expanded; the toes are set wide apart in this genus. In the Opossums and Phalangers the innermost metatarsal bone is directed inwards apart from the rest, and together with the first phalanx is broad and flat. The second phalanx in the Opossums supports a claw, but in the Phalangers is short, transverse, unarmed, singularly expanded in *Ph. Cookii*, but almost obsolete in *Ph. ursina* (fig. 111, 1). In all the preceding genera there are two small sesamoid bones on the under side of the joints of the toes, both in the fore and hind feet.

The commencement of a degeneration of the foot which is peculiar to and highly characteristic of the Marsupial animals may be discerned in the Petaurists, in the slender condition of the second and third toes, as compared with the fourth and fifth. In the Phalangers this diminution of size of the second and third toes, counting from the hallux, is more marked. They are, also, both of the same length and have no individual motion, being united together in the same sheath of integument as far as the ungueal phalanges, whence the name of *Phalangista* applied to this genus (fig. 111, 2 and 3).

In the saltatorial genera of Marsupials the degradation of the corresponding toes is extreme, but though reduced to almost filamentary slenderness they retain the usual number of phalanges, and the terminal one of each is armed with a claw. These claws being the only part of the rudimental digits which project freely beyond the integument, they look like little appendages at the inner side of the foot for the purpose of scratching the skin and dressing the fur, to which offices they are exclusively designed. The removal of the innermost toe, corresponding with our great toe and the hallux of the *Pedimana*, commences in the Perameles. In one species I find the metatarsal bone of this toe supports only a single rudimental phalanx which reaches to the end of the next metatarsal bone, and the internal cuneiform bone is elongated. In another species the internal toe is as long as the abortive second and third toes, and has two phalanges, the last of which is divided by the longitudinal fissure characteristic of the ungueal phalanges in this genus. In the *Perameles lagotis* the innermost toe is represented by a rudimentary metatarsal bone, about one-third the length of the adjoining metatarsal.

In the Peophagous Marsupials no rudiment of the innermost toe exists. The power of the foot is concentrated in all these genera on the fourth and fifth or two outer toes, but especially the fourth, which, in the Great Kangaroo, is upwards of a foot in length, including the metatarsal bone and the claw. This formidable weapon resembles an elongated hoof, but is three-sided and sharp-pointed like a bayonet, and with it the Kangaroo stabs and rips open the abdomen of its assailant: with the anterior extremities it will hold a powerful dog firmly during the attack, and firmly supporting itself behind upon its powerful tail, deliver its thrusts with the whole force of the hinder extremities.

The cuboid bone which supports the two outer metatarsals is proportionally developed. The internal cuneiform bone is present, though the toe which is usually articulated to it is wanting. It is also the largest of the three, and assists in supporting the second metatarsal; posteriorly it is joined with the navicular and external cuneiform bones, the small middle cuneiform occupying the space between the external and internal wedge-bones and the proximal extremities of the two abortive metatarsals. The great or fourth metatarsal is straight and somewhat flattened; the external one is compressed and slightly bent outwards; the toe which this supports is armed with a claw similar to the large one, but the unguis phalanx does not reach to the end of the second phalanx of the fourth toe, and the whole digit is proportionally weaker.

In the climbing Potoroos, (*Hypsiprymnus sinus* and *Hypsiprymnus dorcocephalus*), the two outer toes are proportionally shorter than in the leaping species, and are terminated by curved claws by which they gain a better hold on the branches and inequalities of trees.

MYOLOGY.—To give a description of the muscular system with the same detail as of the osteology of the Marsupials would not be attended with the same advantages. Modified as this system necessarily is in conformity with the various modes of locomotion in the different Marsupial genera, as running, leaping, burrowing, swimming, even flying, we should here fail to detect in these modifications so many marks illustrative of the aberrant and inferior type of structure of our present group as we have witnessed in those of the skeleton. In addition, moreover, to their physiological relations, the importance of the passive and enduring parts of the locomotive system to the zoology both of recent and extinct species, confers upon them a claim to our attention which the more perishable though more highly organised and active parts of the same system do not possess, even if a detailed myology comported with the scope and extent of the present work. The present notice, therefore, of this department of the anatomy of the Marsupialia will be limited to a brief description of a few of the most striking peculiarities.

Every one knows that the erect position is the most usual one in the Kangaroos; yet the conditions of this posture are very different from

those in the human subject. The trunk, instead of resting on two nearly vertical pillars so placed with reference to the superincumbent weight that it rather inclines to topple forwards, is here swung upon the femora as upon two springs, which descend from the knee-joints obliquely backwards to their points of attachment at the pelvis; and the trunk is propped up behind by the long and powerful tail (*fig.* 103).

In Man the massive and expanded muscles which find their attachment in the broad bones of the pelvis, especially at the posterior part, are the chief powers in maintaining the erect posture. But in the Kangaroo the *glutæi* offer no corresponding predominance of size; the narrow prismatic ilia could not, in fact, afford them the requisite extent of fixed attachment.

The chief modifications of the muscular system in relation to the erect position of the trunk in the Kangaroo are met with on the anterior part of the base of the spinal column. The *psosæ parvæ*, for example, present proportions the very reverse of those which suggested their name in human anatomy. They form two thick, long, rounded masses, which take their origin, fleshy, from the sides of the bodies and base of the transverse processes of the lower dorsal and all the six lumbar vertebræ, and from the extremities of the three last ribs; the fibres converge penniformly to a strong, round, middle tendon, inserted in the well-marked tubercle or spine of the pubis, already noticed.

The disposition of the abdominal muscles, especially at the pubic and hypochondriac regions, has been described and figured by Mr. Morgan* and Professor Vrolik† in the female Kangaroo. The principal modifications are seen first in the presence of a large muscle called the *triangularis* by Tyson, the *anterior rectus abdominis* by Mr. Morgan,‡ and considered as the analogue of the *pyramidalis* muscle by Meckel; secondly, in the equal development of the cremaster in both sexes; and thirdly, in the formation of a moveable bone in the situation and, as it were, in the substance of the mesial or internal pillar of the abdominal ring, which bone serves as a trochlea or pulley for the cremaster, and affords an extensive attachment to the abnormally developed *pyramidalis*.

This part of the muscular system is here described as it exists in a male Phalanger (*fig.* 112), that sex being chosen, because most of the peculiarities, as the extensive *pyramidalis*,§ the cremaster, and the ossified tendons of the external oblique abdominal muscle have been regarded as being essentially connected with the physiology of the marsupial pouch, whereas they are equally developed in both sexes.

The *external oblique* (*obliquus externus*), besides the usual origin by digitations from the ribs, also arises from the *fascia lumborum*; it is inserted fleshy into the summit of the mar-

* Linn. Trans. xvi. 1833.

† Tydschrift voor de Natuur, 1837.

‡ A portion of the external oblique is included by Mr. Morgan with the *triangularis* under this term.

§ Considered by Home as a sling by which the mammae were supported.

Fig. 112.

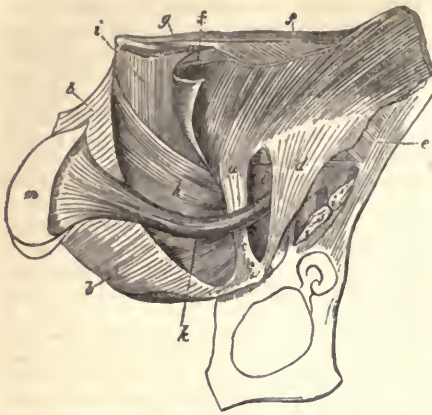
Abdominal muscles, *Phalanger vulpina*.

supial bone (*a*), over which its strong inner tendon is spread; the external oblique becomes aponeurotic at a line continued from the marsupial bone outwards, with a gentle curve, towards the anterior extremity of the ilium; and in the opposite direction, or inwards, the carneous fibres of the external oblique terminate in an aponeurosis along a line parallel with the oblique outer margin of the pyramidalis; the fascia continued from the latter boundary of the fleshy fibres passes over, or dermad of, the so-called pyramidalis, and meets its fellow at the linea alba; it is strictly analogous to the anterior layer of the sheath of the rectus in ordinary Mammalia. It is seen reflected from the pyramidalis, at *b*, fig. 112. The aponeurosis continued from the external and inferior boundary of the carneous fibres divides as usual into two distinct portions; one, corresponding to the internal or mesial pillar of the abdominal ring, spreads its glistening fibres, as above described, over the dermal surface of the marsupial bone (*c*), to which it closely adheres: the other column (*d*) contracts as it descends obliquely inwards, forms, like Poupart's ligament, the upper boundary of the space through which the psoas and iliacus muscles and femoral vessels and nerves escape from the pelvis, and is finally inserted, thick and strong, into the outer end of the base of the marsupial bone.

This bone is so connected with the pubis that its movements are almost limited to directions forwards and backwards, or those concerned with the dilatation and diminution of the abdominal space; the contraction of the abdominal muscles must draw the bones inwards so as to compress the contents of the abdomen, and so far as the connections of the bone permit, which is to a very trifling degree, the external oblique may draw it outwards towards the ilium.

In some Marsupials, as the Koala, the triceps adductor femoris sends a slip of fibres to the external angle of the base of the marsupial bone, and would more directly tend to bend that bone outwards.

The upper or anterior fibres of the *internal*

oblique have the usual origin; the lower ones (*e*) arise fleshy from the outer and anterior spine of the ilium, and for an inch along an aponeurotic chord extended from that process to the upper part of the acetabulum: these carneous fibres pass inwards, and slightly upwards, and terminate close to the outer margin of the rectus, where they adhere very strongly to the transversalis, but give off a separate sheet of thin aponeurosis which is lost in the cellular sheath of the posterior rectus.

The fleshy fibres of the *transversalis abdominis* (*f*) are closely connected by dense cellular tissue with those of the internal oblique; they are arranged in finer fasciculi, and have, as usual, a more transverse direction; they terminate along the same line as those of the internal oblique in an aponeurosis (*g*), which is continued along the inner or central surface of the posterior rectus to the median line. The lower boundary of the fleshy fibres of the transversalis is parallel with the line extended transversely between the anterior extremities of the ilia; a fascia, less compact than an aponeurosis, is continued downwards from this margin, and envelops the cremaster and the constituents of the spermatic chord, as they pass outwards and forwards beneath the lower edge of the internal oblique.

The *pyramidalis* (*h*) arises from the whole inner or mesial margin of the marsupial bone, from which the fibres diverge, the lower ones passing transversely across the interspace of the bones, and meeting at a very fine raphé, or linea alba; while those fibres from the anterior ends of the marsupial bones gradually exchange their transverse direction for one obliquely forwards. The breadth of each pyramidalis opposite the upper end of the marsupial bone is more than an inch, the thickness of the muscle one line.

The *rectus abdominis* or posterior rectus (*i*) comes off from the pubis along the inner part of the strong ligamentous union of the broad base of the marsupial bone, and expands as it ascends until it attains the level of the ensiform cartilage, when the rectus diminishes as it is inserted into the sternal extremities of the ribs reaching to the manubrium sterni and first rib in the Dasyures, as in the cats.

The slight indications of tendinous inter-sections which were noticed in this dissection were confined to the posterior or central superficies of the muscle; the first extended only half-way across from the outer margin.

The *cremaster* (*k*), in the Phalanger and Opossum, is not a fasciculus of fibres simply detached from the lower margin of the internal oblique or transversalis, but arises by a narrow though strong aponeurosis from the ilium, within and a little above the lower boundary of the internal oblique, with the fibres of which the course of the cremaster is not parallel; it might be considered as a part of the transversalis, but it is separated by the fascia above mentioned from the carneous part of that muscle. Having emerged from beneath the margin of the internal oblique, the cremaster escapes

by the large elliptic abdominal ring (*l*), bends round the marsupial bone near its free extremity, and expands upon the *tunica vaginalis testis*. In the female it has the same origin, course, and size, but spreads over the mammary glands at the back of the pouch. If the anterior fascicles of the diverging and embracing fibres be dissected from the posterior ones, the appearance of the cremaster dividing into two layers is produced.

The principal modifications of the muscles of the pectoral extremity are here described as they exist in the *Perameles lugotis*.

The *trapezius* is a broad and very thin muscle, having its origin extended from the skull, along the cervical and dorsal spines, to the fascia covering the lumbar portion of the latissimus dorsi: its fibres converge to be inserted along the spine of the scapula, the anterior ones directly continued into the pectorales, whereby it becomes an extensor of the humerus and a protractor of the fore extremity.

The *latissimus dorsi* arises chiefly from the broad aponeurosis covering the muscles of the lumbar region of the spine, and from the spines of the six posterior dorsal vertebræ; the fibres gradually converge, the muscle increasing in thickness as it diminishes in breadth, and terminating in a strong flattened tendon one inch before its insertion at the upper third of the humerus.

The chief peculiarity of this muscle is its connection with an accessory extensor (*omo-anconeus*) of the antibrachium. This extensor takes its principal origin by fleshy fibres from the terminal half inch of the fleshy part of the latissimus dorsi, and continues fleshy, slightly diminishing in size to its insertion at the apex of the olecranon; it may thus be considered as a slip detached from the latissimus dorsi, yet its fibres from their very origin run at right angles to those of that muscle, to which they are attached. To remedy the inconvenience of an origin from a yielding and flexible part, a thin aponeurotic slip, two lines in breadth and an inch in length, attaches a part of the base of the superadducted muscle and the corresponding portion of the latissimus dorsi to the sheath of the *teres major*, and to the inferior costa of the scapula near its posterior angle.

The *serratus magnus* offers no peculiarity worthy of notice.

The *supra-spinatus*, a strong penniform muscle, exceeds the *infra-spinatus* in breadth by as much as the supra-spinal fossa is broader than the infra-spinal one: it has a broad and strong insertion into the great outer tuberosity of the humerus. The *infra-spinatus* is inserted into the upper and posterior part of that tuberosity.

The *deltoides* is a comparatively small muscle; it arises from the anterior half of the spine of the scapula and from a fine aponeurosis covering the *infra-spinatus*; its fibres converge to be inserted in the upper part of the deltoid ridge.

A thin small strip of muscle arises from about the middle of the inferior costa of the scapula, beneath the *infra-spinatus*; its fibres pass forwards and join the lower margin of the

small deltoid, thus bracing and enclosing the tendon of the *infra-spinatus*.

The *subscapularis* offers no peculiarity.

The *teres major* is a strong sub-compressed muscle arising from near the posterior half of the inferior costa of the scapula, and joining, as before stated, the tendon of the latissimus.

The *triceps extensor* has its long portion arising from the anterior third of the inferior costa of the scapula; its second head comes from the posterior part of the proximal third of the humerus; the third portion takes its origin from the whole of the posterior part of the humerus; in addition to these, the olecranon receives the above described fourth superadducted slip from the latissimus dorsi.

The *pectoralis major* is, as usual in the Marsupial and many of the Placental quadrupeds, a very complicated muscle; it consists of an anterior or superficial, and a posterior or deeper portion; the anterior portion receives the strip of fibres before mentioned from the trapezius, there being no clavicle or clavicular ossicle interposed in the *Perameles*: its fibres converge, increasing in thickness as they diminish in breadth, and are inserted into the anterior and outer part of the strongly developed pectoral ridge. The second and main portion of the *pectoralis* arises from the whole extent of the sternum; its fibres are twisted obliquely across each other as they converge to be inserted into the inner part of the pectoral ridge; some of the internal and posterior fibres of this portion of the twisted pectoral pass obliquely upwards and behind the anterior fasciculi, and are inserted into the coracoid process, thus representing the *pectoralis minor*.* Beneath this latter portion of the twisted pectoral, a long and slender muscle passes to be inserted into the anterior part of the tuberosity of the humerus; this may likewise be regarded as a dismemberment of the *pectoralis major*, but it arises from the fascia of the rectus abdominis, below the cartilages of the lower ribs. Thus the strong pectoral ridge of the humerus is acted upon by muscles having a range of origin from the occiput and cervical vertebræ along the whole extent of the chest to the beginning of the abdomen.

The *biceps* is a powerful muscle, although its short head from the coracoid process is suppressed. The long head has the usual origin and relation to the shoulder-joint; its tendon is very thick and short. The fleshy belly joins that of the strong *brachialis internus*, situated at the external side of the humerus, whence it takes its principal origin from the short deltoid ridge, closely connected there with the second portion of the triceps, and deriving some fleshy fibres from the lower and outer third of the humerus. The portion of the biceps arising by the long head soon resolves itself into two distinct penniform muscles; the tendon of the outer one joins that of the *brachialis*, and this conjoined tendon simply bends the fore-arm,

* Professor Vrolik found that the *pectoralis minor* in the Kangaroo was inserted not into the coracoid process, but into the humerus between the biceps and the tendon of the *pectoralis major*.

while the other tendon bends and pronates; this, which is a direct though partial continuation of the biceps, is inserted into the ordinary tubercle of the radius; whereas the other tendon is attached to the fore part of the proximal end of the ulna.

The muscles which arise from the internal condyle of the humerus are the *pronator teres*, which has the usual origin, insertion, and relative proportions, and next the *palmaris longus*.

There are, likewise, distinct and strong fasciculi of muscles corresponding to the *flexor carpi ulnaris* and *radialis*, and to the *flexor sublimis digitorum*.

The strong ridge continued from the olecranon to the posterior and inner part of the ulna gives origin to a great proportion of the oblique fibres of the *flexor profundus*; but both this and the *flexor sublimis* terminate in a single thick and strong tendon, which after passing the wrist divides into those corresponding with the perforating and perforated tendons here concentrated upon the three long middle fingers.

The *pronator quadratus* runs the whole length of the interosseous space, passing from the radius a little obliquely downwards to the ulna.

The *supinator longus*, arising as usual from the upper part of the strongly developed ridge above the outer condyle, sends its tendon across the carpal joint, which tendon divides before it crosses, and is inserted by one of its divisions into the base of one of the metacarpal bones of the index finger, and the other to the adjoining metacarpal bone.

These are the principal muscles of the fore extremity which require notice in this place. Their modifications, in respect of number and strength, relate to the act of digging up the soil, which is habitual in the Bandicoots, as it is for the purpose of obtaining food, and not for shelter. It is for this purpose that the three middle digits of the hand are developed at the expense of the other two, which are rudimental; and we have seen that the whole power of the deep and superficial flexors is concentrated upon the fossorial and well-armed fingers; and that by the single common tendon in which the fleshy fibres of these muscles terminate, they move them collectively and simultaneously. Thus variety of application, and especially the prehensile faculty, are sacrificed to the acquisition of force for the essential action. In no Marsupial is the hand so cramped as in the *Perameles*, excepting in the *Charopus*, where the functional and fossorial fingers are reduced from three to two. It is in relation to this condition, doubtless, that the clavicles are wanting in these genera, while all other Marsupials possess them. The inverted position of the pouch in the *Perameles* might also be conceived to have relation to their imperfect hands, the mouth of the pouch being thus brought nearer to the vulva; but I am disposed to regard it as being more essentially connected with the habitually inclined or procumbent position of the trunk in the Saltatorial Entomoplaga.

The muscles of the hinder extremity are chiefly remarkable in the Kangaroo for their prodigious strength and unusual number: the

accessory muscle of the biceps, e. g. is divided into two strong fasciculi, which unite to be inserted into the side of the patella;* the pyramiformis is also a double muscle.†

The *sartorius* has its insertion so modified that it becomes an extensor instead of a flexor of the tibia: it is chiefly fixed to the tibial side of the patella, and by fascia into the capsular ligament of the knee-joint and the anterior proximal tuberosity of the tibia. In a *Dasyurus* (*Das. macrurus*) I found that the *sartorius* had a similar disposition and office. In this ambulatory carnivorous Marsupial the *external* and *middle glutei* are so disposed as to extend the thigh, while the *internal gluteus* inflects and rotates it inwards.

In a Bandicoot (*Perameles lagotis*) the *sartorius* ran nearly parallel with and dermad of the *rectus*, and was inserted into the upper part of the patella. Besides this sesamoid, which is rarely developed in other Marsupials, I found a thick cartilage attached to its upper part and interposed between the common tendon of the recti and vasti, removing that tendon further from the centre of motion and increasing the power of the extensor muscles of the leg.

The *rectus femoris* has its two origins very distinct, and its analogy to the biceps of the upper extremity is very close. The *gracilis* is a very thick and strong muscle.

The *biceps flexor cruris* in the *Perameles* is a muscle of very great strength; it terminates in a strong and broad aponeurosis, which extends over the whole anterior part of the tibia, being attached to the rotular tuberosity of that bone, and terminating below in the sheath of the tendo Achillis, whereby this muscle becomes an extensor of the foot.

It is a curious fact that all the equipedal Marsupials, whether burrowers as the Wombat, climbers as the Koala, Phalangers, and Opossums, or simply gressorial, as the *Dasyuride*, have the *tibia* and *fibula* so connected together as to allow of a certain degree of rotation upon each other, analogous to the pronatory and supinatory movements of the bones of the antibrachium, and the muscles of the leg present corresponding modifications. It is not without interest in the question of the affinities of the Marsupials to find that none of the analogous carnivorous, pedimanous, or rodent Placentals present this condition of the hind leg.

In the *Dasyurus macrurus*, the *plantaris*, instead of rising from the femur, has its fixed point in the fibula, from the head to half-way down the bone, fleshy; its tendon passes obliquely inwards and glides behind the inner malleolus to its insertion in the plantar fascia, so that it rotates the tibia inwards besides extending the foot. The *soleus* has an extensive origin from the proximal to near the distal end of the fibula. There are as usual three deep-seated muscles at the back of the leg. Of these three the muscle analogous to the *tibialis posticus* is readily recognized; its tendon glides

* Cuvier, loc. cit. p. 501.

† Ibid. p. 502.

behind the inner malleolus, and is inserted into the inner or tibial cuneiform bone.

The muscle which has the relative position and origins of the *flexor longus pollicis*, sends its tendon by the usual route to the sole of the foot, where it divides and distributes a flexor tendon to all the toes except the rudimental hallux; it has the same disposition in the Opossums, where the hinder thumb or great toe is fully developed; for this modification, however, the Comparative Anatomist is already prepared by meeting with it in the first step from man, viz. in the Chimpanzee and Orang.*

The third deep-seated muscle, being situated internal to the two preceding ones, may be the analogue of the *flexor digitorum communis longus*; it nevertheless sends no tendon to the toes nor even to the tarsus, but its fibres pass from the tibia obliquely outwards and downwards between the preceding muscle and the interosseous ligament to the fibula, where they are exclusively inserted so as to oppose the plantaris and rotate the foot outwards. This muscle closely adheres to the interosseous fascia, and thus resembles in its attachments the pronator quadratus of the fore limb: it is most developed in the pedimanous climbing Marsupials, where the rotation of the foot is more extensive and more useful.

The subjoined illustration (fig. 113) of this modification of the muscles of the hind-foot is taken from a dissection of the *Phalangista vulpina*, which very closely accords with that above described in the *Dasyurus macrurus*: *a*, expanded tendon of the *sartorius*; *b*, *gracilis*; *c*, *semitendinosus*; and *d*, *semi-membranosus*; both these muscles are inserted, as in many other quadrupeds, low down the tibia: *e*, *gastrocnemius*; *f*, *plantaris*; *g*, the analogue of the *flexor longus pollicis pedis*; *h*, *tibialis posticus*; this muscle divides and is inserted by two tendons, *k* and *h'*, into the internal and middle cuneiform bones: *i*, the rotator muscle of the tibia, probably a modification of the *flexor digitorum communis pedis*; its fibres descend obliquely from the fibula *p* to the tibia *t*.

In the muscles on the anterior part of the leg I observed no peculiarity worthy of notice; the *extensor brevis digitorum* has, however, its origin extended into this region and is attached to the outside of the fibula. There are three *peronei*; the external one is inserted into the proximal end of the fifth metatarsal: the tendon of the middle peroneus crosses the sole in a groove of the cuboid like the peroneus longus: the internal peroneus is an extensor of the outer or fifth toe. The *Perameles lugotis*, among the Saltatorial Marsupials, presents a different condition of the extensors of the foot from that above described. The *gastrocnemii*, *soleus*, and *plantaris* all arise above the knee-joint, and the tendon of the plantaris, after sheathing the tendo Achillis and traversing the long sole, is finally inserted into the base of the metatarsal bone of the fourth or largest toe; thus this muscle, which is strongly developed, bends both this toe and the knee, while it extends the foot.

* Zoolog. Proceedings, 1830, p. 59.

Fig. 113.



Muscles of leg, *Phalangista vulpina*.

NERVOUS SYSTEM.

The brain bears a smaller proportion to the body in the Marsupials than in any other order of Mammals: thus, in the Ursine Dasyure it is as 1 to 520, in the Wombat as 1 to 614, in the great Kangaroo as 1 to 800: it is relatively largest in the smaller species of Petaurists and Phalangers.

The Marsupial brain is also the simplest as respects its external form in the Mammiferous class. The cerebral hemispheres do not extend over the cerebellum in any of the species, and in some, as the Dasyures and Opossums, they leave the optic lobes exposed. The brain consists, as in other Mammalia, of a medulla oblongata with a pons Varolii, cerebellum (*d*, fig. 114), optic lobes, or bigeminal bodies, (*c*, fig. 114), cerebrum (*b*), to which may be added, on account of their large proportional size and distinct development, the olfactory lobes (*a*, *a*). In the Phalangers and Petaurists, the Opossums, Perameles, the insectivorous Phascogales, and the smaller Dasyures the surface of the cerebral hemispheres is smooth and unconvoluted. In the *Dasyurus ursinus* the complication of the cerebral surface is merely indicated by a few slight indentations; it is in the strictly herbivorous species as the Kangaroo (fig. 115) and Wombat, that the

Fig. 114.

Brain of *Dasyurus ursinus*.

hemispheres are penetrated by anfractuous fissures. In the Wombat a large longitudinal fissure bounds the outer side of the natiform protuberance and olfactory tract at the base of the brain; from the anterior moiety of this fissure three or four smaller ones curve upwards upon the sides of the hemispheres. On the upper surface a short transverse fissure marks off what may be regarded as the anterior lobe of the cerebrum, and behind this each hemisphere exhibits a few detached shallow fissures. In the Kangaroo (fig. 115) these fissures become continuous and are deeper; a long and nearly transverse anfractuousity divides the upper surface of the hemisphere; behind the shorter fissure which marks off the anterior lobe, and between the two transverse fissures there is a longitudinal one bounding a convolution that runs parallel with the median interspace of the hemispheres. The anterior lobes are also broken by small fissures; two or three long and moderately deep ones ascend upon the sides of the hemispheres (a), and the posterior portion (b) presents occasionally small detached fissures. So far therefore as the external surface is con-

Fig. 115.

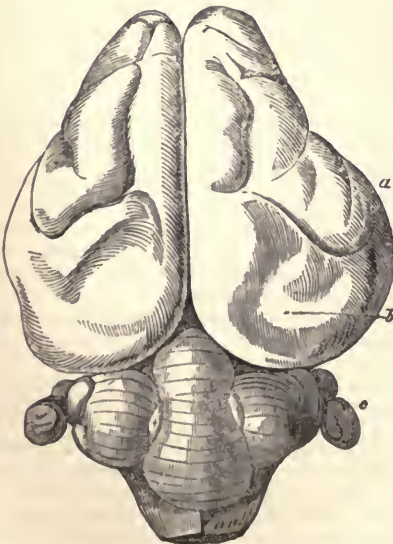
Brain of *Macropus major*.

cerned, the brains of the herbivorous Marsupials are more complicated than those of any of the Rodent Mammalia. The cerebellum presents the usual close-set, sub-parallel, transverse convolutions: it is remarkable for the large proportional size of the median or vermiform lobe, as compared with the lateral lobes, especially in the carnivorous and insectivorous Marsupials, where this condition is associated with a corresponding diminution of their commissural band or 'pons Varolii,' as is shown in the view of the base of the brain of an Opossum (fig. 116, b).

Fig. 116.

Brain of *Didelphys virginiana*.

In the Kangaroos, Perameles, Phalangers, and Koala the hemispheres or lateral lobes of the cerebellum are characterized by a small subspherical lateral process or appendage (c, c, fig. 115), which is lodged in a peculiar fossa of the petrous bone above the internal meatus: there are corresponding but less produced processes in the Dasyures and Opossums, but they are not developed in the Wombat. On the upper surface of the cerebellum the medullary substance appears superficially at a small tract between the vermiform processes, marked with an asterisk in figures 115 and 117. The simple disposition of the arbor vitæ is shown in fig. 118, f. Behind the pons Varolii are seen the two trapezoid bodies (c, fig. 116); and the corpora pyramidalia (d) are always clearly distinguishable from the corpora olivaria. The *crura cerebri*, which, in the Opossum (e, fig. 116) are left exposed below, like the optic lobes above, by reason of the small proportional size of the cerebrum, are more completely concealed in the brain of the Kangaroo and Wombat. The natiform protuberances form a great proportion of the under part of the cerebral hemispheres in all the Marsupials; their external boundary, which is basial in the Wombat and Kangaroo, runs along the side of the hemispheres to the outer side of the olfactory lobe in the Opossum. The inner root of the olfactory nerve forms a bulbous or ganglionic enlargement (fig. 116, * b). Behind the commissure of the optic nerves is seen a broad and short infundibulum supporting the pituitary gland (d, fig. 118), and posterior to this is the single corpus albicans. The optic lobes are solid, and are each divided by a transverse fissure, as in the Placental Mammalia; the anterior divisions or 'nates' (B, fig. 117) have a greater longitudinal diameter than the posterior ones or 'testes,' which have a greater transverse development. The difference in the relative development of the nates and testes is much less in the herbivorous and carnivorous Marsupials than in the corresponding Placental quadrupeds.

From the fact that the cerebral organ is that which exhibits the most marked degradation of structure in the class of warm-blooded Vertebrate animals which are characterized by an oviparous generation, I was induced to suspect, after having ascertained how closely the Marsupialia approached Birds in their mode of generation, that the brain might present in them some corresponding inferiority of structure, as compared with the Placental Mammalia.

The brain in the placental Mammalia is essentially characterized by the complexity and magnitude of the apparatus by which the hemispheres are brought into communication with one another. With respect to size, the cerebrum is in many species proportionally inferior to that of Birds; and in most Insectivorous and Rodent Mammalia it presents an equally smooth and uniform external surface; but notwithstanding the absence of convolutions and its diminished size, a large apparatus of medullary fibres is present, which connect together the opposite hemispheres, as well as the distant parts of the same hemisphere; and this apparatus, or great commissure, is superadded to the anterior, posterior, and soft commissures, which, with the exception of a very slight rudiment of the fornix, are alone developed in Birds for the purpose of uniting the opposite sides of the brain. In the higher Mammalia, in which the cerebral hemispheres acquire superior size and increased extent of surface by means of convolutions, the superadded commissural apparatus presents a corresponding development and a highly complicated structure; its several parts being distinguished as the corpus callosum, fornix, and their intercommunicating laminae, termed the septum lucidum.

The corpus callosum is the principal bond of union between the opposite hemispheres; it extends, as is well known, horizontally above the ventricles, its middle fibres passing transversely, while those of its extremities, which are more or less bent beneath its body, radiate, and all intermix, in apposition with the ascending and diverging fibres of the peduncles of the cerebral hemispheres. It has hitherto been considered as the great characteristic of the brain in the Mammalia, and, taking the human brain as the term of comparison, to be developed in the ratio of the magnitude of the cerebral hemispheres.

In the placental Mammalia this is a pretty accurate expression of the relations of the corpus callosum; and as the posterior lobes of the hemispheres are the first to disappear in the descending comparison, so the corpus callosum diminishes in longitudinal extent from behind forwards, and thus the corpora quadrigemina, pineal gland, and posterior part of the optic thalami are successively brought into view on divaricating the cerebral hemispheres in the different Mammalia, as the Rodentia, Cheiroptera, and Edentata, which exhibit this progressive degradation of the great commissure.

An attentive study of the manners of different Marsupials in confinement, and an inspection of the exterior forms of the brain in some of the species, induced me to allude, in

my paper on the generation of the Kangaroo,* to an inferiority of intelligence and a low development of the cerebral organ, as being the circumstances in the habits and structure of these singular animals, which were most constantly associated with the peculiarities of their generative economy. I have since derived the most satisfactory confirmation of this coincidence from repeated dissections of the brains of Marsupials belonging to different genera; and although unable to explain how a brief intra-uterine existence and the absence of a placental connexion between the mother and fœtus can operate (if it be really effective and any thing more than a relation of simple co-existence) in arresting the development of the brain, yet it is a coincidence which has not been suspected, and is, in various points of view, perhaps the most interesting of the anatomical peculiarities of the quadrupeds here treated of.

In order to obtain satisfactory proof of the difference in the structure of the brain in the marsupial and placental quadruped, I have dissected and compared together, step by step, the brains of a Wombat and Beaver. These animals are of nearly equal bulk, and manifest so many mutual affinities in their structure that they have been classed in the same order of Mammalia. The Wombat is, in fact, in all its exterior characters, save the marsupial and scrotal pouch, a Rodent; and in its internal anatomy, especially its digestive organs, more nearly resembles the Beaver than do many of the true Rodent animals. The brain of the Beaver was also preferred for this comparison of internal organization, because, on an outward inspection, it would be pronounced to be the less highly organized of the two; the hemispheres in the Wombat presenting a few convolutions, as before described, whilst in the Beaver they are perfectly smooth.

In the Beaver, however, the cerebrum is extended further backward, although it still leaves the cerebellum quite uncovered; while in the Wombat a portion of the optic lobes (corpora quadrigemina) is also exposed.

On divaricating the hemispheres of the brain in the Beaver we bring into view, about three lines below the surface, the corpus callosum; and on removing the cerebral substance to a level with this body, its fibres are observed to diverge into the substance of each hemisphere in the usual manner, some bending upwards, but a greater proportion arching downwards and embracing the cerebral nuclei; the anterior fibres radiating into the anterior, the posterior fibres into the posterior extremities of the hemispheres.

The portions of the brain which are removed in thus tracing the extent of the corpus callosum, bring into view the corpora bigemina and the pineal gland; but the optic thalami are concealed by the great commissure above described.

On separating the hemispheres of the brain of the Wombat, not only the bigeminal bodies (*B*, *fig.* 117.) and pineal gland (*u*, *fig.* 117.)

* Phil. Trans. 1334, p. 358.

but the optic thalami (*t, t, fig. 117*) are immediately brought into view, and instead of a

Fig. 117.

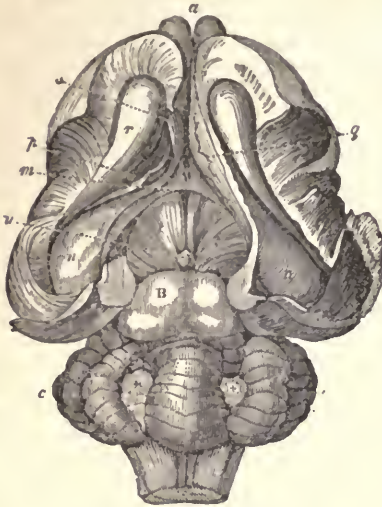

Phascolomys fusca.

broad corpus callosum, we perceive, situated deeply at the bottom of the longitudinal fissure, a small commissural medullary band, (*m, fig. 117*) passing in an arched form over the anterior part of the thalami, and extending beneath the overlapping internal or mesial surfaces of the hemispheres, (*q, fig. 117,*) which are thus, as in the Bird, disconnected with each other.

On gently raising the hemispheres from above the commissure and pressing them outwards with the handle of a scalpel, the instrument passes into the fissure upon which the hippocampus (*n, fig. 117*) is folded; and, on continuing the pressure, the hippocampus is torn through, and the lateral ventricle is exposed. The mesial wall of the hemisphere is continued from the superior and internal border of the hippocampus, and is composed in the Wombat, as in the Bird, of a thin lamina of medullary substance analogous to a detached layer of the septum lucidum. In the Kangaroo the mesial parietes of the lateral ventricles are stronger, being about two lines in thickness.

The posterior transverse fibres of the commissure are continued outwards and backwards beneath the more longitudinal fibres, which overlap them as they pass from the tæniæ hippocampi (*o, fig. 117*) forwards to the anterior cerebral lobes. All the fibres of the commissure pass along the floor of the lateral ventricles into the substance of the hippocampi majores, which are of proportionally very large size. Thus the commissure, which is brought into view on divaricating the cerebral hemispheres in the Wombat, is seen to be partly the bond of union of the two hippocampi majores in the transverse direction, and partly of the hippocampus and anterior lobe of the same hemisphere in the longitudinal direction. It also fulfils the other function of the fornix

by sending down from the inferior surface two small nerve-like processes, which extend vertically, behind the anterior commissure, through the substance of the optic thalami, near their mesial surfaces, to the corpus albicans, at the base of the brain.

The superior view of the connexions of the hippocampal commissure of the Wombat is given at *m, n, o, fig. 117*.

If in the Beaver's brain the posterior thickened margin of the corpus callosum be raised, it is observed at the middle of its inferior surface to be closely connected with the centre of a commissural band of fibres, arching over the anterior part of the optic thalami, and passing outwards and backwards along the floor of the lateral ventricles into the substance of the hippocampi, which are as largely developed as in the Wombat. The anterior part of the corpus callosum is bent downwards, and is attached along the middle line of its inferior surface by a uniting medium of medullary substance, representing the septum lucidum, to the hippocampal commissure or fornix; the tæniæ hippocampi extend forwards, as in the Wombat, into the anterior lobes.

The corpus callosum being removed, and the commissural fibres of the hippocampi being left behind, the view of the Beaver's brain now corresponds with that obtained in the previous dissection of the brain of the Wombat, which we regard, therefore, as wanting the principal mass of the corpus callosum, the septum lucidum, and consequently the fifth ventricle. The artery of the plexus choroides, (*p, fig. 117,*) in both the Beaver and Wombat, enters the lateral ventricle, where the hippocampus commences at the base of the hemisphere, and the plexus is continued along the under surface of the tænia hippocampi, and passes beneath the fornix, through the usual foramen, to communicate with its fellow in the third ventricle immediately behind the anterior crura of the fornix, which are sent down in the Beaver, as in the Wombat, from the centre of the inferior surface of the hippocampal commissure.

If we expose the lateral ventricle by removing its outer parietes in a marsupial and placental quadruped, as, for example, in the Kangaroo and Ass, the hippocampus major, the tænia hippocampi, the plexus choroides, and the foramen Monroianum are brought into view. If a style be thrust transversely through the internal wall of the ventricle, immediately above the hippocampus, in the placental quadruped, it perforates the septum lucidum and enters the opposite ventricle below the corpus callosum. If the same be done in the marsupial brain the style passes into the opposite ventricle, but is immediately brought into view from above by divaricating the hemispheres, and is seen lying above the fornix or commissure of the hippocampi.

This commissure may, nevertheless, be regarded as representing, besides the fornix, the rudimental commencement of the corpus callosum; but this determination does not invalidate the fact that the great commissure which unites the supra-ventricular masses in the Beaver, the Bat, and all other placentally developed

Mammalia, and which exists in addition to the hippocampal commissure, is wanting in the brain of the Wombat; and as the same deficiency exists in the brain of the Great and Bush Kangaroos, the Vulpine Phalanger, the *Parmeleus lagotis*, the Ursine and Mauge's *Dasyures*, and the Virginian Opossum, it is most probably the cerebral characteristic of the marsupial division of Mammalia.

In the modification of the commissural apparatus above described, the Marsupialia present a structure of brain which is intermediate between that of the placental Mammalia and Birds; as in the latter class the great commissure is wholly wanting, and the hemispheres, though comparatively larger than in many of the Mammalia, are brought into communication only by means of the anterior, posterior, and soft commissures, and by a slight trace of the fornix or hippocampal commissure.

Of the other peculiarities of the marsupial brain, the relatively large size of the anterior commissure (c, fig. 118) is most worthy of notice; its development corresponds with the large size of the cerebral ganglion, which

Fig 118.

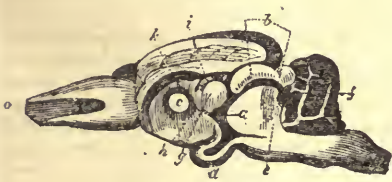
*Didelphus Virginiana.*

forms the chief origin of the olfactory nerve, and some of the anterior fibres of this commissure arch forwards, and are directly continued into those nerves.

In the position, superficial transverse fissure, and solidity of the bigeminal bodies, the marsupial brain adheres to the Mammiferous type, as also in the exterior transverse fibres of the commissure of the cerebellum, forming the pons Varolii, the presence of which relates to the development of the lateral lobes of the cerebellum.

In one of the latest published treatises on comparative anatomy, the *Lehrbuch der Vergleichenden Zootomie*, zweite auflage, 1834, of Carus, the first and chief structural characteristic of the brain in Mammalia is stated, as in the *Leçons d'Anatomie Comparée* of Cuvier, to be the presence of the corpus callosum.* The brain of the Rodentia is cited as the example of the transitional condition of this organ from Mammalia to Birds.† Besides the

* "Theils und vorzüglich werden sie in den durch eine neue grosse Commissur vereinigten," § 122, B. i. p. 77. "Die einzelnen Hirnmassen betreffend, so äussert sich, wie schon bemerkt, das Eigenthümliche der ersten, der Hemisphären, vorzüglich durch die Erscheinung des Balkens (corpus callosum) und des Gewölbes (fornix)."

† "Im allgemeinen bildet zur Hirnform dieser Klasse von der vorigen (der Vögel) die Gehirnbildung, wie sie in den Nagethieren (Rodentia) beobachtet wird, den deutlichsten Uebergang." Ibid. p. 77.

Rodentia, Carus afterwards states that the *Monotremata*, *Marsupialia*, and *Insectivora* (shrews, moles, and bats) also present the more simple form of brain among the Mammalia, "the hemispheres being of an ovate form contracted anteriorly, and their surface perfectly smooth, as in Birds, not extending over the cerebellum, and sometimes not over the corpora quadrigemina. Internally the great commissure is generally very short (in the Bats and Kangaroo hardly so long as the corpora quadrigemina, a structure which reminds one of that in Birds). The fold of the corpus callosum and the cornua ammonis (which Carus terms the processes of the corpus callosum in the ventricles) are commonly broad and large."* In illustration of this simple structure of the mammiferous brain Carus gives a figure of the brain of a Rodent, and from the whole description the reader is led to infer that the Rodent and Insectivorous placental Mammalia participate with the marsupial Mammalia in all the characters of the cerebral organization which approximate to those in Birds. Rudolph Wagner also describes the brain in the Rodentia, Cheiroptera, Edentata, and Marsupialia as being characterised by the small size of the corpus callosum,† which does not extend far back. It must not be supposed that the preceding quotations are adduced to detract from the merit of works whose reputation deservedly stands high. The position of the accomplished and indefatigable authors in a central town of Germany is unfavourable to the acquisition of specimens of animals which, like the Marsupialia, are almost confined to one of our most distant colonies; but it would be unpardonable in an English Comparative Anatomist, possessing the requisite opportunities of consulting nature, to content himself with copying the generalizations of foreign systematic writers, which, as regards the marsupial Mammalia, are liable to repose on so limited and imperfect an induction.

The Spinal Chord.—The spinal chord manifests all the usual Mammalian characters; the brachial and pelvic enlargements correspond with the relative size and muscularity of the extremities to which they furnish the nerves, the lumbar or pelvic enlargement is consequently most marked in the Kangaroo (fig. 119) and Potoroo, but does not exhibit the rhomboidal sinus which characterises this part of the chord in Birds. The disposition of the layer of

* "Die äussere gestalt der hemisphären ist in den Nagern, so wie in den Schnabel- und Beutelhieren, Spitzmäusen, Maulwürfen und Fledermäusen ein vorwärts sich verschmäerndes Eirund, und ihre Oberfläche, wie in Vogel vollkommen glatt; hinterwärts werden dadurch weder kleines Hirn, ja oft nicht einmal die Vierhügel bedeckt; innerlich ist die grosse Commissur (corpus callosum) gewöhnlich noch sehr kurz (bei den Fledermäusen und dem Känguruh kaum so lang als die Vierhügel, eine Bildung, so an die Vögel erinnert) der Umschlag des Balkens und Forsetzung desselben in die Seitenhöhlen (cornua Ammonis) vorzüglich breit und gros (f. v. e. g.," Ibid. § 124, p. 79.

† Der Balken ist noch schmal bei den Nagern, Fledermäusen, Edentaten und Beutelhieren und geht nicht weit nach hinten.—*Lehrbuch der Vergleichenden Anatomie*, p. 609, 1835.

Fig. 119.

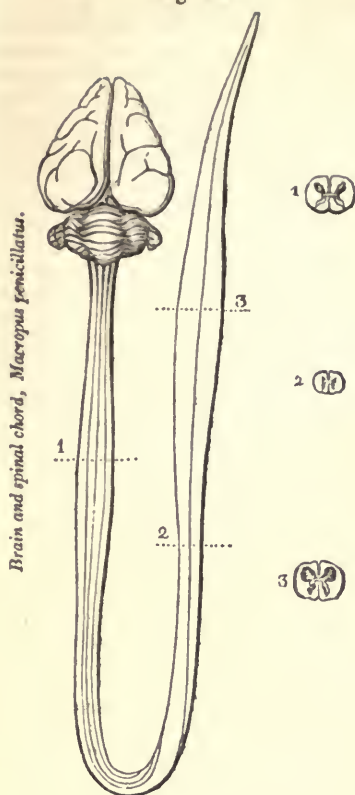

grey matter enveloping the central medullary tract in each lateral moiety of the chord is shewn in the three situations marked 1, 2, and 3 (fig. 119); the superior expansion and complexity of the grey matter in the anterior columns of the pelvic enlargement accords with the predominance of the locomotive over the sensitive function* in the strong saltatory hind legs of the Kangaroo.

Organs of Sense.—The olfactory nerves and the osseous cavities and laminae destined for the protection and support of the pituitary membrane offer a remarkable proportional development in all the Marsupials, and more especially in the Insectivorous and Carnivorous tribes. The outer root of the olfactory nerve appears as a continuation of the whole natiform protuberance; a corresponding accumulation of nervous matter, “protuberantia pyriformis,” † at the base of the inner root of the olfactory nerve has already been noticed; both these broad tracts consist externally of grey matter: the middle or medullary root of the nerve is the smallest. It is very conspicuous in the Wombat, where it emerges from a longitudinal fissure at the anterior and inner part of the “protuberantia natiformis.” The olfactory nerves or rather lobes are hollow, and contain, as in most Mammalia, the ante-

rior continuation or extremity of the lateral ventricles (*v*, fig. 118). The filaments pass from the skull through several foramina of a cribriform plate. Certain species of Kangaroo, of the subgenus *Osphranter*, Gould, remarkable for their acuteness of smell, have the turbinated bones so large that the lateral expansion of the nasal cavity forms a marked feature in the skull.

The chief deviation from the Mammalian type in the organ of hearing presents itself in the form of the stapes, the body of which is a simple elongated style either entirely, as the Perameles, or for half its length, as in the Kangaroo (fig. 120), where it divides into two short crura, before terminating in the base; it thus more or less approximates to the form of the columella in the bird.

Fig. 120.



Stapes of the Kangaroo.

The largest proportional external ears are those of the *Perameles lagotis*, the shortest those of the Wombat. The internal structure of the ear is not less strikingly developed in the *Perameles* than the outward appendages. The tympanic cavity is very extensive, but is formed, as in other Marsupials, by the sphenoid and petrous bones; the tympanic bone is limited to the function of supporting the ear-drum, and forming the internal commencement of the meatus auditorius externus. The internal extremity of the tympanic cylinder projects obliquely into the posterior and outer part of the sphenoidal bulla. The membrana tympani is a delicate transparent tissue, slightly concave internally, and having the long handle of the malleus (*a*, fig. 121) attached to it. This process of the malleus is bent upon itself at a right angle; the inner portion is broader and thicker than that which is attached to the membrana tympani, and it is ankylosed at its internal extremity by a thin and transparent plate of bone (*b*) to the side of the incus (*c*). This little ossicle, which here appears as a process of the malleus, presents a

Fig. 121.

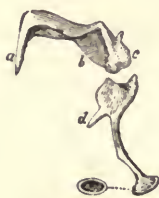

Auditory ossicles, Perameles.

notched articular surface for the orbicular end of the stapes. This portion of the stapes gives off a short slender process for the attachment of the stapedius (*d*), and then is continued in the form of a moderately long and slender columelliform shaft to the elliptical and slightly expanded base which closes the foramen ovale.

Organ of Vision.—The anatomy of the eye offers no peculiarity illustrative of the affinities of the Marsupialia or of any other speciality in their economy save the nocturnal habits of the majority of the order. It is in relation to these habits that the lens is large and convex, the iris broad, the pupil round and generally wide, and the cornea correspondingly large.

The Harderian gland and the retractor oculi co-exist, as usual in Mammalia, with the nictitating eyelid. This is always largely de-

* Mayo, *Outlines of Physiology*, p. 235. *Phil. Trans.* 1837, p. 93.

veloped, and the conjunctiva covering its free margin is stained black.

In the Kangaroo I found the dark pigment on both the inside and outside of the choroid, and the ciliary processes very well developed. The lens is proportionally large. In the dead Kangaroo the radiated muscle of the iris is much contracted, and the pupil widely open. Beneath the upper eyelid in the Kangaroo there is a cartilaginous ridge having the conjunctiva reflected over it.

Organ of taste.—The tongue is well developed and freely moveable in all the Marsupialia, and the epithelium covering the simple papillæ of its dorsum is never condensed into spines. In the carnivorous species, as the *Dasyuri*, the conical papillæ are minute and soft, but directed backwards so as to give a slight roughness to the tongue when stroked in the opposite direction. Under a lens they appear like fine shagreen. Near the base of the tongue in *Dasyurus viverrinus* there are three fossulate papillæ, in triangle, with the apex towards the epiglottis. There is a small *lytta* beneath the tip of the tongue.

In the *Perameles*, besides the minute and generally diffused simple papillæ, there are others of larger size, placed at distances of nearly a line apart, and raised about a third of a line above the surface of the dorsum. The fossulate or glandular papillæ correspond in number and arrangement with those of the *Dasyures*, but the entire tongue is relatively longer and more slender, especially in *Per. lugotis*.

In some species of *Opossum*, as *Didelphys Philander*, the margin of the tongue is fringed with a series of fine long papillæ.

In the *Phalangers* there is a thickening at the edge of the *frænnum linguæ*, but no true *lytta*. The dorsal papillæ resemble those of the *Dasyures*, but are somewhat more obtuse.

In the Kangaroo there is a callous ridge along the middle of the under surface of the free extremity of the tongue, and a corresponding furrow along the dorsum; the latter is common to all the Marsupials. In the *Wombat* and *Koala* the dorsum of the tongue rises somewhat abruptly from a furrow surrounding its base; its form is narrow, moderately deep, diminishing in this respect to the tip, which is rounded. In both the Kangaroo and *Koala* there is a single large fossulate papilla near the base of the tongue.

The palate is sculptured in most Marsupials with transverse ridges. These are most numerous in the *Bandicoots*, being fourteen in the *Perameles nasuta*, and are slightly curved forwards. The roughness thus produced must aid the tongue in retaining small insects.

DIGESTIVE SYSTEM.

Mouth.—The various modes of locomotion, resulting from the different modifications of the osseous and muscular systems observable in the several families of *Marsupialia*, relate to the acquisition of as various kinds of alimentary substances, which necessarily require for their assimilation as many adaptations of the digestive organs.

Food.—means of obtaining it,—instruments for preparing and mechanically dividing it,—cavities, canals and glands for chemically reducing and animalizing it,—form a closely connected chain of relationships and interdependencies. The usual sequence of anatomical description has here been followed in commencing with the consideration of the passive and active organs whose office it is to carry the stomach to the food and the food to the mouth, and we have now to describe the preparatory mechanical instruments in digestion, and the modifications and appendages of the alimentary canal.

The jaws of the Marsupialia are covered by well-developed fleshy lips; the upper lip is partially cleft in the Kangaroos, as in some of the *Rodents*; the muzzle is clad with hair in the Great Kangaroo and a few other species of *Macropus*, but in other Marsupialia it is naked and generally red from the vascularity of the integument.

The masticatory muscles of the jaws consist in the Marsupial, as in other *Mammalia*, of the temporal, the masseter, the external and internal pterygoids, and the digastricus. They are chiefly remarkable for the large proportional size of the masseter and internal pterygoid; the great development of the latter muscle is constant in all the Marsupials, and is the condition of the peculiarly large and inflected angle of the lower jaw. The relative size of the masseter, as compared with the temporal muscle is greater in the herbivorous than in the carnivorous species, but this difference is much less in the Marsupial than in the corresponding placental genera. The extent of origin of the *temporal muscle* is indicated by the various conditions of the temporal and parietal crests; the inner surface of the zygomatic arch always affords origin to a portion of the fibres of this muscle, and in some species, as in the *Koala*, to all that portion of it which is inserted into the external fossa of the coronoid process and ascending ramus of the jaw, the fibres from the temporal and parietal bones being implanted on the inner side of the coronoid process. The *masseter* takes its origin by a strong band of tendinous and carneous fibres from the inferior and anterior part of the zygoma; the muscle expands as it is directed backwards, and is inserted into the ridge which bounds the external temporal fossa of the ascending ramus, and into the outer side of the inflected angle of the outer jaw. The *external pterygoid* takes its origin from the temporal plate of the sphenoid and the base of the pterygoid plate anterior to the sphenoidal bulla; the fibres converge to be implanted into the inner projecting side of the condyle of the jaw. The *internal pterygoid* arises from the outer depression of the longitudinally extended pterygoid plate already mentioned as characterizing the cranial structure of the Marsupials, and is implanted along the inner surface of the inflected angle of the jaw. The *digastricus* arises from the ex-occipital process; its fibres expand, and are inserted into the lower margin of the maxillary ramus, anterior to the commencement of the inflected

angle of the jaw. The preceding description is taken from a dissection of the Koala. The masticatory muscles of the Wombat differ only in their relative proportions; the masseter in this gliriform Marsupial is single, presenting no trace of that subdivision and modified attachments which adapt it to the protraction of the lower jaw in the true Rodents, and accordingly the structure of the joint of the lower jaw of the Wombat exhibits, as already described, a corresponding difference from the Rodent type.

There is no toothless genus among the true Marsupials, unless the Monotremes which represent the Edentate order of the Placental Mammalia be regarded as modified Marsupials. Molar and incisor teeth are present in both jaws in every true Marsupial species; the canines are but feebly represented in many, as the Phalangers, Petaurists, &c. are wanting in the lower jaw in the Potoroos and Koala, and in both jaws in the Kangaroos and Wombat. The grinders, on the other hand, present their most complicated structure in these last cited herbivorous genera.

The Dasyures and Thylacine offer the carnivorous type of the dental system, but differ from the corresponding group of the Placental Mammalia in having the molars of a more uniform and simple structure, and the incisors in greater number; which number, however, is different in the different Marsupial carnivorous genera, as is expressed in the dental formulæ already given.

The canines are as formidable for their size, shape, and strength in the Thylacine and Ursine Dasyure, as in the Dog or Cat, and in a fossil species of the latter genus (*Dasyurus lanianus*),* which co-existed, in ancient Australia, with herbivorous Marsupials of greater size than now inhabit that continent, these teeth were as large as in the Leopard. In the Thylacine the points of the lower canines are received in hollows of the intermaxillary palatal plate when the mouth is closed, and do not project, as in the carnivorous placental, beyond the margins of the intermaxillaries.

In some of the smaller species of the carnivorous group, as the *Phascogales*, the canines lose their great relative size, and the molar teeth present a surface more cuspidated than sectorial: there is also an increased number of teeth, and as a consequence of their more equable development they have fewer and shorter interspaces. Thus the *Phascogale penicillata* has, as Mr. Hunter observed, "a mouth full of teeth," and these are adapted for the capture and mastication of insects and other small and low organized animals.

In the Opossums the canines still exhibit a superior development in both jaws adapted for the destruction of living prey, but the molars have a conformation different from that which characterises the true flesh-feeders, and they consequently subsist on a mixed diet or lower organized animals; some, as the web-footed *Cheironectes*, betake themselves to the water,

and prey, like the otter, on fish; others prowl about the sea-shore and subsist on crustacea, as the *Didelphys cancrivora*.

The *Perameles* are for the most part insectivorous; the incisors are always very small, the molars generally multicuspidate; some species, as *Per. nasuta*, have the canines not more developed than the premolars, which they closely resemble; but in others, as the *Per. lagotis*, they are proportionally as large as in the Opossums, and the inferior ones are concealed in the same position when the mouth is closed, as in the Thylacine. But the *Per. lagotis*, instead of exhibiting a corresponding approach in the structure of the molars to a carnivorous diet, have these unerring indicators of the nature of the food terminated by a broad oblique flattened surface, adapted to the trituration of farinaceous vegetable roots, the destruction of which is confidently attributed to this species of Bandicoot by the colonists of Swan River. The interesting genus *Myrmecobius* offers, in the small size and scattered distribution of its teeth, the nearest approach among the Marsupials to the edentate group of the Placental Mammalia; the multicuspidate structure of the molar teeth, and their small size, indicates that the *Myrmecobius* feeds chiefly on the weaker insects which are implied by its generic name. It is important to notice that in many of the Marsupials there is an inconstancy in the number of teeth in species of the same genus, and sometimes even in individuals in the same species; this at least appears to be the case in the *Myrmecobius*, in which, of three specimens examined, identical in all other respects, one had forty-eight, the other fifty-two, and the third fifty teeth. We have already pointed out the variety which obtains in the spurious and true molars of the Phalangers and Petaurists. The prominent feature in the change from the carnivorous to the herbivorous type of dentition is the inordinate development of the two middle incisors of the lower jaw, at the expense, as it would seem, of the posterior ones. In the *Phalangista Cookii*, e. g. six incisors are always present in the lower jaw, but only the first two have any functional character: the canine tooth again offers neither a form nor size by which it can be distinguished from the spurious molars; in the other Marsupials with the same characteristic modification of the hinder feet, including the Petaurists with the Phalangers, the small posterior incisors are wanting wholly or in part; the canines seem also to be lost, and the spurious molars are fewer, but variable in number. This inconstancy is not to be wondered at in teeth which have too simple a form and too insignificant a size to exercise any influence on the habits and economy of the species; and it would seem to be lost labour in the zoologist to attempt to found generic distinctions, and invent new names for the species in which these insignificant varieties are presented. The six incisors of the upper jaw and the two anterior ones in the lower jaw, with the true molars in both jaws, present a constancy of character and a functional importance in their development in all the *Phalangers* and *Petaurists*. These teeth

* See Major Mitchell's Australia, vol. ii.

are adapted, the first for cropping the foliage of the gum-trees (*Eucalypti*) and similar trees, and the others for bruising and masticating the same. The grinding surface of the molars generally presents four blunt tubercles.

The *Koala* resembles in its dentition and in its diet and arboreal life the Phalangers and Petaurists. In the lower jaw the absence of teeth between the two large procumbent incisors and the false molars is constant; in the upper jaw, however, the lateral or posterior incisors begin to exhibit the same diminution of size as the corresponding teeth in the lower jaw of some of the Phalangers, while the two anterior upper incisors present a proportional increase; the canines correspond in feebleness and form with the small incisors. In the Wombat, the defective development to which the teeth between the incisors and molars are subject in the Marsupial tribe, has reduced the dental formula of both jaws to the rodent type; but the shape, comparative shortness, and procumbent position of the two large inferior incisors, and the three-sided figure of the opposing pair above, bespeak the marsupial character of which this genus offers so extreme a modification. The grinders, however, agree with those of the herbivorous rodents in the absence of fangs, arising from the uninterrupted growth and ossification of their formative pulps; they offer also in both jaws an extreme degree of the curvature which characterises the molars of some herbivorous Rodents, as the Guinea-pig, and the great extinct gliriform *Pachyderm*, called *Toxodon*; but their chief distinctive peculiarity is the marsupial excess of number already mentioned.

With respect to the modifications of the teeth of the herbivorous Marsupials, it need only here be observed that the grinding surface of the true molars in the Kangaroos most resembles that which characterizes the same teeth in the Tapir, Dinothera, and Manatee.

No Marsupial possesses teeth composed of an intermixture of layers of dentine, enamel and cement throughout the crown, but the external layer of coronal cement is very conspicuous in transverse sections of the teeth of the Marsupials, viewed with the microscope, and forms a thick layer on the outside of the crowns of the teeth in the genera *Macropus*, *Phascolarctus*, and *Phascolomys*.

The modifications of the tongue and soft palate have already been noticed. In two species of Marsupials I have detected cheek-pouches. In the *Koala* they are wide and shallow, situated one on each side of the upper lip; the orifice is opposite the first superior premolar, and leads forwards above a horizontal fold of the mucous membrane which attaches the upper lip to the side of the intermaxillary bone, separating this part of the cheek-pouch from the mouth. In the *Perameles lagotis* there are also two small fossæ, one on the inside of each cheek, about four lines in diameter, and lined by a very distinct white epithelium.

The fauces are wide in the Zoophagous, but narrow in the Entomophagous and Phytophagous Marsupials.

Alimentary canal.—The *œsophagus* in passing

through the chest recedes from the spine as it approaches the diaphragm, and is loosely connected with the bodies of the dorsal vertebræ by a broad duplication of the serous membrane of the posterior mediastinum. In the Phalangers the *œsophagus* terminates in the stomach almost as soon as it has pierced the diaphragm; in the *Opossums* it is continued some way into the abdomen; in the *Didelphys Virginiana*, for example, for the extent of an inch and a half; in *Did. brachyura*, for half an inch. In the Kangaroos the abdominal portion of the *œsophagus* is of still greater extent; I have observed it five inches long in a male *Macropus major*.

The inner surface of the *œsophagus* is generally smooth, or disposed in fine longitudinal plaits; but in the Virginian *Opossum* the terminal part of the *œsophagus* presents many transverse folds of the lining membrane analogous to, but relatively larger than those in the Lion and other *Felines*. I have not met with a like structure in the Phalangers nor in any other genus of Marsupials; what is more remarkable is that the transverse *œsophageal rugæ* are not developed in the carnivorous *Dasyures* or *Phascogales*, where analogy would lead one to expect them, rather than in the insectivorous *Opossums*.

The *stomach* presents three leading modifications of structure in the Marsupialia; it is either simple, as in the Zoophagous, Entomophagous, and Carpophagous tribes; or is provided with a cardiac glandular apparatus, as in the *Koala* and *Wombat*; or is complicated by sacculi, as in the *Poephagans*.

It might have been expected that the stomach would have exhibited some modifications in the development of the left or cardiac extremity corresponding with the differences of food and dentition observable in the large proportion of the Marsupial order, in which this viscus presents its simple condition; but this is not the case: the form of the stomach is essentially the same in the carnivorous *Dasyure*, the insectivorous *Bandicot*, and the leaf-eating Phalangers. It presents a full, round, ovate, or sub-triangular figure, with the right extremity projecting beyond and below the pylorus; the longitudinal diameter seldom exceeds the vertical or transverse by more than one-third; often, as in *Phascogale* and *Dasyurus viverrinus*, by only one-fourth of its own extent; and the *œsophagus* enters at the middle of the lesser curvature, or sometimes nearer the pylorus, but always leaves a large hemispherical cul-de-sac on the left side. Daubenton has given illustrations of this characteristic form of the stomach in different species of *Didelphys*; it is here figured as it exists in the *Phascogale* (*fig. 122*). The stomach is relatively much more capacious in the carnivorous Marsupials than in the carnivorous Placentals. Some slight modifications occur in the disposition of the lining membrane; thus in the *Phascogale* I observed a series of very thick *rugæ* radiating from the middle of the upper part of the caecal end of the stomach, some of which were continued along the lesser curvature to the pylorus. Dr. Grant found, in the *Perameles nasuta*, that “the

Fig. 122.

Alimentary canal, *Phascogale flavipes*.

internal surface of the left cul-de-sac was quite smooth and villous (?), while the right half of the stomach was entirely covered internally with rugæ, running chiefly in a longitudinal direction, and particularly numerous towards the pylorus.”*

The stomach in the Wombat and Koala does not materially differ in external figure from that of the above-cited Marsupials; the œsophagus terminates nearly midway between the right and left extremities, but further from the pylorus in the Wombat than in the Koala. The conglomerate gastric gland is of a flattened ovate form, relatively larger in the Wombat than in the Koala, situated to the left of the cardiac orifice, at the lesser curvature of the stomach (fig. 123). The gastric gland has a similar position in the

Fig. 123.

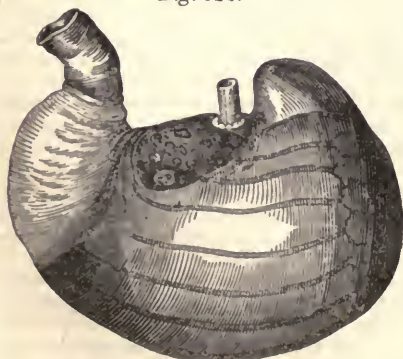

Stomach of the Wombat, inverted.

* Wernerian Transactions, vol. vi. p. 109.

Beaver, but in this animal the excretory orifices of the gland are arranged in three longitudinal rows, while in the Wombat and Koala they are scattered irregularly; in the Wombat they are about thirty in number, and the bottoms of the larger depressions are subdivided into smaller cells. In the partially contracted state the inner membrane of the stomach of the Wombat, as represented in the figure, is disposed in pretty regular longitudinal rugæ, which gradually subside towards the pylorus; but when the stomach is distended these folds disappear, and the left extremity presents a full globular form. In the Wombat dissected by me the œsophagus terminated nearer the pylorus than is represented in the figure here given from the Comparative Anatomy of Sir Everard Home.

The sacculated stomach of the Kangaroo, which offers the extreme modification of this organ in the Marsupial order, resembles the human colon both in its longitudinal extent, structure, and disposition in the abdomen. The natural relative position of this singular viscus is, however, very different from that described by Sir Everard Home,* who evidently has taken his account from the drawing by Mr. Clift, from which our fig. 124 is taken: the object of this drawing, however, being to portray the modifications of the inner surface of the Kangaroo's stomach, it is artificially disposed accordingly. In a full-grown female Kangaroo (*Macropus major*), I found the abdominal œsophagus four inches long, and terminating at six inches distance from the left extremity of the stomach: this extremity was folded forwards and to the right in front of the œsophagus; from the basis of the left cul-de-sac the stomach continued to expand, and descended into the left lumbar and iliac regions, whence it stretched upwards and to the right side obliquely across the abdomen, to the right hypochondrium, where it became contracted

Fig. 124.

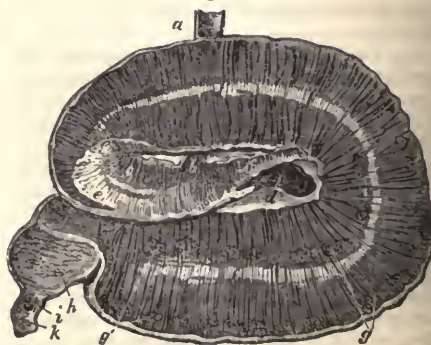

Stomach of the Kangaroo.

and finally bent downwards and backwards to terminate in the duodenum. The whole length of the stomach, following its curvatures, was three feet six inches, equalling that of the animal itself from the muzzle to the vent.

* Lectures on Comp. Anatomy, i. p. 156.

The stomach of the Kangaroo may be regarded as consisting of a left, a middle, and a right or pyloric division. The left extremity of the stomach is bifid, and terminates in two round cul-de-sacs. The sacculi of the stomach are produced, like those of the colon, by three narrow longitudinal bands of muscular fibres, which gradually disappear, together with the sacculi at the pyloric division. One of the longitudinal bands runs along the greater curvature, at the line of attachment of the gastro-colic omentum; the others commence at the base of the left terminal pouches, and run, one along the anterior, the other along the posterior side of the stomach: the interspace, between these bands, forming the lesser curvature of the stomach, is not sacculated. The largest of the two terminal sacculi (*d*, fig. 124) is lined with an insulated patch of vascular mucous membrane, which is continued for the extent of five inches into the cardiac cavity; the epithelium is continued from the œsophagus in one direction into the nearest and smallest sacculus, and extends in a sharp-pointed form for a considerable distance in the opposite direction into a series of sacculi in the middle compartment of the stomach (*c*): this epithelium is quite smooth. The vascular mucous surface recommences by a point at the great curvature, near the beginning of the middle compartment, and gradually expands until it forms the lining of the whole inner surface of the right half of the stomach. Three rows of clusters of mucous follicles (*g, g*) are developed in the mucous membrane of the pyloric half of the middle compartment; they are placed parallel with the longitudinal muscular bands: about fifteen patches are situated along the greater curvature, and there are nine in each of the anterior and posterior rows. These glandular patches disappear altogether in the pyloric compartment of the stomach, where the lining membrane is thickened, and finely corrugated; but immediately beyond the pylorus there is a circular mucous gland three-fourths of an inch broad: the non-sacculated pyloric division of the stomach was five inches in length.

In the smaller species of Kangaroo the stomach is less complicated than in the *Macropus major*; the number of sacculi is fewer: in *Macropus Parryi*, Ben. the third longitudinal band at the great curvature of the stomach is almost obsolete: in the Brush-tailed or Rock Kangaroo, (*Macropus penicillatus*,) the cardiac extremity terminates in a single sub-clavate cul-de-sac. In all the species which I have examined the œsophagus terminates in the middle division of the stomach, close to the produced crescentic fold which separates it from the cardiac compartment. In the great Kangaroo a second slighter fold is continued from the right side of the cardiac orifice parallel with the preceding, and forming with it a canal, somewhat analogous to that in the true ruminating stomachs, and along which fluids, or solid food not requiring previous preparation in the cardiac cavity, might be conducted into the middle compartment.

I have more than once observed the act of rumination in the Kangaroos kept in the Viva-

rium of the Zoological Society. It does not take place while they are recumbent, but when the animal is erect upon the tripod of the hind legs and tail. The abdominal muscles are in violent action for a few seconds, the head is then a little depressed, and the cud is masticated by a rapid rotatory motion of the jaws. This act is by no means repeated in the Kangaroos with the same frequency or regularity as in the true Ruminants. A fact may, however, be noticed as an additional analogy between them; balls of hair, cemented by mucus, adpressed and arranged in the same direction, are occasionally formed in the stomach, of which I have met with two, of an oval shape, in the *Macropus Parryi*.

In the genus *Hypsiprymnus* the stomach is as singularly complicated as in the Kangaroos, and the complication is essentially the same in both; arising from the sacculation of the parietes of a very long canal by a partial disposition of shorter bands of longitudinal fibres; but in the Potoroos this sacculation is confined to that part of the stomach which lies to the left of the œsophagus, while the right division of the cavity has the ordinary form and structure of the pyloric moiety of a simple stomach. The left or cardiac division is enormously developed; in relative proportion, indeed, it is surpassed only by the true ruminant stomachs, in which both the rumen and reticulum are expansions of the corresponding or cardiac moiety of the stomach. The relation of the stomach of a Potoroo to that of a Kangaroo may be concisely expressed by stating that the termination of the œsophagus in the former is removed from the commencement of the middle sacculated compartment to its termination.

When fluid is injected into the stomach of a dead Potoroo, it distends first the pyloric division; it is probably by a kind of antiperistaltic action that the aliment is propelled into the long sacculated œcum to the left of the œsophagus.

The modifications of the *epiploon*, as an appendage to the stomach, may here be noticed. In the Kangaroo it is of very moderate size, being continued loosely from the stomach to the transverse colon, but not extended beyond that part. The posterior layer lies between the stomach and the intestines, and affords a good illustration of one of the uses of the epiploon, as it evidently prevents these parts from interfering with each other's motions. The anterior layer generally contains more or less fat. In the *Petaurus* the great omentum is continued from the great curvature of the stomach, and the commencement of the duodenum. In the *Phalangers* it is of considerable extent, and is usually loaded with fat. In the *Opossums* I have found it generally devoid of fat, when this substance has been accumulated in other parts. In the *Phascogales* and *Dasyures* the epiploon is of moderate size, and contains little or no fat.

Having seen that, with the exception of the Potoroos and Kangaroos, the stomach is simple in the *Marsupialia*, presenting only some additional mucous glands in the Koala and Wom-

bat, it is to the succeeding parts of the alimentary canal that we have to look for those modifications which should correspond with a vegetable, a mixed, or an animal diet; and never perhaps was a physiological problem more clearly illustrated by comparative anatomy than is the use of the cæcum coli by the varying conditions which it presents in the present group of Mammalia.

In the most purely carnivorous group of the Marsupial order the stomach presents in the magnitude of the left cul-de-sac a structure better adapted for the retention of food than we find in the stomachs of the corresponding group in the placental series. In the most strictly carnivorous *Feræ*, as the cat-tribe, there is a cæcum, though it is simple and short; but in the Marsupial Zoophaga this part is entirely wanting, and the intestinal canal, short and wide,* is continued, like the intestine of a reptile, along the margin of a single and simple mesentery from the pylorus to the rectum.

In the Entomophagous Marsupials, some of which are suspected with reason to have a mixed diet, the intestinal canal is relatively longer; the distinction of small and large intestine is established; and the latter division commences with a simple, moderate-sized, sub-clavate cæcum.

In the Carpophagous Phalangers, whose stomach resembles that of the predatory *Dasyure*, the compensation is made by a longer intestine, but principally by the extraordinary length of the cæcum, which in some species is twice that of the body itself.

Lastly, in the Koala, which is, perhaps, a more strictly vegetable feeder than the *Petaurists* or *Phalangers*, the cæcum is more than three times the length of the animal, and its essential part, the inner secreting membrane is farther augmented by about a dozen longitudinal parallel, or nearly parallel, plaits, which are continued from the colon three-fourths

of the way towards the blind extremity. When we reflect that the Sloth, which has the same diet and corresponding habits with the Koala, has a singularly complicated stomach, but no cæcum, the vicarious office of this lower blind production of the digestive tube as a subsidiary stomach is still more strikingly exemplified. What then, it may be asked, is the condition of the cæcum in the Marsupials with enormous sacculated stomachs? It is in these species comparatively short and simple. In the *Potoroos* which scratch up the soil in search of farinaceous roots, it is much shorter than in the great Kangaroos which browse on grass. There is a slight tendency to sacculation at the commencement of the cæcum in the latter Marsupials, by the development of two longitudinal bands (fig. 127).

In the Wombat the cæcum is extremely short, but wide; it is remarkable for being provided with a vermiform appendage.

In this animal, however, the colon is relatively longer, larger, and it is puckered up into sacculi by two broad longitudinal bands. In the specimen dissected by me, one of these sacculi was so much longer than the rest as to almost merit special notice as a second cæcum.

The most interesting peculiarity which the Zoophagous Marsupials exhibit in the disposition of their simple intestinal canal, consists in its being suspended from the very commencement of the duodenum on a simple and continuous mesentery, like the intestine of a carnivorous reptile. The duodenum makes the ordinary fold on the right side, but it is not tied to the spine at its termination; the commencement of the jejunum may, however, be distinguished by a slight twist of the mesentery, and a fold of peritoneum is continued from the lowest curve of the loop of the duodenum to the right iliac region, as in the Kangaroos. The intestine is a little narrower at its middle part than at its two extremes; the tunics increase in thickness towards the rectum. There is a zone of glands at the commencement of the duodenum.

In the *Entomophaga* the duodenum is tightly connected to the spine, where it crosses to be continued into the *jejunum*: from this part the mesentery is continued uninterruptedly along the small intestines and colon to the rectum; so that although the cæcum is generally found on the right side, its connections are sufficiently loose to admit of a change of position.

In the *Petaurus pygmaeus* the duodenum is attached to the spine as in the *Opossums*, but it is not tied down to the right iliac region by

Fig. 125.



Cæcum of an Opossum.

Fig. 127.



Cæcum of the Kangaroo.

Fig. 128.

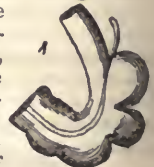

Cæcum of the Wombat.

Fig. 126.

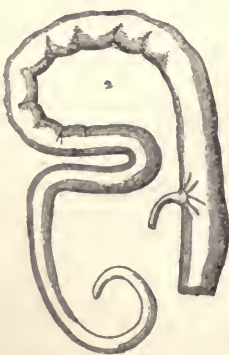

Cæcum of the Koala.

* The jejunum, in the *Thylacine*, has a diameter of two inches and a half.

a fold of peritoneum continued from the convexity of its depending curve. I found the cæcum in this species disposed in a spiral curve in the left lumbar region; the colon ascended a little way in front of the stomach, receiving a branch of the superior mesenteric artery, and was then continued straight down to the anus; thus we are again reminded of the oviparous character by the shortness of the large intestine.

In the *Pet. taguanoides* the duodenum is tied down to the iliac region, as in the *Dasyure*; the cæcum is four inches long, and the colon is relatively longer than in the *Acrobates*; it makes the tour of the abdomen much as in man, but is continued into the rectum without forming a sigmoid flexure.

In the *Phalangers* the duodenum winds round the root of the mesentery, descending pretty low down on the right side, and becoming a loose intestine or jejunum on the left side. The long cæcum is suspended by a broad duplicature of peritoneum continued from the mesocolon; and the colon is closely attached at its transverse arch to the duodenum and root of the mesentery.

In the *Koala* the cæcum and large intestines arrive at their maximum of development. The duodenum commences with a small pyriform sacculus nearly an inch in breadth, and soon contracts to a diameter of five lines, which is the general calibre of the small intestines. The large intestines, where the ilium terminates, have a diameter of two inches. The end of the ileum (*a*, fig. 129) protrudes for the extent

Fig. 129.

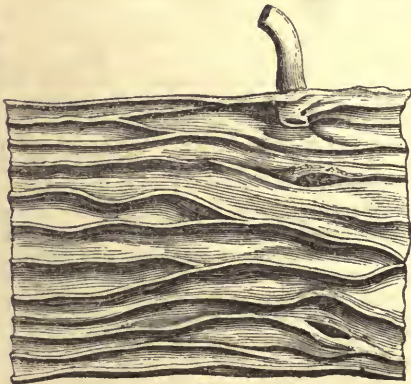

Ileo-cæcal valve, *Koala*. Half its natural size.

of a quarter of an inch within the cæcum, forming a very effectual valve: near this part there are two wide and deep glandular fossæ: the longitudinal valvulæ conniventes of the large intestines have already been noticed.

In the *Potoroos* the small intestines are disposed nearly as in the *Phalangers*: the short and wide cæcum lies in the right hypogastrium: the colon makes the usual tour of the abdomen,

but is disposed in long convolutions through its whole course, being suspended on a broad mesocolon. The diameter of both small and large intestines is nearly the same: in *Hyps. setosus* I found this to be half-an-inch.

In the great *Kangaroo* the descending portion of the duodenum is attached posteriorly, by means of a thin peritoneal duplicature, to the spine, and anteriorly to the ascending colon: it makes an abrupt turn upon itself, and a fold of peritoneum is continued from the convexity of the curve to the right iliac region. The small intestines are strung in short folds on a rather narrow mesentery. The cæcum is in part suspended from the same mesenteric fold. The colon, besides its posterior connexions with a mesocolon, is attached, as before observed, to the duodenum; and also, by means of the great omentum, pretty closely to the stomach, whence it passes down, forming many large and loose convolutions to the rectum, being attached by a broad mesocolon to the left hypochondriac region.

The zone of glands at the commencement of the duodenum has been already noticed; they are present in other Marsupials, even in the most carnivorous species; but I have not met with a similar structure in the placental Mammalia. The villi of the small intestines in the *Kangaroo* are of moderate length, compressed and close-set. Glandulæ aggregatæ are arranged in narrow patches in the ileum. There are seven groups of similar follicles in the cæcum; and a few long and narrow patches of glands occur in the colon intermingled with numerous glandulæ solitariae; the surface of the rest of the lining membrane of the large intestine is disposed in a very fine net-work.

Two faint longitudinal bands extend along the first ten inches of the colon and are continued along two-thirds of the cæcum: the sacculi produced by these bands are but very feebly marked. I have not met with any example in the *Macropus major* of a cæcum, which, either naturally or when inflated and dried, presented the sacculated structure represented by Cuvier in fig. 8, pl. xxxix. of the *Leçons d'Anat. Comparée*.

The contents of the cæcum in the great *Kangaroo* are of a pultaceous consistence, and the mass continues undivided along the first two feet of the colon, gradually becoming less fluid and then beginning to be separated into cubical fæces about an inch square. The diameter of the large intestine in this species exceeds very little that of the small intestines.

In all the Marsupials two sebaceous follicles open into the termination of the rectum. The anus has its proper sphincter, but is also surrounded, in common with the genital outlet, by a larger one. When the penis is retracted, the fæcal, urinary, and genital canals all terminate within a common external outlet; so that in the literal sense the Marsupials are monotrematous.

The following is a table of the length of the intestinal canal, and its parts in a few species of the different families of Marsupialia.

Table of the length of the intestinal canal as compared with the body.

SPECIES.	Body from snout to vent.		Intestinal canal with cæcum.		Small intestines.		Large intestines.		Cæcum.	
	Ft.	Inch.	Ft.	Inch.	Ft.	Inch.	Ft.	Inch.	Ft.	Inch.
<i>Thalacynus Harrisii</i>	3	4	9	8						
<i>Phascogale flavipes</i>	0	5	0	14						
<i>Dasyurus macrurus</i>	1	4	5	0						
<i>Perameles nasuta</i>	1	4	3	5	2	5	0	9	0	3
<i>Didelphys Philander</i>	0	9	3	5	1	11	1	2½	0	4
<i>Petaurus pygmaeus</i>	0	2½	0	6½	0	5	0	0½	0	1
<i>Phalangista vulpina</i>	1	8	24	10	11	0	9	0	4	10 ³
<i>Ditto</i>	1	7	18	8	9	9	6	10	2	1
<i>Phuscolarctos fuscus</i>	1	11	24	0	7	8	10	5	6	5
<i>Hypsiprymnus setosus</i>	1	0	5	0	2	5	2	6	0	2
<i>Macropus major</i>	3	3	32	0	22	0	9	0	1	8
<i>Phascolumys Vombatus</i>	2	6	25	6	11	3	14	2	0	1†

Salivary glands.—These glands in the Carnivorous Dasyures consist of a small parotid and a large submaxillary gland on each side. I searched expressly, but in vain, for the zygomatic gland; the Dasyures do not agree with the dogs in having these glands. They have no sublingual gland. The submaxillary gland is placed in front of the neck, so that its duct passes on the dermal side of the tendon of the biventer maxillæ, and terminates half an inch from the symphysis menti. There is a thick row of labial glands along the lower lip. The Opossums and Bandicoots present a similar salivary system.

In the *Phalangista vulpina* there is a sublingual gland on each side of a firm texture, about one inch in length and three lines broad; a roundish submaxillary gland about the size of a hazel-nut; and a broad and flat parotid, larger than in the Entomophagous or Sarcophagous Marsupials.

The parotid glands are relatively larger in the Koala, in which the duct takes the usual course over the masseter and enters the mouth opposite the third true molar, counting backwards.

In the Wombat I found the parotid glands very thin, situated upon both the outer and inner side of the broad posterior portion of the lower jaw; the duct passed directly upwards and outwards to the insertion of the sternocleido-mastoideus; here it was buried in the cellular substance anterior to that muscle, then turned over the ramus of the jaw, and, pursuing a somewhat tortuous course over the masseter, entered the mouth just anterior to the edge of the buccinator. The submaxillary glands were each about the size of a walnut; their ducts terminated as usual on each side of the frænum linguae.

* These admeasurements were obligingly communicated to me by my friend Mr. Hobson, of Hobart Town, Van Dieman's Land, and were taken from an animal killed in the wild state. I subjoin the admeasurements of an individual of the same species which died after a year's confinement in the Zoological Gardens: there is a considerable difference in the length of the intestinal canal and

In the great Kangaroo the parotid is very large, extending from below the auditory meatus three or four inches down the neck. In the *Hypsiprymnus* it reaches as far as the clavicle. In both cases this gland is separated from the submaxillary gland by the submaxillary vein.

The *tonsils* are small in all the Marsupials, but are not represented in the carnivorous species, as in the Placental Feræ, by simple glandular pouches at the sides of the fauces; for example, they consist of an oblong glandular body on each side in the *Dasyurus macrurus*.

The liver.—The liver is subdivided into many lobes in all the Marsupial genera. It is relatively largest in the burrowing Wombat and carnivorous Dasyure; relatively smallest in the graminivorous Kangaroo, in which it is situated, as in the placental Ruminants, entirely to the right of the mesial plane. The small or Spigelian lobe, which fits into the lesser curve of the stomach, is given off from the left lobe of the liver in the Kangaroos, but from the right in most other Marsupials; the difference just noticed in the Kangaroo depends on the peculiar disposition of its remarkable stomach.

In the Koala the under surface of the liver (*fig. 130*) is singularly sculptured and subdivided into thirty or forty lobules; this condition is presented in a minor degree in the liver of the Ursine Dasyure.

In a long-tailed Dasyure, which weighed 3 lbs. 8½ oz., the liver weighed 3½ oz. avoirdupoise.

The gall-bladder is present in all the Marsupials, and is generally of large size and loosely lodged in a deep cleft of the cystic lobe. In the Opossum it generally perforates that lobe, and the fundus appears at a round opening on

especially of the cæcum; and it may be allowable to speculate upon the influence which difference of diet and confinement may have had in producing this difference. Mr. Martin's admeasurements of another *Phal. Vulpina* agree more nearly with mine.—See Zool. Proceedings, 1837.

† The vermiform process measures two inches in length.

Fig. 130.

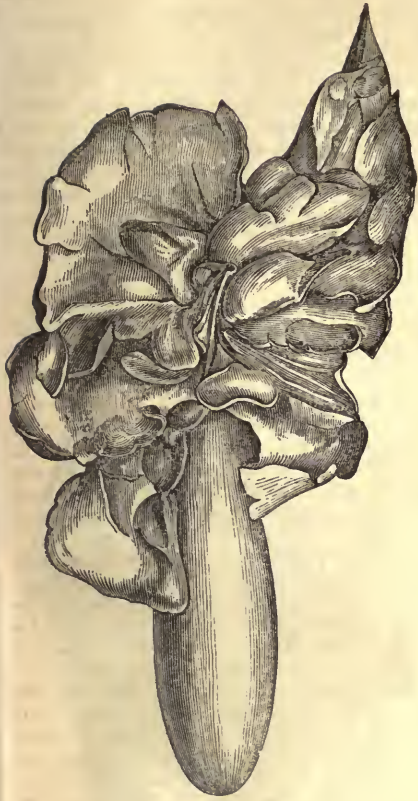

Liver of the Koala.

the convex surface of the liver. The coats of the ductus choledochus are thickened towards its termination, and become the seat of numerous mucous cysts which open into the interior of the duct.

In the Phalangers the terminal half-inch of the ductus choledochus is similarly enlarged and glandular. The biliary and pancreatic ducts generally unite together before perforating the duodenum. In the Virginian Opossum, the long-nosed Bandicoot, and the long-tailed Dasyure they pour their secretions into the gut an inch from the pylorus. In the great Kangaroo the glandular ductus choledochus is joined by the pancreatic duct, and terminates in the duodenum five inches from the pylorus.

The pancreas.—The pancreas extends as usual from the duodenum to the spleen, behind the stomach; it is characterized by a process sent off at right angles, or nearly so, to the main lobe at or near its left extremity. I have observed other small and thin processes branching out into the duodenal mesentery in a Phalanger; and similar but still more numerous processes, so as to give the organ a dendritic appearance in the Kangaroo; but the first-named process is constant.

The spleen.—It is interesting to observe that the spleen corresponds in this triangular or T-

shaped figure with the pancreas. In the great Kangaroo (*Macropus major*) I found the main body of the spleen ten inches long, and the rectangular process six inches; both parts were narrow and thin.

Absorbents.—The lacteal absorbents form, in the *Dasyurus viverrinus*, two thin, subelongate, dark-coloured mesenteric glands: one of these is situated near the pylorus, at the end of the pancreas. The plexiform cysterna chyli is situated in the Kangaroo (*Macropus Parryi* was the species from which the following description is taken) upon the crura of the diaphragm, and extends upon the right side above the diaphragm into the thorax. Two thoracic ducts are continued from the cysterna, one along the left, the other along the right side of the bodies of the dorsal vertebræ. The right duct crosses the seventh vertebra and joins the left, which again divides and reunites, forming a slight plexus, before finally terminating at the confluence of the left subclavian and jugular veins. The double thoracic duct in the Kangaroo was first noticed by Dr. Hodgkin; it is interesting, on account of its resemblance to the characteristic condition of the great nutrient conduit in the Bird and Crocodile; in these, however, each division terminates in the vena innominata of its own side, which was not the case in the Kangaroo above described.

Blood.—From the characteristic elliptical form of the blood-discs of Birds and Reptiles, and the rare occurrence of that form, as in the exceptional case of the Camel tribe, among the placental Mammalia, the examination of these particles of the circulating fluid in the Marsupial genera was attended with more than ordinary interest, and the results, derived from a comparison of species belonging to all the leading groups, show that the different tribes of Marsupial animals correspond with the analogous placental Mammalia both in the circular or subcircular contour of the blood-discs, and very nearly also in their size.*

Dasyurus viverrinus.—The blood-discs of this small carnivorous Marsupial were sensibly larger than those of the analogous placental Mammalia, as the Cat. The ordinary or unbroken discs had their margin rounded off. The number of the granulated discs was considerable; many of them presented a well-defined margin, notched like a cog-wheel. The average diameter obtained by me was $\frac{1}{3500}$ th of an inch.

Dasyurus ursinus.—The average diameter of the blood-discs is $\frac{1}{3500}$; observed extremes of size $\frac{1}{2800}$ and $\frac{1}{4370}$.

Perameles lagotis.—The blood of this Marsupial, which was examined while recently drawn from the living animal, and under the same circumstances as that of the two species of *Dasyure*, presented a still greater number of the granulated blood-discs mixed with others of the ordinary form. The descriptions of such altered blood-discs not only by Hewson and Falconer, and in recent times by Professor

* See Medical Gazette, November 13, 1839, and Mr. Gulliver's observations, London and Edinb. Philos. Magazine, February, 1840.

Wagner, (Hecker's Literarische Annalen, Februarheft, 1834,) but also in works in our own language, as in Hodgkin's Translation of Edwards's Influence of Physical Agents on Life, Appendix, p. 438, 1832, have rendered the fact sufficiently familiar. But the connection of this well-known appearance with the mode of formation or multiplication of the blood particles had not before attracted the attention it seemed to deserve; on this subject I have elsewhere remarked: "In some of the granulated blood-discs of the *Perameles* the subdivisions producing that appearance were fewer and larger, and were separated by deeper clefts than I had before observed; they suggested to me the idea that the blood-disc was undergoing a spontaneous subdivision into smaller vesicles, and, although my observations are not at present sufficiently numerous to warrant the hypothesis that the development of smaller vesicles within itself is a normal property of the ordinary coloured vesicle or blood-disc, yet the obscurity which still hangs over the origin and reproduction of the blood-discs, and the unexpected constancy of the granulated form in a greater or less proportion of them while recent, and floating in the serum, in different species of animals examined by me, makes me unwilling to suppress any idea naturally arising out of such observations and likely to be suggestive of examination of the same appearances by other microscopical observers."* The general form of the blood-vesicles of the *Perameles* is the usual circular flattened disc: they presented a greater variety of size than in the *Dasyurus*, but upon the whole a larger average diameter, viz. $\frac{1}{37\frac{1}{2}}$ th of an English inch.

Phalangista Vulpina.—Average diameter of blood-disc $\frac{1}{37\frac{1}{2}}$ th inch.

Petaurus sciureus.—Ditto ditto $\frac{1}{35\frac{1}{2}}$ th inch.

Macropus penicillatus.—Do. do. $\frac{1}{42\frac{1}{2}}$ th inch.

Macropus major.—Ditto ditto $\frac{1}{40\frac{1}{2}}$ th inch.

Phascolomys Vombatus.—Do. do. $\frac{1}{36\frac{1}{2}}$ th inch.

The results of the present observations on the blood of the Marsupial quadrupeds correspond generally with those obtained from the placental Mammalia, inasmuch as the blood-discs of the species which derives its nutriment from the greatest variety of organized substances, as the *Perameles*, which subsists on insects, worms, and the farinaceous and succulent vegetables, are larger than those of the strictly carnivorous *Dasyure*, and of the herbivorous Kangaroo, the blood-discs of the latter, like those of the placental Ruminant, being the smallest, though not in the same proportion. In each natural group of Marsupialia there is a direct relation between the size of the blood-disc and that of the species.

Heart.—The heart is inclosed in a pericardium, and situated in the same relation to the lungs, mediastinum, and thoracic cavity as in the Rodent and most other mammiferous quad-

rupeds. It offers no peculiarity in its general outward form. The apex is less obtuse in some species, as the *Phalanger* and *Wombat*, than in others, as the Kangaroo. The serous layer of the pericardium is reflected upon the large vessels near to the heart. The fibrous layer of the pericardium adheres to the sternum in the Kangaroo. The appendix of the right auricle is always divided into two angular processes, (*a, a*, figs. 131 and 132,) one in front and the other behind the trunk of the aorta.

Fig. 131.

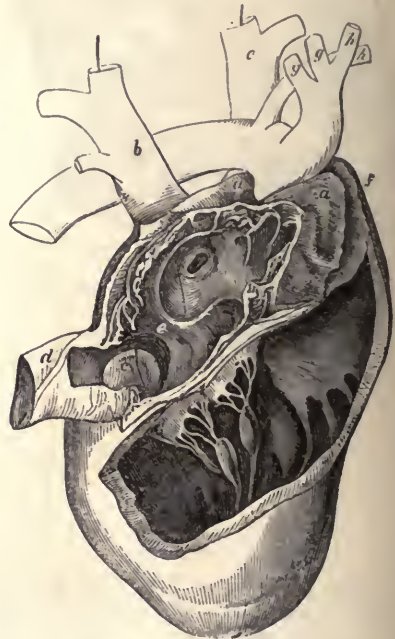

Heart of the Kangaroo.

Besides this characteristic modification of its external form, the right auricle presents some still more essentially marsupial conditions in its interior. There is no trace, for example, of a 'fossa ovalis' or an 'annulus ovalis' in any marsupial animal;* and the absence of these structures, which are present in the heart of all the placental Mammalia, doubtless relates to the very brief period during which the auricles intercommunicate in the Marsupials, and to the minute size, and in other respects incompletely developed state, at which the young marsupial animal respire air by the lungs, and has the mature condition of the pulmonary circulation established. The right and left auricles intercommunicate by an oblique fissure in the uterine embryo of the Kangaroo, when two-thirds of the period of gestation is past, but every trace of this fetal structure is obliterated in the subsequent growth of the heart; so that in the mature animal the wide terminal orifice of the posterior cava is

* Medical Gazette, 1839, l. c. My hypothesis has received a certain degree of confirmation by the subsequently published observations on the division of the corpuscles of the blood by Mr. Quekett, (Med. Gazette, January, 1840,) and by Dr. Martin Barry, Philos. Trans. 1840, p. 595.

* Physiological Catalogue, Mus. Royal College of Surgeons, 4to. vol. ii. p. 52.

separated from that of the anterior cava by a simple crescentic ridge (*c*, *figs.* 131 and 132), which forms a salient angle of the parietes of the auricle between these apertures. The anterior cava (*b*) returns the blood from the right side of the head and the right anterior extremity; the corresponding vein on the left side (*c*) passes down in all the Marsupials, as in Birds and Reptiles, behind the left auricle, below the two pulmonary veins, and, after receiving the coronary vein, joins the inferior cava (*d*) immediately before its expansion into the auricle.

Fig. 132.

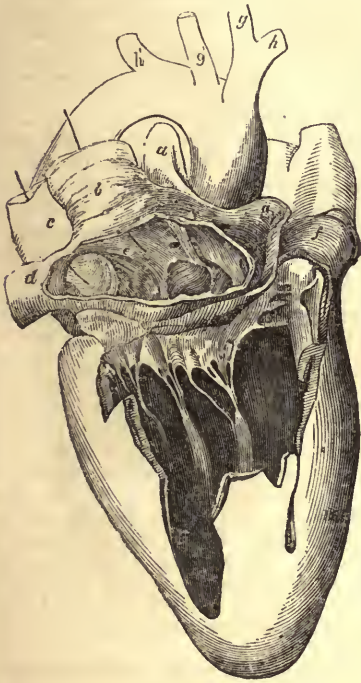

Heart of the Wombat.

Where the posterior extremities are less or not larger than the anterior ones, as in the Ursine Dasyure and Wombat, the posterior cava is somewhat less than the left vena innominata (*figs.* 131 and 132), and they appear to terminate by separate apertures in the auricle; but in the Kangaroo (*fig.* 131) the proportions of the two veins are reversed, and the posterior cava more obviously receives the left vena innominata before it terminates: these two veins meet at a very acute angle, and are separated by a crescentic ridge similar to, but thinner than, that which divides their common orifice from the orifice of the anterior cava.

The right auriculo-ventricular valve is membranous, as in the placental Mammalia, and its free margin is attached by fine chordæ tendinæ to three columnæ carneæ; these in the Kangaroo (*fig.* 131) all arise from the septum of the ventricles, but in the Wombat (*fig.* 132)

the base of two of the columnæ is situated at the angle between the septum and the thin outer wall of the ventricle.

The right ventricle extends nearly to the apex of the heart in the Wombat, but falls short of that part in the Kangaroo. The ventricle is continued in the form of a pyramidal process, somewhat resembling a *bulbus arteriosus*, to the origin of the pulmonary artery (*f*, *figs.* 131 and 132), and projects beyond the general surface of the heart further than in ordinary Mammalia.

The appendix of the left auricle is notched in the Kangaroo to receive the apex of this process, but not in the Wombat. Two pulmonary veins (*i*, *fig.* 133) terminate close together, or by a single trunk, at the upper and dextral angle of this auricle. The mitral valve is regulated by two short and thick columnæ (*k*, *k*, *fig.* 133), which send their tendinous chords to the margin and ventricular surface of the valve.

Fig. 133.

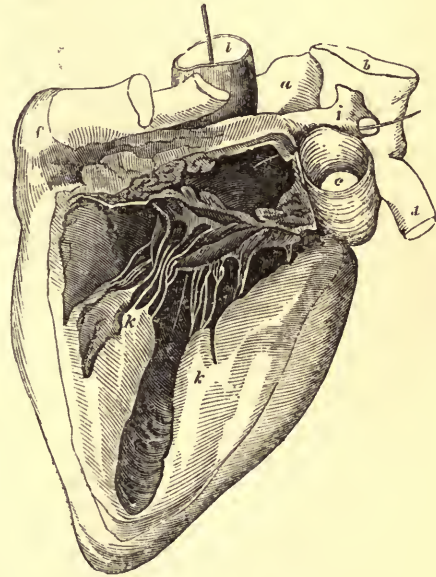

Heart of the Wombat.

The ventricles and auricles present the usual mammalian proportions and relative thickness of their parietes. Three sigmoid valves are situated at the origin of the pulmonary artery, and the same number at that of the aorta.

After the coronary arteries, the primary branches from the arch of the aorta rise in some species by three, in others by two trunks. The broad-chested Marsupials, the Koala and Wombat for instance, are those in which the left carotid (*g'*, *fig.* 132) and subclavian (*h'*) arise separately from the arch; the arteria innominata dividing into the right subclavian and carotid (*g*, *h*, *fig.* 132), as in man. In most of the other Marsupials the innominata gives off both carotids (*g*, *g*, *fig.* 131) as well as the right subclavian (*h*); and the left subclavian

(*h*) alone has a separate origin. The common carotid in the Kangaroo gives off the thyroid artery, and afterwards divides opposite the transverse process of the atlas into the external and internal carotids. The internal carotid describes a sharp curve at its origin, and passes along the groove between the occipital condyle and the occipital process to the foramen caroticum. The vertebral arteries are given off by the subclavians, and pass to the skull, as usual, through the vertebral foramina of the cervical transverse processes. They unite beneath the medulla oblongata to form the basilar artery, which sends off at right angles to the cerebellum two branches as large as itself: it divides opposite the anterior margin of the pons Varolii, and the diverging branches are connected by two straight transverse canals, before they anastomose with the internal carotids to form the circle of Willis. No peculiarly marsupial condition occurs in the distribution of the other arteries of the head, or those of the neck, the chest, and anterior extremities; but I may observe that in the Koala, Wombat, Kangaroos, Potoroos, most Phalangiers, (*Phal. Cookii* is an exception), most Petaurists, (*Pet. Sciuereus* is an exception), the Opossums, Bandicoots, and Phascogales, the brachial artery perforates the internal condyle of the humerus; it passes over that condyle, impressing it with a more or less deep groove in the Dasyures and Thylacine.

In the abdomen, the primary branches of the aorta are sent off in the same order as in most of the ordinary Mammalia, with the exception of the constant absence of an inferior mesenteric artery. This modification probably relates to the simplicity of the mesenteric attachment of the intestines above described. A still more marked example of the oviparous affinities of the Marsupialia, as exemplified in the arterial system, occurs in the mode of origin of the great arteries of the posterior extremities. In Man and the ordinary Mammalia these are derived, as is well known, from a single trunk on each side—the common iliac artery; in Birds from two primary branches of the aorta, one corresponding with the external iliac and femoral, the other with the internal iliac and ischiadic arteries. In the Kangaroo and Phalangista vulpina the aorta gives off, opposite the interspace of the two last lumbar vertebrae, the iliac arteries; but these are afterwards resolved into the ordinary branches of the external iliac of the placental Mammalia, with the addition of the ilio-lumbar artery. The trunk of the aorta, much diminished in size, maintains its usual course for a very short distance, and then gives off the two internal iliacs, and is continued as the ‘arteria sacra media’ to the tail. The transitional character of this part of the marsupial sanguiferous system between the oviparous and placental types, is manifested in the large size of the external iliacs as compared with the internal iliacs, their greater share in the supply of blood to the hinder extremities, and the brevity of the aortic trunk between their origins. In most Birds the femorals or external iliacs are

smaller than the ischiadic or internal iliac arteries subsequently given off. At the upper part of the thigh the femoral artery divides into two equal branches; the one which corresponds with the radial artery in the fore leg (*m*, fig. 134) principally supplies the foot in the Kangaroos; it passes along the back of the radius, between the gastrocnemius internus and tibialis posticus, and divides a little above the internal malleolus. The smaller division (*l*, fig. 134), which follows the ordinary course of the femoral along the popliteal space, is lost upon the inner and posterior part of the tarsus; the larger branch winds over the malleolus to the front of the tarsus, sends off the anterior tarsal artery, and is then continued along the inner and afterwards the under part of the metatarsal bone of the long and strong toe.

In fig. 134, *a* is the trunk of the cœliac artery; *b* that of the superior and inferior mesenteric arteries; *c* is the capsular artery of the left side; *d, d*, the renal arteries; *e* the spermatic artery, of which the left branch is shown continued to the left ovarium *g*, which, with the uterus *r*, vagina *s*, and bladder *t*, is drawn to the right side; the spermatic arteries arise close together but separately in the male Vulpine Phalanger: *f* is the external iliac, corresponding with the common iliac in placental Mammalia, and with the femoral artery in Birds, (see Vol. i. p. 337, figs. 170, 23;) below these are given off *h*, the arteries corresponding with the ischiadic arteries in Birds, (Vol. i. p. 337, fig. 170, 26,) and with the internal iliacs in Mammalia; [they are represented of too small a size in the cut]; *k* is the femoral artery; *l* the external, *m* the internal branch; *i* is the sacro-median or caudal artery, which is protected in its course along the tail by the hæmaphysial or chevron-like processes of the caudal vertebrae. This artery of course corresponds in size with the development and functional importance of the tail, and must be rudimentary in the tail-less or nearly tail-less Marsupials, such as the Chæropus, Koala, and Wombat.

With respect to the veins of the Marsupials it may here be noticed that the iliac veins combine to form the trunk of the abdominal cava, as in the rest of the Mammalia, without conveying any part of their blood to the kidneys: in the Kangaroo they both pass on the central aspect of the iliac arteries. The renal veins, in like manner, directly communicate with the abdominal cava, and do not contribute any share in the formation of the portal vein. This great securing trunk of the hepatic organ presents the strictly mammalian condition, being formed by the reunion of the gastric, intestinal, pancreatic, and splenic veins. It is in the chest that we first meet with decided traces of the oviparous type of structure in the venous system of the Marsupialia. The primitive veins of the animal system of organs, commonly called ‘azygos,’ retain their original separation and symmetry; the left ‘azygos’ bends over the left bronchus to communicate with the left anterior cava, and the right azygos over the right bronchus to join the right anterior cava. The left anterior cava commonly

Fig. 134.

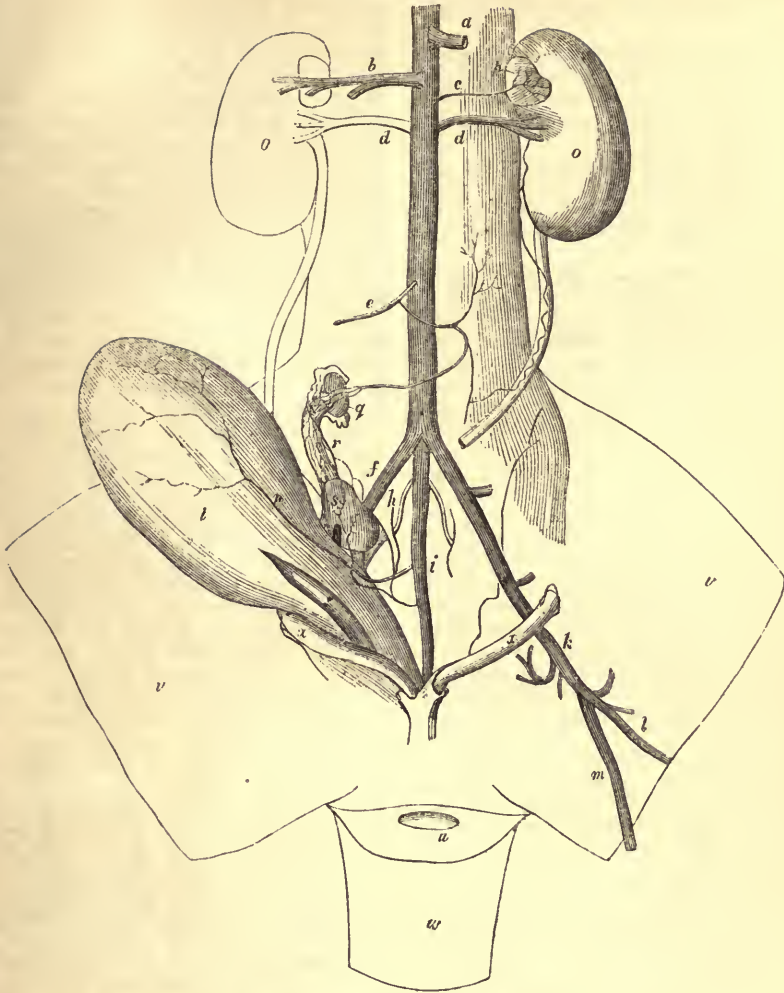

Branches of the abdominal aorta, Kangaroo.

receives also the coronary vein of the heart: the termination of this and the two other venous trunks in the right auricle has already been noticed.

Respiratory organs.—In the condition and structure of the respiratory organs all the Marsupial species adhere to the Mammalian type; the only tendency to the Ovipara is in the entireness of the tracheal rings in certain species. In the *Phalangista fuliginosa*, where I counted twenty-nine rings, the first four-and-twenty were entire; below these they were divided posteriorly, the interspace growing wider to the twenty-ninth ring. In the *Dasyurus macrurus* the rings of the trachea are twenty-three in number, and are incomplete or rather ununited behind. In the *Perameles* the tracheal rings are divided posteriorly by a fissure. In no species have I found the trachea divided near the larynx into two long bronchiæ,

as in the Rodent genus *Helamys*, nor convoluted in the chest as in the Edentate Sloth, both of which modifications are more striking approximations to the oviparous type of structure than the entire rings above-mentioned.

The *lungs* present the most simple form in the Wombat, in which they consist of a single lobe on both the right and left sides, with a small lobulus azygos extending from the right lung to the interspace between the heart and diaphragm.

In the *Macropus major* I found the right lung with two notches on the anterior margin, and the left lung undivided. In the *Macropus Parryi* both lungs had one or two notches. In another Kangaroo I found the right lung divided into four lobes, the left into two. The azygos lobe is large in consequence of the length of the chest in the Kangaroos, and the distance of the heart from the diaphragm: it is

three-sided, one side convex, the second concave and applied to the pericardium, the third side concave, and in contact with the diaphragm.

In the Potoroo the left lung is unilobate with a fissure on the anterior or upper edge; the right lung has two or three deep fissures. The azygos lobe is elongated, pointed, and triedral, as in the Kangaroo.

In the Petaurists and Phalangers the right lung is trilobate, the left bilobate; there is also a lobular azygos. The Koala has the lungs similarly divided, and not simple as in the Wombat.

In the Opossums, Dasyures, and Perameles the right lung is usually trilobate, (bilobate in *Didelphys brachyura*.) and with the usual azygos appendage: the left lung is commonly divided into two, but is sometimes entire, as in the *Perameles* and *Didelph. brachyura*. In all the Marsupials the right lung is the largest, owing to the oblique inclination of the heart to the left side.

The thyroid glands are two disunited bodies in the Dasyures; they were each the size of a horse-bean in the *Dus. macrurus*. They were of the same size in a *Phalangista fuliginosa*, but were united by a filamentary strip passing between their lower extremity, across the first tracheal ring. In the Koala, the thyroid gland is situated lower down extending from the fourth to the ninth or tenth tracheal ring. In the Wombat I found the thyroid glands two elongated bodies of a dark colour reaching from the thyroid cartilage to the seventh tracheal ring on each side.

The larynx of the Marsupialia consists of a cricoid, thyroid, and arytenoid cartilages and an epiglottis. The latter is always remarkable for its large size, and generally for its emarginate apex. There is no muscle passing from the epiglottis to the tongue; its base is connected in the Kangaroo by a triangular fascia to the body of the os hyoides and the greater cornua; and a small muscle passes from the middle part of the body of the os hyoides to the dorsum linguæ.

In the Phalangers the epiglottis is broad and short, and with a bifid apex. In the *Perameles* and *Phascogale* the sides of the broad and short epiglottis are attached to the apices of the arytenoid cartilages, retaining thus much of its early condition, which will be adverted to in the account of the peculiarities of the mammalian fetus.

In the *Perameles lagotis* I found on the base of the tongue in front of the epiglottis a small sacculus of mucous membrane, which communicated by a regular symmetrical crescentic aperture, situated between the body of the os hyoides and the thyroid cartilage, and continued down in front of the thyroid cartilage: the surface of the cavity was smooth and lubricated, and it seemed to be for the purpose of facilitating a hinge-like motion between the thyroid cartilage and the body of the os hyoides.

The thyroid cartilage is convex externally and protuberant in the Phalangers and Koala, but

offers no particular modification in other Marsupials. The base of the arytenoid cartilages is broad in the antero-posterior direction, and the chordæ vocales short and feebly developed. The Marsupials have little or no voice: the Wombat emits a guttural hissing sound: the *Dasyurus ursinus* a snarling growl or whine: the Thylacine is described as uttering a short guttural cry. I have never heard a vocal note of any kind from the Kangaroos, Potoroos, Petaurists, Phalangers, or Perameles.

Renal system.—The kidneys present a simple conglobate external form in all the Marsupials, as in *fig. 134, o, o*, and in their structure and position in the abdomen agree with the Mammalian type of structure.

In the *Macropus Parryi* the kidneys are situated six inches above the brim of the pelvis, and lying in the same transverse line: they have the same relative position in other Poephaga.

In the Koala the right kidney is higher by its whole length than the left. In the *Dasyuri macrurus* and *viverrinus*, the right kidney lies half an inch higher or in advance of the left: in this carnivorous genus a few branches of the renal veins are distributed upon the surface of the kidney, but not in the same proportion or with the beautiful arborescent disposition characteristic of the kidneys of the Cats, Suricates, and Hyæna. In a *Dasyurus macrurus* weighing three pounds eight ounces, the two kidneys weighed thirteen drachms. In a *Phalangista vulpina*, weighing five pounds three ounces, the two kidneys weighed only ten drachms.

The substance of the kidney is divided into a cortical and medullary part; the former is generally a thin layer. The tubuli uriniferi terminate on a single mammilla which projects into the commencement of the ureter in the Opossums, but does not extend beyond the pelvis of the kidney in the Kangaroos. In the Kangaroos the medullary substance forms several lateral abutments to the base of the main mammilla.

The supra-renal glands generally present the relative position and proportions to the kidneys represented in the Kangaroo, at *fig. 134, p*. They are, as in most of the smaller quadrupeds, less flat than in man: the right body generally adheres to the coats of the vena cava, and the left to the renal vein. In the Dasyures the external stratum is light-coloured; this surrounds a dark-coloured layer, and then there is a light-coloured central part, but no cavity.

The ureters terminate at the back of the neck of a muscular and pendulous urinary bladder (*t*), which only exhibits a trace of urachus at the middle of its anterior part in the young marsupial, while in the maternal pouch.

Male organs of generation.—The testes, which are still abdominal at the time of birth, descend, soon after the fetus is transferred to the pouch, into the external pedunculate pre-penial scrotum; the canal of communication between the abdominal cavity and the tunica vaginalis is long and narrow, but always remains pervious.

The tubuli testis are relatively smaller than in the Rodentia, but are similarly arranged, the corpus Highmorianum being near the surface and upper part, not at the centre, of the gland. The epididymis is large, and generally loosely attached to the testis: in a small species of Kangaroo I found the connecting fold of serous membrane half an inch broad. The vasa deferentia pass from the globus minor along the infundibular muscular sheath formed by the cremaster as far as the abdominal ring, then bend downwards and backwards, and terminate below and external to the ureters, at the commencement of the urethra (*a*, *fig. 135*), on each side a longitudinal verumontanal ridge. There are no vesiculæ seminales in any Marsupial quadruped.

Fig. 135.

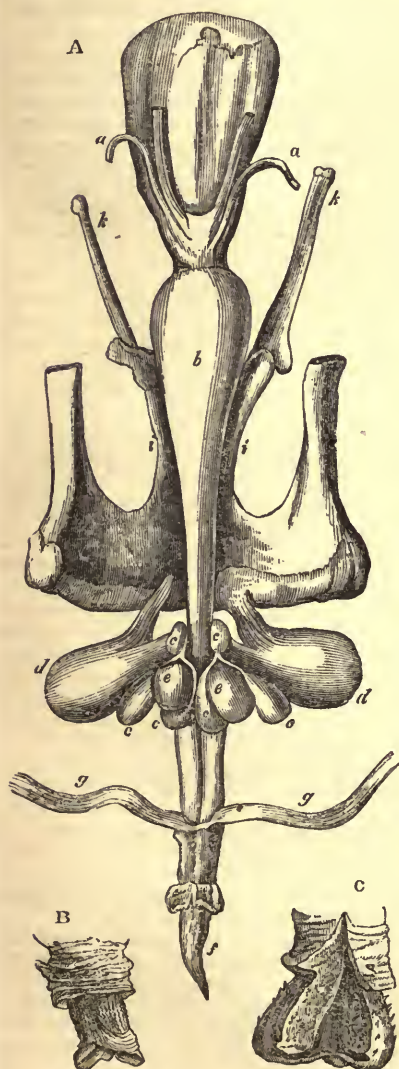
A, *Hypsiprymnus*. B, *Phascolarctus*. C, *Phascotomys*.

As the part of the urethral canal immediately succeeding the termination of the vasa deferentia is the analogue of the vagina, some modification of this part might be anticipated in the male corresponding with the extraordinary form and development which characterise the vagina in the female: accordingly we find that the combined prostatic and membranous or muscular tract of the urethra is proportionally longer and wider in the Marsupial than in any other Mammiferous quadrupeds (*fig. 135, b*). It swells out immediately beyond the neck of the bladder, and then gradually tapers to its junction with the spongy part of the urethra: it is not, however, divided like the vagina. Its walls are thick, formed of an external thin stratum of nearly transverse muscular fibres; and a thick glandular layer, the secretion of which exudes by innumerable pores upon the lining membrane of this part of the urethra. In a male Kangaroo I found that a glairy mucus followed compression of this musculo-prostatic tract of the urethra: the canal itself is here slightly dilated.

Three pairs of *Cowper's glands* (*c, c, c, fig. 135*) pour their secretion into the bulbous part of the urethra: the upper or proximal pair are not half the size of the two other pairs in the Kangaroo, but are relatively larger in the Koala and other Marsupials: the two lower pairs are situated, one on each side the lateral division of the bulb of the urethra; their ducts meet and join, above this part, with the duct of the smaller gland: each gland is inclosed by a muscular capsule.

The *penis* consists of a cavernous and a spongy portion, each of which commences by two distinct bodies. The separate origin of each lateral half of the spongy body constitutes a double bulb of the urethra (*e, e, fig. 135*), and the 'accelerator urinæ,' as it is termed, undergoes a similar division into two separate muscles, each of which is appropriated to compress its particular bulb. The two bulbous processes of the corpus spongiosum soon unite to surround the urethra, but again bifurcate to form a double glans penis in the multiparous Marsupials, in which most of the ova are impregnated in both ovaria, as the Phalangers, Perameles, Opossums, &c. (*b, b, fig. 136*).

This modification of the opposite extremities of the corpus spongiosum, called 'bulb' and 'glans,' was detected by Cowper in his dissection of a male Opossum; and, in his account of the anatomy of that animal in the Philosophical Transactions for the year 1704, he says, "As the bulb of the urethra in man is framed for the use of the glans, to keep it sufficiently distended when required, so it seems it is necessary to have *two* of these bulbs, inclosed with their particular muscles in this animal, to maintain the turgescence of its *double* or forked glans when the penis is erected."—Vol. xxiv. p. 1585.

The force of this ingenious reasoning on the correlation of the bulb to the glans might seem to be invalidated by the fact that in the uniparous Marsupials, as the Kangaroo, the glans penis (*f, fig. 135*) is single, and yet the bulb double

but in this circumstance we may perceive an example of the retention of a typical structure at the deeper seated part of a system of organs, when not incompatible with a slight modification of a peripheral segment of the same system; it being by no means obviously necessary to abrogate the division of the urethral bulb simply because the blood accumulated in each division was to be driven in a concentrated current upon a single, instead of a double glans penis.

The intermediate structures of the glans between the two extremes above instanced are presented by the Ursine *Dasyure*, *Koala*, and *Wombat*. In the *Koala* (fig. 135, B) the glans penis terminates in two semicircular lobes, and the urethra is continued by a bifurcated groove along the mesial surface of each lobe. In the *Wombat* (fig. 135, C) there is a similar expansion of the urethra into two divergent terminal grooves, but the glans is larger, cylindrical, and partially divided into four lobes:* the chief structure of interest in this part of the *Wombat* is the callous external membrane of the glans, and its armature of small recurved, scattered horny spines, which do not occur in any other Marsupial animal. The small retroverted papillæ on the infundibuliform glans of the *Koala* and on the bifurcate glans of the *Phalangers* and *Petaurists* are not horny.

In the *Perameles lagotis* not only is the glans bifurcate, but each division is perforated, and the urethral canal is divided by a vertical septum for about half an inch before it reaches the forked glans. From the septum to the bladder the canal is simple, as in other Marsupials. The bifurcations of the glans in the *Opossums* and *Phalangers* are simply grooved.

If the experiments of Haighton and the detection, by Drs. Bischoff and Barry, of spermatozoa upon the ovary itself after coitus, had not rendered the question of the necessity of the contact of the semen with the ovarium for impregnation almost independent of the aid of Comparative Anatomy, the differences of structure above described in the urethra and glans penis of the Marsupial animals would have gone far to explode the once prevalent notion of an 'aura seminalis' fertilizing the ovum through the medium of the circulating fluid: for why, on such an hypothesis, should the impregnation of two ovaria, each communicating with a distinct oviduct, uterus, and vagina, as in the *Opossum*, require two conduits of the semen in the male, one for each vagina?—and wherefore, in the case of an uniparous Marsupial, in which the fecundating stream need ascend only to a single ovarium, as in the *Kangaroos* and *Potoroos*, is the penis terminated by a single glans?

The spermatozoa of the *Perameles* have a single barb at the base of the head, which is sub-elongate and compressed; in other respects, as in size and proportion of the filamentary tail, they resemble the spermatozoa of the *Rabbit*.

Neither in the *Kangaroo*, *Phalanger*, nor *Dasyure* did the spermatozoa present a spiral head or any noticeable deviation from the characters of the spermatozoa in the smaller placental quadrupeds: those of the *Dasyure* have a node at the base of the head.

The corpus cavernosum penis commences by two crura (*d, d*, figs. 135, 136), neither of which have any immediate attachment to the bony pelvis. Cuvier correctly states, that in the *Kangaroo* the two crura of the corpus cavernosum, and the two bulbs of the corpus spongiosum, soon unite to form a single cylindrical body, having a canal which nearly follows the direction of its axis, whose parietes are equally strong and fibrous, and which contains the urethra; so that the transverse section of the corpus cavernosum resembles a ring; but the two lateral cavities are separated by two vertical septa which extend one from the central canal to the dorsum penis, the other from the central canal to the inferior wall of the penis.*

In the *Kangaroo* and *Potoroo*, the *erectores penis* (fig. 135 *d, d*) arise by a thin fascia from near the lower part of the symphysis pubis, soon become fleshy, and increase in thickness as they pass outwards: each muscle then returns upon itself, at an acute bend, to grasp the crus penis, and terminates in a strong tendinous expansion at the junction of the cavernous with the bulbous structure.

Fig. 136.

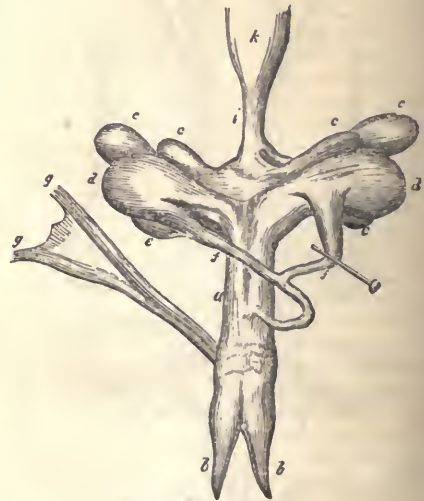
Male Organs, *Opossum*.
(Cuvier, l. c.)

The *retractor penis* (figs 135, 136, *g, g*) arises in the *Kangaroo* from the middle of the sacrum, and divides into two muscles, behind the rectum, and opposite the dilated commencement of the musculo-prostatic part of the urethra; each division diverges to the side of the rectum, then passes to the interspace between the rectum and roots of the penis, and along the

* Cuv. Leçons d'Anat. Comparée, 1805, t. v. p. 91.

* Leçons d'Anat. Comp. 1805, t. v. p. 73.

lateral and posterior part of the penis, until it is inserted with the opposite muscle at the base of the glans.

In the Opossum and those Marsupials which, having a bifid glans, enjoy, as it were, a double coitus, there is a *levator penis* (*f, f*, *fig. 136*), which is not present in the Kangaroo. Each portion of this muscle takes its origin from the fascia covering the crus penis, converges towards its fellow above the dorsum penis, diminishing as it converges, and terminates in a common tendon inserted into the upper part of the base of the glans.

There is another powerful muscle which, though not immediately attached to the penis, must exert, in all Marsupials, so important an influence upon its erection as to merit notice here. This is the external sphincter ani, or more properly 'sphincter cloacæ': it is an inch and a half in breadth in the Kangaroo and half an inch in thickness; from the back of the termination of the rectum it passes over the anal glands and sides of the base of the penis, inclosing the two bulbs with Cowper's glands and their muscles, and terminates anteriorly in a strong fascia above the dorsum penis, so as to compress against that part the venæ dorsales.

This adjustment and function of the great sphincter did not escape the observation of Cowper. Speaking of the *erectores penis* of the Opossum, he says, "the muscles of the cavernous bodies of the penis of this creature, having no connexion with the os pubis, cannot apply the dorsum penis to the last-named bone and compress the vein of the penis, whereby to retard the reflux blood and cause an erection, as we have observed in other creatures; but some large veins of the penis here take a different course, and pass through the middle parts of the bulb (*crus*), and are only liable to the compression made by the intumescence of the muscles (*c c*) that inclose them. But the chief agent in continuing the erection of the penis in this animal is the sphincter muscle of its anus, or rather cloaca; and not only the sphincter muscle of the cloaca of the male Opossum, but that of the female also, closely embraces the penis in coition, and effectually retards the reflux blood from its corpora cavernosa, by compressing the veins of the penis."* The penis is bent upon itself in a sigmoid form when retracted; with the glans concealed just within the cloacal aperture, from which it emerges, as in the *Ovipara*, when the penis is turgid and erect.

Female organs.—These consist of two ovaries, two oviducts or fallopian tubes, two uteri, two vaginae, an uro-genital canal, a clitoris, mammary organs, and marsupial pouch.

The ovaries are small and simple in the uniparous Kangaroos; tuberculate and relatively larger in the multiparous Opossums; but the largest size and most complicated form of these essential organs which I have met with in the Marsupial order were presented by the Wombat (*fig. 137*). The

ovaria are represented of their natural size in *fig. 138, a a'*, in the great Kangaroo, where they present an oval form and a smooth unbroken exterior, except after impregnation, when a large corpus luteum projects from the surface, as at *a'*. The ovaria are not inclosed by a capsular duplication of the peritoneum, but are lodged within the expanded orifice of the oviduct, or 'pavilion,' near the upper or anterior extremities of its two principal lobes or processes. These are of considerable extent, and their internal surface, which is highly vascular, is beset with rugæ and papillæ. In the *Dasyures* and *Petaurists* the ovaries are elliptical, subcompressed, and smooth. In the Opossum the ovarium consists of a lax stroma remarkable for the number of ovisacs imbedded in it, the largest of which are the most superficial, and give rise to the tubercular projections on the surface of the ovary.

In the Wombat (*fig. 137*) each ovary, besides being lodged in the pavilion, as in the Kangaroo, is inclosed with the pavilion in a

Fig. 137.

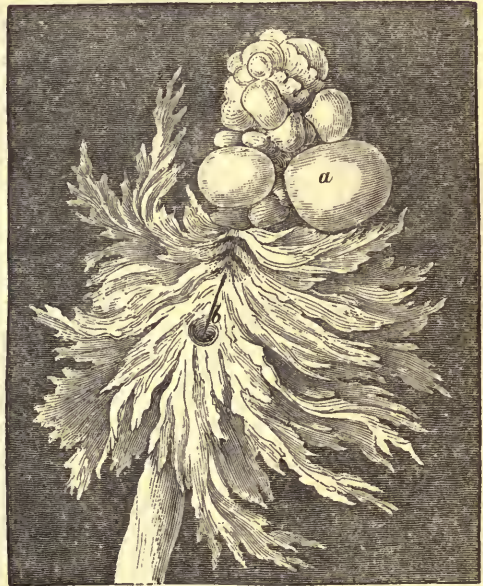

Ovarium and pavilion, Wombat. Natural size.

peritoneal capsule. In the unimpregnated female examined by me, the ovaries were six times as large as in the Kangaroo, and presented a well-marked botryoidal form, resembling the ovarium of the bird. Numerous ovisacs in different stages of growth projected from the surface, the largest presenting a diameter of eight lines (*fig. 137, a*); the structure of these ovisacs, the character of the stroma in which they are imbedded, and the dense albuginous tunic by which they are inclosed, bespeak the strictly mammalian type of the ovaria of the *Phascolumys* as of every other genus of Marsupial; but the affinity of the Wombat to the Rodent order, in many species of which the ovaria are tu-

* Phil. Trans. vol. xxiv. 1704, p. 1534.

Fig. 138.



a, Right ovarium.
a', Left ovarium, with corpus luteum.
b, Oviducts.
c, Right uterus.
c', Left uterus, impregnated.
d, Os tincae.
e, Vaginal cul-de-sac.

e, Vaginal canals.
e', Vaginal septum.
f, Commencement of uro-genital canal.
i, Chorion of fetus.
h, Umbilical cord.
k, Round ligaments of the uterus.

Female organs, Kangaroo.

berculate, is again manifested in this part of its structure. The expanded orifices of the fallopian tubes present a greater development than in the Kangaroo, and are still more remarkable for the number, size, and variety of the fimbriated processes and folds which augment the internal vascular surface of the pavilion. In both the Wombat and Kangaroo the lining membrane of the contracted portion of the oviduct is similarly complicated by minute and delicate reticular plications and processes. The oviducts are shorter and less sinuous in their course in the uniparous Kangaroo, *fig. 138, b*, than in the multiparous Opossums (*b, fig. 139*).

In the above described essential parts of the female generative apparatus the mammalian type of structure is closely adhered to; the deviations most characteristic of the implantental group begin to manifest themselves in the remaining parts, and here under so irregular and complicated a form as to require a brief review of the analogous structures in other groups of animals for their intelligibility.

The variations of structure which the female generative organs present in the oviparous classes of *Vertebrata* are fewer and of less degree than those observable in the different orders and genera of the *Mammalia*. The most prevailing characteristic of the oviparous type of the female generative organs is the absence of union in the mesial plane of the lateral efferent tubes, which consequently continue separate to their terminations in the excretory outlet.

In Birds the genital apparatus is characterised by the higher, and, in the female, as far as function is concerned, exclusive development of the left moiety; and the uniformity in the condition of the excluded ovum in this class corresponds with the sameness which prevails in the structure of the organs concerned in its production.

In Reptiles the ovaries and efferent parts of the genital system are equally developed, or nearly so, on both sides. But although a considerable uniformity of structure is found to prevail in this system throughout the different orders of the class, the widest difference obtains both in the place of development of the ovum and the condition in which it quits its mother. No one, *e. g.*, could have predicated from a comparison of the structure of the ovaries and oviducts in poisonous and innocuous Serpents that any difference existed in the structure and development of the ovum, much less that the former were ovo-viviparous but the latter oviparous; or, from a comparison of the same organs in *Lacerta crocea* and *Lacerta agilis*, that a like difference should exist in the generative economy of species so nearly allied as for a long time to have been confounded together by naturalists.

In *Mammalia*, however, in most of the orders of which the connexion of the ovum with the uterus is so much more intimate than in the preceding classes, the variations in the structure of the female sexual organs are more numerous and remarkable; and though it be admitted that the nature of the fœtal coverings and ap-

pendages results from the original constitution and properties of the ovum, yet the modifications of the uterus have evidently, in this class, a subordinate relation to those differences.

In tracing the female generative apparatus from the human subject through the different orders of *Mammalia*, we find that it approximates to the oviparous type of structure in two ways, *viz.*, by an obliteration of the os tinæ, which is the characteristic limit between the uterus and the vagina in this class; and by a gradually increasing division of the uterus and vagina until they become two separate tubes throughout their entire extent.

In no mammiferous genus do the female organs present that character of unity or concentration, with distinction of parts, which is found in the human subject; for in the lower orders, besides the more essential differences above-mentioned, there is always an elongation of the uterus, with a thinning of its parietes, and in general a blending together of the urethral and sexual passages. This latter deviation commences in the *Simia*, and in the *Lemures* the angles of the uterus begin to elongate and to assume the form of cornua. The mesial cleft increases, and the cornua preponderate in the *Carnivora*, the *Cetacea*, the *Ruminantia*, and the *Pachydermata*; but it is in the *Rodentia*, which present affinities to Birds in other parts of their structure, that the uterus is first found completely divided into two lateral halves. This structure is not, indeed, uniformly met with in all the genera of the order; but besides the Hare and Rabbit, in which the double uterus is allowed to exist by De Graaf and Cuvier, a similarly complete division of the organ obtains in the genera *Sciurus*, *Arctomys*, *Spalar*, *Bathyergus*, *Echinys*, *Eretizon*, (*F. Cuvier*) and *Hydrocharus*; while in the genera *Mus*, *Cavia*, *Calogenys*, and *Dasyprocta*, a portion of the true uterus still remains undivided; though this part, to which alone the term 'corpus uteri' can be properly applied, is extremely small or rudimental. Nevertheless, although the corpus uteri exists in these genera, the true vagina is as remarkable for its length and capacity as in those in which the corpus uteri has ceased to exist.

Hitherto the vagina has presented itself under the form of a simple undivided canal, communicating with the urethro-sexual passage, at least after impregnation by a single aperture. But it is a remarkable and interesting fact that in the Sloth, in the Mare and Ass, in the Pig, and in the Cow, the vagina in the virgin state communicates with the urethro-sexual passage by a double aperture, in consequence of being traversed by a narrow vertical septum or chord. This septum has been described by veterinary authors as a hymen in the Mare; the analogous part in the human subject also occasionally presents the same structure, and has even been observed in some cases to extend as a mesial partition inwards towards the uterus.

In the *Marsupialia*, where from the small size of the fœtus at birth a similar conformation is permitted to remain as a permanent structure, the vagina is in some genera wholly, and in

others partially divided; but the divided portion in the latter is always that which is nearest the urethro-sexual passage.

The true uterus is completely divided in all the Marsupial genera, and each division is of a simple elongated form, as in the *Rodentia*.

The superadded complications in the female generative organs of the *Marsupials*, as compared with other mammals, are not then rightly attributable to the uterus, but to the vagina; and they are of such a nature as to adapt the latter to detain the fœtus, after it has been expelled from the uterus, for a longer period than in other *Mammalia*.

These complications vary considerably in the different marsupial genera. On a comparison of the female organs in *Didelphys dorsigera*, *Petaurus pygmaeus*, and *Petaurus tagueanoides*, in *Dasyurus viverrinus*, in *Didelphys Virginiana*, in *Macropus major*, and *Hypsiprymius murinus*, I find that the relative capacity which the uteri bear to the vagina diminishes in the order in which the above-named species follow, while the size of the external pouch increases in the same ratio.

In *Didelphys dorsigera* the uteri (fig. 139, c, c,) rather exceed the unfolded vagina in

Fig. 139.



Didelphys dorsigera.

length. In most *Marsupials* the vagina at first descend as if to communicate directly with the urethro-sexual passage; but in this small Opossum, in which the abdominal pouch consists of two slight longitudinal folds, and the young, as is implied by its trivial name, are transported by the mother on her back, each vaginal tube (c, c, fig. 139,) after embracing the os tincæ (d), is immediately continued upwards and outwards, then bends downwards and inwards, and, after a second

bend upwards, descends by the side of the opposite tube to terminate parallel with the extremity of the urethra (h) in the common or uro-genital passage (f).

In the *Petauri*, the vagina, when unfolded, are a little longer than the uteri. On examining a specimen of the Pigmy Petaurist which had two very small young in the pouch, I found both the true uteri of three times the diameter of the same in an unimpregnated specimen; but the vagina were unaltered in size, indicating that the situation in which gestation takes place in this species is the same as in the Kangaroo. The vagina, after receiving the uteri, descend close together half-way towards the commencement of the urethro-sexual passage, but do not communicate together in this part of their course. From the upper part of these culs-de-sac they are continued upwards and outwards, forming a curve, like the handles of a vase, then descend, converge, and terminate close together, as in the preceding example.

In *Dasyurus viverrinus* and *Didelphys Virginiana*, the mesial culs-de-sac of the vagina descend to the urethro-sexual passage, and are connected to, but do not communicate with it. The septum dividing them from each other is complete, being composed of two layers which can be separated from each other, and which result indeed from the apposition and mutual cohesion of the vagina at this part. In order to reach the common passage, each tube is continued outwards from the upper end of the cul-de-sac, and forming the usual curve, terminates parallel to the orifice of the urethra. The vagina in the *Dasyures* are smaller in proportion to the uteri than in the *Virginian Opossum*, but of a similar form.

In another species, the *Didelphys Opossum* of Linnæus, it would appear from the description and figures of Daubenton,* that the septum of the mesial culs-de-sac of the vagina was imperfect; but it is doubtful whether this intercommunication was not the result of parturition, or of an accidental rupture in the specimen examined. If it should prove to be a specific difference of structure, it is an approximation to the condition of the female organs in the *Phalangers*, the *Wombat*, and the *Kangaroos*.

In the *Macropus major* the vagina (fig. 138, c, c') preponderate in size greatly over the uteri (c, c'); and, the septum (e'') of the descending cul-de-sac being always more or less incomplete, a single cavity (e) is thus formed, into which both uteri open; but however imperfect the septum may be, it always intervenes and preserves its original relations to the uterine orifices (d, d).

The fœtus has been conjectured to pass into the urethro-sexual cavity by a direct aperture formed after impregnation at the lower blind end of the cul-de-sac, but I have not been able to discover any trace of such a foramen in two kangaroos which had borne young; and besides, I find that this part of the vagina is not continuous by means of its proper tissue

* Buffon, Hist. Nat. tom. x. p. 279.

with the urethro-sexual passage, but is connected with it by cellular membrane only; as might have been anticipated from the structure presented in the simpler forms of the marsupial uterus, as in *Didelphys dorsigera* and the *Petauri*, in which the culs-de-sac do not come into contact with the urethro-sexual passage. The evidence of M. Rengger on the development of the young and the parturition of the *Didelphys Azara* is also directly opposed to the theory of a temporary orifice in the mesial cul-de-sac.

The last form of the marsupial female organs which may be noticed is that which is found in one species at least of the Kangaroo Rat (*Hypsiprymnus murinus*). The type of construction is, however, the same as in the great Kangaroo, but the mesial cul-de-sac of the vagina attains a still greater development; it not only reaches downwards to the uro-genital passage, but also expands upwards and outwards, dilating into a large chamber, which extends beyond the uteri in every direction. From the sides of this chamber the separated portions of the vagina continue downwards, to terminate, as usual, in the urethro-sexual canal.*

In all the preceding genera the structure of the uteri is as distinct from that of the vaginæ as in the Rodentia. The fibrous or proper tunic of the uteri is thicker than that of the vaginæ, and the lining membrane is soft and vascular, and disposed in numerous irregular folds, which, in section, give apparently a still greater thickness to the uterine parietes. The whole extent of the vaginæ, on the contrary, is lined with a thin layer of cuticle, which is readily detachable, even from the middle cul-de-sac, so generally considered as the corpus uteri in the Kangaroo.

The inner surface of the culs-de-sac in the Opossum is smooth, but in the lower part of the single cavity in the Kangaroo and Potoroo it presents a reticulate structure. The lining membrane in the lateral canals in all the genera is disposed in regular longitudinal folds, a disposition which characterizes the true vagina in most of the ordinary quadrupeds. In the Kangaroo, as in the other Marsupialia, the lateral canals communicate with the common or urethro-sexual cavity without making a projection; but at the distance of three-fourths of an inch from their termination there is a sudden contraction, with a small valvular projection in each (fig. 138). By those who consider the cul-de-sac and lateral canals as a modification of the corpus uteri, these projections will probably be regarded as severally representing an os tinæ; but as they do not exist in the Opossums and Petaurists, in which there is simply a contraction of the vaginal canals at the corresponding part, and as in both these and the Kangaroo, the true uteri open in the characteristic valvular manner, as in the *Rodentia*, without the slightest appearance of a gradual blending with the median cul-de-sac, the valvular structure in the lateral canals cannot be regarded as

invalidating the view here adopted of the vaginal nature of the median cul-de-sac, which is supported both by the general texture and connexions of the part in question, as well as by what is now ascertained to be its limited function. Moreover, in the large single vagina of some of the *Rodentia*, as the Hare, Rabbit, and Paca, there are two corresponding valvular folds of membrane near its commencement, a little way above the urethral aperture.

In endeavouring to trace the purposes answered by the different forms of the female marsupial organs above described, considerable difficulty arises from the want of the necessary evidence which would be afforded by the examination of the pregnant uterus in each genus, and by the absence of information as to their respective periods of gestation, and the powers of the new-born fœtus. As far, however, as a conclusion can be drawn from the relative periods of gestation in the Kangaroo and Opossum, the proportionate capacities of the vaginæ to the uteri would appear to be greater as gestation is shorter; the vaginæ being thus calculated to present fewer obstacles to the escape of the fœtus in proportion to the duration of its uterine existence; and, consequently, a less capacious and complete external pouch is requisite for its ultimate perfection. From Rengger's description of the connexion of the fetal Opossum to the uterus, it might be concluded that the generation in that animal approximated to the true viviparous mode more nearly than it does in the Kangaroo; but the determination of this interesting question will require a more exact investigation into the nature of the fetal vessels and membranes in the genus *Didelphys*. The impregnated uteri of the smaller pouchless Opossums of South America would be objects of peculiar interest and value in the present state of the inquiry.

With respect to the variations of structure in the marsupial female organs, it may also be remarked, that though they are apparently most complicated in the Kangaroos and Phalangers, yet in reality they deviate from the type of the normal *Mammalia* in a minor degree in these *Marsupialia* than in the *Didelphides* and *Petauri*. For, the essential difference being a division of the vagina into two canals, we find this bipartition to be most complete in the multiparous genera, while in the Kangaroos the division is only partial, and the complexity arises from augmented capacity and extent. It is to be observed, however, that the bipartition of the vaginal canal in the Kangaroos is not continued from the uterus into the vagina, leaving its distal extremity single, but commences at the urethro-sexual cavity, and is arrested near the uteri, the orifices of which thus open into a common canal.

The situation of the rudimentary vaginal septum or hymen in the unimpregnated female organs of the placental *Mammalia* before mentioned, corresponds with this formation in the Kangaroo; and in a case where this septum was prematurely developed in the human subject, it was found to obey the same law of

* See *Philos. Trans.*, 1834, pl. vi. fig. 6.

formation, and at the same time to have been coincident with a completely divided uterus.*

It is not unusual to find the vagina of the Kangaroo distended with a gelatino-mucous adhesive secretion containing hard irregularly shaped fibrous masses. One of these bodies, which was found in the mesial cul-de-sac of a Kangaroo, was described and figured by Sir Everard Home† as the vertebral column and occipital bone of a fœtus; and his first theory of marsupial generation appears to have been much influenced by this belief. Professor Leuckart,‡ who found similar bodies in the vaginal tubes of a Kangaroo, compares them to a mola, or false conception, but observes that there was nothing in their structure that would permit him to form a conclusion that they were parts of a fœtus.

In the Wombat the lining membrane of the vaginal culs-de-sac is greatly increased by innumerable irregular rugæ and papillæ, the urethro-sexual canal is lined by a thick epithelium, and its surface is broken into countless oblique rugæ and coarse papillæ; the surface immediately surrounding the urethral orifice, which in this as in other Marsupials is close to the vaginal orifices, is comparatively smooth.

The *clitoris* is situated in a preputial recess near the outlet of the uro-genital passage: it is simple in those marsupials that have a simple glans penis, but is bifid in those which have the glans divided: and in the Opossum each division of the glans clitoridis is grooved.

Development of the Marsupialia.—Before proceeding to detail the present received doctrine of the generation and development of the Marsupialia, it may not be unprofitable to take a rapid glance at the different opinions that have prevailed at different periods respecting this interesting and difficult part of their economy.

The minute size of the young of the American Opossum when first received in the marsupium, their pendulous attachment to the nipples, and perhaps the mode in which the nipples themselves are developed, gave rise, among the earlier observers, to a notion that the young were originally formed by and from those parts.

And this belief was not only current then, as now, among the unscientific settlers in the colonies where the marsupial animals are common, but was entertained likewise by the best informed Naturalists of those times. Thus the learned Marcgrave, in his account of the Opossum, says, when speaking of the marsupial pouch, "*Hæc bursa ipse uterus est Animalis, nam alium non habet, uti ex sectione illius conperi; in hac semen concipitur et catuli formantur.*"§ And Piso repeats the assertion more strongly. "*Ex reiteratis horum animalium sectionibus alium non invenimus uterum præter*

hanc bursam, in qua semen concipitur et catuli formantur. Quos deinde quinos vel senos simul circumfert, mobiles, perfectos, sed depiles, adeoque pertinaciter uberibus affixos, ut a perpetuo suctu vir avellantur, antequam permittente matre ad pastum ipsi egrediantur."*

The assertion that the young grow from the nipple was again repeated in regard to the Philander Opossum (*Didelphys Philander*) by Valentin in his History of Amboyna, and has even been revived at a comparatively recent period.† Some glimpses of the truth were obtained, however, before the time of the authors who have been last quoted. Hernandez, for example, speaks of the generation of the Opossum almost in the same words in which Cuvier‡ sums up the then existing knowledge of the subject in the second edition of his '*Règne Animal.*' "Quaternos, quinosve parit catulos, quos utero conceptos, editosque in lucem, alvi capacitate quâdam, dum adhuc parvuli sunt, claudit ac servat."§ And Maffei more particularly describes the attachment of the young to the nipple. "Illud autem mirum in Cerigonibus" (Opossums) "ex ejus alvo duæ dependent veluti manticeæ, in iis catulos circumfert, et quidem adeo pertinaciter suoque uberi affixos, ut a perpetuo suctu non avellantur, antequam ad pastum ipsi per se progredi valeant."||

Nevertheless, as the uterine gestation is here simply alluded to without any detailed observations in proof of it, the assertion was comparatively of little value in a scientific point of view; and the gemmiparous theory, supported by Marcgrave and Piso, seems to have been prevalent at the time when Dr. Tyson first turned his attention to this subject.

The discovery of the true uterus, recorded by that learned and accurate anatomist in the 20th volume of the Philosophical Transactions, p. 105, was the first step towards a correct theory of the generation of the marsupial animals. It necessarily caused him to reject the gemmiparous theory, but, as often happens in such cases, Tyson was led into the opposite or sceptical extreme; and he was also induced to doubt the really accurate statements of Her-

* De Indiæ utriusque Re Naturali et Medicâ, lib. v. c. 24, 1658.

† See Geoff. St. Hilaire, in the Journal Complémentaire du Dict. des Sciences Médicales, tom. iii. p. 193 (1819): "Si les animaux à bourse naissent aux tétines de leur mère."

‡ "La première de toutes leurs particularités est la production prématurée de leurs petits, qui naissent dans un état de développement à peine comparable à celui auquel des fœtus ordinaires parviennent quelques jours après la conception. Incapables de mouvement, montrant à peine des germes de membres et d'autres organes extérieures, ces petits s'attachent aux mamelles de leur mère et y restent fixés jusqu'à ce qu'ils se soient développés au degré auxquels les animaux naissent ordinairement. Presque toujours la peau de l'abdomen est disposée en forme de poche autour de ces mamelles, et ces petits si imparfaits y sont préservés, comme dans une seconde matrice." Règne Animal, 1829, vol. i. p. 172.

§ Hist. Mexican. lib. ix. p. 330.

|| Joh. Petr. Maffei, Hist. Indica.

* Dr. Purcell, Philosophical Transactions, vol. lxiv. p. 478.

† Philos. Trans. vol. lxxxv. p. 228.

‡ Meckel's Archiv für Physiologie, tom. viii. p. 442.

§ Hist. Rerum Naturalium, Brasil. 1648.

nandez and Maffei^s respecting the function of the marsupial pouch; "for," says Tyson, "here I find they place the mammæ or teats, and they tell very odd stories about it," &c.

The female Opossum which Tyson dissected appears to have been a young one, and therefore, for a reason which has lately been clearly explained by Mr. Morgan, he was unable to detect the nipples within the pouch, and although he confesses that he was equally unable to find them upon the outer skin, he rejected the statements respecting the premature birth of the young and their pendulous attachment to the nipple, and, believing the generation of the Opossum not to deviate from that of ordinary quadrupeds, he limited the function of the marsupium to that of affording a temporary shelter to the young in time of danger.

The assertions of Hernandez and Maffei^s were soon, however, corroborated by other observers; and Daubenton* repeated and confirmed the dissections of Tyson, so far as regarded the existence and general form of the uterus; but no satisfactory explanation was offered as to the nature or precise period of the uterine development or of the passage of the young to the marsupium.

The next really important advance towards the solution of this problem was made by John Hunter, who in the dissection of some marsupial fœtuses of the Kangaroo detected evidences of a deviation from the ordinary mode of mammiferous development, in the absence of the usual traces of a placental organization; there being in these fœtuses no perceptible remains either of an urachus, of umbilical arteries, or of an umbilical vein. The beautiful series of preparations† exhibiting these and other interesting facts in the structure of the mammary‡ fœtus of the Kangaroo are preserved in the Museum of the Royal College of Surgeons, and afforded the principal materials for the paper on Marsupial Generation, published by Mr. (afterwards Sir Everard) Home, in the 85th vol. of the Philosophical-Transactions (1795). I have already shewn that one of the chief grounds of the theory of marsupial generation there proposed is untenable, the supposed remains of the fœtus,§ described as being situated in the corpus uteri, (vaginal cul-de-sac,) being nothing more than a portion of the inspissated secretion commonly present both in this sac and the lateral canals. The temporary orifice by which the fœtus is stated to pass immediately from the so called corpus uteri into the vagina (uro-genital passage) does not exist.

In the subsequent theory of marsupial gene-

ration propounded by Sir Everard Home,* the 'cornua uteri' of Tyson are regarded as portions of the Fallopian tubes. These he believes to furnish the yelk of the ovum, while the lateral canals, 'uteri reduplicati' of Tyson, secrete the albumen; the ovum is supposed to be impregnated and incubated in the uterus, (middle cul-de-sac formed by the communication of the two vaginal canals,) out of which the young one is stated to pass into the vagina (uro-genital passage) by a particular opening, which prior to gestation does not exist.

The only observations published by John Hunter himself relative to marsupial generation are contained in the 'Zoological Appendix to White's Voyage to New South Wales,' where, in the introduction to his descriptions of the quadrupeds of that country, Mr. Hunter alludes to the American Opossum, and observes, "there is something in the mode of propagation in this animal that deviates from all others; and though known in some degree to be extraordinary, yet it has never been attempted, where opportunity offered, to complete the investigation. I have often endeavoured to breed them in England; I have bought a great many, and my friends have assisted me by bringing them or sending them alive, yet never could get them to breed; and although possessed of a great many facts respecting them, I do not believe my information is sufficient to complete the system of propagation in this class."

At this period, when it was admitted on all hands that some remarkable peculiarities were connected with the marsupial generation, and yet their precise nature and signification remained unelucidated by any direct and accurate observation or experiment, it is not surprising that the subject should have given rise to many curious hypotheses and speculations; those of Sir Everard Home have already been noticed. I shall next briefly allude to the writings of M. Geoffroy St. Hilaire.

The fruitful and discriminating labours of this talented Naturalist in advancing the zoological history of the Marsupialia cannot be too highly esteemed, but his attempts to elucidate their generative economy have been less successful.

Placing an undue reliance on the relation of Count Aboville,† he first revived the gemiparous doctrine,‡ meeting the objection afforded by Tyson's discovery of an uterus, by the remark that the fœtus of the marsupial animal has never been found there; but that the teats are developed in the ratio of the size and according to the number of the young: that mules equally possess a generative apparatus, which is stricken with sterility: that some plants with a perfect system of procreative organs, nevertheless propagate by gemma-

* Philos. Trans. 1819, p. 234, and Lectures on Comparative Anatomy, vol. iii.

† See the note at the end of the 2d volume of 'Chastelleux Voyage à l'Amérique Septentrionale, Paris, 1786.'

‡ Journal Complémentaire du Dict. des Sciences Médicales, 1819.

* Buffon, Hist. Naturelle, vol. x.

† See Nos. 3758-3777, Physiol. Catal. vol. v. p. 209.

‡ I adopt this term from M. de Blainville, in preference to the term 'marsupial' previously proposed by Dr. Barton, to express the condition of the young of the Marsupialia from the time they enter the pouch to that of quitting the nipple, or to the close of the period of their uninterrupted attachment to the nipple.

§ No. 3460 F. Physiol. Series, Mus. R. Coll. of Surgeons.

tion, &c. This theory, however, was abandoned, or at least considerably modified after the publication of Dr. Barton's letters relative to the breeding of the Opossum. The product of marsupial generation is then stated by M. Geoffroy to quit the uterus in the condition of a gelatinous ovulum, comparable to a Medusa, and to become organically connected with the nipple by continuity of vessels. He supposed, therefore, that a flow of blood followed the detachment of the mammary fœtus from the nipple,* and even speculates upon the signification of the thyroid gland, on the strength of this hypothetical confluence of the maternal and fœtal vascular systems in the marsupial tribe.†

In another essay M. Geoffroy abandons this opinion, it having been proved by repeated observation that the adhesion of the fœtus to the nipple is by simple contact merely;‡ and finally, he falls into the opposite extreme, and from some appearances of an urachus which were pointed out to him in a very small fœtus of an American Opossum, he describes them as vestiges of a placental organization.

Mr. Morgan,§ in his elaborate and excellent Memoirs on the Structure and Development of the Mammary Organs of the Kangaroo, bears testimony to the simply mechanical mode of attachment between the mammary fœtus and the nipple in the Kangaroo, and was the first to show that the young animal, in its blind and naked condition, prior to the act of voluntary detachment,—the birth 'à la manière des Marsupiaux,' as it is called by M. Geoffroy,—would bear a separation from the nipple for two hours, and voluntarily regain its hold. The mammary fœtus of the Kangaroo on which Mr. Morgan experimented was nearly the size of a fully grown Norway rat. Mr. Collie, surgeon R.N. in a letter addressed from New South Wales, and published in the Zoological Journal, (No. xviii. p. 239.) obtained the same result in detaching from the nipple of a smaller species of Kangaroo (*Macropus Brunii*) a mammary fœtus, not two inches in length: he says, "I gently pressed with the tip of my finger the head of the little one away from the teat of which it had hold, and continuing pressing a little more strongly for the space of a minute altogether, when the teat which had been stretched to more than an inch came out of the young one's mouth, and showed a small circular enlargement at its tip, well adapting it for being retained by the mouth of the sucker."

* Geoffroy St. Hilaire, in detailing some observations on a Kangaroo in the 'Annales des Sciences,' observes, "car le sang aperçu à la litière est un indice qu'à ce moment le fœtus s'est détaché de la tétine et qu'il est né définitivement à la manière des marsupiaux." Vol. ix. p. 342, 1827.

† "Des vaisseaux nourriciers se repandroient-ils des parties du pharynx le long et entre les lames de la trachée artère pour entrer le cœur, et (conjecture de M. Serres) le gland thyroïde seroit-il le point de leur reunion?" Geoff. St. Hilaire, *Mémoires du Muséum*, tom. xix. p. 406, 1822.

‡ Art. Marsupiaux, *Dict. des Sciences Nat.* tom. xix. 1823.

§ Transactions of the Linnaean Society, vol. xvi. pp. 61, 455.

—"An hour afterwards the young was observed still unattached, but in about two hours it had hold of the teat, and was actively employed sucking."

Dr. Barton's very interesting observations on the American Opossum are as follows:—"The female *Didelphis Woopink* sometimes produces sixteen young ones at a birth. I have actually seen this number attached to the teats, but never a greater number. When they are first excluded from the uterus, they are not only very small but very obscurely shaped. The place of the future eyes is merely marked by two pale bluish specks; we see no ears; in short the animal is a mere mis-shaped embryo. Its mouth, which is afterwards to become very large, is at first a minute hole, nearly of a triangular form, and just of a sufficient size to receive the teat, to which the little creature adheres so firmly, that it is scarcely matter of surprise that Beverly* and other writers have asserted that the young grow fast to the teats.

"It is not true that the young cannot be detached from the mother without the loss of blood; I can assert the contrary from many experiments made upon embryos weighing nine grains and upwards. I have fully satisfied myself as to all the various circumstances, both in the structure and in the exertions of the minute animal, which enable it, while yet a mere speck of living matter, to cling so firmly to the fountain of its support.

"—The wonderful little *Didelphis* is by no means the inanimate or the passive being some physiologists and naturalists have represented it.†

"The toes of the fore-feet of the new born embryo opossum are furnished with sharp and hard nails or claws, but this is not the case with the hind-feet. The latter are for some weeks of little use to the animal; but by means of the former it is enabled to cling most firmly to the teat, and especially to the hair in the marsupium immediately around the teat.

"—An opossum-embryo, or fœtus, which weighed sixty-seven grains, lived upwards of thirty hours after I had detached it from the teat. Another which weighed 116 lived thirty-eight hours, at which time I killed it by putting it in spirits.

"Superfœtation (I should perhaps in strict propriety say *uterine* superfœtation) is wholly incompatible with the established laws of the economy of the *Didelphis*. But Nature, always provident, wastes no time. While, therefore, the first litter of young opossums are fast approaching to their adult state, the mother accepts the ardour of the male; she is impregnated; and after a gestation which is not, I think, remarkably short, if we consider the small size of the embryos when they are excluded from the uterus, the marsupium is destined to perform the office of a second, I was going to say a more important, uterus; just at the time when the first litter have attained such a size that they are no longer (one or two of

* History of Virginia, p. 136, 1722.

† Pennant, *Arctic Zool.* i. p. 84.

them at the utmost) capable of taking refuge in her pouch.*

Besides the satisfactory evidence, thus afforded by different and independent observers, respecting the condition of the mammary fœtus and its true relations to the nipple, the discovery of the uterine fœtus was announced nearly at the same time by two naturalists in two different species of marsupial animals. Mr. Collie, whose experiment on the young mammary fœtus of a Kangaroo has just been quoted, states in the same letter, "I have just now procured two gravid uteri, (of the *Macropus Brunii*,) in which fœtuses seem to be arrived at, or very near to, the termination of the period of gestation. One of them, which is about the size of the smallest young already mentioned, which was about one-half larger than the body of the common wasp, as being in the abdominal sac, has protruded through an opening inadvertently made in the uterus, and is distinctly seen through its transparent membranes and the liquor amnii."† About the same time Dr. Rengger, a naturalist who was detained several years by the Dictator Francia in Paraguay, gave the following account of the generation of a species of Opossum (*Didelphis Azara*) in his work on the Mammalia of that province. "The fœtuses are developed in the cornua uteri, and not in the lateral canals. Some days after impregnation they have the form of small round gelatinous corpuscles, which do not appear, even when examined with a lens, to have any communication with the mother, but a red line indicates the first commencement of development. Towards the end of gestation, when the fœtuses have attained the length of six lines, they are seen to be enveloped in a membrane and provided with an umbilical chord, which is united to the uterus by the medium of many filaments. The head, the four extremities, and tail are recognizable with the naked eye, but those fœtuses which are nearest the Fallopian tubes are generally least advanced. "In gestation they make the circuit of the lateral canals, in which they are found to be deprived of their fœtal envelopes, and to have no communication with the parent by means of the umbilical chord; whilst one fœtus was found in this situation, two others were still in the body of the uterus (vaginal cul-de-sac), from which the umbilical chords were not yet detached. At this period a slight enlargement of the cul-de-sac and lateral canals was the only change perceptible in them."‡

Thus, by the various observations derived from the different sources above indicated, the following propositions are satisfactorily established, viz. that the young of the Marsupialia are developed, primarily, as Tyson conjectured, in the true uteri or cornua uteri; but that, contrary to Tyson's opinion, they are, as

compared with other Mammalia, prematurely born; and that, nevertheless, the attachment of the immature young to the nipple is essentially the same as in ordinary mammals, the young marsupial being nourished by the lacteal secretion, and its blood aerated by its own independent respiratory actions.

Such, therefore, being the condition of the problem of marsupial generation in the year 1830, there remained to be determined by exact experiment and observation the period of uterine gestation, the structure of the fetal envelopes and appendages, the nature of the connection, if any, between the uterine fœtus and the womb, the manner of the uterine birth, and the condition and powers of the new-born young.

With a view to the solution of these questions, I applied for and obtained from the Council of the Zoological Society permission to perform the requisite experiments on the Kangaroos in the menagerie in Regent's Park. A healthy female (*Macropus major*, Shaw) was separated from the rest; she had a young one which measured about one foot two inches from the nose to the root of the tail, and which continued to return to the pouch for the purpose of sucking and for shelter. The right superior nipple was the one in use; it was nearly two inches long, and one-third of an inch in diameter; the mammary gland formed a large swelling at its base. The other three nipples were everted, and about half-an-inch in length.

A healthy full-grown male was admitted into the paddock with this female for a certain period each day, and watched, during that time, by the keeper or myself. In the course of a week the female seemed to be in a condition to excite the sexual ardour, and after a few days toying on the part of the male, she received his embrace on the 27th August, at 1 p.m. The female stood with her fore-paws off the ground, the male mounted, 'more canino,' embracing her neck with his fore-paws, and retained his hold during a full quarter of an hour; during this period the coitus was repeated three times, and on the second occasion much fluid escaped from the vulva. The male was removed from the female in the evening of the same day, and was not afterwards admitted to her. On September the 2d, six days after the coitus, I examined the pouch of the female, and this scrutiny was repeated every morning and evening until the birth of the young kangaroo had taken place. I select the following from the notes taken on those occasions:—

"Sept. 6th.—10th day of gestation. The pouch is nearly free from its peculiar brown musky secretion. The right superior nipple retains its large size, and the young one that has left the pouch returns occasionally to suck.

"Sept. 11th.—15th day of gestation. No appearance of a mammary fœtus; nipples in the same condition; the young kangaroo continues to suck and return to the pouch for shelter.

"Sept. 30th.—34th day. The nipple in use by the young kangaroo (which has died) is diminished in size, and the brown secretion

* Barton, 'Facts, Observations, and Conjectures relative to the Generation of the Opossum.' *Annals of Philosophy*, vol. vi. 1823, p. 349.

† *Zoological Journal*, vol. v. p. 240.

‡ From the Analysis of Rengger's "Sangethleren von Paraguay" in the *Bulletin des Sciences Nat.* tom. xxi. p. 469.

has begun to be formed. Qy.—Will the fœtus seize the larger nipple as the readiest, or be directed to another more proportionate to the size of its mouth?

“ Oct. 4th.—38th day. The keeper has observed the female putting her nose into the pouch, and licking the entry. She was examined at six in the evening; there was a slight increase of the brown secretion; the nipple formerly in use has diminished one-third in size; the other nipples indicate no appearance of approaching parturition.

“ Oct. 5th.—39th day. The keeper examined the pouch at seven this morning, and found there the young one attached to a nipple. On being made acquainted with this fact I repaired to the Zoological Gardens, and examined the pouch. The new-born kangaroo (fig. 140) was attached to the left superior nipple (fig. 140, a), to the point of which it adhered pretty

Fig. 140.



New-born fœtus and left nipples, *Macropus major*.

firmly. It measured one inch from the mouth to the root of the tail, was quite naked, and covered by a thin semitransparent vascular integument; the place of attachment of the umbilical chord was obscurely indicated by a longitudinal linear cicatrix. The fore-legs were longer and stronger than the hind ones, and the digits were provided with claws; the toes were developed on the hind legs; the body was bent forward; and the short tail tucked in between the hind legs. This little animal breathed strongly, but slowly; no direct act of sucking could be perceived. Such, after a gestation of thirty-eight days, is the condition of the new-born young of a species of Kangaroo, of which the adult, when standing erect on his hind feet and tail, can reach to the height of seven feet. The birth having taken place in the night, the mode of transference of the young to the pouch and nipple was not observed.

The hypothesis of an internal passage from the uterus to the pouch—countenanced by some imperfect anatomical observations on the course of the round ligament to the abdominal ring, and the continuation thence of the cremaster to the posterior part of the mammary gland, together with the primitive inverted condition of the nipple—is wholly refuted by more exact observations of the conditions of these parts. I was chagrined at the loss of so favourable an opportunity of determining, *ex visu*, this interesting part of the problem; for it had been my intention, if the symptoms of approaching pregnancy had been more marked, to have established a night as well as day-watch over the female; but by placing perhaps too

much reliance on the observations on the pregnant kangaroo recorded in the 9th volume of the *Annales des Sciences*, in which the duration of four months is assigned to the uterine gestation of this species, I had not anticipated so speedy a termination of that process as resulted from my experiment.

In order, however, to remedy, as far as might be, this omission, it occurred to me that if the young kangaroo were detached from the nipple and deposited at the bottom of the pouch, any actions of the parent, by which its original transference from the uterus to the nipple had been aided or effected, might be instinctively repeated, and thus an insight be gained into their nature. As, therefore, the experiments of Messrs. Morgan and Collie seemed to show that this might be done without necessarily causing the death of the young one, I performed the experiment with the sanction and assistance of Mr. Bennett, then Secretary of the Zoological Society.

“ Oct. 9th.—I examined the pouch of the female, and found the young one, now four days old, evidently grown, and respiring vigorously; it adhered more firmly to the nipple than was expected, requiring a continued gentle pressure to detach it: when that took place, a minute drop of whitish fluid, a kind of serous milk, was expressed from the nipple. No blood followed, nor anything to indicate a solution of organic continuity; the extremity of the nipple was small, not swollen as in Mr. Collie's case. The young one moved its extremities vigorously. It was deposited at the bottom of the pouch, and the mother was left and then carefully watched. Soon after this was done she seemed uneasy, was often scratching the exterior of the pouch, and every now and then dilated the cavity with her two fore-paws, grasping the sides of the aperture, and pulling them in contrary directions, just as in drawing open a bag; she then inserted her muzzle pretty deeply into the pouch, moving her head about as if to lick off something from the interior, or perhaps to move the little one. She kept her nose in the pouch sometimes for half-a-minute. I never observed her to put her fore-legs, or either of them, in the pouch; they were always occupied in keeping open the mouth of the pouch, while she was at work with her mouth within it. She generally concluded by licking the mouth of the pouch, and occasionally she stooped down to lick the cloaca, which she could reach with ease. When she scratched the outside of the pouch it seemed as if to push up something that was inside towards the aperture. These actions she repeated at short intervals for about an hour; she then lay down and appeared quiet. She had also lain down in the intervals of the above operation, but during that time never meddled with the pouch; when stimulated to do so by some uneasy sensation, she always rose upon her hind feet, and then inserted her muzzle alternately into the pouch and vulva. Observing the freedom with which she could reach both these parts, I was led to believe that the mode of removal of the young from the vulva to the

pouch was by the mouth of the mother. Her fore-paws, in this case, would be used, not for the transport of the young, but for keeping the mouth of the pouch open for its reception, it being deposited therein by the mouth, and so held over a nipple until the mother had felt it grasping the sensitive extremity of the nipple.

This means of removal is consistent with analogy; dogs, cats, mice, all transport their young from place to place with the mouth. In the case of the kangaroo, it may be supposed that the fœtus would be held by the lips only, not the teeth, on account of its delicate consistence. Whether this theory, suggested by witnessing the actions of the mother after an artificial separation of the Marsupial fœtus, be correct, must be confirmed by actual observation. There is no internal passage from the uterus to the pouch:—the mouth of the vagina cannot be brought into contact with that of the pouch, either by muscular contraction in the living or by any force of stretching in the dead kangaroo:—as the young was proved by the result of this experiment not to have the power of itself to regain the nipple, *à fortiori* we may conclude that it could not transfer itself from the vulva to the interior of the pouch and to the apex of the nipple:—the fore-paws of the Kangaroo would not so effectually protect the tender embryo from the external air as the mouth, nor so safely ensure its passage to the pouch, notwithstanding that they are adroitly used in grasping objects, being similar, in respect of the extent and freedom of motion of the digits, to the fore-paws of the Rodents.

After the mother had rested quietly for a short time, we again examined her, but found the young one still detached, moving more vigorously than before. On an examination two days afterwards the marsupium was found empty: the young one had died and had probably been removed by the mother.

Thus the period of uterine gestation, the condition of the new-born young, and the probable mode of its transference to the nipple being determined in the genus *Macropus*, it next remained to be determined how the embryo was nourished in utero. The means of giving the required solution were shortly after afforded by specimens of the impregnated uterus, transmitted to me by Mr. George Bennett, Captain Grey, and Dr. Sweatman. The first was of the *Macropus major*, nearly two-thirds of uterine gestation having been completed; the second was of the *Macropus penicillatus*, at about the same or somewhat earlier period of gestation; the third exhibited the uterine fœtus at nearly the completion of that period of its existence.

Before, however, giving the summary of what I have elsewhere* recorded respecting the uterine development of the Marsupialia, a description of the ovarian ovum must be premised.

In the Kangaroo this part agrees in all essential points with the observed ovarian ova of placental Mammalia: the main modification

is the greater proportion of vitelline fluid and globules, and the smaller proportion of fluid between the external membrane of the ovum (vitelline membrane) and the ovarian vesicle, or lining membrane of the ovisac.

In a female *Macropus Parryi*, the ovum from the largest ovisac of the left ovary measured $\frac{1}{10}$ th of a line in diameter, the germinal vesicle $\frac{1}{10}$ th of a line in diameter.

We are at present ignorant of the changes that take place in the development of the ovum between the period of impregnation until about the twentieth day of uterine gestation. At this time, in the great Kangaroo (*Macropus major*), the uterine fœtus (*fig. 138*) measures eight lines from the mouth to the root of the tail; the mouth is widely open (*fig. 141*); the tongue large and protruded; the nostrils are small round apertures; the eyeball not yet wholly defended by the palpebral folds; the meatus auditorius externus is not provided with an auricle; the fore-extremities are the largest and strongest; they are each terminated by five well-marked digits; those of the hind legs are not yet developed; the cervical fold of the mucous layer or the branchial fissure is still unenclosed by the integument. The tail is two lines long, thick and strong at the commencement; impressions of the ribs are visible at the sides of the body; the membranous tube of the spinal marrow may be traced along the back between the ununited elements of the vertebral arches; posterior to the umbilical chord there is a small projecting penis, and behind that, on the same prominence, is the anus. This fœtus and its appendages were enveloped in a large chorion, puckered up into numerous folds, some of which were insinuated between folds of the vascular lining membrane of the uterus, but the greater portion was collected into a wrinkled mass. The entire ovum was removed without any opposition from a placental or villous adhesion to the uterus. The chorion (*a, a, fig. 141*) was extremely thin and lacerable; and upon carefully examining its whole outer surface, no trace of villi or of vessels could be perceived. Detached portions were then placed in the field of a microscope, but without the slightest evidence of vascularity being discernible. The next membrane, whose nature and limits will be presently described, was seen extending from the umbilicus to the inner surface of the chorion, and was highly vascular. The fœtus was immediately enveloped in a transparent amnios.

On turning the chorion away from the fœtus, it was found to adhere to the vascular membrane above-mentioned, into which the umbilical stem suddenly expanded. With a slight effort, however, the two membranes could be separated from each other, without laceration, for the extent of an inch; but at this distance from the umbilicus the chorion gave way on every attempt to detach it from the internal vascular membrane, which here was plainly seen to terminate in a well-defined ridge, formed by the trunk of a bloodvessel.

When the whole of the vascular membrane

* Proceedings of the Zool. Society, 1833. Philos. Trans. 1834.

Fig. 141.



Uterine fetus with chorion and fetal appendages, Macropus major. The fetus is magnified twice the natural size.

(*b*, fig. 141) was spread out, its figure appeared to have been that of a cone, of which the apex was the umbilical chord, and the base the terminal vessel above-mentioned. Three vessels could be distinguished diverging from the umbilical chord and ramifying over it. Two of these trunks contained coagulated blood, and were the immediate continuations of the terminal or marginal vessel: the third was smaller, empty, and evidently the arterial trunk. Besides the extremely numerous ramifications dispersed over this membrane, it differed from the chorion in being of a yellowish tint. The amnion (*c*, 141) was reflected from the umbilical chord, and formed, as usual, the immediate investment of the fetus.

The umbilical chord measured two lines in length and one in diameter. It was found to contain the three vessels above-mentioned, with a small loop of intestine; and from the extremity of the latter a filamentary process was continued to the vascular membrane. The

margins of the umbilicus or abdominal opening were very strong, offering much resistance to their division. On tracing the contents of the chord into the abdomen, the two larger vessels with coagulated blood were found to unite; the common trunk then passed backwards beneath the duodenum, and after being joined by the mesenteric vein, went to the under surface of the liver, where it penetrated that viscus: this was consequently an omphalomesenteric or vitelline vein. The artery was a branch of the mesenteric. The membrane, therefore, upon which they ramified, answered to the vitellicle, i. e. the vascular and mucous layers of the germinal membrane, which spreads over the yolk in oviparous animals, and which constitutes the umbilical vesicle of the embryo of ordinary Mammalia. The filamentary pedicle which connected this membrane to the intestine was given off near the end of the ileum, and not continued from the cæcum, the rudiment of which was very evi-

dent half a line below the origin of the pedicle. (See the fœtus in *fig.* 141.)

The small intestine above the pedicle was disposed in five folds. The first from the stomach or duodenum curved over the vitelline vein, and the remaining folds were disposed around both the vitelline vessels. From the cœcum, which was given off from the returning portion of the umbilical loop of the intestine, the large intestine passed backwards to the spine, and was then bent, at a right angle, to go straight down to the anus. The stomach did not present any appearance of the sacculated structure so remarkable in the adult, but had the simple form of a carnivorous stomach. The liver consisted of two equal and symmetrically disposed lobes. The vena portæ was formed by the union of the vitelline with the mesenteric, and doubtless the other usual veins, which were, however, too small to be distinctly perceived. The diaphragm was perfectly formed.

The vena cava inferior was joined, above the diaphragm, by the left superior cava, just at its termination in a large right auricle. The ventricles of the heart were completely joined together, and bore the same proportions to each other as in the adult,—a perfection of structure which is not observed in the embryos of ordinary *Mammalia* at a corresponding period of development. The pulmonary artery and aorta were of nearly the same proportionate size as in the adult: the divisions of the pulmonary artery to the lungs were at least double the size of those observable in the embryo of a sheep three inches in length. The ductus arteriosus, on the contrary, was remarkably small. The aorta, prior to forming the descending trunk, dilated into a bulb, from which the carotid and subclavian arteries were given off.

The lungs were of equal size with the heart, being about a line in length, and nearly the same in breadth: they were of a spongy texture and of a red colour, like the veins, from the quantity of blood they contained. This precocious development of the thoracic viscera is an evident provision for the early or premature exercise of the lungs as respiratory organs in this animal: and on account of the simple condition of the alimentary canal, the chest at this period exceeds the abdomen in size.

The kidneys had the same form and situation as in the adult. The supra-renal glands were half the size of the kidneys.

The testes were situated below the kidneys, and were one-half larger than those glands, the superiority of size depending on their large epididymis, with the adherent remains of the Wolffian body. They continue within the abdomen for six weeks after uterine birth.

At a later period of uterine development, when the fœtus, measured in a straight line from the mouth to the root of the tail, is ten lines in length, the urachus expands into a small allantois (*a*, *fig.* 141), of a flattened pyriform figure, and finely wrinkled external surface. This bag insinuates itself between the amnios and chorion, carrying along with it two small hypo-

gastric arteries and an umbilical vein, but not establishing by their means an organized and vascular surface of the chorion by which a placental attachment is formed between the ovum and the womb. The allantois depends freely from the end of the umbilical chord, and has no connexion at any part of its circumference with the adjoining membrane. Its office is apparently that of a receptacle of urine.

The vitellicle or umbilical sac presented the same large proportionate size and vascular structure as in the first described fœtus. The chorion which enveloped this fœtus and its appended sacs was adapted to the cavity of the uterus by being disposed in innumerable folds and wrinkles. It did not adhere at any part of its surface to the uterus, but presented a modification not present in the chorion of the earlier fœtus, in being partially organized by the extension of the omphalo-mesenteric vessels upon it from the adherent vitellicle. The digits of the hind legs were distinctly formed in this embryo.

The new-born fœtus of the great Kangaroo does not exceed, as we have already shown, one inch in length; its external characters have been already described. Dr. Barton has given the following account of the Opossum (*Didelphys Virginiana*) at an analogous period. "I have been so fortunate as to ascertain the size and weight of several embryos immediately after their exclusion from the uterus. One of them weighed only one grain! The weight of each of the six other young ones was but little more than this. The young opossums, unformed and perfectly sightless as they are at this period, find their way to the teats by the power of an invariable, a *determinate* instinct" (qu.?). "In this new domicile they continue for about fifty days, that is, until they attain the size of a common mouse (*Mus musculus*), when they begin to leave the teats *occasionally*, but return to them again until they are nearly the size of rats.

"At the end of about fifty or fifty-two days from its first reception in the pouch the eyes of the young begin to open.

"I have found that the same embryo has increased in weight 531 grains in sixty days, that is, at a rate of almost 9 grains daily. The animal attains to nearly its full growth in about five months; but never, I believe, (in our latitudes I mean,) procreates the first year of its existence.

"On the 21st of May, upon looking into the box which contained the female Opossum, I found that she had just excluded from her uterus seven embryos; the smallest of which scarcely weighed one grain, another barely two grains, and the remaining five (taken together) exactly seven grains."*

In the Kangaroo about ten months elapse before the mammary fetus quits the pouch: it has, prior to this period, quitted the nipple,

* Barton, in *Annals of Philosophy*, vi. (1823), p. 349. "Facts, Observations, and Conjectures relative to the Generation of the Opossum."

and occasionally protrudes its head and changes its position in the pouch.

The anatomical condition and progressive development of the mammary fœtus of the Marsupialia offer a subject of highly interesting research, especially if compared with the same circumstances in the uterine fœtus of an equal sized and analogous placental species. Much still remains to be done in this chapter of the history of Marsupial generation; at present I have to offer the following observations.

By comparing the new-born Kangaroo with a similarly sized fœtus of a sheep, we find that, although, in the Kangaroo, the ordinary laws of development have been adhered to in the more advanced condition of the anterior part of the body and corresponding extremities, yet that the brain does not present so disproportionate a size; and the same difference is observable in the uterine fœtus of the Kangaroo, even when compared with the same sized embryo of an animal of an inferior class, as the bird. This difference, I apprehend, is owing to the rapidity with which the heart and lungs acquire their adult structure in the Kangaroo, whereby the passage of the purer and more nutritious blood through the foramen ovale and left auricle to the primary branches of the aorta and so to the brain is impeded. The brain, however, of the mammary fœtus, though exhibiting a low degree of development, yet is of a firmer texture than in a similarly sized fœtus of a sheep, and attains its ultimate proportion by a more gradual process of growth.

In a mammary fœtus, one inch and a half in length, the urinary bladder is largely developed, and adheres by its apex to the peritoneum, exactly opposite that part of the abdominal integument where a small linear ridge indicated the previous attachment to the umbilical chord and appendage. There are also minute but distinct traces of umbilical arteries running up the sides of the bladder to this point of attachment. As the urinary bladder becomes afterwards expanded in the abdomen, the peritoneum is gradually, as it were, drawn from this part of the abdominal parietes, forming an anterior ligament of the bladder. In a mammary fœtus of the Kangaroo about a month older than the above, there was at the superior part of this duplicature a small projecting point from the bladder, like the remains of a urachus; but the fundus, now developed considerably above this point, was covered with a perfectly smooth layer of peritoneum; and it is this modification, I apprehend, which led Hunter to suppose that there was no trace of urachus or umbilical arteries in the fœtuses of the *Marsupialia*. In the Sloth, the Manis, and the Armadillo, the urachus is continued in the same manner from the middle of the anterior part of the bladder, and not from the fundus.

In neither of the above fœtuses of the Kangaroo was there any corresponding trace of umbilical vein, although there was a distinct ligamentum suspensorium hepatis, formed by a duplicature of the peritoneum descending

from the diaphragm to the notch lodging the gall-bladder, and not entering, as usual, the fissure to the left of that notch: the allantois is too small, and its function too limited for the preservation of any permanent trace of its peculiar vein.

The small intestines in the mammary fœtus, one inch and a half long, when compared with those of the uterine fœtus above described, were found to have acquired several additional convolutions; the fold to which the umbilical vesicle had been attached was still distinct, but now drawn in to the back of the abdomen. The cœcum was much elongated, but the colon proportionately not more developed than in the uterine fœtus; the subsequent modification, therefore, of the large intestines seems evidently destined to complete the digestion of the vegetable food.

The stomach was not sacculated, but the division between the cardiac and middle compartments was more marked than in the uterine fœtus. The liver had now advanced in its development beyond the oviparous form which it presented in the uterine fœtus, the right lobe being subdivided into three. The supra-renal glands bore the same proportionate size to the kidneys. The testes were still larger than the kidneys, and were situated below them, not having yet passed out of the abdomen: this takes place when the mammary fœtus is about three inches long from the nose to the root of the tail. The ductus arteriosus was distinct in the small mammary fœtus, but I could not perceive any trace of the thymus gland. Is this gland unnecessary on account of the precocious development of the lungs? or because of the small size and gradual growth of the brain? The latter appears the more probable condition of its absence, as in the ovoviviparous classes with small and simple brains the thymus gland is rudimental or of doubtful existence.

Notwithstanding that the new-born Kangaroo possesses greater powers of action than the same sized embryo of a sheep, and approximates more nearly in this respect to the new-born young of the rat, yet it is evidently inferior to the latter. For, although it is enabled by the muscular power of its lips to grasp and adhere firmly to the nipple, it seems to be unable to draw sustenance therefrom by its own unaided efforts. The mother, as Professor Geoffroy and Mr. Morgan have shown, is therefore provided with the peculiar adaptation of a muscle (analogous to the cremaster) to the mammary gland, for the evident purpose of injecting the milk from the nipple into the mouth of the adherent fœtus. Now it can scarcely be supposed that the fetal efforts of suction should always be coincident with the maternal act of injection; and if at any time this should not be the case, a fatal accident might happen from the milk being forcibly injected into the larynx, unless that aperture were guarded by some special contrivance. Professor Geoffroy first described the modification by which this purpose is effected; and Mr. Hunter appears to have anticipated the ne-

cessity for such a structure, for he dissected two small mammary fetuses of the Kangaroo for the especial purpose of showing the relation of the larynx to the posterior nares. The epiglottis and arytenoid cartilages are elongated and approximated, and the rima glottidis is thus situated at the apex of a cone-shaped larynx, (fig. 142, c,) which projects, as in the *Cetacea*, into the posterior nares, where it is closely embraced by the muscles of the soft palate. The air-passage (b) is thus completely separated from the fauces, and the injected milk passes in a divided stream on either side the larynx to the œsophagus.

Fig. 142.

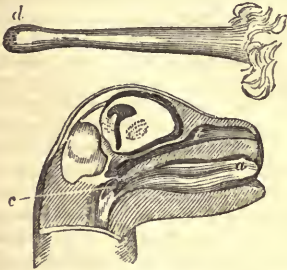

Nipple, and head of Mammary Fœtus, Kangaroo.

Thus aided and protected by modifications of structure, both in the system of the mother and its own, designed with especial reference to each other's peculiar condition, and affording, therefore, the most irrefragable evidence of creative foresight, the small offspring of the Kangaroo continues to increase, from sustenance exclusively derived from the mother, for a period of about eight months. During this period the hind legs and tail assume a great part of their adult proportions; the muzzle elongates; the external ears and eyelids are completed; the hair begins to be developed at about the sixth month. At the eighth month the young Kangaroo may be seen frequently to protrude its head from the mouth of the pouch, and to crop the grass at the same time that the mother is browsing. Having thus acquired additional strength, it quits the pouch and hops at first with a feeble and vacillating gait, but continues to return to the pouch for occasional shelter and supplies of food till it has attained the weight of ten pounds. After this it will occasionally insert its head for the purpose of sucking, notwithstanding another fetus may have been deposited in the pouch; for the latter, as we have seen, attaches itself to a different nipple from the one which had been previously in use.

Mammary Organs.—In the young Marsupial, as Mr. Morgan was the first to observe in the Kangaroo, the nipples are not visible, but are indicated by the orifices of a kind of cutaneous preputial sheath in which they are concealed. M. Laurent has noticed a similar condition of the nipples in a mammary fetus of an Opossum and a *Perameles*. I have also observed it in the mammary fetus

of a *Petaurist* and *Dasyure*: it is doubtless, therefore, common to all Marsupials.

Once naturally protruded and the preputial sheath everted, the nipples, in the Kangaroo at least, continue external. They are longer and more slender than in other quadrupeds, and when in use generally present a terminal expansion (fig. 142, d). This part lies in a deep longitudinal fossa on the dorsum of the tongue (a, fig. 142); and the originally wide mouth of the uterine fetus is changed to a long tubular cavity, with a terminal sub-circular or triangular aperture just large enough to admit the nipple, to which the young Marsupial thus very firmly adheres.

In the *Phascogale*, in which the nipples are relatively larger than usual, and of a subcompressed clavate form, the young, when grown too large to be carried in the pouch, are dragged along by the mother, if she be pursued, hanging by the nipples.

The number of nipples bears relation in the marsupial, as in the placental Mammalia, to that of the young brought forth at a birth; although from the circumstance of the produce of two gestations being for a short time suckled simultaneously, the nipples are never so few. Thus the uniparous Kangaroo has four nipples; of which the two anterior are generally those in use: the *Petaurists*, which bring forth two young at a birth, have also four nipples: the *Thalycine* has four nipples: the multiparous *Virginian Opossum* has thirteen nipples, six on each side and the thirteenth in the middle. In the *Didelphys Opossum* there are nine nipples, four on each side and one in the middle. The *Didelphys dorsigera* has the same number of nipples, although six is the usual number of young at a birth (fig. 143). In the *Phascogale penicillata* there are eight nipples arranged in a circle. The *Perameles nasuta* has the same number of nipples arranged in two slightly curved longitudinal rows; this Marsupial has three or four young at a birth.

The nipple in all the Marsupials is imperforate at the centre; the milk exudes from six to ten minute orifices arranged round the apex. It increases in size with the growth of the mammary fetus appended to it.

The mammary gland has the same essential structure as in the ordinary Mammalia; it has no cavity or udder; its chief peculiarity arises from its being embraced by the muscle, already noticed, which has the same origin and course as the cremaster muscle in the male.

Marsupial pouch.—The development of the pouch is in an inverse ratio to that of the uteri and directly as that of the complicated vagina: thus it is rudimental in the *Dorsigerous Opossum*, which has the longest uteri and the simplest vagina: we may conclude therefore that the young undergo a greater amount of development in the womb in this and allied species.*

* Is there any essential modification of the membranes of the ovum in these small Marsupials? The means of determining this question are most desirable.

Fig. 143.



Female *Didelphys dorsigera*, with young and pouch.

In the Kangaroos and Potoroos, which have the shortest uteri and longest vaginal tubes and cul-de-sac, the marsupial pouch is wide and deep. It is composed of a duplicature of the integument, of which the external fold is supported by longitudinal fasciculi of the panniculus carnosus converging below to be implanted in the symphysis pubis. The mouth of the sac is closed by a strong cutaneous sphincter muscle. The interior of the pouch is almost naked: a few hairs grow around the nipple: it is lubricated by a brown sebaceous secretion. The mouth of the pouch is directed forwards in most Marsupials: the reversed position in the *Perameles* and *Chæropus*, where the mouth is directed towards the vulva, has been already noticed. M. Laurent* has made the interesting observation of the presence of a rudimental pouch in the male mammary fetus of an Opossum: he could not discern equal traces of the nipples: that of the pouch is

soon obliterated, as the scrotum increases in size.

In the male Thylacine the rudimental marsupium is retained, in the form of a broad triangular depression or shallow inverted fold of the abdominal integument, from the middle of which the peduncle of the scrotum is continued. In the female the orifice of the capacious pouch is situated nearer the posterior than the anterior boundary of that receptacle.

A few observations on the claims of the Marsupialia to be regarded as a natural group of animals may not inappropriately conclude this article. Cuvier, in 1816, first separated the marsupial from the other unguiculate quadrupeds, to form a distinct group, which he describes as forming, with the Monotremes, a small collateral chain, all the genera of which, while they are connected together by the peculiarities of the generative system, at the same time correspond in their dentition and diet, some to the Carnivora, others to the Rodentia, and a third tribe to the Edentata. M. de Blainville, in the tables of the Animal Kingdom which he published in the same year, 1816, constituted a distinct sub-class of Cuvier's "small collateral chain" of mammals, and gave to the sub-class the name of *Didelphes* in antithesis to that of *Monodelphes*, by which he distinguished the Placental Mammalia.

The class or sub-class 'Implacentalia,' of which the *Marsupialia* form one order, also includes a second order, the *Monotremata*, which can only be termed 'Didelphes' in the sense in which the word is applicable to many of M. de Blainville's 'Monodelphes,' i. e. in reference to their having two distinct uterine tubes. But the merit of the primary division of the Mammalia into PLACENTALIA and IMPLACENTALIA does not rest upon the appropriateness of the terms, but upon the establishment, by a long series of anatomical researches, of a primary division of the Mammiferous class, which before was a mere hypothesis.

Many acute and sound-thinking naturalists refused their assent to the views of Cuvier and De Blainville, which, as they were supported by a knowledge of the conformity of organization of only the generative system in the Marsupials, were unquestionably defective in the evidence essential to enforce conviction. The best arguments for returning to the older views of classification, and for distributing the Marsupial genera, according to the affinities apparently indicated by their dental and locomotive systems, among the different orders of the Placental Mammalia, have been advanced by Mr. Bennett, the accomplished author of the *Gardens and Menagerie of the Zoological Society delineated*, (vol. i. p. 265); and these have been repeated with approbation, and adopted by later systematists, as by Mr. Swainson.

The discovery of the true affinities of the Marsupialia could only flow from an insight into their whole organization, and the question which Mr. Bennett proposes with reference to the genus *Phascolomys*, "What is there of im-

* *Annales d'Anatomie et de Physiologie*, 1839, p. 237.

portance in the structure of the Wombat, except this solitary character of the Marsupium, to separate it from the Rodent order?"—a question which he might in 1831 have asked with equal force in reference to any other Marsupial genus,—could only be answered satisfactorily by the submission of the Marsupialia in question to a thorough dissection.

Although the Marsupials present modifications of the dental system corresponding with the carnivorous, omnivorous, and herbivorous types, yet they agree with each other, and differ from the analogous Placental Mammalia in having four instead of three true molars, i. e. four molars which are not displaced and succeeded by others in the vertical direction. The incisor teeth, also, either exceed in number those of the analogous Placental classes, or are peculiarly arranged and opposed to each other.

In the locomotive organs it is true that we see some of the Marsupials having a hinder thumb, like the Placental *Quadrumana*; others are digitigrade, with falcate claws, like the Placental *Feræ*; a third, as the Wombat, has the feet adapted for burrowing; a fourth, like the *Cheironectes*, is aquatic, and has webbed feet; yet all these Marsupials agree with each other in having a rotatory movement of the hind foot, analogous to the pronation and supination which, in the placental quadrupeds, are limited when enjoyed at all to the fore feet; and they manifest moreover a peculiar modification of the muscles of the hind leg and foot in relation to these rotatory movements. In those Marsupials, as the Kangaroos, Potoroos, and *Perales*, in which the offices of support and locomotion are devolved exclusively or in great part upon the hind legs, these are strengthened at the expense of the loss of the rotatory movements of the feet; but in the enormous development of the two outer toes, and the conversion of the two inner ones into unguiculate appendages, useful only in cleansing the fur, these Marsupials differ from all Placentals, whilst the same peculiar condition of the toes may be traced through the *Pedimarnous* group of Marsupials. Thus the locomotive organs, notwithstanding their adaptation to different kinds of progression, testify to the unity of the Marsupial group in the two remarkable peculiarities of structure above cited.

The vascular system gives evidence to the same effect. We have seen that the Marsupials present the following peculiarities in the structure of the heart: viz. the right auricle manifests no trace of either *fossa ovalis* or *annulus ovalis*, and receives the two *venæ cavæ superiores* by two separate inlets. This generalization is, however, less urgent than the preceding in the present question, because the modification, as regards the separate entry of the superior *venæ cavæ*, obtains in a few placental species, as in the elephant and certain Rodents; but as the first cited cardiac character is common and peculiar to the Marsupial Mammalia, and as the second, while it is universal in the Marsupials, occurs only as an exceptional condition in the placental

series, the arguments which they afford to the unity of the Marsupial group cannot be overlooked in a philosophical consideration of the affinities of the Mammalia.

With respect to the nervous system, it has been shown that in the structure of the brain, the Marsupialia exhibit a close correspondence with the *Ovipara* in the rudimental state of the *corpus callosum*; the difference which the most closely analogous placental species offer in this respect is broadly marked.

These coincidences in the Marsupialia of important organic modifications of the dental, locomotive, vascular, cerebral, and reproductive systems, establish the fact, that they constitute, with the *Monotremes*, a natural group inferior on the whole in organization to the Placental Mammalia.

The following is a tabular view* of the subordinate divisions in the Marsupialia regarded as an order of the Implacental sub-class of Mammalia:—

* Of the various forms of Marsupial animals attempted to be arranged in natural groups in the present classification, it may be asked which is the typical form? or in other words, which genus combines most of the points of organization peculiarly characterizing the Marsupialia?

We have seen that certain modifications of the nervous, circulating, and generative systems are common to all the genera. But the female generative organs approach nearest to the Rodent type in the small *dorsigerous* Opossums, in which the characteristic external pouch becomes very nearly obsolete. It is not the genus *Didelphys* therefore that we should select as the type of the Marsupials. It appears to me that there is both a dental and a digital character which may be regarded as eminently marsupial; the former, besides the number of true molar teeth, consists in the opposition of six vertical incisors above to a large procumbent single pair below; the latter is exemplified in the atrophied and coadunate condition of the second and third digits of the hinder foot. The *Phalangers*, *Petaurists*, *Koalas*, *Kangaroos*, and *Potoroos* possess, in addition to the ordinary Marsupial characters, both these modifications of teeth and digits. It seems, therefore, that it is from one of these genera that we should select the Marsupial type *par excellence*. If we say the *Phalangers*, it may be objected that the hinder hand and opposable prehensile thumb indicate in these a transition from the Marsupialia to the *Quadrumana*. Should the *Petauri* be our choice, then again we perceive in the development of the lateral tegumentary folds, and their connection with the locomotive members, a tendency to the *Flying Squirrels*. The tail-less *Koala* may be deemed to exhibit in its clumsy form and proportions a resemblance to the *tree-bears*. The *Kangaroos* and *Potoroos* obviously typify the Rodent *Jerboas*, and they have lost the peculiar rotation of the hind leg and the muscular modification connected therewith. If, however, the type of a natural group of animals, and such I have proved the Marsupial group to be, is that which manifests the greatest number of the structural modifications peculiar to the group, and the smallest number of such as are common to other natural assemblages of Mammalia, then the *Koala* has the best claim to typical pre-eminence. The Marsupial bones might be readily supposed to afford a simple indication of the most peculiarly Marsupial animal, if they offered different relative magnitudes in different genera: now the range of variety in this respect is, in fact, considerable, and the Marsupial bones present their greatest development in the *Koala*.

Classification of the Marsupialia.

TRIBES.	FAMILIES.	GENERA.	SUB-GENERA.
1. Sarcophaga.			
Three kinds of teeth, canines long in both jaws; a simple stomach, no <i>intestinum cæcum</i>	Dasyuridæ ...	{ Thylacinus. Dasyurus. Phascogale.	
Extinct transitional forms			
2. Entomophaga.			
Three kinds of teeth in both jaws; a simple stomach, a moderately long <i>intestinum cæcum</i>	Ambulatoria ...	Myrmecobius.	
	Saltatoria	{ Charopus. Perameles.	
	Scansoria	Didelphys	{ Didelphys. Cheironectes.
3. Carpophaga.			
Anterior incisors large and long in both jaws; canines inconstant; stomach simple, or with a special gland; a very long <i>intestinum cæcum</i>	Phalangistidæ ..	{ Phalangista Petaurus	{ Pseudocheirus. Tapoa. Petaurista. Belidia. Acrobata.
4. Poephaga.			
Anterior incisors large and long in both jaws; canines present in the upper jaw only, or wanting; a complex stomach, a long <i>intestinum cæcum</i> ..	Macropodidæ ..	{ Hypsiprymnus. Macropus.	{ Lagocheles. Halmaturus. Macropus. Osphranter.
5. Rhizophaga.			
Two scalpriform incisors in both jaws; no canines; stomach with a special gland; <i>cæcum</i> short, wide, with a vermiform appendage	Phascolomyidæ ..	{ Phascolomys. Diprotodon...	Fossil.

BIBLIOGRAPHY.—*Marcgravius, G.* Historia naturalis Brasiliæ, 1648; *Piso, De Indiæ utriusque re naturali*, fol. 1658. *Hernandez*, Hist. Mexican. lib. ix. p. 330. *Tyson*, Philos. Trans. 1698, vol. xx. *Couper*, Philos. Trans. 1704, vol. xxiv. *Daubenton*, Buffon, Hist. Nat. tom. x. p. 325, 1750. *Aboville, Count*, in Chastelleux Voyage à l'Amérique Septentrionale, 1786. *Hunter, John*, Appendix to White's Journal of a Voyage to New South Wales, 1790. *Home, Sir Everard*, Philos. Trans. 1795, 1819; Lectures on Comparative Anatomy, 1814-1823. *Cuvier, G.* Leçons d'Anatomie Comparée, 1799-1805 and 1836-1840; Annales du Muséum, t. v; Ossements Fossiles, 1822, t. iii.; Règne Animal, 1816 and 1829. *Geoffroy St. Hilaire*, Annales du Muséum, 1803; Journal Complémentaire du Dictionnaire des Sciences Médicales, t. iii. 1819; Mémoires du Muséum, 1822; Anatomie Philosophique, tom. ii. 1822; Dictionnaire des Sciences Naturelles, art. Marsupiaux, 1823; Annales des Sciences Naturelles, 1827. *Meckel, J. F.* Abhandl. aus der menschl. & vergl. Anatomie und Physiologie, 1806; System der vergl. Anatomie, 1821-1828. *Blainville*, Bulletin de la Soc. Philomathique, 1818; Comptes Rendus de l'Acad. des Sciences, 1838. *Tiedemann*, Icones cerebri simiarum, &c. 1821. *Barton, Dr.* Annals of Philosophy, vol. vi. 1823. *Treviranus*, Biologie, 1802-1821; Zeitschrift für Physik. Bd. iii. 1827. *Burdach*, Physiologie, Bd. i. pl. iv. 1822. *Lawrent*, Lettre sur deux sujets d'Anatomie Comparée, Bulletin des Sciences Médicales, Juin 1827; Voyage de la Favorite, 1839; Annales d'Anatomie et de Physiologie, 1839. *Broderip, W. J.* Zoological Journal, 1828. *Grant, Dr. R.* Wernerian Transactions, vol. vi., Anatomy of Perameles nasuta. *Collie, Dr.*

Zoological Journal, No. xviii. 1828. *Ritgen*, Ueber einige Eigenthümlichkeiten im Bau der Beuteltiere, Zeitschrift für organische Physik, Eisenach, 1828. *Leuckhart*, Meckel's Archiv. für Physiologie, t. viii. *Rennger, Dr.* Säugethiere von Paraguay, 8vo. 1829. *Morgan, John*, Trans. Linnæan Society, vol. xvi. 1829 and 1833, Mammary Organs of Kangaroo. *Owen, R.* Proceedings of Zoological Society—1831, Female Organs of Kangaroo; 1833, Uterine Gestation and Fœtus of Kangaroo; 1834, Anatomy of Macropus Parryi; 1835, Anat. of Dasyurus Macrurus; 1836, Anat. of Wombat; 1837, Allantois of Kangaroo; 1838, Anat. of Koala, Osteology of Marsupialia; 1839, Classification of Marsupialia. Phil. Trans.—1834, Generation of Marsupialia; 1837, Brain of Marsupialia; Medical Gazette, 1839, Blood-discs of Marsupialia; Physiological Catalogue of Museum Royal College of Surgeons, 1834, 1840; Notes to Hunter's Animal Economy, ed. 1837; Description of Australian Fossil Marsupials, in Mitchell's Expeditions into the Interior of Eastern Australia, 1839; Geological Transactions, second series, vol. vi. *Mayo, H.* Outlines of Physiology, 1833, Spinal Chord of Kangaroo. *Corvus*, Lehrbuch der Vergleich. Anat. 1834. *Waterhouse*, Zoological Transactions, 1836; Marsupialia, vol. xi. of the Naturalist's Library, 1841. *Vrolik, W.* Ontleed—en Natuurkundige Aanteekeningen over den grooten Kangaroo, in Van der Hoeven's Natuur Tydschrift. 3 deel. 1837. *Temminck*, Monographies de Mammalogie. *Wagner, R.* Lehrbuch der vergleich. Anatomie, 1835. *Valenciennes*, Comptes Rendus de l'Acad. des Sciences, Paris, 1838. *Müller, S.* Over de Zoogdieren van Indischen Archipel. 1840. *Gould*, Monograph on Kangaroos.

(R. Owen.)

MEMBRANE, (in Anatomy,) Gr. *μνηνγξ*; Lat. *Membrana*; Fr. *Membrane*; Germ. *die Haut*. This term is commonly applied to designate those textures of the body which are disposed or arranged as laminae, destined to cover organs, to line the interior of cavities, or either singly or by their application one over the other, to constitute the walls of canals or tubes. Expansion with very slight thickness is the main morphological characteristic of membranes in their ordinary sense.

I do not intend here to give any classification of the membranes: the term is extensively used in descriptive as well as in general anatomy; and anatomists differ materially as to the degrees within which they limit its meaning. Anatomists hitherto have been content to adopt the gross anatomy of the textures as the basis of their classification, a circumstance which has given rise to much error, as well as to great variety of opinion. Now, aided as we are by excellent microscopes, and by the light which they have thrown upon the minute anatomy of the tissues, we should only admit that classification which is based on an ultimate or even proximate anatomical analysis. As these points will be all fully treated of in the article *TISSUE*, reference is made to it for the details respecting the membranes.

(R. B. Todd.)

MENINGES.—This word signifies *membranes*; it is specifically applied to those membranous expansions which cover and more or less protect the brain and spinal cord, and in this sense is best interpreted by the German word *Hirnhaut*. The term is in common use on the continent, but not so frequently employed by British anatomists, although always understood by them in the sense above given. It appears to have been thus applied first by Galen, who distinguished *μνηνγξ παχυτερη*, or the dura mater, and *μνηνγξ λεπτη*, or the pia mater.

The description of the membranes of the brain and spinal cord will be found in the article *NERVOUS CENTRES*.

(R. B. Todd.)

MICROSCOPE, (*μικρος*, small, and *σκοπειω*, to look at,) an instrument for aiding the eye in the examination of minute objects. Although a description of the structure and uses of this instrument cannot be considered as strictly belonging to a work like the present, yet the knowledge of them is so closely connected with its general objects that it has been deemed advisable to make it an object of special attention. The applications of this instrument to the purposes of the anatomist and physiologist are so numerous, that a whole treatise might easily be written upon them alone. We are not aware, until we come to think on the subject, how much of our knowledge of what takes place within the living body is dependent upon its revelations. To take a familiar illustration,—the capillary circulation might be, in some degree, guessed at by tracing the ramifications of the bloodvessels as far as they could be dis-

cerned with the naked eye; but we should have known extremely little of it without the microscope. Our whole knowledge of the early processes of development in plants and animals is gained by the same assistance. Not only is much of that, which ranks as established anatomical or physiological truth, founded upon microscopic researches, but similar researches, which are being prosecuted at the present time, are yielding a harvest of discovery still richer in amount, whilst not less important in its character.

We propose, in the present article, to take a general view of the principles, optical and mechanical, which are concerned in the construction of the microscope; and then to give an outline of the results of some of the most recent enquiries in which it has been profitably employed,—confining ourselves chiefly, however, to those which concern the origin and formation of the principal organized structures. If it be thought that the former portion is too much extended, we have only to say, that we know of no single treatise to which we can refer our readers for a large part of the information which we desire to convey; and that we have therefore judged it desirable to make the article complete in itself.

I. OPTICAL PRINCIPLES GOVERNING THE CONSTRUCTION OF MICROSCOPES.

All microscopes, except those which operate by reflection (to be hereafter noticed), depend for their operation upon the influence of convex and concave lenses on the course of the rays of light passing through them. This influence is the result of the well-known laws of refraction—that a ray passing from a *rare* into a *dense* medium is refracted *towards* the perpendicular, and vice versâ. When, therefore, a pencil of parallel rays passing through air impinges upon a convex surface of glass, the rays will be made

Fig. 144.

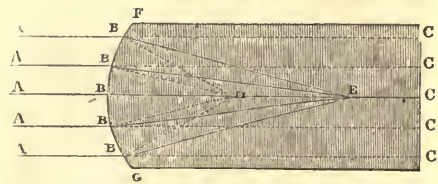

A B, parallel rays of light falling upon the convex surface F, B, G; D the centre, D B, D G, radii, which are the perpendiculars to the curved surface at the several points; B C, course of the rays if uninterrupted; B E, their course in consequence of the refraction they have undergone, converging to a focus at E.

to converge, for they will be bent towards the centre of the circle, since the radius is the perpendicular to each point of curvature. The central ray, as it coincides with the perpendicular, will undergo no refraction; the others will be bent from their original course in an increasing degree in proportion as they fall at a distance from the centre of the lens; and the effect upon the whole will be such, that they



will be caused to meet at a point, called the *focus*, some distance beyond the centre of curvature. This effect will not be materially changed, by allowing the rays to pass into air again through a *plane* surface of glass, such as would be formed by a section of the glass in the vertical line; a lens of this description is called a *plano-convex* lens; and it will hereafter be shown to possess properties, which render it very useful in the construction of microscopes. But if, instead of passing through a plane surface, the rays re-enter the air through a convex surface, they will be made to converge still more. This may be best understood by considering the course of parallel rays, as in the adjoining

Fig. 145.

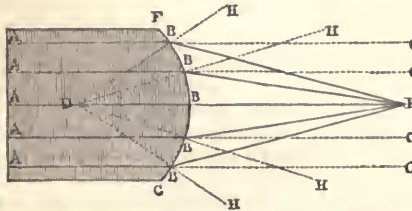

A B, parallel rays passing through glass and falling upon the convex surface F B G; B H, B H, radii prolonged, which are the perpendiculars to the curved surface at the several points; B C, course of the rays if unrefracted; B E, their course in consequence of refraction.

figure (fig. 145). Here the radii prolonged will be the perpendiculars to the curved surface; and, according to the law of refraction just alluded to, the rays passing from the dense into the rare medium will be bent *from* the perpendicular, so as to be made to converge towards a focus, as in the former instance. It is easy to see, therefore, that the effect of the second convex surface will be precisely equivalent to that of the first; for the contrary direction of the surface is antagonized by the contrary direction of the refraction; so that the focus of a double convex lens will be at just half the distance from it, or (as commonly expressed) be half the length of the focus of a plano-convex lens. In fact, the focus of the former to parallel rays will be the centre of its sphere of curvature, and its focal length will therefore be the radius; whilst the focus of the latter will be in the opposite side of the sphere, and its focal length will be the diameter. Now it is evident that

Fig. 146.

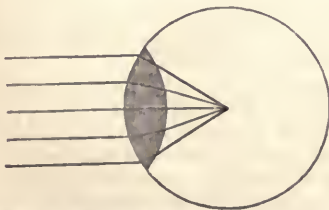

Parallel rays falling on a double convex lens brought to a focus in its centre; and rays diverging from such a point rendered parallel.

Fig. 147.

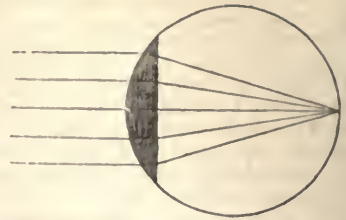

Parallel rays falling on a plano-convex lens brought to a focus at the distance of its diameter, and vice versa.

if a double convex lens will bring parallel rays to a focus in the centre of its sphere of curvature, it will on the other hand cause rays to assume a parallel direction, which are *diverging* from its focus; so that if a luminous body were placed in that point, all its cone of rays, which fell upon the surface of the lens, would pass out in a cylindrical form. Again, if rays already *converging* fall upon a convex lens, they

Fig. 148.

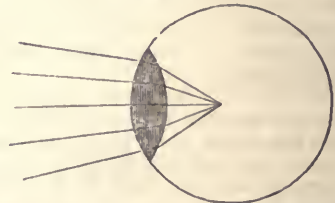

Rays already converging brought to a focus nearer than the centre; and rays diverging from such a point, still diverging in a diminished degree.

Fig. 149.

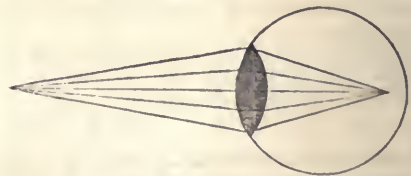

Rays diverging from points more distant than the principal focus on either side brought to a focus beyond it.

will be brought to a focus at a point nearer to it than the focus for parallel rays (which is called its principal focus); and, if they be diverging from a distant point, their focus will be more distant than the principal focus. The further be the point from which they diverge, the more nearly will the rays approach the parallel direction; until, at length, when the objects are very distant, their rays in effect become parallel, and are brought to a focus in the centre of the sphere. If they diverge from the other extremity of the diameter of the sphere, they will be brought to a focus at a corresponding distance on the other side of the lens. On the other hand, if they be diverging from a point

within the principal focus, they will neither be brought to converge nor be rendered parallel, but will diverge in a diminished degree. The same principles apply equally to a plano-convex lens, the distance of its principal focus being understood to be the diameter of the sphere. They also apply to a lens whose surfaces have different curvatures; the principal focus of such a lens is found by multiplying the radius of one surface by the radius of the other, and dividing this product by half the sum of the same radii. For the rules by which the foci of convex lenses may be found for rays of different degrees of convergence and divergence, we must refer to works on optics.

The influence of *concave* lenses will evidently

Fig. 150.

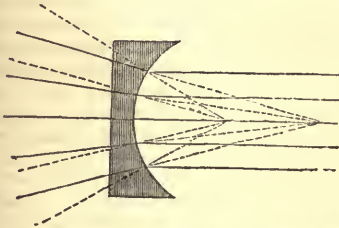

Parallel rays falling on a plano-concave lens made to diverge as from its principal focus, and rays converging to that focus rendered parallel.

be precisely the converse of that of convex. Rays which fall upon them in a parallel direction will be made to *diverge* as if from the principal focus, which is here called the *negative* focus. This will be, for a plano-concave

Fig. 151.

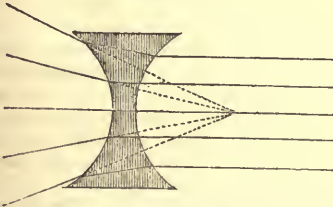

Parallel rays made to diverge as from the principal focus, and rays converging to that focus rendered parallel.

Fig. 152.

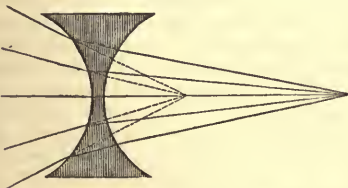

Rays greatly converging made to converge less, and rays slightly diverging made to diverge more.

lens, at the distance of the diameter of the sphere of curvature; and for a double concave, in the centre of that sphere. In the same manner, rays which are converging to such a degree that,

Fig. 153.

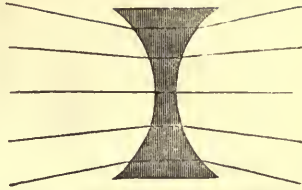

Rays slightly converging made to diverge.

if uninterrupted, they would have met in the principal focus, will be rendered parallel; if converging more, they will still meet, but at a greater distance; and if converging less, they will diverge as from a negative focus at a greater distance than that for parallel rays. If already diverging, they will diverge still more, as from a negative focus nearer than the principal focus; but this will approach the principal focus, in proportion as the distance of the point of divergence is such, that the direction of the rays approaches the parallel.

If a lens be convex on one side and concave on the other, forming what is called a *meniscus*, its effect will depend upon the proportion between the two curvatures. If they are equal, as in a watch-glass, no perceptible effect will be produced; if the convex curvature be the greater, the effect will be that of a less powerful *convex* lens; and if the concave curvature be the more considerable, it will be that of a less powerful *concave* lens. The focus of convergence for parallel rays in the first case, and of divergence in the second, may be found by dividing the product of the two radii by half their difference.

Hitherto we have considered only the effects of lenses upon a pencil of rays issuing from a single luminous point, and that point situated in the line of its axis. If the point be situated above the line of its axis, the focus will be below it, and vice versa. The surface of every luminous body may be regarded as comprehending an infinite number of such points, from every one of which a pencil of rays proceeds, and is refracted according to the laws already specified; so that a perfect but inverted image or picture of the object is formed upon any surface placed in the focus, and adapted to receive the rays.

Fig. 154.

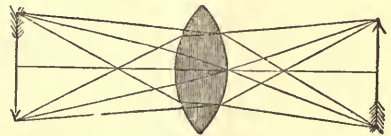

In optical diagrams it is usual, in order to avoid confusion, to mark out the course of the rays proceeding from two or three only of such points. By an inspection of the subjoined figures, it will be evident that, if the object be placed at twice the distance of the principal focus, the image being formed at an equal dis-

Fig. 155.

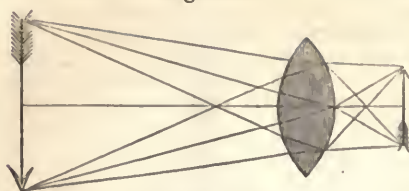

Formation of images by convex lenses.

tance on the other side of the lens, will be of the same dimensions with the object: whilst, on the other hand, if the object be nearer the lens, the image will be farther from it, and of larger dimensions; and if the object be farther from the lens, the image will be nearer to it, and smaller than itself. Further, it is to be remarked, that the larger the image in proportion to the object, the less bright it will be, because the same amount of light has to be spread over a greater surface; whilst a smaller image will be much more brilliant, in the same proportion.

The knowledge of these general facts will enable us readily to understand the ordinary operation of the microscope; but the instrument is subject to imperfections of various kinds, the mode of remedying which cannot be comprehended without an acquaintance with their nature. One of these imperfections results from the *spherical aberration* of the rays which have passed through lenses, whose curvatures are equal over their whole surfaces. If the course of the rays be carefully laid down, it will be found that they do not all meet exactly

Fig. 156.

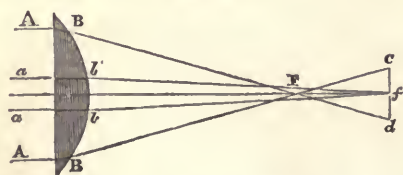

A B, rays falling on the periphery of the lens; P, focus of these; a, b, rays falling nearer the centre; f, more distant focus of these.

in the foci already stated, but that the focus of the rays which have passed through the peripheral portion of the lens is much closer to it than that of the rays which are nearer the line of its axis; so that, if a screen be held in the former, the rays which have passed through the central portion of the lens will be stopped by it before they have come to a focus; and if the screen be carried back into the focus of these, the rays which were most distant from the axis will have previously met and crossed, so that they will come to it in a state of divergence. In either case, therefore, the image will have a certain degree of indistinctness; and there is no one point to which all the rays can be brought by a lens of spherical curvature. The difference between the focal points of the central and of the peripheral rays is termed the *spherical aberration*. It is obvious that, to

produce the desired effect, the curvature is required to be increased around the centre of the lens, so as to bring the rays which pass through it more speedily to a focus, and to be diminished towards the circumference, so as to throw the focus of the rays influenced by it to a greater distance. The requisite conditions may be exactly fulfilled by a lens one of whose surfaces, instead of being spherical, is a portion of an ellipsoid or hyperboloid of certain proportions; but the difficulties in the way of the mechanical execution of lenses of this description are such, that, for all practical purposes, they have been entirely abandoned in favour of lenses with spherical surfaces. Various means have been devised for diminishing the aberration of these. In microscopes of ordinary construction, the method employed is to diminish the aperture or working surface of the lens, so as to employ only the rays that pass through the central part, which, if sufficiently small in proportion to the whole sphere, will bring them all to nearly the same focus. The use of this may be particularly noticed in the object-glasses of common microscopes; where, although the lens itself be large, the greater portion of its surface is rendered inoperative by a *stop*, which is a plate with a circular aperture interposed between the lens and the rest of the instrument. If this aperture be gradually enlarged, it will be seen that, although the image becomes more and more illuminated, it is at the same time becoming more and more indistinct; and that, in order to gain *defining power*, the aperture must be reduced again. Now this reduction is attended with two great inconveniences; in the first place, the loss of intensity of light, the degree of which will depend upon the quantity transmitted by the lens, and will vary therefore with its aperture; and, secondly, the diminution of the number or quantity of rays, which will prevent the surfaces of objects from being properly seen. Thus, for example, we shall suppose the observer to be looking at the scales of a butterfly's wing with a microscope furnished with two object-glasses of the same focal length,—one corrected, the other not so. If, with the same illumination of the object, he apply to it the uncorrected objective, the aperture of which is necessarily small, after having looked at it with the corrected lens, he will, in the first place, perceive that the whole field is much darker; but if, by increasing his illumination, he give the image an equal brightness, and see its outline with equal distinctness, he will be completely unable to see with the uncorrected lens a series of delicate lines upon the surface of the scale, which the other makes evident. The power of exhibiting these and similar objects is termed *penetration*; it depends upon the size of the conical pencils of light admitted by the lens, and therefore upon its aperture.

The spherical aberration may be considerably diminished by making the most advantageous use of *single lenses*. Thus the aberration of a plano-convex lens, whose convex side is turned towards parallel rays, is only $\frac{1}{100}$ ths of its thickness, whilst, if the plane side be turned

towards the object, the aberration is $4\frac{1}{2}$ times the thickness of the lens. Hence, when a plano-convex lens is employed, its convex surface should be turned towards a distant object, when it is used to form an image by bringing to a focus parallel or slightly-diverging rays; but it should be turned towards the eye, when it is used to render parallel the rays which are diverging from a very near object. The single lens having the least spherical aberration is a double convex, whose radii are as 1 to 6. When the flattest face is turned toward parallel rays, the aberration is nearly $3\frac{1}{2}$ times its thickness; but when the most convex side receives or transmits them, the aberration is only $\frac{7}{100}$ ths of its thickness. The spherical aberration may be still further diminished, however, or even got rid of altogether, by making use of combinations of lenses so disposed that their opposite aberrations shall correct each other, whilst magnifying power is still gained. For it is easily seen that, as the aberration of a concave lens is just the opposite of that of a convex lens, the aberration of a convex lens placed in its most favourable position may be corrected by a concave lens of much less power in its most unfavourable position; so that, although the power of the convex lens is weakened, all the rays which pass through this combination will be brought to one focus. This is the principle of the *aplanatic doublet* proposed by Sir J. F. W. Herschel, consisting of a double-convex lens of the most favourable form, and a meniscus with the concave of longer focus than the convex.* A doublet of this kind may be made of great use in the microscope, as we shall hereafter show.

Fig. 157.



Herschel's doublet.

But the spherical aberration is not the only imperfection with which the optician has to contend in the construction of microscopes. A difficulty equally serious arises from the unequal refrangibility of the different coloured rays, which together make up white or colourless light,† so that they are not all brought to the same focus, even by a lens free from spherical aberration. It is this difference in their refrangibility which causes their complete separation by the prism into a spectrum; and it manifests itself, though in a less degree, in the image formed by a convex lens. For if parallel rays of white light fall upon a convex surface, the most refrangible of its component rays, namely, the *violet*, will be brought to a focus at a point somewhat nearer to the lens than the principal focus, which is the mean of the whole; and the converse will be true of the *red* rays, which are the least refrangible, and whose focus will therefore be more distant.

* The exact curvatures to be given to these surfaces will be found in the original memoir, Phil. Trans. 1821.

† It has been deemed better to adhere to the ordinary phraseology, when speaking of this fact, as more generally intelligible than the language in which it might be more scientifically described, and at the same time leading to no practical error.

Fig. 158.

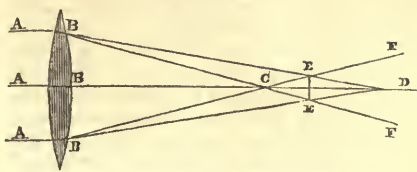

Diagram illustrative of chromatic aberration.

A B, rays of white light refracted by a convex lens; C, the focus of the violet rays, which then cross and diverge towards E F; D, the focus of the red rays which are crossed at the points E E, by the violet; the middle point of this line is the mean focus, or focus of least aberration.

This is easily proved experimentally. If a lens be so fixed as to receive the solar rays, and to illuminate a white screen at any distance between the lens and the mean focus, the luminous circle will have a red border, because the red rays will there form the exterior of the cone; but if it be removed beyond the mean focus, the circle will have a violet border, because the violet rays will then be outermost. As the spherical aberration would be mixed up with the chromatic in such an experiment, the undisguised effect of the latter will be better seen by taking a large convex lens, and covering up its central part, so as to allow the light to pass only through a peripheral ring; and since the greater the alteration in the course of the rays, the greater will be the separation of the colours, (or *dispersion*, as it is technically called,) this ring will exhibit the phenomenon much better than would be done by the central portion of the lens. Hence, in practice, the chromatic aberration is partly obviated by the same means used to diminish the spherical aberration,—the contraction of the aperture of the lens, so that a very small portion of the whole sphere is really employed. But this contraction is attended with so much injury to the performance of the microscope in other respects, that it becomes extremely desirable to avoid it. In no single lens can any correction for chromatic aberration be effected; and it requires a very nice adjustment of two, three, or even more, to accomplish this with perfection.

The correction is accomplished by bringing into use the different dispersive powers of various materials, which bear no relation to their simple refracting power. As the effects of concave lenses are in all respects the converse of convex, it is obvious that, if a concave lens of the same curvature be placed in apposition with the convex, in such an experiment as that just alluded to, the dispersion of the rays will be entirely prevented, but neither will any change in the course of the rays take place. If, however, we can obtain a substance of higher dispersive power in proportion to its power of refraction, it is obvious that a concave lens of less curvature formed of it will correct the *dispersion* occasioned by the convex lens, without altogether antagonising the *refraction* of the latter. This is accomplished

without any essential difficulty in practice; for the dispersive power of flint-glass is so much greater than that of crown-glass, that a convex lens of the former, the focal length of which is $7\frac{3}{4}$ inches, will produce the same degree of colour with a convex lens of crown-glass whose focal length is $4\frac{1}{2}$ inches. Hence a concave lens of the former material and curvature will fully correct the dispersion of a convex lens of the latter, and will yet diminish its refractive power only to such an extent as to make its focus ten inches. The correction for chromatic aberration in such a lens would be perfect, if it were not that, although the extreme rays, violet and red, are thus brought to the same focus, the dispersion of the rest is not equally compensated; so that what is termed a *secondary spectrum* is produced, the images of objects seen through such a lens being bordered on one side with a purple fringe, and on the other with a green fringe. Moreover such a lens is not corrected for spherical aberration; and it must of course be rendered free from this, to be of any service, however complete may be its freedom from colour.

Opticians have long since been able to effect the required corrections, with sufficient accuracy for most practical purposes, in the construction of large object glasses for telescopes; the size of which has been only limited by the impossibility of obtaining glasses of large dimensions perfectly free from faults. But it has been only of late years, that the construction of achromatic and aplanatic object-glasses for microscopes has been considered practicable,—their extremely minute size appearing to forbid the employment of the necessary combinations, since a very high amount of accuracy is required in the several curvatures, in order to obtain any real improvement. About the year 1820, however, the attempt was first made in France by M. Selligues, who was followed by Fraunhofer at Munich, by Amici at Modena, and by Mr. Tulley of London; and with these attempts a new era in the history of the microscope may be said with truth to have commenced. The work has been prosecuted, both theoretically and practically, with the greatest zeal, and the result has been most successful. By combining two or three groups of double lenses, each corrected in a particular manner, so that the whole is quite free from aberration, a perfectly sharp and clearly-defined image may now be obtained through a lens of many times the aperture of those formerly in use; and the differences in the representation of the objects under enquiry, between such lenses and a good achromatic, are such as could not have been, *à priori*, suspected. One of the most pleasing results of this improvement has been the greatly-increased unanimity amongst microscopical observers, as to the appearances actually witnessed by them; for with the old and imperfect instruments, great uncertainty could not but exist in regard to many objects, of whose nature every one formed his own opinion, frequently according to preconceived ideas; but at present the objects are presented to the sight of each ob-

server possessed of a good instrument, with so much more clear and uniform an appearance, that there is much less scope for the play of his imagination as to their real character,—however much he may exercise it upon their history. It would be foreign to the purpose of this article to enter into scientific details upon the minutiae of the construction of achromatic combinations; but it may not be amiss to state that, in the opinion of the author, English artists have far surpassed foreigners in the construction of lenses of very short focus, whilst some foreign combinations which he has seen, of low magnifying power, possess an advantage over those of British make,—the constructors of the latter having sometimes sacrificed what he deems adequate correctness in aiming at a very large aperture.*

With these preliminary details as to the nature of the means by which microscopic power is obtained, we shall proceed to notice their chief applications to practice. Excluding for the present the solar and gas microscopes, in which an image visible to any number of persons at once is formed upon a screen, and is viewed by them precisely as other surrounding objects would be, we shall consider the instruments (to which the term microscope is more commonly applied), whose effects are produced by their influence on the rays of light which enter the eye of the observer, and which can be used, therefore, by but one at the same time. These are distinguished as *single* or *simple*, and *compound* microscopes. Each of these kinds has its peculiar advantages for the anatomist; and we shall, therefore, describe the construction and uses of both in some detail. Their essential difference consists in this,—that in the former the rays of light which enter the eye of the observer proceed directly from the object itself, after having been subject only to a change in their course, whilst in the latter an inverted image of the object is formed by a lens, which image is viewed by the observer through a simple microscope, as if it were the object itself. The *simple* microscope may consist of *one* lens, but (as will be presently shown) it may be formed of *two* or *even* three; but these are so disposed as to produce an action upon the rays of light correspondent to that of a single lens. For this kind of microscope, therefore, we prefer the term *simple* to *single*. In the compound microscope, on the other hand, not less than two lenses must be employed, one to form the inverted image of the object, and this being nearest to it is called the *object-glass*, whilst the other magnifies that image, being interposed between it and the eye of the observer, and is hence called the *eye-glass*: Both these may be constructed of several lenses, as will be hereafter shown; but they are so arranged as to have the functions of a single lens, and are only combined

* Those who wish to study the principles which now guide opticians in their construction, should refer to Mr. J. J. Lister's paper in the Phil. Trans. for 1829, and Mr. Ross's Memoir in the Trans. of the Society of Arts, vol. ii.

for the purpose of correcting the defects incidental to it.

In order to gain a clear notion of the mode in which a single lens serves to magnify minute objects, it is necessary to revert to the phenomena of ordinary vision. An eye free from any defect has a considerable power of adjusting itself in such a manner as to gain a distinct view of objects placed at extremely varying distances; but the image formed upon the retina will of course vary in size with the distance of the object; and the amount of detail perceptible in it will follow the same proportion. To ordinary eyes, however, there is a limit within which no distinct image can be formed, on account of the too great divergence of the rays of the different pencils which then enter the eye; since the eye is usually adapted to receive and bring to a focus rays which are parallel or slightly divergent. This limit is variously stated at from five to ten inches; we are inclined to think from our own observations, that the latter estimate is nearest the truth; that is, although a person with ordinary vision may see an object much nearer to his eye, he will see little if any more of its details, since what is gained in size will be lost in distinctness. Now the utility of a convex lens interposed between a near object and the eye consists in its reducing the divergence of the rays forming the several pencils which issue from it; so that they enter the eye in a state of moderate divergence, as if they had issued from an object beyond the nearest limit of distinct vision; and a well-defined picture is consequently formed upon the retina. But not only is the course of the several rays in

assistance of a convex lens which shall enable him to see at the same distance with equal distinctness. It is evident, therefore, that the magnifying power of a single lens, depending as it does upon the proportion between the distance at which it renders the object visible, and the nearest distance of unaided distinct vision, must be different to different eyes. It is ordinarily estimated, however, by finding how many times the focal length of the lens is contained in ten inches; since, in order to render the rays from the object nearly parallel, it must be placed very nearly in the focus of the lens; and the picture is referred by the mind to an object at ten inches distance. Thus, if the focal length of a lens be one inch, its magnifying power for each dimension will be ten times, and consequently a hundred superficial; if its focal distance be only one-tenth of an inch, its magnifying power will be a hundred linear or ten thousand superficial. The use of the convex lens has the further advantage of bringing to the eye a much greater amount of light than would have entered the pupil from the enlarged object at the ordinary distance, provided its own diameter be greater than that of the pupil. It is obviously necessary, especially when lenses of very high magnifying power are being employed, that their aperture should be as large as possible; since the light issuing from a minute object has then to be diffused over a large picture, and will be proportionally diminished in intensity. But the shorter the focus the less must be the diameter of the sphere of which the lens forms a part; and unless the aperture be proportionally diminished, the spherical and chromatic aberrations will interfere so much with the distinctness of the picture, that the advantages which might be anticipated from the use of such lenses will be almost negatived. Nevertheless, the simple microscope has always been an instrument of extreme value in anatomical research, owing to its freedom from those errors to which, as will hereafter appear, the compound microscope is subject; and the greater certainty of its indications is evident at once from the fact, that the eye of the observer receives the rays sent forth by the object itself, instead of those which proceed from an image of that object. A detail of the means employed by different individuals, for procuring lenses of extremely short focus, though possessing much interest in itself, would be misplaced here; since recent improvements, as will presently be shown, have superseded the necessity of all these. It may, however, be stated that Leuwenhoeck, De la Torre, and others among the older microscopists, made great use of small globules procured by fusion of threads or particles of glass. The most important suggestion for the improvement of the simple microscope composed of a single lens proceeded some years ago from Dr. Brewster, who proposed to substitute diamond, sapphire, garnet, and other precious stones of high refractive power, for glass, as the material of single lenses. A lens of much longer radius of curvature might thus be employed to gain

Fig. 159.

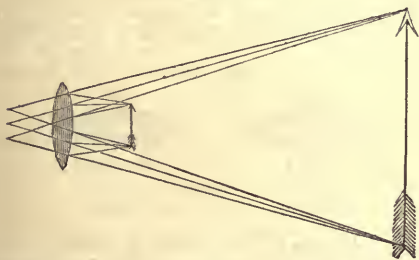

Diagram illustrating the use of the Simple Microscope.

each pencil altered as regards the rest by this refracting process, but the course of the pencils themselves is changed, so that they enter the eye under an angle correspondent with that at which they would have arrived from a much larger object situated at a greater distance. The picture formed upon the retina, therefore, corresponds in all respects with one which would have been made by the same object, greatly increased in its dimensions, and viewed at the smallest ordinary distance of distinct vision. A short-sighted person, however, who can see objects distinctly at a distance of three or four inches, has the same power in his eye alone, by reason of its greater convexity, as that which the person of ordinary vision gains by the

an equal magnifying power, and the aperture would admit of great extension without a proportional increase in the spherical and chromatic aberrations. This suggestion has been carried into practice with complete success as regards the performance of lenses executed on this plan; but the difficulties of various kinds in the way of their execution are such as to render them very expensive; and as they are not superior to the combination now to be described, they have latterly been quite superseded by it.

This combination was first proposed by Dr. Wollaston, and is known as his doublet. It consists of two plano-convex lenses, whose focal lengths are in the proportion of one to three, or nearly so, having their convex sides directed towards the eye, and the lens of shortest focal length nearest the object. In Dr. Wollaston's original combination no stop was interposed, and the distance between the lenses was left to be determined by experiment in each case. A great improvement was subsequently made, however, by the introduction of a stop between the lenses, and by the division of the power of the smaller lens between two; this is due to Mr. Holland.* By these means a combination may be produced, in which the errors are made to correct each other so nearly that all the advantages of a wide aperture with a very short focus may be gained. The general nature of the performance of a doublet or triplet may be understood from the adjoining figure, (*fig. 160*), in which $L O L'$ is

Fig. 160.

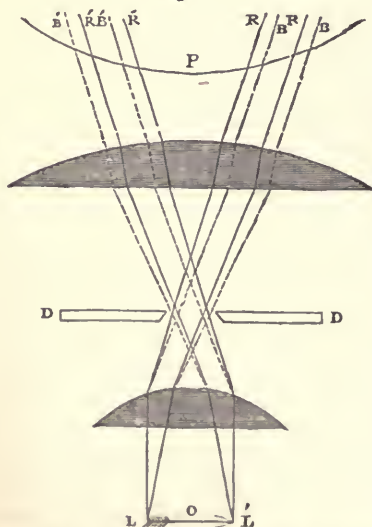

Diagram of the passage of rays through a doublet.

the object, P a portion of the pupil, and $D D$ the stop. The pencils of light from the two extremities, $L L'$, of the object cross each other in the stop, and consequently pass through the two lenses on the opposite sides

of the axis $O P$; so that each becomes affected by opposite errors, which to a certain extent balance and correct one another. To take the pencil L , for instance, which enters the eye at $R B$, $R B$; it is bent to the right at the first lens, and to the left at the second; and as each refraction alters the direction of the blue rays more than of the red, and moreover, as the blue rays fall nearer the margin of the second lens, where the increased power of the refraction, consequent upon the distance from the centre, compensates in some degree for the greater focal length of the second lens, the blue and red rays will emerge very nearly parallel, and are therefore colourless to the eye. At the same time the spherical aberration has been diminished by the circumstance that the side of the pencil, which passes one lens nearest the axis, passes the other nearest the margin. This explanation applies only, however, to the pencils near the extremities of the object. The central pencil, it is obvious, will pass through the same relative portions of the two lenses, and only an imperfect correction will therefore take place, and of those issuing from the intermediate points the amount of correction will vary with their proximity to the centre or to the circumference. Hence a doublet is not a *perfect* magnifier; but it is very much superior to a single lens, and may be so constructed as to show many of the usual test-objects,—especially those in which a moderate amount of *penetration* is sufficient, provided the *definition* be good,—in a very beautiful manner. Its *angle of aperture*, however, by which is meant the angle of the apex of the conical pencils of rays admitted by it, cannot be advantageously increased much beyond 40° or 45° . But when the smaller lens is replaced by a combination of two others, so as to form a triplet, their joint aberration is so much less

Fig. 161.



Diagram to illustrate angle of aperture.

A , lens with small opening, admitting only pencils of rays diverging at an angle of 15° ; B , lens with large opening, admitting pencils of 50° .

that it is more counterbalanced by the third lens placed above the stop. In this manner the transmission of a still larger angular pencil,—even to 65° ,—is rendered compatible with distinctness; and great penetrating power is thus combined with perfect definition, as well as with brilliancy of illumination. For the purposes of anatomical investigation, as we shall hereafter state, we consider good doublets and triplets, where circumstances admit of their employment, superior to any other kind of magnifying instrument. The principal disadvantages which the use of them involves are the close proximity to the object required by their very short focus when a high

* Trans. of Soc. of Arts, vol. xlix.

magnifying power is employed; and the straining of the eye, which is occasioned by their very minute aperture. Thus a triplet in our possession, which will show the most difficult test-objects, has a focal distance of only about $\frac{1}{35}$ th of an inch, and an aperture through which the smallest pin would scarcely pass. But the first of these disadvantages is more apparent than real. The object should be always covered with talc, (which may be easily split into laminæ of the $\frac{1}{300}$ th of an inch in thickness,) for the purpose of protecting both it and the lens from injury by accidental contact; and the magnifier should not be screwed into the arm which carries it, but loosely fitted, so that, if the observer should happen to bring the arm too near the stage, he may not force down his lens upon the object. As Mr. Holland justly observes, "Should the proximity of the object to the lowest lens of the triplet be urged as a material objection to its usefulness, it may be answered that the whole microscope is a mass of delicacies; consequently, it cannot be allowed that a line be arbitrarily drawn, beyond which every thing is to be considered as too delicate." The second of the above objections must be obviated by never continuing the use of deep powers in a simple microscope for any length of time at one sitting, and by taking care to adjust the instrument in such a manner that the head may be as little inclined forwards as possible.

The only other form of simple microscope which we shall notice is one commonly known under the name of the Coddington lens. The first idea of it was given by Dr. Wollaston, who proposed to cement together two plano-convex, or hemispherical lenses, by their plane sides, with a stop interposed, the central aperture of which should be equal to $\frac{1}{3}$ th of the focal length. The great advantage of such a lens is that the oblique pencils pass, like the central ones, at right angles with the surface; and that they are consequently but little subject to aberration. The idea was further improved upon by Mr. Coddington, who pointed out that the same end would be much better answered by taking a sphere of glass, and grinding away the equatorial parts, the groove being then filled with opaque matter, so as to limit the central aperture. Such a lens gives a large sphere of view, admits a considerable amount of light, and is equally good in all directions; but its powers of definition are by no means equal to those of an achromatic lens, or even of a doublet. This form is very useful, therefore, as a hand lens, in which a high power is not required, but has no particular advantages for magnifiers of short focus, nor for the object-glasses of a compound microscope.*

It may be desirable to mention that a magnifier, now known under the name of the Stanhope lens, and much praised by those interested

* We think it right to state that many of the magnifiers sold as Coddington lenses are not really (as we have satisfied ourselves) portions of spheres, but are manufactured out of ordinary double-convex lenses, and will be destitute, therefore, of many of the above advantages.

in its sale, is nothing more than a double convex glass, much thicker than ordinary, so that an object in contact with one of its surfaces shall be in focus to the eye placed behind the other. This is an easy method of applying rather a high magnifying power to scales of butterflies' wings and other similar flat and minute objects; but the instrument is totally destitute of value as a means of scientific research, and must be regarded as an ingenious philosophical toy.

Compound Microscope. — The compound microscope essentially consists, as already stated, of two lenses, which are so disposed that one of them receives the rays of light from the object, and forms an image by its refraction of them; and this image is seen by the eye through the second lens, which acts upon it as a simple microscope. The principle of such a microscope will be at once understood from the adjoining diagram (*fig. 162*). According to the laws already stated, if the object be at a less distance from the lens than its diameter of curvature (supposing it to be a double-convex lens, or twice that distance of a plano-convex) the image will be larger than the object; and this in proportion as the latter is brought nearer to the principal focus, at which it can give rise to no image, as its rays after refraction become parallel. Hence, by the use of the same object-glass, a considerable variety of power might be obtained; for, if the image be formed near the lens, it will be small; but if the object be caused to approach it, the image will be thrown to a considerable distance, and will be proportionably magnified. The eyepiece would of course require, however, a corresponding re-adjustment; and, in fact, the construction of the whole instrument would need modifica-

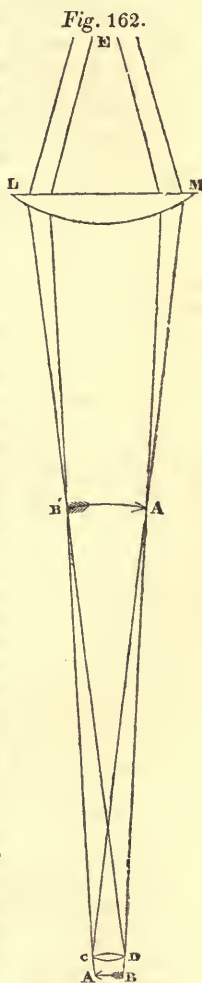

A B, the object, of which an amplified image is formed by the object-glass C D, in the contrary direction, at A' B', by the convergence of the rays of the several pencils to a focus. These again diverging are received by the eye-glass L M, which gives them the nearly parallel direction necessary for them to enter the eye, and causes the apparent size of the image to be E.

tion. Further, the optical disadvantages of such a plan would be considerable, for the nearer to the principal focus of the lens the object is brought, the more obliquely will the rays fall upon its surface, and the greater, therefore, will be the errors of aberration. This method of augmenting the power of a microscope has been adopted in spite of these disadvantages,* but it is not found to answer. Nevertheless, it is capable of being made of great utility, as we shall presently show, to a limited extent. A much more generally convenient method of varying the power of the microscope is to employ, as object-glasses, lenses of different foci; and thus, as the same distance between the image and the lens is constantly maintained, whilst that of the object varies, the number of times that the latter is amplified is changed in a like proportion. In whatever mode additional amplification be obtained, two things must always result from the change; the portion of the surface of the object, of which an image can be formed, must be diminished, and the quantity of light spread over that image must be proportionably lessened. In the use of high magnifying powers, the compound microscope has the great advantage over the simple, that the object need not be brought to nearly the same proximity with the lens, and that much more of it can be seen with comfort at a time. The long focus and large aperture with which the eye-piece is usually made prevent even the prolonged use of the instrument from acting prejudicially on the visual powers, except in cases of peculiar tendency to nervous disorders of the eye. And as the power of the eye-piece as well as that of the object-glass can be raised, there are scarcely any limits to the magnifying power that *may be* obtained. Practically, however, there are limits, arising from the fact that, as the amplification is greater, the aberrations will be increased in even an augmented proportion; so that these completely antagonise the benefit otherwise derivable from the employment of high powers. The aberrations can only be diminished by contracting the aperture of the object-glass; and this renders the image so dark that no real advantage is gained. Moreover, the imperfections necessary to the best compound microscope, in which ordinary lenses are employed, are further augmented by the slightest error in the centering of the lenses, so that their axes do not coincide.

In addition to the two lenses of which the compound microscope has been stated essentially to consist, another is usually introduced between the object-glass and the image formed by it. The ordinary purpose of this lens is to change the course of the rays in such a manner that the image may be formed of dimensions not too great for the whole of it to come within the range of the eye-piece, and consequently to allow more of the object to be seen at once.

* We have seen a microscope, constructed by Chevalier, in which the tube was capable of being drawn out to the length of between three and four feet!

Fig. 163.

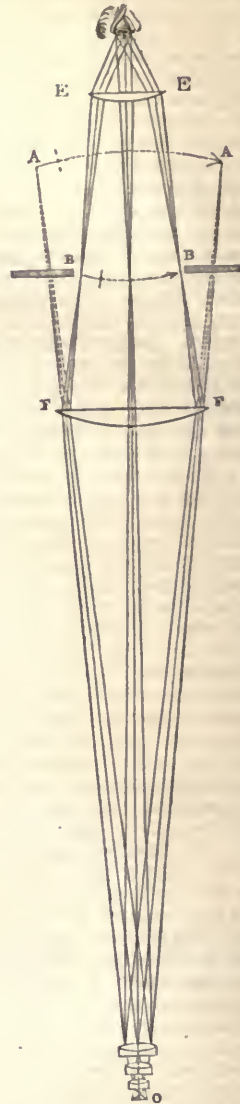

Section of Compound Microscope, with field-glass introduced.

A A, the image which would be formed by the object-glass alone; B B, the image formed by the interposition of the field-glass E E; the whole of this image is within the range of vision of the eye-glass E E, and the field of view is therefore increased.

Hence it is called the *field-glass* (fig. 163). It may be so adjusted, however, in regard to the eye-glass, as to correct its errors in almost a perfect degree; and it is now, therefore, usually considered as belonging to the ocular end of the instrument,—the *eye-glass* and the *field-lens* being together termed the *eye-piece*. Various forms of this eye-piece have

been proposed by different opticians, and one or other will be preferred, according to the purpose for which it be required. It may be laid down as a general principle, however, that to give the highest effect to the microscope, in regard to clearness of view and penetrating power, no more than *two* lenses should be employed; and that when a certain amount of these may be sacrificed to gain a large flat field, *three* is the largest number which can be introduced with any benefit. This principle is founded on the fact that, whenever light impinges on the surface of even the most transparent body, a part of it only is transmitted, the remainder being reflected. In the passage of light through ordinary lenses, therefore, a certain quantity is lost by reflection at each surface; and every multiplication in the number of lenses entails, therefore, a positive evil, which may or may not be counterbalanced by the good it effects. In the doublet or triplet already described, the correction of the aberrations is an advantage much greater than the injury resulting from the substitution of four or six surfaces for two; but this is by no means the case in the eye-piece, in which (from their low power) the aberrations are much less. Hence, when too many lenses are employed in it, although the field of view (that is, the circle within which the image is comprehended) may be very much enlarged and rendered flatter, the brilliancy and sharpness of the image are so much impaired, and it is invested with so much false colour, that, for all scientific purposes, the instrument is rather deteriorated than improved.

The eye-piece which may be most advantageously employed with achromatic object-glasses, to the performance of which it is desired to give the greatest possible effect in regard to defining and penetrating power, without the necessity of a large field, is that termed the Huyghenian, having been employed by Huyghens for his telescopes, although without the knowledge of all the advantages which its best construction rendered it capable of affording. It consists of two plano-convex lenses with their plane sides towards the eye. These are placed at a distance equal to half the sum of their focal lengths; or, to speak with more precision, at half the sum of the focal length of the eye-glass, and of the distance from the field-glass at which an image of the object-glass would be formed by it. A stop or diaphragm must be placed half-way between the two lenses. By Huyghens this arrangement was intended merely to diminish the spherical aberration; but it was subsequently shown by Boscovich that the chromatic dispersion was also in great part corrected by it. Since the introduction of achromatic object-glasses for compound microscopes, it has been further shown that all error may be avoided by a slight over-correction of these, so that the blue and red rays may be caused to enter the eye in a parallel direction, and thus to produce a colourless image, though not actually coincident (*fig.*

Fig. 164.

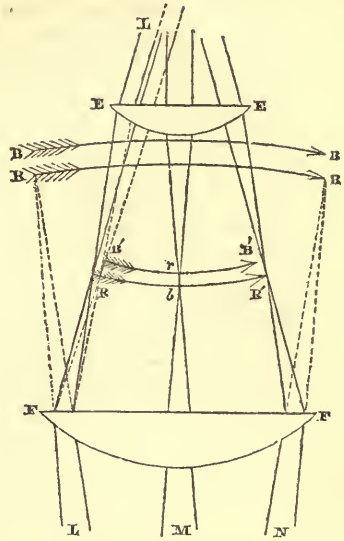

Section of Huyghenian eye-piece, adapted to over-corrected achromatics.

L M N, the two extreme rays of three pencils, which, without the field-glass, would form a blue image convex to the eye-glass at *B B*, and a red one at *R R*. By the field-glass, however, a blue image, concave to the eye-glass, is formed at *B' B'*, and a red one at *R' R'*. As the focus of the eye-glass is shorter for blue rays than for red rays, their rays, after refraction by it, enter the eye in a parallel direction, and produce a picture free from false colour. If the object-glass had been rendered perfectly achromatic, the blue rays, after passing the field-glass, would have been brought to a focus at *b*, and the red at *r*, so that an error would be produced, which would have been increased instead of antagonised by the eye-glass.

164). Further, the image produced by the meeting of the rays after passing through the field-glass is by it rendered convex towards the eye-glass, instead of concave, so that every part of it may be in focus at the same time, and the field of view thereby rendered flat. Those who desire to gain more information upon this subject than they can from the accompanying diagram and the explanation of it, may be referred to Mr. Varley's investigation of the properties of the Huyghenian eye-piece in the 51st volume of the Transactions of the Society of Arts, and to the article "Microscope" in the Penny Cyclopædia.

By an achromatic object-glass for a compound microscope, therefore, is not meant one which simply contains within itself a perfect correction for its own errors, but one in which the usual order of dispersion is so far reversed that the light, after undergoing the series of changes effected by the eye-piece, shall come uncoloured to the eye. "We can give no specific rules," says the writer of the article just

referred to, whom we believe to have had great practical experience in the matter, "for producing these results. Close study of the formulæ for achromatism given by celebrated mathematicians will do much; but the principles must be brought to the test of repeated experiment. Nor will the experiments be worth any thing, unless the curves be most accurately measured and worked, and the lenses centred and adjusted with a degree of precision which, to those who are familiar only with telescopes, will be quite unprecedented." We are not favourable to the use of a very high magnifying power in the eye-piece; and we believe that it will be discontinued in proportion to the perfection attained in object-glasses. We have seen microscopes of foreign construction in which only object-glasses of comparatively long focus were employed, and the required power was made up by the great convexity in the eye-glass; but the performance of these was not to be compared to that of instruments of British manufacture. Our own experience leads us to think that there are very few objects of which more can be made out with a deep than with a shallow eye-piece,—the diminution in distinctness and loss of sight being nearly sufficient to counterbalance the gain derived from increased power. Hence the *magnifying power* of an instrument is by no means to be regarded as an indication of its excellence; for that is to be considered as the best which, *ceteris paribus*, will show the most with the lowest power. It may be scarcely an exaggeration to affirm that there are few objects of which the details may not be as well made out by an achromatic microscope magnifying but 100 diameters, as by the best ordinary microscope magnifying 1000; and there are many objects shown with the greatest readiness by the former, which are totally inscrutable by the latter.

Next in order of optical perfection to the achromatic microscope with the Huyghenian eye-piece, we are disposed to rank the doublet microscope, invented by Mr. Holland. This gentleman has proposed to adapt to his doublets and triplets a compound body, containing an eye-piece somewhat resembling the Huyghenian, but differing from it in having the lenses fixed at a distance equal to the whole sum of their foci. "By this increase of distance, light and defining power are gained, although the magnifying power and the field of view are diminished; but at the same time the latter is rendered very perfect." Having ourselves had a microscope constructed upon this principle, we can speak in very high terms of its performance. The field of view will appear *very* small to those accustomed to the use of eye-pieces of high power; but every part of it is brilliantly illuminated, and difficult test-objects are exhibited by it with a sharpness and definition which we have seldom seen equalled. For objects which require to have a large surface in view at once, such a microscope is inappropriate; but for the purpose of minute examination of those in which

the parts may be studied independently, we regard it as the best substitute for the achromatic microscope; and we can strongly recommend it to those who are debarred by the price of the latter instrument from possessing themselves of it. In employing doublets or triplets of high power as objectives in such a microscope, care must of course be taken (as when they are used singly) to avoid injuring them by contact with the object. For the most difficult test-objects, a triplet of $\frac{1}{4}$ th of an inch focus should be employed; and the powers should successively diminish down to a doublet of $\frac{1}{4}$ th of an inch, which may be advantageously employed for opaque objects. It is necessary to state that the performance of this microscope will very much depend upon the attention paid to the *illumination* of the object; on this we shall hereafter treat in detail.

We shall next speak of eye-pieces which are intended to increase the size of the field in the most advantageous manner, without regard to the perfection of minute details. This object is ordinarily attempted by the substitution of two plano-convex lenses, or double-convex lenses of low curvature, for the single lens of the eye-glass. It has been proposed to make the same change in the field-glass; but, in our opinion, the loss by reflexion from two additional surfaces is by no means compensated by the diminution of aberration. We are ourselves, however, in the habit of employing an eye-piece, which we regard as greatly superior to that in ordinary use. It consists of a meniscus having the concave side next the eye, and a convex lens having the form of least aberration, with its flattest side next the object, nearly resembling, therefore, Herschel's aplanatic doublet. The field-glass is a double-convex lens of the form of least aberration. With this eye-piece we are enabled to obtain a field of 14 inches diameter (measured at the usual distance—10 inches) equally distinct and well illuminated over every part, and admirably adapted for the display of sections of wood, wings of insects, and objects of a similar description, and also for opaque objects. When employing it for these purposes, we much prefer the use of ordinary double-convex objectives to achromatic lenses; for the latter, being adjusted for a much smaller field, produce an image which is only distinct in the centre; and the former, being of low power, may have an aperture quite sufficient to admit the requisite amount of light. Even with deeper objectives, the performance of this eye-piece approaches much more closely to the effect of an achromatic microscope, than would be supposed by those who have only seen the ordinary one; and, when made on a small scale, it may be advantageously substituted for Mr. Holland's for all but the most difficult objects. The two additional surfaces are of course disadvantageous, by reflecting some of the fainter rays proceeding from the more delicate markings; but the increased magnifying power is gained with so little aberration,

that a considerable general advantage is hence derived. We can regard no microscope as complete, without an eye-piece of this kind, with a set of ordinary objectives of low powers; for it will certainly do what no other combination with which we are acquainted can effect. The great improvements recently made in the construction of achromatic objectives, and the unquestionable fact that, for exhibiting the minute details of objects, they are infinitely superior to all other kinds, have had, we think, a tendency to blind microscopists to the advantages afforded by other combinations, where it is desired to obtain a view of the general arrangement of the parts of a large object, rather than to investigate its minutiae.

We should recommend, therefore, that every achromatic microscope should be fitted with at least two Huyghenian eye-pieces, adapted expressly to the achromatic objectives; and that it should also have a meniscus eye-piece, with a set of ordinary object-glasses of long focus. And the best substitute for such a microscope, at least for the purposes of anatomical or physiological research, we believe will be found in Mr. Holland's doublet microscope, which should be furnished with his eye-piece for doublets already described, and with a meniscus eye-piece and ordinary object-glasses of low power. In this last form of compound microscope, there is the further advantage, that the high magnifying power of the doublets and triplets employed as objectives renders them available as simple microscopes; and this cannot be said of achromatic object-glasses, which have not yet been usually made of shorter focus than one-tenth of an inch, and which are not, therefore, of much use in themselves. No one, however, can be regarded as entitled to form positive conclusions in regard to difficult questions of microscopic enquiry, until he has availed himself of the very best means of observation at his command; and these are certainly to be found only in achromatic microscopes of the highest class.

For viewing large opaque objects, achromatic objectives of low power are often very useful, on account of the large quantity of light they admit, which supersedes the necessity of artificial illumination; this is a particular advantage in anatomical investigations, in which it is often especially necessary to avoid the reflection of condensed light from the surface of the object, on account of the confusion which is thereby occasioned.

The achromatic objectives at present usually made on the continent consist of sets of three or more, of which one, two, or three may be used at once. In this manner considerable variety of power may be gained; but the highest degree of perfection in the performance must be sacrificed to obtain it, since no single objective consisting of two lenses only can be thoroughly corrected, and each combination ought to be corrected for itself alone. The best achromatics made by British artists consist of combinations of two or three compound lenses, which cannot be separated; and thus

Fig. 165.

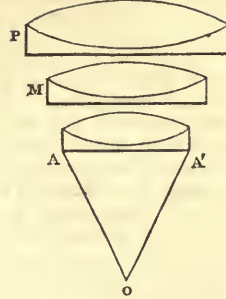

Section of the English achromatic combination.

every required power must be furnished by a distinct combination. The expense of a microscope fitted with the requisite number of these, however, is a great bar to its general employment. Other combinations have been constructed, therefore, in which the lens next the object may be removed, so as to diminish the magnifying power considerably; and the corrections are so adjusted as to be nearly the same when the two or when three compound lenses are used together. The difference between the performance of the best of these, and that of those most perfectly adjusted, is not, for general purposes, of much importance. Two sets of these separating lenses,—a high and a low one,—giving four powers, therefore, which may range from an inch and a half to one-eighth of an inch focus, will adapt the microscope, with the eye-pieces we have mentioned, to a great variety of purposes.

The power may be further varied by lengthening the body of the microscope, by drawing out the eye-piece, which should always be made capable of this kind of movement. This operates by increasing the distance from the object-glass of the image formed by it, and therefore augmenting the size of the image; the object must of course be brought somewhat nearer on the other side. We have already stated that the length of the body cannot be much increased with advantage; but a moderate variation will be found useful in many ways. It enables the magnifying power to be adjusted to almost any point intermediate between those given by the different objectives. Thus, one may give a power of 80 diameters, and another a power of 120; by using the first, and drawing out the eye-piece, the power may be increased to 100. Again, it is often very useful to make the object fill up the whole, or nearly the whole, of the field of view. This is especially the case, when it is itself not very transparent, and requires a strong light to render its details visible; in which condition a glare entering around its edges would very much interfere with its distinctness. When opaque objects, also, are being viewed by condensed light, in the modes hereafter to be stated, it is often extremely desirable to make them, or the discs on which they are mounted, fill up the whole field. In either case the

drawing out of the eye-piece until the end is accomplished answers the object most simply and effectually. In the use of the micrometric eye-piece, also, which will be presently described, the capability of adjusting the magnifying power to a certain definite amount will be found of very great utility. It is to be borne in mind, however, that for giving the *highest* effect to the achromatic objectives, a certain fixed distance of the eye-piece is necessary; this is usually adjusted by the maker; but it may be easily determined by trial, since at any other the want of correction of the chromatic aberration will make itself apparent (however slightly) by the presence of coloured fringes around the images.

The degree of perfection in the construction of the optical part of a microscope, whether simple or compound, is judged of by the distinctness and comfort (by which we mean the freedom from strain or effort on the part of the observer) with which it exhibits certain objects, the details of which can only be made visible by combinations of lenses of high magnifying power and a near approach to correctness. Such are called test objects. They are of various degrees of difficulty. For testing the *penetrating* powers of a microscope, the lined scales on the wings and bodies of certain insects are commonly employed. The scales from the wings of many Lepidoptera are so coarsely marked, that a good ordinary compound microscope, or deep single lens, will make the lines apparent. But there are many others, which, under such magnifying powers, only show a flat unmarked surface, requiring lenses of large angular aperture to make their lines visible. One of the most beautiful of these, and at the same time most easily resolved, is the scale of the *Menelaus* butterfly; its longitudinal *striæ* may be seen in the best ordinary microscope, but they require a corrected object-glass to be well made out; and its transverse markings are only to be seen distinctly with a superior instrument. A scale with more delicate lines than these is the larger of those of the *Lycæna Argus*; the smaller one will be presently noticed. The most difficult of the test-scales, however, is that of the *Podura plumbea*, or common spring-tail; and a microscope which will distinctly exhibit its markings may be regarded as, for this class of objects, of the highest order. For *defining* power, however, another class of objects is needed. Among these one of the best is the small scale of the *Lycæna Argus* (or *battledore*), which, with an inferior instrument, appears covered with coarse longitudinal lines; but these, when more perfectly defined, are found to be resolvable into separate circular or oval dots, arranged in a linear manner. The curious hair of the *Dermestes*, and that of the *Bat*, require a microscope of good defining power to represent their forms with clearness and accuracy. We have ourselves been accustomed to employ the branching hairs of the common bee as tests of the correctness of a microscope of moderate power; for they have

a remarkable tendency to produce fringes of colour, under most of the ordinary modes of illumination, unless there is a perfect freedom from chromatic aberration. The spiral fibres lining the tracheæ of many insects, also, will be found good tests of the defining power, and freedom from aberration, of a microscope. For still lower powers, we consider the glandular dots in the woody fibre of the resinous trees (especially those of the order *Coniferae*) as very advantageous tests. They ought to be rendered distinctly visible with an object-glass of half an inch focus; and the depression in the centre should be clearly made out, with a perfect freedom from colour. We have seen objectives of English construction (in which a large aperture for showing opaque objects was the chief point aimed at) so defective in this respect, as to be far inferior in their exhibition of these and similar objects to French acromatics of much smaller aperture. We may here repeat the general rule, that those microscopes are, *ceteris paribus*, the best, which will show the most with the lowest magnifying power. It will sometimes happen that, although the details of an object may be made out with tolerable clearness, there is a sort of thin fog or mist over the whole field. This fault may proceed from the too great enlargement of the aperture of the objective, or from a faulty mode of illumination; or it may result from the imperfect extinction of the rays reflected within the body of the microscope from the surfaces of the lenses of the eye-piece, and from the interior of the tube itself,*—a fault which may be obviated by carefully coating the inner surface with a black covering, adapted to absorb all the false light. Black velvet may be advantageously used for this purpose. If the aperture be too great, the fault may generally be corrected by the use of *stops* beneath the stage, by which it may be diminished as required. This plan, which will be presently described more in detail, will be found very much to increase the applicability of low-power achromatic lenses of that large aperture which is desirable for opaque objects.

II. OF THE MECHANICAL ARRANGEMENTS OF MICROSCOPES.

Having now described, with as much detail as the nature of this article permits, the principles on which the operation of the microscope depends, we shall next proceed to consider the means of arranging the optical portion of the instrument, so as to confer upon it the best and most varied application, keeping especially in view, however, the wants of the anatomist and physiologist. We shall begin by stating what, in any form of microscope, we regard as the essential conditions to be attained in its construction.

1. Steadiness and firmness in all its parts,

* [Or it arises, as suggested to the Editor by Mr. Powell, the eminent optician, from imperfection in the correction of the objectives.—ED.]

so that it may be free from vibration. An amount of vibration, which is imperceptible when low powers are used, is sufficient to render the most perfect optical arrangements for high magnifying powers next to useless. That the whole instrument should be secured as much as possible from vibration, by being placed upon a steady table, and this on a steady floor, is of the first importance for its advantageous employment. But, as an entire freedom from this cause of vibration can rarely be obtained in an ordinarily-constructed house, the next point to be aimed at is such an arrangement of the optical portion of the instrument in regard to the object, that any vibration which takes place may affect both alike, in which case it will be scarcely perceptible. In many microscopes of ordinary construction the stage is comparatively motionless, whilst the body (containing all the optical portion) is subject to tremor; and in such instruments, when a high magnifying power is employed, the object is seen to oscillate so rapidly upon the slightest cause of vibration (such as a person walking across the room or a carriage rolling by in the street) that it is frequently almost indistinguishable. Various modes have been devised for obviating this inconvenience, the chief of which we shall hereafter notice.

2. Capability of accurate adjustment to every variety of focal distance, without movement of the object. It is now a principle almost universally recognised in the construction of good microscopes, that the stage on which the object is placed should be a fixture; and that the movement by which the focus is to be adjusted should be effected in the body or optical portion. Several reasons concur to establish this principle, which was, we believe, first insisted upon by Dr. Goring.* Among the most important we consider to be that, if the stage is made the moveable part, the adjustment of the illuminating apparatus must be made afresh for every change of magnifying power, whilst, if the stage is a fixture, the illumination having been once well adapted, the object may be examined under a great variety of magnifying powers, without its being changed in any respect. Moreover, if the stage is the moveable part, it can never have that firmness given to it, which it ought for many purposes to possess. It is almost impossible to make a moveable stage free from some degree of *spring*; so that, when the hands bear upon it in adjusting the position of an object, it yields to an amount which, however trifling, becomes apparent with high powers by the alteration of the focus. We might add many more reasons, but these will here suffice. It having been determined, then, that focal adjustment should take place in the optical portion of the microscope, the next point for consideration is the mode of effecting it. This should be such as to allow free range from a minute fraction of an inch to three or four

inches, with equal power of obtaining a delicate adjustment at any part. It should also be so accurate that the axis of the instrument should not be in the least altered by movement in a vertical direction; so that, if an object be brought into the centre of the field with a low power, and a higher power be then substituted, it should be found in the centre of *its* field, notwithstanding the great alteration in the focus. In this way much time may often be saved by employing a low power as a *finder* for an object to be examined by a higher one; and, when an object is being viewed by a succession of powers, no readjustment of its place on the stage is required, such as would otherwise be necessary for each. The best modes of securing these ends, also, will be considered in their proper place.

3. The power of placing the instrument in either a vertical or a horizontal position, or at any angle with the horizon, without deranging the adjustment of its parts to each other, and without placing the eye-piece in such a position as to be inconvenient to the observer. It is certainly a matter of surprise that opticians should have so long neglected the very simple means which are at present so commonly employed, of giving an inclined position to microscopes; since it is now universally acknowledged that the vertical position is, of all that can be adopted, *the very worst*. We do not ourselves consider the *horizontal* position of the body and its appendages at all an advantageous one, although it has been adopted in some of M. Chevalier's latest and best instruments. In the first place it requires that the whole microscope should be raised so much above the level of an ordinary table, as to bring the eye-piece to the height of the eye of the observer when sitting upright at his ease; if this be not done, a constrained and consequently disadvantageous position of the head is required on his part; and if it be, all the manipulations must be executed at an elevation very inconvenient and fatiguing to the arms. Moreover either the stage must be rendered vertical, in which case all the objects must be so secured (to prevent their slipping) as to render the necessary movement of them very difficult; or, the stage being horizontal, the direction of the rays must be changed, after they have passed through the object-glass, by a prism or a mirror placed at an angle of 45° in their course, as in M. Chevalier's construction, which we think a decided disadvantage, as introducing another source of imperfection and error. We believe that it will be generally acknowledged, that an inclination of about 45° to the horizon is the most convenient for unconstrained observation; and the instrument should be so arranged, that, at such an inclination, the stage may be so far elevated above the table, that, when the hands are employed at it, the elbows may rest upon the table. In this manner a degree of support is attained, which gives such free play to the muscles of the hands, that movements of the greatest nicety may be executed by them; and the

* See Pritchard and Goring's *Microscopic Illustrations*.

fatigue of long-continued observation is greatly diminished. Such minutæ may appear too trivial to deserve mention; but no practised microscopist will be slow to acknowledge their value. At the inclination we have mentioned, the departure of the stage from the horizontal position will not be such as to render it necessary to confine the objects with more than a slight force, and accordingly they may be moved by the hands with considerable freedom; and light objects may be placed upon a slip of glass without any confinement, or covered with talc if necessary, and yet be in little danger of falling off it. These are conveniences which are of more value in practice than they may appear in theory; for it will often be found that the saving of a little time in the adjustment of the microscope is of great importance in the observation of objects which are undergoing change. There are some objects, however, which can only be seen in a vertical microscope, as they require to be viewed in a position nearly or entirely horizontal; such are dissections in water, saline solutions undergoing chrySTALLISATION, &c. For other purposes, again, the microscope should be placed horizontally, as when the camera lucida is used for drawing or measuring. It ought, therefore, to be made capable of every such variety of position.

4. The last principle on which we shall here dwell is *simplicity* in the construction and adjustment of every part. Many ingenious mechanical devices have been invented and executed, for the purpose of overcoming difficulties which we cannot but regard as trivial. If all these were combined in one instrument, a degree of complexity would be thereby engendered, which would prevent it from being generally available. Our own experience leads us to the conclusion, that a moderate amount of dexterity in the use of the hands is sufficient to render most of these superfluous; and without such dexterity, no one, even with the most complete mechanical facilities, will ever become a good microscopist. We shall hereafter describe, however, some of those which are in most general use; premising that we cannot speak from much experience of their applicability, since we have ourselves found no difficulty in doing without them, as we recommend our readers to do. Although a large box, well filled with glittering brass implements of various shapes and sizes, may have a very inviting appearance, it will often be found that these are more for show than use, and add to the expense of the instrument in a proportion far exceeding their utility. Among the conveniences of simplicity, the practised microscopist will not fail to recognize the saving of time effected by being able quickly to set up and put away his instrument. Where a number of parts are to be screwed together before it can be brought into use, interesting objects as well as time are not unfrequently lost; and the same cause will often occasion the instrument to be left exposed to the air and dust, to its great detriment, because *time* is

required to put it away. With those who are not practised in mechanical manipulation, this is especially necessary; indeed we have often known a slight advantage on the side of simplicity of arrangement cause an inferior instrument to be preferred to a superior one. Yet there is, of course, a limit to this simplification; and it ought never to interfere with due attention to the principles already specified.

Before proceeding to notice any of the ordinary forms of *stands* for simple or compound microscopes, we shall make a few remarks on the best means of carrying on a dissection under a magnifying power. The simplest of all means of effecting this, where the object is large and opaque, and a low magnifying power only is requisite, is to fasten it down upon a board, to any part of the edge of which may be affixed, by means of a small clamp, a jointed stem, carrying a socket or cell, into which a lens mounted in the usual manner may be dropped. This stem, being capable of movement in every possible direction, but having also sufficient stiffness in its joints to remain in any position in which it may be placed, appears to us preferable to any other plan of supporting the lens. The object may be illuminated, if necessary, by light condensed through a convex lens, or reflected from a concave mirror. If the dissection must be carried on under fluid, the only variation necessary is the use of a shallow trough, instead of a board, which may be filled with water, dilute spirit, or oil of turpentine, as the case requires; to the edge of this trough the clamp may be fixed in the most convenient position; and the bottom of it (if of metal) may be covered with a piece of cork, or a layer of resin and beeswax, for the purpose of receiving the pins necessary to fix the object. Where the object is smaller, and the dissection may be carried on under a higher magnifying power, we can strongly recommend the use of Mr. Slack's dissecting microscope, of which a description and figures may be found in the 49th volume of the *Transactions of the Society of Arts*.*

Dissecting instruments.—The instruments employed in microscopic dissection must of course vary with the nature and size of the object. The following will, we think, be found most generally useful. Small pointed scalpels. The iris-knife is a convenient size and form for many purposes. Scarpa's curved cataract needle is an instrument which we have found extremely serviceable. Fine scissors, one leg of which should be fixed in a long handle, and the other kept apart from it by a spring, so as to close by the pressure of the finger and to open of itself; the blades should both be pointed and sharpened on a hone; these will

* [Mr. Powell, the optician, Clarendon-street, Somers' Town, has enlarged and improved considerably Slack's dissecting microscope; and Mr. Ross, of Regent-street, has also on sale a convenient form of dissecting microscope, which is delineated in the Penny Cyclopædia, art. 'Microscope.'—Ed.]

be found much superior to any form of knives for cutting *through* delicate tissues without disturbing them. Swammerdam is said to have made great use of such implements, in his dissections of insect structures, which, from the accounts of them on record, seem almost to have surpassed any which have been since executed. The curved forceps recommended by Mr. Slack, we also have used with much advantage. For more minute dissection we can strongly recommend *common needles*, and cutting implements which may be easily manufactured from them, by grinding down their sides upon a hone. These may either be fixed in wooden handles, or, which is much better, held in little instruments resembling crayon-holders, specially constructed for their reception. The dissector is thus enabled to give to his needle the effect of a long elastic point or of a short stiff one, by simply altering the part at which it is held. In the ivory handles of these holders, also, there is a receptacle for the needles, which makes the whole of this useful little apparatus complete in itself.*

Many microscopists, especially on the continent, are in the habit of making great use of the *compressorium*, an instrument in which an object may be submitted to graduated pressure between two plates of glass, the parallelism of which is perfectly maintained. The results obtained by such compression, however, must be accepted with great caution, and need to be corrected by those views of the object which are gained without that distortion of it to which it is liable in this method. The class of investigations in which the *compressorium* is most valuable, is that in which such structures as the minute ovum need to be closely scrutinized, without any further change in their shape than may render their contents more distinctly visible. For such purposes we believe that a steady hand and a well-made aquatic box will answer the purpose sufficiently; but to those who prefer relying on mechanical assistance, the *compressorium* will be a useful instrument.

We shall now proceed to describe some of the modes of mounting and arranging simple and compound microscopes, which appear to us most convenient. The first that we shall notice is a form which has cheapness and simplicity to recommend it, and which, if well made, is capable of an adjustment sufficiently delicate for all ordinary purposes. It is a slight modification of one of Mr. Pritchard's.† *A* (fig. 166) is the stand, or basis, into which the pillar is screwed. This may be variously constructed, according to the purpose for which it is designed. If *bulk* be an object, it may be a round disk of lead; but if *weight* must be avoided, a thick tablet of mahogany about six inches square, or five inches by seven, (the longest side being in the direction of the movement of the pillar,) is preferable. If great

Fig. 166.

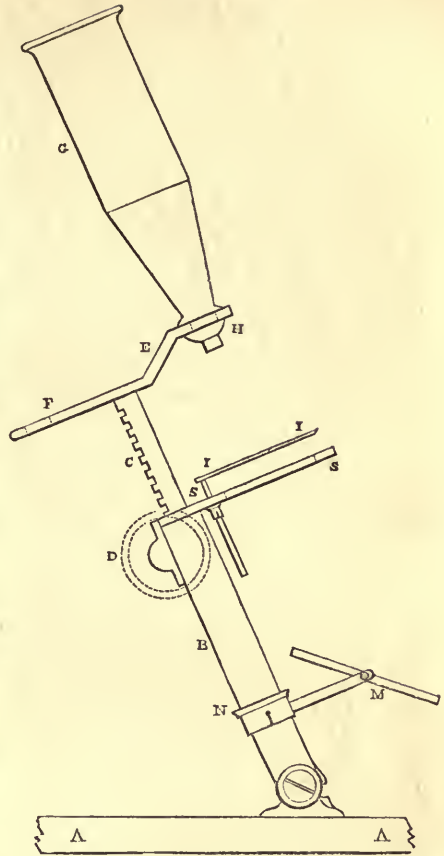

Elevation of ordinary compound or simple microscope.

A, base; B, hollow pillar, with joint at bottom; C, triangular rack; D, nut by which it is moved; E, bar carrying compound body; F, other end adapted for simple magnifiers; G, compound body; H, objective; I, spring fork; M, mirror attached to sliding tube, tightened by the nut, N; S, stage.

portability be desired, the pillar may be made to screw into the top of the box that holds the apparatus; but this plan should not be adopted, unless all the smaller fittings be contained in a tray which may be lifted out, in order that there may be no necessity for opening the box when the instrument is in use. The pillar is a thick tube of brass about six inches long, with a large screw at the bottom for being attached to the stand, and a joint above this, for allowing it to be inclined at any angle. If this joint be well constructed, the instrument will remain in any position in which it is placed, without any steadying rod or perceptible vibration. Within the tube is a triangular bar, with a rack cut on its posterior edge; this may be raised or depressed from the top of the tube, by turning the milled head, which carries a pinion working into the rack. Particular attention

* Such needle-holders are sold by Mr. Pritchard, Fleet-street, London.

† Microscopic Illustrations, 2nd ed. p. 82.

should be paid to the action of this rack ; it should work through a triangular socket at the top of the pillar of at least an inch long, closely embracing the bar, so that it may be moved up and down without the least shake, or variation from its axis, or tendency to slip, when loaded with the full weight it has to carry ; at the same time, it should be sufficiently *sensitive* to be moved by the slightest rotation of the pinion, which may be effected, not only by the milled head, but by a lever, as in Mr. Holland's microscope. Such a rack will afford the means of focal adjustment for doublets and triplets of high power, as well as for ordinary magnifiers. If it be considered desirable to vary the length of the pillar, and consequently the height of the stage, this may be effected by attaching the rack, stage, &c., to a piece of tube which shall slide within the one that is attached to the base ; if the top of the lower one is *sprung*, and surrounded by a clamping screw, the upper one may be firmly fixed at any elevation. This plan has been proposed by Dr. Goring for the pillar of his engiscope ; but we consider it perfectly inapplicable to a large instrument, of which the pillar should be solid, in order to avoid oscillation. The triangular bar carries at its top a double arm, attached to it with a screw and a small milled head, by which its movements may be rendered more or less free. This arm should be thick and well hammered, in order that, when it carries the compound body, it may not be subject to vibration. The object of the double bend in one side of it is to allow the *nose* of the body, which is screwed into the hole on that side, to project below it, so that the magnifiers may be attached on its under side ; by this means, the necessity for unscrewing the body every time that the magnifier is to be changed (which is requisite where the magnifier is screwed into the arm and the body into it) is avoided, without any increase in the length of the rack, which would otherwise be necessary for low powers. The other side of the arm carries the magnifiers, when employed as single lenses ; the same set may be used as are fitted to the compound body, their interior being *screwed* for attachment to it, and their exterior being adapted to drop loosely into the hole of the second arm. For such a microscope, we should recommend a series of ordinary lenses from $2\frac{1}{2}$ or 2 inches focus to $\frac{1}{4}$ th of an inch, and two or three doublets from $\frac{1}{10}$ th to $\frac{1}{20}$ th, with a triplet of $\frac{1}{30}$ th. These may all be used as objectives with a meniscus eye-piece ; though, for the latter, Mr. Holland's will, in most cases, be preferable. The stage of this microscope may be a simple plate, attached to the top of the pillar, as in *fig. 166*, with a spring stage and other appurtenances adapted to it. We are inclined to recommend for such a microscope, however, for the sake of simplicity and facility of use, a stage in which the ordinary principle of fixity is in some degree departed from. The upper part of it consists of a thick and strong fork, projecting about 2 inches and about $1\frac{1}{2}$ inch broad, of well-hammered brass, firmly attached

to the top of the pillar ; at about $\frac{1}{4}$ ths of an inch below this is a plate of similar dimensions, with an aperture of about an inch. Bearing upon this lower plate by a spiral spring, and guided by vertical pins working through apertures in it, is a thin moveable plate, which is constantly being pressed upwards by the spring against the fork. This stage combines, in a degree which renders it an extremely convenient one, the advantages of the ordinary spring-stage, and the fork. The objects, whether placed in sliders, on slips of glass, or in aquatic boxes, are readily slid under the prongs of the fork (which should be bevelled off on the under side so as to allow them to enter), and are held by the spring with sufficient firmness in any position, whilst ready movement is also permitted them. The fork may have a vertical hole drilled in it on each side, for holding the stage forceps or other such instrument ; and it may be made thick enough to allow of a lateral hole for fixing the condenser, without being too much weakened. The thickness of the fork will be of no kind of inconvenience, as the nose of the microscope will have free play from side to side between its prongs. To the lower plate may be attached ground-glass, stops, condensers, polarising apparatus, or any other required fittings. The disadvantage of this stage is that it affords no firm support to the object, which is in some instances of importance. This may be obtained by simply adapting a plate to the upper side of the fork, which may be received into grooves on its lower surface ; and this plate may then be considered as the stage. Whenever such an instrument is being adapted to the purpose of dissection, all that is necessary is to raise up a support for the hands on each side of the stage, which may consist of books, or still better of blocks of wood cut to the form of the outside of Mr. Holland's case ; and the height of the stage being then adjustable by the sliding tube of the pillar, all the advantage of Mr. Holland's microscope, except its *self-containedness*, may be secured. We have only further to mention the mirror, which should be at least two inches in diameter, and have one of its sides plane, and the other concave. Its stem should be attached to a short piece of *sprung* tube sliding over the pillar, and capable of being secured in any situation by a clamping screw.

If a still more portable microscope be required, combining considerable range of power with great exactness of adjustment, we can strongly recommend an instrument constructed upon the plan of the large one subsequently to be described, (*fig. 167*.) but upon about two-fifths of the scale. Its pillar may either be screwed into the lid of the box containing the apparatus, or mounted on a tripod similar to that which is used for portable telescopes,—the tripod being reversed, and the legs being folded round the stem, when it is packed in its box. The delicate focal adjustment of which this microscope is susceptible renders it more advantageous than the one last described, when deep magnifying powers are being employed ;

and its portability is a great recommendation. The one in our own possession is packed, with its tripod, into a box whose outside dimensions are 7½ inches by 5, and its depth only 2, and this also contains a short body with meniscus eye-piece, four ordinary magnifiers, and three doublets and triplets, which may be used singly or as objectives, illuminating lenses and speculum, aquatic boxes, and other small apparatus,—the weight of the whole being no more than 2¼ lbs, although a magnifying power of 450 diameters, with sufficient penetration to exhibit the markings on the Podura, and with perfect steadiness, may easily be obtained by it.

The instruments we shall now describe are not adapted for use in any other way than as compound microscopes. Their size and weight are such as would render them far less convenient than the smaller forms already described for use with simple lenses, although there is no other reason why they should not be thus employed. Every constructor of microscopes has his own favourite model; and there are few recently made instruments of the highest class which do not possess some particular recommendations. Amidst the numerous claimants to our notice, we shall select two; of which the first is the form adopted by one of the best constructors of achromatic objectives in this country; and the second is the one which we have ourselves had in use for several years, and which we do not desire to lay aside for any we have seen. With respect to the former, our limited space compels us to refer to the article Microscope in the Penny Cyclopædia, where a delineation and full description of Mr. Ross's Microscope will be found.*

We shall now describe the microscope

* [Without wishing in the least degree to detract from the merit of Mr. Ross's microscope, (to which, on the contrary, he bears willing testimony,) the Editor deems it but justice to refer to a very beautiful instrument constructed by Mr. Powell, which he has employed for some time, and which is also used by several observers in this city. The body of the microscope moves on a triangular bar, having a bearing of three inches, which renders it very steady. The coarse adjustment is obtained by a rack and pinion, attached to which are two large milled heads, which allow of the body being adjusted with either hand. The fine adjustment has also two milled heads, only two inches apart from the coarse one, and their axis being horizontal and parallel to each other, renders the motion of the hand from one to the other perfectly easy, without removing the eye from the body of the microscope. The stage is seven inches square. The convenience of its being thus large is, that the hands do not interfere with the object when adjusting it. The heads that move the stage have their axis in the same line, and so placed that with the same hand the stage may be moved in all directions; this is convenient when viewing an object, the surface of which is very irregular; with the right hand you can move the stage, and there being two heads to the adjustments for the body, with the left the object can be adjusted into focus. There are likewise two milled heads to one motion of the stage, by which means both hands may be employed at the same time, which is sometimes requisite. On the same bar that the body rests, moves the "achromatic condenser," by which arrangement it is certain to move in the same line with the body,

which we have ourselves been accustomed to employ, and state what we regard as its advantages; not omitting to notice the objections which may be brought against it, and bearing in mind that every microscopist is naturally most partial to the form which he has himself adapted to his own ideas of convenience. It is principally constructed according to the plans of Mr. Pritchard and Dr. Goring; and we may observe *in limine*, that the objections which have been brought against any form of construction in which the body is screwed by its lower extremity to a horizontal arm, as placing it in the most unfavourable position for vibration, independently of the stage, are applicable only to instruments which are not made with sufficient solidity; for, having had an opportunity of comparing the quality in this respect, of Mr. Ross's microscope, with our own, the two being placed in exactly the same circumstances, we could not find that there was any inferiority on the part of the latter. It must be borne in mind, that every increase in the size and power of a microscope must be accompanied by *more than* a corresponding increase in solidity, in order to guard effectually against oscillation.

The stand or basement is a slab of solid mahogany 12 inches square and 1¼ inch thick, loaded with lead at the corners, and having a strip of thick baize, about 1½ inch broad, glued round the edge of the under side; the whole weight bears upon the baize, which does not readily communicate vibrations; and the large surface over which the pressure is distributed gives the instrument a degree of *imperturbability* which would scarcely have been anticipated. The slab is surrounded by a slightly elevated rim; and it thus serves as a most convenient little table, on which the various pieces of apparatus required for microscopical observation may be carried about with the instrument without any danger. The pillar of the microscope carries at its lower extremity a screw, above which is a flange or shoulder of 2 inches diameter; the screw is received into a socket let into the wooden foot, and firmly attached to it, and itself having a shoulder of equal size; so that, when the pillar is firmly screwed down upon it, there is not the least tendency to vibration between the two. The socket is not let into the middle of the base, however; but its centre is only 2½ inches from one of the sides, and 9½, therefore, from the other; so that, in fact, when the microscope is placed vertically, the centre of the stage pretty nearly corresponds with the centre of the foot. The object of this is to give a decided preponderance in weight to the front of the foot in all positions of the microscope; for we are inclined to think that much of the oscillation so frequently complained of in microscopes is to be

which is most essential, for unless it did so when using different power object-glasses, the axis of the lenses would not coincide. There are many other conveniences and improvements to this microscope which cannot be mentioned in this brief notice.—ED. J.]

Fig. 167.

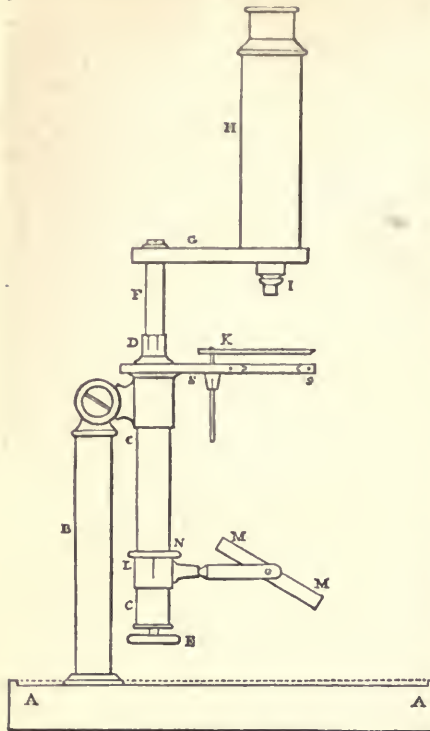

Superior Compound Microscope.

A A, base; B, pillar with joint at the top; C C, stem, containing square tube D, which is moved by a fine screw turned by the nut E; within this tube slides the square bar F, carrying the arm G; into this is screwed the tube H, within which the compound body slides; I, the objective; K, stage-fork; L, sprung tube, tightened by the nut N, carrying the frame of the mirror M.

attributed to the fact, that, when the instrument is much inclined, the hinder foot receives nearly the whole weight, and the portions of the instrument on the two sides so nearly counterpoise each other, that a very slight cause will communicate an oscillation to the whole. We can strongly recommend to our readers a basis of this kind, having not only our own experience of its benefit to guide us, but that of friends whom we have induced to adopt it, and whose previously unsteady microscopes have been greatly improved thereby. It certainly does *not* possess the merit of portability; but this, in a large microscope for observations of the highest kind, ought not to be a consideration. Nothing is easier than to have a separate tripod of the ordinary kind for use when occasion requires. To such a tripod Mr. Ross* has recently applied a method of construction, which he states to be very effectual in obviating vibration; but we cannot speak from experience in regard to its use; and being well satis-

fied with our own much simpler and less expensive plan, we do not see the necessity for it.

The pillar is just an inch in diameter, and consists of a stout brass tube loaded with lead. On the firmness of this part much depends. It is 8 inches from the foot to the centre of the joint. The middle piece of the joint is $\frac{1}{4}$ th of an inch thick; and to this is attached a tubular clamp with a binding screw, which closely embraces the stem. This mode of construction we adopted in accordance with the recommendation of Dr. Goring and Mr. Pritchard;* but we are doubtful if its advantages counterbalance the disadvantage of a certain want of fixity which it imparts to the remainder of the instrument supported by it. The stem is a thick brass tube of about $\frac{7}{8}$ ths of an inch in diameter; to the upper part of it is firmly attached the stage, which is composed of a simple plate of well-hammered brass, $\frac{1}{2}$ of an inch thick; its length from the front of the pillar is 4 inches, its breadth $2\frac{1}{2}$ inches, and the diameter of its aperture $1\frac{1}{2}$ inch. The only fitting constantly attached to it is the fork, of which the two wires work through sockets projecting from the under side of the stage. This fork is made sufficiently thin to possess a certain degree of elasticity; and, being firmly held in any position by the friction of its wires, it is a very useful means of holding aquatic boxes, slips of glass, large sliders, &c., affording, by its wide opening, (2 inches,) considerable freedom of movement to the object. The utility of this fork will depend upon the goodness of its construction in the first instance; it ought to work easily, and yet hold tightly in any position. The sockets through which its wires pass should be *sprung*, so that they may be tightened at pleasure, should they work loose. The stage has a slight rim projecting into the lower side of the aperture, in order to hold various fittings which are attached to it by a bayonet catch, and holes are drilled in various parts of the stage (the massiveness of which prevents its being weakened thereby) for the reception of the pins of the forceps, condenser, &c. The stem carries a sprung tube, to which the mirror is attached, in the manner to be presently noticed.

From the top of the stem projects a square tube, a little more than $\frac{7}{8}$ ths of an inch each way, the upper end of which is sprung, so as to grasp with sufficient firmness a solid bar of half an inch square, which slides up and down within it. The upper end of this bar carries the arm to which the body of the microscope is attached; on the accuracy of its formation the *truth* of its movement will of course depend; but if well made, a rise and fall of $3\frac{1}{2}$ inches may be allowed to it, without the slightest alteration in the position of the axis of the body which it carries. The advantages of this sliding movement over the rack commonly employed for the coarse adjustment we regard as considerable; very much time is saved; for the arm may be shifted from its greatest to its least distance from the stage, in scarcely more time than is

* Microscopic Journal, No. 2.

* Op. cit.

required for making the slightest adjustment. The axis of the body is never changed in the least degree,—which we have rarely found in rack adjustments, owing to the pressure of the pinion against one side of the bar; and thus an object is always kept in the centre of the field, whatever change made be made in its focal distance by an alteration of the magnifiers. By a little practice, the power of making adjustments of extreme minuteness may be obtained, if the bar have been originally filed so true that it works with perfect smoothness in every part. An additional adjustment, which may be made of any required fineness, is provided for, however, by making the square tube or socket itself moveable, and connecting it with a micrometer screw worked by a large milled-head at the bottom of the stem. By turning this screw, the socket, and the bar which it carries, are raised or depressed in any minute degree; and the socket being made to work through stuffing-boxes closely packed with cork, all twisting on its axis by the action of the screw is avoided. On the fineness of the screw the delicacy of the adjustment will of course depend. That which we have employed has forty turns to the inch; and the milled-head being $1\frac{1}{2}$ inch in diameter, or about $4\frac{1}{2}$ inches in circumference, a movement of one-fiftieth of its periphery, or something less than $\frac{1}{100}$ th of an inch, will affect the arm to the amount of $\frac{1}{2000}$ th of an inch. We should recommend, however, a screw rather finer than this. By dividing a circle on the milled head, and affixing an index-point to the bottom of the stem, the amount of motion given may be known to a great nicety, and thus the thickness of a minute object laid upon any surface may be measured. If its upper side be brought exactly into focus, and it be then removed, and the surface on which it has lain be brought into focus by the micrometer screw alone, the number of divisions over which the index has passed will of course indicate the thickness. This method, which was proposed by Mr. Valentine,* answers very well for such objects as the vessels of plants, scales of insects, &c. which can be completely isolated, when a sufficiently high power is employed, so that distinctness can only be obtained at one point. We consider it a great advantage of this kind of adjustment, that it is effected at a considerable distance from the stage, and that the hand is therefore in no danger of deranging the position of objects or apparatus connected with it.

The arm which carries the body is attached to the top of the bar by a screw-pin passing through the former, by which it is enabled to traverse from side to side. This movement will often be found extremely useful, both in the examination of different parts of objects which it is desirable not to move, and in changing magnifiers, &c. on the body; the want of it we consider one of the chief inconveniences in Mr. Ross's form of construction. The arm is $\frac{3}{8}$ ths of an inch thick, and broad enough at the part farthest from the centre to receive the

body, which is not made tapering in the usual manner, but is attached by a screw of $1\frac{1}{4}$ inch diameter, with a large shoulder above it. By this mode of attachment, and by the massiveness of the arm itself, all vibration from the top of the bar is prevented; at least we have not been inconvenienced by it. When the bar is pushed into its socket, so that the arm approaches the stage, (as when high powers are used,) no oscillation can arise from its vibrations; and the socket itself works through an aperture in the stage-plate, to which it is so closely fitted that no oscillation can arise in that point; so that, both in theory and practice, we find the form here proposed unobjectionable on this score. It is true that, when the bar is drawn out to its full extent, oscillation may arise; but this is never the case, except when low powers are being employed, and then we altogether fail to perceive it. In the construction of the body there is nothing worthy of peculiar remark; and, as we have already described the various modes of magnifying the object, we shall therefore now pass on to consider the best means of illuminating it.

The perfect illumination of the object is a matter of the utmost importance, especially when high magnifying powers are being employed. There are many difficult objects which require to be viewed under a great variety of aspects, in order that their true characters may be determined; and there are not a few whose structure cannot be understood at all, even with the most perfect arrangement of the optical portion of the microscope, unless similar attention be bestowed on the concentration of the light by which they are viewed. We shall, therefore, bestow on this subject more attention than it has ordinarily received.

For transparent objects of large size, which are being viewed with low powers, such as sections of wood, wings of insects, &c. we find a concave mirror by far the most simple and, at the same time, effective means of illumination; and the optical errors to which it gives rise are not such as to interpose any practical difficulty in its use. It should be, for such a microscope as we have described, of greater size than that ordinarily employed; three inches may be regarded as a good diameter. It should be set, by an universal joint, upon a piece of tube fitted to slide stiffly up and down the stem which descends from the stage. In this manner its distance from the object may be readily varied; and the degree of concentration of light effected by it will thus be easily adapted to the character of the object to be viewed. Thus, if it be pushed near the stage, the pencil of convergent rays will not be nearly brought to a focus, and a large surface will be illuminated with a moderate light. But if it be drawn nearer the opposite end of its range, the rays will be more concentrated, so that a smaller surface will be illuminated, but with much greater brightness. By the former adaptation we are enabled to illuminate, with great equality, and by means of the ordinary lamp-flame, an area of three-eighths of an inch in diameter, with sufficient intensity to produce a very bright

* Trans. of Soc. of Arts.

field of fourteen inches. In viewing large objects for which great perfection is not required, we find it advantageous to interpose a ground-glass at about half or three quarters of an inch distance beneath them; this is easily adapted to the under side of the stage. It serves to produce an extremely equable diffusion of the light over a large field, and to deaden the glare which is occasioned by the direct admission of so large a quantity; but, if applied to objects which require to be seen with great distinctness, it will be found to produce a kind of fog which seriously impairs the power of the microscope; and with objects of any difficulty it is quite inadmissible. In viewing objects, however, of the largest size that the microscope can receive, by a good diffused daylight, the ground-glass is never required. A bright cloud, *opposite to the sun*, is then the best source of illumination. For the purpose of effecting these and other adjustments of the mirror, we have found it convenient to have the tube which carries it *sprung*, so as to slide rather loosely on the stem, and to secure it in any particular situation by means of a large milled head which screws on one end of the tube, and clamps it upon the stem.

The plane mirror, with a condensing lens between it and the stage, is preferred by many to a concave mirror; and for certain objects it is, without doubt, superior. For ordinary use, however, we prefer the concave mirror, for the following reasons:—Its effects are obtained by a single adjustment; whereas, in the use of the plane mirror and lens, two adjustments are required: and if (as we shall presently state to be often desirable) the mirror be thrown quite out of the axis of the optical part of the instrument, it is difficult to adjust the condenser with correctness. Further, in order to obtain light enough for a field such as we have mentioned, the condensing lens must be nearly three inches in diameter, and thus becomes very cumbersome and inconvenient. For objects of a high class the concave mirror should of course not be employed; but for these the common condenser is by no means adapted, and must be put aside for a superior one, such as we shall presently describe. The plane mirror and condenser enable the observer, however, to obtain an additional variety of illumination, which is often advantageous; and by a simple modification, proposed by Mr. Varley, the light of a bright cloud may be artificially imitated by them. The means of doing this consist in covering the surface of the plane mirror with carbonate of soda or pounded glass, by which the direct solar rays are reflected very much as by a white cloud. We have also seen a plaster of Paris mirror employed for the same purpose, and with good effect, where, on account of the transparency of the object, it was necessary to reduce the amount of light sent through it, without interposing any screen that should produce indistinctness.

It is often very desirable to throw the centre of the mirror a good deal to one side of the axis of the body of the microscope, so that the reflected rays may fall very obliquely upon the

object, and cause its prominences and depressions to exhibit shadows of much greater depth than can ever be seen with more direct light. No microscope, in which there is not a provision for this movement, can be regarded as having its resources properly developed; and we have seldom seen one which comes up to our ideas of the degree in which it should be permitted. In general, the mirror-frame is immediately fixed to the sprung tube which carries it; and thus it can only be turned out of the axis at an angle which will evidently interfere with its use. In our own microscope, the mirror-frame is connected with the tube by a stalk of an inch in length, so that the centre of the mirror is three inches from the stem. This, of course, involves a lengthening of the stage, and of the arm which carries the body, in order that the centre of the apertures of all three may be in the same line; but the disadvantage hence resulting is easily avoided by increasing the strength of these parts. The variety of illumination which may be given by a mirror fitted in the manner we have described, is very great; and some very curious and unexpected phenomena are not unfrequently disclosed by means of it. For example, the field may be rendered almost dark, by turning the centre of the mirror considerably out of the axis, so that none of the rays reflected by it pass up the body of the microscope; whilst objects of great delicacy will frequently appear brilliantly illuminated, on account of their retention of a part of the light which is passing obliquely through them. In this manner we have often been enabled to see an immense number of the minutest animalcules (monads) rapidly moving through water, in which, with direct light, none but the larger ones could be distinguished; and the interest of the spectacle is heightened by the phosphorescent glow which the animalcules appear to have when thus illuminated.* A similar effect may be produced without the use of the concave mirror, by causing a direct pencil of rays from a lamp or candle to be thrown very obliquely upon the object by means of a condensing lens.

In the examination of many delicate objects with high powers, direct light will often be found more advantageous than reflected. This may be obtained with facility, by placing a lamp or wax-candle behind the stage, the mirror being turned out of the way. In the day-time the direct light of a bright cloud will often be found to produce an extremely beautiful effect; but in order to attain this without an inconvenient position of the head, the microscope stand must be elevated to such a height, that, when the stem is horizontal, or even inclined in a position contrary to the usual one, the eye-piece may be at a convenient height for the eye. The different modes of illumination best suited to different objects can only be found out by experience, since achromatic objectives vary in their relative effects with each.

* This method of viewing objects was publicly noticed, a few years since, as a new discovery; it had long, however, been familiar to ourselves, and, we believe, to most other scientific observers.

When condensed light is employed with deep powers, great care is necessary in order to bring out the best effects of a microscope, with difficult objects. These remarks apply to the simple as to the compound forms of the instrument. We do not ourselves consider the ordinary condenser as of much more value for the higher than for the lower class of transparent objects; and we think that it may be discarded from the instrument without disadvantage. Great assistance may be obtained, however, from a well-constructed condenser, in the resolution of the more difficult class of microscopic objects. That which was proposed by Dr. Wollaston for use with his doublet consists of a tube about six inches long, having at the lower end a diaphragm with a circular perforation about three-tenths of an inch in diameter, through which light, proceeding from a radial point or surface, is reflected by a mirror below it. At the upper end of the tube is a plano-convex lens, about three-fourths of an inch focus, with its plane side next the observer; the object of which is to form a distinct image of the circular perforation in the plane of the object, which should be at about eight-tenths of an inch from the lens. We consider this instrument to be theoretically faulty; inasmuch as the point from which the illuminating rays diverge, and the limiting aperture are not coincident, so that pencils brought to a focus for the former are not for the latter. The length of the tube, again, is an inconvenience, especially in the case of small microscopes. Nevertheless, it is much superior to the ordinary form of condenser. An improvement was suggested by Dr. Goring, which consisted in shortening the tube below the lens, and removing the stop from that end of it to the other, so that it should be just beneath the object; in this manner the illuminating rays may be brought to a focus on the object, the superfluous ones being cut off by the stop. We have derived much advantage from the use of this condenser in the small doublet microscope already noticed, and by a slight modification of it we can obtain a variety of illumination, which is often very useful. Our condenser consists of three tubes, one sliding within the other; the outer one is fixed to the under side of the stage; the second carries at its upper end the stop, the distance of which from the object may thus be changed, and the inner one carries the condensing lens. A stop may be screwed into the bottom of the latter, if it is desired to adopt Dr. Wollaston's plan. We have derived the greatest advantage from the use of this condenser, however, by using it with direct light from a radiant point at some distance,—a bright cloud, for instance, in the day-time,—and a lamp or candle on the opposite end of the table at night. In either of these cases, the focus of the illuminating rays may be made coincident with the plane of the object, without that glare which will almost certainly be produced if the source of light is nearer and more intense. When thus used, Dr. Goring's condenser approaches in its

VOL. III.

character to that of Sir D. Brewster,* which we shall now describe, adding some ideas of our own in reference to its construction.

The principle of illumination on which Sir D. Brewster lays great, and we think fully-deserved stress, is, that the focus of the illuminating rays shall be coincident with the object, so that there shall not be two sets of rays at different angles, one proceeding from the luminous object and the other from the object to be magnified. This can only be attained in any degree by making the image of the illuminating body coincident with the object; and it will be perfectly accomplished, in proportion as the rays forming that image are themselves free from aberration. If, for example, the white rays have been separated into their component colours by the condenser, these colours will be imparted to the object, the appearance of which will also be rendered less distinct by the spherical aberration of the condensing lens. Hence an *achromatic lens*, or, if this be objected to on account of its expense, a Herschel's aplanatic doublet, should be used as the condenser; the latter we have found to answer very well, as the centre of the circle illuminated by it is very nearly free from false colour. Further, if a mirror be employed to change the course of the rays, it should be of metal, in order to avoid the false rays reflected from the first surface of the glass. If day-light be employed, no other precaution is necessary; but if the illumination be obtained from a lamp or candle, it will be necessary to limit the amount of light admitted. This must not be by a stop placed beneath the lens, for the reason already specified; but it should be accomplished by a stop or shade placed as *near as possible to the flame*, so that the image of that and of the flame may be brought—virtually if not exactly—to the same focus. We have found that the same end may be attained by removing the lamp or candle to a greater distance, so as to diminish the intensity of the light to the required amount, and only a very low flame will then be required, as the condensation of the rays is much more perfect than with the ordinary lens. The achromatic condenser is strongly recommended also by M. Dujardin, an eminent microscopist of France; and we know that it is now considered an indispensable addition to microscopes of the highest class, affording, as it does, the means of resolving objects, previously considered too difficult to admit of a clear view of their nature. We are disposed to think, however, that some improvement is necessary in order to develop the *highest* powers of this instrument. The rays of light proceeding from the radiant point or object, being brought to a focus by the condenser on its surface, cross each other there, and should proceed to the object-glass of the microscope, as if they came from the object itself. Now, unless they are made to converge upon the object at the same angle at which they diverge

* Treatise on the Microscope, from the Encyclopædia Britannica.

to enter the objective, we cannot but think that a source of error still remains, and that the most perfect image possible, formed by an achromatic object-glass, of an object which is artificially illuminated, can only be produced when the rays from the source of light take exactly the same course as if they proceeded from the object itself. That they may have this course, they must be made to converge upon the object by a condensing lens, whose focus for parallel rays (if the illuminating point be very distant) shall be the same as the acting focus of the objective. A different condenser would thus be required for every objective; but the expense of these would be sufficient to preclude their general employment. The same condenser might be employed, however, for several low powers; the highest having their own expressly adapted to them. We may mention it as a fact for which we cannot very well account, that we have been able to obtain a very beautiful and distinct illumination by the use of an aplanatic-doublet condenser, receiving its rays from the ground glass globe of the common table-lamp, which would not seem to furnish any of the conditions that we have dwelt on as of theoretical importance.

Opaque objects may be illuminated in two principal ways, either by a light cast obliquely upon them by a condensing lens, or by rays thrown upon them perpendicularly by a silver speculum fixed to the object-end of the body, which receives them from the mirror below. Both these modes have their peculiar advantages, and will be found by experience to be applicable with advantage to different classes of objects. No general directions on the subject can, however, be given. The condenser to be used by lamp-light for large opaque objects should be a bull's-eye or hemispherical lens of four inches in diameter; by this, even from a common candle or flat-wicked lamp, a sufficient light may be attained for almost any purpose, and with an Argand lamp a very powerful illumination is obtained. For the parallel rays of day-light, however, an ordinary double-convex lens of the focus of two inches or more may be employed; this may be mounted upon a separate stem and foot, as the bull's-eye should always be, or it may be attached to some part of the microscope itself. We have seen foreign instruments in which it was fixed to the object-end or nose of the body; a construction which we deem essentially bad, inasmuch as it then requires to be readjusted every time that the focal distance is changed by the substitution of one objective for another. A better mode in our opinion is to attach it to the side of the stage by a jointed arm possessing a pin which may be fitted into one of three or more holes drilled in the *side* of the stage with sufficient tightness to remain in any position. If the wire to which the lens-frame is attached be made to pass through a sprung socket connected by a ball-and-socket-joint with the jointed arm, an immense variety in position may be readily given to the condensing lens,

which will render a separate mounting for it unnecessary.

The metallic speculum, or Lieberkuhn, for throwing down rays directly upon the object, is sometimes attached to the objective itself, sometimes to a tube which may be drawn down over it to the required amount. The former construction is the most perfect, each magnifier having its own speculum; but the latter is most economical, as one speculum serves for many objectives. When the latter construction is employed, the tube should be marked with the numbers of the magnifiers at the points at which it may be best adjusted for each, so that, when the object is in the focus of the objective, it may be in full receipt of the rays reflected from the speculum. In this mode of illumination the size of the concave mirror will be found to have a considerable influence; and the capability of adjusting also its distance from the speculum gives a useful variety to the mode of illumination. It can never be too fully kept in mind, that, in the examination of doubtful objects, no really satisfactory result can be attained, until they have been viewed in every possible way. When the object is not perfectly opaque, or does not fill up the whole of the field of view, it should always be placed on an opaque disc, which should be large enough to interrupt all the rays passing directly upwards from the mirror to the eye. The colour of this disc may be advantageously varied for certain objects, but in general we consider a dead black the best for giving them effect. As a general rule it may be remarked, that the fewer the rays entering the eye *except* through the object, the more perfect will be the view of it; and if there be anything approaching to a glare around an opaque object, whether the light proceed directly from the mirror, or be reflected back from the too-bright surface of the disc, it is equally injurious, and will occasion a mistiness over the object itself. It is evident, however, that the size of the disc must be governed by that of the field of the objective employed; for, if too large, it will interrupt too much of the light impinging on the speculum. A piece of black glass, mounted upon a long strip of common window-glass, will be found very useful where the object is such that it can be laid upon it when the microscope is inclined. When the object requires to be held in the stage-forceps, however, a disc of black card may be placed behind it, so as to afford it a back-ground. And for some delicate opaque objects, it is most advantageous to employ little concave discs or cups, with their interior blackened, in front of which the objects are to be placed. Similar dark back-grounds are useful when oblique light is employed.

III. MAGNIFYING POWER OF MICROSCOPES.

The next point to which we shall advert is the mode of estimating the magnifying power of microscopes, and of measuring the real size of objects under examination. Our esti-

mate of the magnifying power of a microscope must depend upon the standard which we assume as the ordinary distance at which the object is seen with the naked eye; since, if brought within five inches, it is seen under double the angle, and therefore of double the size which it appears to possess at ten inches. If, therefore, the former distance were taken as a standard, the magnifying power of a lens or microscope will only be half that at which it would be estimated with reference to the other. Nearly all opticians, however, have agreed in considering ten inches as the standard of comparison; and when, therefore, an object is figured as magnified 100 diameters, it is meant that this figure placed at ten inches distance from the eye is 100 times the dimension, each way, of the real object seen with the eye alone at a similar distance. The measurement of the magnifying power of simple or compound microscopes by this standard is attended with no difficulty. All that is requisite is to have a glass or thin slip of ivory accurately divided to a small fraction of an inch ($\frac{1}{100}$ th will usually answer very well), and a common foot-rule, divided to tenths of an inch. The glass or ivory micrometer being adjusted to the focus of the magnifier, the rule is held parallel with it, at the distance of ten inches from the eye. If the second eye be then opened, whilst the other is looking at the object, the circle of light included within the field of view, and the object itself will be seen faintly projected upon the rule; and it will be very easy to mark upon the latter the apparent distances of the divisions on the micrometer, and thence to ascertain the magnifying power. Thus, supposing that each of the divisions of $\frac{1}{100}$ th of an inch corresponded with $1\frac{1}{2}$ inch upon the rule, the linear magnifying power is 150 diameters; if it corresponded with half an inch, the magnifying power would be 50 diameters. The superficial magnifying power is of course estimated by squaring the linear; but this is a mode of statement never adopted by scientific observers, although often employed to excite popular admiration or to attract customers by those whose interest is concerned in doing so.

When the magnifying powers of the several objectives of a microscope are known, it is easy to make a fair approximation to the real size of an object under examination, by projecting its image, as before, upon a foot-scale held at ten inches distance; and the apparent dimensions it there exhibits, divided by the magnifying power employed, will of course be its real size. More accurate measurements are generally required, however, although the foregoing may serve as a sufficiently near approximation for ordinary purposes. Various methods of obtaining these have been devised. The most perfect measurements are obtained by a fine micrometer-screw, by turning which either the object or the body will be made to execute a transverse movement; just as, in the fine adjustment of the focus, the body is made to approach or recede from the stage. This apparatus may be attached to the stage, if it be

thought preferable to move the object, or to the arm if the body be made to traverse. In proportion to the fineness of the screw, and to the size of the milled-head, will measurements be obtained of minute accuracy. In the focus of the eye-piece a very fine thread is placed; and one edge of the image being brought against it, the position of the micrometer is noticed; and the other edge being then brought to the same line, the number of divisions of the micrometer-screw, which have passed over the index, will indicate its size. The expensiveness of this micrometer, when made with sufficient accuracy and minuteness, is the only bar to its general employment. Other means have been devised, however, which are scarcely inferior; and the simplest of these requires only the use of an eye-piece of a construction different from the ordinary, with coarsely divided glasses. The micrometer eye-piece is made upon the principle of Ramsden's. The optical part of it differs from that in common use, in having the plane side of the field-glass turned towards the object; and in the adjustment of the foci of its lenses in such a manner that the image to be viewed by it must be beneath the field-glass instead of being between it and the eye-glass. In its focus there is placed a plane glass with divisions on it; these may be from $\frac{1}{2}$ th to $\frac{1}{100}$ th of an inch apart; the latter will enable very minute measurements to be taken. By this arrangement, when the object is brought into focus, it appears as if it were traversed by cross lines; since its image is coincident with the divided glass, and is, like it, viewed by the eye-piece as by a simple microscope. The *value* of these divisions will, of course, depend upon the degree in which the object is magnified in the image; and they must be ascertained for every objective, by the divided glass or ivory micrometer. This being brought into focus, and so placed that the direction of its two sets of lines shall correspond with those of the divided glass in the eye-piece, the number of divisions in the latter, corresponding to each division of the former, must be observed, and their value will be thus ascertained. Thus, if one division on the $\frac{1}{100}$ th inch micrometer be found to coincide with eight on the eye-piece, these eight will together indicate a dimension of $\frac{8}{100}$ th of an inch upon the object; and each division of the eye-piece will of course be equivalent to the $\frac{1}{100}$ th of an inch. If there is not an exact correspondence, or if it be desired to obtain a power which can be expressed in round numbers, a little alteration in the length of the body, made by drawing out his eye-piece, will enable the microscopist to effect this; but the eye-piece should be marked, so as to be adjustable to the same point again, when the same magnifying power is employed. When the value of the divisions on the glass in the eye-piece is ascertained for every magnifier, the object-glass micrometer may be put aside altogether; since by the use of the eye-piece alone, a series of lines, the real distance corresponding to which is known, is projected

upon the object; and, with a little practice, a very close estimate may be formed of the proportional size of the object, when it only extends over a part of a single division. This, for ordinary purposes, is by far the most convenient mode of measurement.

The camera lucida, however, which has been adapted to the microscope for the purpose of delineating representations of microscopic objects, may be most advantageously applied also to micrometry. By this instrument (of the construction of which we shall presently speak) a highly magnified picture is projected upon a surface on which its outlines may be easily marked, and on which their size may, therefore, be determined with the greatest nicety. Here, as in former cases, the micrometer object-glass must first be employed, in order to fix the standard. If one of these be placed in the focus of the microscope, and the camera lucida be so adjusted, that an image of its lines be thrown upon a piece of paper at a fixed distance from it, the distance of these may be marked with precision; and subdivision on the paper may be carried to any required extent, so as to afford the means of at once ascertaining the size of an object placed in the field. Thus, if the magnifying power and the distance of the paper be so adjusted, that the lines which are really $\frac{1}{100}$ th of an inch apart are projected upon it at five inches distance from each other, every inch on the paper will of course be equivalent to $\frac{1}{500}$ th of an inch on the object. Lines of $\frac{1}{10}$ th of an inch apart may easily be drawn on the paper; and the distance between each of these will represent $\frac{1}{10000}$ th of an inch on the object. In this manner the size of an object may be known with great nicety, and with less liability to error than in the use of the screw micrometer. It is easy to increase the apparent size of the image thrown by the camera lucida to almost any required extent; so that even greater minuteness may be attained. The distance between the eye-piece and the paper may be increased,—either vertically by placing the latter upon a chair or even on the floor,—or horizontally, by turning the prism or mirror a quarter round, and projecting the image in the direction of the side of the room, so that the range of distance is much increased. Such a plan is, of course, of no use in delineation; but in micrometry it may be had recourse to with advantage, especially when comparing the relative sizes of similar objects, such as the blood-discs. For every magnifying power, whether gained by changing the objective or by increasing the distance of the screen, a determinate value must of course be ascertained for the divisions of the latter.

The camera lucida of Dr. Wollaston is sometimes applied to the eye-piece of the microscope for the purpose of delineation and micrometry; but it is much inferior for these purposes to other plans which have been devised. Probably the best of these consists of a mirror composed of a thin piece of rather dark-coloured glass cemented on a piece of plate-glass, in-

clined at an angle of 45° in front of the eye-glass. Of the light which passes out from the latter, a sufficient quantity is reflected by the mirror to give a distinct image; and yet the paper and pencil can be distinctly seen through the glass, though rather darkened by the coloured glass, which thus serves to render the image more brilliant. A lens is placed below the reflector, which causes the rays from the paper and pencil to diverge at the same angle with those received from the eye-glass; so that both the object and the pencil are seen with equal distinctness. The use of a small highly-polished steel mirror, fixed in the focus of the eye-piece, and inclined upwards towards the eye at an angle of 45° , is by some preferred to this. The mirror being smaller than the pupil allows the rays from the paper to pass up into the eye around it; and thus the image is seen as upon the screw. In the use of either of these instruments, the chief difficulty (as in the use of the common camera lucida) is for the delineator to see both the image and pencil with sufficient distinctness to enable him to make an accurate tracing of the former. Much will depend upon the advantageous adjustment of the amount of light upon the object and the paper respectively. In drawing or measuring by lamp-light, we have found it useful to place a small taper near the screen, so that its direct rays may fall upon it, whilst the lamp is used for illuminating the object; and when the screen is illuminated by daylight it is preferable still to use the lamp for the other purpose. The point of the pencil should be blackened. The micrometer eye-piece also may be employed for drawing; its squares being represented by squares on the paper; and the portion of the object between each being delineated, in the manner commonly practised by artists. No assistance of this kind, however, can supply that skill to the microscopic draughtsman which is required for making finished delineations of any object. Accuracy of outline is all that they can ensure.

Under this head it seems not inappropriate to introduce a few remarks on the degree of minuteness in the structure of objects, which the magnifying power of the microscope enables us to detect.

Much speculation has taken place amongst philosophers at different times, relative to the possibility of detecting the *ultimate atoms* of material, especially organic, substances; and microscopists have occasionally hazarded statements in regard to their size, which an increased knowledge has shown to be invalid. It was a favourite theory about fifteen years since, that all organized bodies are made up of globules, which cannot be resolved into any other kind of structure, the diameter of which was stated at about $\frac{1}{5000}$ th of an inch. The great improvements which have been recently made, however, in the microscope, and the general advance of knowledge on the subject of the ultimate constitution of organized structures, have shown the erroneous nature of this view, by proving that there is no body, however

minute, which is not capable of being resolved into smaller particles, as far as our means of observation can carry us; and the absurdity of the particular dimensions assumed is further shown by the fact, now well known, that there are very numerous species, and countless individuals, among the Polygastric animalcules, whose whole bulk is much less than that of one of the so-called ultimate particles, and which contain within this a considerable number of different organs. The following statements made some years since by Ehrenberg will give a very good idea of the mode in which the size of such organs and of their component parts may be approximately known, when they are themselves too minute for measurement.

"I could plainly distinguish with a microscope magnifying nearly 800 diameters, Monads, which were filled with colouring nutritive substances, and which possessed voluntary motions, but the entire and greatest diameter of whose body only amounted to the $\frac{1}{1500}$ th or $\frac{1}{2000}$ th of a Parisian line. I could perceive in the largest individuals of this form as many as six, and in the smallest as many as four, internal sacs coloured blue by indigo, which at times did not occupy half the internal dimension of the animal. Such a sac, therefore, of an animalcule measuring $\frac{1}{1500}$ th of a line, and if we suppose only four sacs occupying the half of it, (therefore not one of the smallest,) is $\frac{1}{3000}$ th of a line in size. Further, if we suppose the single colouring particles, with which the stomachs are filled, not to be numerous, it would be against all probability not to think that they were filled by several particles. Let us, however, only suppose each sac to be filled with three colouring atoms,—which, from the roundness made perceptible by the motion communicated to them when diffused through the water, we may well admit,—this alone affords a proof of the existence of material colouring particles of red and dark blue moving freely in water, which measure $\frac{1}{3000}$ th of a line, or $\frac{1}{132000}$ th part of an inch in diameter; and calculating these objects from the smallest of the animalcules, which by actual observation were found to be $\frac{1}{3000}$ th of a line in size, and which sometimes contained four coloured points in the hinder part of the body, these particles, which cannot be distinguished individually by the eye with a magnifying power of 800, but which are yet to be recognized as corporeal, would amount to $\frac{1}{277200}$ th of a line, or $\frac{1}{2772000}$ th of an inch. Further, the smaller monad-stomachs are seen isolated in the body, and with sharp outlines. In larger Infusoria, which are $\frac{1}{4}$ th of a line, or more, in diameter, these internal receptacles are recognized as evident membranaceous sacs, which often make their appearance isolated, when the animalcule is pressed, or when it divides itself, and which have been supposed to be separate infusoria, internal monads. It can be distinctly seen that, when two such digestive sacs touch one another, the thickness of the partition between them is, in comparison with the diameter of the stomach, extremely small, so that the former is scarcely perceptible; it may be reckoned as at

the most $\frac{1}{100}$ th of the latter, Granting, however, the thickness of the partition to be as much as $\frac{1}{10}$ th the diameter of the sac, this would amount to $\frac{1}{100000}$ th of a line, or $\frac{1}{13200000}$ th of an inch, in monads $\frac{1}{3000}$ th of a line in size, in which the stomachs measure but one-eighth of the whole length of the body, and are therefore $\frac{1}{18000}$ th of a line in diameter." When similar views are extended to the young of the species on which this calculation is founded, or to smaller species in the existence of which there is good reason to believe, the minuteness of structure thus disclosed becomes still more wonderful. "Let not these calculations," it is justly remarked by Ehrenberg, "be regarded as playful; they are so far in earnest, that they are founded on the contemplation of nature, and are not to be considered as a groundless speculation. They plainly demonstrate an unfathomableness of organic life in the direction of the smallest conceivable space; and if the word infinity be too much for what we know at present, let the word unfathomableness, which I have purposely employed, avert from me the reproach of exaggeration, and establish the direction which the physical, chemical, and physiological enquiries of our days, should they be rendered fruitful by new powers, have to take, and what deviations they have to avoid."

To these enquiries Ehrenberg has subjoined an attempt to calculate the power of vision for the human eye, and the ultimate power of the microscope. From his experiments on the smallest square magnitudes which are ordinarily visible at any distance by the human eye, he finds that they vary in different cases from $\frac{1}{36}$ th to $\frac{1}{102}$ th of a line; but when strongly illuminated, much smaller bodies can be seen, metallic particles of $\frac{1}{100}$ th of an inch being visible in common daylight; and non-transparent threads of $\frac{1}{300}$ th of a line in thickness being distinguished, when held between the eye and the light. Hence the size of the minutest objects visible with a given magnifying power of the microscope might be determined by dividing their apparent dimensions, as just stated, by the magnifying power; thus no square corpuscles of less dimension than $\frac{1}{3600}$ th or $\frac{1}{4800}$ th of a line could be seen with a magnifying power of 100 diameters. In practice, however, owing to the degree of imperfection which must necessarily attend the best-constructed instruments, the minuteness of the smallest visible objects cannot be judged of entirely by this rule; since, in order that it should be correct, it is necessary that the object of $\frac{1}{3600}$ th or $\frac{1}{4800}$ th of a line in diameter, should be represented to the eye as clearly by a microscope magnifying 100 diameters, as a real object of $\frac{1}{36}$ th or $\frac{1}{102}$ th of a line would be; this is very far from being the case, owing to the loss of light by reflection in passing through the lenses, as well as to the errors of the lenses themselves, which can never be perfectly corrected. With a magnifying power of 1000, which is perhaps the highest that has yet been employed to real advantage, the minutest particle which could possibly be

distinguished would be $\frac{1}{36000}$ th or $\frac{1}{48000}$ th of a line square, and thus they would be much larger than those of whose existence a very simple process of reasoning is sufficient to convince us.

BIBLIOGRAPHY.—The following works may be referred to.—*Hooke*, *Micrographia*, Lond. 1665. *Baker*, *Of Microscopes*, Lond. 1785. *Adams*, *On the Microscope*, Lond. 1787. *Brewster*, *Treatise on the Microscope from Encyclopædia Britannica*, also *Treatise on new Philosophical Instruments. On Optics*, *Lardner's Cyclopædia*. *Lister*, in *Phil. Trans.* 1829. *Chevalier*, *Des Microscopes*, Par. 1839. *Mandl*, *Traité Pratique du Microscope*, Par. 1839. *Pritchard* and *Goring*, *Micrographia*; also, by the same authors, *Microscopic Illustrations and Microscopic Cabinet*. *Slack*, *Holland*, and *Turrell*, in *Trans. Soc. Arts*, vol. 49. *Penny Cyclop. art. Microscope*. *Hildebrandt*, *Anatomic*, Band. i. p. 128. (*W. B. Carpenter*.)

MILK.—(Γάλα, Gr.; *lac*, Lat.; *le lait*, Fr.; *die Milch*, Germ.; *latte*, Ital.) The secretion of the mammary gland. In treating of the milk it will perhaps be best, previous to entering upon its description as produced by the human subject, to give a general account of the secretion as obtained from the cow, such being the most familiar example afforded to us. Milk may be regarded as a serous fluid, holding in suspension minute white globules composed of casein and fatty matter. These globules have been microscopically examined by Raspail, who states them to have a diameter of .00039 inch, and to disappear on the addition of a solution of potassa. The most recent microscopic observations on the milk are those of Professor Nasse, of Marburg,* who gives the following as the constituents of the normal secretion of the mammary gland:—1st, smooth, homogeneous, transparent oil globules and large oil globules, also the common milk globules; 2d, cream globules, distinguishable by their facette-like appearance; 3d, granulated yellow corpuscles; 4th, the lamellæ of epithelium; 5th, the more or less turbid medium in which the four preceding kinds of corpuscles are suspended.

The common milk globules are composed of fatty matter, which dissolves rapidly in ether. No membrane can be seen investing them. The first nine days after delivery the largest globules measure $\frac{1}{360}$ th of a line in diameter, but subsequently become as large as $\frac{1}{180}$ th, but they vary in size throughout lactation. The cream globules are considered by Professor Nasse to be formed after the milk has been drawn or exposed to the air, for in fresh woman's milk no globules but the common milk globules above described are discernible: the cream globules occur as large as $\frac{1}{36}$ th of a line in diameter. The yellow granulated corpuscles are peculiar to the colostrum; their diameter is from $\frac{1}{100}$ th to $\frac{1}{200}$ th of a line; some are found measuring $\frac{1}{30}$ th of a line in length and $\frac{1}{15}$ th in breadth. They are composed of fatty matter. The author considers them analogous to the mucus cells cast off from mucous membranes, and thinks that perhaps they come from the gland ducts. From my own observations I am inclined to

think that the cream globule of Nasse exists even in fresh milk, and may easily be seen in specimens containing but little fatty matter. I lately saw them in the milk of a woman who had suckled for seven months. I have not been able to rid the milk of globules by ether or liq. potassæ. If milk be agitated with ether, then allowed to stand, and the lower stratum of fluid examined, we can detect distinct globules in it—globules of all sizes, and having the appearance described by Nasse as belonging to the cream globule. From the variety in size which I have so constantly observed, I cannot understand how any author can have made up his mind to give an admeasurement to the globule of milk; for my own part, after much careful observation, I feel convinced that the milk contains nothing which deserves the name of a true organic globule. That globules exist I do not deny, and these I believe to be what have been described by Nasse as cream globules, appearing when milk has creamed, because the adhering fatty matter is separated; but, notwithstanding, being very obvious before creaming occurs, in specimens of fresh milk containing a small proportion of fatty matter. The serum in which these particles float is composed of water, holding in solution an alkaline lactate and chloride with traces of sulphate and phosphate, lactates of lime and magnesia, sugar of milk, and animal extractive. Oxide of iron and an earthy phosphate are to be detected in the ashes of milk, but these, in all probability, are derived from the casein of the secretion. When milk is allowed to remain at rest for some hours, a pellicle forms on its surface, varying with the nature of the milk: this is what is called the cream, and consists of the fatty or butyraceous matter of the milk in combination with a varying proportion of casein. It is from this cream that butter is obtained by churning, by which operation the butyraceous particles unite into a mass to the exclusion of the casein, which remains suspended in the serum, and thus forms a mixture known by the name of butter-milk or lait de beurre of the French. The whole of the casein, however, cannot be removed from the butter by churning, its minute particles being entangled by the cohering fatty globules, and it is in a great measure owing to its presence that butter is more or less prone to become rancid and decomposed. Milk from which the cream has been removed still retains the greater part of the casein, and when this is precipitated from it by the action of rennet, we obtain a curd, which, being pressed and dried, constitutes cheese. The clear liquor separated from this curd contains the more soluble matters of milk, viz. the alkaline salts with the sugar of milk, and in Switzerland a considerable quantity of this sugar is manufactured from whey and used for household purposes. I have thought it best to notice the various operations in domestic economy to which the milk is subjected, not only because by them several of its proximate elements are eliminated, but likewise that the reader may have some familiar object with which to connect the following account of the

* Müller's Archiv, 1840, Heft iii. p. 268.

chemical properties of the constituents of the fluid.

The fatty matter of milk obtained by churning cream, and which is known by the name of butter, differs from the other forms of animal fat in several particulars. It yields about 88.5 per cent. of fixed acids on being saponified, for which purpose it requires no more than four-tenths of its weight of caustic potassa; it therefore unites with alkali very easily. Of these acids the margaric and oleic are in large proportion, the stearic existing as a mere trace. Glycerine, as is the case with other fats, is a constant product of the saponification of butter. The great distinguishing peculiarity of this form of fatty matter consists in the production of three volatile acids as results of saponification; these have been carefully examined and distinguished by Chevreul in his admirable work, "Sur les Corps gras." He has named them the butyric, capric, and capric acids. The production of these acids by the action of alkali has been traced by Chevreul to the existence of a new form of fat which he detected in butter mixed with the stearine and elain, and to which he gave the name of butyrine: thus butter may be regarded as composed of three different kinds of fatty matter—stearine, elain; and butyrine—the two former yielding by saponification the margaric, oleic, and stearic acids, and the latter the three volatile acids above mentioned. The proportions of the three kinds of fat vary considerably in different specimens of butter. The solubility of butter in alcohol is stated by Chevreul to be 3.46 parts in 100 at a boiling temperature, the specific gravity of the menstruum being 0.822. The stearine obtained from the alcohol by cooling is more crystalline and of a more brilliant white than that obtained from common fat, and 1.45 parts require 100 parts of alcohol of specific gravity 0.822 for its solution. The elain obtained from butter possesses no peculiar characteristics. The butyrine when separated from it, which is only to be accomplished with difficulty, possesses the following qualities:—it is an oil generally of a yellow colour, but some specimens of butter yield it perfectly white; it concretes at 32° Fahrenheit, and possesses the smell and taste of butter; it mixes with boiling alcohol in all proportions; it is soluble in anhydrous alcohol. Potassa and the other alkalis are not the only substances capable of producing the volatile acids by acting on butyrine. Alcohol if long digested produces a similar effect, as does strong sulphuric acid, and if butyrine be allowed to putrify these acids are developed.

The casein or cheesy matter of milk which is obtained with some slight admixture of the fatty matter in the production of cheese from the skimmed milk has the following chemical properties. It is soluble in water after long digestion; but this is most likely owing to some decomposition which occurs in it, and it is certain that casein in its pure, undecomposed, and dry state is quite insoluble in water. Casein, as it exists dissolved in skim milk, is precipitable by the mineral acids and also by

the acetic acid. The process which Berzelius recommends in order to obtain this substance is as follows:—Skim milk is to be mixed with a small proportion of dilute sulphuric acid, which unites with the casein and precipitates it in the form of a white clot. This is to be well washed with distilled water on a filter in order to separate the whey which it contains. After this carbonate of baryta and water are to be mixed up with the mass, by which means the acid is separated and the casein remains dissolved in the water, and may be separated from the carbonate and sulphate of baryta by filtration. Casein obtained by this process is more or less soluble in water, and is precipitated from its aqueous solution by the acids. It rapidly undergoes the putrefactive fermentation. It is soluble in the alkalis and in alcohol both boiling and cold, but far more so in the former, from which it rapidly deposits on cooling. Casein, when dissolved by the assistance of the acids, is precipitated by the ferro-cyanide of potassium. It is distinguished from albumen, with which it possesses many physical and chemical properties in common, by being precipitated from solution on the addition of acetic acid, and the precipitate so formed being with difficulty soluble in an excess of the precipitant. It must not be imagined, however, that albumen under all circumstances cannot be precipitated from solution by the addition of acetic acid, for when dissolved in an alkaline solution, that proximate principle is immediately thrown down on the addition of the acid. Casein, like albumen, always contains some sulphur as a necessary element in its composition; the presence of this body may be easily shown by boiling casein in a concentrated solution of potassa, when the liquor rapidly assumes a brown colour, and gives out ammonia, an alkaline hydro-sulphuret remaining dissolved, which may be proved by the solution becoming of a deep black colour on the addition of a salt of lead. The aqueous solution of casein is precipitated by all the earthy and metallic salts which precipitate albumen in the dissolved state. Tannin precipitates it even from its solution in alcohol, notwithstanding that menstruum protects it from the precipitating action of the acids. The ultimate analysis of casein is, according to Thenard and Gay Lussac, carbon 59.781, nitrogen 21.381, hydrogen 7.429, and oxygen 11.409. Caseous matter, as precipitated by rennet in making cheese, is liable to a peculiar kind of putrefaction, which has been investigated by Proust and Braconnot; the latter obtained as a product of putrefaction a peculiar crystalline substance, to which he gave the name of aposepedine, from *απο* and *σηπεδωρ*, indicative of its origin. Proust had before noticed this substance and called it caseous oxide. It may be prepared very easily by allowing cheese to putrify under water and evaporating the solution so obtained to dryness; the dried mass is then to be treated with alcohol until that menstruum exerts no further solvent action; the portion insoluble in alcohol, on being dissolved in water, and digested with

animal charcoal, yields us by filtration and evaporation pure crystals of aposepedine. This substance has the following properties: it is somewhat bitter to the taste, very slightly soluble in alcohol, soluble in water, and of greater specific gravity than that fluid. It sublimes when heated strongly, but always undergoes a partial decomposition. It contains sulphur. In addition to aposepedine, cheese when decomposing has been found to contain acetic acid, acetates of ammonia and potassa, chloride of potassium, ammoniaco-phosphate of soda, margarate and phosphate of lime, and a peculiar extractive matter.

I shall now proceed to consider the sugar of milk which is left in the whey after the separation of the cheese by rennet, and exists in solution with the salts of the milk, lactic acid, and animal extractive matter.

Sugar of milk may be obtained from whey by evaporating it to the consistence of a syrup, and setting it aside for a length of time, when small granular crystals of the principle are observed to deposit. The following are the principal qualities of sugar of milk. It has a sweetish taste, the grains crushing with difficulty between the teeth; its specific gravity is 1.543. It contains about 12 per cent. of water, which may be separated by carefully fusing it; when fused it is still quite white if the heat be not too strongly urged. It is soluble with difficulty in water, requiring three parts of boiling water and six of cold for that purpose. It is very slightly soluble in alcohol, and quite insoluble in ether. When acted on by concentrated nitric acid it becomes transformed into a mixture of oxalic, malic, and muric acids. By the action of caustic potassa it is changed to a brown-coloured bitter mass, which is insoluble in alcohol.

Sugar of milk has been stated to be incapable of undergoing the alcoholic fermentation; but late experiments by Hess (Poggen-dorf, *Annalen der Physik*) shew that such will occur, and an intoxicating liquor has been long known among the Tartars, which is prepared from the milk of the mare, and to which they give the name of Koumiss. Sugar of milk has been analysed by Berzelius: including its 12 per cent. of water, its composition is as follows:

Carbon....	40.125 or 1 atom,
Hydrogen..	6.762 or 2 atoms,
Oxygen....	53.113 or 1 atom:
or deducting the 12 per cent. of water,	
Carbon....	45.94 or 5 atoms,
Hydrogen..	6.00 or 8 atoms,
Oxygen....	48.06 or 4 atoms.

It will be observed, on comparing the analysis of hydrous sugar of milk with that of starch, that they accord very nearly, and sugar of milk is convertible, as is the case with starch, into true sugar, by the action of sulphuric acid; these facts strongly point out the curious approach to vegetable matter which is made by this constituent of an animal secretion.

After the crystallization of the sugar of milk from the whey, we have left in solution, according to the experiments of Berzelius, lactic acid

and lactates, chloride of potassium, an alkaline phosphate, phosphates of lime and magnesia, and traces of oxide of iron.

I shall not here enter upon the question whether or not lactic acid be the peculiar acid of milk, or whether the substance receiving that name be only a modification of the acetic; the matter is to be found noticed at length in the 7th volume of the French edition of Berzelius' Chemistry. For my own part I can only wish that one quarter of the animal acids mentioned in our modern chemical works had the same right to be distinguished as peculiar animal principles. Mons. Lassaigue, in his work bearing date 1836, when speaking of lactic acid, says, "regardé pendant long temps comme de l'acide acétique modifié par une matière organique, M. Berzelius a établi d'une manière incontestable sa véritable nature." Anhydrous lactic acid has the following ultimate composition.

Carbon.....	50.50
Hydrogen	3.60
Oxygen	43.90

Berzelius' analysis of skimmed cow's milk is as follows:

Caseous matter with some butter	2.600
Sugar of milk	3.500
Extractive, lactic acid, and lactates	0.600
Chloride of potassium	0.170
Alkaline phosphate.....	0.025
Earthy phosphates, trace of oxide of iron.....	0.220
Water	92.875

The cream from this milk yielded the following result:

Butter.....	4.5
Caseous matter	3.5
Whey	92.0

The specific gravity of this milk was 1.0348, and that of the cream 1.0244.

A specimen of cow's milk which I lately examined was of sp. grav. 1.0338, and its solid contents 121.85 in 1000 parts.

The ashes of cow's milk, according to Pfaff and Schwartz, are composed of phosphates of lime, magnesia, and iron, phosphate of soda, chloride of potassium, and soda, which, before incineration, had existed in combination with lactic acid. They found 1000 parts of the milk yielded 3.742 parts of ash.

According to the experiments of Van Stiptrian, Luiseius, and Bondt, the proportion of cream which separates from cow's milk is about 4 per cent. of its weight. They obtained from milk 2.68 per cent. of butter, 8.95 of casein, and 3.60 per cent. of sugar of milk.

The first milk which is observed in the breast after parturition has received the name of colostrum; it differs somewhat from ordinary milk. It has been stated by some authorities that scarcely any cream can be obtained from the colostrum, and that no butter can be obtained by churning. According to Stiptrian, Luiseius, and Bondt, however, the colostrum from the cow yields 11.7 per cent. of cream, 3 of butter, and 18.75 of cheese. They state the specific gravity of the colostrum at 1.072; dried and incinerated it yielded 5½ per cent. of ash. They

do not mention sugar of milk as a constituent, and in this respect agree with MM. Chevallier and Henry, who do not mention it in their analysis of the colostrum of the cow.

Donné has observed a microscopic difference between the globules of the colostrum and those of milk. He states the colostrum globule to be made up of small granules united together, or enclosed in a transparent envelope. They disappear in ether, and when the fluid is evaporated, small tufts of acicular crystals are observed. Donné traced these globules in milk secreted twenty days after parturition. M. Güterbock has also observed these compound globules, and says he could detect the transparent membrane after the ether had dissolved the enclosed granules. M. Mandl has not been able to detect these compound globules, and believes them to be made up of agglomerated milk globules. The following is the result of a comparative analysis of colostrum and true milk by F. Simon.

	Colostrum.	Common milk.
Casein	4 per cent.	3.5 per cent.
Sugar	7 "	4.7 "
Butter	5 "	2.3 "

I shall now proceed to the consideration of the milk of the human subject, which differs in some respects from that obtained from the cow; its general characters are, however, identical. One of the principal differences to be observed consists in the caseous matter of human milk not being so universally precipitable by acids as that which exists in the secretion from the cow. Meggenhofen found but three out of fifteen specimens which he examined that could be precipitated by the hydrochloric or acetic acids. Three specimens of human milk examined by myself were found not to be precipitable either by the muriatic, nitric, or sulphuric acids. Although human milk resists the coagulating power of the acids, it is, notwithstanding, easily precipitable by rennet; but the curd so formed is some time in collecting, owing to the minute size of the precipitating flocculi; thus there appears both a physical and chemical difference between the caseous matter from the human subject and that from the cow. The casein of human milk being incapable of forming insoluble combinations with the mineral acids, may be regarded as bearing *chemically* the same relation to the casein of cow's milk that the albuminous matter of the chyle bears to that principle as it exists in the blood. The butyraceous matter of human milk has been stated by some chemists to be too liquid to admit of the formation of butter by churning; this, however, has been proved incorrect by the experiments of Pleischl, who succeeded in obtaining butter from the cream of human milk, which was similar in appearance to that from cow's milk, and experiments into the nature of this form of butter have been made by Meggenhofen, who considers it as identical with that obtained from the cow. The specific gravity of human milk has been stated so low as from 1.020 to 1.025, but this is certainly far too low; for out of six specimens which I examined the specific gravities varied

between 1.030 and 1.035. The proportion of solid matter contained in milk is, according to Meggenhofen, 11 to 12.5 per cent. and sometimes more. I have had occasion to verify this result, having obtained 64.15 of solid matter from 500 grains of milk. The specific gravity of this specimen was, however, as high as 1.0358.

Human milk when fresh is either neutral or slightly alkaline. Its analysis, according to Meggenhofen, is as follows, being the results obtained from milk from three different subjects.

No. 1.

Alcoholic extractive, butter, lactic acid and lactates, chloride of sodium, traces of sugar of milk	9.13..	8.81..	17.12
Aqueous extractive, sugar of milk, and salts	1.14..	1.29..	0.88
Caseous matter (coagulated by rennet)	2.41..	1.47..	2.88
Water	87.25..	88.35..	78.03

The specific gravity of the milk appears to increase as the woman continues suckling, this increase ceasing at some period which is as yet undetermined. Milk at three days after parturition I found of specific gravity 1.0310, at four days 1.0334, and at six weeks 1.0358.

Payen has analysed three specimens of human milk with the following results:—

Butter	5.18..	5.16..	5.20
Caseous matter.....	0.24..	0.18..	0.25
Residue of evaporated whey (containing the extractives, salts, and sugar of milk)	7.86..	7.62..	7.93
Water	85.80..	86.00..	85.50

Berzelius remarks upon these analysis, and says that a considerable portion of caseous matter remained in all probability in the whey, and was estimated in the residue obtained by evaporation.

According to Meggenhofen the salts contained in milk amounted to from 0.5 to 1.25 parts in 500 of the secretion. In an experiment made by myself, 500 grains of milk yielded 1.20 grains of salts.

Pfaff and Schwartz obtained 4.407 parts of ash from 1000 of milk, which they found to be composed as follows:—

Phosphate of lime.....	2.500
Phosphate of magnesia.....	0.500
Phosphate of iron.....	0.007
Phosphate of soda.....	0.400
Chloride of potassium.....	0.700
Soda from decomposed lactate.....	0.300
	<hr/>
	4.407

Berzelius very naturally expresses surprise that no carbonate of lime, chloride of sodium, or alkaline sulphate, is mentioned in this analysis, since casein always yields the earthy salt, and chloride of sodium is constantly present in animal matters which are intended for the nourishment of man. The absence of alkaline sulphate is quite inexplicable, as it is always a

product of the combustion of animal substances containing an albuminous or caseous constituent. The proportion of cream contained in milk from the human subject has been determined by Sir Astley Cooper at from one-fifth to one-third by measure, varying with the health, the food, the habits, and state of mind of the mother. The colostrum or first milk which is observed in the human breasts has been examined by Meggenhofen. He states that it contains more saline matter than the after milk, and describes it as having the appearance of a weak solution of soap containing oleaginous particles. It is very prone to become sour and decompose, and becomes viscid by exposure to the air, hence its name from *κολημας*, to agglutinate.

Several instances are on record of the existence of milk in the male breasts, and the analysis of a specimen lately published by Mayer in Schmidt's Jahrbucher, July 1837, is as follows:—

Fatty matter	1.234
Alcoholic extractive	3.583
Watery extractive	1.500
Insoluble matters	1.183

Total solid contents 7.500 in 100 parts of the fluid.

It was slightly alkaline. The following were the physical properties of this milk: when left at rest it quickly coagulated, and cream soon separated; after some hours butyraceous globules collected on the surface. Its specific gravity was 1024.

Milk from several of the herbivorous Mammalia has been examined by Stiptrian, Luiscius, and Bondt, with the following results:—

The milk of the ass has a specific gravity of 1.023 to 1.0355; it yields a white and light butter which is very apt to become rancid. The caseous matter does not separate so easily as in cow's milk; the whey, however, can be obtained very clear, and is found to contain more sugar of milk than that from the cow. An analysis yielded the following result:

Cream	2.9 per cent.
Casein	2.3 „
Sugar of milk	4.5 „

The milk of the mare has a specific gravity of 1.0346 to 1.015; it yields but little cream, but contains a very large proportion of sugar; the analysis gave:

0.8 per cent. of cream,
1.61 „ caseous matter,
and 8.75 „ of sugar of milk.

The milk of the mare, as also that obtained from the ass, very rapidly commences the alcoholic fermentation, an effect which cannot be produced but with the greatest difficulty in cow's milk.

Goat's milk has a specific gravity of 1.036; it possesses a very disagreeable odour of the animal, and the more strongly so if the goat be dark-coloured; it yields a large quantity of cream and butter; the latter contains, in addition to the usual acids of butter, a peculiar acid to which the name of hircic acid has been given; it is to this principle that goat's milk

owes its peculiar unpleasant odour. This milk contains also a large quantity of caseous matter of a firm dense character. Payen found goat's milk composed as follows:

Butter	4.08
Casein	4.52
Sugar, salts, and extractives	5.86
Water	85.50

Stiptrian, Luiscius, and Bondt procured 7.5 per cent. of cream, 4.56 of butter, 9.12 casein, and 4.38 per cent. of sugar from the milk of a goat.

The milk of the sheep has a specific gravity of 1.035 to 1.041; it yields a larger proportion of cream: the butter is semifluid and pale yellow in colour; it putrifies very easily. This milk yields 11.5 per cent. of cream, 5.8 of butter, 15.3 of caseous matter, and 4.2 per cent. of sugar of milk.

The milk of the bitch and also of the porpoise have been lately examined by Dr. Bird; the former contained 15.8 per cent. of casein, and 7.2 of butter mixed with some sugar of milk. That from the porpoise contained 23.00 per cent. of oily matter, and a volatile ingredient supposed to be phoenic acid. The specific gravity of bitch's milk is stated at 1.024.

The milk is very prone to become contaminated by various ingesta; that of the cow is frequently impregnated by the odours derived from particular pasturage, and if saffron or indigo be mixed with their diet the milk has been observed to assume more or less the colour of those pigments.

Chevallier, Henry, and Peligot made experiments on the milk of asses to whom several different substances had been exhibited; they were enabled to detect the oxides of iron and zinc, the trisnitrate of bismuth, common salt, and sesquicarbonate of soda with great ease; sulphate of soda required to be administered in very large doses before it could be detected in the milk, and sulphate of quinine could not be discovered, though large quantities were introduced into the stomach. These gentlemen state likewise that the iodide of potassium cannot be detected in the milk unless exhibited in doses of upwards of a drachm. This rule, however, cannot apply to the human subject, as I lately very readily detected it in the milk of two of my patients, one of whom had taken only 45 grains of the iodide in divided doses of 5 grains each, administered three times a day for three days; and the other 105 grains in 21 doses of 5 grains each, administered in like manner. It is probable that many substances enter the milk which the present state of chemistry does not admit of our detecting, and every practitioner is aware of the danger incurred to the child by exhibiting any active medicine to the mother during the period of lactation.

There is perhaps no animal secretion which bears so strongly-marked an analogy with the blood as the milk, and which promises us so fair a prospect of discovery in the mysteries of secretion, and we cannot but hope that as animal chemistry advances we may be able to imitate those changes which occur in the minute

parts of the mammary gland, where, though each constituent of the blood be changed in its character to form milk, yet each constituent of that secretion retains an obvious type in the fluid from which it was eliminated; thus if we compare the blood and this secretion side by

side, we remark not only identical physical changes to occur, but also the existence of a set of proximate elements, which, though proper to each, still possess many chemical qualities in common; for instance—

Blood separating into	Clot	{ Fibrin Red particles	Milk separating into	Casein Butyraceous matter	} Cream
	and	{ Albumen Alcoholic extractive, viz. lactates		Casein Alcoholic extractive, viz. lactates and lactic acid	} and
	Serum	{ Aqueous extractive; albu- minate of soda Alkaline salts Fatty matter		Aqueous extractive, with sugar of milk Alkaline salts Fatty matter	} Milk or skim milk

The similarity of reaction between fibrin, albumen, and casein is well known to chemists, and the derivation of the latter from the former can scarcely admit of a doubt; the only difference acknowledged between fibrin and albumen is a physical one, and it would be exceedingly interesting to ascertain whether or not the casein, which, like fibrin, separates on standing, be not physically different from that portion of casein which remains in the fluid after the milk has creamed. The red particles of the blood certainly bear no analogy whatever to the butyraceous matter of milk in its perfectly formed state; it is a curious fact, however, noticed by Sir Astley Cooper, that the colostrum at its first appearance is occasionally of a red colour, and the cream which separates is of a still deeper red tinge, thus rendering it probable that the fatty matters are in this instance the colouring ingredient. I may mention, in addition, that it is not easy to obtain hæmotosine quite free from fatty matter; there appears to exist a natural affinity between them.

The alcoholic extractives of blood and milk are too obviously analogous to need comment, as are the salts and likewise the fatty matters adherent to the casein of the milk and the albumen of the serum. The sugar of milk appears in all probability derived from the aqueous extractive of the blood, an ingredient which has scarcely attracted sufficient attention, and the development of whose chemical relations may perhaps assist us greatly in obtaining a further insight into the true nature of those changes which are effected in the minute structure of secreting glands. I have thought it right to mention the above resemblance, as I cannot help thinking that we may be greatly assisted hereafter in the physiology of secretion by attempting to reduce each proximate element of a secreted fluid to some type in the blood, and afterwards endeavouring artificially to produce those substances from their analogues in the circulating fluid; as nature may perhaps in this way form them for the various secretions, by the so-called chemistry of vitality. Physiologists and chemists are, in the present day, too prone to attribute the formation of those substances contained in secretions,

and which cannot be detected in the blood, to changes occurring among the ultimate elements of organic matter, changes of a character too intimate and obscure ever to be induced by those reagents which non-vital chemistry applies in effecting transformations. Such a conclusion is founded on the assumption that organic chemistry is not to make that progress which we now see in almost every branch of inquiry, a progress marked by the development of new laws which not only become valuable as indicators for the ascertainment of new facts, but which have a retrospective influence on science, rearranging and altering the bearings and relations of previously ascertained phenomena.

(G. O. Rees.)

MOLLUSCA, (Lat. *mollis*,) *Malakia* and *Ostracoderma* of Aristotle; *Mollusques*, Fr.; *Weichthiere*, *Mollusken*, Germ.; *Mollusks*, Engl.; invertebrated animals, distinguished by Bruguiere from insects by the negative characters of the absence of bones, of stigmata, and of jointed feet; and first accurately defined by Cuvier as a primary division of the animal kingdom, with the following anatomical characters. The Mollusks are animals without an articulated skeleton or a vertebral column. Their nervous system is not concentrated in a spinal marrow, but merely in a certain number of medullary masses dispersed in different points of the body, the chief of which, termed the brain, is situated transversely above the œsophagus, and encompasses it with a nervous collar. Their organs of motion and of the sensations have not the same uniformity as to number and position as in the Vertebrata, and the irregularity is still more striking in the viscera, particularly as respects the position of the heart and respiratory organs, and even as regards the structure of the latter: for some of these respire elastic air, and others water, either fresh or of the sea. Their external organs, however, and those of locomotion are generally arranged symmetrically on the two sides of an axis. The circulation of the Mollusks is always double; that is, their pulmonary circulation describes a separate and distinct circle. The blood of the Mollusks is white

or bluish, and it appears to contain a smaller proportionate quantity of fibrine than that of the Vertebrata. The veins probably fulfil the functions of absorbent vessels. Their muscles are attached to various points of their skin, forming more or less dense and complex tissues. Their motions consist of various contractions, which produce inflections and prolongations of their different parts, or a relaxation of the same, by means of which they creep, swim, and seize upon various objects, just as the form of these parts may permit, but as the limbs are not supported by articulated and solid levers they cannot advance rapidly. Nearly all Mollusks have the body enveloped by a duplicature of soft and usually muscular integument, which bears more or less resemblance to a *mantle*: it is sometimes narrowed into a simple disc, sometimes prolonged into one or more tubes, or is extended and divided in the form of fins.

The *Naked Mollusks* are those in which the mantle is simply membranous or fleshy. In most of the species one or more plates, of a substance more or less hard, are developed in its substance, usually in successive layers, which increase in extent as well as in thickness as they are successively formed. When this substance remains concealed in the thickness of the mantle, it is still customary to style the animals 'Naked Mollusks.' Most commonly, however, it becomes so much developed that the contracted animal finds shelter beneath or within it, and it is then termed a *shell*, and the animal is called a *Testaceous Mollusk*.

The mode of generation is too varied in the Mollusks to afford any common character to this sub-kingdom: but, being for the most part sluggish and feeble animals, with low and little varied instincts, they are preserved chiefly by their fecundity and vital tenacity.

The nervous system of the Mollusks may consist of one or more ganglionic masses; but these are scattered, often irregularly or unsymmetrically, through the body, and the intercommunicating chords never form a symmetrical knotted pair along the middle line of the ventral surface of the body; whence the term '*Heterogangliata*,' expressive of the characteristic condition of the nervous system, with which the unshapely and often unsymmetrical figure of the whole body corresponds.

The number of the ganglia follows closely the progressive development of the muscular system: the first is that which is found between the anal and respiratory tubes of the *Ascidia*, and which regulates the elongator and sphincter muscles of these tubes. The development of a muscular heart and of a bivalve shell with its adductor muscle is accompanied with the appearance of a second ganglion or centre of the nerves which supply that muscle: a second adductor muscle, with the superaddition of a muscular foot and its retractors, produces an additional ganglion or ganglions, and the complication of the nervous system is further augmented when the breathing and anal siphons

are unusually prolonged, and provided with strongly developed annular contractile muscles and with proportionately powerful retractors. The progressive development of the nervous system may be traced thus far in the tunicated and bivalve Mollusca without its reaching the stage which is marked by the appearance of a distinct supra-oesophageal ganglion or brain. The species have, in fact, no distinct head, and are termed *Accephalous Mollusks*. The first appearance of this important part with its appendages, which are usually subservient to the organs of special sense, is associated with an accumulation of nervous matter, in the form of a transverse chord, with a ganglion or ganglions, above the commencement of the oesophagus, forming the brain; whence these Mollusks are termed '*Encephalous*.'

The development of the brain proceeds directly as the organs of the senses increase in number and complication, and consequently reaches its maximum in the higher Cephalopods with highly complex eyes and distinct organs of hearing; and in these the brain is protected by a cartilaginous cranium, forming the first representative of the true internal skeleton which is met with in the Invertebrate division of animals, and one of the main organic characters by which the higher Mollusks surpass Articulates in the ascent to the Vertebrate type.

The nervous system of the Mollusks is remarkable for the peculiar and distinct colour of the ganglions in certain species, as the freshwater Muscles and Unios; and for the contrast between the density of the cellular sheath of the nerves and the semifluid pulp which it contains. This structure allows of an artificial injection of the nerves, which has led some anatomists to describe them as parts of an absorbent system.

Although the bivalve Mollusks are headless and without brain, some of them have manifested signs of a perception of light, and in a few species simple ocelli have been detected on the verge of the mantle.

In the Encephalous Mollusks the eyes, when present, are small, never exceed two in number, and are usually supported on flexible peduncles or tentacula; but in the Dibranchiate Cephalopods they are large, always sessile, and highly complicated.

The organ of hearing is peculiar to the Cephalopods in the present division of the animal kingdom.

The organ of smell, as a special and circumscribed part, has likewise been recognized only in the highest class: but Cuvier observes, that the skin of the Mollusks so clearly resembles in its softness and lubricity a pituitary membrane, that they probably may recognize odours at every point of their external surface. Professor De Blainville conjectures that in the Gastropods the soft extremities of the first pair of cephalic tentacles may be the seat of the organ of smell. An organ of taste has of course been recognized only in the Encephalous Mollusks, in many of which the tongue is large

and complex, and in the Cephalopods is evidently provided with gustatory papillæ. The sense of touch is in this as in other groups of animals the most generally possessed and the most widely diffused over the body. The marginal fringe of tentacles on the mantle of most Bivalves; the branched processes of the skin in certain Pteropods and Gastropods; the cephalic tentacles or 'horns,' as they are termed, in the Snail and allied Mollusks; the rich and varied apparatus of cephalic and labial tentacles—nearly one hundred in number—in the Nautilus; and the extremities of the acetabuliferous arms of the higher Cephalopods, may all be regarded as organs of delicate sensation: the same opinion may reasonably be entertained of the highly vascular surface of the ventral locomotive disc or 'foot' in the Slug, Snail, and other Gastropods.

The voluntary muscular fibre of the Molluscous animals is distinguished from that of the Articulate and Vertebrate animals by the absence of the transverse striæ, and in most of the Acephalous Mollusks it is antagonized by a merely elastic gelatinous fibre. In the Tunicaries the flexible outer coat obeys and opposes the change of form which the inner muscular envelope occasions. In the Bivalves, whose shell affords firm levers of attachment to the muscles, the antagonizing elastic force is implanted at the hinge of the shell; and some of the species (*Mollusca subsilentia* of Poli) can, by virtue of this mechanism of solid lever with its attached muscular and elastic fibre, execute short leaps.

The Encephalous Mollusks with a cerebral centre of nervous influence antagonize one series of muscles by the regulated action of another series, and are no longer dependent on mere elastic fibres for their movements. The musculo-cutaneous mantle is produced in the form of fins in the Pteropods, Heteropods, and some Cephalopods; or there is an accumulation of longitudinal fibres, intersected by oblique or transverse ones on the ventral surface of the mantle, producing the thick contractile disc, which is termed the foot. This sometimes extends the whole length of the body, as in the Gastropods, sometimes is developed only from the region of the neck, as in the Trachelipods. The attachment of the body to the shell in these Mollusks, the presence of, and power of retracting and elongating, a siphon or breathing tube, the movements of the head and its appendages, especially when these are developed into instruments of progressive motion and prehension, as in the Cephalopods, are the chief conditions of the progressive advancement and complication of the muscular system in the Molluscous sub-kingdom.

The heterogangliate type of the nervous system, with the correspondingly low condition of the muscular and other organs of relation, which, commencing in the Ciliobrachiata Polypes, is established in the Mollusks, is on the whole very inferior to the conditions and powers of the sensitive and motive systems in the Articulates: but, on the other hand, "the organs of growth and reproduction become more

evolved; and in the *Mollusca* we are presented with a perfecting of the internal organs, which is to prepare for and to be more fully developed in the higher animals."*

The alimentary canal is provided with a separate mouth and vent: the stomach may be distinguished from the œsophagus and intestine, and a liver is present in all the Mollusks, and is remarkable in most for its large size and complicated lobular form. The bile is secreted from arterial blood. The mouth in the Acephalous Mollusks is generally concealed in the interior of the pallial cavity, but is always situated at the anterior part of the body, or that which is opposite to the excrementory and respiratory tubes or orifices. There are neither jaws nor salivary glands in this division. Among the Encephala, however, in which the mouth is armed with horny plates representing in different species the knife, the saw, the rasp, or the scissors, the salivary system attains an extraordinary degree of development, especially in the Cephalopods, in which the mandibles resemble those of the Raptorial bird, and sometimes have their margins armed with a calcareous dentated plate. In the Cephalopods the pancreas makes its first appearance. The special forms of the progressive complications of the digestive system in the present division of animals will be found amply illustrated in the articles TUNICATA, CONCHIFERA, PTEROPODA, GASTROPODA, CEPHALOPODA.

The circulating system, which, as has been stated, is complete and double in all the Mollusks, is provided in all the species with a systemic heart, and in the highest organized species with a distinct heart for the lesser or branchial circulation. The systemic heart first appears in the sessile Tunicaries as a vasiform undivided ventricle, which, however, is enclosed in a distinct pericardium. It is concentrated into a more compact muscular organ in the Conchifers, and divided into a venous and arterial chamber; but the auricle, and sometimes also the ventricle, as in *Arca*, is subdivided and segregated, according to the law of self-repetition, which is exemplified in all the systems of organs at their first appearance in the animal kingdom. The heart of the Gastropods exhibits the higher type of a single auricle and ventricle, both placed at the termination of the lesser and the commencement of the greater circulation. In the highest Cephalopods the course of the blood is accelerated in both circulations by a muscular ventricle, but the superadded analogue of the pulmonic heart here, likewise, at its first appearance illustrates, by its separation into two distinct ventricles, the law above alluded to in reference to the systemic heart of the lower Mollusks.

The respiratory organ is distinctly developed in all Mollusks, and is subject to the greatest variety of forms in this division of the animal kingdom; yet, with the exception of the small sessile order of Ascidians at the lowest extreme,

* See the eloquent and philosophic 'Recapitulatory Lecture' of Prof. Green, *Vital Dynamics*, 8vo. 1840.

connecting the Mollusks with the Zoophytes, it affords perhaps the best positive character of this great primary group of the animal kingdom; for whereas, in the Articulate division, the breathing organs are lateral or open upon or towards the sides of the body, and in the Vertebrate division communicate with the oral extremity of the nutritive canal, in the Mollusca they are connected with the anal outlet.

The uropoietic system, where traces of it are recognizable, as in most Gastropods and in Cephalopods, likewise communicates with the respiratory cavity.

The rich endowment of vibratile cilia deserves to be noticed as characterizing the branchial organs, and constituting the chief mechanism of respiration in most Mollusca. The organs of vegetative life subservient to the procreation of the species are not less remarkable for bulk, variety, and complexity than are those which minister to the preservation and growth of the individual. Although comparatively simple and reduced to the essential formative organs in the Acephala, they are, with very few exceptions, placed in distinct individuals, that is to say, one Ascidian or Oyster possesses only the testicle, and is a male; another only the ovary, and is a female. In the order Conchifera, the females have the gills modified to serve as a receptacle for the impregnated ova during foetal development.

Among the Encephalous Mollusks are many hermaphroditical species, some with the male and female organs terminating sufficiently close together for independent or self-impregnation; others having the outlets of the two organs remote, and requiring the concurrence of another individual in reciprocal fecundation; or the same individual is impregnated by another and impregnates a third, as is curiously exemplified in the nuptial chain thus formed by numerous individuals of the Marsh-snails (*Lymnaea*). The Trachelipods and Cephalopods are again dioecious, like the lowest classes of Mollusks, but exhibit the generative organs under the highest stage of complication; and some of the latter class are remarkable for the expulsion not only of the ova aggregated in groups contained in special receptacles, but also of the spermatozoa in a similar state of aggregation in cylindrical cases, which, by the arrangement of their elastic tissue, manifest movements, prior to their rupture, which have long excited the surprise and admiration of the physiological observer.

A large vitellus, among the numerous nucleated cells of which it is often difficult to recognize a single one as the centre of development, or as the germinal vesicle, characterizes the ovum of most Mollusks. In most species also the early formation of vibratile cilia on the surface of the germinal membrane, and the rotation of the embryo upon its axis produced by their action, are striking though not peculiar phenomena. The adherence to a uniform type in the earlier periods of growth is singularly manifested in the young of *Tritonia*, *Doris*, *Aplysia*, and other naked Mollusks, which are protected for a certain period by an external spiral univalve shell.

The classification of the Molluscous animals has exercised the judgment and discrimination of some of the ablest Zoologists, and is a subject too expanded for the limits assigned to the present article. The principles of a natural distribution into the larger groups according to general organization seem to be adhered to in the following system.

Taking the nervous system as a guide to the divisions of highest value and extent, the Mollusca separate themselves, as already shown, into ACEPHALA and ENCEPHALA.

The Acephala may be divided according to the nature of their external covering into TUNICATA, where this is continuous, flexible, and elastic; and into CONCHIFERA, where it is testaceous and divided into two or more valves. The Conchifera may be subdivided according to the modifications of the respiratory organs into Palliobranchians and Lamelliobranchians. Respiratory characters likewise mainly distinguish the sessile Tunicaries or *Ascidians*, and the floating Tunicaries, or *Salpaccans*.

The Encephalous Mollusks are classified according to their organs of locomotion, as PTEROPODS, GASTROPODS, and CEPHALOPODS. The respiratory organs afford the best characters for the subdivisions or orders of these three classes.

(Richard Owen.)

MONOTREMATA, Gr. *μονος*, single, *τερμα*, hole, in reference to the single cloacal excrementory and generative outlet; Fr. *Monotrèmes*; Ger. *Monotremen*; Eng. *Monotremes*.

An order or primary group of the Implacental subclass of MAMMALIA, representing the *Edentata* in that subclass; allied to the *Marsupialia* by the absence of the corpus callosum and by the presence of the marsupial bones, but differing in the absence of the abdominal pouch and scrotum, in the absence of teeth, in the simplicity of the bigeminal bodies, and in some remarkable modifications of the skeleton and generative organs.

As the order *Bruta* or *Edentata* is that which exhibits the lowest modifications of the Placental type of the Mammalian structure, and offers in some respects the nearest approach in that subclass to the Ovipara, so the *Monotremata* present the extreme modifications of the Implacental type, and make the last step in the transition from the Mammalian to the Oviparous classes.

The Monotremes are, however, true Mammalia in all essential points of structure: they possess functional mammary glands, which are largely developed at the breeding season: their lungs consist of a spongy tissue, subdivided throughout into very minute cells; they are suspended freely in a thoracic cavity, separated by a complete muscular and aponeurotic diaphragm from the abdomen: the arch of the aorta bends over the left bronchus: the larynx is superior, and is defended by a well-developed epiglottis: the kidneys are compact conglobate glands with distinct cortical and medullary substances, secreting the urine from arterial blood, and returning the blood to the

cava by a single large vein. The lower jaw articulates with the base of the zygomatic, and not with the tympanic element of the temporal bone, and the cranium articulates by two distinct condyles with the atlas.

The quadrupeds which combine these essential mammalian characters with the oviparous modifications above-mentioned are peculiar to Australia and Van Dieman's Land; they form three well-marked species, referable to two distinct genera. One of these genera, called *Echidna* by Cuvier, is characterized by an elongated slender muzzle, terminated by a small mouth, and containing a long and extensible tongue like that of the Ant-eaters. The jaws are edentulous, but the palate is provided with many rows of small, sharp, hard, epidermal spines, which are directed backwards, and the base of the tongue is similarly armed. The feet are short, but remarkably broad and strong, and are each provided with five very long and strong claws. The upper part and sides of the body are defended by spines similar to but larger than those of the hedge-hog. The tail is very short. The genus *Echidna* contains two species, one (*Ech. hystrix*) characterized by a more complete armour of spines, with a scantier admixture of darker coloured hair; the other (*Ech. setosa*), by being clothed with a greater proportion of lighter coloured hair, which half conceals the spines. These characters are constant in both sexes, and as well marked in the mature as in the young individuals.

Both species of *Echidna* are terrestrial and fossorial; they feed almost exclusively on ants, and abound in certain districts of both Australia and Tasmania, playing there the same part in the economy of Nature which is assigned to the Pangolins (*Manis*) in Asia and Africa, and to the Ant-eaters (*Myrmecophaga*) in South America.

The *Ornithorhynchus*—the second genus of the Monotrematous order—is an aquatic Insectivore,* but combines water-snails, worms, and other small Invertebrata with the insects that constitute the staple article of its food. These it obtains, not by its tongue, which is short and inextensible, but by its lips, which are largely developed, and supported by singularly modified intermaxillary and lower maxillary bones; the whole mouth presenting a close resemblance to the broad and flattened beak of a duck. The similarity is increased by the lateral lamellæ of the lower jaw; but both jaws are provided with four horny teeth; the anterior one on each side, both above and below, is long, narrow, and trenchant; the posterior one is broad, flat, and shaped like a molar tooth. The feet are short, broad, armed each with five claws, but less robust than in the *Echidna*. The fore feet have a web, which

not only unites and fills the interspaces of the toes, but extends beyond the extremities of the claws; the web of the hind foot terminates at the base of the claws. With these swimming-feet is associated a strong, broad, horizontally flattened tail, which completes the organic locomotive machinery for the aquatic existence of an air-breathing and warm-blooded quadruped. The body is clothed with a dense coat of hair, which consists of a fine fur, intermixed with long, stiff, flattened, and sharp-pointed hairs, that seem to represent the spines of the *Echidna*. Only one species of *Ornithorhynchus* is as yet satisfactorily defined; it occurs in the fresh-water rivers, ponds, and lakes of Australia and Van Dieman's Land.

As external ears and large eyes would be ill suited to the habits either of a burrowing or a swimming animal, both genera of Monotremes are characterized by the absence of the auricle and the small size of the visual organs. The male in both genera bears a horny pointed spur upon the heel, which is perforated, and transmits into the wound it inflicts the secretion of a peculiar gland. This singular repetition of an offensive mechanism, which, prior to the discovery of the monotrematous mammals, was known only in certain insects and serpents, completes the anomalous combinations in the external characters of the present order.

Echidna hystrix and *Ornithorhynchus paradoxus* were first described and figured by Dr. Shaw; the former as early as the year 1792 in the third volume of the Naturalists' Miscellany, under the denomination of *Myrmecophaga aculeata*; the latter in the tenth volume of the same work in the year 1799, by the name of *Platypus anatinus*.

In the following year this more extraordinary animal received a further description, together with its present zoological denomination from Professor Blumenbach, in "Voigt's Magazin für den neuesten Zustand der Naturkunde, Bd. ii, 1800;" and soon after Sir Everard Home gave an account of some of its anatomical peculiarities, which appeared in the Philosophical Transactions for the year 1800. As these observations, however, were limited to the head and beak, they rather tended to perplex than guide the naturalist in assigning the position of the animal in the natural system.

Professor Blumenbach, in his Elements of Natural History, placed the *Ornithorhynchus paradoxus* among the *Palmata* of his mammalogical system, between the otter and the walrus; while Dr. Shaw more naturally referred it to the *Bruta* of Linnæus; but being limited to such points of comparison as the external form alone presented, he merely discerned the affinities of the *Platypus* and the *Echidna* to the *Myrmecophaga*. The real value and extent of these affinities could only be determined by a deeper insight into their respective organizations. The important memoirs on the anatomical structure of both these animals read before the Royal Society by Sir Everard Home, and published in the Philosophical Transactions for 1802, drew the attention of the scientific

* See No. 541, B. Physiological Series, Museum Royal College of Surgeons, London. "Debris of Insects belonging to a genus of the *Nauceridæ*, which were found in the cheek-pouches of the *Ornithorhynchus paradoxus*." Mr. Bennett (Zool. Trans. 1834, p. 239) found in the cheek-pouches of the *Ornithorhynchus* mud and gravel, with fragments of insects and shell-fish.

world more strongly towards their remarkable peculiarities and deviations from the ordinary structure of the Mammalia. In these investigations the author having brought to light numerous instances of mutual affinity, before concealed under very dissimilar exteriors, grouped the two animals together under the same generic appellation, adopting that of *Ornithorhynchus*, proposed by Blumenbach. He likewise expressed his opinion that they differed considerably in their mode of generation from the true Mammalia, on the ground of the peculiarities of the organs themselves, and on the absence of nipples in both species, and especially in the female of the *Ornithorhynchus paradoxus*.

The opinion of Sir Everard Home was soon after adopted by Professor Geoffroy St. Hilaire, who, in the *Bulletin des Sciences Philomathiques*, (tom. iii.), constituted a new order for these animals under the term 'Monotremata;' having been led to believe, from an imperfect dissection, that the genital products of both sexes as well as the urine and excrement, were voided by a single common outlet. Concluding, also, by inference that the mammary glands as well as nipples were wanting, and strengthened in his belief of the oviparous nature of the Monotremata by some accounts from New South Wales respecting the discovery of the eggs of the *Ornithorhynchus*,* he subsequently separated the Monotremata altogether from the Mammalia, and characterized them as a class intermediate to Mammalia, Birds, and Reptiles.

This mode of viewing the Monotremata was

not, however, generally assented to. The Baron Cuvier, who in one of his earliest works* had separated the *Myrmecophaga aculeata* of Shaw from the true Anteaters under the generic term 'Echidna,' and who afterwards made considerable additions to its anatomical history, as well as to that of the *Ornithorhynchus paradoxus*, in the *Leçons d'Anatomie Comparée*, whilst he adopted the collective term 'Monotremata,' admitted it in the '*Regne Animal*' as indicative only of a tribe or family in his order *Edentata*. Spix, Oken, and De Blainville more decidedly opposed the opinion of Geoffroy, and the latter naturalist in an express dissertation on the place which the *Ornithorhynchus* and *Echidna* ought to hold in the animal kingdom, after adducing the numerous instances in which the structure of the Monotremes agrees with that of the true Mammals, expresses his opinion that the mammary organs will ultimately be detected, and considers the animals themselves as most closely allied to the Marsupial order.

The exact position of the Monotremata, their natural affinities, and the value of the group, could, however, be only a matter of speculation before their organization, and especially their cerebral structure, had been thoroughly elucidated; the consideration of these points will therefore be resumed after the requisite anatomical and physiological details have been given, for a knowledge of which, as regards the *Ornithorhynchus*, science is chiefly indebted to the celebrated Meckel.†

Fig. 168.

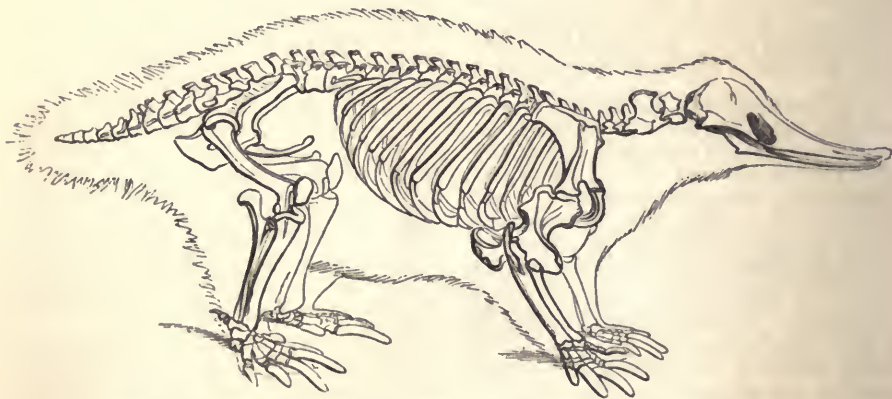

Skeleton of the *Echidna Hystrix*. (Pander and D'Alton, corrected from Nature.)

OSTEOLOGY.

Of the skull.—The skull in both genera of Monotremata is long and depressed, but is characterized by a relatively larger cranium in proportion to the face than in the Marsupials. The parietes of the expanded cerebral cavity are rounded, and their outer surface is smooth. These characters are most conspicuous in the *Echidna*, in which the jaws are slender, elongated, and gradually diminish forwards to an

obtuse point, so that the whole skull resembles the half of a pear split lengthwise. The facial angle of the *Echidna* is 36° , that of the *Ornithorhynchus* 20° , being almost the lowest in the mammiferous class. The cranial bones and their constituent pieces continue longer distinct in the *Echidna* than in the *Ornithorhynchus*; and their relative position, their con-

* *Tableau Elementaire de l'Histoire Nat.* 1797.

† See his beautiful Monograph, "*Ornithorhynchi Paradoxi Descriptio Anatomica*," folio, 1826.

* See Linn. Trans. xiii. p. 621.

nections, and the proportions in which they enter into the formation of the skull, have been in great measure determined and described in that genus.*

I have had the opportunity of investigating the composition of the cranium, a point so important in regard to the natural affinities of the Monotremata, in the young Ornithorhynchi transmitted to the Zoological Society of London by Dr. Weatherhead; and the comparison of this part of their anatomy has enabled me

better to appreciate and understand peculiarities of the same part in the Echidna, the skull of which is here also described from original specimens.

In the cranium of a young but full-grown specimen of *Echidna setosa*, (g, fig. 169, 170, 171,) the four elements of the occipital bone are unanched and are joined together by smooth linear harmonia. The basi-occipital (fig. 170, a) presents a six-sided rhomboidal figure, with the posterior margin notched to complete the lower

Fig. 169.

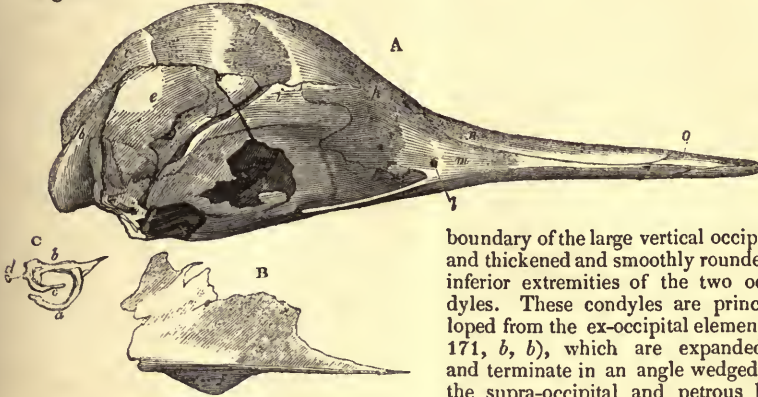

Skull of *Echidna setosa*. (Original.)

Fig. 170.



Occipital and sphenoidal cranial vertebrae, *Echidna setosa*. (Original.)

boundary of the large vertical occipital foramen, and thickened and smoothly rounded to form the inferior extremities of the two occipital condyles. These condyles are principally developed from the ex-occipital elements (figs. 169, 171, b, b), which are expanded superiorly and terminate in an angle wedged in between the supra-occipital and petrous bones; they extend, but do not meet, above the occipital foramen, being separated by a notch closed by membrane in the recent state. The supra-occipital element (figs. 169 & 171, c) is a transversely oblong quadrilateral plate of bone; its short lateral margin is joined by a linear harmonia with the upper part of the os petrosum, on each side; the wide anterior margin is similarly articulated with the single parietal bone, and is slightly overlapped by its posterior margin; this representative of the deltoid suture runs straight across the posterior and upper part of the skull.

Fig. 171.

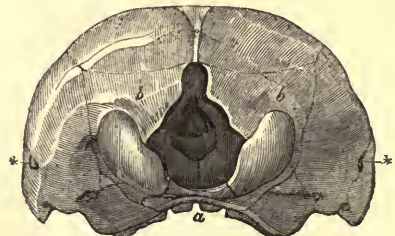

Occipital region of skull, *Echidna setosa*. (Original.)

In the specimen in which the preceding condition of the occipital vertebra was manifested there was no trace of sagittal suture; the upper and middle region of the cranium was covered by a single broad, slightly convex, parietal bone, (fig. 169, d,) joined posteriorly, as above described, with the supra-occipital, laterally with the petrous and sphenoid bones, and anteriorly with the sphenoid and frontal bones, which the parietal overlaps

* See *Leçons d'Anatomie Comparée*, Ed. 1837. VOL. III.

by a squamous modification of the coronal suture. The part described in this Article as a lamelliform portion of the petrous bone, (fig. 169, *e*), which extends upon the lateral and part of the posterior region of the skull, is regarded by the Editors* of the *Leçons d'Anatomie Comparée*, Ed. 1837, as the squamous portion of the temporal; and the flat oblong bone, (fig. 169, *B*), which forms part of the lateral wall of the cranial cavity and the posterior half of the zygomatic arch, and which supports the articular surface for the lower jaw, is thought to be the malar bone. But when we consider the low development or total disappearance of the malar bone in the skull of the *Insectivora* generally, as in *Echinops* and *Centetes* among the *Feræ*, and as in the edentate *Manis* and *Myrmecophaga*, it is unlikely that the malar bone should attain so superior a size and fulfil such important functions in the Monotrematous Edentata, in which its condition, according to the above views of the editors of the *Leçons d'Anat. Comparée*, would be unique in the mammiferous class. It appears to me to be more reasonable to regard the malar bone as either altogether absent in the Echidna, as it is in the *Manis*, and the zygomatic arch as being completed in the Echidna by a greater extension of the zygomatic processes of the temporal and superior maxillary bones; or else to suppose that these are actually united, at an earlier period, by a separate intervening jugal style, which, however, I have not been more successful in finding than the Continuator of Cuvier. With respect to the great development which the petrous bone, according to my view, must present in the Echidna, it may be observed that this bone forms part of the occipital region of the skull in most Marsupials, and also contributes as large a proportion to the lateral parietes of the skull in certain Rodents, as the *Helamys*, as it is here described to do in the Echidna.

The side of the cranium is principally formed by the largely developed *petrous bone* (fig. 170, *e*) and the great ala of the *sphenoid*, which meet and are joined in the interspace separating the parietal from the squamo-temporal bone, by a nearly vertical harmonia half an inch long; this harmonia is crossed at nearly right angles by a deep groove, which in some parts sinks through the wall of the cranium and exposes its cavity. The groove or canal first runs between the squamous and petrous elements of the temporal bone, and is a conspicuous feature in the skull of the *Ornithorhynchus*.

The lower part of the side of the skull of the Echidna is closed by the *squamous element of the temporal*, which overlaps a large portion of the petrous bone, and by a small portion of the sphenoid: it is represented detached from the skull at fig. 169, *B*. The lower boundary of the squamo-temporal forms a straight line, from which the glenoid surface for the lower jaw (*f*) is extended inwards at a right angle, upon the base of the skull; the anterior part

is continued forwards, protecting the temporal fossa by a thin vertical plate of bone, and then diminishes to a slender, straight, styliform, zygomatic process which rests obliquely on a corresponding process of the superior maxillary bone.

The tympanic cavity is shallow, and excavated in the basal part of the petrous bone, where it is widely open in the macerated skull: it is figured closed by the tympanic bone and membrane at *g*, fig. 170, and exposed by their removal at *e'* fig. 170. The plane of the *membrana tympani* is horizontal, and its external surface looks nearly downwards. Three-fourths of its circumference are implanted in the groove of the very slender incomplete hoop formed by the detached tympanic bone, which is figured with the ankylosed malleus at *c*, fig. 169. The petrous bone is continued from the tympanic fossa forwards and inwards, in the form of a broad and nearly horizontal process, (fig. 170, *e'*), to the pterygoid plate of the sphenoid, (*i', i'*) which is also horizontal. The petrous and pterygoid plates are joined by an oblique harmonia, and both contribute to extend the bony palate backwards. The palatal process of the petrous bone is abruptly terminated behind by the Eustachian groove (fig. 170*).

The *frontal bone* (fig. 169, *h*) in the cranium here described was divided by a median frontal suture, toothless like the rest; the angle between the superior and the orbital plates is rounded off; the orbital plate joins the great ala of the sphenoid by a deeply sinuous suture. The anterior part of the frontal is largely overlapped by the bases of the nasal bones, which encroach upon the interorbital space.

The *nasal bones* (fig. 169, *n*) receive the upper edge of the superior maxillary bone into a groove at their outer margin, and articulate anteriorly with the *intermaxillaries* (fig. 169, *o*); but these meet above the nasal canal in front of the nasal bones for an extent of about three lines, and thus exclusively form the boundary of the single, oval, and terminal external nostril. The lower or palatal process of the intermaxillary extends backwards in the form of a long and slender pointed process which is wedged into a fissure of the superior maxillary bone.

The anterior palatal or incisive foramen is a single large elongated fissure extending from the narrow anterior symphysis of the intermaxillaries backwards, for some distance, between the palatal processes of the maxillaries. At the back part of the bony palate a narrow fissure extends forwards between the pterygoid bones, and the intermediate extent of the bony palate is entire, or presents only a few minute perforations. The palatal bones, if originally distinct, soon become confluent with the maxillaries. There was no separate osseous style representing the malar bone between the zygomatic processes of the maxillary and temporal bones in the skull here described.*

The zygomatic process of the *superior mar-*

* The very able anatomists, M.M. Laurillard and Duvernoy.

* Cuvier says, "Entre ces deux apophyses est un très-petit filet qui represent le jugal." Cuvier, *Ossem. Foss.* 4to., vol. v., p. 145.

Fig. 173.

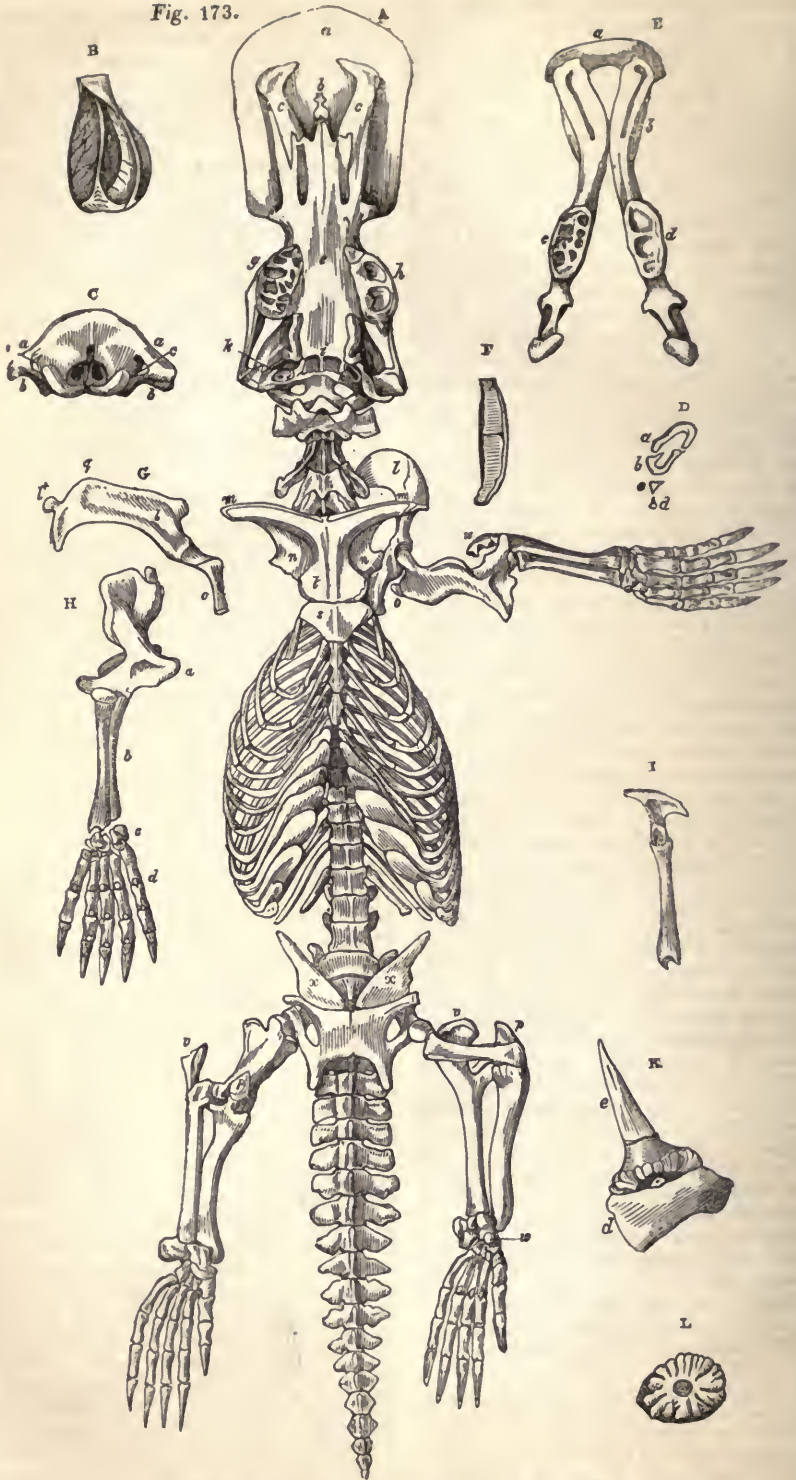

Skeleton of the Ornithorhynchus. (Mechel.).

petrous, but separated from the latter, at its lower half, by a fissure analogous to but wider than the canal which traverses the squamous union of the same bones in the Echidna. The base of the squamous plate is contracted but thickened to form the origin of the zygomatic process: it sends inwards a thin plate, concave externally, which forms the glenoid cavity for the lower jaw, and is applied against the basal part of the petrous bone. The glenoid plate is equal in size to the squamous process. They meet at a right angle, and, from the tubercle developed from their union, external to the glenoid cavity, the zygomatic process is continued forwards to join that which is sent off by the superior maxillary bone. I could not find any distinct malar bone in the young *Ornithorhynchus*. The same arguments against considering the squamous bone to be the malar apply to this Monotreme as have been used in reference to the Echidna.

The *parietal* bone (*fig. 172, d*) forms the chief part of the upper region of the skull; it is longer in proportion to its breadth than in the Echidna. Both the lambdoidal and coronal sutures are squamous, and the parietal overlaps the frontal bones. There is no trace of sagittal suture; the bony falx is developed from the line which that suture would occupy. The lateral connexions of the parietal differ from those in the Echidna by its union with the squamous portion of the temporal bone, as above-mentioned.

The *frontal* bones (*h, h*) are relatively smaller than even in the Echidna: they were divided by a suture in the specimen described. The form of their exposed surface is shown in *fig. 172, h, h*.

The side of the skull anterior to the petrous bone is formed by the great ala of the *sphenoid* (*fig. 172, i*), which is joined by a well-defined linear harmonia to the parietal bone.

The *Ornithorhynchus* differs from the Echidna in the large vacuities in the floor of the skull behind and in front of the tympanic cavity, the one representing the combined jugular and condyloid foramen, the other the oval foramen, between which the body of the sphenoid also presents two membranous spaces. The skull differs also in the larger size of the foramen rotundum, in the stronger zygomata, the more complete orbit, and the singular modification of the bones supporting the beak. The cranial cavity is proportionally smaller and shallower in the *Ornithorhynchus*. The sutures of the cranial bones are much sooner obliterated, and the whole upper and lateral parietes then consist of a thin continuous dense plate of bone without diploë.

The resemblance which the *Ornithorhynchus* offers in this respect to the class of Birds is noticed by Meckel.

The oblique canal, (*fig. 173, c, c*), which traverses the squamous suture between the petrous and squamous portions of the temporal in the Echidna, is so much shorter and wider in the *Ornithorhynchus* that it appears to detach from the side of the cranium a distinct

superior column or root (*fig. 173, c, a*) to the posterior commencement of the zygomatic arch. An analogous canal runs between the tympanic and mastoid bones in the skull of the Crocodile, and is dilated to great width in the Lizards; but the presence of a distinct tympanic bone in the usual position in the *Ornithorhynchus* nullifies the supposition that the upper root of the zygoma can be the analogue of the os quadratum in the Ovipara.

The articular surface for the lower jaw (*fig. 173, c, b*) is much more distinctly developed than in the Echidna; it occupies the base of the zygoma, is extended and concave transversely, narrower and slightly convex from before backwards: it is not defended by any posterior process. The zygoma is complete, and consists of a nearly vertical straight plate of bone, expanded at its anterior or maxillary extremity, where it sends upwards an angular process bounding the orbit posteriorly, and bends downwards to support the broad alveolus of the horny molar tooth (*fig. 173, a, g, h*). The orbits are small and directed obliquely upwards and outwards. The skull is more contracted between them than in the Echidna, but anterior to them it begins to expand, becomes flattened horizontally, then bifurcates, and the two depressed branches, after slightly diverging, terminate each by an inwardly inflected process, the extremities of which are half an inch apart. The space intercepted by the facial fork is the external bony nostril (*fig. 172, p*), which is thus left incomplete anteriorly. The forms and proportions in which the bones of the face enter into the formation of the external nasal aperture are illustrated in the figure of the cranium of the *Ornithorhynchus* given by Pander and D'Alton,* and I have verified the accuracy with which the sutures are there delineated. Cuvier† supposed the facial forks to be formed by the intermaxillary bones, and describes a small bone in the middle of their interspace (*fig. 172, p*) suspended in the cartilage of the upper mandible, and with an emargination on each side of its inferior plate, which he conjectured might represent the nasal bones and the palatine part of the intermaxillary bones. The true nasal bones (*fig. 172, n, n*) are, however, as shown by Pander and D'Alton, analogous in situation to and more largely developed than those of the Echidna. They commence each by an angular process, which overlaps the frontal, and extends into the inter-orbital space. They are continued forward of equal breadth, and have their anterior extremity obliquely truncated and terminated in a fine point, which extends to the middle of the inner side of the facial fork. The nasal bones thus form the posterior half of the boundary of the bony nostril. The superior maxillary bone (*fig. 172, m, m*), after sending off a process (*c*), which curves over the ant-orbital foramen, extends forwards

* Skelete der zahnlosen Thiere, 1825, (tab. ii. fig. a.)

† Leçons d'Anat. Comp. 1837, ii. p. 455.

in a pointed form along the outer side of the facial fork as far as the nasal does on the inner side, and an angular fissure is intercepted between the anterior extremities of these bones into which the pointed posterior part of the intermaxillary bone (*fig. 172, o, o*) is inserted. The anterior half of the facial fork with its inflected end is wholly formed by the intermaxillary bones, which thus bound the anterior half of the wide external nasal aperture. The small detached intermediate bone (*fig. 173, A, b*) may be regarded as a separate centre of ossification of the palatine process of the intermaxillaries, and of the middle stem which divides the anterior nostrils in birds and lizards.

The *vomer* forms a bony septum, dividing the whole extent of the nasal canal from the spine of the sphenoid forwards.

There is a small lachrymal foramen (*fig. 169, l*) at the anterior and inner part of the orbit in both the genera of Monotremes; a little lower down is the commencement of the ant-orbital canal. This canal branches in the *Echidna*, and terminates on the outer side of the maxillary bone by a succession of small foramina; but in the *Ornithorhynchus*, where it transmits a much larger sensitive nerve, it divides into three canals, of which one emerges beneath the uncinated process of the maxillary above mentioned; a second descends and opens upon the palate; and the third passes forwards into the substance of the facial fork, and terminates by a large foramen at the outside of the intermaxillary bone.

On the exterior of the cranium the ridges indicating the extent of the temporal muscles are clearly developed in the *Ornithorhynchus*, and correspond with the stronger zygomata and the more complete apparatus for mastication in this Monotreme. Four linear impressions upon the upper surface of the skull diverge from the middle of the lambdoidal ridge, and terminate at the temporal ridges. The occipital foramen (*fig. 173, c*) has a vertical plane, as in the *Echidna*, and has a similar rounded notch at its upper part.

The interior of the skull offers many unusual modifications. The sella turcica is elongated and narrow in both Monotremes; it is bounded by two very distinct lateral walls in the *Echidna*. The posterior clinoid processes are chiefly remarkable for their height in the *Ornithorhynchus*. The semicircular canals stand out in high relief in this species, as in Birds. In the *Echidna* the ethmoid encroaches upon the anterior part of the cranial cavity in the form of a large convex protuberance made by the posterior wall of the olfactory cavity, and a very extensive cribriform plate is developed. In the *Ornithorhynchus* the olfactory tract is comparatively small, in the form of a depression, and the nerve escapes by a single foramen at the anterior part of the ethmoidal plate. This is likewise an interesting mark of affinity to the bird and reptile; but the most remarkable and characteristic feature in the interior of the skull of the *Ornithorhynchus* is the bony falk (*fig. 173, n*). This is not present in the

Echidna. The tentorium is membranous in both Monotremes.

The lower jaw consists in the *Echidna* of two long and slender styloform rami without a symphyseal joint, but loosely connected together at their anterior extremities. An angular process divides the horizontal from the ascending ramus, which rises at an open angle and terminates in a small oblong convex condyle. A short obtuse coronoid process extends from the upper part of the horizontal ramus as far in advance of the angle as the condyle is behind it. The rest of the ramus is rounded like a rib, and diminishes to the anterior extremity. The dental canal commences below the coronoid process and divides in its progress, one branch terminating near the middle of the smooth alveolar border, the other close to the end of the ramus. In no Mammiferous animal does the lower jaw bear so small a proportion to the skull or to the rest of the skeleton as in the *Echidna*.

In the *Ornithorhynchus* the lower jaw is much more developed (*fig. 173, E*). Each ramus commences posteriorly by a large sub-hemispherical condyle, the convexity of which, so characteristic of the Mammalian class, is strongly marked. The ascending ramus is nearly horizontal, flattened below, and continued upwards in the form of a low vertical compressed plate, on each side of which there is a deep fossa. The ascending is continued by a gentle curve into the horizontal ramus, and the angle of the jaw is very feebly indicated. The horizontal ramus suddenly expands and sends off above in the same transverse line two short obtuse processes, both of which might be termed 'coronoid;' this structure is peculiar to the *Ornithorhynchus*. The innermost process (*c*), although the largest, is the superadded structure, as it affords insertion to the internal pterygoid. About two lines anterior to these processes the upper border of the horizontal ramus expands to form the shallow oblong alveolus (*e*) for the horny grinder. Its floor is perforated by several large foramina. The dental canal divides; one branch opens by a wide elliptical foramen on the outside of the ramus immediately anterior to the alveolus, the other terminates at the lower part of the end of the ramus. The rami of the jaw converge and are united at a symphysis of more than half an inch in length; there they become expanded and flattened, then again disunite, and are continued forwards as two spatulate processes (*b*), which diverge from each other to their broad rounded terminations, and are situated just behind the inflected extremities of the similarly separated inter-maxillaries (*fig. 173, A, c, c*). On the outer sides of the upper surface of the broad symphysis are the long and narrow sockets of the two anterior trenchant horny teeth. The Monotremes differ from the Marsupials in the absence of the inflected process developed from the angle of the lower jaw.

Of the vertebral column.—Both Monotremes have twenty-six true vertebrae, of which the seven first are cervical. In the *Echidna* sixteen, and in the *Ornithorhynchus* seventeen, of the

following vertebræ support long and functional ribs, so that there are three lumbar vertebræ in the Echidna, and but two in the Ornithorhynchus, which thus resembles the Lizards in the great proportion of the trunk which is encompassed by the costal arches. Another approximation to the Oviparous type is made by the long-continued separate state of the short cervical ribs in both Monotremes: these in a young but nearly full-grown Echidna are detached from all the cervical vertebræ except the atlas. The vertebral end of the cervical rib is bifurcated; the lower branch, representing the head, is articulated to the transverse process or tubercle developed from the body of the vertebra; the upper branch, representing the costal tubercle, is articulated to a transverse process developed from the side of the base of the neural arch. In the Ornithorhynchus the cervical ribs appear to become earlier ankylosed to the vertebræ, except as regards the axis, in which the broad costal appendage retains its original independence throughout life, and is slightly moveable upon the confluent extremities of the two transverse processes. In the succeeding vertebræ the space intercepted between the two transverse processes, the vertebra, and the costal rib, forms the so-called 'perforation of the transverse process' for the vertebral artery in human anatomy. In the Echidna, above alluded to, the 'neurapophyses' or vertebral plates of the atlas, which together form the neural or spinal arch, were unankylosed at their upper or spinal extremities. The atlas of the Ornithorhynchus is chiefly distinguished from that of the Echidna by the continuation, from the lower part of its slender body, of two long diverging processes which are developed in the strong tendons of the *recti capitis antici* muscles. The spine of the dentata is broad and high in both Monotremes; those of the other cervicals progressively diminish in size in the Ornithorhynchus, but become at once nearly obsolete in the Echidna. The transverse and spinous processes are of moderate size in the rest of the true vertebræ, but are largest in the lumbar region. The posterior oblique processes are single in these vertebræ. The articular surfaces of the vertebræ, which are slightly concave, are joined together by a thick circular band of ligamentous fibres (*fig. 174, a*) attached to the circumference of the articular surface, enclosing a central oblate spheroidal cavity (*b*) lined by a synovial membrane and filled with fluid.

The ribs are long and slender in the Ornithorhynchus, somewhat stronger in the Echidna. The first is flattened, the rest are cylindrical. Each rib is articulated by a single joint, uniting the head to the vertebral interspace, or to the side of the cen-

trum, as in the two last pairs: the tubercle, though small, is distinctly developed, and defines the neck of the rib, although it does not join the transverse process of the vertebra.

Meckel's statement, 'tuberculum adest nullum,' is applicable only to the last three or four pairs of ribs. The first six pairs are joined to the sternum in both the Ornithorhynchus and the Echidna. Six pairs of ossified sternal ribs (hæmapophyses*) are articulated to the sternum in the Echidna; the first four are nearly straight and sub-cylindrical; the fifth and sixth are expanded. Five pairs of ossified sternal ribs are present in the Ornithorhynchus, to which the second to the sixth vertebral ribs inclusive are joined by shorter intervening cartilaginous pieces of a similar form. The first rib in the Ornithorhynchus is joined to the sternum by cartilage alone. The interposed cartilages, which thus form a third element in the costal arch, repeat a structure common in crocodiles, and may be regarded as the homologues of the costal appendages in the ribs of birds, which in this class are removed from the interspace of the vertebral and sternal rib, and articulated to the vertebral piece.

The cartilages of the false ribs in both genera are singularly expanded and flattened, and present an imbricated arrangement, gliding upon each other with a slight yielding motion: the last vertebral rib, which is the shortest and straightest, is terminated by a short free cartilage. Many bone-corpuscles are scattered through these cartilages.

The ordinary *sternum*, to which the true ribs articulate, consists of four ossicles, and in the Echidna a fifth is developed in the base of the ensiform cartilage; the most anterior of these ossicles (*fig. 173, A, s*) has the usual expanded hexagonal form and large proportions of the manubrium sterni, and receives, besides the first and part of the second pair of ribs, the extremities also of the coracoid bones. The ensiform cartilage in the Echidna presents an elongated oval form with a central perforation. A large T-shaped episternal bone (*fig. 173, A, t*) is articulated to the anterior surface of the manubrium sterni; it is the key-bone of the complicated scapular arch.

The *sacrum* consists in the Ornithorhynchus, as in most Saurians, of two vertebræ, distinguished by the greater breadth and thickness of their transverse costal processes. In the Echidna there are three sacral vertebræ.

There are thirteen caudal vertebræ in the Echidna (*fig. 168*). The first is the largest, with broad transverse processes, the rest progressively diminishing, and reduced, in the six last, to the central element. The Ornithorhynchus (*fig. 173, A*) has twenty-one caudal vertebræ, of which all but the last two have

Fig. 174.



Intervertebral cavities, Echidna. (Original.)

* In the complete vertebræ which encompass the centre of the vascular system, the hæmapophyses or halves of the chevron-bone, or inferior vertebral laminae, are retained, together with the inferior or hæmal spine. The series, sometimes ankylosed, as in Man, of these spines forms the 'sternum'; the inferior laminae or hæmapophyses are the sternal ribs.

transverse processes, and the first eleven have also spinous and articular processes. The transverse processes are broad and depressed; they gradually increase in length to the tenth caudal, then as gradually diminish to the twentieth; their extremities are expanded, and, from the fifth backwards, are thickened and tuberculate. The spinous processes progressively diminish in height from the first caudal. The first six caudal vertebrae have both posterior and anterior oblique processes, and are joined together both by these and by the articular surfaces of the body: the anterior articular processes are present, but progressively diminish in size from the seventh to the sixteenth vertebrae, and are not subservient to their reciprocal articulation. Inferior spinous processes are developed from the bodies of the third to the nineteenth caudal vertebra inclusive; but there are no hæmapophyses articulated to the vertebral interspaces, as in many Marsupials and the Edentata. In the Echidna the inferior spinous processes are absent; but rudiments of hæmapophyses are connected with the interspaces of one or two of the middle vertebrae of the tail. The caudal vertebrae in the Ornithorhynchus are of nearly the same length to the two last; they progressively diminish in vertical diameter as they recede from the trunk, and are chiefly remarkable for their breadth and flatness; resembling in this respect, as Cuvier has observed, the caudal vertebrae of the Beaver, and we might add those of the Cetacea; the horizontally extended tail having a similar relation to the frequent need which an aquatic animal with hot blood and a quick respiration of air has to ascend rapidly to the surface of the water.

Of the pectoral extremities.—Cuvier* justly observes that the most remarkable part of the osteology of the Monotremes is the organization of the shoulder; which corresponds with that of birds, and still more with that of lizards.

Had these anomalous Mammals been extinct, and their fossilized skeleton alone, as in the Ichthyosauri, been preserved for the contemplation of the naturalist, the perplexity which the combination of this structure with the mammalian conditions of the skull and vertebrae would have occasioned may be readily conceived.

The scapula (*l*) is represented detached, with the coracoid (*o*), at *o*, *fig.* 173; *l** is the cartilage appended to the short convex base. The scapula is long, narrower than in most Mammalia, and has its posterior vertebral angle so much produced, as to give it a resemblance to the scapula of the bird and saurian: this resemblance is farther increased by the origin of the spine close to the anterior costa, and by the spine being bent forwards so as to seem to form a continuation of the external surface of the scapula, which is thus rendered concave in the Ornithorhynchus.

The spine, however, terminates in a freely projecting acromion.

The true anterior costa is, in this Monotreme, represented by a ridge which traverses obliquely the inner and convex side of the scapula, from the anterior vertebral angle to the neck of the bone. In the Echidna this ridge is nearly obsolete, and the spine of the scapula is bent so as to form a more direct continuation of body of the scapula with the plane of which it is nearly parallel: the acromial termination is slightly twisted.

Both Cuvier and Meckel describe the spinous process of the scapula as the anterior margin, (superior costa in human anatomy,) and consequently consider the spine of the scapula as being absent. Cuvier says, "Le bord antérieure descend presque droit jusqu'à l'endroit où il se courbe en dedans pour former une apophyse, qui porte la fourchette." Meckel recognises this process as the acromion: "Margo anterior partis superioris versus inferiora extorsum primo flexus, dein eminentiam, acromion, antorsum et introrsum versam, emittit." The 'margo anterior' of Meckel, 'bord antérieure' of Cuvier, is, in fact, the true spine of the scapula, and the true 'margo anterior' is the ridge above described. The proof of this is afforded by the origin of the supra-spinatus muscle which occupies the space between Meckel's 'margo anterior' and the ridge which I regard as the true anterior costa, and which is not noticed by either of the anatomists above quoted.

Since the scapula is peculiarly characterized in Mammalia by the presence of a spine and in Ovipara by its absence, its recognition in the Monotremes, under the modification by which its apparent absence is occasioned, and the transition to the oviparous type of this bone is effected, becomes a subject of especial interest.

The whole scapula is broader, thicker, and less curved in the Echidna than in the Ornithorhynchus. In both Monotremes, the posterior margin or costa is concave, most so in the *Ornithorhynchus*, and in both it is turned towards the trunk, so that the sub-scapular surface looks obliquely forwards and inwards. The articular surface is divided into two facets: the one, internal and flat, articulates with the coracoid; the other, external, is slightly concave, and contributes, with a similar but narrower concave surface of the coracoid, to form the glenoid cavity for the humerus.

The coracoid (*fig.* 173, *g, o*) early coalesces with the scapula in the Ornithorhynchus; it maintains its independent condition to a later period in the Echidna. In both it is a strong, subcompressed, subelongate bone, expanded at both ends; one of these is articulated and ankylosed with the scapula, as above described; the other is joined to the anterior and external facet of the manubrium sterni. The posterior margin of the coracoid is concave and free; the anterior margin is straight and articulated with a thin broad irregularly quadrilateral plate of bone in the Ornithorhynchus, and a thicker and nar-

* Ossem. Foss. v. pt. 1, p. 146.

rower corresponding bone in the Echidna. These bones, which are called the 'epicoracoids' (fig. 173, *Δ, n n*) are joined by their median margin to the stem of the episternal, and by their anterior margins to its transverse branches, which are overlapped by the epicoracoids.

The true or acromial *clavicle* (fig. 173, *Δ, m m*) is a long, slender, compressed, slightly bent bone, continued from the articular cavity at the end of the acromion to near the median line of the episternum, anterior to but parallel and in contact with the branches of the episternum, with which the clavicles finally coalesce, but at an earlier period in the Ornithorhynchus than in the Echidna. These clavicles are the homologues of the os furcatorium in the bird: the T-shaped episternum (fig. 173, *Δ, t*) is feebly represented in birds by the median process continued forwards between the coracoid articular cavities from the fore part of the sternum. It is in Lizards, and especially in the extinct Ichthyosaur, that the episternum presents the same form, development, and relation to the clavicles, as in the Monotremes. The epicoracoids again are wanting in the bird, but they are present in lizards, and the remarkable breadth of the coracoid in the Enaliosauria is due to their presence, although, singularly enough, they are ankylosed to the coracoids in these extinct reptiles, while in the warm-blooded Monotremes they remain separate. In the Echidna they are articulated with the coracoid by a true synovial joint. To render the resemblance between the Monotreme and the Bird complete, in respect of the structure of the scapular arch, the episternum must be reduced to a short and simple process attached to the anterior part of the manubrium sterni, the epicoracoids must be removed, and the clavicles ankylosed together at their mesial extremities.*

The *humerus* is a short and strong bone, expanded at both extremities, and, as it were, twisted half round upon itself. The proximal expansion terminates by a broad thick convex border, the middle part of which is developed into the articular head, which is so adapted to the glenoid cavity, that the bone is maintained in a horizontal position, and the distal expansion is nearly vertical. The deltoid and pectoral crests are strongly developed; both condyles are remarkably produced, especially the internal one, which is perforated. (Fig. 173, *u, a*.) The distal articular surface scarcely occupies a fourth part of that broad termination of the humerus: it presents, in the Echidna (fig. 168), a convex tubercle, which is broadest in front, for the articulation of the radius, narrow behind, for that of the ulna. The articular surfaces of both anti-brachial bones are concave: so that the elbow-joint admits freely of flexion and extension, abduction and adduction, but is restricted in the movement of rotation.

* For a full and elaborate discussion of the various opinions which have been offered respecting the homology or signification of the complicated apparatus of the shoulder in the Ornithorhynchus, the reader is referred to Meckel, 'De Ornithorhynchus,' &c. pp. 12-15.

The *radius* and *ulna* are in contact and pretty firmly connected together through nearly their whole extent; the interosseous space being reduced to a slight fissure. The *ulna* is chiefly remarkable for the olecranon, (fig. 173, *Δ, u*), which is bent forwards upon the humerus, and transversely expanded at its extremity, especially in the Ornithorhynchus, in which the lower or inner angle of the expanded extremity is considerably produced. The shaft of the ulna is compressed, and increases in breadth, in the Echidna, as it approaches the broad carpus. In the Ornithorhynchus it is bent like the italic *f*, is more cylindrical, and more suddenly expanded at the distal end. The *radius* offers little worthy of notice, except that in the Ornithorhynchus it is flattened next the ulna, and so applied to that bone as to prevent altogether a rotation of the hand upon the ulna. In the Echidna the distal articular surface of the ulna (fig. 175, *n*) presents two convex trochleæ separated by a median concavity; that of the radius (fig. 175, *r*) offers a reverse condition: here two concavities are divided by a median convex ridge; all the four facets at the carpal joint of the antibrachium are in the same transverse line. The two radial concavities receive the two articular convexities of the broad scapho-lunar bone (fig. 176, *a*): the two convex trochleæ of the ulna play upon two concavities, one-half of each of which is contributed by the cuneiform (fig. 176, *b*) and pisiform bones (*c*). This complicated joint limits the movement of the hand upon the fore-arm to flexion and extension.

Fig. 175.



Bones of fore-foot, palmar aspect, *Echidna setosa*. (Original.)

Notwithstanding the confluence of the scaphoid with the lunar bone in the *carpus* of the Echidna, as in that of the Marsupials and Carnivora, it includes eight ossicles, a small sesamoid bone (fig. 176, *) being developed in the tendon of the flexor carpi radialis, and articulated with the scapho-lunar bone and radius. The distal series of the carpus includes the four normal bones, the trapezium (fig. 176, *h*)

supporting the innermost digit or pollex, the trapezoides (*g*), the index, the os magnum (*j*), which is almost the smallest, sustaining the medius, and the unciniforme (*e*) the two outer digits: this description is taken from the Echidna: the only essential difference observable in the Ornithorhynchus is the contribution by the os magnum of a greater share to the articulation with the ring-finger.

In the Echidna all the bones of the fore-extremity are relatively larger and stronger than in the Ornithorhynchus, but this difference is especially remarkable in the metacarpal bones and two first rows of phalanges (*fig. 176, h, i, k*), which are singularly short, broad, and thick. The palm is strengthened by two large sesamoids developed in the flexor tendons in the Echidna; these are sometimes confluent (*fig. 175, l*). The number of phalanges in both Monotremes is the same as in other Mammals, viz. two to the thumb and three to each of the fingers. This is not the case in any Saurian, and the retention of the Mammalian type at the peripheral segment of the limb, with the singular deviation from it at the central supporting arch, is not one of the least remarkable points in the osteology of the Monotremes.

There is a sesamoid bone at the palmar aspect of each of the distal articulations of the phalanges in the Echidna (*fig. 175*), and at all the digital articulations in the Ornithorhynchus (*fig. 173, u, d*).

Fig. 176.

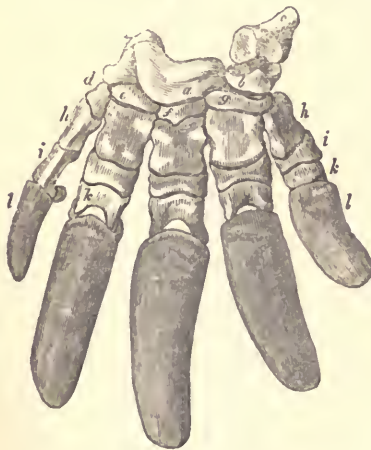

Bones of the fore-foot, Echidna hystrix.
(Cuvier.)

The ungual phalanges are long, depressed, nearly straight, of great strength in the Echidna, in which each of them is perforated at the palmar aspect (*fig. 175*).

Of the pelvic extremities.—The pelvis of the Monotremes bears a resemblance to that of Reptiles in the length of time during which the three components of each os innominatum remain distinct, especially in the Echidna; and in the great development of the ilio-pectineal spine, which equals in size that of the tortoise,

in the Ornithorhynchus; the pelvis of the Echidna resembles that of Birds in the perforation of the acetabulum (*fig. 177, g*), but the pelvis in both Monotremes chiefly resembles that of the higher implantal Mammalia in the presence of the marsupial bones.

Fig. 177.



Internal view of pelvis, Echidna setosa.
(Original)

The ilium (*fig. 177, a*) is a short, strong, trihedral bone, with the upper extremity expanded and everted in the Ornithorhynchus. The ischium (*b*) has its tuberosity prolonged backwards in an obtusely-pointed form in the Ornithorhynchus. The pubis in the same animal, besides having the spinous process directed forwards, gives off a second smaller process, which projects outwards; this process is present, but less developed in the Echidna (*fig. 177, f*). The pubis (*c*) and ischium contribute an equal share to the formation of the foramen obturatorium (*h*) and to the symphysis which closes the pelvis below: the symphysis is relatively shorter in the Echidna (*d*) than in the Ornithorhynchus.

The marsupial bones (*fig. 173, a, x, x, 177, e*) are relatively larger and stronger in the Monotremes than in the ordinary Marsupialia, the Koala excepted; their base extends along the anterior margin of the pubis from the symphysis outwards to that of the spinous process (*fig. 177, f*); they are relatively longer in the Echidna (*e*) than in the Ornithorhynchus; they always remain moveably articulated with the brim of the pelvis.

The femur is short, broad, and flattened; its head rises, like that of the humerus, from the middle of a broad expanded proximal end, having on each side a strong process, the outer one representing the great, the inner one the small trochanter. In the Echidna a projecting ridge extends from the great or outer trochanter beyond the middle of the bone; the whole of the inner part of the shaft is bounded by a trenchant edge; both outer and inner margins of the bone are trenchant in the Ornithorhynchus. The distal end of the femur is expanded transversely, but compressed from before backwards. The rotular trochlea is flat

transversely, convex vertically, in the Echidna; it is hardly definable when the cartilage is separated from the bone; but the *patella* itself is well developed, and ossified in both Monotremes (*fig. 173, A, p*).

The *tibia* is straight in the Echidna, but bent, with the convexity next the fibula, in the Ornithorhynchus; its *cristæ* are slightly marked.

The *fibula* is slightly bent in the Echidna, but is straight in the Ornithorhynchus; in both Monotremes it is longer than the tibia by the extent of a process which rises upwards beyond the proximal articulation of the fibula, and most strongly expresses the analogy of this bone with the *ulna*: this process (*fig. 173, A, v*) reaches half way up the back of the femur in the Ornithorhynchus, and, like the olecranon, is greatly expanded at its termination. Cuvier* indicates the resemblance of this structure in the Monotremes with the fibula and the supernumerary bone imposed upon its enlarged proximal end in the pedimanous Marsupials.

The *tarsus* (*figs. 178, 179*) consists of a scaphoid (*a*), astragalus (*b*), a calcaneum (*c*), three cuneiform bones (*d, e, f*), and a cuboid (*g*) in the Echidna; but the cuboid in the Ornitho-

and forwards, nearly in a line with the digits (*fig. 179, e*).

The astragalus in the Ornithorhynchus presents a double trochlea above for the tibia and fibula, and a depression on its inner side, which receives the incurved malleolus of the tibia, almost as in the Sloths. The toes have the same number of bones as in other Mammalia; their size and form are more alike in the two Monotrematous genera than those of the fingers: the ungual phalanges, like the claws they support, are more curved than those on the fore foot, but like them they are perforated on their inner and concave side (*fig. 179*).

Fig. 179.



Bones of hind-foot, plantar aspect, *Echidna setosa*. (Original.)

Fig. 178.

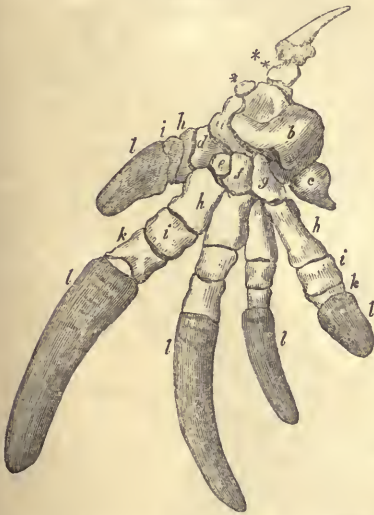

Bones of hind-foot, *Echidna hystrix*. (Cuvier.)

rhynchus is divided into two bones, as in some Reptiles, one for the fourth and the other for the fifth metatarsal bones. In both Monotremes there is a sesamoid bone (*fig. 178, **) placed at the interspace between the astragalus and the navicular; a second supernumerary bone (***) is articulated to the posterior part of the astragalus, and supports the perforated spur which characterizes the male sex (*fig. 173, k, d*).

The calcaneum of the Ornithorhynchus terminates by sending outwards a short obtuse tuberosity; in the Echidna this part is more slender, and is singularly directed inwards

OF THE MUSCULAR SYSTEM.

The figure (180) here given from Meckel* illustrates some of the most instructive peculiarities of the muscular system of the Ornithorhynchus. The animal is dissected from the ventral surface; the great cutaneous muscle, the 'panniculus carnosus' (1), is reflected from the right side, and the deeper-seated muscles are shown on the left. The panniculus carnosus, which is remarkable for its thickness, encompasses nearly the whole body, adhering most firmly to the external skin, but separated from the subjacent muscles, especially where it covers the thorax, abdomen, the arm, and the thigh, by a copious and lax cellular tissue; and in the female, at the abdominal region, by the mammary glands. The fibres are chiefly longitudinal, but at the lower part of the neck become transverse. The obtuse posterior end of the muscle is attached by three or four fasciculi to the dorsal aspect of the transverse processes of the caudal vertebræ. The legs and the arms protrude through oblique apertures in this muscular tunic; some of the anterior fasciculi are inserted by a short tendon into the pectoral ridge of the humerus; and others, still more anterior, are attached to the cranium, the lower jaw, and lower lip. A strip of fibres, which is cut off at 1*, is attached to the os hyoides; another fasciculus (1') spreads over the cheek-pouch, and assists in emptying that receptacle of the food.

The *trapezius* (9) is divided into two muscles; the posterior portion is an oblong slender triangle arising by a broad tendon from the tenth and eleventh vertebræ and ribs, and inserted by a short strong tendon in the anterior extremity of the spine of the scapula; the anterior portion is shorter, but broader, and is subquadrangular; it arises from the occiput and tendinous raphé

* Ossem. Foss. v. pt. i. p. 153.

* De Ornithorhyncho, &c. tab. v.

connecting it with its fellow of the opposite side (called 'ligamentum nuchæ' by Meckel), and is inserted into the spine ('margo anterior scapulæ,' Meckel) and acromion process of the scapula, and into the outer half of the clavicle.

The *latissimus dorsi*, a very long and broad muscle, arises from the spines of all the dorsal and lumbar vertebræ, and from the eleven posterior ribs; it is inserted by a broad and strong tendon into the distal half of the ulnar margin of the humerus. At its anterior part this muscle may be separated into a superficial and deep stratum.

The *rhomboideus* is a single muscle, but thick and long, extending from the occiput to the narrow base of the scapula.

The *splenius* is united by an intermediate tendon with the opposite muscle, and is inserted into the mastoid process.

The *biventer cervicis* and the *complexus* are distinct throughout their whole course, which extends from the anterior dorsal and posterior cervical spines to the occiput; the *complexus* is the longest and thickest muscle, and divides into an external, shorter, and deeper-seated portion, and an internal, longer, and superficial portion.

The *sacrolumbalis* arises from the dorsal extremity of the ilium, is attached to the ribs, over which it passes in its course to its insertion into the transverse processes of the four or five posterior cervical vertebræ.

The *longissimus dorsi* is a much thicker and narrower muscle, and extends from the dorsal aspect of the sacrum along the spine to the third or fourth cervical vertebræ.

Fig. 180.

Muscular system, ventral aspect. *Ornithorhynchus paradoxus*. (Meckel.)

The *transversalis cervicis* and *trachelo-mastoideus* are blended into a single oblong muscle arising from the anterior dorsal and the transverse processes of the six lower cervical vertebræ, and inserted into the mastoid process.

The *sterno-mastoid* is a double muscle on both sides, one portion being superficial (8), the other deep-seated; each arises separately from the episternal bone, and is separately inserted into the mastoid tubercle, behind the tympanic cavity. The *omo-hyoideus* and *mylo-hyoideus* (10, 10) have a common insertion into the os hyoides. A muscle (1ⁿ), arising from the hyoid bone and expanding to be inserted into the lower lip, serves to retract this part. The *sterno-hyoideus* (11) joins the hyo-glossus. The *genio-hyoideus* (12) and the *stylo-hyoideus* (13) have the normal relations: the *biventer maxillæ* (14) is a short thick muscle, inserted near the bend, representing the angle, of the jaw.

The caudal muscles are powerfully developed. The oblique fibres of the inferior or deflector muscles are shown at 53; they are removed on the other side to expose the anterior caudal nerves (i). The *obliquus externus abdominis* (3, 3) arises from all the vertebral ribs, except the first, and from the dilated extremity of the ilium; it is inserted by a strong tendon into the outer extremity of the marsupial bone (vi), then expands into an aponeurosis which is attached to the internal margin and base of the marsupial bone, and into the symphysis pubis, decussating with the tendinous fibres of the opposite muscle.

The *obliquus internus* (6) arises from the anterior part of the ilium, expands, and is inserted into the broad cartilages of the seven posterior ribs (v, v).

The *transversus abdominis* (7) is a thicker muscle, and arises from both the ilium and the transverse processes of the lumbar vertebræ; its tendon passes behind the recti to blend with that of the opposite muscle, and with the aponeurosis of the *obliqui externi*, in the linea alba.

The *pyramidalis*, or superficial rectus (4), is here, as in the ordinary Marsupials, of very large size; it arises from the whole inner margin of the marsupial bone; its fibres converge towards and are confluent at the linea alba with those of its fellow, and it gradually terminates in a point opposite the posterior part of the sternum. It depresses the ribs, shortens the abdomen, and protracts the marsupial bone.

The *rectus abdominis*, or posterior rectus (5), arises from the posterior margin of the marsupial bone, and is inserted into the cartilage of the first rib, the manubrium sterni, and the coracoid bone.

The *diaphragm* presents the structure which is characteristic of the true mammiferous animal. The lesser muscle arises from the first lumbar and four last dorsal vertebræ, and expands to be inserted into the central tendon, which chiefly receives the fibres of the greater muscle arising from the cartilages of the eleven inferior pairs of ribs.

The *pectoralis* (2) is of very striking dimen-

sions; the origin of the superficial portion extends from the acromion, along the sternum and linea alba, almost to the pubis; a deeper-seated portion arises from the six osseous sternal ribs; the fibres of both portions converge to be inserted into the largely-developed pectoral or anterior crest of the proximal half of the humerus.

The *pectoralis minor* is attached to the coracoid, and the *subclavius* is likewise inserted, as in some other quadrupeds, into this bone, which is no longer a subordinate process of the scapula in the Monotremes.

The *subscapularis* is a narrow muscle, and narrower in reality than at first sight it appears to be, since the *supra-spinatus*, from the inflection of the spine and acromion, arises from the same aspect of the scapula, and appears to form the anterior fasciculus of the *subscapularis*; its distinct insertion into the anterior tubercle of the head of the humerus points out its true nature.

The *infra-spinatus* (20) and the large *teres major* cover the whole external surface of the scapula.

The *deltoid* is divided into an anterior and a posterior portion. The anterior portion (19) arises from the anterior extremity of the coracoid, and is inserted into the summit of the deltoid crest of the humerus: the posterior part (21) arises from the anterior and superior apex of the scapula, and is inserted into the lower half of the deltoid crest. There are also two muscles to which the name *coracobrachialis* may be applied, a superior one (22) and an inferior one (25).

The *biceps brachii* arises by two heads; one (23) arises from the sternal extremity of the coracoid, the other (24) also arises from the coracoid; the common tendon is inserted into the middle of the radius.

The other muscles of the anterior extremity adhere closely to the mammalian type. The *extensor carpi radialis* (30) sends three tendons, to be inserted respectively into the second, third, and fourth metacarpal bones. There is a single common *flexor digitorum*, as well as *extensor digitorum* (27).

The *extensor digiti minimi* (26), the *indicator* (28), the *extensor pollicis* (29), the *pronator teres* (32), and the *flexor carpi radialis* (33) are all remarkable for their strength in the Ornithorhynchus, and are still more powerfully developed in the Echinidna.

The most remarkable muscle on the palmar aspect of the fore arm is the *flexor carpi ulnaris*, which arises by two separate heads, the longer one from the broad olecranon, the shorter one from the internal condyle of the humerus; the common tendon is attached to the os pisiforme and the metacarpals of the fourth and fifth digits.

The *psaos minor* from its insertion into the pelvic arch should be regarded as a muscle of the pelvic extremity, and it is one of the largest of these muscles. It arises from the sides of five dorsal vertebræ, and its strong tendon is implanted in the remarkably-developed ilio-pitineal process. It depresses the pelvis,

and with it also the tail and the pelvic extremities.

The *psaos magnus* and *iliacus internus* form a single muscle, having the usual origins, and inserted by a common tendon into the large internal condyle.

The *gluteus externus* is larger than is usually the case with quadrupeds; its tendon is inserted into the plantar fascia and the bone which supports the spur. The *gluteus medius*, *gluteus internus*, *pectincus* (45), *biceps flexor cruris*, *gracilis* (34), *sartorius* (35), *rectus femoris* (36), *adductores femoris* (46), *semitendinosus* (47), *semimembranosus*, *vastus externus*, offer no notable deviations from the usual structure. A strip of fibres (49) descends from the gracilis to the *sphincter cloacæ* (H). A muscle, called by Meckel 'flexor accessorius a caudâ ad tibiam tendens' (51), arises from the transverse processes of the anterior caudal vertebræ, and converges to be inserted into the tibia. Another peculiar adductor of the leg, which might be termed 'intertibialis' (52), is attached by its extremities to both tibiæ; its fleshy belly passes across the sphincter cloacæ (H), and is connected with a strip of the panniculus carnosus (i).

The *gastrocnemius* (48) derives its largest origin from the produced and expanded head of the fibula, and its smaller belly from the internal femoral condyle; its tendon is implanted in the calcaneum. The analogy between the *gastrocnemius* and *ulnaris internus* is strikingly illustrated in the *Ornithorhynchus*.

The *soleus* arises from the head of the fibula and from a large proportion of the tibia; it is nowhere blended with the gastrocnemius, but is inserted by a thick and short tendon into the astragalus.

The *abductors* of the outer digits of both the hand and foot are well developed for the purpose of expanding the web which connects the toes.

In the figure the following muscles of the leg are shown, viz. 37, *tibialis anticus*, 38, *extensor hallucis longus*, 39, *peroneus longus*, 40, *peroneus brevis*, 41, *extensor digitorum communis profundus*, *brevi analogus*, 42, *extensor digitorum communis sublimis*, 43, a portion of the same muscle corresponding with the indicator of the fore leg, 44, *extensor digiti quinti accessorius*.

NERVOUS SYSTEM.

Brain.—In the male *Ornithorhynchus* Meckel found that the brain weighed two drachms, German weight (about four drachms avoirdupoise), and bore a proportion to the weight of the body as 1 to 130. It was inclosed by a pretty strong dura mater, of which the fold corresponding with the bony falx adhered but slightly to that process. The cerebrum weighed one drachm and a half, German; nearly the whole of its superficies was smooth; a few vascular impressions marked the side of the anterior lobe: its shape was triangular, depressed; the contracted anterior lobes forming the obtuse apex of the triangle: the posterior lobes are wide and cover the corpora bigemina. The surface of the cerebrum is smooth and unconvoluted (fig. 181).

Fig. 181.

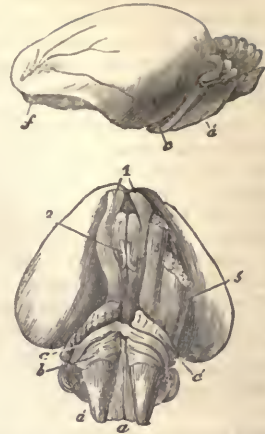

Side view and base of brain, *Ornithorhynchus*.
(Meckel.)

In describing the structure of the cerebral hemispheres Meckel observes, with reference to the most characteristic part of this structure in the Mammalia, "Corpus callosum adest quidem, sed breve, quam haud quatuor lines longitudine æquet, memorabilis etiam videtur, in dimidia duo lateralia, linea mediana haud confluentia, esse disjunctum. Equidem saltem in faciebus sese spectantibus internis nulum dilacerationis vestigium invenire potui."—L. c. p. 33.

During my investigations of the structure of the brain in the Marsupial animals,* I had in memory the apparent exception to the bird-like condition of the corpus callosum, which the *Ornithorhynchus*, according to the above description, presented, but which each successive example of the brain of the Marsupial quadruped served to establish more firmly as the rule of structure in the higher order of the Implacental sub-class. It was difficult to believe that in the lower or Monotrematous group, the cerebral organ, which indicates so accurately the true affinities and natural position of the Vertebrate animal, and which follows so faithfully the degradation of the general organization of each species, should offer so abrupt an ascent to the cerebral condition of the placental Mammalia, as would be indicated by a corpus callosum of four lines long in a brain of which the hemispheres measure only fourteen lines in length (German scale).

The strong suspicion of an error in the celebrated anatomist's description justified a reserve in acknowledging this exception until the opportunity of testing it by a dissection of a brain of a Monotrematous quadruped should have presented itself; and my doubts as to the great development of the corpus callosum of the *Ornithorhynchus* were further justified by the indication of its nearer approach to the Oviparous type afforded by the simple bipartite condition of the tubercles

* Philos. Trans. 1837, p. 87.

called 'quadrigemina.' Well preserved specimens of *Ornithorhynchus* presented to me by Mr. Thomas Bell, surgeon R. N., in 1838, have enabled me to determine this question. There is neither corpus callosum nor septum lucidum in the *Ornithorhynchus*.

The part described by Meckel as the corpus callosum corresponds with the fornix and hippocampal commissure, as it exists in the Marsupialia, excepting that the essential function of the fornix, as a longitudinal commissure, uniting the *hippocampus major* with the olfactory lobe of the same hemisphere, is more exclusively maintained in the *Ornithorhynchus*, in consequence of the smaller size of the transverse band of fibres uniting the opposite hippocampi, and representing the first rudiment of the corpus callosum, as it appears in the development of the placental embryo. The thin internal and superior parietes of one lateral ventricle are wholly unconnected with those of the opposite ventricle.

Meckel makes no mention of the fornix or hippocampus major: the latter forms a large pyramidal prominence at the outer and posterior part of the ventricle, and is confluent with the inferior and external parietes of that cavity. The corpus striatum is long and narrow: the thalamus opticus small, and is united with its fellow by a soft commissure, which rises to the same level, whereby they appear to form a continuous body. The anterior commissure is very large, as in the Marsupials. The posterior bigeminal body is much smaller than the anterior, and the transverse depression which divides them is very feebly marked: the longitudinal groove is equally feeble on the 'nates,' and is altogether absent in the 'testes,' which thus form a single small tubercle. It is in the condition of these parts, recognized, but too briefly noticed by Meckel, that the brain of the *Ornithorhynchus* deviates most essentially from the Marsupialia, and offers the most direct step in the descent to the Oviparous type.

The cerebellum is moderately large, highest in the middle, but with small lateral appendages: the median or vermiform part is traversed by transverse furrows; and its vertical section exhibits an 'arbor vitæ.'

The medulla oblongata is broad and depressed: its inferior surface exhibits the corpora pyramidalia (*fig. 181, a*), the corpora olivaria (*a'*), which expand as they advance forwards, apparently in relation to the immense size of the trigeminal nerve. Their anterior extremities are crossed by large trapezoid bodies (*b*), (figured by Meckel as the pons Varolii); and anterior to those is the true 'nodus cephalii' (*c*), which is narrow, in correspondence with the small lateral lobes of the cerebellum; and from this there emerges on each side a large ganglioid body (*c'*), from which the trigeminal nerve (*5*) arises. The under surface of the medulla oblongata is traversed by a deep median longitudinal groove.

The brain of the *Echidna* is relatively larger, and its external surface is complicated by

convolutions.* It weighs twelve drachms and thirty grains avoirdupoise, and bears a proportion to the weight of the body as 1 to 50. The cerebral hemispheres conceal the bigeminal bodies, but do not extend over the cerebellum. The broad posterior part of each hemisphere is disposed in three nearly parallel transverse convolutions, the outer extremities of which

Fig. 182.



Brain of the Echidna, right hemisphere dissected. (Original.)

incline forwards (*fig. 182*); anterior to these is a larger convolution bent upon itself at a right angle, one crus running transversely; the other longitudinally, and forming the inner boundary of the anterior half of each hemisphere: this convolution was not divided by a transverse anfractuosity, as in the figure in the 'Voyage de la Favorite,' loc. cit. On the outside of the longitudinal convolution there are two or three oblique folds which converge towards the contracted anterior part of the brain, or descend to its under surface: besides these principal and more constant convolutions there are a few smaller and less regular ones at the lateral and inferior parts of the hemispheres, especially on the great natiform protuberances. The principal anfractuositities sink more than a line's depth into the substance of the hemisphere: the posterior convolutions are continued upon the median surface of the hemisphere, and interlock with those of the corresponding hemisphere. The depth of the median fissure of the hemispheres is from five to six lines: the hippocampal commissure (*o*) one line and a half in antero-posterior diameter is seen at the bottom of the fissure which divides the hemispheres.

The dura mater in the *Echidna* is thin and

* See the figures and description of the external characters of the brain of the *Echidna*, given by M.M. Eydoux and Laurent in the 'Voyage de la Favorite,' 8vo. 1839, tom. v. pl. 9, p. 161.

transparent; the membranous falx is less deep than the osseous one of the Ornithorhynchus. I found no bony plate between the hemispheres in the Echidna. The arachnoid is transparent, but relatively strong. The cerebellum is traversed by several narrow transverse anfractuosités, disposed as in *fig. 182*. The vermiform or median lobe, as in the Ornithorhynchus, is larger in proportion to the lateral lobes than in the Marsupialia, and the limits between them are much less distinctly defined.

The base of the brain in the Echidna (*fig. 183*) is remarkable for the deep and wide excavations at the under part of the anterior

Fig. 183.

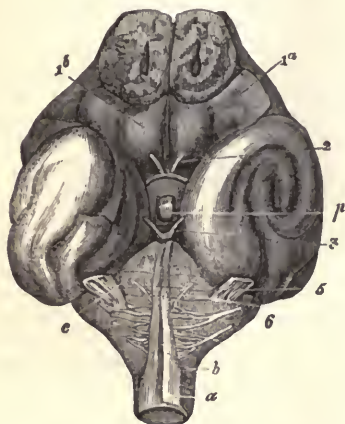

Base of brain of Echidna. (Original.)

lobes, forming the base of the enormous olfactory nerves. The natiform protuberances are unusually large. The medulla oblongata is broad and flat, but contracted anteriorly to an angle; the pyramidal bodies (*a*) long and narrow; the olivary bodies (*b*) broad, but flat. The pons Varolii (*c*) presents, as in the Ornithorhynchus, a low development proportionally to the size of the brain: it is not raised beyond the level of the under surface of the medulla oblongata: it is of a triangular form with the obtuse apex turned forwards: the median longitudinal groove formed by the basilar artery is well marked: the trapezoid bodies are relatively narrower than in the Ornithorhynchus.

The pituitary gland (*p*, *fig. 183*) is one line and a half in length and one line in breadth: its under surface adheres closely to the dura mater of the sella turcica. The corpus mam-

millare is single, broad, and but little elevated.

The internal, superior, and posterior walls of the lateral ventricle are from one line to two lines in thickness; the outer wall is between two and three lines; when the roof of the ventricle is removed, as in *fig. 184*, two elongated convex bodies are exposed, as in the marsupial brain: the posterior and largest (*h*) is the hippocampus major: the anterior body (*s*) is the corpus striatum. The whole internal wall of one ventricle is quite disunited from that of the opposite hemisphere.*

The contracted anterior parts of the hippocampi are connected together by the short transverse commissure above mentioned, which is the sole representative of the corpus callosum and fornix. The septum lucidum and fifth ventricle are entirely absent.

The pia mater, which accompanies the ventricular artery into the floor of the ventricle, at the base of the hippocampus, spreads over the optic thalami, and sends upwards a smooth fold of membrane, one line and a half broad, between the hippocampus and the corpus striatum. The free margin of this fold is slightly thickened by the choroid artery.

It is necessary to remove the hippocampus and posterior part of the hemisphere, in order to bring into view the optic thalami and bigeminal bodies.

The optic thalami (*fig. 182, l*) and nates appear as one convex body slightly contracted laterally, and divided from each other by a sigmoid linear fissure: the testes are only half the breadth of the nates, and the median longitudinal line of division, which is very faint in the larger bodies, is not visible in the smaller and posterior tubercle. The Echidna corresponds in this characteristic modification with the Ornithorhynchus.†

* The internal structure of the hemispheres of the Echidna's brain is not described in the "Voyage de la Favorite."

† MM. Eydoux and Laurent have thrown into the following tabular form the published results of the dissections of the brains of the Implantal Mammalia as compared with Placental Mammals and Birds.

Fig. 184.



Right lateral ventricle laid open, Echidna. (Original.)

	MONDELPHES.	DIDELPHES.	ORNITHODELPHES.	OISEAUX.
Corps calleux	existe.	manque.	manque.	manque.
Pont de Varole . . .	existe.	existe.	existe.	manque.
Lobes optiques . . .	quadrijumeaux et supérieures.	quadrijumeaux et supérieures.	bijumeaux et supérieures.	bijumeaux et lateraux.

They add: "En indiquant ce résultat des observations de M. R. Owen, aux-quelles nous avons

joint les observations de Meckel en les rectifiant, nous devons faire remarquer que Meckel a cepen-

The medullary fibres of the optic thalami (*fig.* 182, *t*) and bigeminal bodies (*r, s*) form a thin stratum above a third ventricle of unusual capacity, the relative size of which appeared somewhat larger than was natural from the decomposition of the medullary matter of the soft commissure. The principal commissure of the hemispheres is the anterior one, which is sub-cylindrical, and measured two lines thick vertically, and one and a half horizontally. The posterior commissure is a narrow strip of medullary matter, which thickens the upper part of the *valvula Vieussenii*. The 'iter' or canal from the third to the fourth ventricle is proportionally wide. The *arbor vitæ*, as displayed by a vertical section of the vermiform process, sends off four principal and some minor medullary branches.

The spinal chord in the *Ornithorhynchus* is long and slender, but fills closely the spinal canal: it is thickest at its commencement and at the lower two-thirds of the cervical region; it is more slender in the dorsal region, especially near the loins; it is slightly enlarged in the lumbar region, and gradually terminates in a point in the canal of the sacral vertebrae: the cauda equina is very feebly represented.

In the *Echidna* the form and proportions of the spinal chord (*fig.* 185) are strikingly different: it is here nearly as short and thick, relatively, as in the hedge-hog, and terminates in a point, at *d*, before it has reached the middle of the dorsal region. Nevertheless, in this short tract the two usual enlargements, giving origins respectively to the nerves of the pectoral and pelvic extremities, are clearly marked; the slightly contracted intermediate portion being extremely short: the cauda equina is remarkable for its length. The nerves escape, as usual, from the intervertebral foramina, and have a longer course in the spinal canal, in proportion as they supply parts more distant from the chord.

It is interesting to find the peculiar structure of so important a part as the spinal chord repeated in two species, which, with the exception of the dermal spines, and their common characters as *Mammalia*, differ in other respects as widely from one another, and occupy such distant places in their class. Can the shortness of the solid chord, and the great length of the nerves within the spinal canal, have any physiological relation with the habit, common to both the placental and monotrematous hedgehogs, of rolling the body into a ball when torpid or asleep, or when the tegumentary armour is employed in self-defence?*

The olfactory nerves are large in the *Ornithorhynchus* (*fig.* 181, 1, 1). The external root

dant admis, dans les figures relatives à l'encéphale de l'Ornithorhynque l'existence du corps calleux; mais, en étudiant avec soin l'encéphale de notre échidné, nous nous avons reconnu que les descriptions de M. R. Owen sont plus exactes que celles de Meckel, et que les déterminations de l'anatomiste Anglais doivent être adoptées." — *Voyage de la Favorite*, p. 166.

* "Cet échidné passait la majeure partie de son temps dans une espèce d'engourdissement, blotti, enroulé à la manière des hérissons." — *Voyage de la Favorite*, p. 159.

Fig. 185.

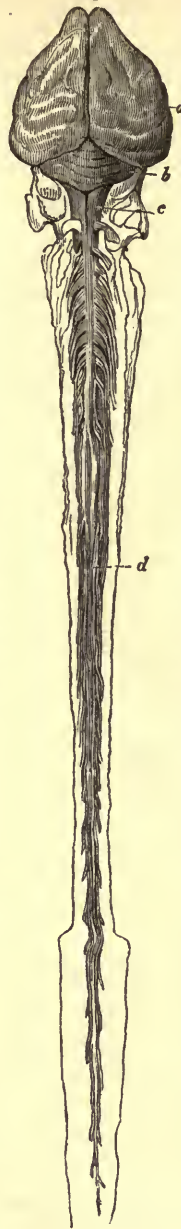

Brain and spinal chord, *Echidna*, Half natural size. (Original.)

is remarkable for its length and relative size: it arises from the posterior surface of the cerebral hemisphere immediately behind the bigeminal body; bends round the *crus cerebri* to the inferior surface; and is continued forward to join the internal root which rises from the base of the anterior lobes of the brain.

In the *Echidna* the olfactory nerves may be described as enormous. The external root (*fig.* 183, 1 *a*) arises from nearly the whole anterior part of the natiform protuberance, which extends its origin, as in the *Ornithorhynchus*, to the posterior part of the hemisphere. The internal root (183, 1 *b*) is also very large: the lateral ventricle is prolonged forwards into the olfactory nerve, which would appear like a continuation of the entire hemisphere, were it not that it is overlapped by the anterior convolution.

The extent and complications of the olfactory cavity are proportionate to the size of their respective nerves.

The optic nerve (*fig.* 181, 183, 2) is small in both *Monotremes*, in accordance with the diminutive size of the eye: the two nerves are joined by a transversely oblong chiasma.

The eye is protected, in the *Ornithorhynchus*, by a cartilaginous plate continued from the upper part of the orbit, which Meckel compares with the bony palpebral plates in the *Crocodile*. Both *Monotremes* have a well developed *membrana nictitans*: there are also an upper and a lower eyelid, each of which has its proper aperture muscle.

In the *Ornithorhynchus* the sclerotic is cartilaginous, the cornea flabby, the retina very thick: there is no trace of pecten or marsupium: the lens is very small, two lines in vertical and transverse diameter, one line in antero-posterior diameter; the anterior surface

is nearly flat, the posterior very convex. The choroid is black, without a tapetum lucidum: the pupil is circular.

The nerves of the third pair (*fig.* 183, 3) have the usual origin and destination, and are likewise very small: the fourth nerve is still more minute.

The fifth pair in the Ornithorhynchus exceeds, in relative magnitude, that of any other animal; though large, also, in the Echidna, its size is much less remarkable in this Monotreme.

The trigeminal nerve in the Ornithorhynchus, (*fig.* 181, 5,) emerging from the ganglion anterior to the pons, soon divides into three branches; the first and second appearing as one. The first and smallest division divides into two equal branches: the superior or ethmoidal branch enters the nose, emerges from a canal in the upper part of that cavity, and supplies the skin at the upper part of the face; and, by a branch continued from between the nasal and intermaxillary bones, is distributed to the nostrils and contiguous integument.

The second division of the fifth is two lines broad and one line and a half thick; it passes through the foramen rotundum, and the chief part of it passes into the ant-orbital canal. On its emergence it divides into two branches, distributed, the one to the nasal or upper parietes of the face, the other to the lateral or labial integuments. The palatine branch divides into a posterior smaller nerve, which passes through the posterior palatine foramina: the anterior and larger branch emerges from the anterior palatine canal and supplies Jacobson's organ and the surrounding palatine membrane.

The third division of the fifth (5') is broader but thinner than the second; it leaves the cranium by the foramen ovale, and is distributed as usual, in part to the manducatory muscles, but mainly to the sensitive labial integument of the lower jaw (*fig.* 180, *a a*).

The sixth nerve (*fig.* 183, 6) is as small as the third. The seventh and the acoustic present half a line in diameter.

The acoustic nerve is expended upon a labyrinth remarkable for the small relative size of the semicircular canals, and their free projection into the cavity of the cranium.

The cochlea is wide, but not high; it is bent around a modiolus, and divided as usual into a superior and inferior scala.

The foramen ovale is nearly circular, and opens into the wide but shallow tympanic cavity. It is naturally closed by the base of a small columelliform and imperforate stapes (*fig.* 173, *d, d*): the stem of this ossicle is articulated with a triangular plate of bone (*c*), representing, according to Meckel, the incus. This bone is connected with a small bent osseous style (*b*), which serves to complete, with the similarly-shaped tympanic ossicle (*a*), the frame supporting the membrana tympani. This membrane is concave externally, and forms the inner extremity of a long and narrow meatus auditorius externus, which is strengthened by a cartilaginous incomplete cylinder,

protected by a valve, but not provided with an external auricle.

The auricle is equally wanting in the Echidna, in which the external aperture of the auditory canal presents the form of a vertical slit, shaped like the italic *S*, one inch and a half in length: the margins of the slit are tumid, and support a row of bristles which protect and cover the orifice when recumbent. The meatus is remarkably long; the tube is strengthened in this Monotreme by a series of incomplete cartilaginous hoops, connected together by a narrow longitudinal cartilaginous band, so that its structure closely resembles that of a trachea (*fig.* 188, *a, a*). The tympanic fossa is almost entirely encircled with a slender hoop of bone (*fig.* 169, *c*) consisting of the anchylosed tympanic bone and malleus.

The portion which represents the tympanic bone (*a*), and which can be separated from the malleus in the young subject, is a slender osseous filament bent into three-fourths of a circle, and placed upon the inner margin of the tympanic fossa, its concavity looking outwards: this concavity is impressed with a fine groove for the insertion of the membrana tympani: the posterior part of the hoop passes across the commencement of the Eustachian canal, and terminates in a free point upon the posterior wall of the tympanic fossa: the anterior end of the hoop is applied to and usually anchylosed with the longitudinal bar of the malleus (*b*).

Only a small portion of this ossicle is contained within the cavity of the tympanum; the principal portion forms the external and part of the posterior boundary of the bony meatus auditorius, and is then continued forwards in the form of a slender pointed process; the bone slightly expands as it extends backwards, and its broadest part is abruptly bent inwards until it nearly meets the posterior end of the tympanic hoop. From the extremity of this inflected portion a slender compressed process (*c*) extends to the centre of the space encircled by the bony hoop; it is attached by its whole length to the membrana tympani, and represents the handle of the malleus. At the posterior margin of the broad incurved part of the malleus there are two minute tubercles nearly a line apart: the short and simple columelliform stapes (*d*) ascends vertically from the innermost of these tubercles, with the upper surface of which it is articulated; its opposite extremity closes the foramen ovale in the form of an expanded plate. The membrana tympani is concave outwardly at its middle part.

The eighth and ninth pairs of nerves have the usual origins and proportions. The pneumogastric nerve (*fig.* 180, *d*) is closely attached, at its origin, to the hypoglossal (*fig.* 180, *b*), but is quite distinct from the sympathetic (*fig.* 180, *f*): it gives off the superior laryngeal, and then proceeds along the neck to the chest: the right nerve here sends its recurrent branch, in the usual manner, round the arteria innominata; the left branch (*fig.* 187, *k*) winds round the aorta: the trunk of the pneumogastric is then expended in the

cardiac, pulmonic, œsophageal, and gastric nerves. The spinal accessory nerve (*fig. 180, c*) is thicker than the pneumogastric, and has the usual distribution.

The brachial plexus is formed by the five posterior cervical and the first dorsal nerves. The third cervical nerve is shown at *g, fig. 180*. The median nerve perforates the inner condyle of the humerus.

The lumbar plexus is formed by the two posterior dorsal, the two lumbar, and the first sacral nerve.

The great ischiadic nerve divides into the peroneal and tibial branches before it quits the pelvis. The crural nerve is shown at *h (fig. 180)*.

DIGESTIVE SYSTEM.

The Ornithorhynchus, which subsists on aquatic insects, larvæ, mollusks, and other small invertebrates which conceal themselves in the mud and banks of rivers, is provided with a mouth which most nearly resembles the flat and sensitive bill of a lamellirostral bird. The singularly modified jaw-bones, already described, are invested by a smooth coriaceous integument, (*fig. 173, A, E, a*) devoid of hair, but perforated by innumerable minute foramina. At the base of the jaws this integument is produced into a free fold, which overlaps the hairy covering of the cranium immediately behind it. The integument covering the upper mandible extends beyond the margins of the bone, and forms a tumid, smooth, and highly sensible lip; the narrower and shorter under jaw is more closely invested: the oral or upper surface of the lateral part of the under jaw supports a series of about twenty nearly transverse folds, increasing in breadth as they approach the angle of the jaw: the corresponding surface of the upper jaw is smooth.

The two anterior horny teeth in both jaws are elongated, narrow, with their outer part raised into a trenchant edge in the lower jaw. The two posterior teeth (*fig. 173, h, and F*) in both jaws are flat, with two broad and slight excavations, corresponding with the two parts into which each molar may be divided in the young animal.

Immediately on the outside of the posterior part of each molar in the lower jaw, is the orifice of an oblong cheek-pouch (*fig. 180, F, F*), about two inches in length, and half an inch in diameter: the pouch is continued backwards, and is lined with a hard dry cuticle.

The tongue (*fig. 186*) consists of two parts, the normal, anterior, narrower portion (*e*), and a broad, raised posterior lobe (*f*), analogous to the intermolar eminence of the tongue in certain Rodents. This part is produced anteriorly into a free projecting apex in the Ornithorhynchus, and is rendered still more remarkable in that animal by being armed with two short thick horny spines (*g, g*), projecting forward.

The anterior part of the tongue is beset with rather coarse papillæ, and extends into the posterior interspace of the incisive teeth, but with the apex more than an inch distant from

Fig. 186.

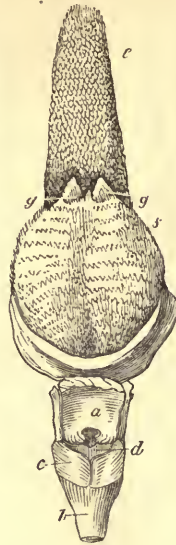

Tongue and larynx of the Ornithorhynchus. (Meckel.)

The soft palate is thick, broad, and divided posteriorly into three fimbriated lobes.

The pharynx is narrow, and is singularly encompassed by two posterior processes of the thyroid cartilage (*fig. 189, c, c*).

The œsophagus becomes slightly dilated near the diaphragm, below which it expands into a moderate-sized membranous stomach (*fig. 187, l*), which is chiefly remarkable for the close approximation of the cardiac and pyloric orifices. The intestinal canal is moderately wide, five feet three inches and a half in length, and provided, at a distance of four feet three inches from the pylorus, with a small and slender cæcum (*w*).

The small intestines are chiefly remarkable for the extent of the mucous coat, which is disposed in numerous folds or valvulæ conniventes: these are transverse at the beginning of the duodenum, but are placed more or less obliquely in the rest of the small intestine; they are about two lines broad, and placed very close together in the duodenum, but diminish in breadth and number as they approach the cæcum coli. There are about fifteen longitudinal folds in the first half of the colon; the remainder of the intestine has a smooth inner surface. There is no valvula coli. The rectum (*z*) terminates at the anterior and dorsal part of the vestibular compartment of the cloaca. In *fig. 191* a probe (*b*) is passed through this termination. On each side of its termination there is an oblong glandular prominence, about four lines in length and two in breadth, on which there are about ten orifices of glands, which Meckel considers as analogous to the anal glands of other quadrupeds.

The long, slender, tubular mouth of the

Fig. 187.



Thoracic and abdominal viscera, *Ornithorhynchus*.
(Meckel.)

Echidna is unprovided with teeth; but the palate is armed with six or seven transverse rows of strong, sharp, but short retroverted spines. The tongue is long and slender as in the true Anteaters; its dorsum is broad, flat, callous, and beset with hard papillæ, and the insects are doubtless crushed and lacerated between these and the palatal spines. As, however, the food undergoes less comminution in the mouth of this Monotreme than in that of the *Ornithorhynchus*, the pharynx and œsophagus are wider, and a dense epithelium lines the inner surface of the latter tube, and is continued over the capacious stomach to the pylorus, near which orifice it is developed into numerous horny and sharp papillæ. The subjacent mucous membrane is smooth; the tunics of the stomach are very thin, except at the pylorus, which forms a prominent protuberance in the duodenum. The intestinal canal of the *Echidna* is seven times the length of the body; the mucous membrane is not raised into val-

ular folds; a small vermiform and glandular cœcum divides the small from the large intestines; the rectum terminates as in the *Ornithorhynchus*.

Salivary glands.—There appears to be no parotid gland in the *Echidna*, and it is doubtful whether the thin flat stratum of glandular substance (*fig. 180, E*), which extends from the meatus auditorius to the cheek-pouch in the *Ornithorhynchus*, can be so regarded. The submaxillary gland (*fig. 180, D*) is a moderately-sized, oval, compact body, situated behind and below the meatus auditorius; it measured five lines in the long diameter and four in the short diameter. The duct is very small, scarcely admitting an absorbent injecting pipe; it passes under the omo-mylo-hyoideus (10), and then, contrary to the usual mode, begins to be disposed in a series of about twelve close transverse folds, and terminates by a single aperture at the frænum linguæ.

The submaxillary gland (*fig. 188, b*) is of unusual dimensions in the *Echidna*, in which it extends from the meatus auditorius along the neck, and upon the anterior part of the thorax: it is a broad, flat, oblong lobulated body, narrowest at its anterior extremity, from which the wide duct emerges. When the duct has reached the interspace of the lower jaw it dilates, and then divides into eight or ten undulating branches, which subdivide and ultimately terminate by numerous orifices upon the membranous floor of the mouth. This modification, which escaped the observation of Cuvier and M. Duvernoy, appears to be unique. The large size of the glands and the mode in which the secretion is spread over the floor of the mouth, relate to the lubrication of the long, slender, and extensible tongue, and to its fitness as an instrument for obtaining the insect food of the *Echidna*.

The liver (*fig. 187, r, r*) closely retains the mammalian type of the organ in both Monotremes. Four lobes may be distinguished in the *Echidna*: the principal or cystic lobe receives the suspensory ligament in a fissure; the large gall-bladder is placed a little to the right; the left lobe occupies the left hypochondrium; the Spigelian lobule is of moderate size; it is an appendage of the right lobe. The liver presents nearly the same form in the *Ornithorhynchus*, which has likewise a large gall-bladder (*fig. 187, s*).

There are three hepatic ducts in the *Echidna* which join the cystic, and the common canal terminates in the duodenum rather more than an inch from the pylorus. In the *Ornithorhynchus* the two chief hepatic ducts join the cystic near the neck of the bladder; the third hepatic joins a more distant part of the cystic; the ductus choledochus receives the pancreatic duct about nine lines before its termination, as in the Marsupials, where its coats are thickened and glandular, and opens into the duodenum about eight lines from the pylorus.

The pancreas in the *Ornithorhynchus* is a thin lobulated gland bent upon itself; the left and larger portion descends by the side of the left

Fig. 188.

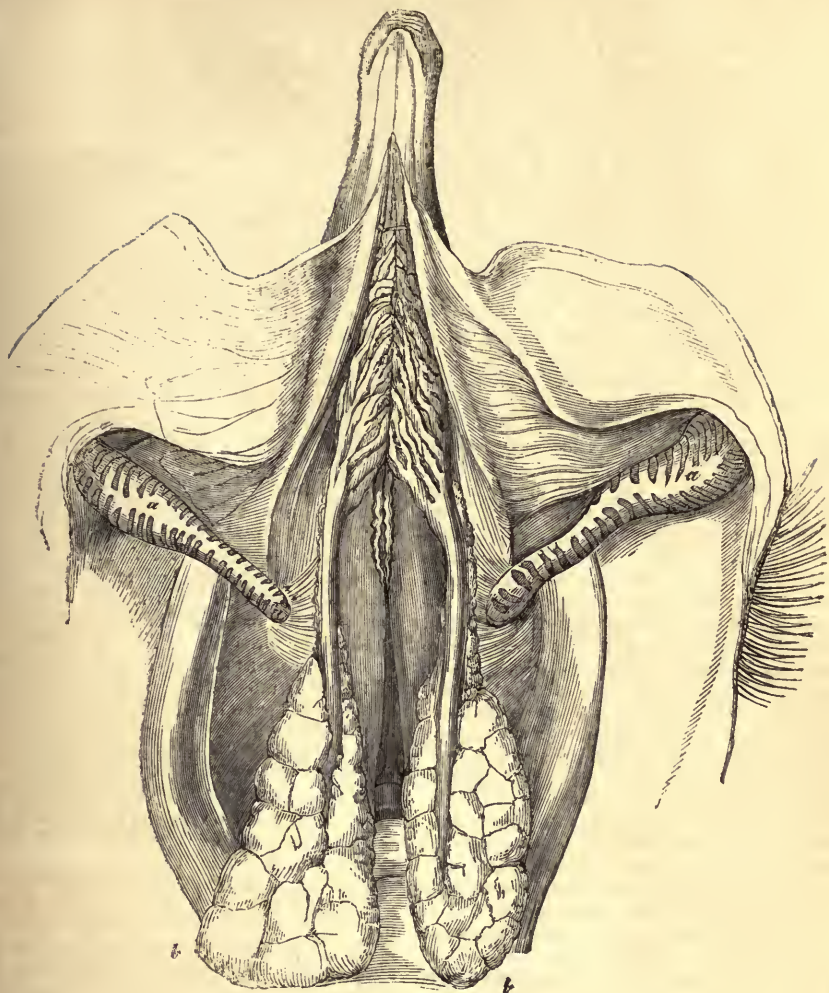
Submaxillary glands, *Echidna setosa*. (Original.)

lobe of the spleen.* The pancreas is thicker in the Echidna, and enlarges considerably towards the duodenum.

The principal difference occurs in the place of termination of the pancreatic duct, which, in the *Ornithorhynchus*, joins the ductus choledochus, but in the *Echidna* terminates separately in the duodenum and nearer the pylorus than does the ductus choledochus.

The arrangement of the hepatic and pancreatic ducts is thus conformable to the Mammalian type, and the *Ornithorhynchus*, in the place of the junction of these ducts near the commencement of the ductus choledochus, manifests its affinity to the Marsupials, as the same structure occurs in the *Dasyurus*.

The spleen (*fig. 187, u, u*) consists of two lobes bent upon each other at an acute angle,

in which the Monotremes again resemble the Marsupials. In the *Ornithorhynchus* the anterior and right lobe is four inches long, the posterior and left lobe two inches and a half; the right lobe is bent upon itself. In the *Echidna*, besides the two lobes which are continued forwards from the left side, there is a third shorter descending appendage.* The lobes are thin and moderately broad in both Monotremes, and in structure, size, situation, and general figure, the spleen conforms to the Mammalian type, although this is exhibited under a more than usual complication of external form.

CIRCULATING SYSTEM.

Blood of the Ornithorhynchus.—A Mammal presenting such striking resemblances in certain parts of its organization to the oviparous

* Meckel, loc. cit. p. 46.

* Cuvier, l. c. t. iv. p. 591.

modification of the Vertebrate type as does the Ornithorhynchus, is one of which it was obviously most interesting to ascertain the form of the blood-discs. I have made applications to different professional and zoological correspondents in Australia on this subject, for the transmission of a portion of recently drawn blood thinly spread and dried on glass, or preserved in its fluid state in brine and other menstrua of the same density as serum, and for the results of observations on the blood-discs of both the Ornithorhynchus and Echidna. Mr. Hobson, of Hobart Town, Van Diemen's Land, an accomplished surgeon and comparative anatomist, has made the required observations on the blood of the Ornithorhynchus, of which he has transmitted to me the following account:—"The globules of the blood of the Ornithorhynchus are discoid, and measured about the $\frac{1}{1000}$ th of an inch, calculating two-and-a-half millimetres to the line. The human blood-globules were placed side by side with those of the Ornithorhynchus, and both in shape and size so nearly resembled each other that it was impossible to say which was human and which was Ornithorhynchus. These examinations were made in the presence of Mr. Ronald Gunn, by means of one of Oberhauser's microscopes; the powers used were 250, 400, and 800. In order to be sure that there was no delusion, I placed the elliptical globules of a Lizard's blood beside those of the Ornithorhynchus. The tenacity and high florid colour of the blood, together with the greater proportional number of globules in a given quantity" (in the Ornithorhynchus) "is most interesting in an analogical point of view."

From the preceding highly valuable observations we may infer that the *Ornithorhynchus* resembles the Mammalia in the circular form, the size, the proportional number, and florid colour of its blood-discs, which correspond in size with those of the only Edentate species yet examined, viz. the Armadillo,* and consequently with those of the Quadrumana and of Man.

The blood-discs of the Echidna, according to the observations made by Dr. John Davy on a portion of blood of that animal, transmitted to England in brine, are likewise circular.

Heart.—The heart of the Ornithorhynchus (fig. 187, a, b, c) presents a rounded oblong form; it is situated in the middle of the anterior part of the chest, parallel with the axis of the cavity. It is inclosed in a thin subtransparent but strong pericardium.

The right auricle (b) is larger and longer than the left; its appendix is free and is slightly bifid, as in the Marsupials. It receives the venous blood, also, as in that order, by three great veins; the left vena innominata (f) descending behind the left auricle to join the termination of the inferior cava (h). The coronary vein also terminates in the auricle to the right of the inferior cava. The right superior

cava (e) is joined to the left by a transverse branch (g). Meckel found in the heart of both the Ornithorhynchus dissected by him a deep but closed fossa ovalis, near the upper extremity of the septum. This structure would indicate that the intra-uterine existence of the young was of longer duration than in the Marsupialia.

The right ventricle (a) is capacious, with thin parietes. The tricuspid valve I found to consist of two membranous and two fleshy portions: the smallest of the latter was situated nearest the origin of the pulmonary artery, and seemed to correspond with the lesser fleshy valve observable in the heart of certain birds, as the Ostrich; it is attached to the whole of the side of the first or adjoining membranous portion. The second fleshy portion may be described as analogous to the muscular valve in the Bird's heart, if the lateral margin of this were detached from the wall of the ventricle, and the connection of its two extremities was preserved, the one to the angle between the fixed and moveable wall of the ventricle, the other to the auriculo-ventricular orifice. The two edges of the lower half of the second fleshy portion of the valve in the Ornithorhynchus are free; but those of the upper half are attached to the two membranous portions of the tricuspid valve; the margin of the membranous part of the valve is attached to the fixed wall of the ventricle by two small chordæ tendinæ; and the structure of the valve thus offers an interesting transitional state between that of the Mammal and that of the Bird.*

The origin of the pulmonary artery is provided with the three usual sigmoid valves.

The left ventricle has very thick parietes, which form the apex of the heart; the mitral valve is membranous; the larger flap is attached to two strong columnæ carneæ; the smaller flap to three smaller columnæ.

The small left auricle (c) receives two pulmonary veins.

In the Echidna the free appendix of the right auricle is slightly indented. The terminal orifice of the superior cava is protected by a membranous semilunar valve, extending from its left side. The muscoli pectinati diverge from a strong fasciculus, which extends from the appendix to the orifice of the inferior cava; this fasciculus bounds the left side of a wide fossa ovalis, which is imperforate. The inferior cava is protected by a large membranous Eustachian valve; the left vena innominata terminates by a distinct aperture to the left of the preceding, and is also defended by a process of the Eustachian valve. The inner surface of the right ventricle is more irregular than in the Ornithorhynchus; the free wall is attached to the fixed one by several columnæ carneæ and short chordæ tendinæ; the tricuspid valve is membranous and consists of one principal portion attached to the exterior

* "Similitudo quædam cum avium valvula venosa dextra et propter carnositatem et propter figuram minime prætervidenda adest."—Meckel, l. c. p. 31.

* See Medical Gazette, Nov. 18, 1840.

circumference, and a smaller portion closing the outer angle; the free margin of the valve is attached to the extremity of a large fleshy column, arising by different roots from both the fixed and the free walls of the ventricle; a short fleshy column is attached to the left extremity of the valve; some chordæ tendinæ are fixed to the right angle of the valve. The rest of the structure of the heart corresponds with that in the Ornithorhynchus.

The aorta (*fig. 187, d*) bends, as in the Mammalia, over the left bronchus. The primary branches come off from the arch, in both Monotremes, as in Man, viz. arteria innominata, left carotid, and left subclavian. The innominata divides, after a course of three lines, into the right subclavian and carotid (*fig. 187, i*), the latter being the smallest branch. Both subclavians emerge from the thorax above the first rib, and pass between it and the coracoid.

The phrenic, celiac, and mesenteric arteries are given off from the abdominal aorta; the renal artery is short, wide, and single; there is no inferior mesenteric artery, but the abdominal aorta terminates by dividing into the two common iliac and the caudal arteries, the arterial system agreeing in this and the other essential characters with the Mammalian type. The crural artery is shown at *y*, *fig. 180*.

Each of the superior venæ cavae receives the azygos vein of its respective side. The inferior cava has a long course in the thorax; it is greatly dilated in the liver in the Ornithorhynchus, as it is in the Placental divers, the Otter and Seal for instance.*

The veins of the kidney are continued from the renal artery, and communicate solely with the inferior cava. The vena portæ is constituted as in other Mammalia.

RESPIRATORY SYSTEM.

The lungs of the Monotremata are confined to the thoracic cavity, and suspended freely in compartments partitioned off by duplicatures of the pleura. The right lung is divided, in the Ornithorhynchus, into three lobes, of which the smallest (*fig. 187, n*) fills the interspace between the heart and diaphragm: the left lung (*o*) is undivided. The structure of the whole is spongy, and divided into minute cells.

The trachea (*fig. 187, m*) is wide, as in most aquatic mammals: the cartilaginous rings, fifteen in number, are broad and slightly overlap each other: the bronchial annuli are bony, and are continued of that texture through a great part of the lungs.

In the Echidna the trachea is narrower than in the Ornithorhynchus: there are twenty-two tracheal hoops, which are disunited behind; very firm cartilaginous annuli are continued along the larger branches of the bronchus for some way into the lung, but the smaller branches are membranous.

There is no trace of inferior larynx in either

Monotreme. The superior larynx is conformable to the Mammalian type, but presents some remarkable modifications in the Ornithorhynchus. The thyroid cartilage (*fig. 189, c*) in this animal is very broad; its middle part is prominent and acuminate: the lateral alæ are bony, and each of them divides, and sends one of the processes to the posterior part of the pharynx (*fig. 186, c*), where it becomes cartilaginous, and is confluent with the corresponding process of the opposite side. The cricoid cartilage (*fig. 189, d*) is ossified at its middle anterior part. The arytenoid cartilages, (*fig. 189, e, e*) present the usual triangular form, and are of large size. The epiglottis (*fig. 189, a*) is remarkably broad, with an acuminate and notched apex.

Besides a small thymus gland, Meckel found in the Ornithorhynchus two other lateral glands on the external part of the chest, extending between the scapula and humerus, covered only by the panniculus carnosus and the trapezius. These presented a reddish colour, a lobulated structure, and pretty firm texture.

RENAL SYSTEM.

The suprarenal bodies (*fig. 190, b, b*) are of moderate size, of the usual structure, and have the ordinary situation internal to the anterior extremities of the kidneys.

The kidneys (*a, a*), in both Monotremes, are simple, compact, conglobate glands, situated, as usual, far forwards on the loins, the right a little in advance of the left. The external surface, after the removal of the capsule, is smooth. The renal tissue consists of the two usual portions; the cortical, or softer and more vascular part, being easily distinguishable from the more compact medullary part. The tubuli uriniferi terminate on the concave surface of a small and simple pelvis.

The ureter (*fig. 190, c, c*) takes the usual course to the contracted neck of the bladder, but terminates, in the male, in the urogenital canal, below the vasa deferentia; and, in the female, (*fig. 191, l, l*) beyond the uterine orifice, which thus intervenes between the ureter and the orifice of the urinary bladder.

In all respects, save the place of termination of the excretory ducts and their relation to the reservoir of the renal secretion, the Monotremes adhere closely, in regard to their urinary system, to the Mammalian type. The circumstances in which they deviate from the higher mammals approximate them closely to the Reptilia, and especially the *Chelonia*; and it is to be observed that the deviation commences where the urinary system begins to be connected with the generative organs, in which the oviparous type of structure is especially manifested.

ORGANS OF GENERATION.

The male organs in both Monotremes consist of a testis, vas deferens, Cowper's glands, and penis: there are neither prostatic glands nor vesiculæ seminales.

Fig. 189.



Larynx of Ornithorhynchus. (Meckel.)

* Meckel, l. c. p. 32.

Fig. 190.

Male organs, *Ornithorhynchus*. (Meckel.)

The Monotremes are true *testiconda*, and in this respect differ from the Marsupial animals. In the *Echidna* each testicle is situated immediately below, or sacred of, the kidney, and is suspended to that gland by a fold of peritoneum; the same fold is continued to the neck of the bladder, inclosing the vas deferens, which is disposed in a series of close transverse folds throughout its whole course. It corresponds closely, in these respects, with the *Ornithorhynchus*. In neither Monotreme is there any disparity of size between the right and left testicle: the latter is figured *in situ* at *a*, *fig.* 187. The vas deferens (*fig.* 190, *f*) emerges from the upper or atlantal extremity of the testis (*e*); and, from its peculiarly extended, plicated, or folded course, seems to prolong the epididymis nearly to the neck of the bladder; the folds gradually diminish, and the duct itself enlarges, as it approaches its termination, which is in the beginning of the urogenital canal (*g*). This canal is continued through the pelvis and terminates in the vestibular passage, anterior to the orifice of the rectum (*q*).

The vascular tissue of the penis commences at the termination of the urogenital canal; it is separated by a median septum into two lateral moieties, and both are inclosed by a common dense fibrous sheath. The whole penis in its collapsed and retracted state is about fifteen lines in length, and is concealed in a large preputial sheath. The terminal half of the penis is formed by the glans, which presents a quadrilateral form, and is traversed by a median longitudinal furrow upon both the upper and the under surface. Its exterior is beset with numerous short and hard epidermal spines: its extremity is bifurcated, and each lobe is directed outwards and termi-

nates in three or four spines, (*k, k*), much larger, but softer, than the rest, and which are usually retracted into a depression.

A longitudinal azygos levator muscle runs along the upper surface of the penis; it arises by two lateral slips from the internal stratum (*n*) of the protrusive sphincter. Another longitudinal but longer and more slender muscle, the retractor penis, (*fig.* 190, *p*), arises from the upper part of the base of the tail, bends downwards over the caudal muscles and vessels, and is inserted into the origin of the penis near the termination of the urogenital canal. The true urethra or canal of the penis begins by a small orifice at the root of the penis, near the termination of the urogenital passage, and by the combined action of the last described muscle with the sphincter cloacæ, it can be brought into closer approximation with the urogenital passage. It must be supposed that this temporary continuation of the urethra and urogenital passages takes place during the vigorous muscular and vascular actions of the parts in coitu, and that the semen is then propelled from the one along the other without escaping into the common vestibular compartment of the cloaca. Under ordinary circumstances, as when the urine is transmitted along the urogenital passage, it must escape into the vestibule, and may there be blended, as in the Bird, with the rectal excrement. The true seminal urethra, commencing by the distinct aperture, as above described, is about a line in diameter, and continues single to the middle of the glans, where it divides into two canals; each branch runs along the middle of the bifurcation of the glans, and, when arrived at the base of the large papillæ, subdivides into smaller channels corresponding with the number of the papillæ, and opening upon their apices. If the canal of the penis were slit open along its under part and thus converted into a groove, the male organs of the *Ornithorhynchus* would be then essentially like those of a Tortoise. The adhesion to the Mammalian type is manifested in a highly interesting manner by the completeness of the urethral canal, whilst the affinity to the Marsupial order is evinced in its bifurcation, corresponding with that of the glans itself. Had the penis been neither perforated nor grooved, as Cuvier once believed, the structure would have been extremely anomalous. That the existence of a penis is essentially and subordinately related to the sexual organs and not to the renal, is beautifully illustrated by the complete separation of the uro-urethral from the semino-urethral passages in the Monotremata.

The modifications by which the male organs in the *Echidna* differ from those of the *Ornithorhynchus*, are confined to the glans penis, which divides into four mammiloid processes, roughened by minute papillæ, and terminated by a depression in which is the branch of the seminal canal that traverses each process. Cowper's glands (*fig.* 180, *k, k*, and *fig.* 190, *h*) are of large relative size; they are situated between the base of the penis, the arch of the ischium, and internal part of the thigh: their secretion is carried by a long and slender duct (*fig.* 190, *m*) into the

seminal urethra. The physiological relation of these glands to such a canal is clearly illustrated by their presence in the Monotremes, and their absence in the oviparous animals which have merely a seminal groove.

The female organs of generation (fig. 191) consist of two ovaria, the right much smaller than the left, two oviducts, two uteri, a clitoris, and mammary glands.

Fig. 191.



a, Cloacal outlet.
 b, Common vestibule.
 c, Uro-genital canal.
 c', Its sphincter.
 d, Uterus.
 d', Oviduct.
 e, Ovarian aperture.

f, Left ovary.
 f', Right ovary.
 i, Ovarian ligament.
 k, Urinary bladder.
 l, Ureter.
 m, Os uteri.

Female organs of generation, natural size, *Ornithorhynchus*. (Owen, *Philos. Trans.* 1832.)

The *ovaria* correspond in situation and surrounding attachments with the testes in the male; and the oviducts and uteri exhibit in their closely convoluted disposition an analogy with the long epididymis or vas deferens.

The left ovary (*fig.* 191, *f*) is an irregular, semi-elliptical, flattened body, with a wrinkled and slightly granulated surface in the unexcited state; but thicker, and with the surface studded by elevations formed by the ovisacs in different stages of development at the season of sexual excitement. At this period I have usually found two ovisacs, as in the figure, which are conspicuously larger than the rest, and presenting each a diameter of about two lines. The right ovary (*f'*) is a narrow, thin, generally elongated body; sometimes broader, with a finely granulated surface. It is often scarcely to be distinguished from the ovarian ligament to which it is attached. This ligament (*i, i*) arises from the posterior parietes of the abdomen, behind and a little on the outer side of the kidney, and passes along the edge of the broad ligament to the fallopian extremity of the oviduct, where it divides into two; one portion is attached to the side of the ovary, the other to the posterior margin of the fallopian orifice: after a course of an inch they again unite, and the ligament is continued along the anterior part of the uterus to its cervix, where it is insensibly lost. The two separated portions of the ligament support a large pouch of peritoneum which forms the ovarian capsule; the wide anterior orifice of the oviduct is also, by means of this ligament, prevented from being drawn away from the ovary.

The efferent tube of the ovarian products is present on both sides of the body, and is divisible into an oviduct, or fallopian tube, (*d',*) and an uterus (*d*). The size of the latter is nearly equal on both sides, but the right oviduct is much shorter than the left, and corresponds with the abortive condition of the ovary. The external serous coat of the oviduct is loosely connected to the muscular coat by filamentary processes of cellular membrane, among which numerous tortuous vessels ramify. The muscular coat is thin and compact, and is most readily demonstrable in the uterus. The mucous coat is thin and smooth in the oviduct; it is thick, soft, plicated, but not villous, in the uterus.

The left *uterus* in a female with a large ovary, shot in the month of September, was two inches long, from four to five lines in diameter, and about a line thick in its parietes; it became suddenly contracted and thinner in its coats to form the oviduct, which presented a diameter of about two lines, slightly enlarging to within an inch of the extremity, which forms a wide membranous pouch, (*d''*), opening into the capsule of the ovary by an oblong orifice or slit (*e*) of eight lines in extent. The edges of this orifice were entire, as in the oviducts of Reptiles, not indented as in the fimbriated extremity of the Fallopian tube in ordinary quadrupeds. The entire length of the oviduct and uterine tube, when detached from their connections with the mesometry, was nine inches.

The right uterus and oviduct of the same specimen exhibited similar differences in diameter and structure, but was shorter, measuring only six inches in length.

In a specimen with a slightly developed ovary, killed by Mr. Bell in April, the uteri were not much wider than the oviducts, and not thicker in their coats; the entire tubes were much less in all their dimensions than those just described.

In the specimen above described with the large ovary, the thickened parietes of the first portion of the uterine tube depended chiefly on an increase of the inner membrane, which presents in a high degree the character of a secreting surface. This membrane at the cervix uteri presented in all the specimens many deep and close-set furrows, which, as the canal grew wider, were gradually lost, and the surface became more or less smooth in the different specimens, being most irregular in the specimen with the largest ovary. In the oviduct, the inner surface is at first smooth after leaving the uterus, but beyond that becomes finely reticulate, and in the terminal dilated part becomes again smooth. The cervix uteri makes a valvular projection analogous to an *os tincæ* on each side of the commencement of the urogenital canal, just beyond the orifice of the urinary bladder. There are two orifices on each of these prominences; the lower one is the termination of the ureter, and a bristle is represented as passing through it in *fig.* 191; the upper or anterior orifice is the *os uteri, m*.

In young or virgin Ornithorhynchi this orifice forms scarcely any projection into the urogenital canal, and it is divided by a narrow septum, or hymen.*

The *uro-genital canal* (*c*) is one inch and a half long, and three or four lines in diameter, but capable of being dilated to as great an extent probably as the pelvis will admit of; the diameter of the bony passage being seven-tenths of an inch. It is invested with a muscular coat, the external fibres of which are longitudinal, the internal circular. The inner membrane of this part is disposed in longitudinal rugæ more or less marked, but presents as little the character of a secreting membrane as that of the vestibule, being smooth and shining; the orifices of a few minute follicles are situated in the interstices of the rugæ near the orifice of the urinary bladder.

It is this division only of the passage from the uterus which is situated within the pelvis, the vestibule being produced beyond it, and the common outlet being in consequence situated at a considerable distance from the outlet of the pelvis.†

If the Ornithorhynchus were oviparous, its eggs must be disproportionately small compared with those of birds, in order to pass through the unyielding pelvis, unless the albumen and shell were subsequently added to the yolk in the

* Geoffroy, Mémoires du Muséum, tom. xv. p. 32.

† In this structure, as well as in its aquatic life, the Ornithorhynchus resembles the Beaver.

vestibule. But, as has been before observed, neither the lining membrane of the vestibule nor that of the genito-urinary passage presents the characters of an active secreting membrane; and it is highly improbable that an almost callous surface daily traversed by the excrements, should be suddenly modified to contribute so important a share to the nutrient store of the embryo.

The common vestibule (*b*) is about one inch four lines in length, and varies from half an inch to an inch in diameter. The muscular fibres immediately investing it are disposed as follows. A thin circular muscle arises from a dorsal raphe which extends the whole length of the canal. Of this muscle the sacral fibres, or those nearest the outlet, surround the whole vestibule; but the atlantal or more internal fibres pass obliquely upwards, and surround the termination of the rectum only, serving as a sphincter to it. On the sternal aspect of the vestibule there are a series of longitudinal fibres, which extend from its external orifice to that of the urogenital cavity, the office of which is to approximate these orifices; and in this action the oblique fibres above described would assist, while at the same time they closed the rectum.

On the sternal aspect of the urogenital canal, and close to where it joins the vestibule, the clitoris is situated, which is consequently about an inch and a half distant from the external orifice of the vestibule. It is inclosed in a sheath upwards of an inch in length, and about two lines in diameter, of a white fibrous texture, and with a smooth internal surface, and this sheath communicates with the vestibule about a line from the external aperture. The clitoris itself is a little flattened body shaped like a heart on playing cards; it is about three lines long, and two lines in diameter at its dilated extremity, where the mesial notch indicates its correspondence of form with the bifurcated penis of the male. From the shortness of the clitoris, and the length of its sheath, it is obvious that no part of it can project into the vestibule in the ordinary state of the parts, as stated by Sir Everard Home, its extremity being situated at least an inch distant from where its sheath communicates with that cavity.

At the base of the clitoris are two small round flattened glands, the analogues of Cowper's glands in the male, which open into the sheath or preputium clitoridis. These glands were largest in the specimen whose uterine organs were most developed.

The vestibule is lined by a dark-coloured cuticular membrane, and has a tolerably uniform surface. The rectum opens freely into it posteriorly, as indicated by the probe *b*, in *fig. 191*; the line of distinction in the relaxed state of the sphincter above-mentioned being little more than a change in the character of the lining membrane.

The urogenital canal, on the contrary, opens into the vestibule by a contracted orifice, and, in one of the specimens examined, made a small circular and valvular projection into that cavity.

On either side the termination of the rectum there are from six to eight small apertures of dark-coloured glands or follicles, about the size of a pin's head, situated immediately behind the proper membrane of the vestibule, and corresponding with the anal follicles of the Marsupial and other Quadrupeds.

The female organs of the *Echidna* correspond in all essential points with those of the *Ornithorhynchus*.

Products of generation.—The mode of generation and course of development of the Monotremata, although elucidated in many essential points by the light of anatomy and analogy, still demand observation of the breeding animals, and of the impregnated uterus and embryo in several stages, before they can be fully determined.

The close resemblance of the efferent tubes, in their complete separation and in their mode of termination, with the oviducts of Reptiles, and more especially of the Oviparous tortoises, added to the approach to the very peculiar condition of the female organs in Birds which the Monotremes offer in the unequal development of the ovaria and oviducts, have inclined several physiologists to a belief in the reports which from time to time have been published of the discovery of eggs in the nests of the *Ornithorhynchus*. But a comparison of the organs themselves with the conditions essential to the Oviparous generation of a warm-blooded animal offers almost insuperable difficulties to this view. The difference of structure and dimensions between the uterine and oviducal divisions of the efferent canal is greater in the *Ornithorhynchus* than in any bird, and so closely corresponds with that which characterizes the uterus and oviduct in the Kangaroo, that it is highly probable they perform similar functions in the completion and development of the ovum.

But the experienced physiologist would seek to obtain a closer insight into the mode of generation of the Monotremes by a comparison of the more essential generative organ,—the ovary,—with that of the bird. Now it has been shown that this organ, at the period of sexual excitement, does not differ in size or form from that of the Rodent or Marsupial quadruped; nay, that some of the latter tribe, as the *Wombat*, more nearly resemble the bird in the large size of the ovisacs or calyxes than the Monotremes are known to do. A yolk of large size appears, however, to be an essential condition of an egg which is to be hatched by a warm-blooded animal out of the body; but the vitelline portion of the ripe or nearly ripe ovarian ovum of the *Ornithorhynchus* does not equal the twentieth part of the yolk of the egg of a bird of corresponding size: and it is scarcely necessary to observe that the yolk is always exclusively a product of the ovarium, and that the material added to it by the oviduct or uterus must be analogous to the albumen, chalybeæ, and cortical investments of the bird's egg.

The unimpregnated ovarian ovum from an ovisac of two lines in diameter, of the *Orni-*

thorhynchus, is of a spherical form, and very nearly fills the ovisac. The diameter of the germinal vesicle is to that of the ovum as 1 to 38. The vitelline fluid is rich in the number of its nucleated cells or granules, and the intermixed, clear, colourless oil-globules. The vitelline membrane is moderately thick, smooth, and highly refracting. The ovum is separated from the ovarian vesicle, or lining membrane of the ovisac, by a very small quantity of fluid and a stratum of granules or cells. The proper tunic of the ovisac consists of a dense and very vascular layer of the 'stroma' or proper tissue of the ovary, which is rather thicker and more distinctly laminated than in most Mammalia, and in this respect widely differs from the lax stroma of the ovary of the bird. The most important difference to be noted in the present comparison with the bird is the small size of the ovarian ovum, depending on the relatively scanty amount of vitelline matter, superadded in the ovary to the essential part of the ovum, the vesicula germinativa.

It may be objected that the impregnated ovarian ova in birds rapidly augment in bulk as the time of dehiscence approaches, and that, although the ovaria of the Ornithorhynchus may have been investigated within a few days of the reception of the impregnated ovum into the oviduct, the changes occurring in such a period might much more nearly approximate the ovarian ovum of the Ornithorhynchus to the size and other conditions of that of the bird than in the instances above described.

The following observations on the impregnated ovum in the uterus itself prove, however, that no such approximation to the bird in regard to the proportion of yolk added to the ovarian ovum, or as respects the size of the ovum prior to dehiscence, is made by the Ornithorhynchus.

For the acquisition of this important evidence in the question of the generation of the Monotremata science is indebted to the exertions of Mr. Geo. Bennett, F.L.S., a Member of the Royal College of Surgeons in London, and Colonial Zoologist at Sydney, New South Wales. Three uteri, containing undeveloped ova, were transmitted by that gentleman to the Museum of the Royal College of Surgeons, in 1834, and with the sanction of the Board of Curators, were described by me in the Philosophical Transactions of that year.*

In these specimens the left ovary only had taken on the sexual actions, but did not exceed in size the same parts in the unimpregnated specimens above described. The right ovary had, however, become enlarged; it measured half an inch in length, a third of an inch in breadth, and was about half a line in

Fig. 192.



Left uterus impregnated, *Ornithorhynchus*.
(Owen, *Phil. Trans.* 1834.)

thickness: a few ovisacs, about the size of a small pin's head, projected from the surface. The left ovary in each of the specimens was concealed by the thin membrane forming the expanded orifice of the oviduct, to which it was agglutinated by a coagulated secretion. In two of the specimens the left ovary presented two empty ovisacs, or corpora lutea (fig. 192, *b b*), corresponding with the number of ova found in the uterus. In the third specimen the left ovary presented two ovisacs still uncatrized; but only one ovum was contained in the uterus. In a fourth specimen three similar ovisacs were present, but the ova had been removed from the uterine cavity. The discharged ovisacs were of an elongated flask-shaped form about three lines in length, and two in diameter, with the margin of the orifice, through which the ovum and granular substance had passed, everted, with a slight contraction, resembling the neck of a flask, below the aperture. On compressing these ovisacs, small portions of coagulated substance escaped. When longitudinally divided, they were found to consist of the same parts as the ovisac before impregnation, with the exception of the granular contents and granular stratum; but the theca, or innermost parietes of the sac, was much thickened, and encroached irregularly upon the empty space, so as to leave only a cylindrical passage to the external opening.

The impregnated Ornithorhynchus, in the uterus of which the two smallest sized ova were found, was shot on the evening of the 6th of October, 1832, in the Yas river, Murray County, New South Wales. These ova were of a semitransparent white colour when recent, but had lost that appearance when examined at the Museum, to which they had been transmitted, *in situ*, with the uterus and surrounding parts well preserved in spirits. The ova were situated at the upper part of the left uterus, and at the distance of about a line from each other. Each ovum was spherical in form, and measured two lines and a half in diameter; they were of a deep yellow colour,

* See vol. cxxiv. p. 555, and *Physiol. Catalogue of the Hunterian Museum*, vol. v. p. 112, No. 3460 A.

with a smooth and polished surface, and had not the slightest adherence to the uterine parietes.

The specimen containing the two ova next in size (*fig. 192, c c*) was shot in the same locality on the 7th of October. These ova measured each three lines in diameter, and were situated a little below the middle of the left uterus: they were of a spherical form, but had evidently been slightly compressed in the uterine cavity. They were of a lighter colour than the preceding; a circumstance which was specially evident at the upper part, from the subsidence of the contained vitelline mass. Externally they were smooth and rolled freely out of the position where they were lodged, like those of the preceding specimen.

The third specimen, in the uterus of which the largest ovum was contained, was shot on the evening on which the first specimen was obtained. This ovum had the same spherical form, smooth exterior surface, and freedom from connexion with the uterus, as in the preceding; but was of a much lighter colour, owing to the increased quantity of its fluid contents, to which its greater size was chiefly attributable. It measured three lines and a half in diameter, and had been situated in a depression or cell a little below the middle of the left uterus. The lining membrane of the uterus was highly vascular in the recent state in each of the above specimens.

In all these ova the contents could be seen, through the cortical or outer membrane, to be of two kinds, viz. a greyish sub-transparent fluid, and a yellowish denser mass, which varied in their relative proportions as above-mentioned, the denser substance always subsiding to the lowest part of the ovum, whichever way it was turned.

In the largest ovum, the yellow mass or yolk occupied about one-third of its cavity, while in the smallest it constituted four-fifths of the whole mass.

The chorion or cortical membrane of these ova (*fig. 193, a*) offered a moderate degree of resistance when torn open with the forceps, and yielded equally in every direction when separated from the yolk, the rent margins

Fig. 193.

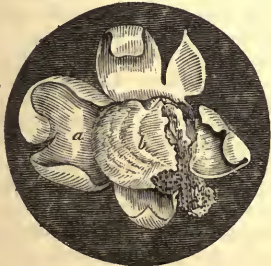

*Uterine Ovum, magnified and dissected,
Ornithorhynchus.
(Owen, Phil. Trans. 1834.)*

curling inwards like the coat of an hydatid. This membrane is of a dull greyish colour, inclining to brown, slightly transparent, and more polished upon its inner than upon its outer surface: it resembles the cortical membrane of the ovum of the Salamander, but is of a more delicate texture. The fluid contents occupied the space between the cortical and vitelline membranes, a situation analogous to that of the albumen in the egg of the fowl, but had not become coagulated by the action of the spirit in which it had been so long immersed.

The yellow matter, or yolk, was seen to be invested by its proper capsule (*fig. 193, b*), which, when reflected under the microscope, was found to consist of an extremely thin, smooth, and transparent outer layer, which I regard as the *membrana vitelli* (*fig. 194, a*), with a thicker granular membrane immediately lining it, analogous to the *blastoderma* or *germinative stratum* (*fig. 194, b*).

The contents of the above investments, or substance of the yolk, consisted of innumerable minute opaque granules, similar in size and regularity of form to those contained in the ovarian follicles; and with these granules were mingled larger transparent globules of oil. There was not the slightest trace of chalazæ attached to the vitelline membrane, as from analogy we might have expected, had the ovum been destined to have been perfected by incubation. I was unable to detect any rudiments of the embryo: an opaque streak was discernible on one part of the yolk, but not sufficiently definite to be satisfactorily recognised as a cicatricula; it is indeed, probable, from the observation of Lieutenant Maule,* that the ova attain a greater size by the imbibition of the nutrient material before the lineaments of the fetus become visible.

The changes which the impregnated uteri of the *Ornithorhynchus* had undergone, as compared with the same part in the quiescent state, were greater than those which have been observed to take place in the Kangaroo. The uterus containing the two smallest sized ova measured seven lines in diameter, but was much firmer and denser than in the unimpregnated specimens; and having also increased in length, was thrown into more abrupt curves on either side of the ovarian ligament. The uterus which had contained the largest ovum measured an inch in diameter; and that containing those of the second size was of

Fig. 194.



*Portion of the vitelline membrane and germinal stratum, Ornithorhynchus.
(Owen, Phil. Trans. 1834.)*

* Proceedings of the Zoological Society, 1832.

“ In the insides of several female platypi which were shot, eggs were found of the size of a large musket-ball and downwards.”

nearly the same size (*fig.* 192). The right uterus in all the specimens had become sympathetically affected, being firmer in texture and thicker in its coats.

The parietes of the impregnated uteri were from three to four lines in thickness; an increase which was principally occasioned by the extension of small vascular folds between the fibrous and internal coats, which were so placed at right angles to these tunics as to present an appearance very similar to that of the second cavity of the stomach of the Porpessa. The fibrous coat was slightly thickened near the cervix, and the serous covering was separated from it by the ramifications of numerous large and tortuous uterine vessels.

There was not the slightest trace of a decidual or adventitious inmembrane in the cavity of the womb; and especial attention was directed to this circumstance, in consequence of the office assigned to it in a recent work,* as ministering support to the ova in the higher *Mammalia*, at a period when, like those of the Ornithorhynchus, they have no attachment to the uterine parietes.†

It may, however, be said that the deciduous membrane is here represented by the cortical or outer covering of the ovum: but this membrane, though of a denser structure and without villi, is certainly analogous to the outer tunic of the uterine ovum of the Rabbit and Bitch, which in them is gradually separated from the vitelline membrane by the imbibition of albuminous fluid. Now the relative proportion of the fluid interposed between the cortical and vitelline membranes in the small and large ova of the Ornithorhynchus, shows that the mutual recedence of the two membranes is effected in the same way.

If the form, the structure, and the detached condition of the ova of the Ornithorhynchus, should still be regarded by some as compatible with, and perhaps favourable to, the opinion that they are excluded as such, and that the embryo is developed out of the parent's body, the following objections oppose themselves to such an opinion: the only part of the efferent tube of the generative apparatus which can be compared in structure or relative position to the shell-secreting uterus of the Fowl, is the dilated terminal cavity in which, in all the specimens above described, the ova were situated; and upon the oviparous theory it must be supposed either that the parietes of this cavity, after having secreted the requisite quantity of soft material, suddenly assume a new function and complete the ovum by providing it with the calcareous covering necessary to enable it to sustain the superincumbent weight of the mother during incubation; or, that this is effected by a rapid deposition of the same material from the cuticular surface of the external passages; or lastly, according to a more recent, but still more improbable sup-

position, by a calcareous secretion of the abdominal glands poured out upon the ovum after its exclusion.*

But granting that the egg is provided in any of these ways with the necessary external covering, yet from the evidence afforded by the specimens under consideration, the ovum is still deficient in those parts of its organization which appear to be essential to successful incubation, viz. a voluminous yolk to support the germinal membrane, and the mechanism for bringing the cicatricula into contiguity with the body of the parent. Add to this, that such a mode of development of the fœtus requires that all the necessary nutritive material be accumulated in the ovum prior to its exclusion. Now the bony pelvis of the bird is expressly modified to allow of the escape of an egg, both large from the quantity of its contents, and unyielding from its necessary defensive covering; but whatever affinities of structure may exist in other parts of the Ornithorhynchus, it is most important to the question of its generation to bear in mind that it manifests no resemblance to the bird in the condition of the pubic bones.

Again, as we have seen that the ova of the Ornithorhynchus have attained a diameter of little more than two lines after having traversed the whole of the Fallopian tube, the length of which is six inches, and the internal secreting surface increased by numerous folds, it may be reasonably inferred, from the analogy of the Rabbit and other *Mammalia*, that the ovum was of much smaller dimensions when first received into the oviduct. But the yolk in Birds and Oviparous Reptiles is invariably the product of the ovary, and derives no appreciable increase from the secretions of the efferent tube, which supply only the albuminous part of the egg, or the material for the first formation of the chick. If, therefore, the gestation of the Ornithorhynchus terminates by the exclusion of an egg, as in the Bird or Tortoise, the preparatory steps in the formation of the ovum are widely different, for the parts concerned manifest the essential characters of the Mammiferous type, and the germ itself has a corresponding structure.

These facts, it is agreeable to find, are in exact accordance with the now ascertained functions of the abdominal glands; for since the yolk in the Bird, besides its uses in the course of the fetal development, is intended as an after-substitute for a mammary secretion, remaining, as it does, but little diminished at the close of incubation, it might have been concluded, from *à priori* physiological deduction, that the Monotremes, in which no such substitute is required, would approximate the other *Mammalia* in the small size of the ovarian ovum.

The nature or amount of subsequent deviations from a true viviparous generation can be determined only by future examinations of more advanced ova. From the structure of the cor-

* Breschet, *Etudes de l'Œuf Humain*.

† In the recent specimens *Mr. Bennett* noticed besides the ova only a "moisture" in the uterus.

* Geoffroy St. Hilaire, *Gazette Medicale*, Feb. 11, 1833.

tical membrane it is probable that this does not become organized into a placenta, and that the *Monotremata* like the *Marsupialia* are essentially ovoviviparous. Since, however, the female *Ornithorhynchus* has no tegumentary pouch to protect a prematurely born offspring, it must be presumed that the fetus acquires greater proportional bulk* and more mature strength by a longer continuance within the uterus. In this case it may be doubted whether the vitelline vesicle will suffice for nourishment and respiration through the whole period of development, and the allantois and umbilical vessels will probably be more expanded for that purpose.

The means of prosecuting this inquiry are the more likely to be afforded, since, through the exertions of Mr. Bennett, the period when the pregnant female may be procured is now ascertained. Had not a specimen, supposed to be in this condition, which my friend had obtained alive, unfortunately escaped from its confinement, he would, there is little doubt, have ascertained the true nature of the generative product, and the probable duration of gestation.

With reference to the latter point, Mr. Bennett observes, that two months after the capture of the female specimen with the smallest ova, viz. on the 8th of December, 1832, he succeeded in laying open one of the burrows of the *Ornithorhynchi* on the banks of the Murrumbidgee River, in which three living young ones were found: they were naked, and measured only one inch and seven-eighths in length, and he considers them to have been recently brought forth. Not having any means of preserving these specimens, and being at a great distance from Sydney, they were lost. The nest was most carefully scrutinized by Mr. Bennett, but not the slightest trace of an egg-shell could be perceived in it.

The principal points, therefore, in the generative economy of this paradoxical species which still remain to be determined by actual observation are—

- 1st. The manner of copulation.
- 2d. The season of copulation. (This is probably at the latter end of the month of September or beginning of October.)
- 3d. The period of gestation. (This is probably six weeks.)
- 4th. The nature and succession of the temporary structures developed for the support of the fetus during gestation.
- 5th. The exact size, condition, and powers of the young at the time of birth.
- 6th. The act of suckling.
- 7th. The period during which the young requires the lacteal nourishment.
- 8th. The age at which the animal attains its full size.

I have ascertained the following particulars

* In reference to this point it may be observed, that the kidneys are not lodged low down in the pelvis as in the true *Ovipara*, but occupy the position characteristic of the Mammiferous type of structure, which allows free space for the enlargement of the uterus during pregnancy.

respecting the young *Ornithorhynchus*, probably not long excluded from the foetal envelopes, by an examination of two specimens, obtained by Lieut. the Hon. Lauderdale Maule, from two different nests, discovered by him in the banks of the Fish River, Australia, and presented by Dr. Weatherhead to the Zoological Society of London.

Subjoined is an outline of the smaller of these specimens of the natural size (fig. 195).

Fig. 195.

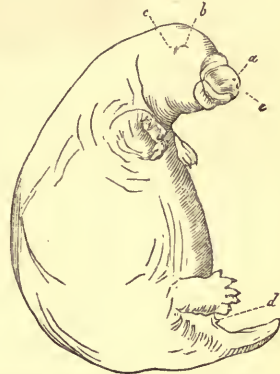

Young *Ornithorhynchus*. (Original.)

The following are admeasurements of these two specimens:—

	Smaller <i>Ornitho- rhyuchus.</i> In. L.	Larger <i>Ornitho- rhyuchus.</i> In. L.
Length from the end of the upper jaw over the curve of the back to the end of the tail	3 9	6 6
Length from the same points in a straight line along the abdomen.....	2 1	4 0
Greatest circumference of the body	2 9	4 8
Length of the head	0 8½	1 0
Length of the upper mandible	0 3	0 5
Breadth of the upper mandible at the base	0 4	0 6
Thickness of the upper mandible at the anterior margin	0 0½	0 1
Length of the lower mandible	0 2	0 2½
Breadth of the lower mandible at the base.....	0 3	0 5
Length of the tail from the vent	0 4½	0 10
Breadth of the tail at the root	0 4	0 8
Length of the fore foot	0 3	0 5
Breadth of the fore foot....	0 3½	0 5
Length of the hind foot....	0 4	0 8½
Breadth of the hind foot ..	0 3	0 5
Distance between the eyes..	0 3½	0 6
Distance between the nostrils	0 1½	0 1½
From the exterior nostrils to the end of the mandible	0 1½	0 2
From the tip of the tongue to the end of the lower mandible	0 0¼	0 0½

The circumstances which first attract attention in these singular objects are the total absence of hair,* the soft flexible condition of the mandibles, and the shortness of these parts in proportion to their breadth as compared with those of the adult.

The integument with which the mandibles are covered is thinner than that which covers the rest of the body, and smoother, presenting under the lens a minutely granulated surface when the cuticle is removed, which, however, is extremely thin, and has none of the horny character which the claws at this period present. The margins of the upper beak are rounded, smooth, thick, and fleshy; the whole of the under mandible (*fig. 196, g*) is flexible, and bends down upon the neck when the mouth is attempted to be opened. The tongue, (*fig. 196, h*), which in the adult is lodged far back in the mouth, advances in the young animal close to the end of the lower mandible; all the increase of the jaws beyond the tip of the tongue, which in the adult gives rise to a form of the mouth so ill calculated for suction or application to a flattened surface, is peculiar to that period, and consequently forms no argument against the fitness of the animal to receive the mammary secretion at an earlier stage of existence. The breadth of the tongue in the larger of the young specimens was $3\frac{1}{2}$ lines; in the adult it is only one line broader; and this disproportionate development is plainly indicative of the importance of the organ to the young animal, both in receiving and swallowing its food. The mandibles are surrounded at their base by a thin fold of integument, which extends the angle of the mouth from the base of the lower jaw to equal the breadth of the base of the upper one, and must increase the facility for receiving the milk ejected from the mammary areola of the mother. The oblique lines which characterize the sides of the lower mandible in the adult were faintly visible on the corresponding parts of the same jaw of the young animal: a minute ridge of the inner sides of these lines indicates the situations of the anterior horny teeth of the adult.

The situation of the exterior nostrils (*figs. 195, 196, a*) has already been given; they communicate with the mouth by the *foramina incisiva*, which are situated at nearly three lines distance from the end of the upper mandible, and are each guarded by a membranous fold extending from their anterior margin: the nasal cavity then extends backwards, and terminates immediately above the larynx, the tip of the

Fig. 196.



Head of young Ornithorhynchus. (Owen, Zool. Trans.)

epiglottis extending into it, and resting upon the soft palate.

On the middle line of the upper mandible and a little anterior to the nostrils there is a minute fleshy eminence lodged in a slight depression (*fig. 196, b*). In the smaller specimen this is surrounded by a discontinuous margin of the epidermis, with which substance, therefore, and probably (from the circumstance of its being shed) thickened or horny, the caruncle had been covered. It is a structure of which the upper mandible of the adult presents no trace, and is obviously analogous to the horny knob which is observed on the upper mandible in the fœtus of aquatic and gallinaceous Birds. I do not, however, conceive that this structure is necessarily indicative of the mandible's having been applied, under the same circumstances, to overcome a resistance of precisely the same kind as that for which it is designed in the young Birds which possess it. The shell-breaking knob is found in only a part of the class; and although the similar caruncle in the *Ornithorhynchus* affords a curious additional affinity to the *Aves altrices*, yet, as all the known history of the ovum points strongly to its ovo-viviparous development, the balance of evidence is still in favour of the young being brought forth alive.

The situation of the eyes (*fig. 195, b, 196, c*) was indicated by the convergence of a few wrinkles to one point; but when, even in the larger of the two specimens, these were put upon the stretch, the integument was found entire, and completely shrouding or covering the eyeball anteriorly. This fact is one of great importance to the question of the mammiferous character of the *Ornithorhynchus*. For on the supposition of the young animal possessing locomotive faculties, which would enable it like the young gosling, immediately after birth or exclusion, to follow the parent in the water, and there to receive its nutriment, (whether mucous or otherwise,*) the sense of vision ought certainly

* Geoffroy St. Hilaire contending, in 1833, for the analogy of the abdominal glands of the *Ornithorhynchus* with those of the *Shrews* which secrete "a mucus possessing a very powerful odour," says, "I should not be surprised, if this mucus, more abundant and more substantial in the *Monotremata*, became the nutriment of the young after their hatching. The *Monotremata* would act, in this respect, like some aquatic birds which conduct their young after hatching to the water, and assist them in their sustentation. The maternal instinct would lead the female *Ornithorhynchus* to effect the contraction of the gland, which is possible by the efforts of the *panniculus carnosus* and the great oblique muscle, between the fibres of which the gland is seated, and thus procure for the young, at several periods of the day, by way of nutriment, an abundant supply of mucus. If this education is carried on in the water, where we know, by the history of the generation of frogs and the nutrition of their tadpoles, that the mucus combines with the ambient medium, becomes thick, and supplies an excellent nutriment for the early age of these reptiles, we shall understand the utility of the ventral glands of the *Ornithorhynchus*, as furnishing a source of nutriment for the young of these animals,—for young *Ornithorhynchus* newly hatched."—*Gazette Médicale*, Feb. 18th, 1833.—*Proceedings Zool. Society*, March 1833, p. 29.

* This is not accidental, as in many of the adult specimens sent over in spirit, for the cuticle is entire. In the specimens which Mr. G. Bennett discovered, the skin had a slight downy appearance.

to be granted to it in order to direct its movements. The privation of this sense, on the contrary, implies a confinement to the nest, and a reception on land of the mammary secretion of the parent.

The auditory orifices (*fig. 196, d*) are situated about a line behind the eyes.

The general form of the body and the cartilaginous condition of the bones of the extremities equally militate against the young *Ornithorhynchus* possessing, at this period of its existence, active powers of swimming or creeping. The head and tail are closely approximated on the ventral aspect, requiring force to pull the body out into a straight line; and the relative quantity of integument on the back and belly shows that the position necessary for the due progressive motions is unnatural at this stage of growth.

The toes on each of the four feet were completely formed, and terminated by curved, conical, horny claws; but the natatory fold of membrane of the fore foot had not the same proportional extent as in the adult, and the spur of the hind foot did not project beyond its socket in either specimen. In the smaller one, which was a male, it presented the form of an obtuse papilla; while in the larger specimen, although a female, it was more plainly developed and more pointed (*fig. 197, f*). This circum-

Fig. 197.



Hind-foot and spur, young female Ornithorhynchus, magnified. (Owen, Zool. Trans.)

stance is in exact accordance with the known laws of the development of sexual distinctions, especially of those of secondary importance, such as beards, manes, plumes, horns, tusks, spurs, &c., which do not avail in distinguishing the sexes till towards the period of puberty. As the spur is the only obvious distinction of the sexes in the full-grown *Ornithorhynchus*, I was compelled to refer to the internal essential organs, in order to determine the sex of the specimens here described.

The ventral surface of the smaller specimen was carefully examined with a lens; but no trace of an umbilicus could be satisfactorily determined. In the very young or newly born Kangaroo, a longitudinal linear trace of the attachment of the umbilical vesicle is at that time apparent, but it is rapidly obliterated; as is probably also the case in the *Ornithorhynchus*.

In the smaller specimen the intromittent organ projected a little way beyond the excre-

mentary orifice, as in the young *Marsupialia*; but it was not continuous, as in them, with the anterior margin of that outlet. In the larger female specimen the corresponding organ was visible just within the verge of the opening; but this clitoris, remaining stationary in its development, is afterwards, as I have shown in my paper on the Mammary Glands of the *Monotremes*,* removed to a distance from the preputial aperture by the elongation of the sheath, just as the minute spur of the female lies concealed at the bottom of the progressively elongated tegumentary socket, and as the tongue is left at the back of the oral cavity by the growth of the jaws.

The following anatomical appearances were noticed in these young *Ornithorhynchi*:—

On laying open the abdomen in the larger specimen, the most prominent viscus was the stomach, which was almost as large as in the adult animal, deriving at this period no assistance from the preparatory digestive cavities, the cheek-pouches, which were not yet developed. The stomach extended in a curved direction across the epigastric and down the left hypochondriac region to the left iliac region. It was full of coagulated milk.

In the smaller specimen the stomach was empty; when distended with air it exhibited a less disproportionate development. It was situated in the left hypochondriac and lumbar regions. The intestines contained air, with granular masses of a mucous chyme adhering to their internal surface. This condition of the digestive canal would seem to show that no long period had elapsed since the birth of the specimen, and that either lactation had not been in full action, or that the young one had been deserted by the parent for some time before it was taken.

In both specimens the spleen bore a proportionate size with the stomach; and as the difference in the development of the stomach was considerable, the correspondence between the condition of the spleen with that of the digestive cavity was made very obvious.

The difference in the development of the liver was not greater than corresponded with the different size and age of the two specimens. But the pancreas in both bore the same ratio to the stomach as the spleen. This, therefore, would seem to afford some indication of the organs with which the function of the spleen is more immediately related.

The intestinal canal in the larger specimen was situated almost entirely on the right side of the *abdomen*. The *cæcum* in both was very minute and filamentary. I examined the *ileum*, and more especially in the usual situation above the *cæcum*, but could not perceive any trace of the pedicle of the umbilical or vitelline vesicle. The other vestiges of fetal organization were more obvious than in the ordinary marsupial or ovoviviparous *Mammalia*.

In both specimens, but more especially in the smaller one, the umbilical vein was seen, extending from a linear cicatrix of the perito-

* *Phil. Trans.* for 1832, p. 525.

neum, opposite the middle of the abdomen, along the anterior margin of the suspensory ligament to the liver. It was reduced to a mere filamentary tube, filled with coagulum. From the same cicatrix the remains of the umbilical arteries extending downwards, and near the urinary bladder, were contained within a duplicature of peritoneum, having between them a small flattened oval vesicle, the remains of an allantois, which was attached by a contracted pedicle to the fundus of the bladder.

As both the embryo of the Bird and that of the ovoviviparous Reptile have an allantois and umbilical vessels developed, no certain inference can be drawn from the above appearances as to the oviparous or viviparous nature of the generation of the Ornithorhynchus. But the structure of the ovary and that of the ovum, both before and after it has quitted the ovisac, afford the strongest analogical proof of the intra-uterine development of the embryo, and at the same time accord with the ascertained fact of the mammary nourishment of the young animal.

The kidneys were situated remote from the *pelvis* and high up in the lumbar region.

The situation of the kidneys with respect to each other varied in the two specimens; in the larger one, the left was a little higher than the right; in the smaller one it was a little lower; the latter is the ordinary position in the adult. The supra-renal glands did not correspond with this arrangement, but in both instances the right was higher than the left, agreeing with the relative position of the testes in the male, and the ovaries in the female. In Man the large size of the supra-renal glands is noted as a foetal peculiarity, but in the Ornithorhynchus they are of minute size, their greatest diameter not exceeding one-eighth of a line in the smaller specimen here described; and they increase in size progressively with the growth of the animal, and in a greater proportion than the kidneys, which increase would appear, therefore, to have relation to the development of the generative organs. There were no traces of the *corpora Wolffiana*.

The *testes* in the small male specimen were situated a little below the kidneys: they were of an elongated form, pointed at both ends, with the epididymis folded down, as it were, upon their anterior surface. In the female, the ovaries were freely suspended to the loins in a similar position, the right being at this period as large as the left: it is the persistence of the latter at an early stage of development which occasions the disproportionate size of the two glands in the adult. The still greater inequality of size in the oviducts of the Bird arises, as is well known, from a similar arrest of the development of the one on the right side, but both are equal at an early stage of existence. The uteri were straight linear tubes, scarcely exceeding the size of the ovarian ligaments.

The lungs were found amply developed in both specimens; the air-cells remarkably obvious, so as to give a reticulate appearance to the surface, and a resemblance to the lungs of

a turtle. They had evidently been permeated by air in the smaller specimen.

The heart, in both specimens, was of the adult form, with the apex entire; but the left auricle was proportionately larger than in the adult heart.

The *ductus arteriosus* was here very evident, and formed a filamentary chord in the usual situation between the aorta and pulmonary artery, but proportionately longer than in the true viviparous Mammalia. Here also we have the indication of a more prolonged foetal existence than in the marsupial animals, there being no trace of a *ductus arteriosus* either in the uterine or mammary foetus of the Kangaroo.

The Ornithorhynchus also deviates from the ordinary Marsupialia in having the *thymus* gland. This is situated in front of the great vessels of the heart, and consists of two lobes, of which the right is the largest. The traces of foetal structures presented by these young Ornithorhynchi, and especially the allantoic dilatation of the urachus, indicate that the Monotremata differ from the Marsupialia in a longer continuance of the true foetal or intra-uterine existence.

Mammary organs.—In this section will be adduced the evidence in proof of the essentially Mammalian nature of the Monotremes which the presence and ascertained function of the mammary glands have yielded.

The most important result of Professor Meckel's anatomical investigations of the *Ornithorhynchus* was his discovery of the two large abdominal subcutaneous glands: these he concluded to be the mammary organs, which until that period had been supposed to be absent in the Ornithorhynchus.

Subjoined is the figure which Meckel has given of one of these glands in its natural relative position, *fig.* 198. It measured four inches and a half in length, two inches in breadth, and half an inch in thickness.

From this apparently conclusive evidence of the affinity of the Ornithorhynchus to the Mammalia, Professor Meckel, however, is far from drawing conclusions as to the identity of their mode of generation. For assuming that the difference between the bringing forth of living young and of eggs is really very small and by no means of an essential nature, and remarking that birds have accidentally hatched the egg within the abdomen and so produced a living foetus,—an occurrence which has also been induced by direct experiment, and that, lastly, the generation of the Marsupial animals is very similar to the oviparous mode, he deems it very probable that as the Ornithorhynchus approaches still nearer than the Marsupial animals to Birds and Reptiles, its mode of generation may be in a proportionate degree analogous. For an animal possessing mammary glands he claims, however, the right to rank with the Mammalia, agreeing with Professor Geoffroy only so far as to consider the Monotremata as a distinct order of quadrupeds, which he places, as Cuvier has done, next to the Edentata.

Against this conclusion, however, Professor

Fig. 198.

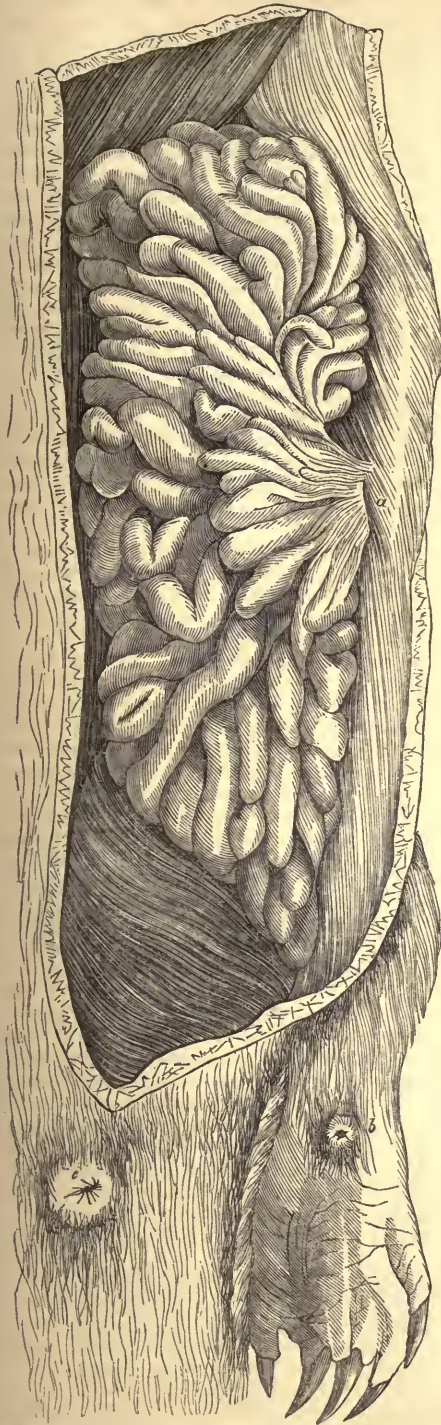

Mammary gland, *Ornithorhynchus*, nearly arrived at full size. (Meckel.)

Geoffroy has argued (*Annales des Sciences Nat.* ix. 1826, p. 457) that the subcutaneous abdominal glands considered by Meckel as mammary, possess none of the characters of a true mammary gland; he states that he examined them with the greatest attention, comparing them with the human mammary glands, and especially with those of Marsupial animals, and that they were of a totally different texture, consisting of a vast number of *cæcums* placed side by side, all directed to the same point of the skin, where *only two* excretory orifices were to be perceived, and these orifices so small that the head of the smallest pin could not be made to enter them. That above all there was no trace of nipples; that in the specimen examined by him, which had the size and appearance of an adult female, the apparatus in question was not more than a fourth part the size of that observed by Meckel. But a mammary gland, Professor Geoffroy observes, when arrived at its full development, occasions an enlargement of all its constituent parts, the nipple acquiring additional bulk even before lactation commences, and that there was no appearance of this kind in the *Ornithorhynchus*. He considers, therefore, these abdominal glands as analogous to those which are situated along the flanks of Salamanders, and still more to the odoriferous glandular apparatus which is concentrated at the sides of the abdomen in the Shrews.

In the absence of direct testimony of the nature of the secretion of the abdominal subcutaneous glands of the female *Ornithorhynchus*, the next obvious step was to test their disputed nature and office by an examination of their periods of increase and functional activity, as compared with those of the ovaria. If these glands had been analogous to the scent-glands of the flanks in the Shrews, and if their secretion had been destined to attract the male to the sexual intercourse, as suggested by Professor Geoffroy, their development ought to have proceeded *pari passu* with that of the ovaria, and the enlargement of both organs ought to have simultaneously reached its maximum. But in specimens in which the ovisacs were enlarged so as to indicate the ova to be ripe for development, I found* that the abdominal glands had made a comparatively slight progress to their full size (fig. 199). This

Fig 199.



Mammary gland, *Ornithorhynchus*, natural size at non-breeding season.

(Owen, *Phil. Trans.* 1832.)

* *Philos. Trans.* 1832, p. 525.

condition was only manifested in the females with ovaria, large indeed, but without prominent ovisacs, and in which the recent corpora lutea were almost absorbed. These facts were established by the dissection of five female *Ornithorhynchi*.

In each of these specimens the mammary gland was composed of between one hundred and two hundred elongated subcylindrical lobes, forming an oblong flattened mass, and converging to a small oval areola in the abdominal integument, which areola is situated between three and four inches from the cloaca, and about one inch from the mesial line. The lobes in the fully developed glands are rounded and enlarged at their free extremities, and measured at that end three or four lines in breadth, and became narrower to about one-third from the point of insertion, where they end in slender ducts. Almost all the lobes are situated at the outer side of the areola, and consequently converge towards the mesial line of the abdomen. Between the gland and the integument the panniculus carnosus (*fig. 199, a*) is interposed, closely adhering to the latter, but connected with the gland by loose cellular membrane. This muscle is here a line in thickness, its fibres are longitudinal, and, separating, leave an elliptical space for the passage of the ducts of the gland to the areola. On the external surface of the skin, when the hair is removed, this areola can only be distinguished by the larger size of the orifices of the lacteal ducts, compared with those for the transmission of the hairs.

Fig. 200.

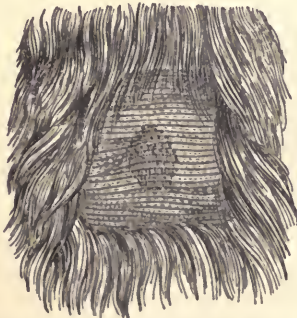

Mammary areola, Ornithorhynchus, natural size.
(*Owen, Phil. Trans. 1832.*)

The orifices of the ducts thus grouped together form an oval spot, which in the female with the largest glands measured five lines in the long and three in the short diameter. In none of the specimens was the surface on which the ducts terminated raised in the slightest degree beyond the level of the surrounding integument.

Meckel was disposed to believe that the ducts terminated on a small eminence about the size of a millet-seed, but did not succeed in demonstrating the fact by injection of the ducts.*

* Meckel writes: "Ductuli excretorii, maxime attenuati, in glandulæ medio extrorsum aperiuntur. Quamvis neque setas, neque mercurium per ductus, et per se, ut monui, angustissimos, et spiritu vini con-

Not any of the specimens of *Ornithorhynchus* examined by me have presented a mammary eminence of any dimensions; on the contrary, I have succeeded in demonstrating the termination of the lacteal ducts on the flat areolar tract. Having in vain attempted to insert the smallest absorbent pipe into the mouths of these ducts, I thrust it into the extremity of one of the elongated lobes, and after a few unsuccessful efforts at length saw the mercury diffuse itself in minute globules through the parenchyma of the lobe, and at a distance of an inch it had evidently entered a central duct, down which it freely ran to the areola, where it escaped externally from one of the minute orifices just described. This process was repeated on most of the lobes with similar results, the greater part of them terminated by a single duct opening exteriorly and distinct from the rest, but in a few instances the ducts of two contiguous lobules united into one, and in these cases the mercury returned by the anastomosing duct and penetrated the substance of the other lobe as freely as that into which the pipe had been inserted.

Some of the lobes injected by the reflux of the mercury through the duct, and of which it was more certain that the glandular structure and not the cellular membrane was filled, were dried, and various sections were submitted to microscopical examination. At the greater extremity they are minutely cellular, the cells communicating with each other, and elongating as the lobule grows narrower, first at the centre, so as to form apparently minute tortuous tubes, which tend towards and terminate in a larger central canal, or receptacle, from which the excretory duct is continued. On making a section of the corium through the middle of the areola the ducts are seen to converge slightly to the external surface, but there is no inverted or concealed nipple at this part, as in the Kangaroo. (*Fig. 201* is a sketch of a magnified view of this section, with the section of one of the dried and injected lobules.)

Thus, prior to and independently of any direct observation of the secretion of the abdominal glands, the anatomical facts brought to bear upon their disputed function were indubitably more favourable to the opinion of the German than of the French Professor; for, 1st, the glands are confined to the female, and vary in degree of development at different periods in individuals of equal size, attaining in some an enormous development; 2nd, the secretion is conveyed outwardly by means of numerous long and narrow ducts,

tractos, et fluido concreto repletos, trajicere poterim, area tamen indicator in cute. Quamvis pili hanc partem tegant, apparet tamen, hos si abstuleris, plaga, quinque circiter lineas longa, tres lata, foraminulis, iis, e quibus pili egrediuntur, majoribus, nigris, circiter octoginta stipata, forsan ductuum excretorium orificiis. Præterea in hujus modo depressiuncula duarum linearum diametri adest, pilis destituta, sed eminentiunculis inæqualis, inter quas præcipue una, nulli granum haud æquans, reliquas antecellit. Hæ sine dubio papillæ et ductuum orificia sunt."—*Loc. cit.* p. 54.

Fig. 201.

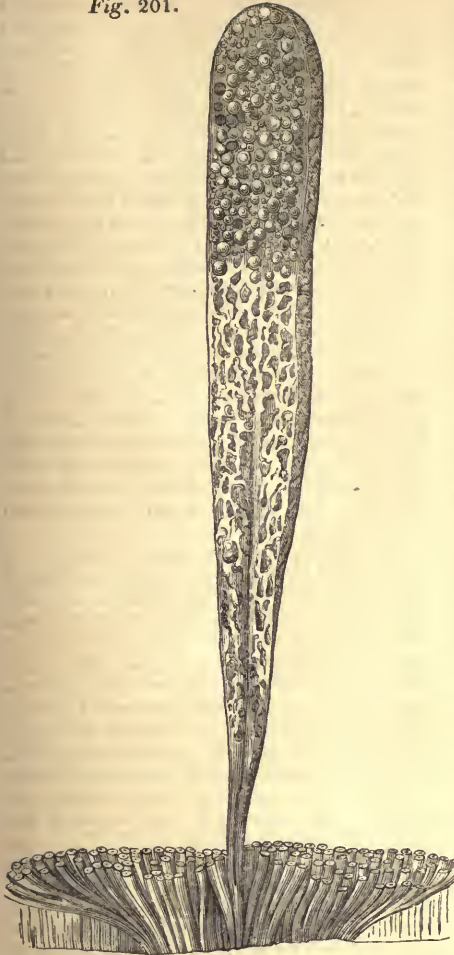

Terminal ducts, and lobe of mammary gland, injected;
twice natural size.

strongly implying its fluid nature, and most contrary to the mode in which odorous substances are excreted; 3rd, the excretory orifices are by no means extended over so wide a space, in proportion, as in the Shrew, but collected into a point which we know to be not disproportionate to the size of the mouth of the young animal, and this point is situated in a part of the body convenient for the transmission of a lacteal secretion from the mother to her offspring.

Compared with an ordinary mammary gland, that of the Ornithorhynchus differs chiefly in the absence of the nipple, and, consequently, of the surrounding vascular structure necessary for its erection. But the remarkable modification of the mouth in the young Ornithorhynchus removes much of the difficulty which previously attached itself to the idea of the possibility of an animal with a beak obtaining its nutriment by suction. The width of the mouth in the smallest observed Ornithorhynchus corres-

ponds with the size of the mammary areola; and the broad tongue, extending to the apices of the broad, short, and soft jaws, with the fold of integument continued across the angle of the mouth, are all modifications which prepare us to admit such a co-adaptation of the mouth of the young to the mammary outlet of the parent, as, with the combined actions of suction in the recipient, and compression of the gland in the expellent, to effect this essentially Mammalian mode of nourishment.

We may presume that a corresponding modification of the mouth of the new-born animal obtains in the Echidna, since the mammary glands in this Monotreme* correspond in structure, and mode of termination of the excretory ducts, with those of the Ornithorhynchus.

As yet the secretion of the mammary glands of the Echidna has not been observed; but that of the Ornithorhynchus has been detected not only in the stomach of the young (*ante* p. 401), but oozing from the lacteal pores of the female, and by more than one competent observer.† Mr. George Bennett, describing his dissection of a female Ornithorhynchus shot at Muddoona, New South Wales, on the 14th of November, the day before his arrival at that place, and which “had evidently just produced her young,” and had very large mammary glands, thus records his observation of their secretion. “The glands were very vascular on the surface, the mammary artery ramifying over them in a most beautiful and distinct manner. The fur still covered that portion of the integument on which the ducts terminated, and there was no appearance of a projecting nipple.” “How different was the appearance in the recent state of this mammary gland from that which I had previously seen at the Royal College of Surgeons, in a specimen long preserved in spirits, in which I had the opportunity of witnessing the injection of the ducts with mercury by my friend Mr. Owen, the mercury exuding, as I have seen the milk from the similar ducts, upon the integuments.”—*Zoological Transactions*, vol. i. p. 251. In a female Ornithorhynchus, which with her two full-furred young were captured alive by Mr. Bennett on the 28th of December, he says, “The milk that could be expressed from the glands was but trifling in quantity; and, in the mother of these young animals, such would have been expected to be the case, for they were capable of feeding upon more substantial diet.”—*Ibid.* p. 254.

Crural gland and spur.‡—This remarkable

* See Phil. Trans. 1832, p. 537, pl. xvii., figs. 2 and 3.

† Hon. Lauderdale Maule, Proc. Zool. Society, part ii. p. 145. G. Bennett, Esq. ib. part i. p. 82. Part ii. p. 141-11.

‡ Meckel, loc. cit. p. 54, calls this peculiar sexual gland ‘femoral,’ observing, “ne ipso nomine de functione judicium proferam, forsitan retrahendam, hoc nomen à situ impono.” As, however, the femoral position is peculiar to the Ornithorhynchus, the gland being popliteal in the Echidna, I prefer a name derived from the word ‘crus,’ which has a more extended signification to the whole hinder extremity.

apparatus in the Monotrematous quadrupeds must be classed with the accessory organs of generation in the same category with the antlers of Deer, the spurs of the Cock, the claspers of the Shark, and other peculiar characteristics of the male sex. It has been already shown, in the description of the young *Ornithorhynchus*, that the external parts of the apparatus are not so developed as to distinguish the sex at that immature period; a small spur, concealed in a cavity or socket of the integument covering the heel, the bottom of which closely adheres to the accessory tarsal ossicle, exists in both sexes; a magnified view of the part in the young female is given at *fig. 197*. As the young animal advances to maturity the cutaneous socket increases in width and depth in the female, but without any corresponding growth of the rudimentary spur, of which in aged female *Ornithorhynchi* sometimes no trace remains. In the male *Ornithorhynchus* the tarsal spur soon begins to rise above the socket, and finally attains a length of ten lines with a basal breadth of five lines, apparently everting the tegumentary socket in the progress of its growth. The spur (*fig. 173, k, e; fig. 202, e*) consists of a firm semitransparent horn-like substance: it is conical, slightly bent, and terminated by a sharp point; its base is expanded, and notched at the margin for the implantation of the ligaments which connect the spur with the accessory flat tarsal bone (*os basilare*, Meckel,) (*fig. 173, k, d; fig. 202, d*.) The base of the spur is covered by a thin vascular integument. The spur is traversed by a canal which commences at the centre of the base and terminate, by a fine longitudinal slit, about one line distant from the point, closely resembling in this respect the canal that traverses the poison fang of the venomous snake.* Like that canal also the spur of the male Monotreme is subservient to the transmission into the wounds it may inflict of the secretion of a peculiar gland.

This gland (*a, fig. 202*) is situated in the *Ornithorhynchus* at the back part of the thigh, between the femur and the long process from the head of the fibula, covered by the integu-

Fig. 202.



Crural gland and spur,
male *Ornithorhynchus*.
(Meckel.)

ment and the cutaneous muscle. It is of a triangular or reniform figure, convex above, concave below, or towards the leg; from twelve to fourteen lines in length, seven or eight lines broad, and three or four lines thick, with a smooth exterior, invested by a thin capsule, on the removal of which the gland may easily be divided into a number of small lobes. Its intimate structure, as displayed by a successful injection of mercury, is minutely cellular, like that of the glandula Harderi of the hare or goose, but with the ultimate secrening cells more minute; the excretory duct is continued from the concave side of the gland, and small clusters of vesicles are developed from parts of its expanded commencement.* The duct, (*fig. 180, L*.) which is about a line in width and with pretty strong tunics, descends straight down the back of the leg, covered by the flexor muscles and posterior tibial nerve, to the posterior part of the tarsus, where it suddenly expands into a vesicle (*b, fig. 202*) about three lines in diameter; the vesicle is applied to the base of the spur, and a minute duct (*c, fig. 202*) is continued from it into the canal which traverses the spur.

The tarsal perforated spur and its glandular apparatus are both relatively smaller in the male *Echidna* than in the *Ornithorhynchus*. The gland is situated lower down, in the popliteal region, between the insertions of the deep-seated fasciculi of the adductor femoris and the origins of the gastrocnemius; it is of subspherical form, about the size of a pea, with a smooth exterior; the excretory duct, wide at the commencement, soon contracts into a filamentary canal, which again enlarges to form a small reservoir for the secretion just above the base of the spur.

The true nature and use of this apparatus has not yet been determined. Its close analogy with the poison apparatus in other animals obviously suggests the idea of a corresponding function, but no well authenticated case of symptoms of poisoning consequent upon a wound inflicted by the spur has been recorded. It seems on the contrary that the *Ornithorhynchus* possesses not the instinct of availing itself of a weapon so formidable, as upon this theory the spur must be, when attacked or annoyed. Mr. George Bennett tried the following experiment with a full grown wounded but lively male *Ornithorhynchus*:—"I commenced by placing my hands in such a manner, when seizing the animal, as to enable it, from the direction of its spurs, to use them with effect; the result was that the animal made strenuous efforts to escape, and in these efforts scratched my hands a little with the hind claws, and even, in consequence of the position in which I held it, with the spur also. But although seized so roughly, it neither darted the spur into my hand nor did it even make an attempt so to do. As, however, it had been stated that the creature throws itself on the back when it uses this weapon, (a circumstance not very

* De Blainville in Bulletin de la Société Philomathique, 1817.

* Müller, De Glandularum penis. Struct. p. 43, tab. ii. fig. 10.

probable to those who have any knowledge of the animal,) I tried it also in that position; but though it struggled to regain its former posture, no use was made of the hind claw. I tried several other methods of effecting the object I had in view; but as all proved futile, I am convinced that some other use must be found for the spur than as an offensive weapon. I have had several subsequent opportunities of repeating the experiments with animals not in a wounded state, and the results have been the same.*

Evidence to a like effect is given by the zoologists of the French expedition in the Astrolabe, in reference to the male Echidna.† An objection to the theory of the spur and gland being a defensive apparatus is their absence in the female.

Since then this apparatus forms a sexual character, it may be presumed that its function is connected with that of generation. Whether the spur be a weapon for combat among the males,—or, like the spiculum amoris of the Snail, be used to excite the female, the injected secretion being an additional stimulus,—or whether the spur be mechanically useful in retaining the female during the coitus,—are conjectures which must be verified or disproved by actual observation.

BIBLIOGRAPHY.—*Shaw*, Naturalists' Miscellany, 1798. General Zoology, vol. i. 1800. *Blumenbach*, Philos. Transactions, 1800; and *Voigt's Magazin für den neuesten Zustand der Naturkunde*, Band 2, 1800. *Home*, Philos. Transactions, 1802, pp. 67 and 356. *Ibid.* 1819. Lectures on Comparative Anatomy, passim. *Cuvier*, Leçons d'Anatomie Comparée, 1799-1805, passim. *Osmemans Fossiles*, 4to. vol. v. 1823. *Peron and Lesueur*, Voyage de découvertes aux Terres Australes, 1807. *Meckel*, Beiträge zur Vergleichenden Anatomie, 1808. *Froriep's Notizen*, 1824. *Ornithorhynchi paradoxo descriptio anatomica*, fol. 1826. *De Blainville*, Dissertation sur la place que la famille des Ornithorynques et des Echidnés doit occuper dans les séries Naturelles, 4to. 1812. Bulletin de la Société Philomathique, 1817. *Nouvelles Annales du Muséum*, tom. ii. 1832. *Geoffroy St. Hilaire*, Anatomie Philosophique, tom. i. 1818. Mémoire sur les Glandes Abdominales des Ornithorynques faussement présumées mammaires, lesquelles secrètent, non du lait, mais du mucus, &c. Gazette Médicale de Paris, 1833. Sur des Glandes Abdominales chez l'Ornithorynque dont la détermination, comme mammaires, fut en Allemagne, et est de nouveau en Angleterre un sujet de controverse, 8vo. 1833. *Rudolphi*, Abhandlungen der Berliner Akademie der Wissenschaften, 1829. *Jaffé*, Thesis inaug. de Ornithorhyncho paradoxo, Berlin, 1823. *Trill*, Edinburgh Philos. Journal, 1822. *Hill*, Linnæan Transactions, vol. xiii. 1822. *Knox*, Wernerian Transactions, vol. v. *Van der Hoeven*, Nova Acta Physico-Medica, tom. xi. 1823. *Pander and D'Alton*, Skelete der zahnlosen Thiere, 1825. *Grant*, (*Dr. R.*) Annales des Sciences Naturelles, 1829, tom. xviii. *Müller*, De Glandularum Scercentium Structurâ penitiori, fol. 1830. *Owen*, Philos. Transactions, 1832, 1834. Proceedings of the

Zoological Society, October, 1832, March, 1833. Zoological Transactions, vol. i. 1834. *Bennett, G.* Zoological Transactions, 1834. *Eydoux & Laurent*, Voyage de la Favorite, 1836, 8vo.

(*R. Owen.*)

MONSTROSITY.—See TERATOLOGY.

MOTION ANIMAL, ANIMAL DYNAMICS, LOCO-MOTION, OR PROGRESSIVE MOTION OF ANIMALS.—Amongst the infinite number of objects presented by the Deity to our contemplation in the sublime spectacle of the universe, there are none, relating to the economy of animal life, more important in their consequences, more calculated to awaken inquiry, or deserving of more profound research, than the phenomena of progressive motion in man and animals.

Life, in virtue of which animated beings possess sensation and exhibit the play of the vegetative functions, endows the muscular system with contractility, and is the fundamental cause of all the motor power of animals.

The theory of the progressive motion of animals presents a most extensive field for anatomical and physiological inquiry, far too extensive indeed for the space here allotted to this subject; it will therefore be treated only in outline. The automatic, and several of the voluntary motions which belong to the vegetative functions of the animal economy, though derived from the same source as those of progressive motion, will not be included in this investigation.

The theory of locomotion relates to those mechanical functions by which animals are capable of changing their relative positions or distances with respect to surrounding objects supposed to be stationary or fixed.

The locomotive organs of the higher animals are composed of a system of levers of various forms, orders, and dimensions, so united or articulated at the joints as to give them the requisite mobility as well as direction of motion. The fulcra to these levers are the earth, the air, or the water; the active agents of motion are the muscles which constitute a complex system of contractile organs, firmly attached to the levers, whereof the points of connexion, amount of contraction, and direction of force, communicate to the levers, to which they are firmly attached, all the movements necessary for progression.

The progression of some animals, such as the Annelida and Ophidian Reptiles, is effected by the alternate contraction or flexion and elongation, or by undulatory movements of the body; in others, as Bipedes, Quadrupeds, Fishes, Birds, &c., by the alternate approximation and angular separation of the levers which form the organs of progression. These principles apply to animals, whether their levers are represented by wings, fins, or legs, and whether the progression is effected on solids, in water, or in the air.

The various modes of animal progression

* Zoological Transactions, vol. i. p. 236.

† “ Nous n'avons point entendu parler d'accident occasionné par cette pique, et nous-mêmes nous avons touché, irrité cet Echidné sans qu'il ait jamais cherché à se servir de son arme, pas même lorsque nous exerçons sur elle une assez forte pression.”—Zoologie du Voyage de l'Astrolabe, p. 124.

are swimming, flying, crawling, climbing, leaping, running, walking, &c. The consideration of these diversified methods of progression involves the theory of the motion of bodies in general, of the lever, the pulley, the centre of gravity, specific gravity, and the resistance of fluids, &c.; and, as we shall have occasion for constant reference to the mechanical principles connected with these subjects, they will be first discussed; but for the convenience of those who are unacquainted with the algebraic method of computation and analysis, the latter will generally be separated from the text.

Fundamental Axioms.—First, every body continues in a state of rest or of uniform motion in a right line until a change is effected by the agency of some mechanical force. Secondly, any change effected in the quiescence or motion of a body is in the direction of the force impressed, and is proportional to it in quantity. Thirdly, reaction is always equal and contrary to action, or the mutual actions of two bodies upon each other are always equal and in opposite directions.

Thus if M (*fig. 203*) be a particle of matter free to move in any direction, and if the lines MA, MB, represent the intensity of two forces

Fig. 203.

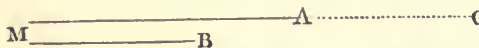

acting on it in the direction MC, the particle M will move towards C by the combined action of the two forces, and it will require a force in the direction of CM, equal to MA + MB to keep it in a state of rest: but if MA and MB (*fig. 204*) represent the intensities and directions of two forces acting on the particle M in opposite directions, if MA be

Fig. 204.



greater than MB, the particle M will be moved towards A by the difference of these two forces, and it will require a force equal to that difference to keep it at rest.

The composition and resolution of forces.—In the composition of forces it is proposed to find the resultant, arising from any number or system of forces acting upon a given point. The resolution of forces, which is the converse of the former process, consists in discovering what forces acting in given directions would combine to produce a given resultant: Thus, if there be two forces F F' (*fig. 205*), whose directions and magnitudes are represented by FN, F'N, and if FR, F'R be drawn respectively parallel to F'N, FN, then by the composition of forces we find the magnitude and direction of the equivalent or resultant of these two forces to be RN, and conversely it may be resolved into a pair of forces as RF, RF' represented by the adjacent sides of any parallelogram, of

Fig. 205.

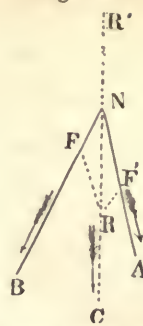

which RN is the diagonal, and consequently into an indefinite number of such pairs.* This construction is called the *parallelogram of forces*.

The resultant of any number of forces meeting in a common point may be ascertained thus: first, let the resultant of any two forces be found as before, and substitute this one force for the two components producing it; then combine this new force with one of the remaining forces, and continue this process until all the forces are reduced to a single force, which is the resultant sought. The following geometrical solution will render the subject more apparent: let P, P', P'', &c. (*fig. 206*) represent a number of forces meeting in the common point A, and let AP, AP', AP'' be proportional to these forces respectively: through P draw PR equal and parallel to AP', and through R draw RR' equal and parallel to AP'', and through R' draw R'R'' equal and parallel to AP'''; join AR'', which represents the resultant of the four forces AP, AP', AP'', AP'''. A similar operation will serve for any number of forces. This figure is denominated the *polygon of forces*. If the directions of three forces are rectangular, and in different planes, the resultant may be found as follows: let PC, PC', PC'', (*fig. 207*) be the intensities and directions of three forces, complete the parallelepiped BD; then the forces PC, PC' have P r for an equivalent, therefore P r may be substituted for these two forces; and by compounding the forces PC'', P r, we get PR the diagonal of the parallelepiped BD r for an equivalent to the three forces. This construction is called the *parallelepipedon of forces*.†

An equilibrium cannot subsist between any two forces acting upon a point of matter, if the lines representing the directions of the forces be inclined to each other at any angle; but a third force, equivalent to their resultant and in an oppo-

* Vide Gregory, vol. iii. ch. ii. p. 23.

† From the same construction the resultant of a system of forces may be found, disposed in different planes by the method of rectangular co-ordinates: let PC = x, PC' = y, PC'' = z, (*fig. 207*), by the 47 Euc. Lib. I. we have $Pr^2 = PC^2 + C'r^2 = x^2 + y^2$, and $PR^2 = Pr^2 + rR^2 = x^2 + y^2 + z^2$, whence the resultant $PR = \sqrt{x^2 + y^2 + z^2}$. The position of the resultant is thus determined; let r, r', r'' denote the unknown angles formed by the direction of the resultant with each of the co-ordinates, and R cos. r, R cos. r', R cos. r'' will represent the equivalents of the resultant in the several directions of the axes, hence we have R cos. r = x, R cos. r' = y, R cos. r'' = z, &c.

$$\text{Cos. } r = \frac{x}{R}, \text{ cos. } r' = \frac{y}{R}, \text{ cos. } r'' = \frac{z}{R}.$$

site direction to it, will produce an equilibrium.

Fig. 206.

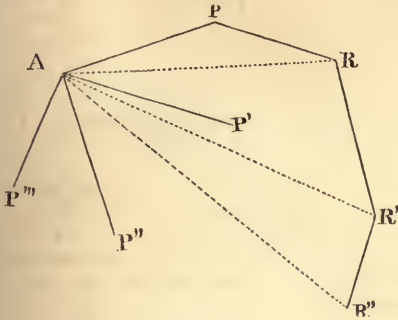

Let N (fig. 205) be the point acted upon by any two forces NF , NF' , which form an angle FNF' , and the line NR their resultant, which will draw the point in the direction NR . But if a third force NR' , equal and opposite to NR , be applied, it will destroy the motion in NR , and the point N will remain at rest by the simultaneous action of the three forces NR' , NF , NF' .

Fig. 207.

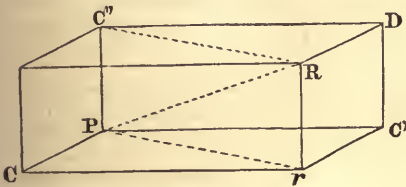

Centre of gravity.—The centre of gravity of any body is a point about which, if acted upon only by the force of gravity, it will balance itself in all positions; or, it is a point which, if supported, the body will be supported however it may be situated in other respects; and hence the effects produced by or upon any body are the same as if its whole mass were collected into its centre of gravity.

Fig. 208.

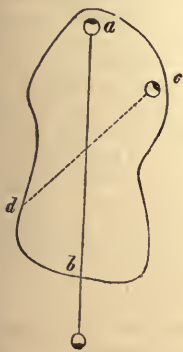

intersecting ab in c , the point c will be the centre of gravity of the plane.

To find the centre of gravity of any plane body mechanically, let the plane $a e d b$ (fig. 208) be suspended freely by a string from the point a , to which a plumb-line ab is also attached—the latter will coincide with the vertical line ab , which is to be marked with a pencil: then suspend the plane and plumb-line from a second point e , when the plumb-line will hang vertically in the line ed , intersecting ab in c , the point c will be the centre of gravity of the plane.

To find the distance of the head and feet from the centre of gravity of the human body in a horizontal position; balance the body placed upon a plane ab on a triangular prism de , as in fig. 209; then draw a line on the plane

Fig. 209.

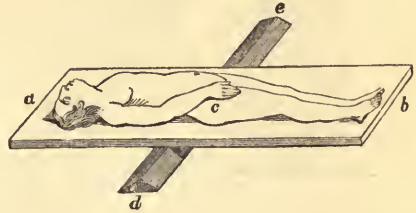

close to the edge of the prism; again balance the body in another position and draw a line as before, the vertical line passing through c , the intersection of these lines will pass through the centre of gravity.

After the plan of Borelli, Weber balanced a plank across a horizontal edge, and stretched upon it the body of a living man: when the whole was in a state of equilibrium, in which the method of double weighing was adopted, by accurate measurements he found the total length of the body

	m.m.	in.
the distance of the centre of gravity below the vertex	= 1669.2	= 65.30853
above the sole of the foot	= 721.5	= 28.406455
above the transverse axes of the hip-joints	= 947.7	= 37.310949
above the promontory of the sacrum	= 87.7	= 3.454729
	= 8.7	= 0.341519

As the horizontal plane of the centre of gravity lies between three-tenths and four-tenths of an inch above the promontory of the sacrum, it must traverse the sacro-lumbar articulation which is intersected by the mesial plane, because the body is symmetrical, and by the transverse vertical plane, the sacro-lumbar articulation must, therefore, contain the common point of intersection of all three planes, which coincides with the position of the centre of gravity of the body when standing; but this point varies in different individuals in proportion to the difference of the weight of the trunk to that of the legs, as well as by any change of the position of the limbs.

The centres of gravity of particular figures may be found geometrically and analytically, as shewn in mechanical treatises; but these methods require computations too detailed for our limits.

The attitudes and motions of every animal are regulated by the positions of their centres of gravity, which, in a state of rest and not acted on by extraneous forces, must lie in vertical lines which pass through their bases of support. Thus, if g (fig. 210, A and B) be the common centre of gravity of two bodies whose respective centres of gravity are g , H , in A

the whole mass will be supported, whilst in B it will fall over on the side of H.

A Fig. 210. B

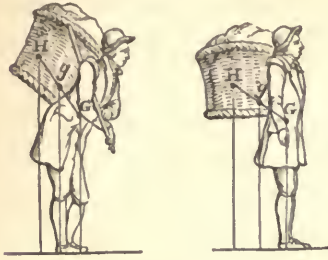

In most animals moving on solids, the centre is supported by variously adapted organs; during the flight of birds and insects it is suspended; but in fishes, which move in a fluid whose density is nearly equal to their specific gravity, the centre is acted upon equally in all directions.

The lever.—Levers are commonly divided into three kinds, according to the relative positions of the prop or fulcrum, the power, and the resistance, or weight. The straight lever of each order is equally balanced when the power multiplied by its distance from the fulcrum equals the weight, multiplied by its distance, or P the power, and W the weight, are in equilibrium when they are to each other in the inverse ratio of the arms of the lever, to which they are attached: the pressure on the fulcrum however varies.

In straight levers of the *first kind*, the fulcrum is between the power and the resistance, as in *fig. 211*, where F is the fulcrum of the

Fig. 211.



lever AB; P is the power, and W the weight or resistance. We have $P : W :: BF : AF$, hence $P \cdot AF = W \cdot BF$, and the pressure on the fulcrum is both the power and resistance, or $P + W$.

In the second order of levers (*fig. 212*) the resistance is between the fulcrum and the power; and, as before, $P : W :: BF : AF$, but the pressure of the fulcrum is equal to $W - P$, or the weight less the power.

Fig. 212.

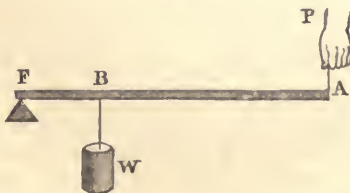

In the third order of lever the power acts between the prop and the resistance (*fig. 213*),

Fig. 213.

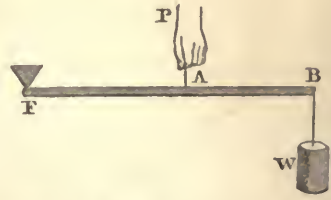

where also $P : W :: BF : AF$, and the pressure on the fulcrum is $P - W$, or the power less the weight.

In the preceding computations the weight of the lever itself is neglected for the sake of simplicity, but it obviously forms a part of the elements under consideration, especially with reference to the arms and legs of animals.

To include the weight of the lever we have the following equations: $P \cdot AF + AF \cdot \frac{1}{2} AF = W \cdot BF + BF \cdot \frac{1}{2} BF$; in the first order where AF and BF represent the weights of these portions of the lever respectively. Similarly, in the second order $P \cdot AF = W \cdot BF + AF \cdot \frac{AF}{2}$, and in the third order $P \cdot AF = W \cdot BF + BF \cdot \frac{BF}{2}$.

In this outline of the theory of the lever, the forces have been considered as acting vertically, or parallel to the direction of the force of gravity.

The head moving backwards and forwards on the atlas acts on the principle of the first kind of lever, the fulcrum being placed between the power and the resistance. The tibia resting on the astragalus acts on the principle of the second order of lever, when the heel is raised by the tendo Achillis, the resistance being between the power and the fulcrum, or between the heel and the toes.

In lifting a weight by the hand and bending the elbow-joint, as in *fig. 214*, in which p the power, or biceps muscle is inserted at a between the fulcrum f , and the resistance w or b , we act on the principle of the third order of lever.

In the latter case, however, the power, instead of acting vertically, is applied obliquely, and the lever, instead of simply resting on the fulcrum, turns upon a point at f , *fig. 214*. Instead, therefore, of estimating the values of p and w as before, according to their reciprocal distances from the fulcrum, we resolve each of them into two other forces by perpendiculars drawn from the fulcrum f to the directions of the forces p and w . Thus, in *fig. 214*, p will not be to w as $b f$ to $a f$, but as the perpendiculars from f on the vertical line through b to that on $a c$ the direction of the insertion of the muscle.

The pulley.—The principles of the simple pulley are introduced into the mechanism of animals for the production of motion, and to change the directions of the motions of several organs in reference to that of the tendons

Fig. 214.

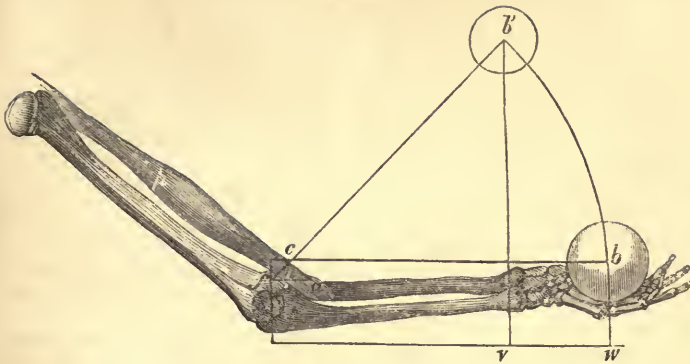

moving them. There are no examples of the compound pulley in animal structures.

We recognise the simple pulley in the transmission of the tendons of the peronei muscles through the groove of the external malleolus of the human ankle-joint, in the tendon of the obturator internus gliding through the groove in the os ischii, in the tendon of the circumflexus palati passing through the hamular process of the sphenoid bone, in the tendon of the obliquus superior gliding through the ring attached to the frontal bone, and in several other instances where a change of the directions of the limbs results from tendons passing over joints, through grooves in bones, or under ligaments, by which the muscles are capable of producing effects on distant organs without disturbing the symmetry of the body, an effect which, owing to the limited power of contraction in the muscles, could be accomplished in no other way.

Of uniform motion.—If a body move constantly in the same manner, or if it pass over equal spaces in equal periods of time, its motion is uniform. The velocity of a body moving uniformly is measured by the space through which it passes in a given time.*

The velocities generated or impressed on different masses by the same force are reciprocally as the masses.†

Motion uniformly varied.—When the motion of a body is uniformly accelerated, the space it passes through during any time whatever is proportional to the square of the time.

In the leaping, jumping, or springing, of animals in any direction, (except the vertical,) the paths they describe in their transit from one point to another in the plane of motion are parabolic curves.

The legs move by the force of gravity as a

* Thus if v be the space passed over by the body in an unit of time, that space x by t , or $t v$ will be the space s passes over in t units, that is,
 $s = t v$ (1).

† If a force communicates a velocity v to a mass m , and a velocity v' to a mass m' , then we have
 $mv = m'v'$ (2).

Generally, if f be the accelerating force, the space
 $s = \frac{1}{2} ft^2$ (3).

and
 $s = \frac{tv}{2}$ (4).

pendulum.—To the many instances already recognised of the connexions subsisting between the functions of living animals and the physical sciences, another remarkable contribution has been recently added by the Professors Weber, whose experimental researches satisfactorily demonstrate that the swinging forwards of the legs of animals in progressive motion obeys the same laws as those of the periodic oscillations of the pendulum. In order to ascertain these relations, MM. Weber instituted a series of experiments upon legs of given lengths, both in the living and dead subject, and under variously modified circumstances. Having removed a leg from the trunk at the hip-joint, and suspended it by a short thread that it might move as if upon the axis of the head of the femur; upon giving it an impulse they found it oscillated nearly in the same time as in the living state. They next communicated a vibratory motion to a leg suspended to the acetabulum by the ligaments of the hip-joint only, the muscles having been previously cut through: in this experiment the oscillatory movements were rather less than in the preceding. The oscillations of the leg of a dead person after the rigidity of the muscles had subsided, were still further diminished. On comparing the durations of the vibrations of the legs in these several states with those of the living, they found their periods nearly equal or in the following proportions.

No.	Length of leg. in metres.*	Half duration of oscillation.	
1	0.831	0.370	An exarticulated freely suspended leg. The same. { A leg suspended to the trunk by the ligaments only, the muscles of the hip-joint having been cut through. { A leg of the dead body in its natural state. { A living leg swinging uninfluenced by the action of muscles. { A living leg walking on the heel. { A living leg walking on the ball of the foot.
2	0.866	0.371	
3	0.831	0.355	
4	0.831	0.355	
5	0.860	0.346	
6	0.860	0.322	
7	0.860	0.323	

* A metre = 3.2808992 feet.
 A millimetre = 0.03937 inch.

From this table it appears conclusive that no muscular force is employed or required to propel the leg forwards after it has been raised and bent by the flexor muscles, and that the force of the earth's gravity alone on the leg is sufficient to accomplish that purpose. The difference found between the oscillation of the legs in the living and the dead body is very small, and is attributed by those authors to the elasticity of the ligaments connecting the leg to the trunk, and some trifling differences in the length of the legs, but decidedly not to muscular action. An application of the principles of the pendulum to the legs of animals moving in a vertical plane shows that the durations of their periodic oscillations must be respectively as the square roots of their lengths,* estimated by the distance of the centre of oscillation; or the time of a complete oscillation of any leg from behind forwards when influenced only by gravity is to the time in which a heavy body would fall through half the length of the leg, considered as a compound pendulum, as the circumference of a circle is to its diameter.

It further results from the periodic movements of the legs being subordinate to the force of gravity, that the same individual would necessarily walk slower as he approached the equator, and quicker as he approached the poles, all other circumstances being equal. For example, let us suppose any two persons to be walking in different latitudes, whose legs are of unequal length, and acted on by unequal gravitating forces, then by the theory of the pendulum the time of the swinging forward of their legs respectively will be as the square roots of their lengths directly and as the square roots of the gravitating forces in those latitudes inversely.†

Mechanical effects of fluids on animals immersed in them.—When a body is immersed in any fluid whatever, it will lose as much of its weight relatively as is equal to the weight of the fluid it displaces. In order to ascertain whether an animal will sink or swim, or be sustained without the aid of muscular force, or to estimate the amount of force required that the animal may either sink or float in water, or fly in the air, it will be necessary to have recourse to the specific gravities both of the animal and of the fluid in which it is placed.

The specific gravities or comparative weights of different substances are the respective weights

* Let l and l' equal the lengths of any two pendulums, t & t' the times of vibrations, g the force of gravity, π to 1: the ratio of the circumference of a circle to its diameter, then

$$t = \pi \sqrt{\frac{l}{g}} \text{ and } t' = \pi \sqrt{\frac{l'}{g}},$$

$$\therefore t : t' :: \sqrt{l} : \sqrt{l'} \dots \dots (5.)$$

† For as $t = \pi \sqrt{\frac{l}{g}}$, and $t' = \pi \sqrt{\frac{l'}{g}}$,

$$\text{hence } t : t' :: \sqrt{\frac{l}{g}} : \sqrt{\frac{l'}{g}} \dots \dots \dots (6.)$$

of equal volumes of those substances.* When any solid body is immersed in a fluid and left to itself, it will sink if its specific gravity is greater than that of the fluid; but if its specific gravity be less than that of the fluid, it will rise to the surface and be sustained there; and when the specific gravity of the solid and fluid are equal, the body will remain stationary wherever it is placed. When the weight of any body taken in a fluid is subtracted from its weight out of the fluid, the difference is the weight of a volume of the fluid equal to that of the solid; this is to its weight in air, as the specific gravity of the fluid to that of the solid; so that generally the specific gravities of solid bodies are as their weights in the air directly, and their losses in water or any other fluid inversely.†

The specific gravity of air, water, and mercury, when the barometer stands at 30 in. and the thermometer at 55°, being to each other as 13, 1000, 13600, it results that all those animals whose specific gravities approximate to that of water are nearly 1000 times heavier than air, and more than thirteen times lighter than mercury, and consequently animals that would sink and perish in water could walk on the surface of mercury.

The human body in a healthy state, with the chest filled with air, is specifically lighter than water, and its sinking generally depends upon the air in the lungs escaping under the pressure of water upon its immersion. Dr. Arnett remarks that if this truth were generally and familiarly understood, it would lead to the saving of more lives than all the mechanical life-preservers which man's ingenuity will ever contrive.

Atmospheric pressure produces a great variety of mechanical effects on animal structures. If we estimate the surface of a man to be equal to 2000 square inches, the pressure of the atmosphere on his body with the barometer at 30 in. will amount to 30,000 lbs., or about 15 tons; when the barometer falls from 30 to 27 inches, the pressure is reduced from 15 to 13½ tons; we need not, therefore, be surprised that variations of atmospheric pressure should be attended with corresponding sensations in living animals.

The pressure of the atmosphere enables some animals (as we shall subsequently prove) to fix themselves to rocks with great force, to walk up the surfaces of glass windows, to sustain themselves in an inverted position on the

* If W, w are the weights of two substances, V, v their volumes, S, s their specific gravities, then

$$S : s :: \frac{W}{V} : \frac{w}{v}.$$

† Let W = the weight of the body in air, W' = its weight in water or any other fluid, S = the specific gravity of the solid, s = the specific gravity of the fluid, then we shall have the following proportions;

$$W - W' : W :: s : S;$$

$$\text{hence } s = \frac{W - W'}{W} S \dots \dots \dots (7.)$$

$$\text{and } S = \frac{W}{W - W'} s \dots \dots \dots (8.)$$

ceilings of rooms in opposition to the force of gravity, and to hold the mechanism of the joints together with a force proportional to their respective areas.

The air being elastic, its density decreases as the elevations above the earth's surface increase, and when the heights increase in an arithmetical progression the densities decrease in a geometrical progression; hence, in the flight of birds, the weight of air which they displace, and the effective force of their wings must continually vary with every change of elevation.

Animals moving in water at various depths are not subjected to the same variations of density that are experienced in air, since water, being nearly incompressible, suffers no sensible change of volume at the greatest depths of the ocean; but although the density remains nearly constant, the pressure increases with the depth, being equivalent to about one pound on the square inch for every two feet. The specific gravity of water being from 800 to 1000 times greater than air, its pressure becomes very great at the known depths to which many fishes and cetaceous animals descend.

Resistance of fluids.—Animals moving in air and water experience in those media a sensible resistance, which is greater or less in proportion to the density and tenacity of the fluid, and the figure, superficies, and velocity of the animal.

An inquiry into the amount and nature of the resistance of air and water to the progression of animals will also furnish the data for estimating the proportional values of those fluids acting as fulcra to their locomotive organs, whether they be fins, wings, or other forms of lever.

The motions of air and water, and their directions, exercise very important influences over velocity resulting from muscular action.

The resistance of a plane moving perpendicularly to itself in a fluid, equals the weight of a column of the fluid of which the base is equal to the plane, and the altitude to the depth through which a body would fall to acquire by gravity the velocity of the plane.*

If the direction† of the motion, instead of being perpendicular to the plane, as before supposed, be inclined to it at any angle, the

* Let a represent the area of the plane, v the velocity, p the specific gravity of the fluid, then the height due to the velocity being $\frac{v^2}{2g}$, the whole resistance is

$$a p \frac{v^2}{2g} \dots \dots \dots (9.)$$

hence, cæteris paribus, the resistance is as the square of the velocity.

† Let AB (fig. 215) be the plane, and nD the direction of its motion, $\angle ABD$ the angle whose sine is s , the number of particles which strike the plane, as well as the force of each particle, will be diminished in the ratio of 1 to s , therefore the whole resistance will be diminished in the ratio of 1 : s^2 , but the effective part of the resistance being perpendicular to the plane, the whole resistance in the direction AE is to the effective part in the direction BE perpendicular to AB , as AE and BE ,

resistance will be diminished in the *triplicate* ratio of the sine of the angle of inclination.

Fig. 215.

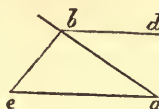

When a body is terminated by a curved surface generated by the revolution of a plane round its axis, and moves parallel to that axis, the amount of resistance may be obtained by the formulae and analysis subjoined.*

Fig. 216.

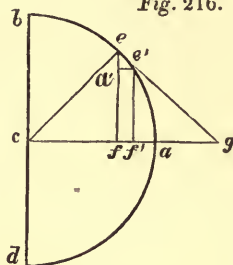

But the forms of animals, though symmetrical, can rarely be considered as mathematically regular figures, and consequently many of the data for calculating the resistance to their movements must be derived from experiment.

Passive organs of locomotion. Bones.—The solid framework, or skeleton of animals which supports and protects their more delicate tissues, whether chemically composed of entomoline, carbonate, or phosphate of lime; whether placed internally or externally; or whatever may be its form or dimensions, presents levers and fulcra for the action of the muscular system, in all animals furnished with earthy solids for their support, and possessing locomotive power.

The form, strength, density, and elasticity of skeletons vary in relation to the bulk and locomotive power of the animal, and to the media in which it is destined to move.

or as 1 to s . Hence the whole resistance in the direction of the motion will be diminished in the ratio of 1 : s^2 , and will therefore be

$$\frac{a p v^2 s^3}{2g} \dots \dots \dots (10.)$$

* Let $bead$ (fig. 216) be the section through the axis ca of the body whose motion is in the direction of ca , draw the tangent eg to any point of the curve meeting the axis produced in g , draw the ordinates ef and $e'f'$ indefinitely near each other, also draw $e'a'$ parallel to gc , then let $cf = x$, $e'f = y$, $be = z$, and s the sine of the angle g to the radius 1; then $2\pi y$ is the circumference of the circle whose radius is ef and $2\pi y x e e'$ or $2\pi y d z$ is the surface described by $e'e$ in its revolution about the axis ca , which is the quantity represented by (a) in the preceding note, therefore $\frac{p v^2 s^3}{2g} 2\pi y d z$, or $\frac{\pi p v^2 s^3}{g} y dz \dots \dots (11.)$

will be the resistance on that ring or the differential of the resistance to the body whatever its figure may be.—(See Gregory's Mechanics, chap. v. p. 521.)

The number of moveable articulations in a skeleton determines the degree of its mobility within itself; and the kind and number of these articulations of the locomotive organs determine the number and disposition of the muscles acting upon them. See *ARTICULATION*.

The strength, density, and elasticity of the external skeleton of animals have been but very partially investigated or made an object of either physiological or mechanical enquiry, notwithstanding their great importance in the animal economy generally, as well as their office in locomotion.

A superficial inspection, however, is sufficient to detect that the shells of those animals which reside constantly at the bottom of the sea, as the *Astrea tridulina*, *Phombus*, &c. are more dense, and contain a greater number of calcareous laminae than those which swim or float, either by means of specific organs of progression, such as the *Lanthina vulgaris*, the *Lymnae*, and *Hyalæa*, or upon hydrostatic principles, as in the *Nautilus*, assisted, it is believed, by the siphon. Shells are formed with a design to resist the greatest external pressure, consistent with the least expediture of materials, and with regard to the habits of the animal. The bones of vertebrated animals, especially those which are entirely terrestrial, are much more elastic, hard, and calculated by their chemical elements to bear the shocks and strains incident to terrestrial progression than those of the aquatic vertebrata; the bones of the latter being more fibrous and spongy in their texture, the skeleton is more soft and yielding.

The bones of the higher orders of vertebrata, such as the *Mammalia*, which are designed to afford large surfaces for the attachment of their powerful muscles of locomotion, are constructed in such a manner as to combine lightness with strength; therefore their surfaces are convex externally, concave within, and strengthened by ridges running across their discs: such are the forms of the scapular and iliac bones.

The long bones of the legs and arms of *Mammalia* are piled on each other endwise, forming a series of moveable columns, which in the standing position are directed vertically; these are designed to support the head, neck, and trunk, with all their contents and appendages, together with their own weight, and to elevate the trunk to some variable height above the plane of position.

It would indeed be a problem of no small difficulty, if it were proposed to an artist to erect a moveable column, composed of a definite number of rods, so united and inclined as to fulfil all the objects, for which the long bones of the extremities are designed when viewed only mechanically, and adapted to support the weight of the superincumbent organs, to present the lengthened dimensions necessary to raise the trunk often far above the plane of motion, the strength requisite to bear the shocks directed upon them both vertically and laterally, the symmetry of form and beauty of proportion corresponding to the outline and functions of other organs, their extremities being furnished with articulating surfaces for the

joints, with ridges and protuberances for the attachment of muscles, and with levers adapted to perform all the varied offices of locomotion.

In quadrupeds, which have four osseous columns to support the superincumbent organs, the pressure of the trunk on each leg is only half that in bipeds; but owing to the horizontal inclination of the trunk and the projection of the neck and head, the anterior osseous pedestals have to sustain the largest proportion of the weight; and we consequently find that the angle formed by the bones of the anterior extremities at the joint are less, and the directions of the bones nearer the vertical plane in these than in the posterior: this arrangement is most conspicuous in the larger *Ruminantia* and *Pachydermata*, especially in the *Elephant*, *Horse*, &c. We may, therefore, readily perceive why the shafts of the long bones of the legs and arms of most *Mammalia* are partially hollow cylinders; the prismatic outline predominates in the *Elephant* and *Megatherium*.

The weights which cylindrical or prismatic flexible columns will support perpendicularly when their bases and composition are equal is, according to Euler,* in the inverse ratio of the squares of their lengths, therefore if we take any bones, of similar materials and thickness, but of which the lengths are as 1, 2, 3, 4, 5, they will support weights without flexion relatively in the proportions $1, \frac{1}{4}, \frac{1}{9}, \frac{1}{16}, \frac{1}{25}$, so that whilst the lengths increase in an arithmetical progression, the weights will decrease in a geometrical progression; the necessity, therefore, for dividing the columns which sustain the trunk by means of the joints, independently of the use of the latter for locomotion, is obvious.

According to Galileo, the power of a beam or bar to resist a fracture by a force acting laterally, is as the section of the beam, where the force is applied, multiplied into the distance of the centre of gravity of the section from the point or line where the fracture will end. By applying this principle to the case of bones, we deduce the following propositions, which must, however, be regarded only as approximations to the truth.

The lateral strength of two cylindrical bones of equal weight and length, of which one is hollow and the other solid, are to each other as the diameters of their transverse sections. Thus, let a, b, d, c (*fig. 217, A, B*) be the section of the two bones: then the strength of the tube d, e is to that of the solid a, b as d, e to a, b .

Fig. 217.

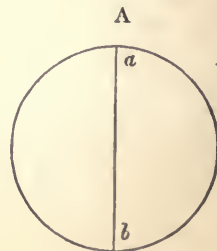

* De curvis elasticis, No. 37.

Fig. 217.

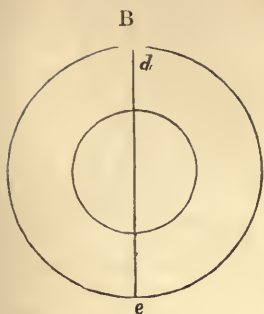

Upon the principle of this proposition, it was long since observed by Galileo that nature greatly augments, in a thousand ways, the strength of bodies without increasing their weight, and that if a wheat straw which supports the ear, that is heavier than the whole stalk, were made of the same quantity of matter, but solid, it would bend or break with far greater ease than it now does. The feathers of birds as well as the bones of animals present similar provision for the combination of strength, lightness, and economy of material. The strength of bones, however, cannot, as might possibly be inferred from the preceding proposition, be increased with the same quantities of matter indefinitely, because when the diameter of the tube exceeds certain dimensions it will become so thin and fragile as to break almost without offering any resistance.

The lateral strengths of prismatic bones of the same materials are as the areas of their sections and the distances of their centres of gravity directly; and their lengths and weights inversely.

From the deductions which may be drawn from the preceding proposition Galileo very justly concludes that "there are limits set to the magnitudes of the works of nature and art, and that the size of ships, palaces, and temples, trees and animals, cannot surpass certain dimensions; and he observes that large animals have neither the strength nor speed proportionate to their bulk, and if there were any terrestrial animals much larger than those we know, they could hardly move, and would be much more subject to the most serious accidents: and also that it is impossible for nature to give bones to men, horses, or other animals, if they were enlarged to immense heights so as to perform their offices proportionally unless the structure of bones were composed of materials much more firm and resisting, or that they were made of a thickness out of all proportion, which would render the figure and appearance of animals monstrous." Mr. Banks has found that an oak rod one inch thick, supported at each end, will break by its own weight at the length of 57.45 feet, and a similar one of iron at 38.223 feet; Emerson also found that the cohesive strength of bone is double that of oak, whilst its specific gravity is only to that of the latter as 1656 to 1170, or as 92 to

65. In the Megatherium and Elephant the length of the bones of the legs is small compared with their diameters, and consequently they possess greater comparative strength as columns in supporting their ponderous superstructures.

In the thigh bones of most animals an angle is formed by the head and neck of the bone with the axis of the body, which prevents the weight of the superstructure coming vertically upon the shaft, converts the bone into an elastic arch, and renders it capable of supporting the weight of the body in standing, leaping, and in falling from considerable altitudes.

Joints.—Where the limbs are designed to move to and fro simply in one plane, the ginglymoid or hinge-joint is applied; and where more extensive motions of the limbs are requisite, the enarthrodial, or ball and socket joint, is introduced. These two kinds of joints predominate in the locomotive organs of the animal kingdom. Though the ginglymoid joint restricts the movements of the limbs to one plane, yet it secures that precision of direction and firmness of step recognized in their motions, as well as the steadiness with which they support the trunk. The elbow, knee, and ankle-joints, in man more especially, though ginglymoid, are differently constituted and possess different degrees of mobility. The limbs revolving upon the elbow-joint move in concentric planes, whilst those articulated at the knee allow, according to Weber, a rocking motion upon each other; the ankle has the greatest latitude of motion of these three ginglymoid joints.

The enarthrodial joint has by far the most extensive power of motion, and is therefore selected for uniting the limbs to the trunk, as it is at the enarthrodial joints that the planes in which all the limbs move is determined.

The enarthrodial joints permit of the several motions of the limbs termed pronation, supination, flexion, extension, abduction, adduction, and revolution upon the axis of the limb or bone about a conical area, whose apex is the axis of the head of the bone, and base circumscribed by the distal extremity of the limb.

In consequence of the structure of the ankle-joint, the foot may be directed out of the plane of the leg's motion.

The limbs, in moving upon or about the heads of bones, describe arcs of circles, of which the centres of motion are the axes of the heads of the bones or the tubercles on which they revolve.

Ligaments.—The office of the ligaments with respect to locomotion is to restrict the degree of flexion, extension, and other motions of the limbs within definite limits.

The strength, form, elasticity, and points of attachment of ligaments are sufficient to effect the objects above mentioned; they are, however, destined mechanically to limit the motions rather than to expend their forces in supporting the weight of the limbs suspended beneath the joints to which they severally belong.

The influence of atmospheric pressure in supporting the limbs was first noticed by Dr.

Arnott, though it has been erroneously ascribed by Professor Müller to Weber. Subsequent experiments made by Dr. Todd, Mr. Wormald, and others, have fully established the mechanical influence of the air in keeping the mechanism of the joints together. The amount of atmospheric pressure on any joint depends upon the area or surface presented to its influence and the height of the barometer. The forces acting in opposition to the weight of the limb are the pressure of the air, and a force employed by the ligaments and muscles equal to the excess of the weight of the limb, if any, above that of the pressure of the atmosphere. According to Weber the atmospheric pressure on the hip-joint of a man is about 26 pounds. The pressure on the knee-joint is estimated by Dr. Arnott at 60 pounds. This estimate agrees with our measurement of the area of the surface of the knee-joint in an adult female, but is too small for an adult male which is about 90 pounds. In the Elephant and Megatherium, the pressure of the air upon the joints is greater in proportion to the increased bulk and weight of their limbs. In the latter the area of the plane bounded by the edge of the cotyloid cavity, is an ellipse whose diameters are seven and eight inches, and therefore present a plane surface exceeding 43.9824 square inches, which, being multiplied by fifteen, with the barometer at 30 inches, will be $= 43.9824 \times 15$, or about six hundred and sixty pounds pressure upon the cotyloid joint of this greatest of terrestrial Mammalia.

Muscles.—The amount and effects of muscular contraction, the absolute and relative power of muscles in reference to their length, mass, and obliquity of direction, and the expenditure of their power to support given weights, will now be either simply noticed or briefly estimated.

In the application of muscles to the purposes of locomotion we find them so arranged as to produce great velocity, and at the same time to admit a great extent of motion, still preserving the beauty of proportion. These objects are obtained, 1st, from the oblique directions of their fibres towards the tendons; 2d, from the obliquity of the direction of the tendon to the bones on which they act; 3d, from the proximity of their points of insertion to the articulations of the bones, or axes of motion in the joints.

The muscles are capable of contracting (according to the researches of M.M. Prevost and Dumas) about $\frac{25}{100}$ or nearly one-fourth their whole length, which, owing to the circumstances just mentioned, is sufficient to produce all the positions and motions observed in animals.

It has been already determined by experiment that the volumes of muscles do not alter by contraction, their thickness only increasing as they decrease in length, and *vice versa*.

The comparative power of muscles in the same animal, according to Borelli, may be thus estimated:—

When two muscles are composed of an equal number of fibres, or are of equal thickness but of unequal lengths, they will suspend equal

weights, but their motor powers and the height to which they are capable of raising the weights will be as the lengths of the muscles.

2d. When the lengths of the muscles are equal and their thicknesses unequal, their relative powers will depend upon their thicknesses, but they will raise weights to equal heights.

3d. When the lengths and thicknesses are unequal, the weights they will raise will depend on their thicknesses, and the heights to which they will raise them will be as their lengths.

When the fleshy fibres of a muscle lie parallel to the tendon, the space through which they will draw it equals the contraction of the fleshy fibres; but when they are inserted obliquely into the tendon, the space through which they will draw it will vary with the inclination.

Thus, let two equal fleshy fibres, ΔC , $B C$, (*fig.* 218) similarly situated with respect to the tendon $C D$, be inserted obliquely at C , join $A B$, and produce $D C$ to meet it in P , then $D P$ is perpendicular to $A B$. Now if the points at A , B be considered as fixed, and the angle $\Delta C P$ be such that radius : its sine :: ΔC : to the length of ΔC when contracted, then the joint action of the fibres will draw the point C to P .

Fig. 218.

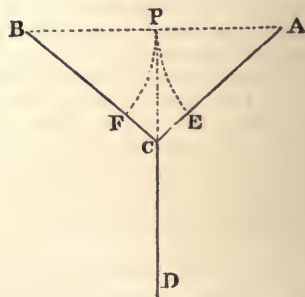

For with $A B$, as centres describe the circular arcs $P E$, $P F$, touching each other at P , then it is evident that the point C will, after the contraction of $C A$, be somewhere in the arc $E P$, because the radius of $E P$ is the length of ΔC when contracted; for a similar reason C will be somewhere in $F P$; therefore it will be at P , their point of contact. The same result becomes apparent from the consideration that the forces in the direction $C A$, $C B$ are equivalent to forces in the direction $C P$, $P A$ and $C P$, $P B$ respectively, of which the forces in the direction $C P$ are not counteracted, but gradually diminish and become zero when the fibres are at right angles to their tendon, that is, when C coincides with P . It is here assumed that there is no obstacle to the free motion of the tendon in the line $C P$.

If the obliquity of the fibres be *less* than $\Delta C P$, the arcs will intersect in some point between P and C , and the contractile force will be insufficient to draw C to P . If, on the contrary, the obliquity be *greater* than the angle $\Delta C P$, the arcs will not meet, but C

will be drawn to P. In this case the contractile force is more than sufficient for the object to be attained. All other things remaining the same, the space C P will be greatest when the obliquity is that which is stated in the proposition. If $AP = \frac{1}{4} AC$, the $\angle APC$ is $48^\circ 35'$ nearly.

From the researches of the Professors Weber we learn that the weight of the extensor muscles generally predominates over that of the flexors; those of the leg being selected, their proportions in two well-formed healthy subjects were found to be as $(2403.2 + \frac{1021.1}{2}) : 810.3$

$+ \frac{1021.1}{2} = 2913.75 : 1320.85$,* or as 11 to 5 in favour of the extensors, the proportions are divided by 2, or halved, to allow for the double office which some muscles perform of both flexion and extension, according as either end becomes the fixed point. The preponderance of the weight of the extensors becomes greater if the double action of each be omitted in the computation and the whole weight of each set be substituted; the proportion then becomes, $2403.2 : 810.3$, or as 3 to 1 nearly.

The weight of the extensor muscles, when compared with that of the rest of the leg, is in the proportion of 5 to 9, and to the whole of the muscles, including the flexors, as 3 to 4, consequently the extensor muscles of the leg weigh three-fourths of the whole series.

Borelli has given approximate values for the powers of a great number of the muscles of the human body, from which we select a few computations which will convey an idea of the enormous amount of their absolute power and the large proportion of it which is sacrificed in order to gain velocity. Borelli states that the whole force expended by the muscles of the arms, when stretched horizontally, is 209 times greater than that of any weight suspended at its extremity, and that the force of the biceps to that of the brachialis is as 3 to 2.6, or as 15 to 13, and their absolute forces as 300 to 260. He estimates the force of the deltoid at 61600 pounds, the sum of the forces of the intercostal muscles at 32040 pounds, and of the glutei at 375420 pounds. The extensor muscles of the hip, knee, and ankle-joints have also a large proportion of their power sacrificed to velocity; the amount of this interchange has been estimated upon the following principles of Borelli.

Let us suppose a porter carrying a weight to be in the act of stooping in order to enter a doorway with his load; his body is bent, with one leg raised from the ground, and the heel of the

Fig. 219.

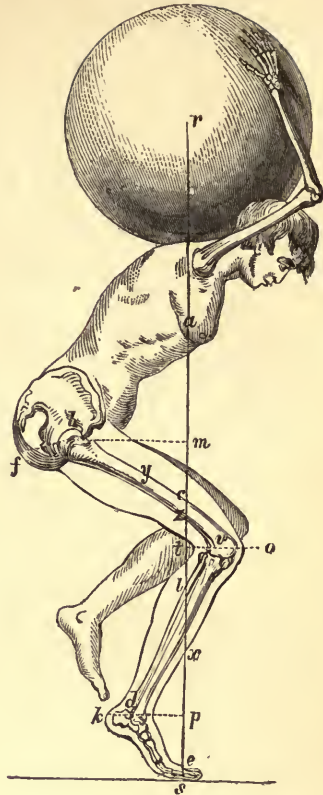

other elevated, as in *fig. 219*; he is sustained in this position by the glutei (*f*), the quadratus femoris (*y*), and the gastrocnemius and soleus (*l*). Then if the weight $r = 120\text{lb.}$, the weight of the porter 150lb. , the line rs be the direction of the force of gravity cutting the femur and tibia in c and x , the centre of gravity of the man be at b , and the common centre of gravity of the man and his load be at a , then the weight of the man from the head to b will be $= \frac{1}{2} 30\text{lb.} = 75\text{lb.}$, and of the section b to c , by supposition, is $= 47$, therefore the weight of the arc $abc = 75 + 47 = 122$, also by supposition the section $cvx = 20$, and consequently the whole arc $abvx = 142$, also the distances of the directions of the muscles from the axes of the joints to the distances of the line of gravity are, according to Borelli, in the following ratio: $\frac{1}{2}$ the distance fb is to the distance mb as 1 is to 8; $\frac{1}{2} ov$ is to tv as 1 to 6; $\frac{1}{2} kd$ is to pd as 1 to 3; and tv to bm as 3 to 4; hence we derive these proportions:—

$tv : bm :: r + abvx : z$,
or $3 : 4 :: 120 + 122 : 322\frac{1}{2}\text{lb.}$ = the pressure of the weight of man and load at the point z .

$ap : bm :: r + abvd : s$,
or $3 : 8 :: 120 + 150 : 720$ = the force of the whole weight at s .

$\frac{1}{2} bf : m :: r + abc : g$,
2 E

* $2403.2 =$ the weight of the muscles in grammes acting over one joint of the leg, viz. the glutei $= 936.0$, vasti and cruralis $= 1092.0$, soleus $= 375.2$, and $1021.1 =$ the weight of those flexors and extensors of the leg acting over two joints, viz. the rectus $= 199.2$, semitendinosus $= 128.2$, semimembranosus $= 206.5$, biceps $= 129$, gastrocnemius 358 .

† A grain $= 0.067508$ gramme.

or 1 : 8 :: 120 + 124 : 1936 = the force resisted or employed by the glutei muscles.

$$\frac{1}{2} v o : l v :: z : y,$$

or 1 : 6 :: 232\frac{2}{3} : 1936 =^o the power exerted by the quadratus femoris;

$$\frac{1}{4} k d : d p :: s : l,*$$

or 1 : 3 :: 720 : 2160. The last proportion gives the force exerted by the gastrocnemius and soleus muscles to sustain the weight of the man together with the weight *r*; now as the sum of the forces exerted by the muscles *f* + *y* + *l* = 2 × (1936) + 2160 = 6032, and the weight supported being only 120lbs., it follows that the extensor muscles of the leg, to sustain this weight, exert a force = 6032lbs., being more than fifty times the weight.

Force of muscles at various stages of their contraction.—The variations which the force of muscles undergoes in different states of their contraction have not yet been thoroughly investigated; though it is a subject not only susceptible of being pretty accurately determined, but also leads us to form a more correct hypothesis of the laws which regulate the contraction of the muscular fibres, and of the physical operation of the vital agents which are the immediate causes of the contraction.

The force of muscles, according to the experiments of Schwann, increases with their length, and *vice versa*. His experiments were made on the gastrocnemius muscle of a frog. The apparatus which he employed consisted of a board, to which the frog was fixed, with the thigh in the horizontal position, the leg being raised so as to be perpendicular to the board, and the foot again flexed to the horizontal position, in which posture the limb was firmly fixed; a rod or beam was suspended upon the board and made capable of turning upon it as its axis of oscillation. This balance beam was unequally divided with respect to its axis of motion, one arm being to the other as 1 to 6. To the longest arm of the beam a scale was separated; to the other arm the tendo Achillis (which had been carefully exposed and detached from the heel) was attached by means of a thread; by this method a very small contraction of the muscle caused the other end of the beam to revolve through a much greater space, so that the slightest contraction of the muscle became very apparent. The ischiatic nerve was then laid bare, cut through high up in the thigh, and drawn out, great care being taken not to injure the surrounding vessels. The nerve was then laid upon two wires, connected with a galvanic battery, consisting of a single pair of plates, one of the wires being connected with one pole of the battery, and the other made to communicate with the opposite pole by using a slight pressure upon it. The skin was left entire, except where the tendon and nerve were exposed. By this simple apparatus, Schwann observed that the force of the muscle was at a maximum when at its greatest elongation, and

at a minimum at its greatest contraction. In a series of five experiments, which were repeated at equal intervals, the forces of the muscles at different lengths were in the following proportions:—

No. of Experiments.	Force of Muscle in grains weight.	Comparative length of Muscle.	Difference in length.
1.	0	14.1	
	60	17.1	3.
	120	19.7	2.6
	180	22.6	2.11
2.	0	end of experiment.	
	0	13.5	
	100	18.8	4.3
	200	23.4	4.6
3.	0	end of exp. 14.4	
	0	13.7	
	50	18.7	4.3
	100	20.3	2.1
4.	0	end of exp. 14.1	
	50	17.7	
	0	13.5	5.6
	100	19.1	4.1
5.	200	23.2	
	100	16.8	
	0	12.17	4.1
	100	16.1	2.4
5.	200	18.7	
	100	16.1	
	0	11.17	

This table shows that twice the comparative length coincides with twice the force of the muscle, and that at its greatest contraction the force = 0. In the first two experiments the increase of force and length of muscle were uniform; but in the last three the ratios of the force and the length varied; the earliest experiment, however, was performed when the animal might be supposed to be nearest to its normal condition, and therefore when the result approximated most nearly to the healthy play of the muscle.

These experiments of Schwann are opposed to the hypotheses of Prevost and Dumas, as well as to those of Meissner, who regard the phenomena of muscular contraction to be due to the force of electric attraction, but as the latter increases in force the more nearly the attracted bodies approach each other, and decreases as they recede in the inverse ratio of the square of the distance, and as the force of elastic bodies varies in a ratio differing from that of muscles, when their length and force affecting them vary, we conclude that the contraction of muscles does not depend upon any of the known laws connected either with electro-dynamics or the forces regulating the molecules of elastic matter.

If we conclude from the experiments of Bergolotti, Mayo, and Prevost and Dumas, that the contraction of muscles is unaccompanied by a diminution of bulk, and that the aggregate molecules present equal volumes and are at equal distances from each other, whether contracted or not, the electric force would remain constant, whilst the muscular force varied; or if with Professors Gruithuisen and

* This computation differs from that in the 53d prop. of Borelli, where he has substituted new and arbitrary values for *s* and *z* in the two last proportions, which diminish the values of *y* and *l*.

Ermann, that the molecules approximate during contraction, the magnetic force would increase at the same time, and the muscular force is observed to decrease, therefore both of these hypotheses are inconsistent with the theory of the identity of the magnetic and muscular forces.

The power of muscles, however, rapidly decreases by exertion, especially in some of the lower animals, such as the Ophidian and Batrachian reptiles; the ratio of decrease is in proportion to the energy of action, until, by continued exertion, locomotion becomes impossible. It has now been sufficiently demonstrated that muscles are capable not only of moving the levers on which they act with great force and velocity, and of prolonging their action for a greater or less period, but that they are endowed also with a surplus of force beyond what is necessary for locomotion, and which is applied to the various purposes of life.

Having now given a brief statement of the mechanical principles applicable to the locomotion of animals, we shall proceed to give an outline of their various modes of progression according as it is performed in *air*, in *water*, or on *solids*; and in the first place, for example, we shall select those that move by means of an aeriform medium.

SECT. II. *Flying*.—Flying depends on the power which animals possess of raising themselves in the air, and of moving through it with considerable velocity in every direction. The power of flight is denied to a large proportion of the animal kingdom, and requires for its exercise a certain configuration of body, adjustment of parts, and modification of structure, based on the most profound principles of dynamics. In flying, as in swimming, the animal moves in a medium which furnishes a suitable fulcrum to its levers or locomotive organs, whatever may be their kind or form. Air supplies the medium to animals that fly as water to those that swim. Air, however, being more than eight hundred times lighter than water, gives a proportionably diminished support to the animals which move in it; consequently, instead of having the whole or nearly the whole weight of the body sustained, as when plunged in water, the same animal weighs as much more in air as corresponds to the difference in the specific gravities of the two fluids, or nearly as $1\frac{1}{2}$ to 1000. The weight of the volume of air displaced by the equal volume of any insect or bird indicates the amount of buoyancy or force acting vertically upwards, in opposition to the force of gravity on the mass of the body of the animal acting vertically downwards. The difference between the specific gravity of animals and that of the atmosphere represents the weight necessary to be overcome in flying by the action of their locomotive organs; or, in other words, whatever may be the amount of the force of gravity on the mass of particles composing the whole animal in a direction vertically downwards, and the resistance of the air on its surface due to its velocity, an equal force acting vertically upwards will be

required to sustain it in the air, and a still greater force to cause it to rise. It is the vast preponderance of the weight of most animals over that of the air they displace, which constitutes the chief obstacle to their flight, in addition to their inappropriate form and the unsuitable organization of their locomotive organs.

Flight of insects.—The flight of insects depends on the same principles as that of birds, notwithstanding the dissimilar structure of their bodies and wings. The skeleton of insects is both light and dense, and, without greatly adding to their weight, affords the necessary fulcrum for the action of an elaborate muscular system. The mobility of the segments of the abdomen upon the thorax enables the insect to bend upon itself, and to adjust the position of the centre of gravity, with respect to the articulation of the wings during flight. The attachment of the wings to the trunk lies above the centres of magnitude and gravity, so that the insect is kept steady whilst flying. Compared with their volume, the weight of insects is less than that of birds: the lightness of their skeletons and the diffusion through their bodies of tracheæ and air cavities, greatly tend to diminish their specific gravity and the quantity of muscular action employed during their flight. The form of their bodies is very irregular, but being for the most part either cylindrical or ellipsoidal, is well adapted to pass through the air with little resistance.

In the Diptera, the single pair of wings is articulated to the meso-thorax; in the other orders with two pairs of wings, the first pair is also articulated to the meso-thorax, and the second to the meta-thorax. The wings are composed of a duplicature of the common integuments continued from those parts of the body. In the Diptera and Hymenoptera the ratio of the areas of the wings to their weight is much less than in the Lepidoptera; and as this ratio decreases, the number of the vibrations of the wings in a given time proportionally increases. Hence it is vastly greater in the two former orders than in the latter. The nerves when injected with air and fluid assist in giving expansion and tension to the wings; an office compared by Jurine to the support given to a sail by its cordage. Insects are capable of varying the area of their wings during their elevation and depression, by alternately filling and exhausting the tubes, which movements follow synchronously the expansion and contraction of the thorax. The muscles which act indirectly on the wings at the same time effect changes in their surfaces, angular inclinations, and ratios of velocity during their ascent and descent. There is an elaborate mechanism provided in the structure of insects relating to their flight. The surfaces of their wings, like those of birds, are in general slightly convex above and concave below. In the Strepsiptera, Orthoptera, and Hemiptera their figure approaches that of the quadrant of a circle. In the Diptera, Coleoptera, and diurnal Spingies it is ellipsoidal. The figure of the wings varies, how-

Fig. 220.

Areas of wings within the parallels, showing the ratio of increase with their distances from the axis of the body.

0.26 1.28 1.228 1.07743 0.40631

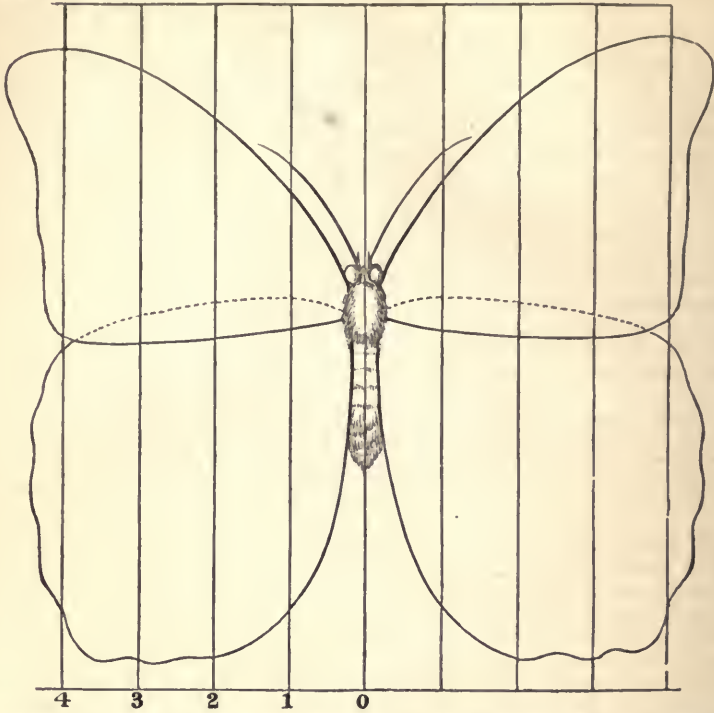

Distances of parallels from the axis of the body in 0.4 of an inch. (*Morpho autumedon*.)

ever, considerably in different orders of insects, and they are here described rather in the language of geometry than in that of entomology. The ratio of the area of the wings to the weight of the insect varies in each order, and approximates to a constant quantity only in the same order. The wings of insects diminish in thickness from their base to their apex, and from their anterior to their posterior margin;* the strongest nervures traverse the anterior margin of the wing, and confer on that portion the greatest resisting power. The posterior margin being weaker is inclined upwards and backwards in reference to the direction of its stroke. The plane of the wing, as Straus has correctly remarked, is therefore inclined at a different angle to the horizon at every moment of its descent. By the composition of forces the obliquity of the wings backwards and downwards gives to the centre of gravity an impulse upwards and forwards. The radial and cubital nervures in insects supply the place of the bones of the arm in birds; and though different in structure, they have the same mechanical effect. The anterior nervures being articulated to the apo-

physes of the wings, and being fixed at their extremities upon the two axillary first pieces, the latter, with the wings, form a *lever of the first order*, and when the internal borders of the two axillary pieces are lowered the wings are raised, and vice versâ; or as the axillaries are articulated upon the border of the clypeus, the movements of elevation and depression in these produce the contrary movements in the wings.* The wings of insects oscillate during flight through arcs of various lengths, which depend on the distances of the centres of the wings from their axes of motion, and other dynamic conditions. In the Lepidoptera they appear to describe an arc of 180° , so as to meet each other at each elevation and depression. In some other orders the arc of oscillation appears to be much less. Amongst the Coleoptera, in some of which the elytra assist the under wing in flight, according to Chabrier, the latter describe an arc four times as great as the former.† In estimating the number of

* See Straus-Dürckheim, loco cit. 212.

† Dans les hannetons chaque aile, en volant paraît décrire un arc de plus de 200° cent, tandis que celui tracé dans le même temps par les élytres est peut-être au dessous de 50° cent. See Chabrier, sur le vole des insectes, p. 31.

* See Chabrier sur le vole des insectes, c. i. p. 424.

strokes made by the wings of insects as well as of birds during flight, it is necessary to take into the account the length of the arc in which they oscillate.

The oscillations of the wings of insects are too rapid to be numbered by common observation. The principles of optics,* acoustics, and dynamics have been employed to determine them during their flight. According to Burmeister the pitch of the sound made during flight varies with the number of strokes made by the wings, although the production of the sound is perfectly independent of them.† If the number of strokes is synchronous with the number of vibrations which produce the sound, we can ascertain the number of their oscillations very readily; but we are not yet furnished with sufficient evidence that each stroke of the wing is coincident with one musical semi-vibration to determine this question with precision. According to the analysis made on the flight of birds, if the same data may be considered applicable, we shall see by Chabrier's investigations when all other things remain the same, that the number of strokes made by the wings of insects will vary as the square roots of the weight directly, and of the area of the wings inversely.

In the Coleoptera, the ratio of the area of the wings to the weight of the insect is small in comparison with other orders. The elytra of the Coleoptera add to their weight and surface in passing through the air, without contributing either to the vertical elevation or horizontal velocity of the insect; on the contrary, as their surfaces are inclined to the axis of the body and the direction of motion, they retard the velocity of the beetle in moving against the wind. The centre of the forces lies posterior to the articulation of the wings, and as the angle of inclination of the elytra tends to elevate the head and depress the abdomen by its resistance to the wind, the axis of the body becomes inclined vertically during flight. In a stag beetle weighing forty grains, the area of each elytra measured 0.366364 of a square inch, and the true wings, calculated as the quarter of an ellipse, gave 0.6263565 of a square inch each, or 1.2527126 in. for both. The same measured by a graduated scale gave 0.62240 in. each, which shows how nearly the form of the true wings approaches to a segment of perfect ellipse. Those Coleoptera in which the ratio of the surface of the wings is very small cannot fly against a strong wind. Olivier says, "None of this class can fly in opposition to the wind," but this assertion is opposed by Kirby, who states that the *Melolonthæ Hoptiæ* fly in all directions; others, as the *Cicindelæ*, take short flights, and may be easily marked down by the entomologist. The *Cetoniæ* expand their wings in flight without elevating their elytra, as is done by other Coleoptera.

The *Dermaptera*, though generally on their legs, take flight towards evening. The wings

of the earwigs are ample; the nervures radiate from a common centre to the external margin of the wings, which they expand like a fan. According to Ray, the tegmina of the Orthoptera assist the wings in flight. The *Grillus domesticus* flies with an undulatory motion like the woodpecker, alternately making a few strokes with the wings in order to give a projectile velocity to the body upwards, and then folding the wings to descend on the opposite side of the vertex of a parabolic curve. Owing to the analogous structure of their wings, the *Gryllus campestris* and *Gryllotalpa* are capable of using them in a similar manner. The Hemiptera employ their hemi-elytra to assist the wings in flying.* By this means the area of the wing is increased, a greater surface is given to it for striking the air, the ratio of the surface of the wings to the weight of the body is augmented, the quantity of action and the number of vibrations necessary to sustain it in the air is diminished, and the power of flight is consequently increased.

The *Lepidoptera* are furnished with a far greater area of wing in proportion to the weight of their bodies than is observed in any other flying animal. The under wing approaches in figure to the quadrant of a circle, and in many species the two meet posteriorly and form a semicircle. The anterior and under wings are locked together during their descent so as to give them a synchronous action, and a compact surface to resist the air. The surfaces of the two wings on each side increase with the distances of their sections from the axes of motion; in the *Morpho automedon* (*fig. 220*), in which the areas of the sections of the wings lying between the parallels 1, 2, 3, 4, drawn at equal distances from the axis of the body, will be seen to increase (the last one excepted) as the distances from the centre of motion of the wings increase; the effect of which is, to throw the centre of resistance to a greater distance from the axis of motion, so that the muscles of the wing act at a mechanical disadvantage; and the weight of the body being small in proportion to the area of the wing, the body oscillates considerably at each elevation and depression, and its flight is rendered unsteady.

The surface of the anterior wing is less than that of the posterior, being as 2.08 : 2.4483471 square inches, and the sum of the surfaces of the four wings is = 9.0566942 inches. As the solid contents of the body are very small when compared to the surface of the wings, we naturally conclude that the *Morpho* has prolonged powers of suspension. The great magnitude of the wings of the *Lepidoptera* are generally in proportion to the weight of their bodies, and the force of their muscular system endows them with great powers of flight; but it is most frequently accomplished in a zig-zag path. In the *Pontia brassicæ* the weight of the insect is found to be 1.525 gr.; the area of the anterior wing 0.6 square inch, the area

* See Nicholson's Journal, 4to. vol. iii. p. 38.

† Remarks on the causes of sound produced by insects in flying, by Dr. H. Burmeister. Taylor's Scientific Memoirs, vol. i. p. 378, 1837.

* See Dr. Roget's Bridgewater Treatise, third edition, vol. i. p. 313.

of the under wing 0.65; the sum of the areas of the two wings consequently is ≈ 1.25 ; but when placed in the position of flight, as the anterior wing lies partially over the under wing, the whole effective surface of the two wings measures 0.83, and that of the four 1.66 in. During repose the dorsal planes of the wings of the diurnal Lepidoptera are directed vertically and brought into contact.

Nocturnal Lepidoptera.—Many of this order have large organs of flight; their wings, which in repose lie in or beneath the horizontal plane, are triangular, their apices being the most distant points from the body when the wings are

extended, and their areas are in the inverse ratio of their velocities, and their distances from the centre of gravity. Thus in the *Erebus Strix* (fig. 221) the wings are greatly expanded and of a form the best calculated for rapid flight, the areas of the sections of the wing being, for the most part, in the inverse ratio of their distances from the axis of motion; consequently the reverse of that of the *Pontia*, the *Morpho*, and most of the diurnal Lepidoptera. The anterior wing is much larger than the posterior, being as 7.175 to 5.095 square inches. The area of the four wings is therefore about 12.270 inches, which, being very considerable in proportion

Fig. 221.

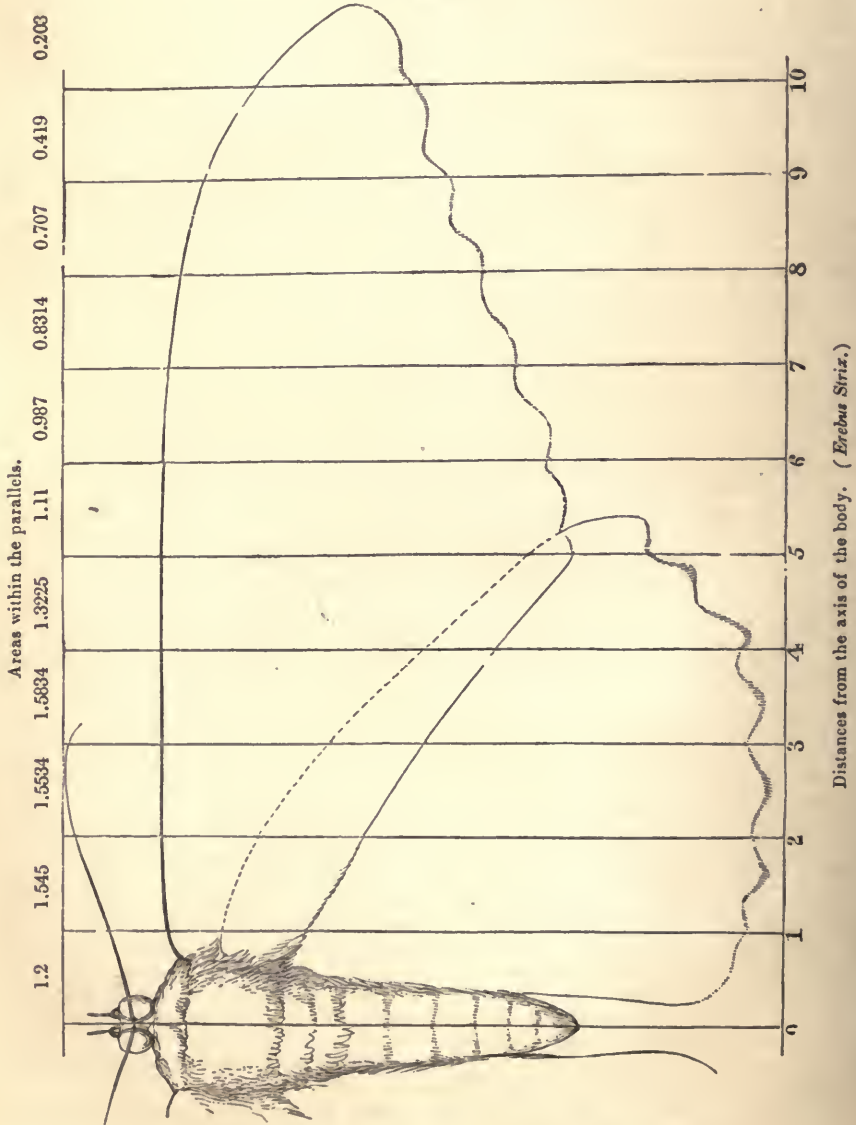

to the cubic contents of the body, endows this insect with great powers of suspension in the air and with great velocity of motion. The triangular figure of the wings prevents the unsteady undulating progression observed in the diurnal Lepidoptera, and the flight is consequently more direct as well as more rapid. The wings of many of the moths are of considerable dimensions. The largest male Atlas moth in the collection at the British Museum measures $5\frac{1}{2}$ inches on each side, estimated from their axes of motion to the apices of the wings, presenting a total area of $26\frac{1}{2}$ square inches. If the force of the muscles acting on the wings is proportional to their areas, they must possess the most extensive power of flight. The Bombyx mori, or silk-worm moth, is stated to travel more than a hundred miles a day.*

The Neuroptera have a separate set of muscles appropriated to the movements of each wing, which being detached can be moved either synchronously or independently of each other: the muscles also are actually inserted into the wing, instead of moving them indirectly, as in other orders of insects. The surfaces of the four wings of the Libellulæ, or dragon-flies, are nearly equal in most species; they are always expanded in repose, and extended horizontally at right angles to the axis of the body, so that they take flight in an instant. Their figure is lanceolated. The ratio of the united areas of the four wings to the weight of the body is greater than in the Coleoptera and Hymenoptera, and the muscular power is proportionally augmented. The articulation of the wings being situated above the centre of gravity keeps them steady in flight: their velocity is very great, exceeding that of the Swallow. Leeuwenhoek once observed one of this tribe in a menagerie 200 feet long, chased by a swallow; the insect flew with such velocity, and turned to the right and left in all directions so instantaneously, that the swallow, with all its powers of flight and tact in chasing insects, was unable to capture it, the insect always keeping about six feet in advance of the bird. The great length and surface of the wings of the Libellulæ, and the power of the muscles acting on them, is such that they appear to be never tired of flying in quest of their prey.

In a specimen of the *Æshna maculatissima*, which weighed fourteen grains, the area of the anterior wing was 0.7324 in. the posterior 0.8988 in. and the area of the four wings 3.26408 square inches. The preponderance of surface in the posterior wing enables the Libellulæ to change the direction of their path of motion with great facility, and to capture their prey on the wing. Previously to taking flight, this *Æshna* exerts a vibratory movement with its wings; the oscillations are made in very minute arcs, and with great rapidity, producing a faint though distinct sound. The pitch indicates that the wings perform ninety-six vibrations in a second. On taking flight the wings oscillate through larger arcs, with a less number of vibrations, the amount of which it is not easy

to determine, and does not depend, as some distinguished entomologists have supposed, on their mutual friction.

In a *Triphæna pronuba*, weighing 8.545 grains, the area of the anterior wings measured 0.6213, and that of the under wings 0.68 square inches, making the sum of the areas of the four wings 2.6026 square inches.

In the *Hymenoptera* the ratio of the areas of the four wings to the weight of the insect is less than in the Neuroptera, and they are consequently obliged to make a greater number of strokes in the same interval of time in order to suspend themselves in the air. The areas of the upper are greater than those of the under wings. When expanded they are retained in the same place, and are linked together by means of small hooks, so that the upper and under wings act simultaneously and with greater power. A humble bee, which weighed 6.2 grains, had wings the sum of whose areas measured 0.366 of a square inch, or rather more than $\frac{1}{30}$ th of a square inch to each grain weight of the body. Bees are not only celebrated for the geometry displayed in the structure of their cells, but also for the precision with which they return to their homes by the shortest path or in a straight line. The collectors of honey make use of this fact to discover their nests. Having captured two of these insects, they separate them some yards from each other, and on setting them free, ascertain with an instrument the angles respectively made by the lines of their flight with that between the points of their departure, then the point where the two lines of direction intersect each other indicates the position of the nest. The humble bee, wasp, and hornet fly with great force, but owing to the weight of their bodies, compared with the areas of their wings, cannot fly with much speed against a strong wind, so that a person might easily outstrip them by running in the same direction against the wind. When disturbed, or before leaving their abode, they wheel round the spot in a large circle, and then fly off at a tangent to some part of the curve. The Ichneumons are provided with a far greater expansion of wing, in proportion to their weight, than the Bees, and can consequently sustain themselves in the air with less expenditure of muscular action. In a species of ichneumon allied to *Ophion luteus*, which weighed 0.5 gr. the areas of the anterior wing measured 0.0832 in. the posterior 0.0480 in. the sum of the two wings = 0.1322 in. and that of the four = 0.2644 in.

The *Diptera* are furnished with only two wings, which when in repose lie directed obliquely backwards upon the abdomen; their figure is nearly that of an ellipse, and their areas are ample when compared to the weight of their bodies. Three examples of *Musca vomitoria* for instance were found to weigh 2.4375 grains, which gives for the mean weight of each 0.8025 gr. and the mean areas of both wings were found to be from $\frac{1}{15}$ th to $\frac{1}{14}$ th of a square inch. Instead of posterior wings they have poisers, the articulation of which to the thorax is placed more posteriorly than in the four-

* Lin. Trans. vol. iii. p. 40.

winged insects, so as to lie above the centre of gravity. According to Dr. Derham, if either a poiser or winglet be cut off, the insect flies as if one side overbalanced the other, till it falls to the ground; and if both be removed, it flies unsteadily. Shelver states that the removal of either winglets or poisers deprived the insect of the power of flight altogether. The pneumatic pressure which retains them inverted to the ceilings of rooms, gives them a position favourable for flying off instantaneously, the centre of gravity being below the articulation of the wings, enabling them to regain the pendant position of the trunk in flight.

In the crane fly the centre of gravity is adjusted, and the direction of flight directed by

its long legs; the two fore legs being extended forwards, and the four hind legs backwards. According to Kirby, the one represents the prow, the other the stern of a ship. The velocity of the house, and large flesh flies (*Musca domestica et vomitoria*) appears to be from five to six feet in a second, or about four miles in an hour; but if favoured by the wind, they are seen flying round the ears of horses when travelling at the rate of from ten to twelve miles in an hour.*

The following table presents at one view the proportions of the areas of the wings in square inches to their weight in grains of various species of insects which have been already described in the text.

<i>Order.</i>	<i>Species.</i>	<i>Area of Wings in square Inches.</i>	<i>Weight of Body in Grains.</i>
COLEOPTERA	<i>Lucanus cervus</i>	1.2527126	40.
HYMENOPTERA	<i>Bombus</i>	0.366	6.2.
	<i>Ophion luteus</i>	0.2644	0.5.
DIPTERA	<i>Musca vomitoria</i>	0.083333 or $\frac{1}{12}$	0.8025.
LEPIDOPTERA	<i>Pontia brassicæ</i>	2.50	1.525.
	<i>Triphaena pronuba</i>	2.6026	8.545.
NEUROPTERA	<i>Æshna maculatissima</i>	3.26408	14.

By the help of this table we are enabled to compare the proportions of the area of the wing to the weight of the insect in different orders, and to estimate the relation between these proportions and the absolute powers of flight, when the latter have been ascertained by experiment.

If the velocity and power of suspension varied in insects precisely in the same ratio as the areas of the wings to the weight of their bodies, we should be enabled to compare with tolerable accuracy the relative powers of the flight of insects from data similar to the preceding, but there are several other mechanical and physiological conditions involved; such as the ratio of the force of the muscles to the areas of the wings, and the figure and structure of the latter. The Lepidoptera which have the greatest surface of wing in proportion to their weight, should surpass all other insects in power of flight, yet the diurnal section at least yield to the Libellulæ in velocity, if not in the duration of their suspension in the air. From the preceding data we conclude, that to render a man, whose weight is 150 pounds, capable of suspending himself in the air by the assistance of artificial wings, with the same facility as insects, would require an extent of surface beyond the control of his muscular force, and consequently that the act is impossible.

Flight of Birds.—In the organization of birds, we observe that many parts common to other animals are modified, the power of the muscular system is increased, and new forms of matter are introduced to confer on them the power of flight. The bulk of birds is less than that of quadrupeds of equal strength, and owing to many of their bones being permeated with air, and their skin clothed with feathers, their specific gravity, and consequently the demand on their muscular power

are diminished.† Instead of the cylindrical form observed in animals which move exclusively on solids, the anterior extremity of birds is expanded into a triangular surface, of which the apex is the distal, and the base is the proximal section of the wing in reference to the axis of rotation. The arm is articulated to the trunk by a ball and socket joint, permitting all the freedom of motion necessary for flight, whilst in consequence of the axes of motion in the ginglymoid joints of the fore-arm being directed either perpendicularly or obliquely to the ascent and descent of the wing, it is prevented from yielding to the resistance of the air during elevation and depression, and is more conveniently folded on itself during repose. The surface of the wings may be increased or diminished by abduction and adduction, in consequence of which the resistance of the air to their motion may be proportionally varied in the up and down strokes. The amount of this resistance is also varied by the surface of the wing being convex above, and concave below. The feathers are moreover provided with a curious mechanism by which the barbules lock into each other, so as to unite all the parts of the vane, and present a continuous surface to the air. The ten primary and the secondary feathers, which have the greatest leverage, are inserted into the arm and fore-arm, and directed so as to produce the greatest surface of wing

* See Kirby and Spence, vol. ii. p. 357.

† 1. The Pelicanus onocrotalus is five feet in length, but its skeleton weighs only twenty-three ounces, whilst the whole animal weighs twenty-five pounds. See Roget's Bridg. Treat. vol. i. p. 490.

2. The skeleton of the Carrion Crow when dry weighs only twenty-three grains. Jaquamin, An. Sci. Nat. series 2, 11, p. 2718.

3. Many entire Humming Birds weigh only one-eighth of an ounce, or one drachm.

without very sensibly increasing its weight. The scapulars which have the least velocity are shorter and weaker. The length and strength of those feathers which contribute so largely to increase the area, vary directly with the velocities of that portion of the wing to which they belong. The ratio of the area of the wings of birds to their weight is by no means constant. It is least in the Cursors, such as the Ostrich, Cassiowary, and Emeu; greater in the Insectores, as the Raven, Crow, and Humming-bird; and greatest in the diurnal Raptores, as the Eagle, Falcons, and Vultures. The power of flight in birds, provided the muscular forces vary in proportion, is as the areas of their wings directly, and as their specific gravities inversely. Owing to the triangular figure of the expanded wing, the area of its sections diminishes as their distance from the centre of gravity increases, and from the same cause the areas are in the inverse ratio of the velocities corresponding to the distances of the sections from the axis of motion. The centre of resistance coincides very nearly with the middle of the length of the wing from the shoulder-joint to the tip. The wing is moved on the principle of the third order of levers, and the power is applied sufficiently near the axis of motion to produce a considerable relative velocity. The power of the muscles acting on the wing is increased in proportion to their mass, being to those of the inferior extremity (according to Borelli) in the proportion of more than three to one, their absolute power in proportion to the weight of the bird being as 10'000 to 1. In order to give the osseous framework the surface and strength necessary for the attachment of the great pectoral muscles which act on the wing, the sternum is carinated, whereby its surface is increased in proportion to the mass of the muscular fibres which are inserted into it, and the shoulder-joints are strengthened by the elongation of the coracoid processes, and the magnitude of the clavicles. The fixed condition of the ribs and vertebral column tends also to strengthen the thoracic sections of the bird, and enables it to resist the enormous muscular force applied to it during flight.* This brief outline of the manifold adaptations necessary for aerial progression will give some idea of the number and complication of the elements which enter into the composition of so small a fabric, and of the enormous muscular power with which birds are endowed, compared with their bulk and weight. When a bird rises from the ground, and at the moment it begins its flight, the first impulse is communicated to its centre of gravity by the sudden extension of the legs, as in leaping. During this action the humerus is raised; the wings are unfolded and spread out horizontally by the extension of the fore-arm, and of

the carpal, metacarpal, and phalangeal bones. The force resulting from the sudden extension of the legs elevates the whole mass of the bird above the plane of position, and the body thus raised being deprived of the support previously afforded would begin again to fall by its own weight, as soon as the projectile force became insufficient to sustain it, but the wings having in the meantime been spread out to their fullest extent, are made to descend with great velocity by the contraction of the powerful pectoral muscles. In consequence of the planes of the wings being disposed either perpendicularly, or obliquely backwards to the direction of their motion, a corresponding impulse is given to the centre of gravity. The resistance of the air to the wings during their depression through a greater or less arc of a circle becomes greater than the force of gravity on the mass of the bird, together with the resistance of the air on its body due to its velocity, and consequently the bird rises. During the ascent of the wing, the opposite effect takes place. The bird has not only to encounter the resistance which the air opposes to the motion of the wing during its back stroke, but also the resistance due to its figure when in motion, as well as the force of gravity. These are so many forces tending to neutralize the down stroke of the wing, and to produce an opposite effect, so that there will result a motion, the amount of which may be pretty nearly ascertained when the necessary data are obtained by experiment.

The principal data required for computing the quantity of muscular action expended, the velocity of the centre of the wing, and the number of its periodic oscillations necessary to sustain the bird in the air, may here be briefly stated. 1st. The area of the horizontal section of the body of the bird. 2d. The area of the two wings whilst they are lowered. 3rd. The area of the wings whilst they are raised. 4th. The velocity with which the bird is driven through the air. 5th. The velocity with which the wings are lowered. 6th. The velocity with which the wings are raised. 7th. The respective durations of the elevation and depression of the wings. 8th. The weight of the whole bird. 9th. The weight of an equal volume of air. 10th. The resistance of the air due to the figure and velocity of the bird. 11th. The ratio of the resistance which the air opposes to the wings during their elevation and depression. 12th. The ratio of the resistance of the air to the time of an elevation of the wings to that of a depression.

These are the principal data which are deemed necessary for estimating by dynamics the amount of the force employed by birds during their flight.† If the area of the wings of birds always preserved the same ratio to their weight, the

* The position of the scapulo-humeral joint with respect to that of the great pectoral muscles throws the centres of gravity and figure below the axis of articulation of the wings, so that the animal is kept steady in flight, whilst its figure is such as to enable it to glide through the air with the least possible resistance.

† Let us suppose the bird to endeavour to rise perpendicularly in the air by equal flappings of its wings in a vertical direction, and let s = the area of the transverse section of the bird, A = the area of the wings whilst they are depressed, A' = the area of the wings whilst they are elevated, u = the velocity with which the bird rises in the air, V = the velocity with which it depresses its

velocity of the centre of the wing would be the same in all birds, and if the arc of vibration and the ratio of the time of ascent to that of descent in the wing were constant, the number of flappings would vary inversely as the distance of the centre of the wing from the axis of

wings, V' = the velocity with which it elevates its wings, t = the time reckoned from the moment when the wings begin to be depressed, τ = the time of a depression, τ' = the time of an elevation, W = the weight of the bird, π = the weight of a cubical foot of air, g = the velocity acquired by gravity in an unit of time, k = a constant coefficient, by which we multiply the product $\frac{u^2}{2g}\pi$, in order to get the expression for the resistance of the air to the rising of the bird, which is therefore $\pi k s \frac{u^2}{2g}$, K = a similar coefficient for the expression of the resistance of the air to the depression of the wings, K' = a similar coefficient for the resistance of the air to its elevation. During the depression of the wing the bird is drawn downwards by the force W , arising from its own weight, and by the resistance of the air to its rising, namely, $\pi k s \frac{u^2}{2g}$, but it is driven upwards by the resistance which the air opposes to the motion of the wing, that is, $\pi K A \frac{(V-u)^2}{2g}$, hence the equation to the motion will be

$$\frac{W}{g} \frac{du}{dt} = \pi K A \frac{(V-u)^2}{2g} - \pi k s \frac{u^2}{2g} - W,$$

or

$$2W \frac{du}{dt} = \pi K A (V-u)^2 - \pi k s u^2 - 2Wg \dots \dots \dots (12)$$

These are approximative values. The motion of the wing being very quick, we may consider u to be constant during a depression, and if u_0, u_1 be the values of u , at the beginning and end of the depression, equation (12) will become

$$2W(u_1 - u_0) = \tau \{ \pi K A (V - u_0)^2 - \pi k s u_0^2 - 2Wg \} \dots \dots \dots (13)$$

Similarly if u_1, u_2 be the values of u at the beginning and end of an elevation, the equation for the motion will be

$$2W(u_2 - u_1) = -\tau' \{ \pi K' A' (V' + u_1)^2 + \pi k s u_1^2 + 2Wg \} \dots \dots \dots (14)$$

By adding the two latter equations together we have

$$2W(u_2 - u_0) = \tau \{ \pi K A (V - u_0)^2 - \pi k s u_0^2 - 2Wg \} - \tau' \{ \pi K' A' (V' + u_1)^2 + \pi k s u_1^2 + 2Wg \} \dots \dots \dots (15)$$

Since, at the end of every flapping the wings are supposed to be in the same position as they were at the beginning of it, we must have

$$V \tau = V' \tau' \dots \dots \dots (16)$$

The two equations (15) and (16) express the conditions under which the bird may acquire a given motion, the nature of which is shown by the variation $u_2 - u_0$ which the velocity u undergoes in the time $\tau + \tau'$. If we suppose the motion of the bird to be uniform during each flapping $u_0 = u_1 = u_2$, and if we take the value of V' in equation (16), equation (15) will become

$$0 = \tau \tau' \pi K A (V - u_0)^2 - \pi K' A' (V \tau + u_0 \tau')^2 - (\tau + \tau') \tau' \pi k s u_0^2 - (\tau + \tau') \tau' 2Wg \dots \dots (17)$$

In order to fly, the bird must expend a quantity of force sufficient to overcome the resistance of the air to the motion of the wings, and, considering the velocity of the bird to be constant during each movement of the wings, the quantity of force expended in a depression will be

$$\pi K A \frac{(V - u_0)^2}{2g} V \tau,$$

and in an elevation

$$\pi K' A' \frac{(V' + u_1)^2}{2g} V' \tau'.$$

If we now suppose $u_0 = u_1$ as before, and substitute the value of V' , we shall have for the whole force expended in an unit of time

$$\frac{\pi V \tau}{2g(\tau + \tau')} \left\{ K A (V - u_0)^2 + K' A' \left(\frac{V \tau + u_0 \tau'}{\tau'} \right)^2 \right\} \dots \dots \dots (18)$$

Let $\tau' = p \tau$, and $K' A' = q K A$, equation (17) then becomes

$$0 = p(V - u_0)^2 - q(V + u_0 p)^2 - (p + p^2) \frac{k s}{K A} u_0^2 - (p + p^2) \frac{2Wg}{\pi K A}$$

* V and V' are supposed constant during the times of elevation and depression, respectively, and are referred to the centres of the wings.

motion; but according to our experiments the weight of the Pigeon is 4347.344 grains; of the Rook 4170.25; and of the Canary 229; whilst the areas of their wings are respectively 0.6198, 1.11, and 0.054 feet: hence, we see that in these instances, as probably in other

and solving it with respect to V, we have

$$V = p \frac{q+1}{p-q} u_0 + \sqrt{pq \left(\frac{p+1}{p-q}\right)^2 u_0^2 + p \frac{p+1}{p-q} \frac{\pi k s u_0^2 + 2 W g}{\pi K A}}, \dots\dots(19)$$

and supposing the same things in (18), it will become

$$\frac{\pi K A V}{2g(p^2 + p^2)} \left\{ p^2 (V - u_0)^2 + q (V + pu_0)^2 \right\} \dots\dots\dots(20)$$

Here we may substitute for V its value found in equation (19). If the bird merely supports itself in the air without rising or falling, $u_0 = 0$, and the expressions for V and the force expended in an unit of time, viz. (19) and (20) will become respectively

$$V = \sqrt{\frac{p+p^2}{p-q} \frac{2 W g}{\pi K A}}, \dots\dots\dots(21)$$

$$W \frac{p^2 + q}{p^2 - p q} \sqrt{\frac{p+p^2}{p-q} \frac{2 W g}{\pi K A}} \dots\dots\dots(22)$$

We may suppose q to be known from the figure of the bird and the power which it has of expanding the wing in a depression, and closing it during an elevation, so as to increase and diminish the surface and resistance alternately; and in order to find the least quantity of force necessary to sustain the bird, we must give to p such a value as will make the expression (22) a minimum.

All other things being the same, we see that the quantity of force expended is proportional to the $\sqrt{W^3}$, and is also inversely as the $\sqrt{\text{density of the air}}$. Let us take, as an example, the data given by M. Chabrier with respect to the Swallow. $W = 0.01526$ kil. $\pi = 1.25$ kil. $A = 0.0086$ met. $g = 9.80422$ met., now from experiment it is found that a plane surface very nearly equal to the surface of a swallow's wing will produce a resistance in air equal to the weight of a column of fluid, whose base is the plane and altitude between one and a half, and twice the height due to the velocity with which the plane is moving; if, therefore, we suppose the resistance of the wing to be a little more on account of the concavity of its surface, and consider the altitude just twice the height due to the velocity, K will = 2. It is also evident that $p > 1$ and $q < 1$, and by giving different values to q, we may obtain the corresponding values of p.

1. Let $q = \frac{1}{2}$, then when (22) is a minimum.

$$p = 3.073$$

$$V = 8\text{m}.18 = 26.8304 \text{ feet.}$$

$$(22) = W 10\text{m}.36 = 33.784 \text{ feet.}$$

2. Let $q = \frac{1}{3}$ p = 1.866.

$$V = 6\text{m}.91 = 22.6648 \text{ feet.}$$

$$(22) = W 8\text{m}.39 = 27.5192 \text{ feet.}$$

3. Let $q = \frac{1}{4}$ p = 1.6

$$V = 6\text{m}.81 = 20.3368 \text{ feet.}$$

$$(22) = W 7\text{m}.95 = 26.0660 \text{ feet.}$$

We may observe that the several values assigned to q do not produce any great variations in the values of V and (22), we may, therefore, with tolerable accuracy conclude that a bird which just supports itself in the air, expends as much force every second as would be sufficient to raise its own weight a height of 8 metres or 27.5192 feet. The mean velocity of the descending wing is about 7 metres or 22.96 feet per second, and the velocity of the ascending wing is about one-half of it. Let us now take the distance of the centre of the swallow's wing, from its axis of motion, to be three inches, and that it oscillates in an arc of $120^\circ = \frac{2\pi}{3}$, then the length of this arc will be found

by the following proportion $1 : 3 :: \frac{2\pi}{3} : 2\pi = 6.2832$ inches; the velocity divided by this length is = 43.85, being the number of arcs which would be described by the descending wing in one second, but the ascending wing takes 1.866 seconds to describe the same number of arcs, consequently this number, divided by the sum of the times taken by each wing, namely, 2.866, gives 15.3, the number of flappings, each consisting of two arcs, per second.

Such is the result by Chabrier's formula. If we apply the same formula to the case of the Pigeon, the result is 14.9, or nearly 15 flappings per second; but actual observation proves this to be nearly three times the real number; a similar discrepancy is observed in the case of the Rook,

dissimilar orders, the areas of the wings do not vary as the weights of the birds.

The ratio of the times of the descent and ascent of the wing will cause a corresponding difference in the ratio of the resistance of the air, which is not as the velocity simply, but as the square of the velocity. The velocity of the wing varies according to the celerity with which the bird moves, and it moves through a greater or less arc according as the bird merely suspends itself in the air or is in rapid motion, on the rational supposition that birds employ their locomotive organs in such a manner as to economize as much as possible the expenditure of their muscular power. We find by the annexed analysis that for this purpose the ratio of the time of the descent of the wings to that of their ascent is nearly as one to two, and that the ratio of the resistance of the up to that of the down stroke lies between one-half, one-fourth, and one-fifth. In the Swallow, for example, in order that the bird may merely sustain itself in the air, the centre of the wings, according to Chabrier, must descend with a velocity of about seven metres, or 22·9662944 feet per second, which, we find by the annexed analysis, gives 15·3 for the number of vibrations, and for the minimum amount of action expended in the same time, a force which would raise its own weight to the height of 26·246 feet.

The ratio of the time of the ascent and descent of the wing becomes much greater when the bird moves against the wind, suppose about forty-eight feet per second, or in rapid flight; and the velocity of the descent of the wings, and quantity of action expended, will augment in proportion. The great quantity of action expended in flight tends to confirm the views of Borelli respecting the vast power with which the pectoral muscles of birds are endowed. In small birds the oscillations are performed with such great rapidity, that they cannot be numbered by the eye; but in the finches and humming-birds, the oscillations of which produce a musical note, the pitch will enable us to determine with accuracy the number of oscillations in a given time. In large birds, the wings move through arcs of greater circles than in small ones, and the times of their periodic oscillations decrease in the same ratio, and may thus be more easily numbered: the areas of their wings, and the resistance which they encounter,

where the formula gives 7·38, and observation from 2 to 3 flappings per second. It is worthy of remark, that by supposing V to be equal to the cube root, instead of the square root of $\frac{p+p^2}{p-q} \frac{2Wg}{\pi K A}$

the number of flappings in each of the last two cases by the formula, agrees very closely with the number determined by the mean of several observations.

The quantity of force expended would be greater if the density of the air were less, but it would only increase in the ratio of 1·4 to 1 if the air were but half as dense. We may, therefore, conclude that the height to which a bird can raise itself is limited not so much by want of sufficient support in the resistance of the air as by the difficulty of respiring in too rare an atmosphere.

* The Rook appears to make from ten to fifteen, and the Pigeon from ten to twenty-three effective strokes of the wing in five seconds.

† The soft downy feathers which line the wings of the nocturnal rapacious birds, as the Owl, permit the wings to perform its evolutions during flight in search of their prey without noise. On the contrary, in the diurnal species of this order, which chase and capture their prey in open day, and where no secrecy would suffice, the feathers are strong, and their passage through the air is accompanied with a rushing noise.

bear some proportion to the greater weight of the body: but although theory ascribes to the wings a large number of oscillations, it by no means follows that they perform the exact number assigned at least for any lengthened period. On the contrary, we observe that many birds, such as the Woodpecker,* and most Insectores, give a few strokes of the wings by which the body acquires a projectile velocity sufficient to elevate it through a considerable space, and that when the impulse thus given is nearly expended, they repeat this action, and again suspend it. If they are moving horizontally, their progression is performed in a similar manner; the axis of the bird is inclined upwards at each impulse like a projectile, but the mean motion is horizontal. The curve described during each projection is a parabola. After a few strokes, during the ascent, the wings are folded until the bird has passed the vertex of the curve, and has descended to some distance on the opposite side, when they suddenly expand their wings again, and by a few strokes describe a new curve. In this mode of progression the velocity is very variable, being equal to that which a body would acquire by falling through one-fourth of the parameter of each point in the curve. Many large birds, such as the Rooks, Pigeons, &c. when descending from great heights expand their wings, and incline the axis of their bodies obliquely downwards, as in *fig.* 222.

Fig. 222.



In this case the air opposes sufficient resistance in a vertical direction upwards to keep in equilibrium the force of gravity acting upon the body vertically downwards, so that the motion of the bird becomes uniform, without requiring any movement of the wings.† Another mode of de-

scant is performed with greater celerity by elevating the wings at an angle of nearly 45° above the plane of the horizon, (as in *fig. 223*), by which

Fig. 223.

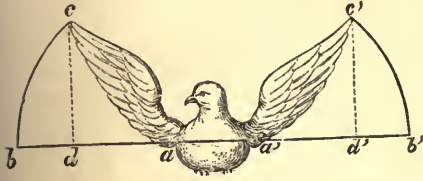

the resistance of the air, compared with the resistance to the wing when horizontal, is diminished in the ratio of radius to the cube of the sine of inclination, that is, as $a b$ to $d c^3$; consequently, a bird with its wings elevated at any angle to the horizontal plane will descend with greater velocity than when they are in the direction of $a b$. We most frequently observe that Pigeons elevate their wings in this manner until they arrive within a foot or two of the ground, when, to prevent the shock they would otherwise receive, owing to the velocity acquired during their descent, they suddenly turn their axis perpendicular, which had previously been parallel, to the direction of their motion, and by a few rapid strokes of the wing neutralize their momentum, and thus reach the ground with ease and safety. In order to produce lateral motion one wing oscillates more rapidly than the other, thereby causing the head to turn towards the side to which the latter wing is attached.

The tail of the bird performs the office of a rudder in steering its course; its plane being horizontal tends chiefly, as Borelli has demonstrated, to elevate and depress the head, rather than to turn the axis of the bird laterally. Let us, for instance, suppose that a bird, flying in the direction of its axis $g f$, (*fig. 224*) elevates

Fig. 224.

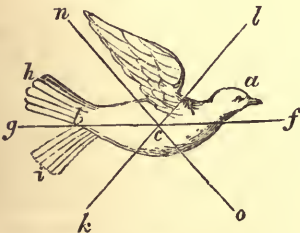

its tail into the position $b h$ parallel to $o n$, the resistance of the air will depress b towards k , and causing the bird to rotate on its centre of gravity c will elevate the head from a towards l ; on the other hand, if the tail be depressed into the position $b i$, parallel to $l k$, by the resistance of the air, the point b will be

raised towards n , and the head depressed towards o , consequently the direction of the bird in its mesial plane is regulated by the tail.* In the Grallatores the tail is short and its surface very small, and the function of a rudder is transferred to the legs, which are projected backwards in flight, to counterbalance the depressing weight of their long extended neck and head. This fact was noticed by Aristotle.† The Swallows, which are almost always upon the wing, economise their muscular action by giving a few strokes with their wings, and by keeping them expanded, scud through the air with great velocity in chase of their prey; this interval of comparative repose must be of great service to them during their annual migrations across the sea to other countries. The velocity of some birds is very great. The Eider-duck is said to fly 90 miles in an hour, the Hawk 150. The great Albatross wafts itself across the Pacific Ocean apparently with untiring energy, owing to the vast muscular power with which it is endowed.

Flight of fish and other animals.—Besides insects and birds, there are some other animals capable of sustaining themselves during a short period in the air by means of membranous expansions or enlarged pectoral fins. The *Dactylopterus* and *Ercatus*, or flying fish, are enabled to raise themselves above the surface of the water by the action of their enormous pectoral fins; but Mr. Bennett, who appears to have particularly observed their motions, states that he has never seen these fishes sustain themselves for a longer period than thirty seconds, nor ever witnessed any vibration in their pectoral fins. Captain Basil Hall estimates their longest flight at about two hundred yards, and they have been sometimes known to rise above the surface of the water as high as twenty feet. The projectile force with which they emerge from the water determines their elevation, and the expanded pectoral fins merely sustain them for a brief interval.

The *Draco Volans* (*fig. 225*) is provided with a broad disc on each side, extending from the fore to the hinder extremities. It is covered by the skin, supported by the first six false ribs, and directed horizontally. This membranous disc expands and closes like a fan, and is elevated and depressed like the wings of birds to break their fall in descending from trees, but notwithstanding the extent and mobility of their wings, they are said to be incapable of raising themselves in the air, since their arms are detached, and neither enter into the composition of the wings, nor assist in their elevation or depression.

The area of the wings of the *Draco volans* (*fig. 225*)† estimated from the mesial section of the body is nearly 5.052 square inches. Another *Draco volans* which is preserved in spirits

* See Borelli, *De motu Animal.* c. 22, p. 235.

† See Taylor's Aristotle's *Progressive Motion of Animals*, c. x. p. 184.

‡ In consequence of the specimen in the collection of Professor Grant, from which the annexed outline was made, being dry, its weight in the living state could not be ascertained.

Fig. 225.

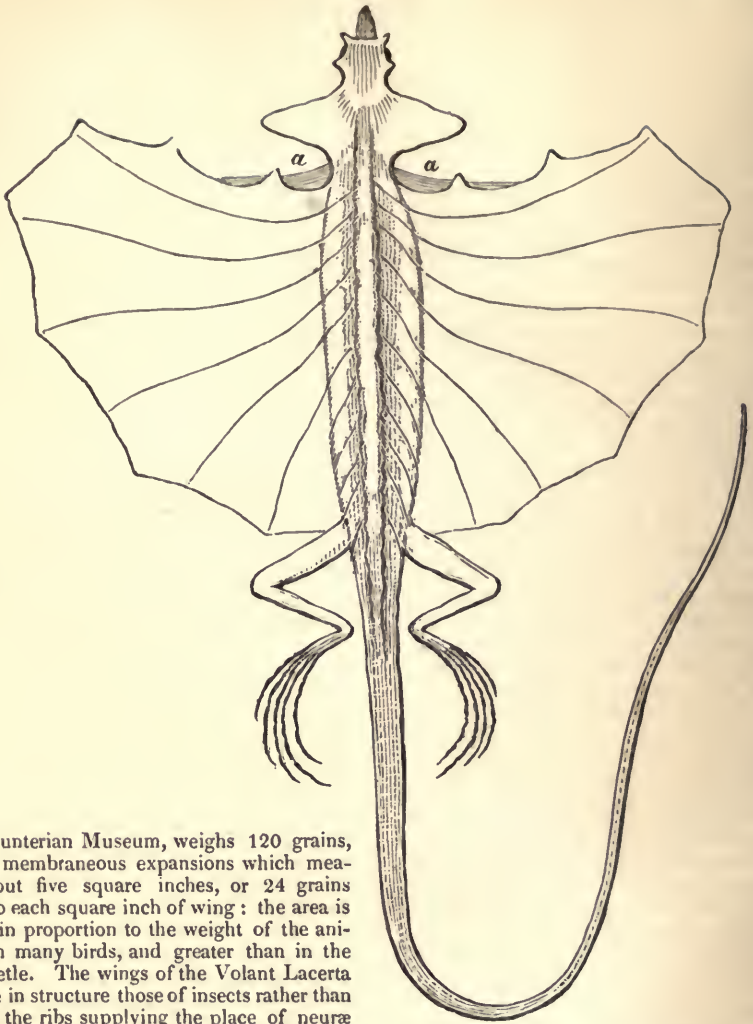

in the Hunterian Museum, weighs 120 grains, and has membraneous expansions which measure about five square inches, or 24 grains weight to each square inch of wing: the area is as great in proportion to the weight of the animal as in many birds, and greater than in the Stag Beetle. The wings of the Volant Lacerta resemble in structure those of insects rather than of birds, the ribs supplying the place of neuræ in the former, and of the osseous framework of the anterior extremity in the latter. They have sufficient membraneous expansion for flight, provided the muscles which move them were so applied, and had sufficient force to elevate and depress them with the necessary velocity.

The Galeopithecus, or flying Cat, and the Pteromys, or flying Pha'nger, are also furnished with lateral membranes extending from the atlantal to the sacral extremities, to both of which they are attached, but they are incapable of raising the animal in the air, and rather perform the office of parachutes than of true organs of progression.

The fossil remains of the Pterodactylus show that it was organized for flight; the phalanges of the ulnar finger being greatly elongated, apparently for supporting a membrane extending along the whole ulnar aspect of the arm and side of the body to the leg; a me-

chanism which enabled these animals to move through the air like birds. The four other fingers are free to answer the purpose of prehension, and are terminated by curved hooks like the thumb of the Bat.

The *Cheiroptera* are endowed with extensive powers of flight. The figure of the Bat presents an outline closely resembling that of birds, and calculated to offer the least resistance in the direction of their motion during flight. Their anterior extremities are constructed like wings, and their whole organization is adapted for aerial progression. The weight of the body compared to the area of their expanded wings is very small, and hence they have the power of raising and supporting themselves in the air. The osseous system is dense, but light, the sternum carinated, the scapulæ and clavicles fitted to support the wings, and to

furnish a large surface for the attachment of the muscles which move them. The fore-arm, consisting almost solely of the radius, does not possess the power of pronation and supination, which would tend to lessen the resistance of the air to the wing in flight; the hand rotates on the radius by abduction and adduction, as in birds, so that, when folded, the little finger lies along the outside of the radius: the fingers, which are of great length, contribute to the expansion of the wing in flight; the thumb, which is not enclosed by the interdigital membrane, terminates by a strong hook for prehension, and for suspending the animal when in repose. The wing, taking its commencement from the neck, extends to the arm, feet, and tail. The interfemoral membrane, when developed, has its margin supported by an osseous extension from the calcaneum; this membrane serves to elevate and depress the axis of the animal, its functions in this respect being analogous to that of the tail of birds. The elastic though delicate membrane of which the wings are composed, gives its stroke upon the air a great mechanical effect.

The proportion of the area of the wings to the weight of the body is greater in Bats than in many species of birds, and nearly approaches that in the Lepidopterous Insects, consequently their power of flight is very considerable.

Bats are capable of increasing the area of their wings during their descent, and of contracting them during their ascent by the alternate flexion, extension, abduction, and adduction of their elbows, fingers, and hands; and they can also vary their velocity, and consequently the resistance of the air during the elevation and depression of their wings in the same manner as birds. The ratios of the times and of the resistances during these movements of the wings, as likewise the number of their oscillations in a given time, may be computed very nearly by the formula applicable to the flight of birds, but owing to the extensive area of their wings compared with their weight, their oscillatory movements are comparatively slow. Their power of flight preponderates greatly over the force of gravity and the mass of their bodies, so that they are capable of flying with great ease, even when laden with one or two young ones. Their centres of gravity and magnitude lie beneath the axes of the articulation of the wings with the trunk, an arrangement which keeps them steady during flight. In repose they suspend themselves by their hind feet to some elevated object, from which on being alarmed they can fly off instantly. Their inferior extremities possess neither the length necessary to raise the body sufficiently to expand their wings, nor the power to project it vertically, like birds on taking flight; but by dropping suddenly from the point of suspension, they are enabled to expand their wings instantaneously and without obstruction in the air. Their velocity is so great that they can overtake and capture their insect food on the wing.

The amount of force requisite for aerial progression is so enormous, owing to the rarity of

the atmosphere, that it would be impossible for a man to sustain himself in the air by means of his muscular strength alone, in any manner he is capable of applying it. It is calculated that a man can raise 13 25 lbs. avoird. to a height of 3.25 feet per second, and can continue this exertion for eight hours in the day, he will therefore exert a force capable of raising 381600 lbs. in the day to a height of 3.25 feet, or 47700 lbs. to a height of 26 feet, which, according to Chabrier, is the height to which a bird would raise itself in one second by the force it is obliged to exert in order to sustain itself in the air. Now, if we suppose the conditions necessary for flight in man to be the same as for birds, and that a man whose weight is 150 lbs. could concentrate the muscular power of a day's labour into as short a period as the accomplishment of this object required, we might find the time t , during which he could support himself in the air, from the following equation:—

$$150 t = 47700,$$

hence $t = 318'$, or about five minutes.

It is, however, impossible that a man could concentrate the force of eight hours' labour into the short interval in which he would have to expend it when supporting himself in the air. The opinions of Borrelli and Chabrier agree with these views, and we are not so sanguine as to suppose with Bishop Wilkins, Sir G. Cayley, and others, that with the assistance of some mechanical contrivance men will some day be enabled to fly by the force of their muscular system. Such hypotheses, like the ancient stories of Dædalus and Icarus, &c. serve only to deceive the ignorant, amuse the credulous, and misdirect the human mind to attempt the accomplishment of impossible objects.

SECT. III. *Swimming*.—In swimming, as in flying, the fulcrum which affords the requisite resistance to the action of the locomotive organs of animals is the fluid medium in which they move, and as this medium yields to the force impressed on it by the organs, it is evident that these modes of locomotion are regulated by different principles from those applicable to animals whose progression is performed upon solids.

The reaction of the water in swimming is equal to the action impressed on it by the impulse of the locomotive organs; and if motion ensues, it results from a surplus force in the body in motion, equal to the difference between the force of the locomotive organs, and the resistance of the medium. The motion is accelerated as long as the force of the locomotive organs is greater than the resistance of the medium reacting against the surface of the animal. When the mean forces urging the animal forwards and the resisting force are in equilibrio, the motion becomes uniform. When these forces are at the maximum, the velocity is also at a maximum. If the weight of the animal be equal to that of the water it displaces, there will be no tendency to rise or sink, as the vertical force of the water upwards will be equal to the force of gravity upon the animal vertically downwards, and forces need only be employed to urge the

centre of gravity forwards, backwards, or obliquely. The case is different with animals moving upon solids, where the weight of the body has to be supported as well as urged forwards by the instruments of progression. When the weight of the water displaced is greater than that of the animal, the body floats upon the surface, as in the Palmipedes; if, on the contrary, the weight of the animal be greater than that of the water displaced by its bulk, a vertical as well as a horizontal force is requisite, equal to the difference of the specific gravities of the animal and the water, to prevent its sinking during progression.*

The animal kingdom includes a vast number of species which are aquatic and constantly reside in ponds, lakes, rivers, and seas, having their general structures organized for inhabiting in these dense and resisting media, and their locomotive organs adapted for swimming. The number of these is far beyond the reach of calculation. Many of the larvæ of insects and the tadpoles of Amphibia, which in their adult state are either entirely or partially terrestrial, commence their career in water; in these not only the locomotive organs, but their respiratory systems undergo metamorphosis.

Ciliograde animals. Under this denomination are comprehended the polygastric and rotatory animalcules, and many genera of the orders, such as the Porifera, Polypifera, and Acalephæ, whose locomotive organs are those minute, transparent, elastic, and very flexible conical filaments well known by the name of *Cilia*. The nature and structure of these organs have been fully detailed in the article *CILIA*, so as to render any further description here superfluous. The cilia act as levers, to which the water is the fulcrum.

We may here refer to the Volvox, as affording a familiar example of ciliary locomotion. The figure of this animalcule being spherical, the cilia placed on its surface are all equidistant

from its centre, but those possess the greatest mechanical power which are placed at equal distances from either pole of the animal's axis of rotation. The volvox is capable of changing its axis of revolution, or varying its direction, and appears to revolve across the field of the microscope like a planet over that of the telescope. In the Rotifera, or wheel-animalcules, the cilia are arranged in rows, around the margin of one or more circular discs, capable of being extended and retracted from the body.* When the tail of the animal is free, it moves by its cilia, pursues, and darts upon its prey in every direction. The Rotifera are also capable of crawling upon solids, by the extension and retraction of the body, the head and tail being alternately fixed points: they are also capable of revolving with great velocity on fixing themselves by the two posterior exsertile bulbs.

Porifera and Polypifera.—The Gorgona and Flustra are for a brief period capable of a ciliograde mode of progression. In the gemmules of sponges the cilia are spread over about two-thirds of the body. According to Grant, these zoophytes swim in a zigzag course, with the bulbous extremities directed forwards; their figure is pyriform; their migrations are of very brief duration, for after the lapse of a few days only, which are spent in seeking for some suitable locality, they fix themselves during the remainder of their lives.

The Actiniæ are capable of gliding upon the discs which form their bases of support. Reaumur asserts that they sometimes invert their position, and employ their tentacles as feet; they also diminish their specific gravity by augmenting their dimensions through the absorption of water; when detaching themselves at the base, they suffer the current of the sea to drift them from place to place.

Unlike most of the Polyypes which are fixed, the *Hydra viridis* is capable of moving in the liquid medium which it inhabits (*fig. 226*). It

Fig. 226.

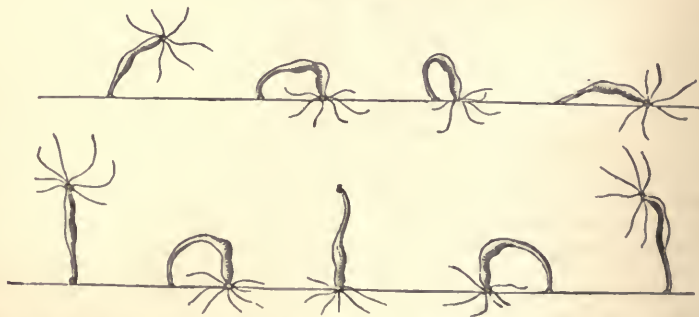

The Hydra viridis represented in its different stages of terrestrial locomotion, as figured by Trembley.

has three modes of progression; the first is accomplished by alternate flexions and extensions of the body; thus the head being fixed by the oral tentacles at *c* (*fig. 227*), the little disc terminating the anal extremity is drawn forwards from *a*, and

fixed at *b*; the head is then raised and carried forwards, by the extension of the body, towards *d*; these two actions of flexion and extension complete a step, whose length is $= ac - bc$. The second mode of progression is performed

* See theory of Specific Gravities.

* See Ehrenberg's Infus. Berlin, 1830.

Fig. 227.



by a series of somersets, the tail being thrown over the head; if the head is first made the fixed point at *c*, as before, the tail will then describe the semicircle *a d*, which is twice the length of a step, or *ad = cd*, in the second movement; the tail being fixed at *d*, the head turns upon it as the centre of a new circle, and takes a position in advance of *d*, at a distance equal to *c d*; in these two actions the animal travels over a space equal to *a b*. In this manner the head and tail are advanced alternately. The third mode of progression is by far the most speedy. The Hydra having crawled to the surface of the water, lifts its tail above it to dry in the air, whereby it exerts a repulsive action on the water; this hydrostatic apparatus, acting as a float, is capable of suspending the body at the surface of the water in an inverted position; in this posture it rows itself along, or is drifted by the winds from point to point without effort.

In the *Beroë* Pileus, the motions are partly by cilia attached to rectangular laminae, which are arranged in rows along the eight costae (*h h*, fig. 32, vol. i.) of the elliptically-formed body. According to Dr. Grant, each row contains about forty laminae, whose transverse section presents literally the appearance of the floats upon the paddle-wheel of a steam-boat: when the whole of these laminae strike the water simultaneously, the resultant of their combined action is in the line of the projection of the axis of the animal, which is usually directed vertically. The direction, however, may be changed by the cilia acting partially, by which the inclination of the axis in the direction of the animal is determined.

The Physalus has the power of rendering itself either specifically lighter or heavier than water, by means of the inflation or contraction of its air-bladder; with the assistance of which the animal is enabled either to swim upon the surface, or sink, if alarmed, into the bosom of the ocean. The swimming-bladder of the Physalus is of considerable dimensions, and nearly of an elliptical figure, its longest axis being directed horizontally. The top of this bladder is furnished with a membranous lamina or crest, serving to increase the surface presented to the wind, before which it sails with considerable velocity. The *Rhizophysa Melon*, the *Agalma Okenii*, and the *Diphyes Campanulifera*, with most of the *Acalephæ*, having already been described and figured in the article *ACALEPHÆ*, the reader is referred to them for further particulars, but it may be remarked that the progression of the *Diphyes* is performed upon the principle of the *Syringogrades*, merely by the reception and expulsion of water by

their two truncated sections, which, taking place alternately, gives the animal a mean uniform motion of considerable velocity.*

Cirrigrade animals.—Unlike the entirely soft gelatinous forms which compose the *Pulmograde* and *Ciliograde Acalephæ*, the *Cirrigrade* group have an internal solid skeleton to support their soft and delicate exterior tissues. In the *Porpita* this skeleton is composed of a flat, circular, semicartilaginous plate, which lies horizontally on the surface of the water; to this plate are appended numerous cirri which perform the office of oars in rowing the animal on the surface of the sea: the *Porpita* is permeated with pores, which being filled with air render it of less density than the water upon which it floats. The *Velella Limbosa* has a thin perpendicular crest resting obliquely upon the horizontal plate, which being elevated above the water, and presenting a considerable surface to the wind, serves as a sail. In the *Rataria cordata*,† the crest is furnished with muscular fibres, by which the sail can be elevated or lowered at pleasure; but this does not take place without altering at the same time the centre of gravity; for the position of the body is nearly reversed when the crest is lowered, but it recovers itself on the crest being elevated.

Pulmograde animals.—The umbelliform or mushroom-shaped disc of the *Rhizostoma* being capable of expansion and contraction at the will of the animal, is employed not only to keep the body (which is specifically heavier than water) at its surface, but also to propel it along. When the plane of the disc lies horizontally, and its whole margin contracts simultaneously, the percussion given to the water is perpendicular to the plane, or in a vertical direction, and the animal receives an ascending impulse equal to the force of the reaction caused by the displacement of the water. In moving horizontally, the centre of the disc is turned in that direction, and the animal can also accelerate its descent by the assistance of the disc. The contractions of the disc are isochronous, and repeated about fifteen times in a minute,‡ or $15 \times 60 = 900$ times in an hour. The convex surface of the *Aurelia arita* is directed forwards in progression; in this position the whole margin of the disc is called into action, by which the locomotive force is increased, and owing to the figure of the disc the resistance of the water is diminished, and the speed is consequently accelerated.

Syringograde animals.—Under this denomination we shall include the *Holothuria*, the *Salpæ*, and the larvæ of those insects whose progression is effected by the alternate reception and expulsion of water to and from their respiratory organs by an action similar to that of the syringe. Independently of moving upon solids by means of its tubular feet, the *Holothuria*, according to Muller, is capable of drawing water into its cloacal aperture, and by means of its muscular system, of expelling it from its respiratory

* See vol. i. p. 35 *et seq.*

† Vide Art. *ACALEPHÆ*, vol. i. p. 40, fig. 12.

‡ See Grant's Lectures, *Lancet*, 1833.

organs with sufficient force to propel itself through the surrounding medium. The progression of the *Salpa cristata* is effected by drawing water into its body, at an opening situated in the posterior segment of the mantle, where a valve (fig. 228 c) is placed to pre-

Fig. 228.

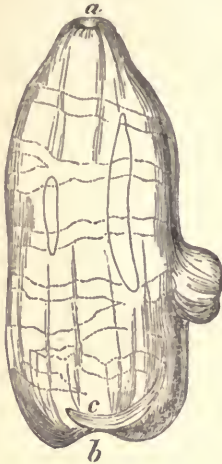
*Salpa cristata.*

vent its returning by the same aperture; the mantle having been distended by the water, contracts upon it, by which action it is expelled at an opening situated at the side of the mouth (a); its progression is retrograde, or in the direction of a b, opposite to that of the fluid in b a.

The larvæ of some Dragon Flies, such as the Ashna and Libellula, draw in and expel the water alternately at the anus, which they occasionally lift out of the water, and project a small stream at a distance above the level of its surface: the hydrodynamic effect of these actions is to give a locomotive impulse to the centre of gravity in a direction opposite to that of the ejected fluid. The reaction of the water, which is equal to the action of the ejected stream, is not only sufficient to overcome the resistance of the surrounding medium and the inertia of the body of the animal, but also to drive it along. The velocity of the Syringogrades is accelerated during the expulsion of the water, and retarded during its reception; consequently the motion is never uniform.

The *Vermiform* animals are for the most part destitute of distinct locomotive organs, yet, owing to the flexibility of their lengthened and usually cylindrical bodies, they swim with great facility. They glide by a series of lateral undulatory movements of the body, with which they strike the water obliquely backwards, and with equal force on each side of the axis of motion, so that the force impressed on the water is translated to the centre of gravity of the animal in an opposite direction forwards; the composition of all the forces giving a resultant the di-

rection of which coincides with the axis of motion. Many serpents whose habits are chiefly terrestrial, swim with the head elevated above the surface of the water; others glide entirely beneath it. Some of the Entozoa, as the *Tenia*, and, among the Annelides, the Planariæ, when immersed in warm water, swim by similar undulations of the body; the latter, however, with the ventral aspect upwards. In the Ophidian Hydrophili, or water-snakes, the tail is flattened; and its planes being directed vertically, give it the properties of a powerful oar, in striking the water by lateral oscillations. In many chetopod Annelides, the setæ and cirrhi form numerous and complex external organs of progression. The *Terebella* has four rows of setæ in tufts; the dorsal row projecting in the horizontal, the ventral in the vertical plane. They extend along the whole of the elongated subquadrate-shaped body. In the Eunice Gigantea, which grows to the length of more than ten feet, each ring is furnished with two lateral packets of bristles, and two cirrhi. In the *Nereis nuntia* the locomotive organs are complex and greatly multiplied. The cirrhi and setæ may propel the body forwards, independently of those undulatory movements which are indispensable for the progression of the apodous Annelides.

Aquatic insects.—The perfect insects swim like quadrupeds and birds, by the alternate flexion and extension of their legs. Amongst the aquatic insects the *Dytiscus* is one of the best organized for swimming; its figure resembling that of a boat, being calculated to glide through the water with little resistance. The posterior legs are greatly developed, and they are moved by powerful muscles performing the office of oars, and are the principal instruments used in swimming. Their movements forwards are made in a plane nearly horizontal. The haunches being fixed to the thorax, give firmness and precision to these legs, which do not differ materially from those of other Coleoptera, with the exception of the tarsi, which are much flattened, and present their broad surfaces to the water. They are furnished with rows of stiff hairs, which bend when the leg is carried forwards, and become straight when its movement is vigorously reversed, thus increasing the

Fig. 229.

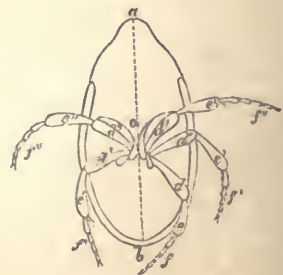

The *Dytiscus*, from Straus-Durckheim, showing the various positions which the posterior legs take in swimming.

effect of the stroke. In the back stroke, the thigh (*d*, fig. 229) moves first, describing an arc of a circle about their iliac extremity, from *d* to *d'* and *d''* successively. During this movement the legs *e* and tarsi *f* are flexed passively, and carried forwards to *e'*, *f'*, so as to act with little effect on the water. The two thighs *d''* *d'''* begin to approach their greatest flexion forwards, the legs *e'* *e''* and the phalanges *f''* *f'''* extend in succession, so that the water opposes resistance to only one of them at a time. The tarsi (*f''*) having been completely extended outwards, the two legs are suddenly carried backwards, pressing on the water, with the entire plane of the tarsi, and as the silky fringes which cover the phalanges are extended at the same instant, their surface is considerably augmented. The other parts of the two legs pressing upon the tarsi, as in the walk or the leap, projects the body forward in the direction of its axis. In walking, the two members of the same pair act alternately, in order to serve, each in its turn, as a support to the centre of gravity. In swimming, on the contrary, the two members move simultaneously, in order to give the greater impulse, and it is in this respect that swimming differs essentially from walking, and more nearly approaches leaping. The middle legs of the *Dytiscus* act in a manner similar to the posterior, but being shorter and weaker, contribute little towards accelerating the movements of the animal; the anterior pair appear to be used chiefly for the purpose of altering the direction of its motion.

The motions of insects in the water may be thus explained: let *a b* (fig. 230,) be the axis of the body passing through the centre of gravity *o*; and let *c o* be the excess of the specific gravity of the water over that of the insect, acting in a vertical direction upwards; and *d o* the resistance of the water to the insect moving in a direction oblique to the axis of the body; this

Fig. 230.

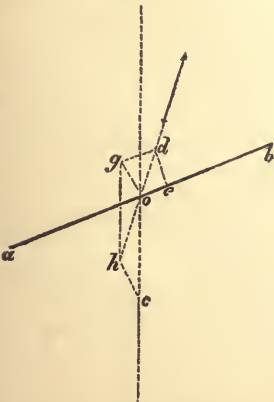

latter force is decomposed into two forces, one in *d g* parallel, and the other in *d e* or *g o* perpendicular to the body, the former of which is lost, and the latter forces it obliquely down-

wards and backwards; this force being combined with the force of the water *c o* produces a resultant in *h o*, opposite to *d o*, which is the force by which the insect ascends passively. On the other hand, when the insect moves horizontally with its axis inclined in *a b*, and its centre of gravity in *o*, (fig. 231,) let its

Fig. 231.

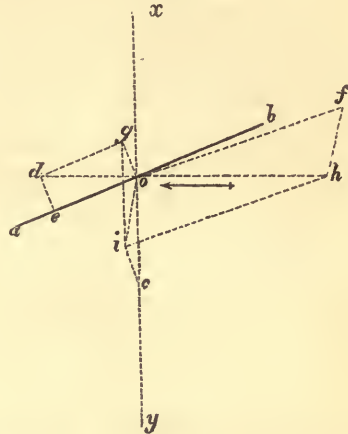

A figure from Straus-Dürckheim, to illustrate the movements of insects swimming horizontally.

velocity be represented by *h o*, so that the force in this direction may be the resultant of the forces of the locomotive organs, of the water *c o*, and of the resistance which it opposes to the motion of the body in the direction of *d o*, opposite to *h o*. The resistance of the liquid in *d o*, acting obliquely upon the plane of the body, *a b*, (which is known from the velocity of the body and the inclination of its axis to the horizontal plane,) may be decomposed into two forces, one in *d g* or *e o* parallel, and the other in *d e* or *g o* perpendicular to the body; the former is ineffective, and the latter tends to force the body backwards and downwards. The force *g o*, being combined with that of the water *c o*, produces the resultant *i o*, which, with the force of the oars, must give the two components of *h o*. Completing the parallelogram of forces, of which *h o* is the diagonal, we find that the legs must generate a force represented in magnitude and direction by *f o*, and it is in the direction of this component, or, more correctly, in a line parallel to it, that the centre of force of the feet ought to act, which is in fact the case.

The *Hydrophilus* has nearly the same form as the *Dytiscus*, but is not quite so well organized for swimming. The *Gyrinus* also, as well as the *Hydrophilus*, swims in conformity with the same principles as the *Dytiscus*. The *Nepa*, being ill organized for swimming, usually walks in the water. The *Hydrometra* being so light, and having a little globule of air attached to its feet, has the power of swimming on the water without sinking. The *Notonecta*, in which the centre of gravity lies above the centre of

magnitude, swims in an inverted position; it is propelled exclusively by its posterior legs, which are lengthened, and move in a plane parallel to the axis of the body. The thighs, legs, and tarsi are nearly of equal length; the two phalanges, which are slightly flattened, are furnished with hairs to strike the water with greater force, and to vary the surface presented in the effective back strokes. When the insect is poised freely in the water, its centre of gravity lies in the vertical line, passing downwards from the centre of the figure. From the singular circumstance of its swimming on its back, it has derived the appellation of *Notonecta*.

Decapods.—In the Crustaceous Macrourous Decapods, such as the Lobster, Prawn, and Shrimp, the tail is prolonged, and equals the length of the body. It is the principal organ of locomotion, and the seven segments which compose it are nearly of a semi-elliptical form, the terminal being furnished on each side with laminae, which the animal spreads out transversely like a fan, in order to produce a greater surface in striking the water. At the dorsal aspect, the segments of the tail are locked before its extension is completed, but on the abdominal aspect there is greater freedom of motion. The segments of the tail are articulated with each other on both sides by ginglymoid joints, of which the axes of rotation are directed perpendicularly to the plane of the mesial section, consequently their motions are restricted to one plane. A slight eccentricity, however, in the direction of the articulating axes of the joints permits a limited obliquity of motion in the tail, but at the expense of muscular power. In swimming, the convex surface of the tail is presented to the water during the back stroke, and the concave ventral surface in the effective stroke, by which the force translated to the centre of gravity in flexion is to that of extension nearly as two to one.* During each flexion of the tail the animal is propelled backwards, and its velocity is accelerated, but during each extension it is retarded, so that its movement is retrograde and accomplished by a succession of impulses. In the swimming Decapods, the thoracic stemmata are laminated to assist in progression.

The Cephalopods.—The Cephalopods swim according to the same principles as the Holothuria, by admitting water into the interior of the body and jetting it through the funnel with sufficient velocity to communicate a locomotive retrograde impulse to the animal, which enables it to traverse the sea with considerable speed. From the time of Aristotle to that of Cuvier, the Argonaut, or Paper-Nautilus, has been supposed to have its slight and delicate monothalamus shell designed for a boat, and the broad expanded membranes terminating the two dorsal feet organized for sails; but, whatever poetry may have been associated with this view, must be abandoned by the Zoologist for

the more modern and more physiological conclusions to be deduced from the researches of M. Sander Rang[†] and Madame Power, who have discovered and assigned the true function of these expansions, the fabrication of the shell.

Pteropoda.—Amongst Pteropods, the *Clio Borealis* presents a conical shaped body about an inch long; its locomotive organs consist of two uniform expansions attached on each side of the neck, the planes of which lie parallel to the axis of the body. According to Eschricht, the fins are composed of one muscular fasciculus, which passes through the neck, and this muscle acts in a manner resembling the principle of the double-paddled oar with which the Greenlander steers his course on the surface of the same seas wherein the *Clio* is found. The inclination of the planes of the fins to that of the axis of the body determines the direction of the animal. The *Clio*, however, is destitute of organs of prehension, and consequently incapable of fixing itself to solids; it must therefore either remain at the bottom of the sea or paddle its course upon the dense medium which it inhabits.

Pisces.—Amongst the great multitude of animals moving in seas, rivers, and lakes, Fishes next claim our attention. The medium in which fishes move being nearly of the same specific gravity as themselves, they are sustained by such an amount of hydrostatic pressure as almost to neutralize the force of gravity upon their mass, so that organs of progression, calculated to support nearly their whole weight, such as occur in terrestrial animals moving on solids and in a rarer medium, are unnecessary. We observe also that as they are sustained on all sides by great hydrostatic pressure, they do not require their organs of support to be of that magnitude and density which are requisite to terrestrial Mammalia for resisting the shocks of external forces. In the osseous fishes the bones are, therefore, light and elastic, and in the cartilaginous fishes the organs of support are still more light and flexible. The specific gravity of fishes, although small, is greater than unity, consequently we know, by hydrostatic principles, that without continued muscular effort, or some provision for rendering themselves of equal or less specific gravity than the water, they must sink to the bottom and remain there; † but the economy of a great number of fishes requires that they should sustain themselves permanently far above the solids forming the beds of rivers, lakes, and seas, and that they should be enabled to rise to the surface, or sink into the depths of the ocean in pursuit of their prey. As this, however, would otherwise require a vast and never-ceasing play of muscular action during life, Nature has provided them with an apparatus which prevents this waste of muscular energy by the introduction into their system of the *air-bladder*. This hydrostatic apparatus is of various shapes, but always of sufficient dimensions to contain, when it is distended, as many cubic inches of air as will render the fish specifically

* See Principles of Resistance of Curved Surfaces moving in Fluids.

† Vide Guerin's *Magazin de Zoologie*.

† See Theory of Specific Gravities, sect. 1, p. 412.

lighter than water, and as the specific gravities of air and water are to each other nearly as 1 to 815, a small bulk is sufficient to render the lesser fishes lighter than the medium they inhabit. The position of the air-bladder being immediately under the spine and above the centre of gravity causes the fish to rise without the danger of turning over on its back. Those fishes which are furnished with an air-bladder are capable of either renewing, expelling, compressing, or dilating its aerial contents, and of varying its area so as to rise, sink, or remain in equilibrium. The air-bladder becomes by this means an important auxiliary organ of locomotion, and affords an illustration of one of the many evidences of design in the primary formation of aquatic animals.

The *Diodons* and *Tetrodons* render themselves buoyant by swallowing air, which filling the first stomach becomes inflated like a balloon; but as the gastric reservoir lies below the centre of gravity, the bodies roll over in an inverted position, and are driven in the direction of the winds and tides without the power of directing their course.* The forms of fishes are considerably diversified, being spherical in the globe *tetodon*; an elongated cylinder in the Eel; compressed in the Dory and Spah; flattened into planes parallel to the mesial section in the Pleuronectidæ; elliptical in the Salmonidæ, Scomberidæ, and Mugilidæ. In nearly all the orders of fishes the surface presented to the water by the head and shoulders inclines more or less to the vertebral axis of the fish, which coincides with the axis of motion, and therefore is adapted to offer resistance, which varies with the angle of inclination.

In the Salmon, Cod, and Mackerel the form of the body approximates to that which is considered by mathematicians to offer the least resistance to the surrounding medium. The organs of support are developed principally in the plane of the mesial section, and consist of superior and inferior spinous, interspinous, dorsal, and ventral fin elements, the projections of which prevent motion of the vertebral axis in the plane of the mesial section. The vertebrae are short, numerous, and, towards the caudal extremity, destitute of transverse processes, an arrangement which gives the tail a considerable degree of lateral motion; owing to which it becomes the most essential organ of locomotion. The locomotive organs of fishes are the fins and tail; the pectoral fins represent the anterior, and the ventral the posterior extremities of the higher orders of Mammalia. In the Cod, the legs are absolutely in front of the arms, being suspended under the throat. The Percidæ, which are provided with two dorsal, two pectoral, and two ventral, as well as anal and caudal fins, have the greatest number of locomotive organs. The planes of the dorsal and anal fins are in the mesial section of the fish, and being restricted in that plane by a kind of ginglymoid joint, are capable only of elevation and depres-

sion. In the Cod, Halibut, and Gurnard, the action of these fins serves merely to increase or diminish the lateral surfaces of the fish, so as to prevent any tendency in the animal either to oscillate laterally, or turn upon its vertebral axis into an inverted position, which it would be inclined to do without some muscular effort, since in the erect posture the centre of gravity lies above the centre of figure.* The plane of each ventral fin is in general nearly horizontal, and perpendicular to that of the caudal; their action serves to balance the body, to incline it on either side, when one fin only acts, and to elevate and depress the fish by their joint effort.† In many fishes the pectoral fins being at right angles to the tail and vertical, act horizontally, and communicate either a progressive or a retrograde impulse to the body, thus assisting the action of the tail; if they are both retained in an extended position, they will retard the velocity of the fish; if one pectoral fin only is extended, it will turn the fish in a curve towards that side; if the other only, it will turn it on the opposite side: they thus perform the office of a rudder. When the planes of the pectoral fins are directed obliquely forwards and upwards, they communicate an ascending and a retarding impulse to the fish, but the amount of retardation is compensated by the power which the fish acquires of ascending. When the caudal, ventral, and oblique pectoral fins move simultaneously, there result three forces acting in different planes, whose intensities, estimated in directions perpendicular to those planes, are severally proportional to the products of their areas multiplied into the squares of their velocities;‡ the resultant of these forces may be obtained by the law of the parallelogram of forces.§

In the Rays, the pectoral fins are developed to an enormous extent, and being directed horizontally, their action is vertical, like the wings of a bird. They are furnished with a great number of joints, which endow them with considerable mobility; they have the power to increase the surface of the fin during depression, and to diminish it during elevation. The disc of the ventral fins lies in the same plane as the pectoral, and acts in a similar manner, but the plane of the caudal fin is at right angles to them. The depression of the pectoral and ventral fins elevates the fish, whilst the lateral motions of the tail propel it forwards. The area of the pectoral fins in the Rays is very great compared with that of the caudal; and

* In *Piscibus*, pars gravissima ossium spinæ, copiosissima caro muscosa in dorso supremo posita est, vesica vero aerea in infimo ventre reconditur; ergo centrum gravitatis Piscium supra centrum magnitudinis eorum in supremo dorso positum est; et ideo, dum in aqua imitant, naturali instinctu revolvantur ventre supino, quæ positura cum natant valdè incommoda sit, conjuntur Pisces artificiosè se retinere situ erecto. Borrelli, loco cit. p. 257.

† *Pinnæ duplicatæ, quæ in duobus locis infimi ventris piscium existunt, non inserviunt ad motum, sed ad stationem eorum.* Borrelli, loco cit. p. 257.

‡ See resistance of fluids.

§ See method of rectangular co-ordinates.

* See Dr. Rogt's Bridgewater Treatise.

the intensity of their action (all other things remaining the same) must be proportional to their areas respectively. Sometimes the Rays glide sideways, in which motion the pectoral and caudal fins exchange their office, the former striking horizontally, and the latter vertically, the result of which may be obtained by the composition of forces, when their directions and intensities are given. The Rays, being destitute of an air-bladder, require a much greater force in the vertical direction upwards to sustain themselves in swimming; hence the necessity for the power and mobility of the pectoral fins which we find conferred on them. The great lateral development of the surface of the Rays compared with their depth, and the great depth of the Pleuronectides compared with their breadth, entitle the former, rather than the latter, as Mr. Yarrell justly observes, to the appellation of *flat fish*.

The first movement of a fish from a state of rest is usually produced by the flexion of its tail, as to *a*, fig. 232; during this action the centre of gravity (*c*) recedes slightly from its previous position; the tail being flexed into the position *a*, is forcibly extended by the muscles on the opposite side, in the direction of the line *a i*, perpendicular to its plane. The force of its action upon the water in *a i* is translated to the body of the fish in *i a*, causing the centre of gravity *c* to move obliquely forwards in the direction of *c h*, parallel to *i a*. The tail having reached the mesial line *c d*, its power of urging the centre of gravity forwards not only ceases, but during its flexion in *e o*, it acts backwards in the direction of *o e*; having reached the point *o*, it is again forcibly extended in the line *o e*, causing an impulse on the centre of gravity in *c b*, parallel to *o e*; if the two forces *c h* and *c b* acted simultaneously, we should obtain the resultant *c f*, but as they do not, the point *c* will not move exactly in the right line *c f*, but in a curved line,

Fig. 232.



which lies evenly between *d c f* and a line drawn parallel to it through *h*. The fish being in motion, the tail describes the arc of an ellipse,* whereas if it were stationary, it would describe the arc of a circle. If we suppose the force resulting from the flexion of the tail to be so great as to neutralise the velocity which the centre of gravity had acquired during its extension, the result would be a state of rest whenever the tail reached the points *a* and *o*, and a greater force than this would

cause it to recede; which, according to Sir John Lubbock,* is the case, although it has never yet been detected in the movements of the living animal. The minute investigation of this subject, however, embraces a very complex analysis.† There are several circumstances which militate against the hypothesis of Sir John Lubbock; first, the muscles which move the tail are capable of varying its surface during flexion and extension, and of contracting it during the former and expanding it during the latter action, by which the resistance is proportionably varied. Secondly, the muscles of the tail incline its plane to the direction of its motion during flexion, and present its plane perpendicularly to that direction during extension, which causes the effective resistances in the two strokes to be to each other as $1 : s^2$, where *s* is the sine of the inclination of the tail to the horizon. Thirdly, according to Dr. Roget, the water having been set in motion during the extension of the tail, in the same direction, offers comparatively but little resistance in flexion; on the contrary, when the motion of the tail is reversed, the water meeting it in an opposite direction produces a resistance proportional to the sum of the squares of the two velocities. These are so many causes which contribute to diminish the force of the tail during its flexion, without producing a retrograde motion in the fish. The same demonstration serves when the plane of the tail is directed horizontally, as in the Cetacea and Flat Fishes, but the impulse given must be estimated in a vertical instead of a horizontal plane. The velocity of some fishes is very considerable, and often maintained for lengthened periods. According to Lacepede, that of the Salmon is eight metres, or 26·24 feet in a second; others are said also to travel upwards of sixteen miles in an hour; the Shark, for instance, will often accompany and gambol around a ship in full sail across the Atlantic. In those fishes which have the greatest velocity the tail is forked, the area is in the inverse ratio of the distance from the centre of gravity; in these the centre of force is one half the distance from the centre of motion. When the tail presents a triangular surface, of which the apex is the centre of motion, the centre of force is three-fourths the distance of its base from the axis of oscillation. With this form of tail the muscles act at a mechanical disadvantage, and consequently the animal moves very slowly.

If we consider the density of the medium in which these animals move, the resistance which it opposes to their bodies, and the long periods during which they will continue in progression, we may form some idea of the great energy with which their muscular system is endowed.

Aquatic Birds.—In the Aquatic Birds, the thorax and abdominal regions present a form

* See Dr. Roget's Bridgewater Treatise, vol. i. p. 369.

† See Chabrier, Mém. de l'Acad. des Sc. tom. xi. In this paper formulæ are given for finding the velocity of the centre of the tail and the quantity of action expended in swimming.

resembling the keel of a boat. The feathers are furnished with an oleaginous secretion, which prevents the water from penetrating to the skin; they also enlarge the bulk of the bird without very sensibly increasing its weight. In the Palmipedes, the osseous system, though more dense and less permeated with air than in birds destined for long and continued flight, is yet so light as to render their specific gravity considerably less than water, so that a large proportion of the body is sustained above its level by hydrostatic pressure alone. The interdigital membranes which give an expanded surface to the feet of these birds, acting at the end of the long lever, formed by the metatarsal bone, enable them to strike the water with considerable force.* In the effective stroke produced by the extension of the legs, the flat surface of the feet is presented to the water in the direction of motion, whilst in the back stroke they are drawn forwards very obliquely and with less force. In the former action, the centre of gravity is accelerated, but during the latter it is retarded, so that there results a succession of impulses and a variable motion. The Swan and other Palmipedes sometimes spread out their wings as a sail, upon which the wind acts with sufficient force to propel them along without the expenditure of any muscular power. The specific gravity of birds, being much less than unity, enables them to glide upon the surface of the water without any expenditure of muscular action in the vertical, consequently it is required only in the horizontal direction.

Quadrupeds.—Many quadrupeds have their feet palmated to afford a larger surface for striking the water in swimming. Many of the Saurian, Batrachian, and Chelonian tribes have their feet thus organized, though the Caymans are semipalmated. The lateral direction of the locomotive organs of the three former orders enables them to give an oblique stroke downwards and backwards, so as to communicate an ascending as well as a horizontal impulse to the centre of gravity, and thus to prevent their sinking whilst they are urged forwards. In the common Otter the feet are also palmated, a construction which enables them to move in the water with surprising agility, and with sufficient velocity to overtake and capture the fish on which they prey. In a similar manner the feet of the Newfoundland Dog are also furnished with interdigital membranes, but owing to the number of their respiratory movements in a minute they are incapable of remaining below the surface of the water for lengthened periods. The Ruminantia, Carnivora, and Pachydermata, being all of less specific gravity than water, can swim with facility, and their locomotive organs, acting as in terrestrial progression, render swimming a task of easy accomplishment. Quadrupeds swim by the alternate extension and flexion of their legs; the effective stroke is performed during extension, and the back stroke during flexion,

presenting in the former a larger area to the water than in the latter. In consequence of the difference of their specific gravities, the Horse is capable of swimming even when loaded with the weight of a man, with a large proportion of its body above the surface of the water. The feet of the Solidunguli are well formed for striking the water, the flat portions of which are employed in the effective and the convex in the back stroke, so that the proportion of the resistance of the water in these two strokes, owing to the figure of the foot, are to each other nearly as two to one.*

Man.—The figure of the human body, the position of the respiratory apertures, the number of respiratory movements made in a minute, the different plane in which the locomotive organs usually act in terrestrial progression, and the small surfaces which the hand and feet present to the water, contribute to render man the least adapted of almost all animals for swimming. The specific gravity varies in different individuals; it is rather greater than water when the chest is nearly exhausted, and less when well expanded with air; hence a man has always an hydrostatic apparatus which will keep him floating, if he has the knowledge of this fact and sufficient presence of mind to employ it. The density and temperature of water produce at the moment of immersion an involuntary expulsion of air from the chest, added to which the consequent alarm and misdirected struggles facilitate the fatal catastrophe of drowning. In swimming, the hands and feet are employed so as to present the least surface to the water in the back and the greatest in the effective stroke; in the former the hands are brought near the mesial plane, with the palmar surfaces parallel to each other; they are then thrust forward by the extension of the arm, with the points of the fingers in advance to cut the water with the least resistance; when the hands have nearly reached their greatest distance from the centre of gravity, they are rotated by pronation, so that the palms are directed at an oblique angle outwards and downwards; they are then forced backwards by the abduction of the whole arm through a large arc of a circle, having the shoulder-joint for its centre, and the length of the arm for its radius; the fore-arm is then flexed, and carried into its former position preparatory to making another stroke. During the extension of the arm, the feet are drawn towards the centre of gravity, with their convex surface directed obliquely backwards by the extension of the ankle and flexion of the hip and knee joints, and during the adduction of the arm the flat surfaces of the feet are driven forcibly backwards and downwards by the sudden extension of the leg. From the ratio of the areas of the hands and feet, and the ratio of the difference of their velocities in the two strokes, there results such a preponderance of the force in the vertical direction upwards and in the horizontal direction forwards as is sufficient to keep the respiratory openings above the surface of the

* See Principles of the Resistance of Fluids.

* See Resistance of Fluids.

water, and to overcome the resistance which the water opposes to the motion of the body, due to its figure and velocity. In resisting media, both the facility with which bodies immersed are supported, and the difficulty of moving through them, increase with the density of the medium: this arises from the increased resistance which the particles oppose to their displacement; hence, according to Borelli, fishes expend, in order to acquire a given velocity, nearly twice as much animal power as birds, but are supported in the fluid without any exertion, whereas birds, as we have seen, are obliged to use considerable force to sustain themselves in the air.*

SECT. IV. *Progression on solids.*—The progressive motions of animals on solids are accomplished with much less expenditure of muscular action than is employed by animals in swimming or flying. In the various movements of animals upon solids the reaction of the ground is always equal and opposite to the quantity of muscular action impressed on it.† The velocity being equal, muscular action increases as the resistance of the solids decreases; hence the augmentation of labour in walking on a loamy or soft soil, such as the sands on the sea-shore. If an animal were projected into space, and moving in an unresisting medium, no effort of its limbs would ever enable it to change either the velocity or direction of the motion of its centre of gravity. From these dynamic considerations we perceive the importance of a surrounding resisting medium to animal progression. We shall now trace the modes of terrestrial progression from the lower forms of the animal kingdom successively through the intermediate groups, to man.

Radiata.—In the general outline of the Echinodermata we observe great diversity in the structure of the organs of support and locomotion. The Crinoidea belong most generally to those forms of the Echinodermata which are permanently fixed. Amongst the Asteroidea, in the Comatula, the locomotive organs consist of long, complicated, flexible arms radiating from a common centre, and subdividing into numerous filaments covered with spines, which perform the office of so many legs, enabling the animal to drag itself along the bottom of the sea, or of so many tentacula to lay hold of surrounding solids or to seize their prey. In the Ophiura the rays are of considerable length, being composed of a great number of pieces curiously imbricated and connected together by ligaments; they are flexible and moveable in every direction, and act not only as legs for crawling on the ground but also as fins, which, by a kind of undulatory movement, enable the animal to swim during short intervals. In the Asterias the

five rays diverge at nearly five equal angles from the axis of revolution. In the Sea-star each ray, according to Reaumur, is composed of seven hundred calcareous plates, of which there are about three thousand five hundred in the whole animal. The rays of the Asterias do not possess the flexibility of those of the Comatula or Gorgonia, and of themselves would be insufficient to propel the animal along. Nature has therefore substituted other organs of progression in tubular, retractile, fleshy suckers, protruded from oblique ambulacral perforations, by means of which the animal is dragged along the bottom of the sea or upon the vertical surfaces of submarine rocks. If an Asterias left to all appearance motionless and inanimate by the retiring waves, be picked up from the beach, and placed in a large glass jar filled with sea-water, an astonishing spectacle will be observed. "Slowly," says Professor Rymer Jones, "the rays expand to their full stretch; hundreds of feet protrude through the ambulacral apertures, and each apparently possessed of independent action, fixes itself to the sides of the vessel; as the animal begins its march, the numerous suckers are all soon employed in fixing and detaching themselves alternately, some remaining adherent, whilst others change their positions; and thus by an equable gliding motion the star-fish climbs the side of the glass." The progression of the Asterias is laboured and exceedingly slow, and ill adapted for traversing such surfaces as the rough shingles of the sea-shore.

Echinida.—The Echinus Esculentus is one of the most complicated and elaborately formed species of the whole Echinodermata; its figure is spherical: the five pairs of arched ambulacral, and five pairs of tubercular columns, are joined to each other by zigzag sutures. The numerous spines are connected to the tubercles by a ball and socket articulation. According to Dr. Grant, the skeleton is composed of more than ten thousand pieces, the spines acting as so many inflexible levers, and the numerous suckers protruding through the oblique ambulacral foramina, as so many feet, form a double set of organs for progression.*

In the Echinus, the spines being perpendicular to the shell, elevate its centre of gravity (which, on account of its globular figure, is in the centre of the shell) far above the plane of motion, protect the shell from internal injury, and increase the diameter of the whole sphere, with respect to that of the shell alone, by twice the mean length of the spines. From the nature of their articulations, the spines are capable of moving in every direction upon their tubercular attachments; but these alone would be insufficient to enable these animals to climb the sides of submarine rocks and vertical precipices in search of shell-fish on which they prey; but by the aid of their tubular feet, which they have the power of extending beyond the spines, we behold in the Echini the

* See Borelli, p. 260.

† Barthez, in opposition to Euler, Borelli, and others, denies that *reaction* is the cause of progressive motion on solids, but in the explanation which he gives of it it is difficult to understand his reasoning, without taking into account the *resistance* of the ground.

* Grant's Outlines of Com. Anat. p. 18.

curious spectacle of globular bodies moving in direct opposition to the force of gravity. The structure of this interesting animal in a mechanical point of view is worthy the profound attention of the mathematician, as well as of the anatomist and physiologist.

SECT. IV. *Annelida*.—The terrestrial Annelides, such as the Lumbrici or Earth-worms, have the body cylindrical, and divided into upwards of one hundred and twenty segments, which permit of extension and contraction, with the power also of curving the trunk vertically and horizontally, according to the play of the muscular system. The progression of the Lumbrici is aided by their retractile setæ, or conical spines, eight of which are attached to each ring, consequently there are as many or more than $8 \times 120 = 960$ of these setæ in a single worm, to assist its locomotion. As many of the Lumbrici attain the length of nearly twelve inches, there must be about twelve rings or segments in an inch of the body taken longitudinally; now each ring being articulated with great freedom of motion, and the integuments being soft, flexible, and elastic, the trunk possesses very great mobility.

The locomotion of the Lumbrici is simple, and performed in the following manner. When the animal is about to advance, the head is raised, and about fifteen or twenty of the anterior segments are extended and placed firmly upon the plane of position; the setæ and rings assist in fixing the segment in advance; this being effected, the next fifteen or twenty rings are drawn forwards, and the setæ are again fixed in a similar manner; subsequently a third and fourth series successively complete the progression of a step. The space taken at each advance depends on the energy and magnitude of the animal, and the nature of the surface on which the movements are performed. Some Lumbrici, about six inches in length, having been placed upon a smooth surface, performed a distance equal to their own length at six or seven complete steps, taking about one inch at each advance; this occupied nearly one minute of time, being a velocity of progression of about thirty feet per hour. The smoothness of the surface retarded the celerity of their movements in consequence of the setæ being incapable of fixing the segments against any points with sufficient power to enable them to draw the succeeding segments forward; under these circumstances the mouth was observed to be substituted, and to lay firm hold of the surface, whilst the anterior segments were drawn forwards. The Lumbrici are capable of ascending a plane inclined at an angle of 45° to the horizon, provided its surface presents sufficient irregularities for the application of the rings and setæ. The centre of gravity of the Lumbrici is very near the middle of their length. The cylindrical form of the articulata, and the minute dimensions of the setæ, render them (with such a limited basis of support) very liable to turn upon their axis, and roll over on their backs, but they readily recover the pendent position of the abdomen by bending the trunk forwards into an arch, with its

convexity resting on the plane of motion, and the head and anus raised above it, but inclined to one side: the inclined direction of the raised segments causes the animal to revolve on its axis, and regain its natural position.

When irritated, the Lumbrici contract and contort the body into curves resembling in form the letter S; they appear capable of contracting the body to one half of its entire length; in which condition the integuments present a corrugated appearance. The Nais and Naiades are swimmers. The Hæmocharis walks like the caterpillar of the Geometra. The Hirudines, or Leeches, are more developed in a transverse direction than the Lumbrici; in these animals the mouth is surrounded by a lip, and the anal extremity is furnished with a flattened disc, each of which is capable of causing a vacuum, and the head and anus being fixed to the plane of position, whilst the body is elongated and contracted alternately, the locomotion is effected. Leeches are well known to be capable of thus ascending vertically upon the smooth surface of glass, to which they adhere with considerable force.

Insecta. Apode larvæ of Insects.—The number of segments which compose the lengthened cylindrical form of the Apode larvæ and the disposition of the muscular system permit the trunk to be moved in various directions; to be elongated, contracted, curved upwards, downwards, or on either side, thus contributing to the progression of the Apodes. The cephalic, thoracic, and abdominal sections, which may be considered as merely auxiliary organs in animals furnished with arms and legs, are employed by the cylindrical Apodes as the sole instruments of locomotion.

The progression of the Balaneus Nucium, the Maggot of the hazel-nut, is thus performed. Having first laid hold, with the mouth, of some point in the plane of position, the body is contracted and curved upon itself, and the anal extremity drawn forwards; the latter then takes a fixed point for a fulcrum, and the segments which had previously approximated during the contraction, are again separated in succession from behind forwards, causing a slight undulation of the body in successive curves, vertical to the plane of motion. The head having been projected forwards by the elongation of the trunk, repeats the same actions, recurring as before, in succession. Their progression is slow and laborious, each step not being more than from one-twelfth to one-fourteenth of an inch. The Cionus Scrofulariæ, like the common Snail, secretes a slimy substance which enables it to walk on the leaves of the figwort, on which it feeds.* The larvæ of the Muscidæ are provided with unguiform mandibles, with which they maintain a firm hold, whilst the body is contracted and dragged forwards. Other larvæ, as the Syrphus, use their mandibles for the same purpose.†

Pedate Larvæ.—Many of the pedate larvæ of insects are furnished with six legs like the

* De Geer, vol. v. p. 210.

† Kirby and Spence, vol. ii. p. 272.

perfect insect, which support the three first rings of the trunk. In many larvæ there are no organs of locomotion, whilst others are furnished with a variable number of rudimental legs, presenting differently constituted organs for progression. Most of the larvæ of the Lepidoptera have ten pair of these pro-legs, respectively articulated to the sixth, seventh, eighth, ninth, and anal segments of the body. One family, the Lophyrus, has sixteen pro-legs. Others, as the *Stylotoma*, have fourteen, and the *Tenthredo* twelve. The perfect legs move (according to Kirby and Spence) in the same order as in the imago state; the pro-legs serve not only to raise and support the abdominal and caudal segments of the trunk, but also to assist in grasping objects in the plane of motion, and in urging the centre of gravity forwards.

When the head and thoracic segments are fixed, the body and tail are drawn forwards; the trunk is arched in the vertical plane; the tail being fixed, the pro-legs are advanced successively in pairs, beginning from the anal segment; the body is then extended, and the head advanced to take a new position; a conspicuous undulation of the body is produced, proceeding from the caudal to the cephalic segments. The larva of the Ant-lion (*Myrmeleon*) moves in a backward direction, even after the removal of its legs. Many larvæ, such as the Caterpillar of the Hawk-moth, move with extreme slowness, whilst others possess considerable powers of locomotion, as the *Apotela Leporina*, which has received its appellation from the rapidity of its movements. But of all terrestrial larvæ, the most remarkable for their attitudes and motions are the *Geometræ*. The true *Geometræ* have only two anal, and two intermediate pro-legs; with these they grasp any object so as to fix the anal extremity: the trunk, with the head, is then extended, elevated, and inclined from the horizontal towards the vertical position, and the animal appears to be in the act of surveying surrounding objects as represented in *fig. 233*. In progression, the head being

Fig. 233.



fixed on the surface of motion at *c* (*fig. 234*); the anal extremity is drawn forwards to the thoracic segments, from *a* to *b*; the trunk is then again extended to *d*, and a series of the same alternate flexions and extensions is employed to carry the larva onwards. During progression, the *Geometræ* spin a silken cord, which they fix by the head on the plane of position at each step, thus measuring the distance over which they pass. The use of this cord is to enable them to descend from the

Fig. 234.

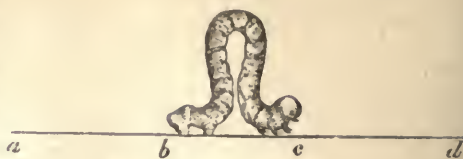

trees, however lofty, on which they feed, and to reascend by the same means, without the necessity of taking a circuitous route, and encountering the inequalities of the trunk and branches. In like manner the Caterpillars of the Cabbage-butterfly weave a ladder of silk on the plane of a glass-window, which serves as a fulcrum for its legs, and thus enables the animal to ascend.

Perfect Insects.—The order in which the legs of the Hexapods move in walking or running has been accurately explained by Professor Müller. Whilst watching insects which move slowly, he observed that three of their legs were always moving at the same time; these were advanced and put to the ground, whilst the other three propelled the body of the insect forwards. The feet, which moved simultaneously, were the fore and hindmost foot on one side, and the middle foot of the opposite side; then the fore and hind foot on this side, and the middle one of the other side, so that in two steps all the six feet are set in motion.* In the first movement, whilst the legs, 1, 2', 3, (*fig. 235*)

Fig. 235.

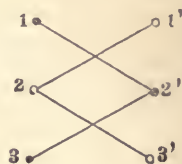

remain on some solid to support the body, and project it forwards, the other three legs, 1', 2, 3', are raised and advanced; then, whilst the legs, 1', 2, 3' are, in their turn, supporting the body, 1, 2', 3 are raised and advanced, and so on alternately. It will be observed, that the base of support in these movements is a triangular plane, with the three feet placed on the three angles; the base and apex of the triangle alternating at each alternate movement of each set of legs; so that in the first movement, the apex, which is at 2, takes the opposite side at 2' in the second step. The Hexapods are supported by their three pairs of legs, and the stability of the animal is increased by the horizontal direction of the legs outward, this arrangement affording a larger base for the support of the centre of gravity. The first pair of legs being articulated to the prothorax, the second pair to the mesothorax, and the third to the metathorax, also gives to the longest axis an increased stability. The articulation of

* Müller, by Dr. Baly, p. 970.

the coxæ to the trunk is by cotyloid joints, as in the Rhizophoræ, or by ginglymoid joints, as in the Lamellicornes; and between the trochanter and femur, the coxa and trochanter, the femur and tibia, the joints are usually ginglymoid: the axis of each of these joints is turned at right angles to the next, so that, as Dr. Roget remarks,* "there results from the combination of both, a capability in the thigh of executing a circular motion, in a manner almost as perfect as if it had revolved in a spherical socket. The principle of this compound motion is the same as that employed on ship-board for the mariner's compass and other instruments which require to be kept steady during the motion of the ship. For this purpose, what are called *gimbals* are used, the parts of which have two axes of rotation at right angles to each other, so as to enable the compass to take its proper horizontal position, whatever may be the inclination of the ship." The remaining joints of the legs of insects are also ginglymoid. The tarsi, which vary in number from two to six, terminate by a double hook; those on the anterior pair of legs are directed backwards; those on the middle pair inwards; and those on the tail-piece, forwards; by which disposition the insect is enabled to lay hold of rough surfaces, and to walk up inclined or vertical planes with security.

In the progression of insects, the fore and middle legs are extended, and the hind legs flexed previously to urging the body forwards; in doing which, the actions of these legs are reversed. The simple hook terminating the locomotive organs of most insects will not enable them to walk on water, to climb vertically on glass, or stand inverted on ceilings, actions which many can perform, and for this purpose an additional apparatus is therefore provided. The common Gnat and some Coleopteræ which walk on the surface of water, have the tarsi furnished with a brush of fine hairs, which appear, when the surfaces are free from moisture, to repel the fluid with sufficient force to sustain the weight of the animal, and in confirmation of this theory, it is found that if the legs are moistened with spirit of wine, the animal immediately sinks and is drowned. Those insects which ascend vertically on the surface of glass, or remain suspended in an inverted position from the ceiling, are furnished with an additional apparatus. We have a familiar example in the House-fly, which has the extremities of its feet furnished with two funnel-shaped membranous suckers, moveable by muscles in every direction, by which they are capable of exhausting the air on very smooth surfaces, thus causing the pressure of the atmosphere to sustain the weight of the body: the area of these suckers is so beautifully adjusted to the weight of the insect, that the pressure of the air alone is more than sufficient to sustain the weight of the insect without exertion, and to suspend its body to a ceiling in an inverted position. The centre of gravity is thus suspended, instead of being supported,

the legs having merely to resist the force of gravity upon the body. In the Bluebottle-fly (*Musca Vomitoria*) these suckers are conspicuous, and the edges being serrated enable them to apply the disc of this pneumatic apparatus to any kind of surface. In the

Fig. 236.



Fig. 237.



Bibio febrilis (fig. 236), the foot is furnished with three suckers, in the *Musca domestica* with two (fig. 237), and in the *Cymbex Lutea* with five. Numerous other species, amongst which is the common Wasp, are furnished with cushions and analogous suckers, which enable them to ascend vertically on glass.

The predaceous insects run with great velocity in proportion to their height. Those which are furnished with very short legs must advance them at intervals of time corresponding to the square roots of their length, on the supposition that their legs are subject to the same physical laws as those of the human race. Mr. Delisle observed a minute fly run three inches in half a second, making 540 steps in the same time; each of these steps must have been consequently $\frac{3}{540} = 0.0056$

of an inch in length. The great number of steps taken by these minute animals conveys to the mind of the observer an impression that the animal is running, whereas it is merely walking, the body not swinging freely in the air, as is necessary, according to the definition of Weber, to constitute the act of running.

Myriapoda.—In the Myriapods, the great number of legs and the celerity of their movements, as for example, in the Scolopendra, render it difficult to detect the order of their motions. The numerous segments entering into the lengthened form of the trunk, each of which is furnished with a pair of legs, give to the body great flexibility, and enable the Myriapods to turn from a right line to any curved or angular path, or to pass over rough surfaces with facility. The legs, in number from fourteen to forty-two, are short, and directed laterally; they are composed of four segments; all the joints, except that by which they are attached to the trunk, are ginglymoid, and terminate in a sharp conical claw, which gives precision and security in climbing. The legs appear to move in a determinate order; every

* Bridgewater Treatise, i. 294.

alternate leg on one side supports the animal, and urges the centre of gravity forwards, whilst the corresponding leg on the other side is raised and advanced to take a new position on the plane of motion. Such, at least, seems to be the process employed, but there is very great difficulty in ascertaining their motions with perfect accuracy; we therefore give the above in part practically, and in part hypothetically. The Myriapods move with considerable agility; usually run, and if disturbed, continue that pace for a great length of time. They have the power of climbing with facility the perpendicular surfaces of trees, walls, &c.

Arachnida.—The Arachnida are furnished with four pairs of legs, which render their mode of progression more complex, and more difficult of observation, than that of the Decapods.* Their coxæ are articulated to the base of the cephalo-thorax by cotyloid joints arranged in an elliptical form, and directed horizontally outwards; all the remaining articulations of the legs are ginglymoid, which is the best mode of articulation for the horizontal movements of the leg whilst urging the body forwards; the tarsi, which are composed of a variable number of segments, terminate by a double or single hook, which affords to this tribe of animals the means of ascending vertically, whenever any surfaces present minute irregularities adapted for prehension; the legs, projecting from the cephalo-thorax horizontally, increase the base of support. The centre of gravity is that of an ellipse. The Arachnida cannot ascend vertically on glass, but are enabled to walk in an inverted position on ceilings or rough surfaces without the assistance of their web.

The organs of motion in spiders, though nearly constant in number, differ exceedingly in length; the general principle is, however, the same. After long and repeated observation, I discovered the order in which the eight legs of these animals are put in motion. If we first attend to the manner in which the legs are moved on either side singly, they will be found to move first the fore leg, then the fourth, then the third, and lastly, the second leg; that is, in the order 1, 4, 3, 2. On observing the motion of the legs on both sides of the animal simultaneously, they are found to move the first right leg, then the fourth left; then the first left and the fourth right; then the third right and the second left; and lastly, the third left and the second right (fig. 238).

Of these, the first two sets are moved consecutively, like those of a quadruped, 1', 4, 1, 4'; the last two in pairs simultaneously, that is, 3', 2, then 3, 2'; and whilst the legs of one side of the animal are moving consecutively

in the order 1, 4, 3, 2, the legs of the other side are moving in pairs in the inverted order 4', 1', 2', 3'. In descending vertically by means of a newly-spun thread, they hang by one of the hind legs; on ascending the same thread they employ three legs; the two first on one side, and the first or second on the other; in running, the second pair of legs is placed in advance of the first, then those of the third before the second, thus giving the feet a greater range of space at each step. The fourth pair, or hind legs, are directed backwards nearly parallel to the line on which the animal is moving; they seem to be chiefly used to support the posterior segments of the abdomen, but also exercise a limited action in propelling the body forwards. Four legs support the body almost, but not quite, simultaneously, as stated by Professor Müller, whilst the other four are raised. The progression of the spider is usually rapid; it can run upon its web with great facility; it can leap many times its own length in chase of prey; it can float during a limited period on water; and the facility with which it can spin and throw a cord across cavities from one fixed point to another, at a considerable distance, endows it with a mode of transit across spaces which is denied to many other animals.

Decapoda.—The modes of progression employed by the Decapods are both various and singular. Organized either to swim in rivers or seas, to walk and run on the dry land or at the bottom of water, both fresh and salt, they are furnished with organs of locomotion suitable for these different purposes. The five pairs of legs articulated at the base of the cephalo-thorax have the whole of the joints articulated, and directed to move on solids either laterally or directly backwards. The front legs are generally the most massive and powerful, throwing the centre of gravity forwards nearly between the axes of their articulations.

The Brachyurous Decapods, as the *Cancer*, *Maia*, &c., present either a quadrilateral or a pyriform figure. They are generally destitute of the great elongations of the abdominal segments and expansion of tail into fins for swimming, which we find in the Macrourous Decapods. The consolidated carapace of the decapod tribe deprives them of lateral flexibility in the thoracic section of the trunk. The land species of Decapods, such as the *Cancer cursor*, or land crabs, are capable of running with such velocity, that a man on horseback has difficulty in keeping up with them. From their speed they were called by the more ancient naturalists *equi*. In many species, such as the *Inachus thoracicus*, the *Leptopus longipes*, and the *Leptopodia sagittaria*, the legs are greatly elongated, and consequently exercise a locomotive office resembling that of the tipula amongst insects, differing however from it in the direction of the articulations, by which the progression of these different classes is reversed. Thus in the *Leptopus longipes* (fig. 239), the action resulting from the flexion and extension of the legs in *g f*, *g' f'* will propel

Fig. 238.

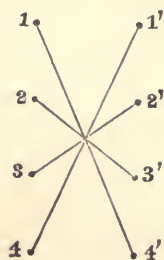

* The female is furnished with an additional pair, to enable her to carry her eggs.

Fig. 239.

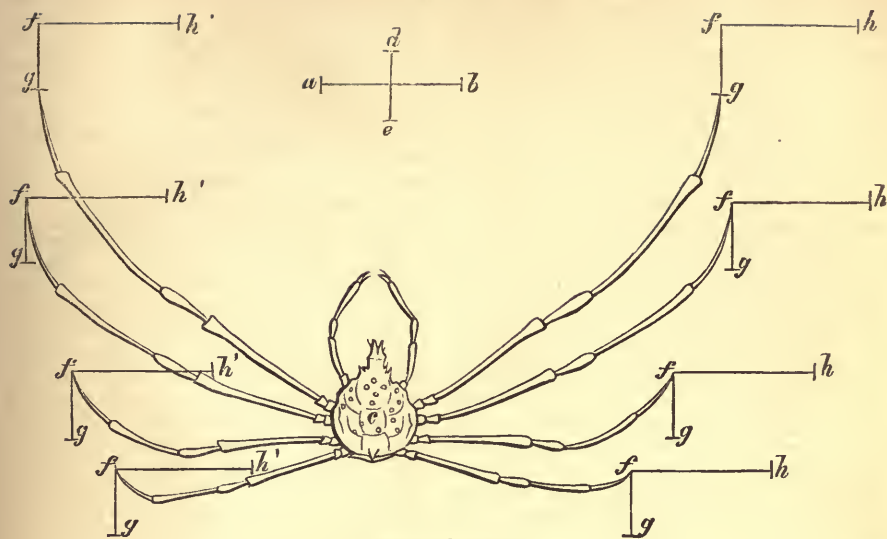
*Leptopus longipes.*

the centre of gravity c backwards in the direction of $d e$, but by the elongation of one set of legs from f to h , and subsequent retraction towards f , and the simultaneous contraction of the other set from f' to h' , and subsequent extension towards f' , the centre c will be propelled laterally in the direction of $a b$, perpendicular to $d e$. The lines $a b, d e$ represent both the magnitude and direction resulting from the two movements of the legs, in $g f, g' f'$ and $h f, h' f'$ respectively, but, by changing the position of the legs, they may also move obliquely.

The Macrourous Decapods, as the lobsters, are all organized for swimming; and they have accordingly been considered under that section.

Gasteropoda.—The motions of the Gasteropoda are proverbially slow; the situation and structure of the muscular foot enable them to traverse surfaces vertically, as well as horizontally. The centre of gravity is supported within the base formed by the disc of the foot, which is organised to expand, contract, and curve in every direction; also to produce a vacuum, and to secrete an adhesive fluid for the purpose of securing the stability of their position on surfaces directed at any degree of obliquity, or on the ceilings of rooms, or roofs of buildings, in opposition to the force of gravity.

The *Limaces*, or slugs, and *Helices*, snails, present in progression a crawling or gliding motion. When, for instance, the *Helix pomatia* prepares for moving, the head, neck, and foot are first protruded from the shell; the foot is next extended on the plane of position, with the shell raised upon it; the muscular fibres of the foot then produce an alternate contraction and elongation of the successive segments of its disc, commencing posteriorly and proceeding forwards by a visible undulatory motion. During these alternate elongations and contractions, the animal glides perceptibly from point

to point, though so slowly that many hours are required to traverse the distance of a few feet. As these animals crawl up the vertical planes of a glass window, the successive undulations of the foot are plainly visible when viewed from the opposite side. Müller considers them capable of producing a vacuum at various portions of the disc of the foot, thus availing themselves of atmospheric pressure in addition to their adhesive mucilaginous secretions. The patella, or limpet, and similar Gasteropods are well known to produce between the foot and plane of motion, a vacuum so powerful that the shell may be broken rather than the animal will suffer itself to be detached from the surface to which it adheres. The minute dimensions of each undulation of the foot render the Gasteropods incapable of traversing loose ashes or sawdust placed in their path, and these means are consequently often employed by gardeners to prevent slugs from destroying the young and tender plants.

Cephalopoda.—The locomotive organs of the Cephalopodous Molluscs are adapted to serve the triple purpose of legs for terrestrial progression, arms for prehension, and oars for swimming; the *Loligo* and *Sepia* are also furnished with fins, which are placed on each side the dorsal aspect of the trunk, and are the organs chiefly employed when swimming. Their terrestrial progression is performed by eight legs, leaving the two long tentaculæ free for prehension. The fleshy legs of the Cephalopods are extremely flexible, of various lengths, and capable of moving in every direction, whilst the acetabulæ enable them to lay hold of bodies with great force. In walking, the head and trunk are inverted, the direction of motion is retrograde, and they move very slowly on solids (fig. 240).

Ophidia.—The Ophidian Reptiles are destitute of organs capable of supporting and carrying the trunk in progression, and therefore they

require some organs modified to render them capable of reptation. For this purpose we find the spinal column is composed of a greater number of vertebræ than is to be found in any other class of animals. The number of vertebræ varies in different species of Ophidia. In a large Python three vertebræ in their normal positions measured one inch, which in an animal of six feet in length would give 216 vertebræ of equal dimensions; towards the tail, however, their bulk diminishes, by which the flexibility of that part is augmented; the vertebræ are most numerous in some of the smaller species of Ophidian Reptiles. The bodies of the vertebræ are short, and are articulated together by a ball and socket joint which is situated at the inferior border of the body of the vertebra; but as this kind of articulation permits of a rotatory motion in every direction, it would render the whole spine exceedingly weak if the motion of the vertebræ was not restricted in some other part; to attain this object, and to give steadiness and precision in their movements, the articulating processes are elongated and furnished with double articular surfaces; of these the inferior is horizontal, and the superior oblique. The horizontal articular surface of one vertebra projects backwards as far as the extreme convex head of the ball, whilst that of the next vertebra projects forward as far as the edge of the socket; by this arrangement the horizontal articular surfaces are in contact to the

extent of the depth of the socket. The superior oblique articular surfaces of corresponding portions of the two vertebræ are also locked into each other when the vertebral column is extended; all the articulating processes being cuneiform and fitting into cavities or upon corresponding surfaces effectually prevents any twisting of the body around it. The areas of the planes of the articular surfaces are sufficiently extensive to enable the animal to rotate each vertebra laterally 15° without causing them to slide from each other, consequently six successive vertebræ allow of a sufficient range of motion to render the animals capable of turning certain portions of its body at right angles to each other. Owing to the position of the arthrodial joint, a small amount of flexion on the abdominal aspect in the mesial plane is sufficient to produce a considerable space between the spinous processes, so that the motion of the spine in this direction is rather restricted, and from the same cause the spine cannot be but very slightly flexed on the dorsal aspect in the mesial plane without dislocation. The movements of the spine for the purposes of locomotion are, therefore, chiefly lateral. The ribs which extend from the atlas to the anus are articulated to the short transverse processes of the vertebræ, and in consequence of the absence of the sternum, scapula and pelvis, are endowed with great freedom of motion; they act in pairs on the transverse abdominal

Fig. 240.



The *Octopus vulgaris* represented in the act of creeping on the shore, its back being turned towards the spectator, towards whom it is supposed to be advancing.

scuta (which take a variable number of fixed points in the surface of motion), and enable them to propel the body forwards and supply the place of so many legs. Their muscular system, though capable of exerting great power, acts at a mechanical disadvantage, and is quickly exhausted. Serpents move by different methods, and upon different principles of progression. First, in a straight line, with the whole ventral aspect of the trunk in contact with the plane of motion. Secondly, in a curved line, with the trunk arched laterally, and the ventral aspect also in contact with the ground. Thirdly, in a curved line, with the body moving by an undulatory alternate elongation and contraction of small segments of the body. Fourthly, in a straight or curved line, with the trunk arched vertically in two or more curves. Fifthly, in a straight or curved line, with the trunk arched vertically in a single curve, consisting of the greater part of the trunk. Serpents possess also the power of climbing, swimming, and springing. In the first order of locomotion, or that of a straight line, with the whole of the ventral aspect resting immediately on the ground, the serpent is urged onwards by the oscillation of the ribs acting on the abdominal scuta, at successive points of

its length. The scuta of a segment or segments having secured a fulcrum in the plane of motion, the ribs connected with the fixed scuta, acting in turns, rotate backwards; the next segments in advance perform a similar action, until the whole series have completed the step. The length of the complete step depends on the arc through which the ribs oscillate, and the distances of the scuta from the axes of motion; and, as these are both small, and the motion has to be transmitted through the whole length of the reptile, this method of progression is, in consequence, very slow, presenting to the eye a tardy gliding movement.

In the second order of motion, the progression is performed in a curved line, with the ventral aspect also in contact with the ground. The method of advancing in this order is similar to that in the first; but as the reptile passes through a larger space in order to reach a given point, the progression will, consequently, be slower. Thus, if the reptile be flexed as represented in *fig. 241*, its length, when extended being equal to the right line *h b*, becomes by flexure only equal in the direction of motion to *a e*.

In the third order of motion, the reptile

Fig. 241.

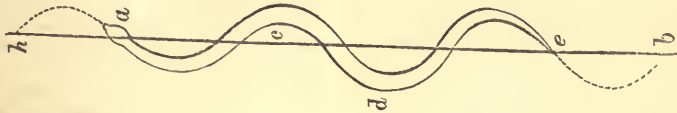

is curved laterally, as in the second, but small segments of the trunk are successively flexed and extended, and the steps taken do not depend on the time or extent of the oscillations of the ribs, but on those of the retractions and elongations of the segments of the body; and as the latter greatly exceed the former in celerity and amount, the progression in this order is vastly greater than in the preceding, which is

the slowest. These modes of progression are practised by the common Snake, the collared Viper, and other Ophidians.

In the fourth order, the trunk is arched into three or four vertical curves. This is an accelerated mode of locomotion; first, the spaces taken at each step are large; and secondly, because the reptile moves in a straight line. When the head *b* is advanced from *b* to *h*,

Fig. 242.

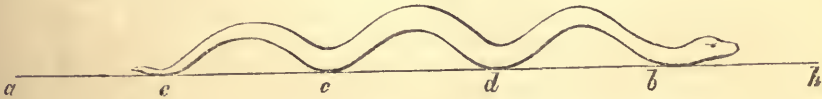
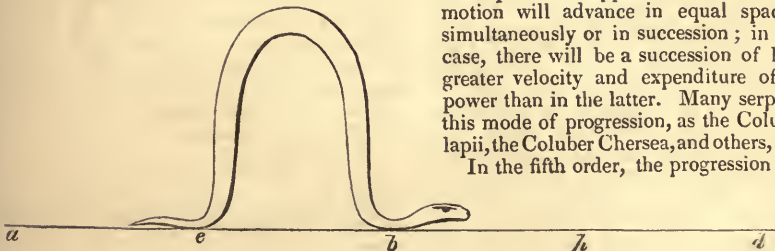

Fig. 243.

each point of application to the plane of motion will advance in equal spaces, either simultaneously or in succession; in the former case, there will be a succession of leaps, with greater velocity and expenditure of muscular power than in the latter. Many serpents adopt this mode of progression, as the Coluber Esculapii, the Coluber Chersea, and others, (*fig. 242.*)

In the fifth order, the progression is effected



by the flexion and elevation of the trunk in a single arc or curve, as seen in *fig.* 243. If during the extension of the reptile the tail be at *a*, it is by flexion advanced to *e*, during which motion the head is fixed at *b*; the tail being then fixed at *e*, the body is suddenly extended, and the head projected to *h*; so that in these two actions of flexion and extension the serpent has advanced through a space equal to *a e* or *b h*. The velocity of this mode is great, but will manifestly depend on the number and magnitude of steps taken in a given time. This mode of progression is that used by the rattlesnake, when the greatest speed is necessary in pursuit of prey, for instance, or in escaping from an enemy. When these flexions and extensions are performed with the greatest rapidity, the speed of the rattlesnake exceeds that of man. The principle of locomotion in the fifth order is similar to that of the larvæ of the Geometræ, and might, with equal propriety, bear the same designation.

The Amphibæna walks with equal facility either backwards or forwards; the lower jaw being supported by the tympanic bone, which is articulated to the cranium, is used by these serpents as a fulcrum for retrograde progression. The Boa and the Python climb trees with great facility; this they effect in a spiral curve, the scuta of various segments, through their enormous length, laying hold of the bark; and aided by the great flexibility of their vertebral column, they are enabled to ascend in opposition to the force of gravity. They select trees in the vicinity of streams and rivers, and suspending themselves from the branches in an inverted position by means of their prehensile tail (which is furnished with a corneous hook on each side the anus), seize and crush quadrupeds even of large size as they approach to drink.

Serpents are also capable of darting, either from the curved position or the spiral coil, by the sudden elevation of the body to an erect posture; such is the movement of the deadly Cobra de Capello in its attack on the unconscious traveller, and in the same manner the common Viper inflicts its less dangerous wound. The erection of the trunk, either from the vertical curve of the Rattlesnake or the horizontal coil of the Cobra, is said to generate a projectile force sufficient to raise the reptile above the plane of motion. Although destitute of the limbs with which the higher vertebrata are furnished, serpents are endowed with the power of transporting themselves from place to place with a velocity greater than many bipeds and quadrupeds. Their locomotive powers enable them to chase and capture their prey; to stride across plains; to ascend and descend hills and precipices, inaccessible to most of the higher animals; to climb trees; to swim lakes, rivers, and seas; and thus not only to provide the means of subsistence, but also to choose those places of abode which are most suitable to their wants, pleasures, or habits.

Amphibia.—In consequence of the amphibious nature of many Batrachia their locomotive organs are adapted both to terrestrial

and aquatic modes of progression. The carnivorous Caducibranchiæ in an adult state present an almost quadrilateral figure, and as many of the osseous elements of the skeleton (which in fishes are separate) are ankylosed together, they give solidity to the framework, and afford levers and fulcra for muscular action to sustain the shocks necessarily connected with a terrestrial mode of locomotion. In the Frog the anterior extremities are short compared with the posterior; the toes are furnished with a broad web, consisting of an expansion of the integuments, a structure which, with the length and strength of the posterior extremities, renders them well adapted for leaping and swimming. The eight vertebræ have a ball and socket articulation, which gives them some degree of motion on each other. Their legs being directed horizontally prevent the Amphibia from supporting their trunks above the plane of position.

In a state of repose, the Frog assumes a sitting posture; the thighs are flexed forwards and outwards; the legs are flexed backwards on the thighs; the lengthened feet and toes are again directed forwards; the trunk is inclined to the vertical plane at an angle of about 45°, which brings the centre of gravity within the base formed by the pelvis and posterior extremities, leaving the anterior extremities either free or lightly touching the ground. The legs, in a state of flexion, are ready on the least alarm to project the body forward by their sudden extension.

The Bull-frog is said to project itself six or eight feet at each leap, and the leaps are repeated so rapidly that it is captured with difficulty, unless chased at a great distance from the water. It will also spring over a wall five feet in height. The Hyla, or Tree-frog, has each of its toes furnished with a concave disc, which acts as a sucker to enable the animal to attach itself to branches of trees, amongst which it runs with great facility. The feet of the Rana esculenta and Rana pipa are palmated for swimming, those of the Rana bufo semi-palmated, and the Rana calomella and others have two osseous tubercles on the palms of the hands, which enable them to climb the planes of old walls in order to secrete themselves in the crevices.

The urodelous kinds of Caducibranchiæ are adapted for land and water; those adapted for terrestrial progression have the tail of a cylindrical form, as in Salamandra, whilst those adapted for the water, as the Triton, have a pisciform tail, the planes of which are directed vertically.

The perennibranchiate tribes of Amphibia residing constantly in the water, and with very rudimentary atantal and sacral extremities, have the trunk elongated and pisciform, and the tail compressed laterally to give a greater impulse in swimming, as in the Proteus, the Axolotl, Siren, &c.

Saurian Reptiles.—The Sauria have commonly four legs, but a very few are restricted to two. Of these, some are organized for progression on land, others for locomotion both by

land and water. The outline of the Sauria presents a lengthened form, having the atlanto-sacral axis much greater than the transverse; they partake more of the figure of the Ophidian than of the Chelonian reptiles, but differ from the former in having legs for the support of the trunk and for locomotion, and also in having a more complex skeleton, including besides the vertebral and costal bones, scapulæ, clavicles,* sternoid, pelvic, and sacral elements, as in mammiferous quadrupeds. The acetabula of the scapulæ and ossa ili are inclined horizontally outwards; the humerus and femur, which are short, take the same direction; the ginglymoid articulations of the elbow and knee joints are inclined backwards eccentrically to those of the shoulder and thigh. The effect of this is that the extension and flexion of the fore-arm and leg, being made in the plane of the transverse horizontal section of the body, are at the same time movements of abduction and adduction; an arrangement which renders the extremities ill adapted for rapid progression on land. Those Sauria which have the four legs nearly of an equal length may be considered the best adapted for locomotion; the vertebral column being in this case parallel to the plane of motion. When the legs are nearly of equal length, the bones of the anterior and posterior extremities bear the following proportions: in the arm of the *Crocodylus acutus* the humerus is found to be 4.334, the ulna 3.083; and in the leg, the femur 4.666, the tibia 3.5 inches, so that $4.334 + 3.083 - 4.666 - 3.5 = -0.75$ inch for the difference of the length of these bones. The metatarsus and toes are longer and broader than the carpus and phalanges of the fingers, and present a large surface to strike the water in swimming.† The posterior extremities of the *Biporcatus* are palmated,‡ those of the Cayman semipalmated. The legs of the Sauria are very short compared with the length of the animal, (which, in the *Biporcatus*, is more than 10 feet,) and their horizontal inclination tends still more to depress the centre of gravity towards the plane of motion. From the same cause the legs act on land at a great mechanical disadvantage.

In the *Crocodylean Sauria*, the cervical vertebræ have but a limited lateral motion owing to the projection and interposition of the false ribs; the dorsal vertebræ have their transverse processes elongated and fixed to the ribs, which have no tubercles, consequently there is but little lateral motion of the back; the lengthened tail, however, admits of considerable lateral play and is of great use in swimming. The *Crocodyles* cannot curve its trunk abruptly or turn it at an acute angle with facility; it runs, however, with considerable agility in a right line. The bones of the skeleton are of a fibrous spongy character, which diminishes the specific gravity of the animal, and is a great

advantage in its swiftest mode of progression, which is in a fluid medium.

Lacerta.—The *Lacertine Saurians* are smaller in dimensions than the *Crocodylean*, and possess much greater mobility of the vertebral column; the prolongation of the animal in the axis of its mesial section is much greater than in its transverse section. As in the *Crocodylean species*, most of the *Lizards* are provided with four legs, but a very few species have two only. In a few forms, such as the *Chirotes* and *Bipes*, the animal cannot support the body above the surface of motion, and consequently drags the thoracic and abdominal segments along upon the ground. In consequence of the construction of the hands, claws, and prehensile tail, many *Lizards* climb with facility. The *Gecko* is provided with a pneumatic apparatus which it employs in a manner similar to that of the house-fly; the under surface of each of the five toes, which (with the exception of the thumb) terminate in a sharp claw, is furnished both in the fore and hind feet with as many as sixteen transverse plicæ, which open into as many cavities or sacs (fig. 244). The contraction of the muscles, acting upon these plicæ and sacs, erects the former and dilates the cavities of the latter; the serrated edges being at the same time accurately applied to any smooth surface, a vacuum is produced, and by this structure the animal is enabled to climb up the vertical planes of walls, and to walk in an inverted position on the ceilings of rooms. The *Anolis* and *Tupenambis*, as well as the *Gecko*, run with considerable speed, and have the power of leaping a great distance; others propel themselves either backwards or forwards by applying

Fig. 244.

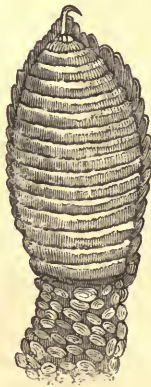

two or more parts to the ground as a fulcrum, and by the alternate flexion and extension of the body, aided by the long and flexible tail.

In the *Thecadactylus* the toes are expanded and furnished at their lower extremities with transverse folds; these folds are divided by a deep longitudinal groove, in which the claw can be entirely concealed; by this provision the claws are preserved sharp for climbing.

In the *Ptyodactylus*, the toes are flattened into plates, the lower parts of which are striated like a fan; the middle of the fold is cleft, and the claw is fixed in the fissure. All the toes have the claws very much curved. This peculiar organization of the feet enables the animal to climb with great facility.

In order to allow of the more secure prehension of its insect food on the agitated branches of trees, the *Cameleon* has short, strong, muscular limbs; a strong, flexible, and prehensile tail; two thumbs opposite to three

* The *Crocodyles* has no clavicle.

† Hunterian Museum.

‡ The same remarks apply generally to the *Alligators of America* as to the *Crocodyles of the Old World*.

fingers on the anterior extremity, and three thumbs opposite to two fingers on the posterior. Many of the climbing Lacertine Sauria have very elongated and flexible fingers, which give them great power of prehension and rapidity of motion, so that they are enabled to climb rapidly up the vertical surface of walls and trunks of trees.

Chelonia.—The Chelonian reptiles are enclosed in a ponderous case formed by the carapace and plastrum, which they are destined to drag along with them in all their movements. In the terrestrial species, the dorsal, costal, sternal, and pelvic osseous elements are all fixed, leaving the neck and caudal extremities of the body alone free. The legs, which are short and curved, act in consequence of their horizontal inclination at a great mechanical disadvantage, rendering the progression of the *Chelonia* proverbially slow. The humerus is bent, and in pronation is locked against the plastrum; the latter tends to assist it in supporting the animal. The same body also prevents the femur from exercising any great degree of flexion, but allows it more freedom of action in extension; from the relative position of the cotyloid articulation and the absence of that impediment in the direction of extension, the hinder extremities give altogether a more effective impulse in walking. The length of the arm and fore-arm equals that of the thigh and leg.

In the *Testudo elephantopus*, the femur measures five inches, the tibia five, the humerus six, the radius four; then as $5 + 5 = 6 + 4$, the sum of the lengths of the anterior and posterior extremities is equal. The feet and hands of the Turtle are furnished with a membranous expansion between the toes and fingers, which enables them to act as fins. The anterior extremities in this species are much more developed than the posterior. The body is remarkably flattened and depressed so as to present the smallest amount of resistance in cleaving the water in quest of their vegetable food. In the *Emydes*, or freshwater *Chelonia*, the feet are palmated, by which means they are enabled to move with greater facility and expedition on soft and yielding surfaces, such as muddy banks and rivers, as well as to swim in pursuit of their prey in the water. The *Chelonia* are remarkable for the great transverse extension of the trunk compared with their length; they differ in their mode of progression from the Ophidian reptiles in having legs, and from the Saurians in the immobility of the ribs. The *Aquatic Chelonia* are rendered of less specific gravity than their bulk would indicate, both by the spongy texture of their organs of support and by the great extent of their respiratory apparatus, which reduce their specific gravity to that of the medium in which they move, and admit of their sleeping motionless on the surface of the water.

The structure of the arch-formed carapace and dense plastrum, and the more solid union of all the osseous elements surrounding the trunk of the *Terrestrial Chelonia*, enable them

to resist the external pressure to which, from their partially burrowing habits, they are subjected, and also to endure the trampling of large quadrupeds.

Birds.—The feathered tribe traverse the surface of the earth as digitigrade bipeds. In standing, the trunk is elevated and supported at various heights above the plane of position, by the legs through which its weight is transmitted to the ground. It is balanced and kept in equilibrium on an axis passing through the centres of the heads of the femurs perpendicularly to the plane of the mesial section.

The inclination of the trunk lies between the vertical and horizontal planes; but its angle of elevation depends on the position and weight of its various elements and appendages, such as the head, neck, and anterior extremities, which determine the distance of the centre of gravity to the cotyloid articulation. The ilio-femoral articulations being placed more forwards in the *ossa innominata* than in quadrupeds, enables them to bring the centre of gravity within the base of support on their two feet with little elevation of the trunk. Several methods are employed by birds to alter the relative position of their centre of gravity in standing, namely, first, by curvature of the neck; secondly, by folding the wing on each side; thirdly, by the elevation or depression of the trunk above or below the horizontal plane in which the cotyloid joints are situated. All these different positions of the trunk and its appendages throw the centre of gravity backwards towards the vertical line passing through the base of support, which may also be changed and thrown forwards by bending the joints of the legs.

The areas of the bases of support vary in different orders of birds according to the number, length, and direction of their toes. The action of the *gracilis* muscle, which enables birds to stand on one leg in repose, was demonstrated by Borelli, and though his views were opposed by Vicq D'Azyr and Barthez, they have been confirmed by Monro, Cuvier, Müller, Roget, and Owen. In walking slowly, the body rests a long time on both legs and a short time on one; during the former period the motion of the trunk is retarded, but during the latter it is accelerated. In these movements, one leg is flexed, raised from the ground, and swung forwards to take a new position in advance, whilst the other supports the trunk and propels it forwards; and as soon as the foot of the raised leg arrives in a position perpendicular to the head of the femur, the hind leg is lifted and repeats the like movements. The time during which the body is supported on one leg, in proportion to that when it is resting on both, depends on the celerity of progression. The time of the oscillation of the swinging leg is governed by the length of the leg and the arc through which it is suffered to oscillate.* In walking, the centre of gravity oscillates laterally; this motion is

* For further details on walking upon two legs see those on human progression, many of which are applicable to birds.

most conspicuous in some of the Natatores, as the Goose, Duck, &c., and in those birds which have the greatest space between the cotyloid cavities and the least length of legs. Many birds depress and elevate the head, and extend and retract the neck at each step, in order to preserve in equilibrio the forces acting on the centre of gravity; the Moor-hen and some others are also observed to spread out the tail like a fan, which is alternately elevated and depressed at each step; and these successive actions of the tail taking place at the extremity of that portion of the lever opposite to the head, tend to produce an equilibrium between those portions of the trunk lying on each side of the cotyloid articulations.

In the progression of some of the long-legged Grallatores, such as the Crane and Stork, the swinging leg describes a portion of a circular curve round the standing leg. Pliny appears to have observed this kind of movement, for, in his *Hist. Nat.*, lib. x. c. 23, he says, "Grues mansuefactæ gyros quosdam indecoro cursu peragunt."

A large number of birds, such as the Sparrows, Canaries, Blackbirds, &c., instead of moving the two feet alternately, move them simultaneously: in these movements the legs are first flexed and then suddenly extended in succession, by which means the trunk and both legs are elevated from the ground, and progression is effected by a series of short leaps. In running the *Cursores* outstrip all other birds, and perhaps all other animals. The osseous columns which support the trunk are of great length and size, and are acted on by powerful muscles. The femurs, though short, have a considerable diameter; the tibia is long, but still longer is the tarso-metatarsal bone. The bones of the legs elevate the trunk to a great height, by which they are enabled to stride over a large space at each step. Aided by its comparatively diminutive wings, the Ostrich will outstrip the fleetest Arabian horse in his flight across the desert, as will the Cassowary the swiftest Greyhound. Thus, though deprived by the comparative smallness of their wings of the power of aerial progression, these birds are fully compensated by the velocity of the terrestrial movements.

The Scansores, such as the Woodpecker, Parrot, Cuckoo, &c have the internal toes and thumbs turned backwards, which enables them, with the assistance of the tail, to climb and to suspend themselves to the upright trunks of trees; during which action, the legs, tail, and that portion of the tree against which they rest form the three sides of a triangle.

Mammiferous Quadrupeds.—The locomotive organs of the mammiferous quadrupeds are more highly organized than those of the *Batrachia* and *Chelonia*. The bones of the skeleton are more compact, hard, and dense, and contain a greater proportion of the calcareous phosphate; they are, therefore, better calculated to resist the shocks incidental to terrestrial progression: the vertebral column, which is directed horizontally, is convex at its dorsal and concave at its ventral aspect. It forms a

single arch, extending from the pelvis to the last cervical vertebra, as it is kept bent by strong ligaments. It constitutes a powerful elastic column, well adapted to support the weight of the abdominal viscera as also of extraneous burdens which these animals are destined to bear. The spinal column of mammiferous quadrupeds is endowed with much greater mobility and elasticity than in the *Saurian* and *Chelonian* quadrupeds. The trunk is directed horizontally, resting on the four legs, which, like so many columns, support the centre of gravity. The scapulæ and pelvis have the power of rotating in a vertical plane through a large arc; the axes of the acetabula of the shoulder and hip-joints are directed vertically downwards to receive the heads of the ossa humeri and femoris, the shafts of which are directed vertically upwards. These ball-and-socket joints permit the several motions of flexion and extension; abduction and adduction, pronation and supination: the rest of the joints of each extremity are ginglymoid, a construction which, although it restricts the limbs thus articulated to movements in one plane, yet secures to these movements greater precision. The joints are lined and lubricated by synovial membranes, which, throughout the life of the animal, effectually secure them from injurious friction notwithstanding their varied and long-continued exertions. The elastic ligaments permit great freedom of action under all ordinary circumstances without rupture. The osseous columns, which enter into the composition of the extremities, are piled upon each other endways, with their long axes either vertical or inclined; and, in order to give them the power of sustaining the greatest possible pressure with the least weight and expenditure of solid materials, the shafts of the long bones are formed into hollow cylinders, of which the height and base are adjusted to each other with the greatest mechanical precision. The bones of the extremities in most mammiferous quadrupeds are inclined to each other's axes at a greater or less angle, the magnitude of which is in proportion to the bulk and speed of the animal. In those quadrupeds which have the greatest bulk and least velocity of locomotion, the bones approach nearest the vertical direction: such is the case with the elephant. On the contrary, in those animals which are remarkable for the greatest speed, the axes of the bones are inclined to each other at the greatest angle.

Although the angular disposition of the bones diminishes their power of sustaining great weight, and increases the expenditure of muscular effort, yet it confers on the legs greater elasticity, and enables them, from the oblique transmission of the impulse, to sustain sudden shocks without fracture of the bones; it also enlarges the range of motion, and gives the posterior extremities greater power of projecting the body forwards during rapid locomotion. The bones of the anterior extremity having to support the weight of the head and neck, as well as a large proportion of the trunk, are inclined nearer to a vertical direction than

those of the posterior; this tends to throw the centre of gravity a little in advance of the middle of the quadrilateral figure described by the four legs of the quadruped on the plane of position.

Although the bones of the posterior extremities are inclined to each other at a greater obliquity than those of the anterior, they have the calcaneum projecting considerably beyond the axis of the calcaneo-tibial articulation, so that, acting with the advantage of a powerful lever, the waste of muscular force is diminished, and the disadvantage arising from their obliquity is partially compensated. The time and order in which the legs of quadrupeds succeed each other in motion determine the paces denominated the walk, the trot, the gallop, the amble, and the leap, or bound.

In order to illustrate many of the general principles on which the progression of quadrupeds is effected, we shall select the horse as an example. In standing, the animal rests its trunk on the legs which form the four columns of support. Let us suppose the legs to be placed on the ground at $A B E D$ (*fig. 245*): if these points be joined, they form a rectangular parallelogram.

When the animal walks slowly with his right side in advance, the left hind leg moves first; the right fore leg second; the right hind leg third; and the left fore leg fourth. During these four successive motions, the centre of gravity is propelled forwards over a space equal to the length of one step. Let us now investigate what takes place during these successive motions. The hind foot having been previously extended, and having urged the centre of gravity forward, is first moved; it is then flexed, lifted from the ground, and advanced from E to e . Whilst the leg E is in the act of advancing to e , the trunk is supported on three legs, $A B D$, thus having the base of support transferred from the plane of a rectangular parallelogram to that of a right-angled triangle.

In this movement, the centre of gravity G must fall within the plane $A B D$, which is effected by an oblique lateral movement of the trunk towards $B D$. The foot E having taken a new position at e , the second foot B is set in motion, raised, and advanced to b , and the base of support becomes transferred from the rectangular triangle, $A B D$, to the oblique-angled triangle, $A e D$: by an oblique lateral motion of the trunk, the centre of gravity is propelled towards a , within the new base of support, leaving the leg free to move without danger of the horse falling. The leg B having advanced and taken a new position at b , the leg D is next raised and advanced to d , during which the base of support is transferred from the plane $A e D$, to that of $A b e$, within which the centre of gravity is propelled; lastly, the leg A is advanced to a , and the base of support is transferred from the plane $A b e$ to that of $a b e d$. When the leg A has reached the point a , the base of support becomes a new parallelogram $a b e d$, equal in dimensions to that of $A B E D$. In walk-

Fig. 245.

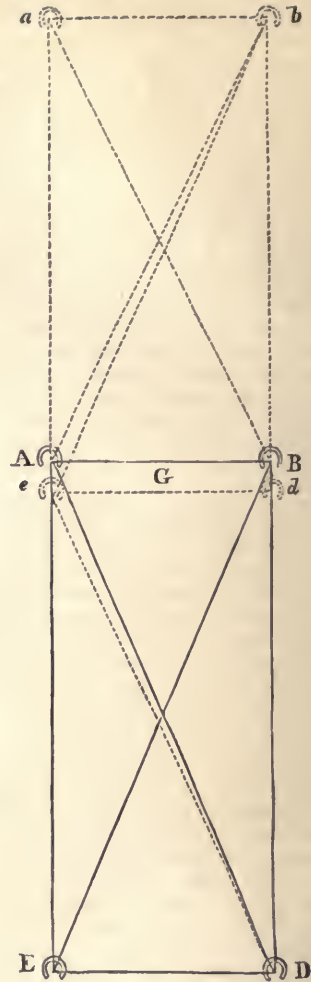

ing, the four legs move in the order above-mentioned successively. The time occupied in performing the series of movements to complete a step varies. In horses of large dimensions, one foot moves the length of a step every second, and, therefore, each leg swings one quarter, and rests on the ground three-quarters of a second. In walking at a more rapid pace each leg moves in rather a less period, and the interval between the setting down of one leg and the rising of the next vanishes.

The trot.—In the trot the legs move in pairs diagonally. If the legs $A D$ (*fig. 246*) be first raised and advanced, then $B E$ will generally be raised the instant that $A D$ reach the ground; on the other hand, when the legs $B E$ are raised before those of $A D$ reach the ground, the trot approximates to the gallop of two beats, the four legs being at the same time, for a minute interval, above the plane of motion. The bases of support in the trot are the lines $A D$ and $B E$ alternately. The same

Fig. 246.



leg moves rather oftener during the same period in trotting than in walking, or as 6 to 5. The velocity acquired by moving the legs in pairs, instead of consecutively, depends on the circumstance that in the trot each leg rests on the ground during a short interval, and swings during a long one, whilst in walking each leg swings a short, and rests a long period. The undulations arising from the projection of the trunk in the trot are chiefly in the vertical plane; in the walk they are in the horizontal.

In fig. 246, as designed by Bewick, and adapted to our purpose, we observe that the vertical line passing through the base of support, lies not only behind the centre of gravity of the horse, but also of the centre of the mass of the rider, consequently the anterior legs will bear much the greatest proportion of the burthen.

The gallop.—The gallop may be divided into three kinds, which may be distinguished by the number and order in which the feet happen to reach the ground. When the horse begins the gallop on the right, the left hind leg reaches the ground first; the right hind and left fore legs next, simultaneously, and the right fore leg last; this is termed the *gallop of three beats*. In the gallop where the four legs strike the ground successively, the left hind foot reaches the ground first, the right hind foot second, the left fore foot third, and the right fore foot fourth; *this is the gallop of four beats*, but it is not the kind of movement adapted for great speed.* The gallop wherein the legs follow the same order as in the trot,—that is, the left hind and right fore feet reach the ground simultaneously, then the right hind and left fore feet;—is the order in which horses move their feet in racing, where their greatest speed is required, and is called the *gallop of two beats*.† In the *amble*, the two legs on one side rest on the ground, and propel the centre of gravity forwards, whilst those on the opposite side are raised and advanced, and on taking a new position on the plane of motion, the former pair are raised and advanced in a similar manner: these successive actions are accompanied by a considerable lateral motion. The amble is the pace peculiar to the Giraffe:

in the horse it is only effected by artificial training. Borelli has erroneously described the order of the motions of the feet of the horse in walking; he states that the fore and hind feet on the same side move first, and then the fore and hind feet on the opposite side: these views, however, differ from the order as described by Aristotle,* and they have since been opposed by Barthez and Müller, whose opinions coincide with those which, after repeated observations, have been here introduced. In the gallop, the centre of gravity moves in a vertical plane, and describes the path of a projectile. The space passed over on the plane of motion is equal to the horizontal velocity of the centre of gravity multiplied by the time.† According to Sainbell, the celebrated horse, Eclipse, when galloping at liberty, and with its greatest speed, passed over the space of twenty-five feet at each stride or leap, which he repeated $2\frac{1}{2}$ times in a second, being nearly four miles in six minutes and two seconds. The race-horse, Flying Childers, was computed to have passed over eighty-two feet and a half in a second, or nearly a mile in a minute. Sainbell has given the geometrical proportions of Eclipse, together with the angles of inclination and range of motion of the joints of the four extremities. He states that a considerable angle of inclination of the shoulder-joint, as well as an angular disposition of the limbs, are essentially necessary for great speed. Sir C. Bell,‡ however, states, “that the speed of a horse depends on the *strength of his loins and hind-quarters*, and what is required in the fore-legs is strength in the extensor tendons;” but surely this hypothesis cannot be correct, or the brewer’s dray-horse would be the fleetest. The horse is one of the most useful and most perfectly organized quadrupeds, combining great strength with speed. The length, strength, and angular disposition of the bones of the legs, the power of the muscles, the structure of the joints, the lengthened metatarsal and metacarpal bones, the consolidation of the phalanges, and the structure of the expanded foot, all conspire to perfect the geometrical proportions of this valuable quadruped.

Having now given in detail the various movements of the horse, we shall briefly pass to the other orders of Mammalia.

Marsupialia.—In the Kangaroo, we observe a greater disproportion between the length of the anterior and posterior extremities than is found in any other quadruped, the length of the legs to that of the arms being as $38\frac{1}{2}$ to $17\frac{1}{2}$ inches,§ or rather more than two to one. This

* After the right of the fore feet they move the left of the hind feet. Afterwards they move the left of the fore feet and right of the hind feet. See Taylor’s *Aristotle on the Progressive Motion of Animals*, chap. xiv.

† See eq. 1.

‡ Library of Useful Knowledge, Art. Animal Mechanics.

§ These measures are taken from a skeleton in the Hunterian Museum. Some variation will occur in the absolute length of the extremities, arising from the age and magnitude of the animal; but the ratio of the length of the extremities in the

* The gallop of four beats is often denominated “the Canter.”

† See Sainbell.

difference arises chiefly from the great length of the tibia, which is nearly equal to that in the Giraffe, the former being to the latter as 16.5 to 18 inches. In the *Rodentia*, as the Hare, Agouti, and Guinea-pig, we observe a similar disproportion in the length of the extremities. The Rabbit, in moving slowly, advances the anterior feet two or three steps alternately, the posterior limbs remaining inactive. The body having been elongated by this means, the posterior legs are suddenly extended and drawn forwards simultaneously; thus, the rabbit walks with the fore, and leaps with the hinder pair of legs. Those quadrupeds in which the length of the posterior extremities much predominates over that of the anterior, are observed to descend declivities in a straight line with difficulty, on account of the great inclination of the axis of the trunk to the plane of motion, which puts the animal in constant danger of oversetting; they therefore take a zigzag course. In ascending a hill, however, their progression is greatly facilitated by the length of their posterior extremities. The speed of the Hare is well known to be greater than that of the fleetest horse or hound.

Ruminantia.—Many of the Ruminantia, such as the Deer and Antelope, are beautifully and symmetrically organized for rapidity of locomotion; the Camel for prolonged power of traversing the arid desert; and the Ox for the strength and development of its muscular system.

Amongst the Ruminantia some species have the neck of great length, and the head being surmounted with massive horns, or antlers, renders it necessary that the spinous processes of the lower cervical and superior dorsal vertebrae be lengthened, so as to form powerful levers for the attachment of muscles, and of that yellow elastic tissue, the *ligamentum nucha*, which is greatly developed in the Ruminantia, to support the head and its appendages; the latter acting at the end of a long lever tends to throw the centre of gravity forwards nearly between the anterior extremities. The figure of the trunk is elliptical; its transverse axis diminishes as it approaches the anterior extremities; there are no clavicles; and from the small degree of curvature of the ribs, the arms are thrown almost together beneath the trunk, and nearly in the plane of the mesial section of the body. The Giraffe presents greater length of osseous columns for the support of its superstructure than is to be found in any other animal; the bones of the anterior extremity are directed more vertically than those of the posterior, which enable it to support, with less weight of bone and less expenditure of muscular force, its lengthened neck, upon which the head acts as at the end of a long lever. The metatarsal and metacarpal bones are of great length, and being directed vertically, as in the *Pachydermata*, the trunk is elevated to a great height. The three phalanges of each finger and toe are inclined forwards; the extensor tendons act on them by means of a pulley, through the inter-

position of the sesamoid bones, which increase the distance of the direction of the tendons from the axes of the joints, and give them greater power.

The length of the arms to that of the legs in the Giraffe is as 71 to 67 inches, which gives a difference of four inches in favour of the length of the arms. This disproportion is further augmented by the lengthened scapula, and by the increased angular disposition of the posterior extremities.

In the Camel, the length of the legs is more nearly equal than in the Giraffe, the anterior being to the posterior limbs as 49 to 47 inches; the spine is consequently directed more horizontally than in the Giraffe. The order in which the movements of the legs succeed each other in the Camel is like that of other quadrupeds. The velocity of the camel at its common travelling pace is estimated at 2½ miles an hour.*

In Deer and Antelopes, the geometrical proportions are such as to confer on them great speed. The lightness, elegance, and strength of their osseous fabric, the energy of their muscular system, the freedom of motion in the vertebral column, the large arc described in the greatest rotation of the scapula and pelvis, the length and proportions of their extremities, the length of the olecranon and calcaneum, the vertical direction and length of the metatarsal and metacarpal bones, the inclined direction and freedom of motion of the three phalanges of the fingers and toes, the number and relative distances of the joints,—all conspire to perfect the progression of these Ruminantia. They bound by the sudden flexion and extension of all the legs, which are lifted from the ground simultaneously, and which, after projecting the centre of gravity in a vertical direction, appear to arrive again synchronously on the plane of motion. They walk or trot upon the principle of other quadrupeds, as explained already in the Horse. The Deer and Antelope, celebrated for speed, bound over plains, ascend or descend mountains, and also possess the power of leaping across an abyss of great breadth, or down precipices twenty or thirty feet in depth without sustaining the slightest injury from the shock.

Proboscidea.—The enormous bulk of the head and body, and massive proportions of the osseous and muscular systems, are more largely developed in the ponderous Proboscidea than in any other known species of terrestrial quadrupeds. The dimensions of the bones of the extremities are proportional to the gravity of the superincumbent weight; the scapula and pelvis, as well as the axes of the scapulo-humeral and ilio-femoral cavities, are directed nearly perpendicular to the plane of progression, and the whole column in each extremity presents a less angular disposition of the axes of the bones than is found in the lighter and more agile solidungulous *Pachydermata*. The olecranon and calcaneum, as well as the trochanters, afford long and powerful levers for the application of muscular action. The ginglymoid

same species of animals may be considered nearly constant for all ages, sexes, and magnitudes.

* See Rennel on the rate of travelling of camels. Phil. Trans. 1791, p. 129.

articulations of the carpal and tarsal bones allow a very limited motion. The axes of these bones are inclined almost vertically, but those of the metatarsal and metacarpal bones are directed rather more horizontally. The phalanges of the toes diverge from each other to give a broader base of support to these great digitigrade quadrupeds; their walk is slow and heavy, and the order in which the legs move is the same as in the *Solidungula*.

Carnivora.—In the structure of carnivorous quadrupeds, such as the Lion and Tiger, we observe the strength of the more ponderous and slow-moving Ruminants, as the Ox, combined with the agility and speed of those lighter forms, as the Stag. This union of strength with speed is due to the geometrical and physical relations of the elements that enter into the composition of these powerful digitigrade *Carnivora*. The spine possesses greater mobility by the retraction of the spinous and transverse processes, and the trunk is of less weight and bulk compared to their muscular power than in the herbivorous ruminants. In the Lion the scapula, which is directed very obliquely forwards, is unfettered in its motions by a clavicle; the humerus is long and cylindrical, and has its axis directed downwards and backwards, forming, with that of the scapula, an angle of 110° ; the radius and ulna are articulated so as to allow of pronation and supination; the olecranon projects several inches beyond the axis of rotation in the elbow-joint, and constitutes a powerful lever for the application of the tendons of the extensor muscles of the arm; the direction of the sacro-iliac articulation is eccentric to that of the sacrum, and the pelvis, which is inclined very obliquely backwards, forms, with the projection of the vertebral column, an angle of about 110° ; the femur is directed forwards in standing at an angle with the pelvis of 84° ; the tibia and fibula are distinct bones; the calcaneum is of great length; the tarsus and metatarsus inclined vertically, the phalanges horizontally; the last of which is elevated above the plane of motion.* In both the arms and legs the phalanges terminate in strong, curved, retractile claws for the prehension and laceration of prey. The posterior extremities in both the lion and tiger are longer, and the bones inclined more obliquely to each other than the anterior, giving them greater elasticity and power in springing: they walk, trot, and gallop upon the same principle as the horse.

Cheiroptera.—The bat being principally organized for flight, is provided with comparatively diminished powers of progression upon solids; the legs are feeble and incapable of supporting the trunk, and they move by a crawling, and sometimes a small leaping motion.

Quadrumana.—Of all Mammalia, the figure and organization of the *Quadrumana* approximates most nearly to man. They are destined

to climb the trees of the forest; to leap from branch to branch; to walk, trot, or gallop as quadrupeds upon plain surfaces, with the trunk directed either horizontally, or to walk as bipeds upon the posterior extremities alone, with the trunk directed vertically. For these several positions of the trunk and modes of progression they are furnished with a suitable geometrical conformation of their osseous framework, more especially in the *Ourangs* and *Chimpanzee*. In the *Quadrumana* the spinal column has greater freedom of motion than in the *Pachydermata* and *Ruminantia*. The scapula, which is directed forwards at an acute angle with the vertebral column, is supported by a clavicle; the ginglymoid cavity is deep, for the secure rotation of the head of the humerus; the latter is long, but slender in the *Hylobates* or long-armed *Gibbon*; the radius and ulna are distinct and free from the motions of pronation and supination; the carpus is often composed of nine bones by the division of one in the second row, to give greater mobility to the hand; the metacarpus and phalanges are much lengthened, but the same in number as in man; the iliac bones, which are long and narrow, are directed backwards nearly parallel to the vertebral column, but presenting with it posteriorly a very small angle; the tuberosities of the ischium incline outwards, giving a large base of support to the animal when resting on its callosities. In the *Hylobates*, the femur is curved and of less length than the humerus, but it is nearly of equal length in the *Chimpanzee* and *Ourangs*. The tibia and fibula are long and slender; the articulations of the astragalus, calcis, scaphoid, cuboid, and cuneiform bones are directed obliquely, which gives to the ankle-joint a motion eccentric to the axis of the leg, the effect of which is to throw the animal upon the outer edge of the hands and feet. The long metatarsal and phalangeal bones are inclined upwards and inwards, by which they are adapted for prehension in climbing or standing on the branches of trees; the calcaneum is short, and its axis of motion is eccentric, with respect to the direction of the tendons of the *gastrocnemius* and *soleus* muscles; which, though not very powerful, act at a mechanical disadvantage tending to diminish their effective force in a twofold manner. In many *Quadrumana*, as the *Cercopithecus* and *Semnopithecus*, the lengthened and flexible tail is employed as an organ of prehension, but in the *Macacus* and others the tail is pendent, and not employed in their movements. In the *Mandrills* the tail is very short; the *Simia*, *Pithecus* and *Simia Inuus* have merely a tubercle, whilst the *Ourangs* and *Gibbons* are destitute of this organ altogether; the deficiency of the mass of extensor muscles of the ankle-joint in the *Gibbons* and *Jockos* is alleged by *Daubenton** as a reason why these apes cannot maintain themselves in the erect position. *Perreault* is of opinion that the straightness of the *ossa ilia* prevents the extensor muscles

* It is in consequence of the direction which the tarsal, metatarsal, and phalangeal bones take, that the *Carnivora* and other animals are digitigrade.

* *Encyclop. Méthodique Dictionnaire des Animaux*, p. 20.

from acting with sufficient mechanical advantage to extend the thigh as perfectly as in man. Vicq D'Azyr* states, that in the Mandrills the flexors of the leg are inserted lower than the extensor muscles, and that they oppose the perfect extension of the leg upon the thigh, which renders it impossible for them to stand upright for any length of time without tottering. The Chimpanzee, the Ourang-Outang, and some of the Gibbons, however, are capable of walking upon their posterior extremities with the trunk nearly erect; but the pelvis being narrow, and the cotyloid cavities being directed inwards so as to throw the soles of the feet very near each other, the base of support becomes very much contracted, and the animal stands very unsteadily. Of all the Quadrumana, the trunk of the Chimpanzee is directed nearest the vertical; in walking as well as in conformation he approaches nearest to the figure and gait of man. In the Hylobates and Laniscus the arms are of sufficient length to enable them to touch the plane of motion with the fingers and assist them in walking; this is resorted to whenever the centre of gravity falls anterior to the base of support formed by the hind extremities.

The Lemurs are more decidedly quadrupeds; the large arc described by the spine, directed with its concavity downwards; the lengthened horizontal direction of the face to the direction of the scapular and cotyloid articulations, contribute to the prone position of the Lemurs. Some of the tribe, as the Lemur tardigradus, are denominated Sloths from their proverbially slow progression. Although the Ourangs have the advantage over other Quadrumana, of walking erect, and having the hands and arms free for prehension and great variety of action, such as using a club for defence or assault; yet the Gibbons outstrip the Ourangs in the velocity of their progression, and in their power of swinging and projecting themselves from tree to tree with extraordinary velocity. According to Duvaucel, the Hylobates agilis can launch itself from bough to bough at the distance of forty feet asunder, apparently without effort or fatigue. Martin relates, that "a live bird being set at liberty in the presence of a female Hylobates agilis, she marked its flight, made a long swing to a distant branch, caught the bird with one hand in her passage, and attained the branch with her other hand, her aim both at the bird and the branch being as successful as if one object only had gained her attention." The addition of a long and flexible tail in the Cercopithecus, Semnopithecus, and several other species, gives a fifth organ of prehension which is employed to assist them in a variety of motions. The walk, trot, and gallop of the Quadrumana are performed upon their four extremities on the same principles as those of quadrupeds in general, but as plantigrade bipeds their locomotion is accomplished like that of man.

SECT. V. *Man*.—The locomotion of man is that of a plantigrade biped. When the

body is erect and the face inclined at a small angle above the horizontal plane, the head is exactly balanced on the atlas, and its weight is transferred to the latter with the least expenditure of muscular action: its axis of motion is bisected by a vertical line passing through its centre of gravity when it is in equilibrio upon the atlas: in every other position of the head the expenditure of muscular action is increased. It has been observed by Daubenton, that, when in the position of a quadruped, man is obliged to elevate the head above the axis of the vertebral column, in order to see directly forwards; and in depressing the head to the earth, the position of the occipito-atlantal articulation prevents the jaws reaching the ground. The movements of the head on the atlas are restricted to one plane, namely, the vertical; but its articulation with the dentata permits a horizontal motion through a large arc of a circle; the head cannot turn without the atlas, nor the atlas without the head; on the contrary, the atlas and dentata revolve upon each other in opposite directions. By means of these two joints, whose axes of motion are at right angles to each other, the head enjoys a considerable range both in the vertical and horizontal planes.

The vertebral column.—The office of this complex structure is purely mechanical. The flexibility of the spine is due to the twenty-four joints which divide its length, and the interposition of the elastic, intervertebral, fibrous tissues. It is upon the elasticity and quantity of the latter that the flexibility of the vertebral column depends. The mean proportions of the heights of the cervical, dorsal, and lumbar intervertebral elastic tissues to that of the bodies of the vertebræ are estimated by Weber as follows:

Heights of cervical vertebræ . . .	MM.	95.85
Dorsal " . . .		242.95
Lumbar " . . .		135.95
	M.M.	—
Heights of intervertebral tissues . .		—
Cervical " . .		20.70
Dorsal " . .		34.90
Lumbar " . .		42.85
and their mean diameters,		
	MM.	
		15.
		25.3
		28.0

And, admitting their breadth to be equal to their thickness, which is near the truth, their transverse sections will be as the squares of the breadths, or as 225, 640, 784. Hence, if the cervical, dorsal, and lumbar portions are curved with equal force, their angles of flexion due to their elasticity will be in the following proportions:

$$\left(\frac{20}{225}\right)^2 : \left(\frac{34.9}{640}\right)^2 : \left(\frac{42.8}{784}\right)^2 =$$

$$846 : 297 : 298$$

that is, the angle of flexion of the dorsal and lumbar portions, notwithstanding their unequal lengths, are nearly equal, whilst the angle of the cervical portion, though of much less

* System Anat. des Animaux.

length, will be nearly three times greater. The greatest flexion of the trunk is in the plane of its mesial section, and results chiefly from the cervical and lumbar vertebræ. According to Weber, its greatest twisting or torsion horizontally is derived from the dorsal region. The angles of flexion of the head and trunk in two cases were as follows:

Crown of the head and sternum.	Sternum and sacrum.	Sum of the two.
1 147° 83° 230°
2 175° 85° 260°
Mean.. 161°	84°	245°

Of these two cases nearly two-thirds of 245° are accomplished by the head and neck, and one-third only by the dorsal and lumbar vertebræ.

The curved form of the spine, somewhat resembling an italic *f*, instead of being a cause of weakness, is, on the contrary, a source of strength and security; for forces acting vertically upon it are transmitted obliquely, thus diminishing their mechanical effect; and the elasticity of the intervertebral tissue prevents the shock to which the bones would otherwise be subjected at every step in walking. With respect to the power of the vertebral column to sustain weight, if we regard it in consequence of its form and elastic intervertebral substance as a spring with small flexures, it is capable of bearing a greater weight than if it were straight, in the proportion of the square of the number of curves plus one to unity; that is, a weight sixteen times as great. Considered as a whole, the vertebral column represents a lever of the third order, of which the fulcrum is in the axis of the articulation of the fifth lumbar vertebra with the sacrum: the *power* is the mass of muscles inserted into the sides of the vertebræ; and the *resistance*, the weight of the head, soft parts of the neck, the thorax, and part of the abdomen.*

In standing erect, the direction of the vertebral column is perpendicular to the horizon. Weber found, by means of plumb-lines let fall on each side opposite the centre of the heads of the femurs on which the trunk is balanced in the erect position, that the transverse vertical plane intersected both ends of the spine, passing through the atlanto-occipital articulation above and the sacro-lumbar below; he found also lying in the same plane the two mastoid processes and the centres of the ankle and knee joints.

Viewed separately, each vertebra represents a lever of the *first* order, whose fulcrum is the next vertebra, on which it rests; the *power* and *resistance* are the muscles acting upon it in different points alternately. The spinal column of animals is a flexible lever, destined to move and support a multitude of organs, and to connect the more distant parts of the skeleton with each other. We have nothing in the structure of locomotive or other machines bearing the least resemblance to its mechanism; and if, with Sir C. Bell, we compare it to the mast of a

ship, it will tend only (as Dr. Arnott has already pointed out) to convey an erroneous impression, both of its structure and its functions.

In standing, the vertebral column transmits the weight of the organs appended to or supported by it by means of the sacrum to the pelvis. The pelvis is a lever of the *first* order, having its *fulcrum* in the ilio-femoral articulations on the heads of the femurs; the *power* and *resistance* are the muscles acting anteriorly and posteriorly to the axis of rotation.

In the erect position of the trunk the pelvis is inclined to the direction of the vertebral column. The angles, both of the superior and inferior margins, have been measured by Nægele and Weber. According to the former, the mean angle of inclination of the superior margin to the horizon is 60°, and to the vertebral column 150°. The inclination of the inferior margin with the horizon 11°, and with the vertebral column 101°. The angle which the pelvis forms with the vertebral column permits the femurs to extend farther backwards, and to increase their range of oscillation. The magnitude of the transverse diameter of the ring of the pelvis determines the distance of the heads of the femurs from each other, and throws the thighs sufficiently apart, to prevent their friction upon each other in walking. The pelvis can rotate only on an axis perpendicular to the plane of the mesial section, when the body rests equally on both legs, but can turn horizontally upon the heads of either femur whilst the body rests on one leg. In standing, the pelvis is kept in equilibrium by several forces. The weight of the abdominal viscera, lying anterior to its axis of rotation upon the femur, tends to depress the pubes, and rotate the pelvis forward, while the weight of the vertebral column, acting posterior to that axis, tends to swing it backwards.

The weight of the vertebral column preponderates over the parts lying anterior to the axis on which the pelvis rotates, and consequently would require a considerable expenditure of muscular action to keep it in equilibrium on the femurs, but the obliquity of the vertical axis of the pelvis to that of the vertebral column throws the resultant of all the forces, acting downwards upon it, near the axis of rotation, which tends to preserve the balance; added to which, the muscles which draw the vertebral column backwards, having one of their points of insertion in the sacro-iliac section of the pelvis, tend to elevate it, and to neutralize their action on the vertebræ in an opposite direction. The principal agents in keeping the pelvis in equilibrium are the powerful muscles acting between it and the thigh.

The pelvis receives the whole weight of the trunk and superposed organs, and transmits it to the heads of the femurs. It has two axes of motion, one of which is on the last vertebra, and the other in the ilio-femoral articulation; in both cases it acts as a lever of the *first* order.

The legs.—The leg moves by means of three joints, namely, the ilio-femoral, the knee, and the ankle. In the erect posture the first of these allows the leg to move only forwards, the

* Vide Majendie Phys., by Dr. Milligan, p. 175.

second only backwards, and the third neither backwards nor forwards.

The length of the legs, measured from the hip-joint to the ground when standing erect, preponderates slightly over that of the body when taken from the distance of the crown of the head to the axis of the hip joint, consequently the centre of gravity is raised above the plane of position rather higher than the semi-distance from the head to the ground when the entire sole of the foot is in contact with the earth.* In consequence of the lengths of the femur and tibia being nearly equal, and of the zigzag direction which the limbs take during flexion, and because the angle of the greatest flexion of the knee-joint is nearly equal to the sum of the angles of the hip and ankle, it results that in the simultaneous flexion of these three joints, (provided the angle of inclination of the foot to the ground continues 30°) the trunk preserves its erect position as when standing, and therefore ascends and descends (by the flexion and extension of the legs) in the same vertical line. The greatest amount of elongation and contraction of the leg resulting from the greatest extension and flexion of the hip, knee, and ankle-joints, may be easily ascertained by measuring with a line from the hip-joint to the head of the astragalus during such flexion and extension, and marking the difference in the length of the line in the two states. By this method the length is estimated by Weber as follows:

In the greatest state of extension. . .	m.m. 924.26
In the greatest state of flexion.	404.74

The actual lengths of the several portions of the leg are

Head of the femur to the condyles. . .	m.m. 380.0
From the condyles to the convex articular surface of astragalus . .	420.0
Axis of articulation of the astragalus to centre of foot	136.0

During the greatest extension the first three of these points of the leg formed an angle of $148^\circ 8'$, and during the greatest flexion an angle of 40° . The second, third, and fourth points form in the greatest extension an angle of $157^\circ 4'$, and in greatest flexion $94^\circ 6'$.

The proportion between the greatest and smallest length which the leg can assume varies but little.

Figs. 247 and 248 from Weber show the greatest amount of extension and flexion which the leg can effect; the corresponding difference in length is as 14 to 5, but in walking and running the flexion is less, and the difference of length as 11 to 9.

In standing, the weight of the body is transmitted from the pelvis to the heads of the femurs; the oblique directions of the latter upwards and inwards keep in equilibrio the vertical forces downwards and outwards produced by the weight of the body on the wedge-like sacrum.

The femurs transmit the weight impressed

* See positions of the centre of gravity, sect. i. p. 409.

Fig. 247.



Fig. 248.



on them by the trunk, together with their own weight and that of the soft parts to the tibiae. The shafts of the latter are straight, and by their prismatic form their solid contents are removed further from the axis of the bone, which enables them to support a greater weight with less expenditure of materials.

The fibula adds likewise to the strength of the tibia, both vertically and laterally; the latter transmits, in its turn, its own weight and that of its soft parts to the astragalus.

The astragalus transmits the pressure made upon it partly to the calcaneum and partly to the scaphoides; the calcaneum partly to the ground and partly to the cuboides; the scaphoides transfers the force through the cuneiform bones; the toes to the ground, where the base of support terminates, supposing the entire foot to rest on it. In the mechanism of the foot we discover an elastic arch, upon which the shock of the body is received, and transmitted obliquely to the ground. This admirable structure prevents the jar which the body would otherwise sustain at each step by the reaction of the ground in walking, running, leaping, or falling; but an exact investigation of the mechanism of the foot would occupy more space than we have assigned to this subject. The areas of the soles of the two feet and the space lying between them is the whole base of support in standing on both legs; but when standing upon one only, this is diminished, not only by the area of one foot, but also of the space lying between them. In the latter case, the base is so narrow that the act is not easily accomplished, but the difficulty of keeping the trunk in equilibrio is vastly increased when the base of support is reduced to the area of the great toe, as is accomplished by opera dancers; or to the area of one-fifth or two-fifths of a square inch as in skating, or to one still less, as in rope dancing, wherein the base of support oscillates laterally. In this latter case, the difficulty is increased by the necessity of keeping the trunk in equilibrio, but the centre of gravity is retained in the plane of the rope by fixing the eye on some distant point in it. The position which the two feet ought to take, when equally advanced and equally inclined, so that

they may form the greatest base of support, has been mathematically investigated by Parent and Barthez. According to the latter, the trapezium which forms the base of support will be a maximum when the prolongations of the lines drawn through the central line of each foot and passing through the centre of each heel form an angle of $38^{\circ} 56'$.

The calculation of Parent is defective, from its being based upon the hypothesis that the foot turns as upon a pivot about its articulation with the leg, instead of around the heel. When the body stands erect upon both legs, and presses equally on each, the legs will form equal angles with the vertical line passing through the centre of gravity; but if the two legs form different angles with that line, the pressure upon the legs will be unequal, and will vary with the angles of inclination, for example, in *fig. 249*, *a d* is perpendicular and *g i* parallel to the horizon; if *a b*

Fig. 249.

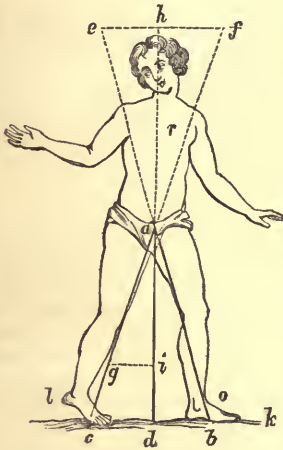

and *a g* represent the entire force exerted by the legs to support the whole body, *a d* and *a i* will be the corresponding portion of these forces necessary to sustain the weight of the body, and will also together represent that weight; and if *a d* and *a i* be found by experiment, the absolute forces, *a b*, *a g*, will be found.* In standing, the limbs serve merely to support the body, and to preserve the centre of gravity at a certain height above the plane of position, within the base of support, which is a necessary condition to prevent it from falling. In addition to these functions they translate the trunk, during progression, from point to point, and keep it in equilibrium, in all the varied movements and under the action of all the extraneous forces incidental to locomotion.†

* See Borelli de motu animal, prop. 138, p. 173.

† When a man stands with his centre of gravity at a vertical height *H*, above the plane of the horizon, if his weight be *P*, then the amount of force which he expends in order to stand is, according to Poisson, equal to $P \cdot H$.—*Traité de Mech.* Paris, 1833, § 688.

Walking.—In walking or running, the body may be divided into two portions, namely, the trunk, head, neck, and arms, which constitute the burden that is to be borne, and the legs which support and carry the burden along. The former cannot, however, be considered as a merely passive or dead weight, as the trunk and arms contribute to keep in equilibrio the forces acting on the centre of gravity during progression. In walking, the trunk is carried forwards with its major axis directed nearly perpendicularly to the horizon, like a rod poised endways on the hand. The power to keep the trunk thus poised whilst it is moved forwards is attained only after considerable experience during the earlier period of man's career, when his unsteady gait, numerous trials, and frequent falls afford practical illustrations of the difficulty of the process. Every movement of the legs, arms, head, or trunk, as well as the bearing of burdens in various positions, requires a compensating movement of some other part, in conformity to the theory of parallel forces, to preserve the whole in equilibrio; therefore, in order to keep the supported parts poised on the rounded head of either femur, whilst the body is transferred from one to the other, and carried forwards in the air, either against or in the same direction as the wind, there must be a continued interchange of compensating movements, and these actions are placed under the controul of the excito-motory division of the nervous system. It is well known that when any portion of a rigid body receives motion from a neighbouring body, all the parts of the rigid body will partake of the same motion, only when the direction of the force passes from the point of contact through the centre of gravity. If this is not the case, as, for example, when the upper extremity of the propelling leg acts on the lower part of the trunk of the human body in the erect position, the lower part would be propelled forwards and upwards, whilst the centre of gravity of the trunk would be left behind, and fall backwards; but if this centre be inclined forwards at the beginning of the step, the weight of the body and its required momentum will propel it forwards and downwards; hence the resultant of the several forces will be a force which propels the body forwards in a direction which, by experience, is found to be nearly horizontal: but there is also another force which affects the trunk, namely, the resistance of the air, which tends to turn the trunk backwards, and must be counteracted by the force of gravity, through the inclination of the trunk forwards. The amount of this constant inclination of the trunk must be estimated by the resistance which it encounters from the air in walking and running. It must therefore be greater in rapid progression, because the resistance of the air is then more powerful than in more deliberate motion. Without this inclination it would still be possible to preserve a uniform position of the body in walking and running, not, however, by the force of its own gravity, but by means of the power of the muscles, which connect it with the limbs; but this

would require a great expenditure of muscular force, which is avoided by the inclination of the trunk. That this inclination really takes place is confirmed by experience, and its amount has been measured by Weber, both in walking and running with various degrees of velocity. In order to take these measures with accuracy, a given path was passed over, sometimes in running and sometimes in walking, with various degrees of speed, the time being measured and the steps counted. By means of a telescope, placed sideways to this path, the difference of inclination in walking and running was ascertained, but as it was extremely difficult to find the actual position of the centre of gravity of the trunk in such varying positions, a conspicuous line marked on the trunk was substituted for the vertical line passing from the axis of the femurs through the centre of gravity, and thus its slightest deviations were observed. The vertical position of the trunk when at rest may be exactly estimated by the angle which it makes with this marked line in walking to and fro, in running to and fro, and in standing in the two opposite positions. The last angle, deducted from each of the two first, gives the double inclination of the trunk from the vertical in walking and running. The results of these measurements are given in the following Tables.

TABLE 1.

Measure of the inclination of the trunk in walking and running.

Angle between the two opposite positions of the marked line in standing.

13° 74
13° 74
13° 66
15° 46

14° 00

TABLE 2.

Measure of the inclination of the trunk in walking slowly.

Length of Step.	Duration of Step.	Angle between the two opposite positions of the marked line.	Velocity.	Double inclination of the trunk.
0.629	0.833		0.755	
0.664	0.777	18° 9	0.855	4° 9
0.699	0.848	18° 9	0.824	4° 9
0.664	0.793	20° 6	0.837	6° 6
0.699	0.839	20° 6	0.833	6° 6
0.629	0.812	18° 9	0.774	4° 9

TABLE 3.
Measure of the inclination of the trunk in quick walking.

0.838	0.452		1.85	
0.838	0.426	27° 8	1.97	13° 8
0.838	0.429	26° 1	1.95	12° 1
0.838	0.428	27° 5	1.96	13° 5
0.838	0.444	32° 6	1.89	18° 6
0.816	0.438	31° 8	1.86	17° 8
0.838	0.431	24° 9	1.945	10° 9
0.838	0.419	29° 2	2.00	15° 2
0.838	0.439	27° 5	1.91	13° 5
0.888	9.436	29° 2	2.04	15° 2
0.838	0.432	30° 9	1.94	16° 9
0.888	0.438	32° 6	2.03	18° 6
0.888	0.456	31° 8	1.95	17° 8

TABLE 4.
Measure of the inclination of the trunk in running.

1.372	0.325		4.22	
1.509	0.323	48° 1	4.67	34.1
1.509	0.337	49° 8	5.00	35°
1.509	0.302	55° 8	5.03	41.8
1.509	0.300	56° 7	4.72	42.7
1.509	0.320	53° 3		39.3

We therefore conclude that when we vary our steps, the velocity of the upper ends of the legs, together with a corresponding inclination, is communicated to the trunk. The trunk, then, as has been before observed, exactly resembles a rod balanced on the finger and carried forward; the inclination in both cases depending on the laws of mechanics.

The force of the muscles which keep the trunk in a state of equilibrium is likewise economized in walking and running by the regular oscillations of the arms. The distance of the scapulo-humeral articulation from the axis on which the trunk freely moves, gives any force applied at the shoulder-joint a considerable mechanical effect on the trunk. In progression the arms and legs move simultaneously in the following order. Whilst the right leg swings forwards, the trunk is turned round horizontally on the head of the left femur, and would propel the right shoulder before the left, but at the same time the right arm swings backward and the left forwards, and by generating a force in an opposite direction neutralises this tendency. A corresponding compensation takes place when the left leg swings forward, and this is effected by a good walker, without any sensible lateral twisting of the trunk. The length of the arms is so adjusted to that of the legs, that they oscillate with the latter in small curves simultaneously. Weber has computed the duration of a single oscillation of the arm, hanging straight down, at 0°.63, and when bent at right angles at 0°.53. The pace is less constrained and less fatiguing when the arms are

allowed to accompany the movements of the legs without muscular effort. When the body is put in motion, the momentum generated requires an equal force in the opposite direction to stop it, for which purpose the trunk is thrown back; and this, with the resistance of the feet on the ground, will commonly suffice. When, however, this is not the case, the motion must be arrested gradually, or, as it often happens when the plane of position is composed of ice, the leg goes on without the trunk, and the centre of gravity comes to the ground.

In walking, the trunk is also elevated and depressed at each step vertically, as well as oscillated in other directions. By the assistance of a rod graduated into millimetres, which was carried at the head of the trochanter major by the ambulator, and viewed through a telescope, Weber was enabled to ascertain the amount of the elevation and depression of the trunk. He found that when the length of the steps treading on the whole sole of the foot measured 2.39 feet, the mean elevation and depression were 1.1 inches. The plane in which the rod vibrated, and the magnitude of the oscillations, did not appear to vary materially, whether the speed was accelerated or retarded. In walking on the ball of the great toe the mean elevation and depression of the trunk was 0.8 inch.

Estimate of the forces employed in walking.
The forces which we have to estimate in walking are, first, that of the extension of the leg; secondly, the gravity of the body; thirdly, the resistance which the body encounters in progression. Of these, the first is that force which the leg exerts by its extension to bring it into a straight line, as if both of its extremities (viz. the head of the femur, and that part of the foot which is in contact with the ground) endeavoured to push each other away. The direction of this force depends on the position of the extremities of the leg; but whatever that direction may be, it is always resolvable, on the principle of the parallelogram of forces, into a vertical and a horizontal component. The vertical portion of the extension upwards is equal to the *second* force, or the gravity of the body acting vertically downwards; in this case the centre of gravity remains at the same height above the plane of progression. The horizontal portion of the extension produces an increased velocity in the horizontal direction, the magnitude of which depends on the position of the supporting leg. By means of these forces the body is propelled forwards. At the moment the body receives the impulse of extension it is accelerated until the *third* force, namely, the resistance,* augmenting continually with the velocity, is equal to that of the acceleration; when these two forces neutralize each other, the body will move forwards with an uniform velocity.

Hitherto the forces which influence walking

* The principal resistance is occasioned by the advanced leg when it reaches the ground. Other resistances are the frictions of the joints, of the sole of the foot upon the earth, of the air, &c., but these are very trifling when compared with the retardation caused by the advanced leg.

have been considered as if they were uniformly accelerating forces; but though they are not strictly such, yet as they recur at the end of each step, the mean velocity of the body will remain the same as if they actually were so.*

Let us assume a common point of application of the forces, and consider this as the centre of the body, or the point of separation between the trunk and the legs. The three forces may be represented (*fig. 250*) by three straight lines meet-

Fig. 250.

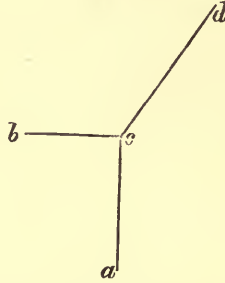

ing at this point, thus: Let *c* be the centre of the body; draw *ca* in a vertical direction, *cb* in a horizontal, and *cd* in the direction of the prolongation of the leg on which the body is supported. These three lines will represent in magnitude and direction the forces which are in action during progression, if they be so taken that either of them equals the diagonal of the parallelogram formed by the other two, and will coincide in direction with that diagonal produced beyond *c*. Messrs. Weber do not consider those physiologists worth refuting who state that the forces which propel the body forwards exceed those that drive it back, for in that case, from the continued preponderance of force in one direction, there would result, not an uniform, but a continually increasing velocity. An uniform motion in a straight line can only take place either when no force whatever is exerted on the moving body, or when all the forces by which it is affected are in equilibrium.

In order to investigate with greater precision the laws which regulate the movements of the body, the Messrs. Weber have considered the weight of the trunk to be collected at the point of junction of the legs, and the weight of each leg, supposed a straight line, to be collected in a point at a given distance from that junction. The movements of these points are supposed to take place in the same vertical plane. They have then applied the general equation for the motion of a system of material points,† and deduced by means of it that the raised leg, in walking, swings forward like a pendulum, the length of which is the above-mentioned given distance, but in consequence of the motion of the point of junction, which is supposed to

* The three forces which influence walking are so related to each other, that each of them is equivalent and opposite to the resultant of the other two.

† See Poisson's *Traité de Mécanique*, Paris, 1833, vol. ii. § 531.

move uniformly in a horizontal line, it has a retrograde motion in its curve of oscillation, which, if measured from its lower extremity, is just equal to the velocity of the point of junction, when estimated in the direction of the tangent of the curve at the commencement of the step. Hence, in quick walking, when the swinging leg is supposed to come to the ground in a vertical position, it describes half of the curve during each step. By following the same course of reasoning Messrs. Weber have ascertained the amount of the vis viva, or vital force, communicated to the swinging leg in any given time; the amount communicated to the body by the standing leg; the proportion which the time when the body is supported on one leg bears to the whole time of a step; and the height at which the centre of gravity is borne above the ground.* In order to verify

* After an elaborate analysis the Messrs. Weber have deduced the following equations, which express the general laws of walking.

$$h^2 + \mu^2 = l^2 \dots\dots\dots (23)$$

$$(h - \frac{1}{2} g \theta^2)^2 + \mu^2 = l^2 \dots\dots\dots (24)$$

$$\frac{t}{\tau} = 1 + n \text{Cos} \left\{ \frac{\pi}{T} (t - a) \right\} \dots (25)$$

$$k = k (\tau - \theta)^2 \dots\dots\dots (26)$$

$$\theta = \frac{3 - \sqrt{1 + \frac{g}{4k}} \tau}{2 - \frac{g}{k}} \dots\dots\dots (27)$$

$$r = \frac{g}{l} \frac{T^2}{\pi^2} \dots\dots\dots (28)$$

In which equations

$$n = \sqrt{1 + \frac{r h^2}{l g \tau^2}}$$

$$a = \frac{T}{\pi} \text{arc} \left(\text{Cos} = \frac{1}{n} \right).$$

$$k = \frac{(\mu + 1) g}{\left(1 + r n \frac{\pi}{T} \text{Sin} \left\{ \frac{\pi}{T} (t - a) \right\} \right)^2 - (1 - r)^2}$$

The mass of the trunk is supposed to be concentrated in a point *m* at the upper end of the leg, and the mass of the swinging leg in a point *m'* in the leg which is considered as a straight line.

l is the length of the hinder leg at the beginning of a step.

h is the height of *m* above the horizontal plane at that time.

p is the distance between the hinder foot and the forward at that time, or the length of a step.

θ is the time during which *m* falls below its horizontal line at the end of the time *t*.

l' is the length of the hinder leg at the end of the time θ before it is extended or becomes *l*.

τ is the time of one step.

t is that portion of it during which the leg is swinging.

the pendulous movements of the legs a person was placed upon a small block, and by supporting himself on one leg, suffered the other, measuring thirty inches, to swing, with relaxed muscles, as a pendulum. A vibratory motion having been communicated by a slight movement of the trunk backwards and forwards, the number of oscillations made in the time of a minute were found to be 84, consequently

$$\frac{60''}{84} = 0''.714285 = \text{time of one oscillation};$$

and since the lengths of pendulums at the same place vary inversely as the squares of the numbers of oscillations in a given time, $84^2 : 60^2 : : 39\frac{1}{2} : l$ (the length of a pendulum which vibrates synchronously with the leg);

$$\text{hence } l = \frac{60^2 \times 39\frac{1}{2}}{84^2} = \frac{140850}{84^2} = 19.961$$

inches. Now as the whole length of the leg was 34 inches, the centre of oscillation must be less than two-thirds of that length from the point of suspension, and consequently less than in a prismatic rod, the length of which is such as will vibrate synchronously with the leg. This accords with the known figure of the leg, the mass of which diminishes as the distance from the axis of motion increases. The time of a half oscillation of the freely suspended leg which we have found $\frac{0''.714285}{2} = 0''.3571425$, approximates very closely to that found by the Webers, both in the living and the dead subject.

The second experiment was made by our engraver, Mr. Vasey. In walking at the rate of four miles per hour he counted 2000 steps every fifteen minutes; then $\frac{15 \times 60}{2000} = 0''.45$

the time of each step; now as 2000 steps were taken in one mile of 5280 feet, the length of each

r is the ratio of the distance between *m* and *m'* to *l*.

g is the accelerating force of gravity = 32.5 feet.

π is the number 3.1416.

T is the time of an oscillation of a pendulum whose length is *rl*.

μ is the ratio of the mass of the trunk to the mass of the swinging leg.

The quantities *l*, *T*, μ must be previously ascertained, and π and *g* being always the same, there will be nine equations for finding the values of the ten remaining quantities; if therefore we know any one of these ten, the rest may be found.

In regular progression the force communicated by the supporting leg to the trunk must equal that imparted by the trunk to the swinging leg, that is

$$m' \left(c + r n \frac{\pi}{T} \text{Sin} \left\{ \frac{\pi}{T} (t - a) \right\} \right)^2 - m' (1 - r)^2 c^2 = \frac{m + m'}{h} g p^2 \frac{2 t - \tau}{\tau}$$

from which, by substituting $\frac{p}{\tau}$ for *c* and μ for

$$\frac{m}{m'}$$

we get equation (26.)

Fig. 251.

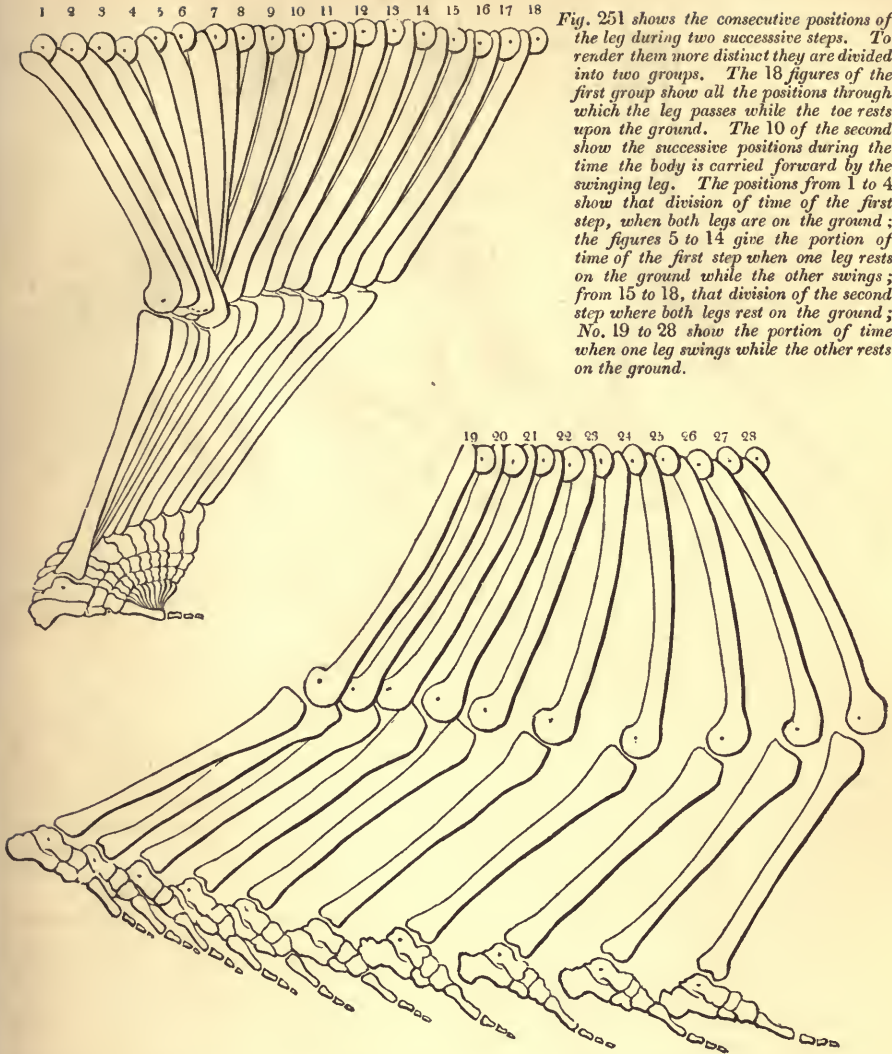

Fig. 251 shows the consecutive positions of the leg during two successive steps. To render them more distinct they are divided into two groups. The 18 figures of the first group show all the positions through which the leg passes while the toe rests upon the ground. The 10 of the second show the successive positions during the time the body is carried forward by the swinging leg. The positions from 1 to 4 show that division of time of the first step, when both legs are on the ground; the figures 5 to 14 give the portion of time of the first step when one leg rests on the ground while the other swings; from 15 to 18, that division of the second step where both legs rest on the ground; No. 19 to 28 show the portion of time when one leg swings while the other rests on the ground.

step must have been $\frac{5280}{2000} = 2.64$ feet. In this case also the length of the leg was 34 inches, which gives 19.961 inches for the length of the synchronous pendulum, and for the time of each half oscillation $0''.357$; hence the time of taking each step was longer than the time in which the leg was susceptible of swinging without muscular effort, as a pendulum, by about $0''.093$.

The step is considered as commencing at the instant when the hindmost leg is raised from the ground. Let us then suppose the whole sole of the foot of the right leg, which is in advance of the left, to be in contact with the ground, upon which it acts as a fulcrum; the hip, knee, and ankle-joints to be in a state of partial flexion, and the line from the head of

the femur to the ankle-joint to be vertical, as in fig. 251, No. 4. In this position, the right leg supports the whole weight of the trunk, and the left, being extended obliquely backwards, does not contribute to the support of the burthen. The flexed position of the right leg lowers the centre of gravity, and the effective portion of the force of extension, acting only in a vertical direction, produces no horizontal motion. At this moment, the left leg having previously communicated a slight horizontal impulse to the centre of gravity, and the trunk being inclined forwards, the head of the femur of the right leg is propelled from No. 4 towards No. 18. The leg, instead of being vertical, is now directed obliquely forwards and upwards. In order that the head of the femur with its load may be sustained at the same height above the

Fig. 252.

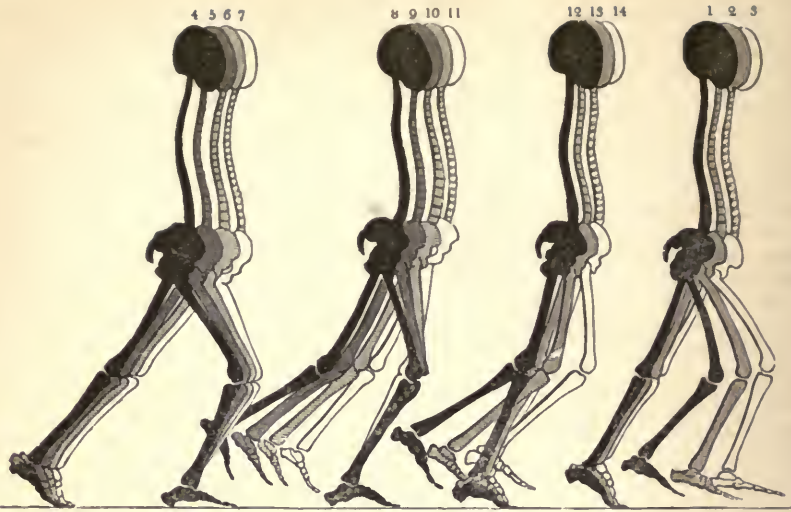

Fig. 252 shows the simultaneous positions of both legs during a step, divided into four groups. The first group, 4 to 7, gives the different positions which the legs simultaneously assume while both are on the ground; the second group, 8 to 11, shows the various positions of both legs at the time when the posterior leg is elevated from the ground, but behind the supported one; the third group, No. 12 to 14, shows the positions which the legs assume when the swinging leg overtakes the standing one; and the fourth group, 1 to 3, the positions during the time when the swinging leg is propelled in advance of the resting one.

plane of motion, whilst it moves forwards with the trunk, from No. 4 to 18, the distance from the head of the femur to the foot must be constantly increasing. To accomplish this the muscles which extend the hip, knee, and ankle-joints are gradually contracted, and the length of the leg sufficiently increased by its extension to reach from No. 18 to the ball of the foot (fig. 251). In these movements the sole of the foot rotates on the ground, and (independently of the angle formed by the legs) increases the length of the step by the length of the foot from the heel to the ball; because, when the head of the femur arrives at No. 18, fig. 251, the line from the ankle-joint to the ball is perpendicular to the ground. At the moment that the head of the femur of the left leg arrives at a position vertical to the foot, as No. 4, fig. 251, the right leg is lifted from the ground,* and, from its oblique position and weight, swings forward like a pendulum, whose axis of motion is in the hip-joint, Nos. 19 to 28, fig. 251, and having passed by the supporting leg it touches the ground, with the ankle-joint in advance of the head of the femur, No. 1, fig. 251. The heel is first placed upon the earth, and by degrees every part of the

* Measure of the elevation of the heel and toes in walking, the distance passed through 30 metres.

Number of steps.	Time.	Elevation of the heel.	Elevation of the point of the toe.	Velocity.
41	17'.4	0.178	0.092	1.72
39	12'.7	0.173	0.115	2.36

sole, the hollow arch only excepted, is brought into contact with the ground, and the head of the femur is again over the ankle-joint, as before, No. 4, fig. 251. The motion of the left leg alternates with that of the right in the same manner.* In the first period of the movement the left leg is seen in the rear of the right leg, No. 8 to 11, fig. 252. Having overtaken the latter, No. 12 to 14, fig. 252, it advances before it and comes to the ground in sufficient time to receive the weight of the body as soon as the right leg ceases to act, No. 4, fig. 252, so that the instant the weight of the trunk is transferred to it from the right leg bending slightly and returning to its former position, it acts like a spring, and prevents any sudden concussion arising in consequence of the translation of the burthen from one leg to the other. The weight of the trunk being thus propelled, supported, and transferred from one leg to the other alternately, a constant and uniform movement in a horizontal direction is maintained. The right and left leg having thus swung and supported the body alternately, and having been on the ground simultaneously a short, and separately a long, period, the horizontal path of the centre of gravity, during these two movements, is equal to the length of a double step. In consequence of this interchange of offices the supporting leg is active, whilst the swinging leg is comparatively pas-

* The Webers compare the action of the foot to the rolling of a wheel, with this difference, that the rotation of the wheel is uninterrupted, whilst that of the foot is terminated and renewed at every step. In walking on the ball of the foot, or on the toes, the rotation is confined to the distance between the ball of the foot and the point of the toes.

sive; that is, it swings forwards by the force of gravity alone, independently of muscular action. The supporting leg is regarded by the Messrs. Weber as a substitute for the propelling weight of a clock, and the swinging leg as the substitute for the pendulum, both exchanging their offices alternately. The distance from the point where the ball of the foot of the swinging leg quits to the point where it is again placed on the earth, is equal to the length of a double step. This outline of the action of the legs in walking depends on principles which we shall now proceed to investigate more strictly, in doing which we shall draw largely from the theoretical and experimental researches of the Messrs. Weber, whose labours have contributed so extensively to advance our knowledge in this interesting branch of human physiology.

The positions of the body in walking at various instants of time have been described both by Borelli and Weber; it is thus represented by the latter. Let *fig. 253* be the vertical, and *fig. 254* the ground plan, on planes in a straight

Fig. 253.

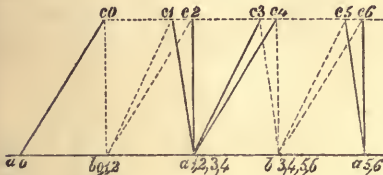
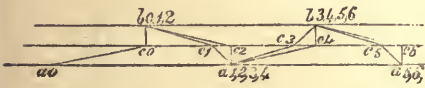

Fig. 254.



horizontal path. In *fig. 253* the simultaneous positions of the two feet are represented at the moment when they reach the ground, also the position of the centre of gravity of the body in the vertical plane. The position of the right leg is shown by the continued lines, and that of the left leg by the dotted lines. The extremity of the right foot is designated by the letter *a*, that of the left by the letter *b*, and the centre of gravity by *c*, the contemporaneous positions of these points being denoted by the numerals annexed to these letters. In the horizontal projection, *fig. 254* represents the simultaneous position of both legs and of the centre of gravity: the letters and figures are the same as in the preceding diagram. At the instant when the hinder leg is raised from the ground at the commencement of each step, the extremity of the forward leg and the centre of gravity lie in the normal plane of the line of progression; for example, at the beginning of the first step, b_0 and c_0 , of the second step a_2 and c_2 , and of the third step, b_4 and c_4 , lie in the normal plane of the direction of progression.

In each step the extremity of one leg must

be advanced as far before the foot of the other as in the preceding or following steps the other leg was placed before the first, for example:— in the first step, the foot, $a_1, 2, 3, 4$ must advance so far before $b_0, 1, 2$, as in the second step $b_3, 4, 5, 6$ must advance before $a_1, 2, 3, 4$.

The time of each step, that is, the space of time between the raising of each foot in succession, is subdivided by Borelli and the Webers into two parts, namely, one part in which one leg, and the other when both legs are on the ground: for instance, during the first step, while the centre of gravity advances from c_0 to c_1 , one leg, and, while it advances from c_1 to c_2 , both are on the ground. In the second step, while the centre moves from c_2 to c_3 , one leg only, but while it advances from c_3 to c_4 both legs are again on the ground, and so on in succession. But there is no instant in walking in which the body moves freely through the air without either leg touching the ground, as in running.

The sum of the squares of the elevation of the centre of the body above the horizontal plane, and the length of the step, is equal to the square of the length of the extended leg.* This proposition depends on the circumstance that the forward leg stands vertical to the ground at the instant the hinder leg quits it; and that the two legs, with the horizontal distance between them, form, at this moment, a right-angled triangle. According to the Webers, the body, in walking, continues to be affected by the extensor power of one leg only, because the expenditure of the extensor power of the legs to support the body is only just sufficient to sustain it; and this expenditure is at a minimum only when the *forward leg* bears the whole burden during that period in which they are both on the ground, for as the forward leg acts at a less angle than the hinder leg, it is capable of supporting the body at a much greater mechanical advantage, which is at a maximum when it stands vertically. MM. Weber also find that the body is accelerated whilst one leg, and is retarded whilst both legs are on the ground; for, in slow walking, the forward leg being placed on the ground in advance of the centre of gravity, it tends for an instant to check the horizontal velocity of the body.

We shall now take a brief view of the velocity in walking, and of the principles on which it depends. MM. Weber have shewn that the velocity in walking varies with the height at which the head of the femur is carried from the ground; as this height *increases*, the velocity *decreases*.† The length of each step decreases as the height of the centre of gravity increases; for the greater the elevation, the less will be the distance to which the leg will extend; therefore corpulent persons, and porters with heavy burdens on the shoulders, take steps of diminished length. The duration of a step,

* Hence we get eq. 23.

† The velocity being uniform $= \frac{p}{\tau}$ and therefore increases as h decreases.

also, depends on this height. When the centre of gravity is most depressed, the swinging leg must be placed on the ground in the vertical position, instead of being suffered to pass beyond it, as it does in slow walking. In quick walking the propelling leg acts more obliquely on the trunk, which is more inclined, and forced forwards more rapidly than in slow walking. The time when both legs are on the ground diminishes as the velocity increases, and it vanishes altogether when the velocity is at a maximum.

TABLE 5.

Measure of the velocity in quickest walking. Space traversed 47 metres.

Number of Steps.	Time.
53	17.57
54	18.00
55	18.20
54.5	18.18
55	18.42
54.5	18.00
54	17.92
55	18.10
54	17.77
54	18.05
54.3	18.021

From this table we observe that the velocity in quickest walking is at the rate of 2.608 metres, or about 7.897 feet per second. In conducting their experiments the MM. Weber found that the velocity was constant, whether the power of the muscular system had been renovated by repose, or exhausted by fatigue, and therefore they concluded "that so long as the muscles exert the general force necessary to execute locomotion, the velocity depends on the size of the legs and on external forces, but not on the strength of the muscles."

TABLE 6.

Measures of military marching. Space traversed 43.43 metres.

Number of Steps.	Time.	Duration of Step.	Length in Metres.	Velocity.
49.3	21.50	0.436	0.881	2.020
52.3	27.17	0.519	0.831	1.598
54.7	32.35	0.592	0.794	1.342
61.7	43.57	0.706	0.704	0.997
68.8	55.08	0.801	0.631	0.789
74.2	64.02	0.863	0.585	0.678
87.1	83.72	0.961	0.499	0.519
100.5	105.16	1.046	0.432	0.413
111.5	124.00	1.112	0.390	0.350

TABLE 7.

Measure of the time of vibration of the leg, and of the shortest time of a step in different persons.

Persons.	Duration of Swinging.	Duration of Step.
A.	0.730	0.375
B.	0.662	0.337
C.	0.730	0.372
D.	0.680	0.340
E.	0.696	0.348
F.	0.746	0.341
G.	0.740	0.380
H.	0.690	0.370
I.	0.663	0.337
K.	0.678	0.345
L.	0.724	0.362
M.	0.743	0.374
Mean.	0.7068	0.3567

TABLE 8.

Measure of the natural gait in walking with different velocities on the entire sole of the foot.

Space traversed 43.43 metres.

Number of Steps.	Time.	Duration of Steps.	Length of Steps.	Velocity.
			met.	
51	18.12	0.335	0.851	2.397
52	20.48	0.394	0.835	2.110
54	22.55	0.417	0.804	1.928
54	24.83	0.460	0.804	1.748
55	26.38	0.480	0.790	1.646
57	28.90	0.507	0.726	1.503
60	33.70	0.562	0.724	1.288
61	34.92	0.572	0.712	1.245
65	39.27	0.604	0.668	1.166
66	41.60	0.630	0.658	1.044
69	45.72	0.663	0.629	0.949
69	46.07	0.668	0.624	0.942
73	53.02	0.726	0.595	0.819
76	57.72	0.760	0.572	0.753
82	69.40	0.846	0.530	0.627
80	68.78	0.860	0.543	0.631
88	79.67	0.908	0.493	0.545
97	93.67	0.966	0.448	0.464
101	104.08	1.030	0.430	0.417
109	114.40	1.050	0.390	0.379

TABLE 9.

Experiments on the time during which the leg rests on the plane of position in various degrees of velocity.

Duration of Step.	Length of Step.	Velocity.	Time of Leg standing.
	met.		
0.344	0.790	2.30	0.341
0.376	0.804	2.14	0.400
0.429	0.755	1.76	0.484
0.523	0.657	1.27	0.570
0.742	0.659	0.89	0.817

TABLE 10.

In the following table we find the proportion between the duration of the step and the time of the leg resting and swinging during very diversified paces.

Duration of Step.	Duration of Standing.	Duration of Swinging.
0.344	0.341	0.347
0.376	0.400	0.352
0.429	0.484	0.374
0.523	0.570	0.476
0.742	0.817	0.667

These experiments prove that the time in which the leg is swinging is least in the quickest pace, and is equal to half the whole time of oscillation of the leg; that it increases in proportion as the step becomes slower; that, consequently, that division of time which the swinging leg occupies in describing its entire curve is increased by one-half of the entire portion of time, and more in proportion as the pace becomes slower. This gives rise to another range of experiments which have been made by the Messrs. Weber with the same design, of which the following table is the result.*

TABLE 11.

Experiments on the time in which the leg stands on the ground, with various degrees of velocity in walking.

Duration of Step.	Length of Step.	Velocity.	Duration of the Leg resting.
	<i>m.</i>		
0.317	0.820	2.587	0.317
0.430	0.741	1.721	0.513
0.463	0.712	1.537	0.504
0.582	0.621	1.067	0.692
0.660	0.562	0.851	0.782

Whence we deduce the following comparison between the duration of the leg standing and that of its swinging.

Duration of Step.	Duration of Standing.	Duration of Swinging.
0.317	0.317	0.317
0.430	0.513	0.347
0.463	0.504	0.422
0.582	0.694	0.472
0.660	0.782	0.538

The number of steps which a person can take in a given time in walking depends, first, on the length of the leg, which, governed by the laws of the pendulum, swings from behind

* In these experiments the footsteps were taken on the ball only.

forwards: secondly, on the earlier or later interruption which the leg experiences in its arc of oscillation by being placed on the ground. When the hinder leg has quitted the ground, it swings forward by its own gravity, in consequence of its freedom of motion in the ilio-femoral articulation and its oblique position; and, in order that the body may be supported, it must, at least, move so far forwards that the foot may arrive at a position vertically under the head of the femur; for in that direction the leg not only supports the body with least effort, but it is also in that position that it can most easily avoid any impediment in its path by transferring the point of support to any portion of the sole of the foot, particularly if the latter be turned outwards, which gives a greater security than when it is directed parallel to the line of motion. The weight of the swinging leg and the velocity of the trunk serve to give the impulse by which the foot attains a position vertical to the head of the thigh bone; but as the latter, according to the laws of the pendulum, requires, in the quickest walking, a given time to attain that position, or *half* its entire curve of oscillation, it follows that every person has a certain measure for his steps, and a certain number of steps in a given time which in his natural gait in walking he cannot exceed. We can easily ascertain the time it requires to accomplish the quickest step in walking, which is equal to the half vibration of the leg made with relaxed muscles. In order to make the steps follow each other in much slower succession, the foot is not placed on the ground when it arrives in the perpendicular position, or the half oscillation from behind forwards as in the rapid pace, but we plant it on the ground somewhat later when the foot has described more than half the curve of vibration. From these principles we conclude that the man in *fig. 255* walks much faster than that in *fig. 256*; in fact the former makes steps 27.559 in. in length, whereas in the latter the steps are barely 23.622 in. in length; and whereas the first makes a step in 0'.35, the second takes 0'.422 for a step, so that the velocity of *fig. 255* is nearly double that of *fig. 256*. These figures are represented as walking on the toes, as if the foot always touched the ground in the same position, and their steps are shorter than when the entire sole is brought into action. *Fig. 255* shows the greatest step which it is possible to make with the toes. The steps are shortest in *fig. 257*, in which the difference of the heights of the centre of gravity, compared with that of *fig. 255*, may be easily seen.*

In *figs. 258, 259, and 260*, the legs are of

* These figures, with the others upon the same plan, reduced to $\frac{1}{20}$ th the natural size, are drawn in accordance with the principles on which the theories of walking, running, and leaping are based. They are taken in the various instants of a step as seen through a revolving disc, constructed upon the principles of the stroboscope invented by Dr. Faraday, and modified so as to apply to these purposes by Stammer.† These

† Vide Poggendorff's Ann. vol. 22. p. 600.

Fig. 255.

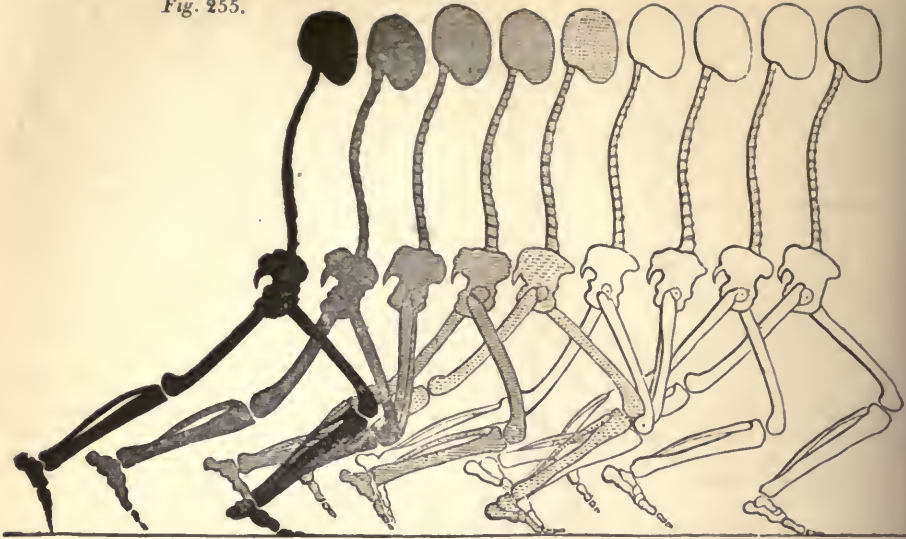
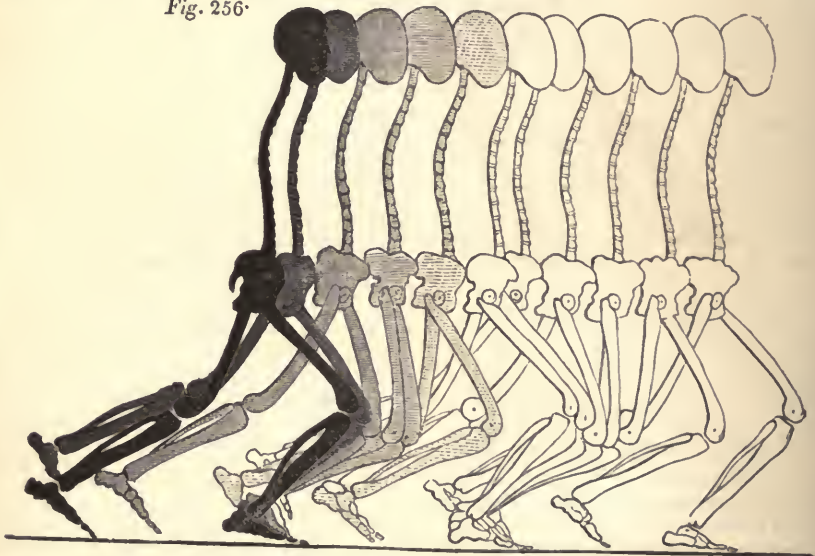

Fig. 256.



figures serve also to illustrate the following formulas.

$$h^2 + p^2 = l^2.$$

$$t - \tau = \tau \cos \frac{\pi}{1} t.$$

$$h = \frac{(\mu + 1) g}{\left(1 + \frac{\pi \tau}{1}\right)^2} \tau^2$$

These three equations, which are deduced from the general formulas, are intended to express the principal data upon which the theory of walking is based. If $n = r = 1$, and $\theta = 0$, and we substitute for μ its value as deduced from experiment in walking, and let $(\mu + 1) g = 34.65$,[†] $T = 0''.7$ and $l = 0.95$ met. by substituting these

values in the equations above we get the following results which accord very closely with experiment.

No.	τ	t	h	p
			m.	m.
1	0.350	0.350	0.642	0.700
2	0.414	0.372	0.727	0.611
3	0.422	0.375	0.736	0.600
4	0.432	0.378	0.749	0.585
5	0.446	0.382	0.765	0.564
6	0.465	0.387	0.786	0.533
7	0.494	0.395	0.817	0.484
8	0.542	0.406	0.864	0.395

Nos. 1 and 3 are represented in figs. 255, 256, and Nos. 1, 3, 7, in figs. 258, 259, 260.

[†] In this estimate $\mu = 2.53$, $g = 9.811$ metre.

equal length, equally extended, and represented at the moment when the previously swinging leg is placed on the ground; but *fig. 260*, which is walking slowly, has the leg advanced far beyond the vertical. *Fig. 259*, which is walking quicker, has the leg less advanced, whilst *fig. 258*, which represents the greatest possible celerity, has the foot placed directly in the vertical line, passing through the head of the femur. We observe also that of the paths

described by the swinging leg of the three figures, that of *fig. 260* has nearly completed the entire curve, that of *fig. 259* a little more than half, and that of *fig. 258* exactly half the curve; and that the dotted line which serves to indicate the path of the leg is least in *fig. 260*, greater in *fig. 259*, and greatest in *fig. 258*. The time is greatest in *fig. 260*, less in *fig. 259*, and least in *fig. 258*; consequently, when the leg swings beyond the

Fig. 257.

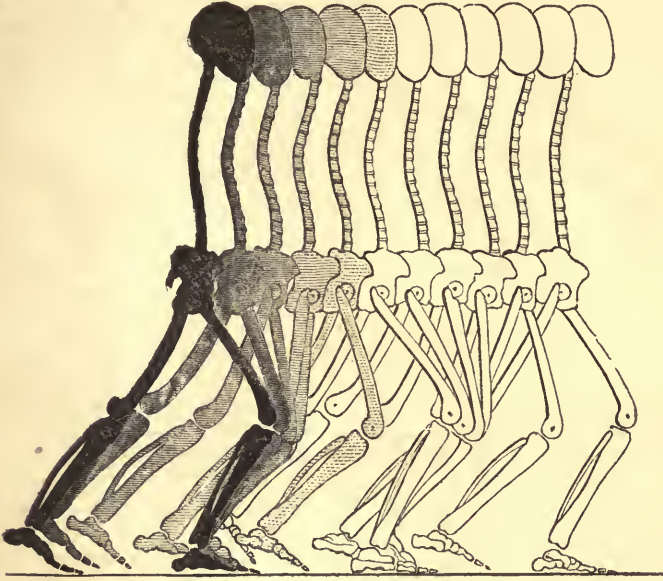

Fig. 258.

Fig. 259.

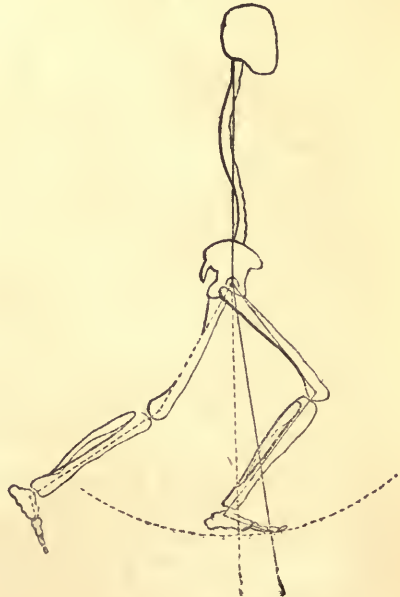
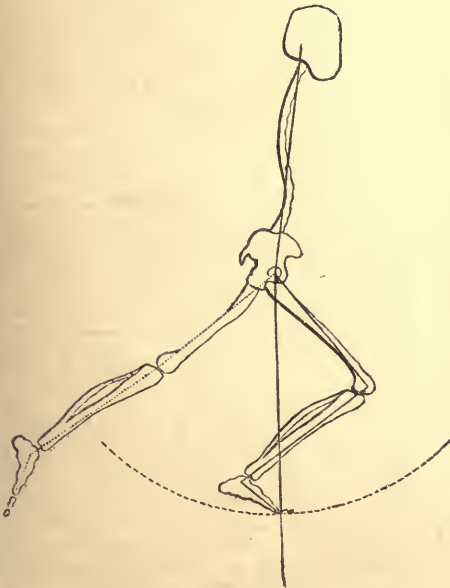
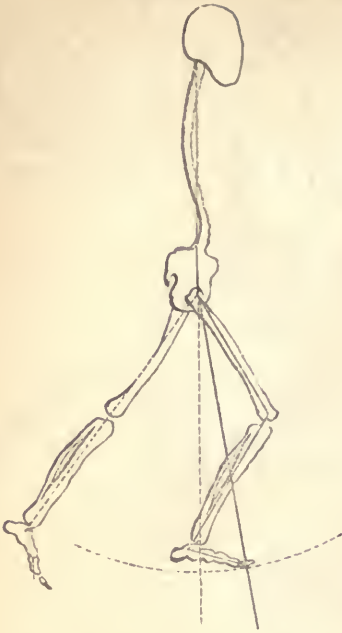

Fig. 260.



vertical line, not only the time of swinging the leg has increased, but also the time in which both legs are resting on the earth; for the latter commences at the instant when the forward leg has reached the ground, and terminates when the head of the femur has arrived at the vertical line, passing through the point of support of the same foot. The time augments in proportion to the distance which the swinging leg passes beyond the vertical position, or half oscillation. The time when both legs are resting is greatest in *fig. 260*, because it must be sufficiently great for the head of the femur, together with the whole trunk, to advance to a position directly over the foot, during which the head of the femur moves very slowly, and by the direction of the forward leg its action is to retard the horizontal advance of the centre of gravity. The time is less in *fig. 259*, because the head of the femur has to pass through a less space, and the supporting leg acts against the trunk at a less angle; but in *fig. 258* the time of both legs resting at the same time, disappears altogether. The two legs complete the least portion possible of the vibrating curve, and the duration of each step amounts only to the time of half an oscillation. In walking very slowly we may suffer the swinging leg to vibrate so long, that it partly returns to its former position before it reaches the ground.

We have seen in quick walking that during the time both legs rest on the ground, the advanced leg continually forms a smaller angle with the vertical than the hinder leg; but in very slow walking the forward leg may form a greater angle with the vertical than the hinder leg; the magnitude of this angle determines the

kind of gait the walker acquires. In order to accomplish this, the swinging leg is suffered nearly to complete its curve of oscillation before it is placed on the ground, and during this time the centre of gravity moves so little, that half the length of the step may not be at once described, and the entire duration of the step will be about four times greater than in the quickest pace.* In this case the forward leg really makes a greater angle than the hinder as it reaches the ground, but during the time that both legs are on the ground, the angle of the forward leg diminishes, whilst that of the hinder leg augments, and there is an instant when both legs form equal angles. When the angle of the forward leg becomes zero, or in other words, when it is directed vertically, the hinder leg rises from the earth; for example, in *fig. 261*, where *a c* represents the right leg, *b c*

Fig. 261.



the left, in the beginning of a step, or the instant the foot *a* is raised from the ground; *c c'''* is the magnitude of the step, or the space which the centre of gravity passes through in the time of a step, *c''* being the centre of that space. Now, if the foot *a*, which was raised at the beginning of the step, were placed again on the ground at *a'*, at the instant when the centre of gravity reaches the middle point *c''*, then both legs would form equal angles with the vertical; or, the angle $b c'' a = a' c'' a$, in which $c'' a$ is the vertical through *c''*; but if the angle of the hinder leg to the vertical be less, when the right leg is set down in *a'*, the centre of gravity will not have arrived at the middle point *c''*, but at *c'*; however, whilst both legs are on the ground, the centre of gravity is propelled from *c'* to *c''*, after which the angle $b c' a$ increases and the angle $a' c' a$ diminishes (where $c' a$ is the vertical through *c'*); when the centre of gravity is propelled onwards from *c''* to *c'''*, the angle $a' c' a$ is less than $b c' a$, until the termination of the step.

In this slow method of walking a very measured pace results, in which the body is carried very erect, and remains for a considerable time in the rear of the forward leg after it first reaches the earth; consequently the duration of the step will be very considerable, nearly one second and a half, the length of the step very short, and the velocity of the centre of gravity, which is very little at the middle of the step, varies considerably during each step, so that there is an instant in which the body is nearly at rest. This is denominated by Weber *the grave or procession step*.†

A remarkable difference may be observed in the duration of the steps of two different persons, one of whom has long and the other short legs. In quickest walking the duration of

* That is, where *T* represents the entire duration of an oscillation of the leg, the time of a step in the quickest to that in the slowest walking will be as $\frac{1}{2}T$ to $2T$, or four times that of quickest walking.

† Vide Weber, loc. cit. sect. 139, p. 344.

their steps will equal the time of oscillation, and the case is nearly the same in a slower pace. We observe, therefore, that when children and grown persons, or tall and little men, are walking together in the pace most easy and natural to them, they move in a different time. It is true the movements of the legs, like those of any other member, may be accelerated by means of the muscular force and made to move quicker than when they are merely impelled by their own gravity in swinging from behind forward, but when so continued an exercise of muscular power is required, such an unnatural pace cannot long be sustained.

In the estimate already given of the forces which have an influence in walking, it will be observed that as long as the force of the extension of the legs in a vertical direction upwards, is equal to that of gravity upon the body acting vertically downwards, the centre of gravity will move in a direction perfectly horizontal; but experience shows that as soon as the force of the extension of the supporting leg ceases, the centre of gravity falls below the horizontal path in which it was previously moving; but the instant the other leg stands perpendicularly it will rise again to its former level. The mathematical theory of walking proves that from the figure of the human machine there must of necessity be a sinking of the centre of gravity in order that progression may be accomplished. By varying the time of the sinking of the body at the end of each step, the effect of the resistance of the air and other extraneous influences which would disturb the horizontal velocity of the trunk, are compensated. In a favourable wind, when it travels at a greater velocity than the walker, it is necessary he should increase the time of sinking to counteract its effect, and preserve a mean uniform motion.

The application of mechanical principles does not accord with slow as it does with that of quick walking, for the former is too much under the control of the will of the walker, and the limbs are not suffered to swing freely by their own gravity as in quick walking, in which this volition diminishes, according to Weber, at least when the slightest exertion is continued for any length of time, and it is in this condition alone that theory and experiment nearly approximate. We must, however, remember that the control exercised by the muscular system over the limbs in slow walking is a new force which animals are enabled to interpose in order to vary the effects which result from the physical laws in operation during locomotion, and by no means refutes the theory of the influence of those forces which affect, not only the locomotion of animals, but the motion of matter universally.

Running.—The laws which regulate running in many of the lower animals, such as quadrupeds and birds, are nearly the same as in Man. It will therefore be necessary to enter into the details of this movement in reference to the latter only.

The principles upon which walking and running differ.—In running as in walking it may be considered as a fundamental law that

the same motions of the body recur after each double step; and that both legs exercise equal and alternate actions in these movements. In running the object is to acquire a greater velocity in progression than can be attained in walking. In order to accomplish this, instead of the body being supported on each leg alternately, the action is divided into two periods, during one of which the body is supported on one leg, and during the other it is not supported at all. The latter condition constitutes the principal difference between these two modes of progression. When the body is projected upwards so as to swing freely in the air, the hinder leg must be raised from the ground before the advanced swinging leg has reached the vertical position; hence, in running, the duration of the step is less than the half-duration of the oscillation of the leg, because, when the advanced leg has reached the vertical position and is again placed on the ground, the hinder leg has already begun to describe a portion of its arc of oscillation. By these means the duration of the step is diminished, whilst the length is increased, both of which tend to augment the velocity. The length of the step is consequently greater than that side of a right-angled triangle, whose hypotenuse is the extended leg, and the other side the elevation of the centre of gravity above the ground. In running the step may be divided into two periods; the first, the time t , during which the body is supported on one leg, and the second, the time $\tau - t$, during which it is not supported at all.

Forces employed in running.—The forces which act in running are the same as in walking; first, extension; secondly, gravity; thirdly, resistance. In running, a horizontal movement of the centre of gravity is not practicable as in walking, for although the extensor power might be so regulated that the centre should continue at the same elevation so long as the body poised on one leg, it would evidently fall during the time it was left unsupported. Now, as it is found after the whole time of a step to have neither sunk nor risen, and since no instantaneous elevation of the centre of gravity takes place between the termination of the preceding and the commencement of the following step; it follows that during the time t , it must ascend just as much as it sinks during the time $\tau - t$. The effects of gravity and resistance have been sufficiently explained in the theory of walking.*

The conditions for regular progression in

* By an analysis based on data similar to those for walking, Messrs. Weber have deduced the following equations which express the general laws of running.

$$(h + s)^2 + c^2 t^2 = l^2 \dots \dots \dots (29)$$

$$(h + s - \frac{1}{2} g t^2)^2 + c^2 t^2 = l^2 \dots \dots \dots (30)$$

$$\frac{1}{2} T + \beta = 2 \tau - t \dots \dots \dots (31)$$

$$s = \frac{1}{2} g \frac{t}{\tau} (\tau - t)^2 \dots \dots \dots (32)$$

running are fulfilled if the vital force which the body receives by the extension of the supported leg whilst it is on the ground, is equal to the vital force communicated to the swinging leg during the time of its oscillation.*

The motions of walking and running tend continually to approximate, in proportion as the time in which both legs are on the ground in the former, and the time in which the body is not supported at all in the latter, is diminished, and the laws of both running and walking coincide, when the time that the body swings unsupported in the air in the former, and that where both legs are on the ground in the latter, vanishes.

The resistance of the air to the trunk, when it is propelled with great velocity as in running, requires to be compensated, in order to be kept in a state of equilibrium, either by the force of its own gravity, or by that of its muscular system. The former method is usually adopted to prevent an unnecessary expenditure of vital power.

It will be seen in Table 4, that the angle of inclination of the trunk in running, is to that in quick walking, as 49°.8 to 31°.8, when the

$$h = \frac{(\mu + 1)g(t - \beta)^2(1 - \frac{2s'}{3h})}{(1 + rn \frac{t}{T})^2 - (1 - r)^2} \dots (33)$$

$$r = \frac{g}{l} \frac{T^2}{\pi^2} \dots (34)$$

$$s = \frac{t}{t - \beta} s' \dots (35)$$

In which equations,

$$\beta = \frac{T}{\pi} \arccos \left(\cos \frac{1}{n} \right)$$

$$n = \sqrt{1 + \frac{r(h - s)^2}{lg^2}}$$

The other expressions being the same as those in walking,

c is the uniform velocity of the point *m* in a horizontal direction.

s is the space through which the centre of gravity is raised in the time *t*.

s' is the space through which the same centre is raised in the time *t* - β .

When $\tau - t = 0$, that is, in slowest running, the above equations become identical with those in quickest walking, where the time during which both legs are on the ground vanishes.

* That is, when

$$(m + m') \frac{g c^2 (t - \beta)^2}{h} \left(1 - \frac{2s'}{3h}\right) =$$

$$m' \left(1 + rn \frac{t}{T}\right)^2 c^2 - m' (1 - r)^2 c^2$$

and as $\mu = \frac{m}{m'}$ by substituting μ , we get equa-

tion (33), from which the height of the centre of gravity is to be found.

length of step in the former is to that in the latter as 1.509 to 0.888.

In order to find the amount of the vertical undulations of the trunk in running, MM. Weber viewed the runner through a telescope, adapted for that purpose. They calculate the undulations to be from $\frac{1}{4}$ th to $\frac{1}{3}$ th of an inch; they estimate the duration of the step to be $\frac{1}{4}$ th to $\frac{1}{3}$ th of a second, of which the body swings freely in the air $\frac{1}{10}$ th of a second, and of this falls $\frac{1}{13}$ th; now, by the law of falling bodies, the centre of gravity will descend in this time 22 mm. = 0.85614 in.; hence, the body falls through a less space in running than in walking.

The simultaneous positions of the centre of gravity and of the two feet at individual instants of time, of which *fig.* 262 is a vertical, and *fig.* 263 a horizontal representation. The right foot is marked *a*, the left *b*, and the centre of gravity *c*: b_1, a_2 signifies that during the time *a* is passing from *a* to a_2 , and *c* from *c* to c_2 , *b* remains standing on the point b_1, a_2 , and so on. In order to distinguish the swinging from the supporting leg, in *fig.* 262, the former is so contracted that it does not reach the horizontal line; and in *fig.* 263, the swinging leg is represented as if it swerved from the path both on the right and left sides alternately: $c_1, c_2 = c_3, c_4 = c_5, c_6, c_7$, indicate the length of the step = *p*, $a_1, a_2, a_3 = a_4, a_5, a_6 = b_1, b_2, b_3 = 2p$. The time which elapses from the instant when *b* steps in b_1, a_2 to a_3, a_4 , is the duration of a step τ . The time in which *c* advances from c_1 to c_2 is the time *t*, when the body is supported upon one leg. The time in which *c* advances from c_2 to c_3 is the time $\tau - t$, during which the body swings in the air. The time in which *c* advances from c_2 to c_3 , is the time in which the left leg swings, which is greater than τ , in which *c* merely passes from c_3 to c_4 . The instant when the left leg steps in b_1 or the right in a_3 , the leg must press against the ground with such force as to impede the accelerating force of gravity upon the body, and communicate to it an ascending movement; to accomplish this, the leg must be set down on the ground perpendicularly, therefore the lines $c_1, b_1, c_2, a_2, \&c.$ are vertical.

The length of the extended leg being b_2, c_2 , *fig.* 262, at the end of the time *t*, $c_1, d_1 = b_2, d_2 = c_1, d_2$, the horizontal distance of the body in the time *t*, and $c_2, d_2 = c_1, b_2 + c_2, d_1 = h + s$, where *h* represents the distance of the centre of gravity from the beginning of the step, and *s* the height to which it is elevated in the time *t*; now, if b_2, d_2 be a right-angled triangle, then

$$(b_2, c_2)^2 = (b_2, d_2)^2 + (c_2, d_2)^2$$

or,

$$l^2 = c^2 t^2 + (h + s)^2$$

That is, the square of the length of the extended leg is equal to the sum of the squares of the

* The line c_2, d_2 is vertical, and c_1, d_1 horizontal, meeting c_2, d_2 in d_1 ; the letter *d* and line c_1, d_1 are omitted in the figure to prevent confusion.

path described by the centre of gravity in the time t , and the distance of the centre from the earth at the end of that time. The time occupied in running between the raising of the leg from the ground and the setting it down again is equal to the duration of the step, together with the portion of time during which the body swings in the air; or, it is the time in which c (fig. 262) advances from c_2 to c_5 , being the time between the raising of the left leg and the setting it down again, but this time is divided into two portions, namely, that whilst c

Fig. 262.

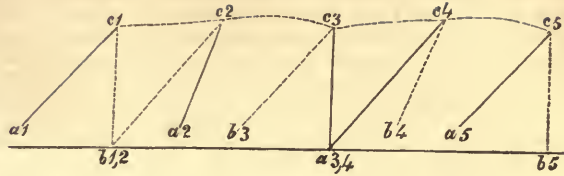

Fig. 263.

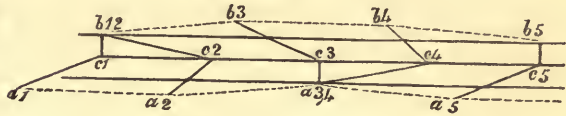
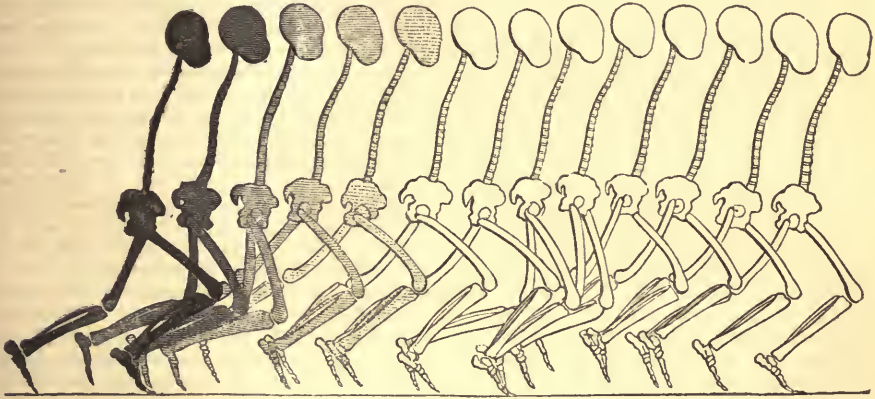

Fig. 264.



Figures designed by Weber, to illustrate the laws of running.

moves from c_2 to c_3 , and that whilst it moves from c_3 to c_5 ; the latter portion is the duration of the step; the former the time in which the body swings freely in the air.

From these principles it is obvious that no man in the act of running could possibly be in

Fig. 266.

Fig. 265.

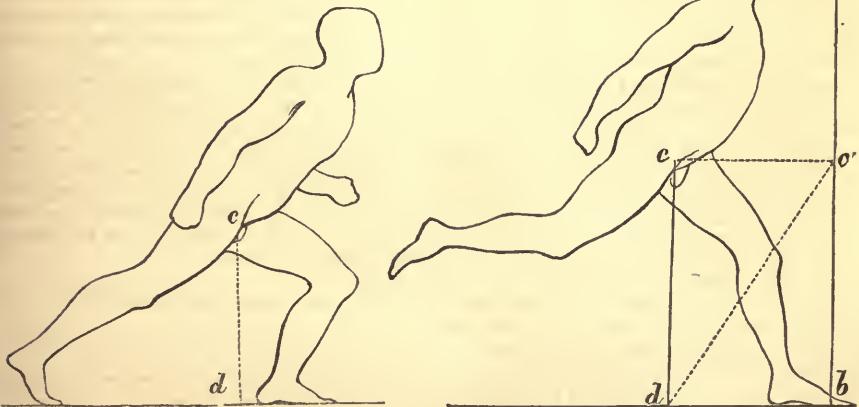

Preparing to run, and running, from designs by Flarman. In fig. 265 $c d$ falls behind the advanced foot, so that the posterior leg bears only a small portion of the weight of the body, but is in a position to push the centre of gravity forwards before quitting the ground.

the attitude of the annexed design by Flaxman (fig. 266), in which it will be seen that the whole mass of the body lies posterior to the vertical line *a c b*, passing through the base of support, whereas the preceding theory shews that in quick walking and running the swinging leg never passes beyond the vertical *d e*, which cuts the head of the femur. This figure has therefore been drawn upon false principles.

TABLE 12.

A Table of fifty-six experiments on running with various velocities. Space passed through 43.43 met. = 142.2504 feet.

Number of experiments.	Mean Number of Steps.	Time.	Duration of Step.	Length in metres.	Velocity.
6	28.17	7.56	0.268	1.542	5.753
3	38.83	9.91	0.293	1.284	4.382
6	35.92	10.80	0.301	1.209	4.016
7	38.17	11.99	0.314	1.138	3.624
3	42.67	13.60	0.319	1.018	3.194
7	46.5	15.173	0.326	0.934	2.865
6	53.	16.81	0.317	0.819	2.583
8	60.5	18.35	0.303	0.718	2.369
5	71.2	21.68	0.304	0.640	2.105
4	83.75	25.45	0.304	0.519	1.707
3	104.33	31.84	0.305	0.416	1.367
3	137.7	41.49	0.301	0.315	1.046

From this table we see that the length of step increases rapidly, whilst the duration varies but very little; and that the duration is always equal to a half oscillation of a pendulum.

Duration of spring .. = 0.2618 } difference
 Duration of half oscillation of pendulum } = 0.323 } 0.0612

Hence we perceive that the duration of the spring is less than the oscillation of the leg as a pendulum by a very small fraction only, which is probably due to muscular action.

In quick running the length of step rapidly increases, whilst the duration slowly diminishes; but in slow running the length diminishes rapidly, whilst the time remains nearly the same. The time of a step in quick running, compared to that in quick walking, is nearly as two to three, whilst the lengths of the steps are as two to one, consequently a person can run in a given time three times as fast as he can walk. The velocity in running is usually at the rate of about ten miles in an hour, but there are many persons who for a limited period can exceed this velocity.

In the human race, however, the velocity in running varies considerably, depending on a variety of physical conditions, such as age, sex, stature, muscular power, the nature of the surface on which the progression is performed, and the angle of elevation above, or depression below the plane of the horizon. Man is exceeded in speed by many of the lower animals, owing to differences in the structure of the

locomotive organs, and the physical laws which they obey.

Leaping or jumping.—This mode of progression is adopted by a great number of animals; some of which resort to it only for the accomplishment of a particular object, others as a regular means of locomotion.

In most of the orders of the animal kingdom there are some species which transfer themselves from place to place by a succession of impulses, in air, in water, and on solids: it is to the latter we shall confine our attention, having already briefly mentioned the former in the sections on flying and swimming.

In leaping, the object to be attained is to take the greatest length of step without reference to its duration; and herein it differs from running, in which the greatest steps are taken in the least possible time.

The height to which animals of different orders are capable of springing* varies, but, according to Straus-Durckheim, all those in the same order leap to equal elevations.

Amongst insects, the Grasshopper and Cricket, and in the order Felis, the Cat, the Leopard, and the Tiger, all rise to the same elevations above the positions of their respective centres of gravity at the instant when their feet quit the ground.

This appears at first to be inconsistent with the computations made on the proportion of the force of muscles to the mass of animals of different dimensions. If we select four different animals of the same order, in which the dimensions of one kind are as 1, 2, 3, 4, their weights will be as the cubes of these numbers, or, as 1, 8, 27, 64; but since the force of a muscle depends on the number of its fibres, and therefore increases in the ratio of its transverse section; that is, as the square of one of these dimensions, the muscular forces of the animals will be as 1, 4, 9, 16, and the velocities (supposing the muscles to act instantaneously) will be as the forces divided by the weights, or as 1, $\frac{1}{2}$, $\frac{1}{3}$, $\frac{1}{4}$, and the heights of the leaps being as the squares of the velocities would be as 1, $\frac{1}{4}$, $\frac{1}{9}$, $\frac{1}{16}$. Now, as they are all found to arrive at the same height, this may be explained by supposing that the muscles do not act instantaneously, but as constantly accelerating forces during the continuance of the spring. The force on an unit of mass in the Cat is to that on an unit in the Tiger, as 1 to $\frac{1}{4}$; and since the dimensions of the latter are four times those of the former, the tiger passes through four times the space the Cat passes over, reckoned from the beginning to the end of the time the muscles act, until the animal quits the ground, and therefore is elevated to the same height as the cat. †

From these principles we see the reason why

* The spring is that portion of the leap which takes place before the feet quit the ground.

† Thus:—Let *s* = the space passed through during the spring of the cat, *f* = the muscular force employed in the time *t* of a spring, then, by equation (3),

$$s = \frac{1}{2} f t^2.$$

Now, as the tiger passes through a space = 4*s*,

Fig. 267.

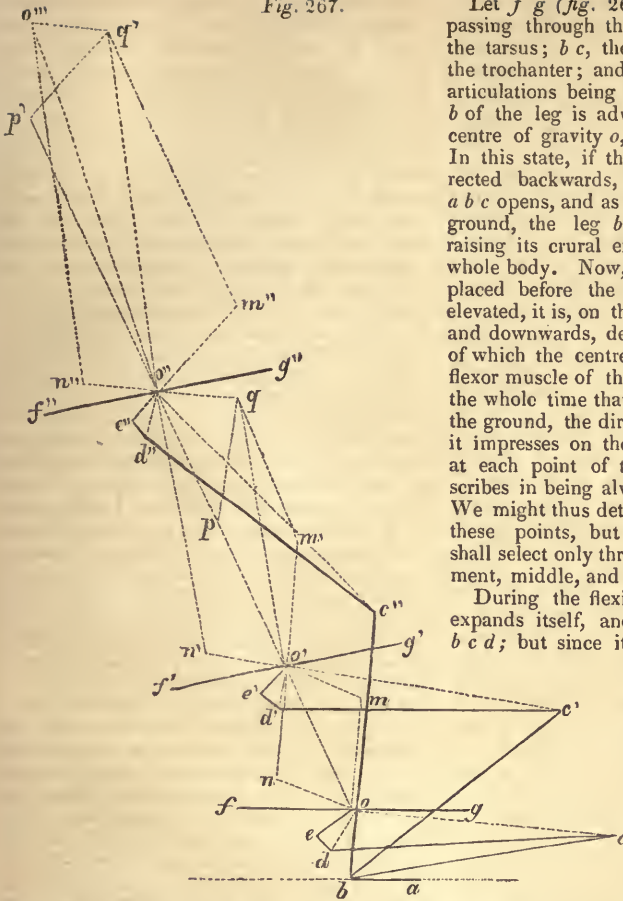

Let $f g$ (fig. 267) be the axis of the body, passing through the centre of gravity o ; $a b$, the tarsus; $b c$, the leg; $c d$, the thigh, with the trochanter; and $d e$, the hip. All these articulations being flexed, the tarsal extremity b of the leg is advanced forwards under the centre of gravity o , which is a little above it. In this state, if the tarsus $a b$, which is directed backwards, become flexed, the angle $a b c$ opens, and as the tarsus rests against the ground, the leg $b c$ begins to move, and raising its crural extremity, draws with it the whole body. Now, as the centre of gravity is placed before the point b , instead of being elevated, it is, on the contrary, urged forwards and downwards, describing an arc of a circle, of which the centre is b , and the action of the flexor muscle of the tarsus continuing during the whole time that the limb is resting against the ground, the direction of the motion which it impresses on the centre of gravity changes at each point of the arc which the latter describes in being always a tangent to this arc. We might thus determine its action for each of these points, but for greater simplicity we shall select only three; namely, the commencement, middle, and the end of the motion.

During the flexion of the tarsus, the leg expands itself, and tends to open the angle $b c d$; but since it rests with its tarsal extremity upon the plane of position, the thigh $c d$ becomes moveable, and is raised forwards, turning as a radius round its cruro-tibial articulation c , and carrying with it the whole body, in the same manner as in the motion of the leg; the direction of the force produced by the extensor muscle changes at each

many of the small insects leap a greater distance in proportion to their masses than the larger animals; for example, if the Flea, which can leap two hundred times its own height, were as large as the Cricket, it could only leap as far as it does at present; but the latter can leap much higher than the former, and therefore, of these two insects, the Cricket is the best organized for leaping. We shall now proceed to investigate the effect of the extension of the legs of insects in leaping.

and the muscular force equals $\frac{1}{4} f$, during the time t' of its spring,

$$\therefore 4s = \frac{1}{2} \frac{f}{4} t'^2 \dots\dots\dots (36)$$

and, $t' = 4t$. $\dots\dots\dots (37)$

The velocity of the cat will be,

$$v = \sqrt{2fs}$$

hence, that of the tiger is,

$$v' = \sqrt{2 \frac{f}{4} 4s} = \sqrt{2fs}$$

that is, the tiger and cat have the same velocity, and therefore the same height of spring, reckoned from the positions of their centres of gravity at the instant of their quitting the ground.

point of the curve which the centre of gravity describes; but this direction is always a tangent to the curve, and consequently perpendicular to the radius $c o$, passing through the cruro-tibial articulation and centre of gravity. The motion produced by the extensor muscle of the trochanter on the thigh $c d$, opens the angle $c d e$, tending to depress it at its tibial extremity, but as it rests upon the leg, which by its own elevation resists it, the motion is wholly communicated to the hip $d e$, which is flexed forward, and carries the body with it; the direction of the force of this muscle is perpendicular to the radius $d o$, passing through d , the articulation of the hip with the trochanter and the centre of gravity. Lastly, the motion produced by the extension of the hip $e d$ upon the body in a direction opposite to that of the thigh, is perpendicular to $e o$, and impresses on the centre of gravity an oblique impulse downwards and backwards. The forces resulting from the extension of the tarsus and the hip being very feeble, may be neglected.

The muscular force expended in these motions may be thus approximatively estimated. By the extension of the leg, the centre of gravity o will be acted on at the beginning of

motion by a force $o m$ perpendicular to $o c$; by the extension of the thigh at the same time the centre will be also urged by a force $o n$, perpendicular to the radius $o d$; the resultant of these two forces is $o o'$, in the direction of which the centre of gravity is raised in the first instant of motion, and the body and foot will be in the position $a, b, c', d', e', o', f', g'$. If the action of the muscles ceased after this first impulse, the body would arrive in the second instant at p , where $o' p = o o'$, but at the point o' the centre of gravity receives two new impulses, one $o' m'$ from the extensor of the leg, and another $o' n'$ by the extensor of the trochanter; the first is in a direction perpendicular to $o' c'$, the second perpendicular to $o' d'$, the former being combined with the motion $o' p$, which is that of the centre of gravity; in the second instant there arises a second resultant $o' q$, which the body would pass through in the second moment, if the action of the thigh did not take place, but this new force $o' n'$ being combined with $o' q$, produces the ultimate resultant $o'' o''$, which the centre of gravity really passes through in the second moment, and the body takes the position $a, b, c'', d'', e'', o'', f'', g''$. In the moment which follows, the centre of gravity would arrive by the second impulse at p' , a distance equal $o' o''$, but the forces of the muscles continuing to act, one of them $o'' m''$ produced by the extensor of the leg, and always perpendicular to $o'' c''$, gives with the motion $o'' p'$ a resultant $o'' q'$, which being combined in its turn with a force $o'' n''$ produced by the extensor of the trochanter in a direction perpendicular to $o'' d''$, gives a new ultimate resultant $o''' o'''$, which the centre of gravity passes through in the third instant. If the distance from the point o''' to the point b is greater than the length of the leg, it is evident that the body of the insect will be elevated during the third instant, and the muscles being no longer able to produce any new impulses, because the foot no longer furnishes them with points of support, the centre of gravity will in the succeeding intervals of time pass over spaces equal to $o'' o'''$.

In this demonstration we have only considered two forces as acting to produce the leap, but there are others which influence the motion of the body as above mentioned, the effect of which we must here notice. By the extension of the hip on the thigh, the body which we have supposed not moveable on the hip would be flexed forwards from its horizontal position; but this is corrected by the motion of the body on the hip and by that of the leg on the tarsus. The extensor muscle of the tarsus opens the angle $a b c$, and tends to lower the extremity a of the tarsus; but since that is supported the leg $b c$ is moved and flexed upwards, giving to the centre of gravity a motion forwards and downwards, perpendicularly to the radius $b o$. This new force being combined with $o o'$, produces in the first instant a resultant more inclined forwards than $o o'$. This oblique direction is afterwards corrected by the motion of the body on the hip. In short, if the body were only subject to the forces of the muscles of the tarsus, the leg, and

the thigh, it would take a direction more oblique than $f' g'$; but by the motion of the body on the hip, the centre of gravity receives a new impulse backwards and downwards perpendicular to $e o$, and this new force combined with $o' o''$ gives a resultant more vertical, and as it acts in an oblique direction downwards, it diminishes necessarily the velocity of the leap; but the body thereby regains its horizontal position. The other legs also contribute to the elevation of the body in leaping, but their action must be very feeble, because these limbs seldom present a greater size or force in leaping insects than in other species. The middle pair of legs being always directed outwards and backwards, urge the body upwards and forwards. The anterior pair, on the contrary, being placed greatly in advance of the centre of gravity, and directed opposite to the others, move it upwards and backwards; these limbs, however, being comparatively very feeble, can produce but little effect on the direction which the body would take were it only impelled by the two hinder pairs.

In almost all the perfect insects the legs are the instruments of leaping, but the Elater is capable of jumping whilst on its back, in order to recover its normal position, which owing to its figure it could not otherwise effect. For this purpose, a mechanism not generally found in other insects is provided; the *pro-sternum* is prolonged backwards, and terminates in a strong conical spine, which in a state of repose is lodged in a grooved cavity situated in the *meso-sternum*. The insect having been turned on its back, is observed to curve the body forcibly backwards; during this movement the spine of the sternum is drawn out of its sheath, and rests upon the edge of it, and the bases of the elytra are elevated above the plane of position. The flexor muscles, situated on the inferior aspect of the body, next contract, by which the spine is forcibly pressed against the edge of its sheath; the sternum is then suddenly relaxed, the spine darts into its sheath with great velocity, the head and thorax fly up, and the base of the elytra descends upon the supporting surface with such force that the insect by the reaction is propelled upwards to the height of one or two inches, during which the animal turns over upon its legs. In order to understand more clearly how this takes place, let $a b$ (fig. 268) be the axis of the body; o its centre of gravity; x the articu-

Fig. 268.

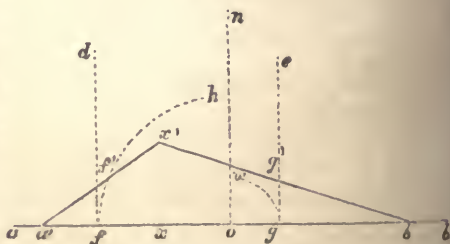

lation at which the trunk and thorax are flexed upon each other; f and g , the centres of force of the anterior and posterior parts of the body; when the body is curved preparatory to the leap, it takes the position $a'x'b'$, and the centre of gravity will be at o' ; when the body returns to its former position axb , the two centres of force come in contact with the ground in f and g ; the forces with which they strike the ground acting perpendicularly to ab , impart to the centre of gravity o a velocity in the same direction, but the reaction of the ground gives to the body two impulses equal and opposite to the forces df and eg ; the lines fd and ge not passing through the centre of gravity o , one part only of the force raises the body above the ground, the other part of the force produces a rotation of the body around the centre of gravity; the force ge being much nearer the centre than fd , and their velocity of rotation being in the direct ratio of their distances from the point o , the motion produced by ge , being opposite to that of fd , is destroyed by a part of the latter, and the remainder of fd will give the body a rotatory motion in the direction of $f'f'h$: by means of this motion the insect is enabled to reverse its position.* The larvæ of insects are variously organized; for example, that of the Tyrophaga casei, when preparing to leap, bends itself into a circle, bringing its head and tail in contact, and fixing its two mandibles in the cavities of its anal tubercles; it then contracts its body into an oblong figure, so that the two halves are parallel to each other. This being accomplished, it suddenly unlocks its head, and extends its body with such force, that the reaction of the surface on which it rests propels the body into the air to the distance of several inches. The leaping of fishes and serpents has been already mentioned in Section IV. Birds walk, run, and leap like Man. The Incessores and other short-legged Birds usually move on solids by a succession of leaps.

In most quadrupeds the propelling force of the leap is produced by the extension of the posterior extremities alone. When a considerable elevation of the body is the object to be attained, the centre of gravity is, previously to the leap, thrown back and lowered by the flexion of the hip, knee, and ankle-joints of the hind legs; the fore-legs are then raised from the ground by the extensor muscles of the trunk, the axis of which, before parallel to the horizon, is now inclined at a considerable angle to it. At this moment the extensor muscles of the posterior extremities are suddenly

contracted, and the leg is extended with sufficient velocity to elevate the trunk of the animal above the ground. At the end of the leap, the anterior feet first reach the ground simultaneously, and then the two hind feet in a similar manner; the head being brought between the two fore-legs, in order to throw the centre of gravity as far back as possible. The direction of the force of propulsion depends on the position of the propelling legs, and on the angle of inclination of the trunk to the plane of motion;—the intensity on the quantity of force impressed by the extension of the legs. In those quadrupeds which constantly move by a succession of leaps, the length of the posterior legs greatly exceeds that of the anterior; but in those wherein the length of the four legs is nearly equal, the leap is attended with so great an expenditure of muscular action that it is only resorted to on particular occasions.

Borelli* is of opinion that the power of leaping is greatest in those animals in which the extremities of the bones of the legs describe (in proportion to their masses) arcs of greatest circles, because they must move with greater velocity in the same time; in other words, that those animals which have the greatest relative length of the posterior legs leap to the greatest height. Nor does this militate against the analysis of Straus, according to which we have seen that animals of the same kind which have the greatest length of leg occupy a proportionably long time in springing.

In the Bull-frog amongst the Batrachia, in the Kangaroo amongst the Marsupialia, and in the Jerboa amongst the Rodentia, we find the greatest disproportion in the length of the anterior and posterior extremities; the length of the latter predominating so greatly, that they walk and trot with difficulty; but when pursued, the Jerboa can leap nine feet at each step, and repeat these leaps so rapidly, that it is said the Cossacks, though mounted on the fleetest horses, cannot overtake them. The Kangaroo reposes on the hind legs and tail, which form a triangular base, leaving the arms free for extension. Independently of the Jerboa, other Rodentia, such as the Hare and Rabbit, are also furnished with lengthened posterior extremities, by which they possess considerable power of springing. As the mass of animals increases in a greater ratio than the force of their muscular system, the large Proboscidiæ are almost incapable of leaping, but the solidungulous Pachydermata are well organized for leaping, as well as many of the Ruminantia, such as the Deer and Antelope. In these two orders the lengthened calcaneum and metatarsal bones contribute chiefly to assist the muscles in the spring. In the Carnivora, we find the ankle-joint possessing the same structure as in the Ruminantia and Pachydermata. The geometrical relation of their osseous and muscular systems is such as to confer on them great power in making a spring; that of the Tiger is well known. The leaping of the Cheiroptera and Quadrumana

* According to Kirby and Spence (loco cit. vol. ii. p. 314), the elater makes a double movement preparatory to the leap, by first drawing out the spine from its sheath, making it re-enter, and then causing it to fly out with a spring in the moment of leaping. This, however, appears to be a very incorrect view of what takes place. Mr. Darwin does not consider that sufficient stress has been laid on the elasticity of the spine, and that the sudden spring of the elater could not have resulted from muscular contraction alone, without some mechanical contrivance. (Journal of the Voyage of the Beagle, vol. iii. p. 35.)

* Quò longiores sunt vectes extremi crurum, saltus majores fiunt. See Part. prim. Prop. 176, p. 211.

has been briefly described in the last section, and our limits will not permit further illustrations. We shall therefore proceed to the investigation of the leap in the human race.

Fig. 269.



Preparing to leap with both legs, as designed by Flaxman.

In Man the leap is accomplished with considerable expenditure of muscular action, amounting, according to Borelli, to no less than 2900 times the weight of the body;* but since, notwithstanding the increased exertion, the velocity of this kind of motion is much less than in running, it is rarely adopted as a means of continued progression, but rather for passing over the greatest possible space without regard to the time taken to accomplish each step. In leaping, either both legs are employed simultaneously to project the body, as in *fig. 269*, or each leg is used alternately. Borelli has confined his observations to the former case; but as that mode of leaping merely consists of a

Fig. 270.

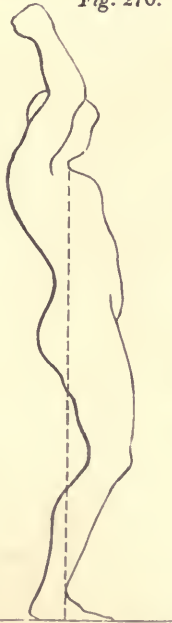

Position of the body at the termination of a leap with both legs.

* This estimate is calculated by Borelli in the same manner as the force of the muscles in Section I. On this, as on several other occasions, Barthez has chosen to deny without attempting to disprove the conclusion of Borelli. (See Barthez, *Nouv. Mecan.* p. 97.)

succession of isolated movements, there being always a pause between each two, we shall investigate the latter case as the only one which admits of a continued uniform progression, the only one, therefore, which is properly within the scope of the present article.*

In the alternate movement of the legs, the swinging leg is not placed on the ground as soon as it has reached the vertical position, as in quickest walking and running, but it is suffered to swing beyond it, and the placing it on the ground is delayed until it comes a second time to the vertical position, consequently the body swings freely in the air for a longer period than in running, whereby a longer step is effected.

Fig. 271 represents the various positions of the centre of gravity and of each leg in successive instants of time: *a* is the right foot, *b* the left, and *c* the centre of gravity. $a_1, 2, 3$ signifies that while *c* moves from c_1 to c_2 and c_3 , and *b* from b_1 to b_2 and b_3 , *a* remains at the point $a_1, 2, 3$. The spaces $a_1, 2, 3, b_4, 5, 6 = c_2, c_5 = \&c.$ the lengths of the steps. It will be observed that whilst the body is advancing from c_1 to c_3 , it is supported and projected by the right leg. From c_3 to c_4 both legs are off the ground, from c_4 to c_6 the body is supported and projected by the left leg, and from c_6 to c_7 both legs are again off the ground, and so on successively.

TABLE 13.

Table shewing the length and duration of the steps in leaping with various velocities.

Length of steps.	Duration.	Velocity.
1.243	0.460	2.702
1.578	0.468	3.372
1.688	0.455	3.710
1.809	0.411	4.402
1.977	0.404	4.894

* In leaping, the equations (29) (32) (34) are the same as in running. Equations (30) and (35) are omitted, for $\theta = 0$, since the centre of gravity of the body does not sink, because at the beginning of each step the leg is bent, and there is, therefore, no depression, as is necessarily the case in walking and running. Instead of equations (31) and (33), we have,

$$2\tau = T + \beta + \left(1 + \frac{1}{\cos \frac{\pi}{T}\beta}\right) t \dots (38)$$

$$h = \frac{(\mu + 1) g t^2 \left(1 - \frac{2s}{3h}\right)}{r(2 - r)} \dots (39)$$

The condition for regular progression in leaping, as in walking and running, is that the vital force communicated by the supporting leg to the trunk, equals that communicated by the trunk to the swinging leg. In the present case the latter force is,

$$m' c^2 r (2 - r) \dots (40)$$

and the former is the same as in running.

By table 13 we find that the duration of the step in leaping is less than in slow walking,* but greater than in running;† the length of step is much greater than in walking, and may be made greater than in quickest running. As the body swings freely in the air a longer period, and rises to a greater elevation in leaping than in running and walking, it is necessary that the projectile force should be made greater, but the time during which the extensor power of the leg acts, although very short, is of intense action;

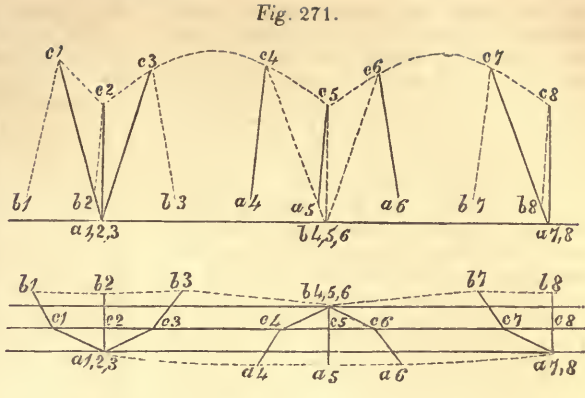
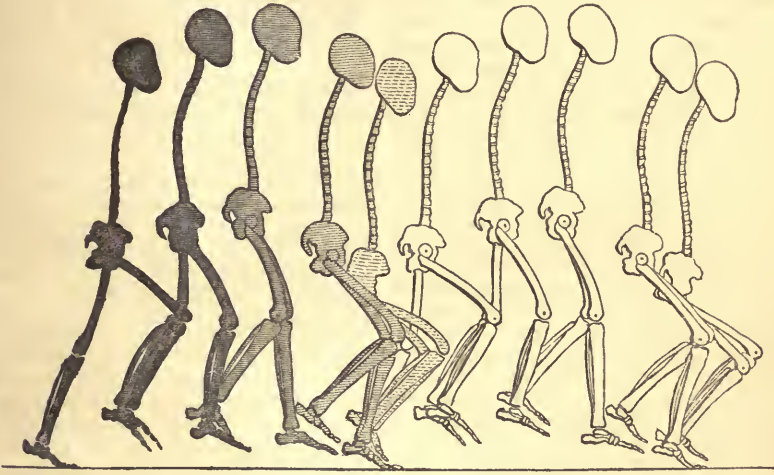

Fig. 272.



Figures designed by Weber to illustrate the formulas for leaping.

hence, it is not easy to regulate the amount of muscular action as in walking and running, and consequently it may be too great or too little for the object in view. The vertical undulations also are much more considerable than in the other modes of locomotion.

In descending rapidly the sides of steep hills it is much safer to do so by leaping than by running, as in the former mode of progression the foot is placed on the ground at the end of each step in a position favourable for stopping, which cannot be done in the latter. MM. Weber consider that the study of the laws which regulate the locomotion of man, and of the mechanism by which it is accomplished, will assist mankind in the construction of automatic locomotive machines. Mr. G. Rennie has studied the construction of animals and the principles on which they move with a view of applying them to the locomotion of the steamboat, on the supposition that animals move in air, in water, with the least expenditure of muscular force, an hypothesis which accords with

our views as well as those of M. Dumas, who considers that man is capable of moving and producing a greater mechanical effect, with less expenditure of fuel, than can be produced by any steam-engine hitherto invented.

In every mode of progression there is a sensible increase of action in the circulating and respiratory systems; but the effect produced on them is much greater in running and leaping than in walking. In the two former cases a violent palpitation of the heart and hurried respiratory movements are quickly produced, on which account they cannot be very long continued. In running, when four steps are taken in a second, the difficulty of breathing soon causes the pedestrian either to slacken his pace, or what may be most advantageously substituted when it is desirable to continue nearly the same speed, and at the same time preserve the breath, to exchange the running for a leaping movement. In consequence of the deliberate manner in which the steps may be taken in leaping, the breath may be preserved for a longer period, and the action of the heart diminished;

* See Table 8.

† See Table 12.

and as the lengths of the steps are greater in leaping than in running, the velocity is not very sensibly diminished, although the duration of each step is increased; that is, for example, when we substitute three leaping, instead of four running, steps in a second. In Table 12 we find that the greatest length of step in running is 1^m.542, and in Table 13 that the greatest length of step in leaping is 1^m.977, consequently four of the former exceed three in the latter mode of progression in a second by 0^m.237, or 0.76736 feet only; but this loss of space is compensated by the greater time the pedestrian employs in taking each step in leaping, being = 0".136.

MM. Weber consider that leaping stands in the same relation to running that the grave step in slow walking does to quick walking. The difference of the grave and quick step in walking consists in this, that in the former the oscillation of the leg has nearly completed its curve of vibration before it is placed on the ground, and therefore forms a greater angle with the vertical than the hind leg. The same difference also exists between running and leaping, independently of which there is another important variation, which is that in leaping the swinging leg completes its entire arc of vibration before it is placed on the ground, and makes the greatest angle with the vertical it can possibly effect. In running, on the contrary, the leg is set perpendicularly on the ground and consequently the angle with the vertical = ϕ . In the grave step as well as in leaping the foot is brought into contact with the ground preparatory to resting upon it; and, lastly, the duration of the leaping step exceeds that of the running step in the same degree that the duration of the grave step exceeds that of the quick step. These are the principal differences which distinguish the four modes of locomotion most usually adopted by man.

The study of the mechanism of which the locomotive organs of animals is composed, of the laws by which their progression is accomplished, and of the vital force which they expend in propelling the body from one point in space to another with different velocities, serves to instruct alike the anatomist and the physiologist, the artist and the mechanic. Ignorance of these laws has been productive of grotesque delineations of the human figure as well as of the lower animals when represented in motion. We have abundant evidence of this in the productions of painters and sculptors, both of the ancient and modern schools. Locomotion is not only a function indispensably necessary for the prolongation of the lives of a vast assemblage of animals, but it is also applicable as a force to innumerable purposes in life. On account of the importance of this subject, we shall in conclusion briefly investigate the manner in which animal force is estimated, and under what circumstances it may be employed to the greatest advantage. Thus, let ϕ denote the whole force of an animal when at rest, and let us suppose it to be incapable of any effort when it is moving with the velocity V ; let F be the effective force when its velocity is V' ; then, if the action of the force be uniform,

(which from the principles assigned we may consider to be the case,) since it is the difference only between the velocities V and V' that is efficient, the effective force will vary as the square of the efficient velocity, that is

$$\phi : F :: (V - \phi)^2 : (V - V')^2$$

$$\text{hence } F = \phi \left(\frac{V - V'}{V} \right)^2 = \phi \left(1 - \frac{V'}{V} \right)^2 *$$

$$\text{and } V = \frac{V' \sqrt{\phi}}{\sqrt{\phi} - \sqrt{F}} \dots \dots \dots (41)$$

or, the utmost velocity with which any animal not impeded moves, is to its velocity when impeded by a given resistance, as the square root of its absolute force to the difference of the square roots of its absolute and effective forces. Let us now investigate the velocity with which an animal must move and what must be its load, that the work performed by it may be a maximum. Retaining the same notation, let $V - V' = u$; then since $F = \phi \frac{(V - V')^2}{V}$

the product of the moving force into its velocity, or the momentum of impulse FV' , will = $\phi \frac{u^2}{V^2} (V - u)$, and making this a maximum, we find $u = \frac{2}{3}V$, and $V' = \frac{1}{3}V$. Therefore the effective work of an animal is a maximum when it is so loaded, that with its whole force in action its velocity amounts to one-third of the greatest velocity which it is capable of exerting without any load at all. In a series of experiments made on men and horses, by drawing a lighter along a canal, and working several days consecutively, the force was measured by the curvature and weight of a track rope, as well as by a spring steel-yard; and the product of this force multiplied by the velocity per hour was considered as the momentum. By these experiments the forces of men were found very nearly as $(V - V')^2$, and those of horses, loaded so as not to be able to trot, as $(V - V')^{1.7}$ to $(V - V')^{1.8}$, results which agree very closely with the theory. In the application of these formulæ let us suppose a man's power to be 70 pounds, and his utmost speed in walking to be six feet per second, hence ϕ will equal 70, and V equal 6, therefore $F = \frac{2}{3}\phi = 31\frac{1}{3}$, which is the greatest force a man can exert in walking, and he will move at the rate of $\frac{1}{3}V = 2$ feet in a second.† The strength of a horse may be easily computed in a similar manner—it is generally reckoned to be six times that of man, or about 420 pounds at a dead pull—then its

* This is a formula of Euler's, who has given another expression $\phi \left(1 - \frac{V'}{V} \right)^2$: by this

formula the greatest mechanical effect is when $V' = \frac{1}{2}V$, but it does not agree with the experiments of Schulze and others as near as the one in the text. See Schulze on the Strength of Men and Horses, Acad. Berl. 1753.

† According to Buchanan, the force expended in pumping is 1742, by a winch 2856, in ringing 3883, and in rowing 4095.—Buchanan on human labour, Rept. 15, 319.

velocity being about 10 feet per second, its maximum action will be $\frac{1}{3}$ (420) = 185 $\frac{1}{3}$, and it will move at the rate of $\frac{1}{9}$ or $\frac{1}{3}$ rd feet per second, being about 2 $\frac{2}{3}$ miles per hour. With the help of these formulae the maximum forces of any other animals may be found.

BIBLIOGRAPHY.—*Aristotle*, On the progressive motion of animals, by Taylor. *Fabricius ab Aquapendente*, De motu locali animalium, Opera ed. Bohnii, Lipsiæ, 1687, p. 332. *Gassendi*, De vi motrice et motionibus animalium, Opera, tom. ii. lib. xi. Florentiæ. *Borelli*, De motu animalium, 4to. Lugduni, 1685. *Haller*, Elementa physiologiæ, tom. iv. lib. xi. sect. iv. *Barthez*, Nouvelle mécanique des mouvemens de l'homme et des animaux, 4to. Par. 1798. *Magendie*, Précis élément. de physiol. tome i. *Roulin*, Recherches sur le mécanisme des attitudes et des mouvemens de l'homme, in Magendie's Journal, tom. i. ii. 1821-2. *Gerdy*, Sur le mécanisme de la marche de l'homme, Magendie's Journ. tom. ix, and Physiol. médicale didactique et critique, par P. N. Gerdy, Paris, 1833, tome i. partie 2. *Krause*, Handb. der menschl. Anat. Bd. 1. *Poisson*, Traité de mécanique, Paris, 1833, tome ii. *Weber*, W. and E., Mechanik der menschl. Gehewerkzeuge, Gott. 1836. *Kirby and Spence*, Introduction to entomology, 8vo. *Müller*, Elements of Physiology by Baly. *Roget*, Bridge-water Treatise. *Paley*, Natural theology, with notes by Brougham and Bell *Gregory*, O., Treatise of mechanics. *Chabrier*, Mémoire de l'Acad. tom. ii. — Sur le vol des Insectes, et observations sur quelques parties de la mécanique des mouvemens progressifs de l'homme et des animaux vertébrés, 4to. Paris, 1823. *Straus Dürkheim*, Considérations générales sur l'anatomie comparée des animaux articulés, 4to. Paris, 1828. *Cuvier*, Règne Animal. *Perrault*, Mécanique des animaux. *Parent*, On animal mechanics, A. P. 1702. *Martian*, On the position of the legs in walking, A. P. 1721. *Bourgelat*, On the motions of the Horse. *Bernoulli*, J. De motu musculorum, Lond. 4to. 1708. *Emerson's* Principles of mechanics, Lond. 4to. 1800. *Pinel*, On animal mechanics, Roz. xxxi. 350, xxxiii. 12, xxxv. 457. *Mayow*, J. De motu musculari et spiritibus animalibus.

(John Bishop.)

MUCUS (from $\mu\upsilon\zeta\alpha$, the secretion of the Schneiderian membrane). This word has been used in so very indefinite a sense by the members of the medical profession, that animal chemists have had great difficulty in fixing on any distinctive characters by which the substance might be identified. The great source of confusion appears to have been that physiologists and the profession generally have applied the adjective mucous or mucoid to certain forms of secreted matter; from which circumstance the term mucus has gradually advanced into substantive use as a medico-chemical word, embracing in its meaning the secretions from the mouth, nose, intestines, &c. as though these were identical in their chemical characters. We shall presently show, however, that such is not the case.

In the Philosophical Transactions for 1800 Mr. Hatchett published a paper, in which he endeavoured to show that such a principle as mucus really existed, characterised by peculiar properties; but considered it a modified form of gelatin. Dr. Bostock subsequently published a paper in Nicholson's Journal, in which he showed that mucus differed from gelatin; this he proved by demonstrating that

tanning did not precipitate mucus, though gelatin was immediately thrown down by it, whereas diacetate of lead precipitated mucus copiously, without affecting gelatin: bichloride of mercury and ferrocyanuret of potassa did not precipitate either mucus or gelatin. I shall show hereafter that these last-mentioned reactions do not apply to every form of mucus: the ingenious experiments of Dr. Bostock can indeed no longer be considered pertinent, inasmuch as the researches of modern chemists have gone far to prove that gelatin is rather a product than an educt of animal analysis. The experiments of Dr. Bostock were made on the saliva of the mouth, and some subsequent observations by Mr. Brande made on the same secretion showed that the precipitates obtained by the diacetate of lead and nitrate of silver consisted of the chlorides and phosphates of those metals; a fact which inclined Mr. Brande to consider mucus as a compound substance rather than a proximate element, and induced him to apply electricity as a means of decomposition. From the results obtained in this inquiry, Mr. Brande was inclined to consider mucus as a compound of albumen either with pure soda or chloride of sodium.

Dr. Marcet made some experiments on mucus which induced him to believe that several morbid secretions contained it as a constituent; he considered it to be present in dropsical effusions. Berzelius, though he allows the secretions of the mucous membranes to differ in chemical character, and to possess distinct properties according to the especial office they have to fulfil in lubricating particular parts, still believes that such a proximate element as mucus really exists as one of the constituents of such secretions, and notices it in his analysis of mucus of the nose. In considering this subject it is, therefore, necessary to premise that the general term, as used by the medical profession, has no relation whatever to the chemistry of the question, the secretions of the different mucous membranes varying greatly in chemical composition, but, notwithstanding, presenting a physical character in common, in relation to which the term mucus has been applied to them. The inquiry of greatest interest consists in determining whether there exists a peculiar proximate element in virtue of which the mucous character is developed, or whether, on the other hand, the peculiar physical character can be traced to the presence of some combination of albumen which is common to all mucous secretions, notwithstanding that they may differ greatly in other respects. We have already seen that the latter opinion is supported by Mr. Brande's experiments, while Berzelius, on the contrary, seems to favour the former view of the case. Before entering upon this question I shall describe the chemical characters of several secretions from mucous surfaces, as the reader will then be better prepared for the inquiry. I shall commence with the secretion from the nose, since this may be regarded as the type of those viscous products to which the general name of mucus has been applied.

The secretion of the Schneiderian membrane, according to the analysis of Berzelius, is composed as follows:—

Mucus	5.33
Alcoholic extractive and alkaline lactate ..	0.30
Chlorides of potassium and sodium ..	0.56
Aqueous extractive, traces of albumen, and a phosphate	0.35
Soda, combined with the mucus	0.09
Water	93.37
	<hr/>
	100.00
	<hr/>

The chemical characters of the substance which Berzelius notices in this analysis as "mucus" are as follows. It is not soluble in water, but swells up and becomes transparent. When dried it is again capable of being swelled by water; but after this experiment has been repeated several times it becomes of a yellow colour, and assumes somewhat the appearance of pus. When boiled in water it neither hardens nor contracts; but after this treatment it is found, to a certain extent, to have lost its property of swelling. When dry it is of a yellow colour and transparent. By distillation it yields carbonate of ammonia and empyreumatic animal oil. The ashes obtained from this substance yield phosphate and carbonate of lime, with traces of carbonate of soda. This mucus is soluble in weak sulphuric acid; the strong acid darkens its colour and eventually destroys its texture. Weak nitric acid coagulates it superficially and renders it partially yellow: long digestion in this acid causes its solution. Acetic acid contracts it, but does not dissolve it even when assisted by heat. It dissolves from it, however, a portion of albumen, which renders the solution precipitable by the ferrocyanuret of potassium. Caustic potash renders this mucus more tenacious, but by digestion it dissolves it. Infusion of galls coagulates it when dissolved in acids or when swelled by water. These characters described by Berzelius may be received as the general properties of that substance to which mucous secretions owe their viscous character.

Urinary mucus.—This form of mucus is best obtained by allowing recently voided urine to remain at rest in a tall glass vessel, when the mucus will subside after some hours, and may be collected by pouring off the supernatant fluid as nearly as possible without disturbing the precipitate, and throwing the remaining part of the secretion on a filter; the mucus will now be retained on the paper. Its properties are as follows:—when dried on paper it exhibits a bright surface; on being moistened, however, it rapidly assumes its original appearance. It is insoluble in sulphuric acid, but the nitric and acetic acids dissolve it in large proportion, and the solution is precipitable by ferrocyanuret of potassa: caustic potassa in solution dissolves it entirely.

Salivary mucus.—The saliva, as it passes from the mouth, contains, in all probability, two kinds of mucus; one derived from the mucous membrane lining the mouth, and the

other from the internal membrane of the salivary ducts. When saliva is allowed to stand it very soon separates into two parts; one a supernatant liquor of a slightly milky hue, and the other a deposit of a white colour, which in this state does not exhibit the ordinary physical characteristics of mucus. On pouring off the liquor, however, and then agitating the deposit with water, it immediately assumes the glairy character; indeed, without the addition of water it will exhibit a mucoid tenacity if an attempt be made to raise it from the vessel in which it has collected. The liquor which has been poured off from this dense form of the principle still contains a portion of mucus in suspension, which may be obtained by dilution with water, and may probably be a less coherent form of mucus secreted by the lining membrane of the salivary ducts. These two forms of mucus have much the same chemical characters, being insoluble in water and coagulable, and rendered firmer, by the acetic, hydrochloric, and sulphuric acids. The liquors obtained by digesting these acids on mucus are not precipitable by the addition of alkalis, which shows that this form of the secretion does not contain any free subphosphate of lime. It is dissolved by caustic alkalis and precipitable by the acids when thus dissolved: the solution in alkalis, however, is not complete, a residue being always obtained, which is soluble in acid, but which cannot be precipitated from the acid solution by means of caustic alkali, and, therefore, is not an earthy salt. Notwithstanding this, however, we can always obtain evidence of the existence of phosphate of lime in considerable proportion by incinerating mucus; and Berzelius considers the tartar formed on the teeth to be derived from this source. This form of mucus is considered by Berzelius to approach very nearly to that obtained from the stomach and intestines: it differs greatly from nasal mucus, which is soluble in the sulphuric and nitric acids.

Intestinal mucus.—The mucus of the stomach and intestines can be best obtained by washing the mucous surfaces of those organs taken from an animal that has fasted some hours: it is occasionally observed adhering to excrement. This mucus, when dried, is no longer capable of assuming the tenacious character on being moistened with water, but, according to an observation of Berzelius, requires an alkaline solution for that purpose: it is coagulable by the acids. The acetic acid acts powerfully upon it, solidifying it completely. None of the acids dissolve it; the acetic acid seems, however, to have a partial action, since the liquor obtained by digesting it is precipitable by the addition of infusion of galls, but not always by the ferrocyanuret of potassa. The caustic alkalis dissolve this mucus, and the addition of acids precipitates it when thus brought into solution.

Mucus of the gall-bladder has been examined, and appears to resemble that last described; it is insoluble in the acids and precipitable by them from solution in alkalis.

From the descriptions which I have now given I think it will be obtained that, inasmuch as the mucus which is obtained by the chemical analysis of different secretions fails to show, when subjected to tests, those agreements in reaction which must be regarded as essential to prove identity, the question as to the existence of any substance to which the name of "mucus" should be applied, as one of the proximate elementary animal bodies, should be regarded as concluded. That there is always a matter present in the secretions of mucous membranes, which possesses a glutinous character, and to which the physical properties of the secretion are owing, is undoubtedly true; but this is quite a distinct question from whether or not this tenacious constituent be entitled to the rank of a proximate element: and the fact of a difference being observed in the chemical reactions of this body, as obtained from various secretions, strongly opposes such an idea. In order to examine into this question I made, some time ago, at the suggestion of Dr. Bright, some chemical observations on those effused fluids which partake more or less of the mucous

character,* such as the effusions which occur in ovarian dropsy, and to compare the results obtained with similarly conducted experiments on other fluids of a more purely serous character, and also with serum of blood, as it appeared probable that some point of difference might be detected to which the mucoid character could be traced, notwithstanding the total absence of any substance obtainable in a solid form and exhibiting physical characters like those of mucus. I I subjoin the examination of five fluids effused in ovarian tumours, and one of a purely serous character drawn from a case of ascites; the serum of blood is also offered for comparison; the separation of these fluids being carried only so far as the division into free albumen, aqueous extractive, and alcoholic extractive. These analyses were made on equal weights, or nearly so, of solid matters, obtained by evaporating each fluid, as previous observation had convinced me that the viscous character into the nature of which I was examining was quite independent of the degree of concentration of the effusions, the most tenacious generally possessing the lowest specific gravity.

	Ovarian effusions.					Fluid of Ascites.	Serum of Blood.
	No. 1.	No. 2.	No. 3.	No. 4.	No. 5.		
Albumen.....	4.50	4.57	3.75	6.17	1.15	6.02	3.77
Aqueous extractive.....	4.94	4.73	4.79	3.25	7.05	1.43	0.35
Alcoholic extractive.....	0.54	0.70	1.45	.57	1.79	2.11	0.87

These analyses at once showed that the aqueous extractive existed in greater proportion in the tenacious fluids of ovarian cysts than in the more serous effusion of ascites and the serum of blood; but another difficulty remained to be solved, which was, that some of these viscous liquors which were less mucoid in character than others, did not indicate the cause of such difference when the examination had been extended only to the separation into the three parts above mentioned, viz. albumen, aqueous extractive, and alcoholic extractive. On incinerating the aqueous extractive, however, so as to ascertain the proportion of animal matter and alkaline salts contained in it, I discovered that, while those specimens which showed the mucoid character in a more marked degree contained salts and animal matter in nearly equal proportions in their aqueous extractive, those in which the mucoid character did not greatly predominate either showed a deficiency or excess of salts; both conditions appearing more or less to interfere with the perfect development of the peculiar tenacious character of the secretion. I have now to notice the late ingenious and valuable observations of Dr. Babington, who has done more to assist this inquiry than any observer who has as yet examined into the subject. In a paper published in the fifth number of the Guy's Hospital Reports, Dr. Babington described some experiments showing that various albuminous matters were capable of assuming the mucous character by mixture with the alkalies. Serum of blood, pus, milk, and white of egg were all so affected; and the

glairy mass so obtained was insoluble in water, precipitable by diacetate of lead, but not by bichloride of mercury or infusion of galls. It admitted of being washed with water till all traces of alkalinity were removed, but it still retained its mucous character. This synthetic formation of mucus is a most important fact; and I see no reason whatever to doubt that the artificially formed viscous mass differs from that secreted by membrane. It is true that the latter always contains microscopic globules, which of course are wanting in the artificial product; but these globules are, I believe, in no way connected with the viscous character of mucus, but are rather superadded to it, and frequently in very small proportion to the mass of the secretion.

The experiment of Hunter, who consolidated albumen by the addition of hydrochlorate of ammonia, as also the observations of Dr. Pearson on the action of some others of the neutral salts on pus, are confirmed by Dr. Babington in the paper to which I have alluded. The microscopic history of mucus, or rather of those organic globules which accompany the secretion, is a matter of considerable interest: before entering upon it, however, I wish to state my reasons why these globules are not, according to my belief, the cause of the viscous character of mucus. In the first place we do not observe them in sufficient numbers to authorize such an opinion; and, secondly, some of the most viscous forms of the secretion do not become corrugated to any perceptible

* See Guy's Hospital Reports, April 1833.
2 1 2

degree by the addition of concentrated saline solutions, whereas, by some experiments lately made with my friend Mr. Lane, I have been satisfied that the mucus globules are so affected, and may easily be observed, under a powerful microscope, to expand or contract according as water, or strong solutions are mixed with them. The mucus globule admits, in fact, of the exudation or imbibition of fluids according to the laws of endosmose and exosmose, and were the greater part of a mass of mucus composed of these globules, we should observe it to corrugate in concentrated solutions; but such is not the case, as I have before stated, with many of the most viscous forms of mucus, while the mucus of the bladder, on the contrary, which (except in severe diseases) is one of the least coherent forms, shows a tendency to contract under such circumstances, and on microscopic examination proves to contain globules in large number in proportion to its mass. This reaction, I think, renders it very probable that the view I have mentioned is the correct one. Most forms of mucus swell when moistened by water or weak solutions; but this is no proof of action on organic globules unless the opposite experiment (contraction by strong solutions) can be successfully performed. The mucus globule varies greatly, as seen in different secretions; so much so that any one who has examined this subject microscopically must be familiar with a form of globule peculiar to each secretion. I shall first describe the globule generally, and then proceed to notice its varieties in appearance. The mucus globule is nearly transparent, and larger than the blood globule. As it exists in the saliva and urine it is of a very regularly circular form, with a well defined margin and a somewhat granular surface. In the more adhesive forms of expectoration, however, it loses this well defined and rounded form, and its translucence is impaired; the granular surface can always, however, be seen. In a portion of mucus taken from the back of the throat I lately had an opportunity of examining this last mentioned condition, and took occasion to examine whether or not it depended on a partially empty condition of the globule, which could be remedied by the addition of water. I found, by careful treatment, in this way under the microscope, that the bodies gradually assumed a more rounded form, and eventually exhibited an appearance almost identical with the more transparent globules observed in the saliva and urine. By subsequently adding a concentrated solution of sugar to them, however, the original appearance was speedily reinduced, owing to the endosmotic action of the sirop. This experiment has led me to a belief that the cause of difference in the microscopic appearance of the mucus globule, as seen in different secretions, is attributable rather to the circumstances under which it is placed than to any difference in organization.

It would appear, from the facts collected up to the present moment on this subject, that we are justified in considering, 1st, that mucus

is a compound of albumen in a state of close combination with alkaline salts, and probably free alkali; 2nd, that the artificial compound formed by the addition of alkalies and neutral salts to albuminous matter is essentially the same as mucus; 3rd, that the mucus globule is superadded to the viscous matter in the secretions of mucous membranes, and is in no way concerned in imparting the peculiar tenacious character to such fluids.

A great deal of trouble has been taken to devise chemical means of distinguishing between pus and mucus, or to detect the presence of the former when existing combined in small proportion with the latter. No chemical method of inquiry can ever be applicable to this question: the microscope must be had recourse to for the detection of the pus globule, if the mucus be suspected to contain it in quantity so small as to escape casual examination. When pus is present, however, even in very small proportion to the mucus, its physical characters are so distinct that no chemical or microscopical tests can possibly be required. Considered as a means of proof, the folly of using chemical tests is at once apparent when we recollect that the question as regards pus is entirely one of structure, and we cannot in reason use chemical tests to determine the presence or absence of a globule. When pus exists as a deposit in urine, we may easily distinguish it from the phosphates with which it is sometimes confounded by adding an alkali, as recommended by Dr. Babington, in which case the deposit (which must be previously separated by decantation from the urine) assumes the glairy character of mucus, and thus shows its albuminous nature. As affording us a distinctive test, therefore, between these two substances, chemistry becomes useful; but inasmuch as the addition of alkali to most forms of albuminous matter develops a mucous tenacity, the re-agent cannot correctly be called a test for pus. We become assured of the presence of pus by this reaction only, because previous experiment has shown that the phosphates and pus are the only two substances assuming a peculiar and similar appearance in the urine.

(G. Owen Rees.)

MUCOUS MEMBRANE.—This term has been usually and properly restricted to those large expansions of membrane, in the interior of the body, which are continuous with the external tegument: but it is impossible, in the present state of knowledge, to treat of these apart from the true glands and the skin, which form with them a great system, to which the generic term *mucous* will be applied in this article.

Many anatomists since the time of Bonn* have treated of the mucous membranes and skin under the common title of tegumentary membranes; and the opinion has been gradu-

* Bonn, Specimen Anatomico-Medicum Inaug. &c. de continuationibus membranarum, &c. in Sandiforti Thesauro, tom. ii. p. 265. Roterod. 1769.

ally gaining ground, that all the glands furnished with excretory ducts have a very close relation to the former, in which their ducts for the most part open. Still, it does not appear that the proofs of this alliance have been hitherto, by any author, deemed sufficient to induce him to blend these several parts under a description common to them all. Even Müller, in whose philosophical work on the glands is contained so much new and important evidence of this relation, continues thus to sever them in the late edition of his *Physiology*. But, indeed, although much weight is to be granted to the arguments drawn from continuity and occasional convertibility of structure, course of development, rough analogies of composition or of function, and sympathies under disease, it must be allowed that hitherto that most important of all proofs has been all but wanting, which, as I shall endeavour to show, is capable of being derived from minute anatomical analysis.

The researches which I have hitherto been able to make on this subject are still so incomplete, that I should have gladly delayed their publication for some time longer, had the progress of this work admitted of it. As it is, I shall state the conclusions to which I have been led, and the grounds they rest upon, (pointing out, as far as possible, where farther examination is demanded,) with the hope of thereby giving a clearer and more satisfactory view of the structure and relations of this important class of tissues than could be otherwise accomplished.

I shall point out that the skin, mucous membranes, and secreting glands, consist of certain elements, which the anatomist may detect and discriminate, some of which are essential to their tissue, others appended or superadded,—and that the broad characteristic distinctions between these structures, appreciable to ordinary sense, as well as the innumerable gradations by which they every where blend insensibly with one another, are solely due to various degrees and kinds of modifications wrought in the form, quantity, and properties of these respective elementary parts.

The skin is the outer tegument of the body; the mucous membranes form its internal investment, and are continuous with the skin. The ducts of all glands are continuous either with skin or mucous membrane, and their true secreting portion, as already described, (see *GLAND*.) is merely a further prolongation of the same tissue. These offsets, like the great mucous tracts, are in the direction of the interior of the body; they form follicles and tubes of infinite variety, and, however complicated, may still be regarded, in a certain sense, as external to all other textures. Thus the mucous system may be described as a great and uninterrupted membrane, every where perfectly closed, in which the rest of the animal, or the *parenchyma*, is enclosed. This membrane has two surfaces, the one free, superficial or external, the other attached, deep, or parenchymal. It is on the parenchymal surface that the appended structures (viz. blood- and lymphatic

vessels, nerves, and areolar tissue) are found in more or less profusion.

The functions of the mucous system, numerous and diversified as they are, all bear a distinct reference to its really external anatomical position, and by this circumstance they are associated together: the principal are sensation, absorption, secretion, excretion, and defence of the parts lined by it against the contact of foreign bodies.

A glance at the opinions that have prevailed concerning the structure and relations of the mucous membranes, will exemplify, more clearly perhaps than any other course, how imperfect have been the means employed, until a very recent period, in researches into minute or structural anatomy. The distribution of their bloodvessels had indeed been studied with brilliant success by Ruysch, Lieberkühn, and others, by the aid of injections, the admirable delicacy of which no modern art has surpassed; and somewhat of their extensive connexions, general properties, and even of their texture, had been divined from rough dissection, maceration, and observations on the mode of their development and on their morbid states. But the ignorance that really prevailed, as to their intimate structure, is abundantly evinced by the number of disputed questions, the absence of precision of detail, and the substitution of loose and unwarranted analogies in its stead. Within the last five years discoveries have been made which throw a new and most important light on the whole subject, and when viewed in connection with one another, must be considered to have greatly simplified our knowledge respecting it. These discoveries, due chiefly to Boehm, Boyd, and Henle, result from examinations of recent specimens with the microscope, and those of the last observer, which are especially valuable, were made with high powers employed upon a single tissue (the epithelium) in different forms and situations. It is this kind of research that promises the most enlarged and trustworthy results to any one who will follow it in a spirit of due caution against hasty generalization, and which has already done so much in the present day towards a complete remodelling of our ideas, both concerning the elements of organization and their union to form compound tissues.

Before proceeding to a description of the anatomical elements of the mucous system, it is necessary to premise that a great portion of the membranes, usually termed mucous, are glands of a complicated structure, arranged in a membranous form, consisting of a closely packed mass of secreting tubules, which open on the general surface, and are essentially involutions of it. The bloodvessels and other appended tissues occupy the intervals of these tubules, and so approach the surface; but, nevertheless, they always remain on the deep or parenchymal aspect of the mucous tissue. So, the same membranes present projections, which are nothing more than hollow evolutions of the same mucous tissue, into which the appended tissues are extended. The same remarks apply strictly to many regions of the skin. Hence it

becomes necessary to guard against confounding such *compound membranes* with the *simple mucous tissue*, of which these and all other portions of the mucous system consist.

Of the ultimate structure of the mucous system.—It has been already stated that the mucous tissue is essentially an uninterrupted membrane in which the other tissues of the animal are contained. A very cursory attempt will serve to shew how much more easily it admits of being separated and examined in certain situations rather than in others. This variety depends chiefly on the difference of its arrangement and connexions in different regions. In the testis and kidney, the capillary vascular rete, spread over its parenchymal surface, has no intimate attachment to it, and the appended areolar tissue is in very small quantity. In the testis especially, this latter may be said to be almost wanting as an investment to the individual tubules, being, as it were, disposed as a collective covering to the entire organ, sending partial septa into its interior, and bearing the name of Tunica Albuginea. In the kidney, a more intricate vascular rete in a great measure supplies the place of areolar tissue. Hence, in these viscera, the simple mucous element allows of being isolated with remarkable facility. In the liver, its isolation is almost impracticable, owing to its lying in the interstices of a capillary plexus that may be termed *solid*, from its being extended uniformly in every direction. The intricacy of the interlacement of the mucous and vascular elements in this organ is sufficient to explain the total ignorance that prevails concerning the mode of termination of the biliary ducts, and concerning their size, shape, and connexions in the lobules of the gland. In many other true glands, the mucous tissue may be submitted to examination without much difficulty; examples of which may be seen in the pancreas and salivary glands, with those allied to them, such as the duodenal glands of Brunner, the buccal, palatal, arytenoid, tracheal, &c.; and in the sudorific glands of the skin. In the compound membranes also, as that of the alimentary canal below the cardia, and the more highly developed parts of the skin, the mucous element may be generally distinguished from the tissues in connexion with it in a satisfactory manner. But in the plane expansions of the simple membrane which line the bony cavities of the nose and ear, its isolation and the demonstration of its structure are far more difficult, for reasons which will be afterwards explained, and our knowledge of it here still rests partially on the ground of analogy.

In the mucous tissue there are two structures that require to be separately described, viz. the *basement membrane* and the *epithelium*. The basement membrane is a simple homogeneous expansion, transparent, colourless, and of extreme tenuity, situated on its parenchymal surface, and giving it shape and strength. This serves as a foundation on which the epithelium rests. The epithelium is a pavement composed of nucleated particles adhering together, and of various size, form, and number. The fol-

lowing general observations on these elementary parts will receive illustration as we advance. Neither the one nor the other is peculiar to the mucous tissue in the sense either of being invariably present in it, or of not being found elsewhere. There are certain situations of the mucous system where no basement membrane can be detected, and others from which the epithelium is absent. Both, however, are never absent together. Again, a structure apparently identical with the basement membrane is met with in numerous textures besides the mucous, and all internal cavities, whether serous, synovial, or vascular, or of anomalous kind, (as those of the thymus, and thyroid body) are lined by an epithelium.

In the ensuing description these circumstances will be enlarged upon, and the exceptions and local peculiarities pointed out, as far as I have been able to ascertain them. At present, I would say that these two elements are *generally* present. The most interesting questions in animal physiology are involved in the determination of the nature and offices of these two elementary parts of the mucous tissue. The discovery of them is, however, too recent, and our knowledge of their history as yet too incomplete, to allow of any certain conclusions on the subject. Both present various modifications in different situations, the study of which is of great importance with reference to their function. It will now be our business to descend to a particular account of each.

Of the basement membrane.—The basement membrane of the mucous tissue, as displayed in the kidney, is an extremely thin, transparent, and homogeneous lamina, simple and entire, without any aperture or appearance of structure (*fig. 273, c*). It forms the parenchymal wall of the uriniferous tubules; gives them their size, shape, and stability; is in relation, on the one hand, with the vascular system of the organ, and on the other with the epithelial lining. It is simply in contact with the capillary plexus, which is fixed chiefly by their mutual interlacement; but the epithelium adheres to it by an organic union. When detached from the vascular rete which it traverses, and deprived of its epithelium, it readily wrinkles (*fig. 273, c*); and such is its tenuity, that it is sometimes only by the folds thus occasioned that it becomes visible at all. The epithelium readily separates from it after a slight maceration, and also in many diseased states of the organ, such as inflammation and Bright's disease. Though this basement tissue is so delicate, its presence or absence in any fragment of a separate tubule may always be ascertained by the aspect of the marginal outline; if this be linear and well defined, the basement membrane is present, but if irregular and broken, the epithelium only (*fig. 273, a, b*). It sometimes happens that when the epithelium may seem to be altogether detached, the basement membrane retains, scattered evenly over its surface and at some distance apart, a number of roundish marks, of the size and aspect of the nuclei of epithelium particles. These are

Fig. 273.

A portion of a tubule of the human kidney, magnified 100 diameters.

At *a*, the basement membrane and epithelium are both seen in a natural state. At *b*, the basement membrane has been separated, and the epithelium is somewhat swollen, and its outline 'woolly.' At *c*, the epithelium has been detached and the basement membrane is seen somewhat wrinkled: *d*, a detached epithelial particle seen in face; its minutely mottled texture is not represented in the wood-cut.



most probably the early condition of the new or advancing series of these particles. Its thickness in the kidney certainly does not exceed the 1000th of an English inch. I have discovered, that in the Malpighian bodies of the kidney, which are the dilated extremities of the uriniferous ducts, with an enclosed tuft of arterial capillaries, the basement membrane is often, to some extent, naturally bare, i.e. without a covering of epithelium. This is the only situation of the body in which such an arrangement is known.

In the testis, the same membrane may be shewn without difficulty to be that which gives to its secreting tubules their peculiar strength; and here, as might be expected, it is somewhat modified. The difference is principally as regards its thickness, which here reaches 1000th of an English inch, and in some animals

Fig. 274.



A portion of a tubule of the testis (Guinea-pig, *Cobaya*), magnified 300 diameters.

a a, basement membrane; *a'*, corpuscle in its substance; *b b*, epithelium in situ, consisting of particles of different dimensions, with minute granules in their interstices; *c*, cavity of the tubule full of detached epithelium particles, of various size and appearance, and mingled with numerous seminal animalcules; *d*, one of these seminal animalcules.

even exceeds that amount, its essential characters, however, remaining the same. In the larger tubes, emerging from the gland, this tubic becomes gradually invested by a delicate fibrous layer, by which the vascular network is attached to it, and which at first sight may

appear to form an integrant part of the wall of the canal.

Fig. 275.

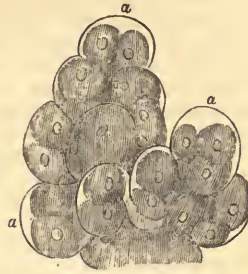

Terminal vesicles of the pancreas of the dog, magnified 300 diameters.

The basement membrane is seen at *a a a*, where the epithelium has been a little detached.

In the salivary and all the allied glands, the basement membrane admits of being easily demonstrated. A very thin slice of the fresh organ should be torn by needles, gently washed, and inspected under a high power. The terminal vesicles of the duct will then be brought into view and their outline seen to be perfectly sharp and linear (*fig. 275, a a a*). In parts where the epithelium which they contain has been loosened, the basement membrane will be left in relief. It is of extreme delicacy; and, as in all other situations, its capillary plexus (when well filled with coloured material) may be seen ramifying, not in its substance (for its tenuity renders such a disposition impossible), but on its parenchymal surface.

I have sought in vain for the basement membrane in the lobules of the liver, and I am inclined to think that it does not exist in this gland, except in the excretory part of the bile ducts.

In the air-cells of the lungs the basement membrane assumes a most interesting and remarkable development, for it constitutes almost the entire thickness of their walls, the epithelium being of extreme delicacy. It appears to be here strengthened by interlacing arches of elastic fibrous tissue, but to be itself transparent and homogeneous, as elsewhere. It is on its parenchymal surface that the close vascular web is spread out. (See *PULMO*.)

But this membrane may be also detected in every part of the alimentary tube, which is more characteristically mucous, in that, viz. intervening between the cardia and the lower extremity of the canal. Here it deserves an attentive study on account of the apparent complexity of its foldings, and because its existence here offers the most unequivocal proof which we possess, of the anatomical identity of the true glands with the membranes usually called mucous. As it is more delicate in this part than any other, and difficult of detection by reason of the enormous preponderance of its epithelial investment, I shall describe the manner in which it may be best observed. The specimen should be as fresh and healthy as possible, or should have been immersed in

alcohol immediately on its removal from the body; a fragment of the tubes of Lieberkühn should then be scraped off, pulled to pieces, and examined in a fluid medium under a high power. The margins and rounded extremities of the tubes will then be seen to be sharply defined, as in the cases already mentioned, and to be formed by a structure independent of the epithelium, which latter forms $\frac{1}{10}$ ths of their thickness. This structure is the basement membrane. When masses of epithelium, escaped from the tubes and bearing their form, are met with floating around, their outline is uniformly irregular, and, as it were, woolly. Sometimes, as in the kidney (*fig. 273*), the basement membrane is seen up to a certain point only, beyond which it has been detached; and in less recent specimens a tube of basement membrane is sometimes seen, containing a mass of broken-down epithelium.

If the part selected for examination be the stomach, the same precautions should be observed, for here this membrane is, if possible, more delicate than below the pylorus, and the epithelial particles are often so large as to bulge the tubes very irregularly, especially towards their blind extremities. It is between these bulges that the basement membrane may be best seen (*fig. 276*).

Nothing is more difficult than to explore, in a satisfactory manner, the internal structure of the intestinal villi. Their thick epithelial caps and their abundant vascular rete are readily demonstrable, but the arrangement of the lacteals, which undoubtedly exist in them, and of the structure on which the epithelium immediately rests, has hitherto almost entirely eluded our research. In vertical sections of the recent small intestine of the Carnivora, I have several times seen the direct continuity of the epithelium covering the villi, with that lining the tubes which open at their base; and also a distinct continuity between the interior of the villi, where the vessels are spread out, with the vascular intervals between the tubes, which contain the fine capillary web surrounding the tubes, and likewise give passage to the branches to and from the villi. It is then difficult to avoid the belief that the basement membrane of the tubes is continued under the epithelium of the villi, to support it, and form a part of those remarkable projections. Nevertheless I have not been able to see it in an isolated and distinct form, and do not therefore assert its positive existence; only I believe that the fact that the injected vessels of a villus, when seen in profile at its margin under a high power, and

when the epithelium has been removed, seldom come to the extreme edge, is attributable to the circumstance of the basement membrane still investing them. This membrane, if it really exist here, adheres intimately to the parts within the villus.

It might seem at first sight a hopeless task to search in so dense and complicated a structure as the skin, for the analogue of a membrane like that I have been describing, which, in no situation where it can be unequivocally brought into view, exceeds the 8000th of an inch in thickness. But as it must exist, if at all, between the epidermis and the vessels and nerves of the cutis, in a position sufficiently determinate, much of the apparent difficulty is removed. The most favourable situations for its detection are those in which the skin is highly developed, presenting, like the small intestine, villi (termed papillæ) on its free surface. The close resemblance between these papillæ and the villi of mucous membranes has been observed by many anatomists. The distribution of the vessels within both is essentially the same. Here, then, under the epidermic layer, we might expect to find the basement membrane. I have removed with great care the whole of the epidermis from a thin vertical section of such a specimen (and it is better to have previously steeped it in solution of carbonate of potass), and have then examined the outline of the bare papillæ with a power of 300 diameters. This outline is sharply defined, and appears to be formed by a homogeneous membrane, enclosing the vascular and nervous contents. This membrane I believe to be that which I am now describing, though, as in the case of the intestinal villi, I have never been able to isolate it, and thus unequivocally prove its presence. This is a part of the skin which has never been noticed by anatomists on account of its tenuity,

Fig. 276.



*Lower extremity of a stomach tubule from the dog (*Canis familiaris*), magnified 300 diameters.*

At *a a*, the basement membrane is seen between *b b b*, bulging epithelial particles.

Fig. 277.

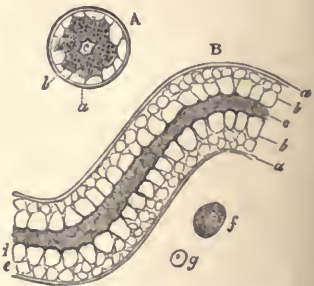

Part of the tubule of a sudoriferous gland from the human axilla, magnified 320 diameters.

A, transverse section; *B*, side view of the interior, obtained by bringing the axis of the tubule into focus; *a a a*, basement membrane; *b b b*, epithelium; *c c*, cavity of the tubule; *d*, superficial epithelial particles; *e*, deep epithelial particles; *f*, a detached superficial epithelial particle, shewing the nucleus and pigmentary granules; *g*, its detached nucleus, with a nucleolus.

but which is quite distinct from the cuticle, and the great mass of that complicated structure to which the terms 'cutis' and 'dermis' are applied.

A very strong reason for believing this membrane to be present in the skin, is the fact of its existence in those minute organs, so profusely scattered under the cutaneous surface, the sebaceous and sudoriferous glands. In *fig. 277* I have represented it in a portion of one of the latter, taken from the axilla, where they are very large. These glands are nothing more than involutions of the external tegument, and correspond closely with the labial and allied glands connected with the ordinary mucous membranes. It is impossible to suppose that a structure attaining so marked a development in those parts, should be wanting in the general superficies, with which they are, at numberless points, directly continuous.

In other situations, where a simple expanse of mucous membrane is spread out upon a surface of the body, as in the œsophagus, pharynx, mouth, nose and its sinuses, vagina, bladder, &c. (from all of which, however, there are numerous prolongations called follicles and glands, which shew this structure well,) a basement tissue such as that described has not been shown to exist. Its existence rests at present principally on analogy, and it is difficult to say whether it be not more or less modified. Certain of the peculiarities presented by these several parts depend on a modified form and greatly augmented mass of the epithelial element, but many also on varieties in the areolar and vascular tissues underlying the mucous tissue, and, properly speaking, forming no part of it. These will be treated of under the topographical description of the membrane.

Of the epithelium.—A very brief period has elapsed since it was universally held that most mucous membranes wanted epithelium, and their analogy with the skin was only maintained in this particular by a fancied resemblance drawn between epidermis and mucus. One of the principal results of microscopic observation, conducted with the improved modern instruments, is that of Henle, proving not only that this structure is present throughout the mucous system, but that in most situations it is so abundant as to constitute nearly the whole material of the tissue. This fact, as yet so novel, coupled with the discovery announced at the same time of the occurrence of a lining of analogous character on all internal cavities, makes the study of this structure under its varied forms peculiarly interesting and important. It will readily be conceived how wide a field is here opened to view, and how premature it would yet be to attempt to offer a general history of such a structure. The numerous questions presenting themselves on every side render this impossible; and if it were not so, the scope of the present article would oblige me to confine the description to those forms of epithelium met with in the mucous system. In acknowledging the great obligations I am under to Henle's admirable paper on this subject, I may state that

the following account has been written as much as possible from my own observations.

By the term epithelium is now meant a layer of particles or modified cells, furnished with nuclei and nucleoli, lining an internal surface of an organized body, and by their apposition and union constituting a kind of pavement. A similar investment to an external surface is styled epidermis. Both these, in their ordinary forms, will be embraced by the following description.

Epithelium is an organized structure endowed with vitality. This is shewn by its form, the process of its growth, and the living properties it displays. Of these the most eminent is that of ciliary motion, which in all the higher animals is performed by cilia clothing the free surface of epithelial particles. But in very many situations, if not in all, the processes of nutrition carried on in the epithelial layer of the mucous system differ materially from those of other organic tissues; the old elements, which in other cases are reconveyed into the blood, being here shed on the free surface of the membrane, and thus becoming at once eliminated from the system.

The epithelial particles preserve a greater resemblance to the form of the development cell than most other tissues. In many parts they continue to be truly cells throughout their existence, and in no instance is the nucleus, from which they have proceeded, absorbed.

In connection with a wide and varied range of function, these particles present numerous modifications of form, bulk, and texture, the leading features of which have been portrayed by Henle. The following arrangement, however, differs in several respects from that proposed by him,* and is more in accordance with what I have myself observed. Founding it on the anatomical condition of the particles and on their office, I distinguish three varieties,—the *lamelliform* or *scaly*, the *prismatic*, and the *spheroidal*. These all run together by imperceptible gradations. The particles may be also divided into *non-ciliated* and *ciliated*, the scaly being always bald, the prismatic and spheroidal in some situations furnished with cilia.

Of the lamelliform or scaly variety.—This consists of broad flattened particles (or scales, properly so called), having an angular outline (caused by their lateral apposition) and a nucleus, which is generally eccentric. These scales form layers of extremely-variable thickness. They are generally, however, superimposed in great numbers over one another, as in the mouth, fauces, and œsophagus of the human subject, where they constitute the opaque defensive investment so visible to the eye in those parts.

But the best-known example of this form is presented by the cuticle, which from its exposed position is thicker and denser than any internal epithelium. This variety, then, is the one which offers the most convincing proof of

* He divides it into pavement epithelium (or the scaly), cylinder epithelium (or the prismatic), and ciliated epithelium. See Müller's Archiv. 1838.

Fig. 278.

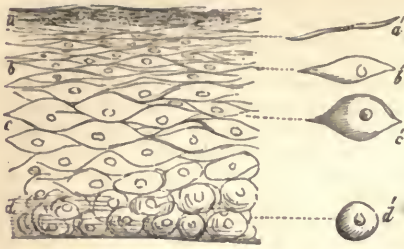

Vertical section of the epithelium of the mouth, shewing its lamellæ and the changes of form which the particles successively undergo.

a, superficial lamina, consisting of true scales; *b*, *c*, particles in progress of flattening; *d*, deep layer of particles; *a'*, *b'*, *c'*, *d'*, separate particles in the several stages. Magnified 300 diameters.

Fig. 279.

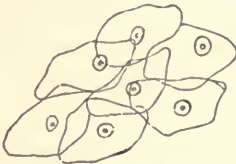

A few scales detached from the surface of the uvula. Magnified 300 diameters.

the homology of the mucous membranes with the skin. The term 'scales' is only applicable to these particles in the last of the stages through which they pass. They first appear on the surface of the basement membrane as granular dots, each of which soon becomes invested with a cell membrane. Both nucleus and cell increase in size up to a certain point, the cell being then more or less globular, and containing a material that appears transparent and almost entirely fluid. By this circumstance, chiefly, it is distinguished from the spheroidal form of particle, presently to be noticed. The cell now begins to flatten, loses its fluid contents, and is at the same time the seat of certain changes by which its chemical properties are modified. At length its opposite surfaces unite, except where the nucleus intervenes, and a lamella of extreme tenuity results, which being now arrived at the surface is loosened and shed. It appears to be by the continual pressure arising from the growth of newly-formed particles that the peculiar characters of this variety result. Accordingly, the scales are only found constituting the superficial layers of a series (fig. 278, *a a'*). It is met with in those parts only where foreign pressure, or more properly friction, has to be encountered. In such parts a thick coating of epithelium is evidently desirable, and the hard and almost horny qualities which these particles at length assume where most exposed to violence, admirably adapt them for their object. On such parts, moreover, cilia would not be needed, and it would even seem that this variety of epithelium when converted into true scales possesses

neither sufficient substance nor vital power to develop and support these exquisite organs.

The scaly epithelium is remarkable for the tenacity with which its particles adhere to one another, and to the surface on which they rest. This adhesion is manifest at all the stages through which the particles pass. It is stronger between particles at the same stage than between those at different stages of growth, so that there is always a tendency to a separation into successive laminae on maceration or otherwise. Hence have resulted the divisions of the epidermis into two, three, or more layers, and especially that remarkable fallacy of regarding the *rete mucosum* as a distinct structure. How far this adhesion is owing to the presence of an intercellular substance in all instances it is difficult to decide; but it seems highly probable that, in the deepest layers, where the particles are small and rounded, such a substance must exist in considerable abundance, filling up the interstices, and serving as a kind of *blastema*, in which the nuclei (or cytoblasts) of fresh particles originate. I have lately (Jan. 1842) ascertained a very curious fact, giving evidence of this adhesion. This is, that the delicate threads drawn out of the cutis when the cuticle is stripped from a piece of macerated skin, consist entirely of the epithelium of the sweat-ducts, the particles of which are so intimately united with one another, and with those of the deeper layers of the epidermis, as to allow of being thus dragged out of their tube of basement membrane, often for a length of an eighth of an inch.

The scaly epithelium is subdivisible into two forms, the *regular* and the *irregular*. In the *former*, the scales are united edge to edge in a regular manner, as in the skin of the Frog and other reptiles, and on many internal surfaces, especially in the lower animals. In this form, the particles do not become so thin as in the other, and the superficial scales are cast off in laminae consisting of a single series and of uniform thickness. In the *latter* form, they overlap one another without order, and present no regular figure. This is the ordinary form, and is that presented in the skin and other parts of Mammalia and Birds.

*Of the prismatic variety.**—In this the particles have the shape of small rods, disposed endwise on the basement membrane, in a single layer, the thickness of which depends on their length. These rods are united to one another by their sides, which are flattened for that purpose. They are, therefore, prisms and not cylinders, as Henle terms them. They are also almost invariably of very unequal thickness in different parts, being bulged somewhere near the middle by their nucleus, which is oval, with its long axis parallel to that of the particle. Their deep or attached extremity, also, usually tapers to a point, in order, probably, to allow room for new particles to spring up in the intervals. This is more decidedly the case where they clothe a convex surface, (as that of the

* To this the very appropriate term *columnar* has been lately given by Professor Todd.

intestinal villi,) and their sides tend to assume the direction of radii from a common centre. Hence they are sometimes even triangular in outline. Their opposite or free extremity is much thicker, often as thick as the part bulged by the nucleus, and near this extremity neighbouring particles are generally very intimately attached to one another, having often the appearance of being blended into a single mass. The best example of this is on the villi of the small intestine (*fig. 280*). The contiguous particles, however, are fitted closely together in the greater portion of their length, and to effect this the bulging nuclei vary in the height at which they are placed. There can be no doubt, that, in certain situations at least, as will be afterwards shown, these particles are being continually shed, and consequently are being perpetually renovated. But it is very difficult to ascertain their early condition and changes, and I am not aware of any satisfactory observations having been made for this end. From the great facility with which they become detached from the surface they invest, it is next to impossible to examine them *in situ* on thin verti-

Fig. 280.

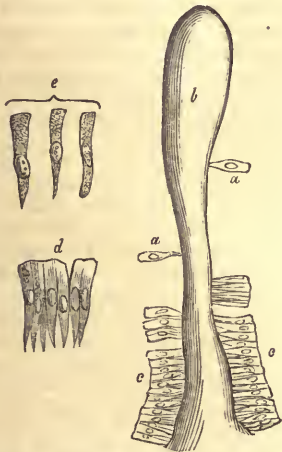

Villus of the intestinum ilium of the Dog, with the epithelium partially detached.

a a, solitary particles remaining attached; *b*, club-shaped extremity of the villus from which the epithelium has been detached; *c c*, epithelium at its base. *Magnified 150 diameters.*

d, detached particles, shewing their close union, especially at the surface (at the letter); *e*, other detached particles, shewing their various shape, their nuclei and nucleoli. The letter is placed at their free extremity. *Magnified 350 diameters.*

Fig. 281.



a, ciliated epithelial particle from the inner surface of the membrana tympani of the human subject; *b*, ciliated epithelial particles from the bronchial mucous membrane of the human subject. All these shew the nuclei and nucleoli. *Magnified 300 diameters.*

Fig. 282.



Epithelial particles from the cornu uteri of the Cow. The opposite cornu contained a fetus one inch and a half long.

a, small particle, apparently in an early stage of development. The nucleus is smaller than in the other specimens; *b*, another more advanced—the nucleus and surrounding substance are both larger, especially the latter, which presents a fine granular texture; *c*, a particle made angular by pressure against others. It presents two nuclei, as though formed by fission; *d*, another of a different shape; *e*, detached nucleus, showing its transparency and clear outline; also two excentric dots, the nucleoli. *Magnified 300 diameters.*

cal sections. But there is no reason for supposing their mode of growth to be originally different from that of the scaly variety. Their nuclei probably appear first on the surface of the basement membrane, and around these a cell is developed (*fig. 280, a*). But this cell from its earliest period seems to contain an amorphous substance, which under high microscopic powers looks finely mottled, but not so definitely so as to allow of being called granular. As the particle advances towards its full size, it loses its cell-membrane, and when complete is to be regarded rather as a solid mass of organic substance, surrounding a nucleus, than as a cell. Here, then, is a striking difference between the *scale* and the *prism*: maturity being marked in the one by the disappearance of the substance of the cell; in the other, by that of the cell-membrane.

Of the spheroidal variety (see *figs. 273 to 277*).—In this the particles are of a rounded

Fig. 283.

Three epithelial particles from the human liver.



a, nucleus; *b*, nucleolus; *c*, fatty particle.

Magnified 300 diameters.

form, though generally somewhat flattened where they touch. They are always thick, from the substance they contain. It is this variety that constitutes the chief mass of the secreting glands, and hence it might not improperly be styled *glandular*. It corresponds with the prismatic variety, in its usually constituting in the glands a single layer, and in the predominance, from the first, of its substance over its membrane. In the glands, indeed, the membrane can seldom be discerned at all, and the substance surrounding the nucleus, though more bulky, has the same finely mottled character already noticed in the prisms. In other situations the cell-membrane is persistent, but even then it never flattens into a scale. This variety presents in the different glands numerous modifications, which have not yet been studied with the accuracy they merit. It is

difficult to reject the belief that it is intimately concerned in the glandular function, and varies in correspondence with it.

To the preceding summary account of these three principal kinds of epithelium much might be added respecting the intermediate forms. This, however, does not appear to be required in so general a description. The spheroidal and the prismatic are seen blended in the specimen I have figured from the human membrana tympani (fig. 281).

Of the non-ciliated and ciliated epithelium.—The true scaly variety appears never to be clothed with cilia. The prismatic epithelium is that which most commonly bears these vibratile organs. They are placed on the free extremities of the prisms in the respiratory tract and in the uterus and Fallopian tubes. The true glandular epithelium is always without cilia. This is a general fact, and one of great importance. But those varieties which seem intermediate between the spheroidal and the other two forms are often furnished with cilia; of which examples may be seen in the Malpighian bodies of the kidney, in the mucous membrane of the frog's mouth, and in that of the human tympanum (fig. 281). In all cases the cilia, when

Fig. 284.

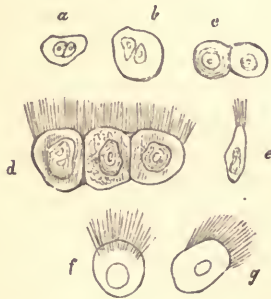

Various particles of epithelium from the frog's mouth.

a, b, c, small particles that have not reached the surface. They appear to present three stages or periods, showing a subdivision of the nucleus and a formation of two cells out of one; *d,* three fully developed particles, with cilia on their free surface; *e, f, g,* other complete particles, showing cilia on that part only which has formed a portion of the general surface of the membrane.

Magnified 400 diameters.

they exist, are developed only on that aspect of the particles which forms a portion of the general surface of the membrane.

It is as yet entirely unknown by what process the cilia are produced and nourished; whether the particles, with their cilia, are shed from time to time, and are succeeded by others, (as is most probable,) or whether the same organs remain, and merely change their component elements. (On the subject of CILIA in general the reader is referred to Dr. Sharpey's excellent article.)

Of the elementary tissues appended to the mucous system.—The two elementary tissues now described may be considered as the more

essential constituents of the mucous system, or as forming the *simple mucous membrane*. This simple mucous membrane envelopes the rest of the body. It contains within its own substance neither vessels nor nerves, but is, strictly speaking, extra-vascular. By modifications, chiefly of the epithelial element, it is in itself capable of presenting great variety of appearance and properties in different situations. But in immediate connection with its deep surface, that is, with the basement membrane, there are certain tissues common to almost every part of the frame, but here assuming a peculiar arrangement and office, and by their diversities in various localities, occasioning the most complicated varieties of outward form, of structure, and of function.

These appended tissues are minute blood-vessels, a lymphatic network, nerves, and areolar tissue.

It has been already stated that in many parts the simple mucous membrane, by its innumerable minute involutions over an extensive surface, is formed into a *compound membrane*. Into the composition of this (of which a good example is afforded by that of the stomach) the appended tissues enter more or less largely, but they are likewise, in addition, generally spread out in great abundance as a layer underneath the compound membrane. This layer has been commonly termed *submucous cellular membrane*, (sometimes *tunica nervea*;) in the case of internal surfaces, and *cutis vera* or *dermis* in the case of the skin.

Bloodvessels.—These may be said to be universally present under the *simple* mucous membrane, with the exception perhaps of the cornea, where vessels, in the normal state, have not yet been demonstrated. The capillaries, in their simplest form, appear to be arranged as a plane network, such as that of the rectum of the frog (fig. 285). The interstices of this network vary much in size and shape in different localities. The most copious supply of blood distributed to any such membrane is that afforded to the air-cells of the lungs in all animals. Here this plane capillary plexus has areolæ scarcely exceeding the diameter of the vessels themselves. Where the membrane they supply is folded, however irregularly, they follow its surface, and hence result many varieties in their arrangement and inosculation. It even seems to be for the purpose of gaining a great freedom of inosculation between the capillaries that the extraordinary complexity has been given to many parts of the simple membrane, especially in the secreting glands. For many foldings from somewhat distant parts of the membrane are there brought into immediate proximity to one another, and are supplied by the same or closely connected vessels. This is remarkably exemplified in the testis, kidney, and liver. The capillary system of all these, as well as of other solid glands, may be styled a *solid plexus*, being extended in every direction, and presenting areolæ of nearly equal size in whatever plane a section of it be made. The liver presents the most perfect instance of such a solid plexus, and in it the vessels are of

Fig. 285.



Capillaries on the rectum of the Frog.
a, a, arteries; b, b, veins.

unusual dimensions, apparently to allow of the more free transit of the blood, which is here propelled feebly by the *vis à tergo* acting through the capillaries that form the portal vein. Though it has not been so described, I believe, from injections that I have made, that the whole organ is one such plexus, and that if it were possible to abstract from it all vessels larger than capillaries, and to leave these entire, all the lobules would still be connected together by capillary channels identical with those of which they themselves principally consist. Hence the lobules of the liver are not definitely bounded on all sides by a capsule of any kind, but here and there blend by continuity of substance with those adjoining them. The larger portion of their contour is, however, well defined by the ultimate twigs of the portal vein, and of the ducts derived from the lobule, as so clearly proved by Mr. Kiernan in his well-known paper.

The size of the capillaries varies much in different parts of the mucous system. In the liver they are very capacious, always one-third wider than the diameter of the blood globule, and sometimes nearly double. In the lungs they are almost equally great. In the intestinal villi also they are of large dimensions. In these organs they form a network on the inner surface of the basement membrane, and are supplied by an artery that ascends in the axis of the villus. The veins from this network are generally two, one on each side. This plexus of the villi is strikingly contrasted by that clothing the tubes that open at their base. In this latter I have observed the diameter to be as small as that of the capillaries of the salivary glands, which do not exceed the width of a

blood globule. This disparity is another confirmation of the opinion that the villi are chiefly absorbing, and the tubes secreting organs. Many other varieties might be enumerated, but these are among the most remarkable.

Under most of the *compound* mucous membranes bloodvessels are spread out in great profusion, and especially in certain localities. The arteries and veins respectively form plane plexuses, more or less close, more or less intricate, from which emerge branches that pass between the foldings of the simple membrane and communicate with its capillaries, already described. There may even be a series of these arterial and venous plexuses situated one over another, and successively springing out of one another. The effect of this arrangement of an arterial network on one side of the capillaries and a venous network on the other side, is that the blood, besides being delayed in their neighbourhood, is most freely and equably distributed in the capillaries themselves: a condition which could scarcely be otherwise accomplished, since, in the case of a villous membrane at least, the capillaries form a series of isolated systems, of which one belongs to each villus. The arrangement now spoken of exists in the submucous areolar tissue of the stomach and intestinal canal, and in most parts of the skin. In the solid glands, where the capillaries form one continuous system, such arterial and venous networks are not found. At least such inosculation, when they exist, are few and rare. In the stomach of many fishes there is a plexus of great thickness under the mucous membrane. In the nose also, chiefly on the spongy bones and septum, there is a plexus of very large veins, well known to anatomists, and also a less capacious arterial plexus; smaller ones are met with in other parts, as the cheeks and lips, the palate and pharynx. The use of these, especially that of the nose, may be to serve as a diverticulum for the blood in cerebral congestions. These are the vessels that give way in ordinary epistaxis.

Of the lacteal and lymphatic vessels.—The lacteals have their sole origin from a plexus underlying the simple mucous membrane of the alimentary canal, and it is probable that in every part of the skin a close network exists, such as has been described by several anatomists (see LYMPHATIC SYSTEM). Considering the means hitherto at command for ascertaining the precise position of this network, it is not wonderful that disputes should have arisen as to whether it lies in the rete Malpighii, or within the surface of the dermis. I would hazard the opinion that the real situation of this plexus is underneath the basement membrane which is everywhere present in the skin.

Of the nerves.—These are numerous and varied, as might be expected from the position of the mucous system in regard to the rest of the body. They may all be styled *afferent*, and are divisible into three kinds, viz. the sensory, the excito-motory, and the sympathetic. The nerves of special sense distributed to this system are those of smell, taste, and touch. The nerves of common sensation and the excito-

motory nerves are almost exclusively found here. The tubules of the sympathetic nerves are chiefly given to the proper mucous membranes and to the glands. All these will be considered more at length under other heads, and they are therefore only referred to here.

Of the areolar tissue.—Before describing the remarkable varieties presented by this tissue under different parts of the mucous system, I must advert to its constitution in those situations where its ordinary characters are well marked—as in subcutaneous fascia, in muscle, on the exterior of the pharynx, &c. Singular as it may appear, there is no correct account of this structure in any of the works on minute anatomy. It in truth consists of two tissues, distinct from each other, and respectively allied to the white and to the yellow fibrous tissues. The *white fibrous element of areolar tissue* is chiefly in the form of bands of very unequal thickness, in which are to be seen numerous streaks taking the general direction of the whole, but not parallel to the border, nor continuous from end to end. These streaks more resemble the creases of a longitudinal folding than intervals between separate fibrillæ, for which they have been mistaken. These bands split up without difficulty in the long direction, whence result fibrils of the most varied width, the finest being far too minute for measurement, even with the best instruments.* These bands interlace and cross one another in various directions, and their natural course is wavy. They frequently subdivide and join those near them. Besides these bands, commonly called fasciculi, there are some finer filaments of the utmost tenuity which seem to take an uncertain course among the rest. The *yellow fibrous element* is everywhere in the form of solitary fibrillæ, which correspond in their essential characters with the tissue of that name. They are disposed to curl, and are truly branched at intervals of variable length; these branches (which usually retain the size of the fibril from which they spring) becoming continuous with others in the neighbourhood. They have higher refractive properties than the white element, and their borders are consequently darker.

It is easy to overlook this twofold composition of areolar tissue in specimens examined in water, but their discrimination is made easy by a trifling artifice. This consists in adding a drop of acetic acid, which instantly swells the white bands, and makes them transparent, but produces no change in the yellow fibrils. These effects of the acid may be watched, if the agent be made to spread gradually over the specimen; and there can scarcely be conceived a more beautiful example of the aid chemistry will afford anatomy than that presented in the course of this interesting process.† The change

* The fibrillæ of true white fibrous tissue are almost precisely similar, and, as I believe, are only produced by the observer himself in opening out his specimen for inspection.

† In the case of the dartos, this procedure detects not only what has just been described, but a third element, hitherto in this situation quite con-

produced in the white bands is such as to shew very clearly that they are not truly fasciculi, or aggregations of fibrillæ. The action of the acid on these two elements is identical with that produced on the two tissues to which I have shewn them to be anatomically allied.

To these two elements of areolar tissue are to be attributed physical properties similar to those of white and yellow fibrous tissues, and these will vary greatly in different situations, according to the proportion and mode of arrangement under which the two elements coexist.

Of the areolar tissue of glands.—There appears to be a very prevalent misconception with regard to the quantity of this tissue found in the interior of the large glands, as the liver and kidney. It is imagined that it *punctates* into every interstice, mingles with the capillary rete, and envelopes the ultimate secreting tubules. It is, however, impossible in the most recent specimen of these organs to discover anything answering to this description. All that can usually be detected is a small quantity accompanying the larger vessels in their course within the organ, and forming septa between its coarse subdivisions. And it would be difficult to suppose a purpose which a more abundant supply could subserve. The capillary network and the secreting tubules by their mutual and intricate interlacement sufficiently sustain one another; no freedom of motion is required between them; there is no force tending to separate them. I am far from saying, however, that the ultimate substance of these glands consists only of simple mucous membrane and bloodvessels. In the interstices of these there are probably nerves and lymphatics, of the mode of termination of which we know nothing, but which seem much fewer than is commonly supposed. There is also more or less of an *interstitial amorphous substance*, hereafter to be described.

In these glands and in the substance of many compound mucous membranes there are to be seen here and there small bodies not unlike cellular tissue in an early stage of its development. They have a bulging nucleus from which they taper to the extremities; and they are much longer and slenderer than the prismatic epithelium. With their nature and use I am at present quite unacquainted.

The lungs seem mainly to owe their extraordinary elasticity to the yellow fibrous element of their submucous areolar tissue. This is spread in great abundance under the whole surface, and much predominates over the white. In the trachea and bronchia it is besides largely developed in longitudinal bands visible through the mucous membrane. In the whole of this region its fibrils take a general longitudinal direction, but branch and inosculate at very frequent intervals, enclosing areolæ of small dimensions. But this element does not cease with the tubes; it is prolonged in the form of branching, arching bands over the basement membrane of the air-cells, which it renders elastic and firmly supports.

founded with areolar tissue. This is *non-striated muscle*, at once known by its being loaded with corpuscles, or persistent cell-nuclei. See MUSCLE.

Where mucous membranes are not destined to move on the parts they cover, the areolar tissue beneath them is very scanty. This is the case in the nasal cavities, even in the portions furnished with a great substratum of bloodvessels. But where much motion is required, as where a muscular lamina underlies the mucous, and the enclosed cavity is liable to vary in its dimensions, the areolar tissue is copious, and very similar in its elements and in the size of its interstices to the ordinary forms. Examples of this are seen in the whole alimentary tract.

But it is under the cutaneous part of the mucous system that this tissue assumes its highest development. Elsewhere its object is to promote freedom of movement, or to confer elasticity. Here it answers both these purposes, and in addition gives a great capacity of resistance against external pressure and violence. The former end is attained by the structure called subcutaneous fascia, which is a large quantity of this tissue in its ordinary form. The two latter are effected by that more condensed part to which the term of cutis has been given. This last is the structure to which the submucous areolar tissue of the intestinal canal mainly corresponds, as may be shown by an examination of the submucous tissue of the mouth, pharynx, and œsophagus, which holds an intermediate place. To describe its modifications in different situations would be to encroach too much on the province of another article (see SKIN), and a few general remarks must here suffice.

The framework of the cutis may be said to consist entirely of a modified form of the areolar tissue. Both elements are enormously developed, but especially the yellow fibrous one. The fibrillæ of this are thicker than elsewhere, and branch and inosculate with great freedom, enclosing interstices open on all sides, and giving passage to the wavy bands of the white fibrous element as well as to vessels, nerves, the ducts of the sweat-glands, the sebaceous glands, and the roots of the hairs. These interstices are in general very close, but they vary with the size of the parts which occupy them. On the deep surface of the cutis the yellow fibrous element changes gradually into that of the subcutaneous fascia, or that of ordinary areolar tissue. It cannot be doubted that the skin chiefly owes its elasticity and toughness to this remarkable development of the yellow fibrous element.

Topographical view of the mucous system in man.—Referring the reader to the article SKIN for a detailed description of that part of the mucous system, and its immediate dependencies, I shall now proceed to point out some of the more remarkable varieties of the internal tracts. These tracts have been usually comprehended under two general divisions, the gastro-pulmonary, and the genito-urinary. The former is continuous with the skin at six points, the two eyelids, the two nostrils, the mouth, and the anus; the latter at a single one, the orifice of the urethra in the male, and the labia pudendi in the female. Besides these, there are two smaller tracts, the mammary, each of

which is subdivided into several, which open separately on the skin.

The description of the *gastro-pulmonary* tract may be commenced at the lips. It covers their inner surface, the cheeks, gums, tongue, and palate, and extends into the labial, buccal, and larger salivary glands, of which it constitutes the chief mass. It passes over the arches of the palate, (where its involutions form the tonsils,) and lines the pharynx, Eustachian tubes, and the cavities of the tympana. Penetrating into the nose by the posterior nares, it lines all the passages and chambers of that organ, and advances along the nasal duct to the lachrymal sac. Thence it may be traced along the canaliculi to the front of the eye, where it takes the name of tunica conjunctiva; covers the posterior surface of the eyelids, a certain portion of the sclerotic, and the cornea, and forms the caruncula, the Meibomian and lachrymal glands. In these complicated portions of its course, the membrane shares more or less in the construction of the five organs of special sense, and is the essential seat of two of them, taste and smell. From the pharynx it spreads in two directions; first, into the larynx, trachea, tracheal glands, and bronchial ramifications, until it terminates by forming the air-cells of the lungs; secondly, into the alimentary canal. Here it lines the œsophagus, stomach, and intestinal tube, as far as the anus, and it penetrates along the excreting ducts of the liver and pancreas, into the inmost recesses of those glands, to form their secreting surface.

The *genito-urinary* tract may be traced along the urethra into the bladder, ureters, and pelvis of the kidneys; and thence into the substance of those organs as far as the Malpighian bodies, the extremities of the uniriferous tubules. In connection with the urethra, processes pass to the glands of Cowper; and, in the male, into the interior of the prostate, the vesiculæ seminales, vasa deferentia, and tubules of the testes. In the female, the vagina, uterus, and Fallopian tubes receive a lining from it, which, at the fimbriated extremity of those canals, becomes continuous with the serous membrane of the abdomen.*

The very remarkable differences presented to the eye by different parts of this system have been a source of great difficulty to anatomists, who, on other grounds, believed them to be nearly allied; and it would appear that hitherto no satisfactory explanation has been given of the anatomical conditions on which this variety depends. This deficiency I shall now endeavour in some degree to supply. From the examinations I have made, I have been led to consider in a distinct and separate manner the several elementary tissues already mentioned, composing the simple mucous membrane, and

* This remarkable exception to a general fact has long attracted attention. As a mere anatomical difficulty, it has lately received curious illustration from Henle's discovery of the existence of an epithelium on serous and other allied surfaces. But its true explanation can probably only be attained by a study of its morphology, joined with that of its final cause.

lying underneath it; and am come to the conclusion that the most complicated diversities that are met with, admit, when studied in this manner, of being explained and reconciled to a common type of structure.

Peculiarities of the skin, mucous membranes, and glands.

Of the skin.—This is chiefly peculiar in its epithelial element and its submucous areolar tissue. The epidermis is composed of a vast number of superimposed laminae of scales, which, in the earlier stages of their development, and especially in certain races of mankind, contain minute *pigment granules* in their interior. The pigment disappears more or less completely as the particles attain the surface. It is continued for some distance down the hair follicles and sweat-ducts, and thus serves to mark the continuity of these parts with the general surface. Hairs, nails, hoofs, and other similar appendages are all composed of modified epithelial particles, and are nearly peculiar to the skin. The sebaceous and perspiratory glands, and the spiral ducts of the latter traversing the epidermis, are also among the most characteristic features of this part of the mucous system. The papillae of the skin have their counterpart in the villi of the mucous membranes; the *cutis vera*, as it is called, has also its analogue in the submucous areolar tissue, but it is so enormously developed that the resemblance has escaped the notice of anatomists. Its characters have been already briefly described. It is a striking fact that the *cutis*, like the submucous areolar tissue, contains no fat, even in the most corpulent subjects. I have repeatedly made this remark. The *cutis* differs in this respect from the subcutaneous fascia, which is therefore, perhaps, to be regarded as less allied to the submucous areolar tissue.

Of the mucous membranes.—These hold an intermediate place between the skin and the true glands. They blend insensibly with the former at the different orifices of the body, and may, under favourable conditions, become so modified as to assume the appearance of skin. The change then wrought is nothing more, however, than an increased deposit of epithelial scales, with an absence of the natural moisture; and it may be doubted whether a transformation of this kind could occur in a mucous membrane of which the epithelium was not of the scaly variety. On the other hand certain parts of the membranes usually termed mucous are nothing less than real glands arranged in a membranous form.

The mouth, pharynx, œsophagus, the vagina and vaginal surface of the uterus, are the parts whose lining membrane most nearly resembles the skin. Their most remarkable feature is the thickness of their covering of epithelial scales, provided for their protection against foreign contact and pressure, and in connection with this the existence of numerous glands opening upon them for the lubrication of their surface. Many of these glands correspond with the sweat-glands of the skin in being similarly scattered under the surface. Such are the

buccal and all the small glands allied to them, which, in particular, resemble the largely developed sweat-glands of the axilla. The only difference between them is in the mode of involution of the secreting membrane, which in the former is celled, in the latter tubular. These portions of the mucous membranes also approach the skin by the denseness of their submucous areolar tissue.

In the pharynx it is only that part of the lining membrane below the posterior arches of the palate, or that exposed to friction during deglutition, that has the dermoid characters now described: all above is more delicate, is clothed with ciliated epithelial prisms, and belongs physiologically to the nasal or respiratory tract. The lower or buccal surface of the soft palate differs in a similar way from the upper.

The lining membrane of the Eustachian tubes and tympana is very delicate, none of the elementary tissues predominating. The epithelium is in a single layer of prisms clothed with cilia. The submucous areolar tissue is in very small quantity, and the vascular network consists of little more than a simple plane expansion. In the nose, the epithelium, according to Henle, is scaly on the septum and on the alæ for some way within the nostrils. Here also there are hairs—an advance towards the characters of the skin; beyond this it is everywhere ciliated, even within the bony sinuses. The membrane covering these sinuses is of extreme tenuity, and presents the elementary tissues all in a simple form. That covering the pendulous parts of the spongy bones, on the contrary, has long been noted for its great thickness—a character due to neither of the elements of the mucous tissue itself, but to the extraordinary size of the submucous vessels. Both arteries and veins are large, but especially the latter, which here form a plexus immediately beneath the surface, and not separated from it by any considerable quantity of dense areolar tissue. Hence the facility with which these vessels give way externally when distended with blood. The lining of the nose has been sometimes called a *fibro-mucous* membrane, from its close connection with the periosteum. The periosteum in the sinuses is extremely delicate, in consequence of the tenuity of the bony laminae it invests; and it would perhaps be impossible to separate it there from the submucous areolar tissue. The globe and cornea are covered with scaly epithelium, of which the particles are smaller towards the folds of the eyelids,* where they gradually become prismatic, and along the tarsal borders clothed with cilia, so small as to be only recognizable a short time after death. The conjunctiva of the lower lid is very minutely villous. At the pharyngeal orifice of the glottis, the epithelium becomes ciliated and continues so along the trachea and bronchial ramifications as far as the air-cells, but, according to my own observations, the cilia there cease, and the epithelium changes its character to a remarkable variety of the glandular form. In the air-

* Henle, loc. cit.

passages, as formerly described, the submucous areolar tissue presents a remarkable modification, and is closely joined to the perichondrium of the inner surface of the cartilages. It is worthy of remark that the glands with which the tracheal portion of the membrane is furnished, are not placed, like the buccal, duodenal, and other similar glands, immediately subjacent to the mucous membrane, but on the posterior surface of the trachealis muscle, which is pierced by their ducts. This peculiar arrangement would seem to be accounted for by the deviation from the ordinary form which the submucous areolar tissue here presents, and which renders it ill adapted to give to these irregular-shaped bodies that loose investment which they everywhere possess, and which therefore appears necessary to them.

The mucous lining of the whole alimentary canal below the cardia is the largest and best marked example of what I have termed the compound mucous membrane, being composed of vertical tubes which are truly glands, opening on the general surface. That of the small intestine presents villi also. This entire membrane is very soft and easily torn, because its chief mass consists of an epithelium, the particles of which adhere but slightly either to one another or to the basement membrane, and are everywhere disposed in a single layer. There is moreover scarcely any areolar tissue between its involutions, which have, therefore, little besides the vascular web to sustain them. The submucous areolar tissue is in considerable abundance between the mucous and the muscular coats. (See STOMACH and INTESTINAL CANAL.) The lining membrane of the hepatic and pancreatic ducts is simple, and its epithelium of the prismatic variety.

In the *genito-urinary* tract, the epithelium presents every variety. The fossa navicularis* is clothed with small, flat, or roundish scales, the rest of the urethra with a single series of prismatic particles. The cells of the prostate are lined with spheroidal epithelium, the vasa deferentia with prisms. In the vesiculæ seminales there is a pavement of somewhat flattened granules, and also in Cowper's glands. In the bladder, ureters, and pelves of the kidneys, the epithelium is in the form of longish cells intermediate between the spheroidal and the prismatic varieties. The nymphæ, clitoris, hymen, and vagina are covered with scaly epithelium, and this has been noticed by Henle in cases where the hymen has been entire. Within the neck of the uterus the epithelium becomes prismatic and clothed with cilia, and so continues over the surface of the uterus and Fallopian tubes, and even for some distance over the outer surface of their frimbriated extremities. Beyond this it merges gradually into the compressed cells of the serous membrane. The lining membrane of the Fallopian tubes, as well as that of the uterus, is of a compound nature, especially during gestation, and consists of tubules arranged vertically to the general surface. It is to be observed that the cilia only

clothe the general surface, and that the epithelium lining the tubules is spheroidal, or intermediate between that and the prismatic. It is a form of the glandular variety, and bears no cilia.

Of the glands.—The varieties apparent in these organs also may be explained by an examination of the modifications and modes of aggregation of the elementary tissues already mentioned. It may be said, in general terms, that the glands are characterized by their solid form, by the great preponderance of their epithelial and vascular tissues, and by the small quantity of their areolar tissue. It is rare for this last to invest every individual involution of the mucous surface in the interior of a gland; but it usually gives a common covering to the whole organ, as well as less complete ones to those subdivisions of it, termed lobes or lobules, which result from the mode of distribution of the bloodvessels and duct, and are designed for the purposes of package or protection.

Such an investment is usually termed the proper coat or capsule of a gland, and seems to correspond most nearly with the submucous areolar tissue of the compound mucous membrane, as, for example, that of the intestinal canal.

The propriety of these remarks will appear, on a particular application of them. As I before entered somewhat in detail into the internal composition of the liver, it may now be selected for illustration. The epithelium, which in the gall-bladder and larger ducts is of the prismatic kind, becomes bulky and of a flattened spheroidal form, in the lobules. It there also acquires a peculiar character, viz. numerous minute globules of an oily or fatty nature, disseminated within the substance of each particle. The basement tissue seems to cease, and on an examination of a thin section of the lobule under a high power of the microscope, its chief bulk appears to consist of epithelium. There is scarcely a trace of areolar tissue to be anywhere detected. Even the coats of the capacious capillary bloodvessels, in the close meshes of which the ultimate ramifications of the bile ducts are situated, are with difficulty seen, and are of extreme delicacy. The submucous areolar tissue of the hepatic ducts, with which the whole of the contiguous capsule of Glisson should be associated, cannot, when arrived at the lobules, be followed into their interior. It can only be distinguished in very slender quantity, giving them a partial investment, on those aspects which share in forming the portal and hepatic-venous canals, and where, in the angles of union between three or more lobules, a terminal twig of the portal vein runs up to open on all sides into their capillary plexus. No lobule is isolated from the rest by a complete capsule, but communicates immediately by its capillary network, with those near it. The intralobular vein has a similar want of areolar tissue around it; and thus the main mass of the lobule, and of the whole liver, consists of epithelium and a plexus of capillaries. Those lobules, however, which contribute to form the general surface of the

* Henle, loc. cit.

organ have an additional and dense covering of areolar tissue on that surface: a covering, which has the same relation to the mucous element, as that on the portal aspect; which is continuous with the capsule of Glisson at numerous points; and which is here developed as a membrane of support, as a nidus for a lymphatic rete, and as a foundation for the peritoneal tunic, that it sustains.

The nerves and lymphatic vessels of the interior of the liver, though but little known, are too inconsiderable in point of size to affect the general accuracy of this description. Hence it evidently appears, on what modifications of the elements of the mucous tissue and of those appended to it, the peculiar friability, colour, and other properties of this organ depend. If the "parenchymatous" areolar tissue abounded in this gland to the extent implied in the descriptions of Bichat and some more recent authors, no doubt its toughness would be far greater than it really is. But where an organ is sufficiently screened from injury by its position, where its different parts are so well connected by the continuity of a close network of capillary vessels, and are not required to move on one another, it would be difficult to imagine what purpose a greater development of areolar tissue would serve.

In the *kidney*, the epithelial and vascular elements are in corresponding abundance, the areolar tissue in very small quantity. The general texture, however, is more tough than in the liver, from the universal presence of the basement membrane on the tubes. In the medullary portion, the tubes radiate from the apex towards the base of the cones, and are imbedded in a firm, granular substance, not hitherto described, but which resembles a blastema, and is probably composed of cells. In this substance is also imbedded the capillary plexus surrounding the tubes, as well as the vessels, that convey blood to and from this plexus, and take the same direction as the tubes. Hence the firmness and close texture of this part of the kidney as compared with the other, and the facility with which it tears from the apex to the base of the cones. At the base of the cones, the tubes enter the cortical substance and take a course, in sets, towards the surface. The central tubes of each set reach the surface and then recline inwards and become convoluted. But the others bend down one after another and become convoluted before reaching the surface. All at length terminate in the Malpighian bodies, which lie among the convolutions. The arteries and veins also take a general course from the hilus towards the surface. Hence, on tearing the cortical part of the organ, there is a disposition for the laceration to occur in lines continuous with the radii of the medullary cones, and this disposition is less evident as we approach the surface; but between these lines the torn surface is very uneven, where it is formed by the contorted tubes. The cortical part has less of the intertubular matrix than is met with in the medullary cones.

In the kidney there is a peculiarity of the

highest interest in the relative situation of the vascular and mucous tissues, which seems to have reference to the peculiar function of the gland. There are two systems of capillary vessels, the former of which, or that in connection with the renal artery, perforates the mucous membrane at the extremity of each tube, and lies on the outer surface of the membrane, that is, bare and loose within the dilated extremities, which thus form the capsules of the Malpighian bodies.* (See *REN.*)

The common submucous areolar membrane of the kidney, or that forming its capsule, is in most animals chiefly composed of ordinary areolar tissue with close meshes. But where a more resisting covering is required, as in the lion, this areolar tissue is modified; the white fibrous element predominates so much as to give the capsule the glistening aspect of an aponeurosis. This is an admirable example of the transition from areolar tissue into white fibrous tissue, and helps to show the true nature and relations of the tunica albuginea of the testis.

The *testis*, compared with the liver and kidney, presents several modifications of the elementary tissues. The basement membrane is much stouter than in the latter gland, the tubes are larger and their convolutions more loosely joined by any intervening substance. There is no appearance of an intertubular substance except towards the corpus Highmorianum, and the principal connecting medium between the tubes seems to be the vessels, which are less numerous than in the glands already mentioned, and form a looser network. The secreting tubules for these reasons admit of being very easily separated from one another, and unravelled to great lengths. The epithelial element of the testis constitutes a lining of considerable thickness, and is highly remarkable (see *fig.* 274). Though no seminal animalcules have been hitherto seen in the interior of the particles while still attached to the basement membrane of the tubes, yet from recent researches, and especially from those of Wagner, on the phases of their development, it is rendered highly probable that these singular moving bodies originate in the epithelial particles, as one of the results of their natural evolution. The loose aggregation of the tubules of the testis makes a firm external capsule necessary, and where, as in man, this gland is much exposed to injury by its situation, a further protection of this kind is made requisite. Hence the firm and unyielding character of the tunica albuginea in man, the contrast of which with the thin covering of the large but well protected testicle of the porpoise (for example), is well worthy of attention. In many large animals, the tunica albuginea, like the aponeurotic capsule of the lion's kidney, is traversed more or less completely by large veins which it thus serves to support. The tunica albuginea consists almost solely of white fibrous tissue, and represents the submucous areolar tissue of the mucous system.

The peculiarities of the *salivary glands* re-

* *Phil. Trans.* 1842, part I.

sult from the predominance of their epithelial element over the others. The ducts terminate in vesicles, very similar in the figure they assume to those of the lungs, but nearly filled up with epithelial particles. The basement membrane is very delicate. The capillary vessels encircle the vesicles, and are comparatively few in number, whence the pale colour of these glands. The areolar tissue forms capsules for those aggregations of vesicles, termed lobules, but does not penetrate between the individual vesicles.

The *mammary glands* derive their extreme denseness and toughness, as well as their white colour, principally from the areolar tissue, in which the proper glandular membrane is enclosed. This tissue penetrates more abundantly between the minuter subdivisions of the gland than is observed in any other instance. It thus affords support, at the same time that it permits and facilitates movement of one part of the organ on another. It is also of such a nature as to readily allow of distension during lactation.

General outline of the functions of the mucous system.—By its external anatomical position, this system is subservient to four great functions: the reception of impressions from without, the defence of the body from external injurious influences, the absorption of foreign particles, and the separation of such as are for any reason to be eliminated. It may almost be said to be the peculiar seat of these functions, which, however, are distributed in a very unequal manner over its different regions.

Reception of external impressions.—The skin and mucous membranes appear everywhere fitted by their nervous supply to receive impressions, which, being conveyed to the nervous centre, may there excite a reflexion of stimulus along motor nerves, without the intervention of consciousness. Common sensation, or that which in its most exalted form becomes touch, exists in all parts of the cutaneous surface, within the mouth, for some distance within the nostrils, and (with the exception of the pharynx and œsophagus) in general, wherever the epithelium is of the true scaly variety. Where the sense of touch is most perfect, the simple membrane is observed to be involuted into the form of papillæ for the purpose of crowding a larger number of nervous loops into a given space. Taste and smell, which are nearly allied to touch, are the other special senses of which the mucous system is the seat. The sensations of hunger and thirst seem also referrible to this tissue.

Defence from external influences.—One chief division of the mucous system, viz. the skin, derives its main characteristics from its adaptation to this function, and those parts of the mucous membranes which are most exposed to the contact of irritating substances approach the most nearly to the skin in their structure. Their epithelium is scaly and in thick laminae, their submucous areolar tissue abundant, dense, and resisting. The nervous endowments of such surfaces, whether excito-motory or sensorial, mainly contribute to the protection of

the animal. And, on the external tegument, the development of hairs, nails, &c. in their endless modifications of form, position, and structure, serve, with few exceptions, the same important purpose. In some parts of the mucous membrane peculiarly obnoxious to pressure, there are special glands for the lubrication of their free surface.

Absorption of external material.—Every particle, entering the body from without, is absorbed, in the first instance, through some portion or other of the mucous system. What is now known of the nature of this function in general, renders it certain that every part of the mucous system would form an absorbing surface, if favourably circumstanced for doing so. But as the extraneous material, to be absorbed, must be brought into contact with the absorbing surface, often by some special and complicated means, this function is chiefly limited to certain distinct districts of the system. With few exceptions the glands are not suited either by their position or structure to receive the contact of extraneous substances, and even many portions of the mucous membranes are incapacitated in the same manner, as, for example, most of those lining the excretory passages of the glands. The secretions which, in a healthy state, are the only substances brought into contact with these surfaces, are, it is true, occasionally modified by a partial absorption of their constituents; but, generally speaking, this occurs to a very slight extent. Once formed, they usually traverse the channels, leading to the outlets of the body, unchanged.

The simplest condition under which this function presents itself appears to be that exhibited by the respiratory surface, which, whether it be arranged as lungs or gills, is concerned with aeriform particles, and absorbs and secretes through the self-same structure. The skin also is a very active absorbing surface, and appears, by the best observations, to be provided with a close net-work of lymphatics, which I have already stated to be most probably situated immediately under the basement membrane. It does not appear that the existence of the lymphatic pores, described by MM. Breschet and Roussel de Vauzème as opening on the free surface of the cuticle, has been confirmed by any subsequent anatomist. I have sought in vain for any such system of vessels in the cuticle, and I believe those distinguished observers must have been deceived by the irregular lines of union between the epidermic particles. It is true that the thickness and texture of the layers of epidermic scales are little calculated to allow of their being permeated by foreign material, whether fluid or gaseous; and, therefore, it is not likely that absorption is effected to any great extent either through their substance or interstices. It seems more consonant with facts to suppose, that this process, especially in respect to solid matters, is carried on by the simple membrane of the sudoriferous ducts, with which external particles would easily be brought into contact through their open extremities. But as these ducts traverse the thickness of the cuticle, and in that part of

their course have not (in man) any proper wall, but are bounded only by the edges of the scales between which they pass, it is very probable that the deeper and softer laminae of epidermic particles may not merely be moistened by the secretion of the ducts, but, under favourable circumstances, may borrow extraneous matters from them, and thus become a part of the absorbing medium. In reference to the question of absorption by the skin, it is interesting to notice the modification of this structure in those lower animals in which this function is manifested in much greater activity than in man. A better example cannot, perhaps, be selected for this purpose than that of the frog. Its epidermis consists of a single layer of scales, and in consequence they do not overlap, but join edge to edge. These scales are not reduced to mere membrane, but always contain a considerable quantity of fluid in their interior. The sweat-pores open here and there in the interstices between three scales, and have true walls, formed out of a pair of modified epidermic particles, adapted to one another, and elongated into the subcutaneous texture. They thus bear a very close resemblance to the *stomata* of leaves. I lately discovered this singular arrangement in the cast-off cuticle of the animal. It seems undeniable, that, here, absorption is effected by the whole series of epidermic scales, as well as by the pores.

But the most remarkable, and at the same time the most recondite form, under which this function is exhibited in the mucous system, is that met with in the alimentary tract. Here, indeed, water and aqueous solutions are imbibed, with great rapidity, into the vascular plexuses of the blood and lacteal systems, as the united testimony of many able experimenters abundantly shews. But from this merely physical process of *imbibition* is to be distinguished the more mysterious and elective function of chylous absorption, which is conducted by the lacteals alone, and is consequently limited to the region supplied with that system of vessels. For an account of the present state of knowledge on the highly important subject of the intimate nature of this function, the reader is referred to ABSORPTION and LYMPHATIC SYSTEM, in which he will find the chief of the conflicting statements and opinions of physiologists detailed and discussed. It has already been explained in the present article, that the latest observations on the structure of the villi, and apparently the most exact ones, because conducted with the most improved lenses, and accordant with other collateral discoveries, make it highly probable that the opinion assigning open mouths to the lacteals is erroneous. In the description of those orifices, furnished by Treviranns, we may plainly discern his partial acquaintance with characters which we now know to be those of the prismatic epithelium investing the villi; and the less precise assertions of the same kind by several other excellent anatomists, we may now, perhaps, fairly consider to have been founded on deceptive appearances which, in their day, did not admit of accurate interpretation. If any such orifices

exist, their minuteness must be extreme, and they must lie in the intervals between the prisms of epithelium. But even such attenuated pores, the best microscopes fail to detect, and at least it may with certainty be affirmed, that none large enough to admit a chyle-globule exist. The structure of the villi, no less than our knowledge of the absorbent function in general, seems to indicate that the chyle, when first taken up, is strictly a fluid, and only acquires its solid particles after it has entered the lacteal plexus.

Of the separation of material from the body.—This function appears to be carried on in every part of the mucous system. One great division, that of the glands, is specially destined to it, as are likewise those portions of the compound mucous membranes, which have been already described as coming properly under the designation of glands. If, however, the essential nature of the function of secretion be adequately considered, it will scarcely be doubted that even the simplest parts of the mucous membranes, and the whole cutaneous surface (as distinguished from its sebaceous and perspiratory glandular offsets) share largely in this important office. It is true that in the skin this function holds a subordinate place to that of defence and protection, but its existence is only an example of what an attentive survey of nature everywhere discovers; the accomplishment of various ends by means of the same simple instruments.

The notion that a secreted product must be fluid, is one that has arisen out of a partial and imperfect insight into the nature of the secreting process. Those matters which are eliminated in the largest quantities and by the largest glands are for the most part so, in the shape under which they meet the eye, that is, after their separation from the organ in which they are secreted. But in the case of the lungs the secretion is gaseous as well as fluid, and in numerous instances, which have been recently brought to light, chiefly by the labours of Henle, it is found, when minutely scrutinized, to consist of organic forms entitled to be styled solid.

The problem which physiologists have now to resolve, is how far these organic forms, which are more or less altered epithelial particles, are necessarily concerned in the performance of the function, for epithelium is all but universal in the mucous system. It would be foreign to the province of this article to enter at length on the general question of secretion, and I shall confine myself to a few remarks tending to show in what direction recent researches point.*

When the secretion of a sebaceous follicle of the skin is minutely examined, it is found to consist entirely of epithelial particles containing the sebaceous matter, and more or less broken and compressed. These are similar to the particles lining the follicle, and are mani-

* Purkinje, *Isis* 1838, No. 7. Schwann, *Froriep's* *notiz*. Feb. 1838. Henle, *Müller's Archiv*. 1838, p. 104-8, 1839, p. 45; also *Müller's Phys.* by Baly, 2nd edit., vol. i., p. 503-4.

festly the same structures, detached and matted together. The secretion found in the tubules of the testis is chiefly composed of epithelial particles resembling those attached to the basement membrane of the tubules. Some of these are very perfect, others have undergone changes. It has been already stated that the seminal animalcules are most probably a development of some of these particles, not altogether different in its nature from that of the cilia found upon them in other situations. The secretion of an ordinary mucous follicle is likewise made up of epithelial particles resembling those still attached to the membrane. The thick, semifluid mucus found in the stomach has been shown by Wasmann* to consist of rounded nucleated particles, which both in size and shape correspond with those of the stomach tubules. This mucus may be even seen projecting from the cells into which these tubules discharge themselves, and no doubt can exist that the proper secretion of this organ is chiefly composed of the bulky epithelium thrown off by the tubules; a view corroborated by the fact,† that this mucous membrane, consisting almost solely of epithelium, when mixed with certain acids naturally existing in the gastric juice, evinces the same powers of dissolving alimentary substances as that wonderful menstruum itself. The same thing may be observed in the intestinal canal, where the adhesive mucus is little else than the aggregated epithelial caps of the villi, together with that which has escaped from the vertical tubes of the membrane. These facts may be always verified in a healthy animal just killed, and may thus be shewn to be independent of any morbid action. The legitimate conclusion from them seems to be this: that the peculiar principles of these respective secretions are lodged in the epithelial particles; having been deposited there from the blood, in the natural course of development. In other words, the process of secretion in these cases consists in *an assimilation of the material from the blood by an organized tissue*, which, when fully developed, is loosened and shed.

This view, so captivating by its simplicity, has certainly much satisfactory evidence in its favour, and it may, at least, be regarded as sufficiently established to constitute a strong presumption in favour of the general position, that *all secretion is primarily assimilation*.

That the epithelial particles, when their growth is completed, should detach themselves in a more or less entire state, in all cases, from the membrane to which they have adhered, cannot be supposed essential to this general position, and even the total absence of any vestiges of these particles from any particular secretion would scarcely form a valid argument against it. For at present we know of no reason why the assimilated material should not be gradually given up by a slow disintegration or deliquescence of the particles, or even by a

continual separation of it without a concomitant destruction of the particles themselves.

But in numerous instances besides those that have been mentioned, there is more or less direct evidence of an actual shedding and continual renovation of the epithelium. The scaly variety of this tissue, whether on skin or mucous membranes, is a wide-spread example of this: the particles may be observed to augment in size by the intus-susception of new material from the blood, afterwards to undergo a slow loss of substance, and, finally, to lose their connection with the body altogether. They retain their position till nothing but the nucleus and cell-membrane remain, till they are reduced, as it were, to a mere skeleton. How the material thus separated from the body is to be distinguished from a secretion, it would not be easy to decide. In the saliva of the mouth, are present, not only detached scales, but globular nucleated particles, of a very delicate aspect and regular character, which seem manifestly to come from the salivary glands. They differ in some respects from the epithelium of these organs, but appear most probably to be particles of it altered by endosmose of the water of the secretion through the cell-membrane; for the ultimate vesicles and ducts of these glands are not merely lined, but filled, with epithelial particles, which, being thrown off from the basement membrane, must in due time escape to make room for the advancing series: and yet none of them in an unaltered state are found in the saliva.

I may in this place refer to an opinion recently entertained in Germany, that the secreting membrane of certain glands is arranged in the form of closed vesicles filled with nucleated particles, which, from time to time, are discharged, as the secretion, by the bursting of the cell in which they are contained. Henle* conceives that this arrangement exists in the mammary, salivary, and lachrymal glands, as well as in almost every mucous membrane, however apparently plain and simple. Wasmann† has described a similar structure in the middle part of the stomach of the pig. This view of the existence of closed vesicles is obviously at variance with the general view before given of the universal continuity of the simple membrane of the mucous system. I am familiar with many of the appearances on which it is founded, and without presuming to pronounce them very decidedly deceptive, I may state that hitherto my observations induce me to agree with Dr. Baly‡ in his rejection of the interpretation put upon them by the German anatomists. A thin slice of a mass of the many-lobed terminal vesicles of one of these glands, especially if compressed, very readily assumes the aspect of a congeries of cells, each entirely surrounded by an envelope of basement membrane. But I have several times, in favourable sections, observed this membrane passing off into a neck, and becoming con-

* De digestionem nonnulla. Berol. 1839.

† Müller's Archiv. 1836, page 90. Schwann, über das Wesen des Verdauungsprozesses.

* Müller's Archiv. 1839, p. xlv.

† De digestionem nonnulla. Berol. 1839.

‡ Translation of Müller's Physiology, p. 504.

tinuous with that of the duct. Such observations seem to me in a great measure conclusive on this subject; and I am strengthened in this view by the fact, that the capsules of the Malpighian bodies of the kidney are now universally considered to be perfectly closed vesicles, whereas they are in reality the expanded wall of the duct, as I have lately shown by several kinds of proof.* But whatever may be the real fact in the matter under dispute, it is admitted by all that the epithelium is formed in enormous quantities, and is being continually thrown off; which is the circumstance chiefly intended to be insisted on at present.

In the healthy bile also, in the urine, and in various other secretions Dr. Henle has met with particles of epithelium detached from the *excretory passages*, and in different stages of decay.

Turning to those two great emunctories, the liver and kidneys, in the secretions of which no trace of the epithelium of the secreting part of the organs can be detected, we might be disposed, on a slight consideration, to conclude the evidence they furnish to be unfavourable to the general position here advanced. We must, indeed, be content for the present to acknowledge that it is less plain and direct, and shrouded in our great ignorance concerning the play of chemical affinities in living bodies; but still it is too interesting and important to be passed over in silence. Though the epithelium of these organs be not detached entire, as in many other cases, there is much, in each instance, to explain the discrepancy consistently with the theory in question.

I have described the lobules of the *liver* as consisting of a solid plexus of capillary bloodvessels, in the meshes of which is a congeries of epithelial particles. We possess no accurate account of the mode of termination of the biliary ducts; but it seems clear, from the small meshes of the vascular plexus being completely filled by the epithelium, that no true ducts, i. e. tubes, penetrate the substance of the lobules: the tubular ducts probably commence on the surface of the lobules. The epithelium of the lobules is doubtless continuous with that of the ducts, but the cavity of the ducts and their basement membrane terminate at the surface of each lobule. Though the cavity of the ducts be not continued within the lobule, yet it is very possible that injection urged along the ducts might insinuate itself by the side of the epithelium into the interstices of the vascular plexus, and thus, like the epithelium itself, form a solid plexus within the lobule. This appearance probably led Mr. Kiernan to describe the termination of the ducts as forming a plexus within the lobule, the *lobular biliary plexus*. And this description must be allowed to be essentially correct; for although the cavity of the duct cease at the surface, the epithelium of the lobule is, in respect of function, its real continuation. I have further observed, that although the epithe-

lium of the lobule has, on the whole, a plexiform arrangement, yet its particles in some measure affect a radiating direction from the central axis towards the circumference, perhaps towards certain parts only; and when a lobule is broken up by violence, the resulting fragments of epithelium are apt to consist of a linear series of particles. Many of the particles, too, are smaller than the rest, and have all the appearance of having been recently formed and as yet incompletely developed. It is also remarkable that the particles should contain granules of oily matter in their interior; for although chemical analysis has detected differences between this substance and cholesterine,* yet as the chief peculiar principles of the bile are forms of hydro-carbon, the coincidence cannot be an accidental one. It is not contended that the contents of these particles are the finished secretion, but rather that their chemical constitution undergoes some modifications during the disintegrating process. And it is worthy of notice, that in many cases where the decarbonizing function of the lungs is slowly but greatly interfered with, as in phthisis pulmonalis, and where the liver is consequently called into increased activity as a compensating organ, these oily globules exist in such abundance and size as to gorge and swell the particles (and therefore the whole viscus) to nearly double their natural bulk.† But this is not all the evidence, that this epithelium is the source of the bile. I am informed by my friend, Dr. W. Budd, that Dr. Henle in his recent edition of Söemmering, of which I have not yet been able to obtain a copy, describes the epithelial particles as appearing yellow or yellowish brown in direct light, and as probably containing bile. He also states that the presence of the fatty globules in the epithelium is inconstant, and corresponds with the varying fatty contents of the bile. He is unable at present to determine in what manner the contents of the particles find their way into the ducts.

The foregoing facts, taken together, afford a very strong presumption that the epithelial particles of the lobules are the agent assimilating the secretion from the blood. It would be still more satisfactory if particles could be found undergoing decay. Meanwhile it seems impossible to assign to them any other office, if it be granted that the sole function of the liver is to secrete bile. For in the case of other glands, the only other use that can with any degree of plausibility be attributed to the epithelium is that of its serving to defend the secreting membrane from the contact of the secretion, and to prevent the latter from re-entering the blood. And it cannot exist for that purpose in the liver, because it is itself the only structure besides the bloodvessels, and does not constitute a lining membrane.

The peculiarity in the minute structure of the *kidneys*, which bears on the present question, is of a kind entirely different from any presented by the liver, and yet tends to establish a similar conclusion. It consists of a special

* Kuehn, *Kastner's Archiv.* xiii. p. 337.

† A author in *Lancet*, Jan. 1842.

* *Phil. Trans.* 1842, Pt. I. p. 59.

apparatus at the extremity of each secreting tube, apparently designed to furnish a flow of water down the canal.* A large quantity of water is evidently required in this secretion as a menstruum for the salts and proximate principles it contains; and there is no doubt, from the analogy of other glands, that the walls of the tubes are the membrane secreting these substances. Now the epithelium constitutes at least $\frac{1}{3}$ of their thickness, and is the only part of them with which the water can come into contact. It therefore seems highly probable that this fluid is provided in the manner described, in order to dissolve, out of the epithelial particles, the peculiar principles which they have previously assimilated from the blood.

In support of this general position it may be observed, further, 1. That the epithelium, which constitutes so large a portion of the true glands, is solid and bulky, usually characterized by its finely granular texture, and in this respect contrasts strongly with that lining the vascular system, which is of extreme delicacy and transparency. The exceptions to this remark confirm its importance. In the air-cells of the lungs, the secretions of which are gaseous and not solid, the epithelium is of great tenacity, and in the Malpighian capsules of the kidney, which appear to serve principally as receptacles for the aqueous fluid that escapes from the bare capillaries within them, this structure is either wanting or consists of perfectly transparent particles. In many intermediate varieties, too, there appears traceable a correspondence between the bulk of the nucleated particles and the activity of the secreting function; of which the scaly form in general may be mentioned as an instance. 2. That many peculiar substances are secreted into the interior of nucleated cells, although prevented, by the position of those cells, from escaping from the body. Such are various fats and fixed oils, colouring matters, &c. 3. That this function of abstracting somewhat from the blood, and elaborating it, seems the most probable one that can be assigned to the thymus and thyroid bodies, the spleen, and supra-renal capsules, and specially to the nucleated particles forming so large a portion of these several structures. On the whole there seems much weight of evidence in favour of the proposition "that secretion is a function very nearly allied to ordinary growth and nutrition: that whereas these are a combination of two functions, assimilation of new particles and rejection of old, the old being reconveyed into the blood, secretion consists in a corresponding assimilation and rejection, but the old particles are at once thrown off from the system without re-entering the blood. According to this view, all effete material received into the blood, from the old substance of the various organs, must be re-assimilated by an organized tissue, specially designed for the purpose, viz. the epithelium, before it can be eliminated: and all substances

thrown off from the system, but designed for an ulterior purpose, must in like manner be assimilated in order to their separation." It places in a strong light a principle of great importance in physiology, the subordination of the bloodvessels and their contents to the tissues among which they are distributed.

The function of secretion may therefore be considered to be universal over the mucous system, and its different activity in various situations to be dependent on, as it certainly is closely associated with, differences in the arrangement and structure of the epithelial element. The basement membrane, from being absent from the lobules of the liver, seems a tissue of inferior (perhaps of no) importance in respect of this function, and probably is chiefly subservient, wherever it exists, to the mechanical support of the epithelium.

There are probably *three ways* in which the secretions are finally separated from the body: and these three ways appear to have a reference to the chemical qualities of the product, and to their effete or non-effete character. 1. The particles assimilated into the nucleated cell may be thrown off by virtue of minute chemical changes occurring in it, without the cell itself being altered in form. In this case the nucleated cells will be permanent, or only very slowly renewed, and the secretion will be formed, or at least perfected, by the passage of its elements through the cells. 2. The nucleated cells, as they arrive at their full size, may undergo a slow change in the arrangement of their elements, and gradually disappear by a kind of solution or deliquescence, thus forming the secretion. 3. The nucleated cells, when mature, may be cast off at once, and entire, with their contents. The two last modes are attended with a continual formation of new cells.

It would appear that, in general, where the secretion is formed by the rejected chemical elements of the cells (1), or by the destructive solution of the cells (2), it is *effete*; but that, when formed chiefly by the separation of cells that are mature and contain much organic matter (3), it is *destined for ulterior purposes in the economy*. Of the first the kidney seems to be an example, of the second the liver, of the third the lining membrane of the stomach.

The varieties in the *qualities* of the products secreted by different portions of the mucous system are only referrible to varieties in the elective powers of the tracts which respectively furnish them, and admit of being most readily explained by the view of the nature of secretion already advanced. It is unnecessary, in this place, to enter on a particular description of the boundaries of these several tracts, and I shall only offer a few observations on the nature and extent of that secretion which has given its name to the structures here treated of.

The term *mucus*, like so many others transmitted from an early period, was originally employed to denote an exaggerated and partial condition, was subsequently applied more loosely and widely in a generic sense, and now requires to be reduced to a more definite

* Phil. Trans. Pt. I. 1842, p. 73. See also the article REN.

application in accordance with that necessity for precision of thought and expression which characterizes modern science. The exposition contained in the article *Mucus* will render it superfluous for me to define its present acceptation. It is denied by Dr. Gruby that the viscid form of mucus is a normal secretion from any membrane whatever, and he considers its existence as a certain mark of diseased action. This view, if less absolute, would be in a great measure correct, since there is no doubt that in a state of perfect health most mucous surfaces are wholly unprovided with any protection of this kind. If the nasal cavities, the trachea or bronchia, the intestinal or urino-genital tracts, be examined in a healthy animal killed for the purpose, we may search in vain for any slimy covering, such as they are commonly imagined to possess. But in a state of disease, each of these surfaces will secrete great quantities; and it is not a little remarkable, that, even when healthy, if moistened and allowed to undergo slight putrefaction, they will become coated with a viscid fluid, having the physical characters of mucus. Yet the slimy fluid of the mouth cannot with propriety be considered abnormal. The true saliva is not viscid, as it escapes from the ducts of the glands into the cavity of the mouth: it probably becomes so by dissolving the substance derived from the scales of epithelium lining the mouth, as they advance to the surface and flatten. The fluid of ranula is not merely the accumulation of a natural secretion, but seems gradually to acquire its great viscosity by receiving the debris of the epithelium lining the excreting channels, and by the partial reabsorption of its aqueous portion.

In the intestinal canal, however, although there is no viscid mucus naturally present, yet there is a large amount of "inrippsated mucus" being continually separated from the villi and follicles of Lieberkuhn. This mucus, as already mentioned, is nothing more than the debris of epithelial particles.

But chemists have detected, in most of the secretions, a small proportion of a substance nearly allied to mucus, and probably a form of it. There is good reason to believe this to be the product of the membrane lining the excretory passages, and to represent the old epithelium of that membrane. Where the secretion of the gland is fluid and in considerable quantity, it seems to be sufficient to convey away this debris from the surface which it traverses on its way out of the system, as in the salivary and allied glands, the liver, kidney, &c. But where, from the absence of this means of carrying off the debris of the epithelium, it might be supposed to be liable to accumulate and clog the surface, cilia are developed; of which the best example is furnished by the respiratory tract, the nasal cavities, and the tympana. That this is the great office of these wonderful organs upon these extensive surfaces appears to be proved by the fact that the currents they produce are uniformly towards an outlet. Hæmle has observed this in several parts, and I have ascer-

tained it by experiment in the case of the tracheal and bronchial membrane.

In this tract no secretion is visible with the naked eye, but with the aid of the microscope I have found, in perfectly recent animals, minute globules of extreme tenuity and of various sizes, which had all the appearance of mucus oozing from the interstices of the epithelial particles. It is impossible but that the cilia should move these globules along the surface, and discharge them into the pharynx; and it hardly admits of doubt that mucus, morbidly existing on the bronchial membrane, is gradually lifted up by these untiring agents to that region where it excites coughing, and is forcibly expelled by the rush of air. The patient is often conscious of its slow motion upwards, when it is in the form of a pellet and proceeds from an isolated spot. This is remarkably the case too in hæmoptysis, and also in that rare disease the bronchial polypus, where branched tubes of lymph are brought up in this manner.

This view of the use of cilia in the mucous system of the higher animals appears to me to merit much attention. I had intended to have considered it under a separate head, but it has been introduced here both in corroboration of the general position as to the nature of secretion, and in illustration of the nature and extent of the special secretion from the ordinary mucous membranes.

On the whole I think it may be concluded:

1. That every part of the mucous system, where epithelium exists, secretes.
2. That the secretion differs, in different regions, according to the vital properties of their epithelia; and that these vital properties are usually attended with appreciable varieties of structure. That corresponding varieties of chemical constitution coexist with these is highly probable, though only as yet proved in a few cases.

3. That mucus is the least peculiar of the secretions, yet by no means universal from the mucous membranes, but confined to tracts of comparatively limited superficial extent, chiefly the excretory channels of the glands.

In the preceding summary account of the structure, relations, and offices of the mucous system, I have not been able (without interruption to the course of the description) to refer sufficiently to the labours of those anatomists to whom we owe almost all our knowledge of the subject. This deficiency, of which I am very sensible, I shall endeavour in some degree to supply by a brief review of the researches which have led to the more modern and general views on the subject. Passing over the imperfect descriptions of the ancients, we find that when the microscope first became an instrument of anatomical research, the scaly character of the cuticle was recognised by Malpighi and Leeuwenhoek; and that the former of these great anatomists had a wonderfully clear insight, considering the period at which he lived, into the close relation that subsists between the glands, mucous membranes, and skin. The labours of the anatomists of the next age were spent with great success upon matters of detail,

particularly on the distribution of the blood-vessels, which Ruysch and Lieberkühn particularly illustrated; and, by the general advance of knowledge, the way was being gradually prepared towards that more philosophical arrangement of the tissues of the body, in conformity with their intimate texture and connexions, of which the first example is to be found in the work of Bonn,* already alluded to. He here traces, with great accuracy, the continuity of the skin and mucous membranes at the different orifices of the body, and he clearly recognises their close structural relation, considering the mucous membranes to be productions of the skin. To our countryman, Dr. Carmichael Smith,† we are indebted for the first application of this arrangement to the purposes of pathological classification, and Pinel soon after followed in the same track.‡

But a new era dates from the remarkable works of Bichat,§ in which he delineated the structure, vital and other properties, and the relations of the different tissues of the body, and arranged them on a basis, which, though faulty in some of its details, has received no essential modification in its principles since his time, and entitles him to the praise of rare genius and sagacity. He seems to have clearly perceived the true connexion that exists between the skin, mucous membranes, and glands, although he failed to carry out his views into the subdivisions of his system, where he was still fettered by the crude notions of his predecessors. One of the most remarkable features in his work, bearing on the present subject, is the analogy he draws between the epidermis of the skin and the mucus of mucous membranes, an analogy which he discovered with the eye of the mind, which has been since often rejected, but which can now be shewn to be real by the eye of sense.

Most writers of eminence since the time of Bichat have adopted the principal part of his views, and some have advanced further towards a full recognition of the homology of the skin, mucous membranes, and glands, among whom must be mentioned, in particular, J. Müller, whose classical work on the glands,|| published in 1830, placed him at once in the foremost rank among the anatomists of our own day.

Subsequently to that date, the improvements in the construction of the microscope and the consequent employment of greater magnifying powers, have added an extraordinary stimulus to anatomical and physiological studies, and directed a host of inquirers into an almost unexplored field, from which the harvests already reaped give the most favourable earnest of future and rapid additions to the stores of knowledge. To the Germans is unequivocally due the merit of having far outstripped all other nations in the honourable

path thus opened, and in no collateral path of inquiry which has been pursued to the same extent, has so much new, interesting, and important information of an accurate and satisfactory character, been obtained, as in that which it has been my duty to treat of in the present article. The names of Purkinje, Valentin, Henle, and Schwann deserve primary honour in this place, and to these may be added those of Ehrenberg, Treviranus, R. Wagner, Boehm, Wasmann, Gruby, and Gerber. Among the French anatomists, MM. Turpin, Mandl, and Donné have contributed much, and our own countrymen have not been behind. Dr. Sharpey, Dr. Sprott Boyd, Dr. Todd, Mr. Nasmyth, Dr. Barry, and Mr. Toynebee, are all distinguished in this field of research.*

In the present article I have endeavoured to combine with all the authentic information I could obtain from these sources, the results to which I have been brought by a two-years' study of the anatomical characters of the whole mucous system. So rapid, however, are the daily advances of knowledge, that it is possible much has been omitted which is already in some shape before the public, and, on the other hand, that a few years may greatly modify the general views that are here set forth. As the anatomical details, however, have been all substantiated by my own observations, except where otherwise stated, I am enabled to speak with more confidence of their correctness.

BIBLIOGRAPHY.—(See also the list of works appended to the articles GLAND and SKIN.)—*Marcellus Malpighius*, De viscerum structurâ. Op. omnia, Lond. 1687. *Peyer*, De gland. intest. Amstel. 1681. *J. C. Brunner*, De glandulis duodeni, Francofurt. 1715. *Lieberkühn*, De fabricâ et act. vill. intest. hom. Lugd. Bat. 1744, 4to. *Haller*, Elementa Physiol. lib. xi. Bonn, Specimen Anatomico-Medicum, &c. exstat in Sandifort. Thesaurus, vol. ii. Roterodami, 1769, xii. p. 265. *Carmichael Smith*, In transactions of a Soc. for promoting Med. Knowl. vol. ii. Lond. 1790. *Soemmering*, Baue des Menschlichen Körpers. Frankfurt a M. 1791. *R. A. Hedwig*, Disquis. Ampull. Lieberkühnii physico-microsc. Lipsiæ, 1797, 4to. *Pinel*, Nosographie philosophique, Paris, 1798. *X. Bichat*, Traité des Membranes, Paris, 1800; Anatomie générale, 1801. *K. A. Rudolphi*, Progr. de humani corporis partibus simil. 4to. Gryph. 1809. *J. F. Meckel*, Handbuch der Menschlichen Anatomie, Bd. 1. Halle, 1815. *C. Mayer*, über Histologie u. eine neue Eintheilung der Gewebe des Menschlichen Körpers, 8vo, Bonn, 1818. *H. Buerger*, Examen Microsc. vill. intest. Halæ, 1819. *F. A. Béchard*, Elémens d'anatomie générale, 8vo. Paris, 1825. *Billard*, De la membrane muqueuse gastro-intestinale, &c. 8vo. Paris, 1825. *Craigie*, Elémens of general and pathological anatomy, Edinb. 1828. *Doellinger*, De vasis sanguiferis quæ villis intestinorum, &c. insunt, Moenchii, 1828. *E. H. Weber*, Hildebrandt's Anatomie, 1830. *J. Müller*, De glandul. secretantium structurâ penitiori, Lipsiæ, 1830; and, in English, *Mr. Solly's* abridged translation. *G. Breschet*, Ann. des Sciences Nat. 1834. *Purkinje & Valentin*, Commentatio physiologica de phenom. motûs vibratorii continui, &c. 4to. Wratislav. 1835. Isis, 1838, No. 7. *Boehm*,

* De continuationibus Membranarum. Roterod. 1769.

† Medical Communications, vol. ii. London, 1790.

‡ Nosographie Philosophique. Paris, 1798.

§ Traité des Membranes, 1800. Anatomie Générale, 1801.

|| De Glandularum secretantium structurâ penitiori. Lipsiæ, 1830.

* To these must now be added Mr. Goodsir, who, in a paper (of which an abstract has been just published) read at the Royal Society of Edinburgh on the 30th March, supports the view of secretion here given, with several new proofs. See Lond. and Edin. Monthly Journal of Med. Science, May, 1842.

De Gland. intest. struct. penitiori, Berol. 1835. *Gurlt*, Müller's Archiv. 1835, page 399,—1836, page 263. *Spratt Boyd*, Inaugural Essay on the structure of the mucous membrane of the stomach, Edinb. 1836. *Krause*, Müller's Archiv. 1837, p. 8. *Henle*, Symbolæ ad anatomiam villorum intest. imprimis eorum epithelii et vasorum lacteorum, Berol. 1837. *Hufeland's Journal*, 1838. Müller's Archiv. 1838, p. 103. Ibid. 1839. Heft iii. p. xxxi.—Heft iv. p. xiv. *Valentin*, Repertor. 1838, p. 310. *Wasmann*, De digestionem nonnulla. Dissert. Inaug. Berol. 1839, and *Froriep's Notizen*, April, 1839. *Müller's Physiology* by *Baly*, London, 1837-41, vol. i. 2d edit. 1839, p. 477-503, et seq. *Schwann*, *Froriep's Notiz*. Feb. 1838: 'Mikrosk. Untersuchung. Berol. 1839. *R. B. Todd*, Lectures on the mucous membrane of the stomach and intestinal canal, Med. Gaz. 1839 and 1842. *Gerber*, General anatomy by *Gulliver*, Lond. 1841. *A. Namyth*, Three memoirs on the teeth and epithelium, Lond. 1841. *Toynbee*, On non-vascular animal tissues, Phil. Trans. 1841, part ii. *Martin Barry*, On the corpuscles of the blood, Phil. Trans. part ii. 1840, parts i. & ii. 1841. *Mandl*, Anatomie microscopique, Paris, 1839-41. *Gruby*, Observ. microscopica, Viennæ, 1841.

(*W. Bowman.*)

MUSCLE.—(Syn. *Mūs*, *Musculus*, Muscular or Sarcous tissue; *vulgo*, Flesh, Meat.) This term is applied to certain fibrous contractile organs, either elongated and fixed at their two extremities, or hollow and enclosing a cavity, which in all the higher animals are the seat of the power by which locomotion, circulation, the prehension and passage of food, the expulsion of many of the excretions and of the young, as well as other diversified functions, are performed. It is also used to denote the peculiar contractile material or tissue, constituting the principal and essential portion of such organs. This tissue is always arranged in the form of fibres, which in many minute animals occur singly, each serving the purpose of a perfect muscle. But they are usually aggregated in very great numbers, surrounded with a network of capillary vessels, and connected to one another by areolar tissue. The nervous tissue is universally associated with the muscular, however small may be the quantity of the latter; it is through this that the stimulus to contract is ordinarily transmitted, and, when the mass is great, made to affect simultaneously many contiguous fibres. A muscle is the organ resulting from the union of these several parts.

Muscles are styled voluntary or involuntary, according as they are, or are not, subject to the influence of volition, and they have been usually so classified. But, however convenient these terms may be in the ordinary language of physiology, they cannot be applied, in a strict sense, to the purposes of classification without obvious objections. Many muscles, especially those under the immediate dominance of reflex nervous action, (as the respiratory and sphincter muscles,) partake of both characters, since volition can interfere only temporarily with their contraction; and all muscles, even the most confessedly voluntary, are subject to emotional and instinctive influences, in which the will has no share. The attempt to introduce an intermediate or mixed class, which has been generally sanctioned,

while it is an acknowledgment of the imperfection of the arrangement, does not appear to be sufficiently warranted either on anatomical or physiological grounds. If subjection or non-subjection to the influence of the will be made the basis of classification, all muscles should be accounted *voluntary* on which this can exercise a direct influence either in causing or controlling contraction, even though such influence be but momentary, and capable of being exerted only while the stimulus excitive of involuntary action is in abeyance.

The voluntary muscles are generally solid organs, while the involuntary are hollow; and, on recurring to the minute structure of their respective elementary fibres, we detect very striking differences between them, those of the former being striped crosswise with very delicate and close parallel lines, which, with some exceptions, are altogether absent from the latter. But these exceptions are of so important a kind as to demonstrate beyond doubt that there is no necessary connexion between the minute conformation of the fibres and their relation to the influence of the will. The muscular coat of the œsophagus often displays the striped structure as far down as the stomach, though the will has no power whatever over its movements; and the heart itself is composed of striped fibres. As the structural differences between these two kinds of fibre are constant, well-marked, and therefore easily ascertained, and as they seem, moreover, to be related to varieties in the activity and mode of exercise of their contractile power, they will be employed as the ground of division in the present article.

I shall first describe the minute anatomy of these two kinds of elementary fibre, and the steps of their development; and, secondly, I shall advert to their mode of aggregation and to the arrangement of the tissues found in connection with them.

a. Of the striped elementary fibres.—These have received the name of Primitive Fasciculi on the erroneous supposition of their being bundles of finer filaments. They may be separated from the tissues associated with them in the compound organ by a variety of means, but as they always constitute the principal mass of the organ, they may be examined without any attempt at such separation. It was a favourite plan with the older anatomists to obtain the fibres apart by submitting them to a long boiling, which destroys the texture of the vessels and filamentary tissue, but at the same time considerably modifies the size, shape, and structure of the fibres. It is in general only requisite to take a small portion of a muscle, as fresh as possible, (but after its contractility has departed,) and to tear it, under water, into fine shreds, with needles. By these means the elementary fibres will be separated from one another, and being in parts irregularly broken, and torn, can be submitted to inspection under a high power of the microscope, in such a condition as to exhibit most of the important points in their structure. Many sedulous examinations of specimens from various sources are requisite for the acquirement of a correct idea of their

organization and properties, but that this simple method of procedure is the one most likely to lead to a true insight and conclusion regarding the anatomy, not only of this but of all elementary structures, becomes every day more evident. Various subsidiary means may doubtless be employed with advantage, such as injections and physical and chemical agencies; but the method which of all others is the least liable to admit of erroneous interpretations by the admixture of artificial elements in which the mind of the inquirer has had a share, is that of employing a power capable of reaching the utmost limits of organization, on examples the most nearly approaching to their natural state during life.

There is perhaps no one line of inquiry in the whole range of minute anatomy so beset with difficulties and sources of error, and therefore so much demanding a cautious study and sagacious discrimination between conflicting appearances, as this of the structure of the striped fibre. The following description is substantially the same as that published by me in the Philosophical Transactions, 1840, and which all my subsequent observations have tended to confirm. To that paper I would venture to refer those who may desire to enter at greater length upon the grounds of the view here summarily given.

1. *Length.*—This varies exceedingly in different muscles. The sartorius, the longest in the body, often surpasses two feet in length, and the individual fibres are as long, extending in parallel bundles from end to end. In many others they do not exceed a quarter of an inch; thus their greatest variety is presented in their length.

2. *Thickness.*—This should be examined in the uncontracted state of the fibre, which for this purpose should be removed from the body after all contractility has departed. I have elsewhere* given a table of numerous comparative measurements in various animals, and subjoin the following abstract:—

Diameter of the elementary fibres of striped muscle in fractions of an English inch.

	From to		average	
Human	$\frac{1}{213}$	$\frac{1}{192}$	of males	$\frac{1}{352}$
			of females	$\frac{1}{457}$
Other Mammalia	$\frac{1}{1100}$	$\frac{1}{1025}$	average	$\frac{1}{367}$
Birds	$\frac{1}{1500}$	$\frac{1}{350}$	"	$\frac{1}{807}$
Reptiles	$\frac{1}{1000}$	$\frac{1}{100}$	"	$\frac{1}{281}$
Fish	$\frac{1}{753}$	$\frac{1}{53}$	"	$\frac{1}{222}$
Insects	$\frac{1}{753}$	$\frac{1}{305}$	"	$\frac{1}{479}$

I believe that the average diameter of the fibres in the human female is upwards of a fourth less than in the male, and that the average of both together is greater than that of other Mammalia; but a more extensive examination is requisite to establish this. Fish have fibres nearly four times thicker than those of Birds, which have the smallest of all animals. Next to Fish come Insects, then Reptiles, then Mammalia. In each of these different classes, however, an extensive range of bulk is observable, not only in the different genera, but in the same animal and the same muscle, some fibres being occasionally three, four, or more times

the width of others. In general the fibres of the heart are smaller than those of other striped muscles. The varieties in the average bulk in different classes have a close connection with differences of nutrition and of their irritability, which will be reverted to.

3. *Figure.*—This is subject to some variety, depending on their number and manner of package. Sometimes, as in some parts of Insects, they are flattened; but when they are isolated, or loosely aggregated, they are more or less cylindrical. In all the cases, however, where many fibres are arranged side by side, as in the Vertebrata, the larger Insects, and Crustacea, they are irregularly polygonal, the contiguous sides being flattened, evidently from the effect of package. Yet some interspaces are always left for the passage of bloodvessels, nerves, and areolar tissue among and between them. Their form may be most readily displayed by a transverse section of a muscle that has been dried *en masse*, as long ago shown by Leeuwenhoeck (*fig.* 286).

4. *Colour.*—The colour of muscle depends partly on the colour of its elementary fibres, partly on the blood contained in its vessels, and there is strong reason to believe that the colouring matter of both is the same, or nearly so. That the fibres have always a colour of their own is at once evident on inspection under the microscope. It is generally more or less of a reddish-brown, but varies much in different animals and in different muscles, and even in the same muscle according to its state of development and activity. In Reptiles and Fish generally, and in Crustacea, the flesh is white, sometimes pinkish, but in some fishes, as the Gurnard, the gill-muscles are red. These varieties of colour are attended with none of structure. In Birds the colour varies much, being often white and deep red in the same animal, but generally the pectoral muscles are very dark.

Fig. 286.

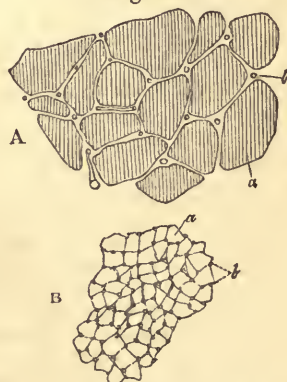

Transverse sections of striped muscle that had been injected and dried, magnified 70 diameters.

A, from the Frog.

B, from the Dog.

a, a, section of elementary fibres, shewing their angular form and various size.

b, b, sections of the injected capillaries, shewing the position they occupy among the fibres.

These figures shew the greater vascularity of the muscle with the narrower elementary fibres.

* Philosophical Transactions, 1840, p. 460.

The most deeply coloured muscle I have seen was the great pectoral muscle of the Teal (*Querquedula crecca*), killed after migration. In Mammalia the colour is ordinarily red, being deeper in the Carnivora than in the vegetable feeders. Among the domestic animals many varieties exist, which need not be specially enumerated. A considerable part of the colouring matter is extracted by repeated washing of a muscle, which then becomes pale, but not quite colourless; some part of the loss of colour here sustained is doubtless owing to the solution of the hæmosine of the blood contained in it. A muscle, if hypertrophied, grows redder, and vice versa; and probably the practice of bleeding calves some days before they are killed, makes their flesh more pale and tender, by causing the absorption of a portion of the proper colouring matter of the fibres, as well as by abstracting the blood circulating among them.

5. *Internal structure.*—Though the elementary fibres of all animals are visible to the naked eye, and in some animals, as the Skate (*Raia Batus*), are often as thick as a small pin, nothing of their internal organization can be distinguished without the aid of a powerful lens. There is indeed, in certain lights, a splendid pearly iridescence, resulting from the arrangement of their structure, and quite characteristic among the soft tissues; but this is not explained till a high power of the microscope is brought to bear upon the fibres. They are then seen, when viewed on the side, to be marked by innumerable alternate light and dark lines, whose delicacy and regularity nothing can surpass, and which take a parallel direction across them; and if the focus be altered so as to penetrate the fibre, they are found to be present within it just as on its surface, thus differing from those on the tracheæ of insects, which exist only at the surface. At the extreme border of the fibre the light lines are sometimes seen to project a trifling degree more than the dark ones, thus giving a slight scallop, or regular indentation, to the edge. If often happens, in tearing the fibres roughly with needles before examination, that they crack across, or give way entirely, along one or several of these dark lines, the line of fracture or cleavage running more or less completely through the fibre in a plane at right angles with its axis; and occasionally two or more of such complete cleavages will occur close together, the result of which is the separation of so many plates or discs (fig. 287, B), of which the light lines at the surface are the edges, and the corresponding light lines seen within are what may be termed the focal sections. Thus it is evident that there is a tendency in the mass of the fibre to separate, when torn or pulled after death, along the transverse planes, of which the dark transverse stripes are the edges. When such a separation takes place, a series of discs result, but to say that the fibre is a mere pile of discs is incorrect, for the discs are only formed by its disintegration. Nevertheless they are marked out, and their number and form are imprinted, in the very structure of the fibre, in its perfect state. (Figs. 287 and 288.)

Fig. 287.



Fragments of striped elementary fibres, showing a cleavage in opposite directions, magnified 300 diam.

A, longitudinal cleavage.

At *a* the longitudinal and transverse lines are both seen. Some longitudinal lines are darker and wider than the rest, and are not continuous from end to end.

b, primitive fibrillæ, separated from one another by violence at the broken end of the fibre, and marked by transverse lines equal in width to those at *a*.

c represents two appearances commonly presented by the separated single fibrillæ. On the upper one the borders and transverse lines are all perfectly rectilinear, and the included spaces perfectly rectangular. In the lower the borders are scalloped, the spaces bead-like. When most distinct and definite, the fibrilla presents the former of these appearances.

B, transverse cleavage. The longitudinal lines are scarcely visible.

a, incomplete fracture following the opposite surfaces of a disc, which stretches across the interval and retains the two fragments in connexion. The edge and surface of this disc are seen to be minutely granular, the granules corresponding in size to the thickness of the disc and to the distance between the faint longitudinal lines.

b, another disc nearly detached.

But again, it always happens that longitudinal lines, more or less continuous and parallel, according to the integrity of the fibre and the strength and distinctness of the transverse lines, are also to be discerned; and like the transverse ones, not on the surface only, but throughout the whole of its interior. And it is found that there is a remarkable proneness in the fibre to split in the direction indicated by these lines also; by which splitting it is resolved into a great number of fibrillæ. These fibrillæ, like the discs, do not exist as such in the fibre, and to obtain them its structure must be necessarily broken up to a certain extent, for the union which naturally subsists between these parts must be destroyed. It is therefore most correct to say that there is an indication in the entire state of the fibre of a longitudinal arrangement of its parts, occasioning a cleavage in that direction on the application of violence. (Fig. 287.)

Sometimes the fibre will split into discs only, more often into fibrillæ only, but there are always present in it the transverse and the longitudinal lines which mark the two cleavages. It is the most common to find a crack or fracture taking both directions irregularly, running partly in the transverse dark lines,

partly in the longitudinal dark lines, sometimes being crosswise on the exterior, more or less lengthwise within. These cracks are often short, even, well defined; at other times the parts near them are much stretched, or quite disorganized,—differences depending on the brittleness or toughness of the particular fibre, which qualities vary very much in different specimens, according to the state of nutrition, period of examination, and other circumstances.

Hence it is clear that the *discs* and *fibrilla* consist of the same parts, and merely result from the different direction in which the mass breaks up. To detach a fibrilla entire is to remove a particle from every disc, and to take away a disc is to abstract a particle of every fibrilla. Thus, every disc consists of a particle of every fibrilla, and every fibrilla of a particle of every disc. Therefore every fibrilla of the same fibre has the same number of particles, and every disc in like manner is composed of the same number of particles.

If, now, isolated discs and fibrillæ be examined under a high magnifying power, they will be found to bear out, in the fullest manner, the description that has been given. The discs are marked on the edge by the fragments of the longitudinal lines, and if regarded on their flat surface, present a finely granular appearance, the granules being equal in diameter with the fibrillæ (*fig. 288*). In fact, the dark lines be-

Fig. 288. Surface of a disc separated from an elementary fibre of a Lizard which had lain long in spirit. It displays the finely granular structure spoken of in the text. The granules are intended to be represented equal in size. Magnified 500 diam.



tween the granules are the fragments of the longitudinal lines of the interior of the fibre. Again, the fibrillæ, whether taken from the surface or from the interior, are always found to be marked at intervals by transverse dark lines, which are nothing more than the fragments of the transverse lines seen on and in the fibre. They uniformly correspond with them in distance and force (*fig. 287, c*). Thus, whether the fibre cleave crosswise or lengthwise, the resulting fragments bear in their structure their respective portions of the lines, taking an opposite course, and evincing a co-existent arrangement in the opposite direction; and when a detached disc or fibrilla is itself broken, the fracture follows the lines thus imprinted in its structure.

It remains to inquire, what is the nature and meaning of the dark lines so often mentioned?

They can be best examined in the separated discs or fibrillæ; and they appear to be undoubtedly the results of an unequal refraction of the light transmitted through the object. The light spaces intercepted between them, and which by their union constitute the discs and fibrillæ, have the aspect of small lenses or particles of higher refractive power than the connecting material, which consequently is in darkness when the inclosed spaces are in focus. By placing the object out of focus, however,

the light and dark parts are reversed, which is precisely what occurs with true lenses. I have had a series of beaded rods of glass constructed, which have exactly the same appearance as the fibrillæ; and when two of these are regarded between the observer and the window, one being in front of the other, and their beads corresponding, the dark circumferences, visible round the beads of each rod when seen separately, are found to be converted into transverse bars, crossing the rods at right angles in the interval of the beads; or, in other words, forming the elements of the transverse stripes.

My friend, Dr. Gruby, of Vienna, informed me that he had had spiral rods of glass constructed, which, when placed in front of one another, have the same appearance as that often met with in the fibres, and he conceives the fibrillæ to be, consequently, spiral threads: an opinion advanced by Muys, to explain the phenomenon of contraction, but unnecessary for that purpose, and which is quite at variance with all I have observed on the subject. Such spiral rods, however apposed, can never present lines *absolutely* transverse, such as *always exist on the unmutated fibre, and generally on the detached fibrillæ*; and the minute zig-zags the stripes so often form, and which might, if constant, be possibly explained by the notion of spiral rods, are the mere result of a stretching and disturbance of the direction of the axes of the particles composing the discs and fibrillæ. But the cleavage of the fibre into discs is especially opposed to the idea of a spiral form of each fibrilla.

I think it is clear that the dark lines in both directions are not occasioned by a difference of colour, but solely by a variety in refraction; but on what this difference in refraction depends it is more difficult to explain. Is the connecting material of a different refractive power, or of the same nature as the particles it unites? If of the same nature, it must be of smaller dimensions, and minute interspaces must be left; but of the existence of such interspaces there is no conclusive evidence. It seems more probable that the connecting material is less dense, and fills up every interval; but I do not pretend to determine what may be its nature, or whether it differs chemically from the parts it serves to join.

It is remarkable that the direction of the cleavage should vary so much in different specimens, without it being possible to say on what the variety depends: and the question has still to be determined, whether the transverse and longitudinal modes of union between the particles are the same. It is most likely that they are, and the differences in the regularity and breadth of the transverse and longitudinal lines are easily explained on that supposition.

The transverse dark intervals between the particles, being all ranged on the same plane, the edge of which is directed to the observer, when he looks on the side of a fibre, appear as a sharp line, while the longitudinal dark intervals not being on a plane, are seen irre-

gularly one in front of the other, as a little consideration will shew. Hence the latter seldom seem so definite or regular as the former. Nevertheless their union, seen on the surface of a detached disc, often presents much regularity, and forms curved or straight lines, such as result when a number of balls of equal size are huddled together on a level.

It may be concluded from what has now been advanced, that the discs and fibrillæ, (or, in other words, the general mass of the fibre,) are made up of a number of particles, which I have termed *primitive particles*, or *sarcous elements*, and which would be obtained in a detached form by a general separation occurring along the transverse and longitudinal lines visible in the fibre. The existence of these particles, as well as their form and size, is indicated in the structure of the fibre, while yet entire; but they are united together, and have no independent existence, each being by its very nature a part of the mass, which is rendered incomplete by the removal of a single element. It results also from this description that these particles have no definite outline on all their aspects, being united together; and that they only obtain such an outline on being severed; on which account it is perhaps impossible to say whether, in the perfect fibre, they be rounded, square, or polygonal.

An example of the strong lateral union of these particles to one another was presented by the specimen from which the following sketch was taken. It consisted of two or three elementary fibres from the leg of a newly-born rabbit, which had been kept for some months in weak spirit. They were lying in a curved form on the field of the microscope, and presented on the convex edge transverse series of

Fig. 289.



In the intervals between the projecting particles, others have become detached.

the particles, which, having lost their longitudinal while they retained their lateral union, stood out in relief, as represented in fig. 289, a, a, a.

It sometimes happens that a linear series of them (a fibrilla) is separated, which has the appearance of a necklace of beads, with constricted intervals, while at other times the intervals, though dark, are of equal width with the light or highly refracting particles. Again, it is possible, by steeping in acid a transverse section of a dried muscle, to separate the particles considerably from one another, and to see that they are granules acting as lenses, being much more refractive than the material connecting them. Such transverse sections are an artificial division into discs, and the intervals between the particles widen out most in specimens taken from birds (fig. 290).

Fig. 290.

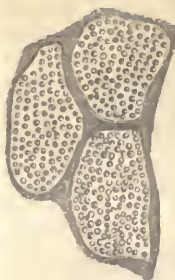

Transverse section of three elementary fibres of the dried pectoral muscle of the Teal, (*Querquedula crecca*,) treated with weak citric acid, shewing the round refracting particles separated from one another. The cut edge of the tubular sheath of each fibre is also seen.

It is in these *sarcous elements* that the contractile power resides, and, as they are apt to retain after death the varying effects of the contraction they have undergone during the rigor mortis, it is not easy to give an exact measurement of their size or shape. An average drawn from very numerous observations shews, however, that they are very nearly alike in these respects in all animals and at all periods of life. Their diameter in the longitudinal direction of the fibre, as indicated by the distance between the transverse lines, is thus shown to be:*

	Eng. Inch.	No. of Observations.
In the Human subject	$\frac{1}{1000}$	27
In Mammalia generally	$\frac{1}{1000}$	15
In Birds	$\frac{1}{1000}$	7
In Reptiles	$\frac{1}{1500}$	7
In Fish	$\frac{1}{1700}$	20
In Insects	$\frac{1}{500}$	8

Their diameter in the opposite direction or that marked by the distance between the longitudinal lines is less, often by a half, but liable to variety from the cause already specified.

In a paper, entitled "On Fibre," read before the Royal Society, on the 16th December and the 6th January last,† Dr. Barry describes the *fibrilla* to be a *flat filament* rounded at the edges, and deeply grooved along the middle line on both its surfaces. He states that this *flat filament* consists of *two spiral threads* placed side by side, with their coils interlacing: that it "is so situated in the fasciculus (elementary fibre) of voluntary muscle, as to present its edge to the observer;" and that the curves of the spiral thread, then seen, seem to have been the appearance that "suggested the idea of longitudinal bead-like enlargements producing the striæ." In Dr. Barry's opinion "the dark longitudinal striæ are spaces (probably occupied by a lubricating fluid) between the edges of flat filaments, and the dark transverse striæ, rows of spaces between the curves of the spiral threads," of which each flat filament consists. "In a postscript, the author observes, that there are states of voluntary muscle in which the" (doubly-spiral, flat,) "longitudinal filaments have no concern in the production of the transverse striæ, these striæ being occasioned by the windings of spirals, within which very minute bundles of longi-

* Auct. loc cit. p. 474.

† Proceedings of the Royal Society, No. 51.

tudinal" (doubly-spiral, flat), "filaments are contained and have their origin."

This description, so entirely opposed to the more simple view above given (and which was already in type when the paper "On Fibre" was read) demands a brief notice. The paper of which it forms part, might perhaps have been more explicitly entitled, "On the double spiral structure of the organic world;" for, in it, the doubly-spiral flat filament, giving the appearance of transverse striæ to voluntary muscle, is discovered to exist in the interior of the blood-corpuses of all animals, and "apparently in every tissue in the body. The author enumerates a great variety of organs in which he has observed the same kind of filaments." "And if the author's view of identity in structure between the larger and the smaller filaments be correct, it follows that spirals are much more general in plants themselves than has been hitherto supposed; spirals would thus appear, in fact, to be as universal as a fibrous structure." "Valentin had previously stated, that in plants all secondary deposits take place in spiral lines. In the internal structure of animals, spirals have heretofore seemed to be wanting, or very nearly so. Should the facts recorded in this memoir, however, be established by the researches of other investigators, the author thinks the question in future may perhaps be, where is the 'secondary deposit' in animal structure, which is not connected with the spiral form? The spiral in animals, as he conceives he has shown, is in strictness not a secondary formation, but the most primary of all; and the question now is, whether it is not precisely so in plants."

As these speculations profess to be grounded solely on observations of particular structures, of which muscle is one, I shall make no apology for applying my few remarks solely to the account of this structure, which is all that can properly be considered here. A renewed examination of this tissue has confirmed, fully and decisively to my own mind, the account I gave of it in 1840, and which was the result of two years' study. 1. I find that when the natural and ready cleavage happens to be into fibrillæ (and I do not pretend to explain why this cleavage should be at one time into fibrillæ and at another time into discs, I only know the fact,) these solitary and isolated fibrillæ do not present any such central longitudinal groove, as Dr. Barry describes, to indicate their double nature: that the cross lines are usually *transverse*, and *not oblique*, by which I mean that the spaces they bound have a *rectangular outline*, so sharp and definite, that the mind rests entirely satisfied that there cannot be two opinions concerning them, between any who have examined the object in one of Powell's *best microscopes*, and with the use of that admirable definer and clarifier of the image, the *achromatic condenser*. That *right angles* can be produced by a *spiral*, whether *double* or *single*, however distorted by accident or violence, it is impossible to conceive. That these transverse lines may sometimes become oblique by irregular traction, such as is almost

necessarily applied in preparing the object, is most easy to understand, if we bear in mind, that the substance in the different spaces which they circumscribe is one united mass. 2. The transverse cleavage of the elementary fibre, which I first showed to be occasionally so complete as to separate it into discs, cannot be reconciled with Dr. Barry's statement. For the surfaces of such discs present, as in *fig. 288*, a fine granular aspect, and *no ends of doubly spiral threads*. And the definite and beautiful appearance presented by a transverse section of the fibre in all animals, but especially in Birds (*fig. 290*), is totally at variance with his views: for the particles there displayed are *highly refracting, round, and not aggregated in pairs*. The condition represented in *fig. 289* is not less opposed to them. Other proofs might be adduced, but they would lead to greater detail than is compatible with the form of the present publication; and perhaps they will be allowed to be unnecessary.

6. *Of the corpuscles of the elementary fibre.* The elementary fibres always contain, among their primitive particles, a number of *corpuscles*, which either are, or are analogous to, the nuclei of the cells of development, of which this and other structures have originally consisted. These corpuscles are visible in the early stages of growth (*fig. 291*), but disappear towards the close of fetal life, as the lines resulting from the deposit of the contractile particles

Fig. 291.

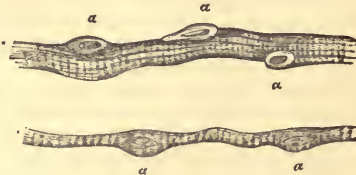

Elementary fibres from the pectoral muscle of a fetal calf about two months after conception, shewing the corpuscles at a, a. Magnified 300 diam.

Fig. 292.



Elementary fibre from the larva of the Libellula, in an early stage of development, shewing the central row of corpuscles. Magnified 300 diam.

Fig. 293.

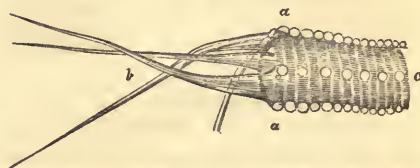

Elementary fibre from the leg of the large Meat-fly (*Musca vomitoria*).
a, a, line of termination of the fibre, along which the tendon (b) is attached to it.
c, central series of corpuscles.
Along the margin the sarcolemma is elevated by water, (which has been absorbed,) and is thereby shown to be adherent to the margin of the discs.

grow dark. The addition of a little acid, however, swells the fibre, obliterates the cross lines, and brings the corpuscles into view, not only at this early period, but at every subsequent one, even to old age. In insects, the nuclei in the earliest stage are a single or double series in the axis of the fibre, and in the perfect fibre they hold the same position (figs. 292 and 293, c). In the Vertebrate classes they have a like correspondence, being scattered equally throughout the mass, in both fetal and adult states. Where the fibre is small, however, they usually abound more towards the surface. They are oval and flat, and of so little substance, that though many times larger than the primitive particles, and lying amongst them, they do not interfere with their mutual apposition and union. These corpuscles are frequently the cause of irregular dark longitudinal streaks, seen in the fibre by transmitted light. They usually contain some central granules or nucleoli (fig. 295). It is doubtful whether the corpuscles or nuclei originally present remain through life, or whether successive crops advance and decay during the progress of growth and nutrition. But it is certain, that, as development proceeds, fresh corpuscles are deposited, since their absolute number is far greater in the adult than in the fetus, while their number, relatively to the bulk of the fibre, at these two epochs, remains nearly the same.

7. *Of the sarcolemma, or tunic of the elementary fibre.*—This is a simple transparent homogeneous membrane of extreme tenuity, but very tough and elastic, which, in the form of a perfect tube, invests every elementary fibre, adheres to its surface, and isolates it from surrounding parts. It is universally present in voluntary muscles, and may be demonstrated in a variety of ways. When the fibres have been immersed in alcohol, which causes them to shrink, it is often seen wrinkled on their surface; or when they are cracked or broken across, it frequently remains entire and connects the severed fragments (fig. 294). This method of showing

Fig. 294.

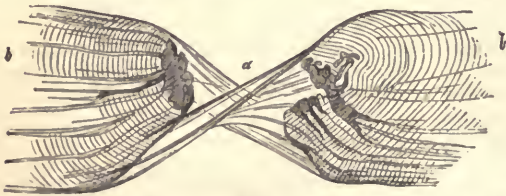

Fragments of an elementary fibre of the Skate, held together by the untorn but twisted sarcolemma.
a, Sarcolemma. b, b, opposite fragments of the fibre.

it is best followed in the case of the large and brittle fibres of the Skate; or, it may be seen cut across in a general transverse section of a dried muscle (fig. 290). When the texture of the fibre is destroyed by maceration, the broken mass is sometimes retained by the sheath, which thus becomes visible. When the fibre swells by acid, this tunic resists, and

the swollen mass emerges at its broken and open end: but, if this is not effected with sufficient celerity, the sarcolemma may give way at different points, being burst by the mass, which thus forms herniæ. Such protruding masses being unequally stretched have their transverse and longitudinal lines distorted from their true direction and thrown into very elegant curves (fig. 295). Again, if a fibre still

Fig. 295.

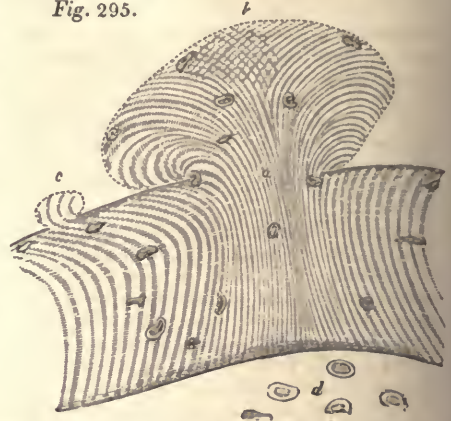

Part of an elementary fibre from the human subject, treated with phosphoric acid.

a, point at which the sarcolemma is burst.
b, hernia of the sarcolemmal mass, with distortion of the longitudinal and transverse lines.
c, a smaller hernia.

Corpuscles are seen scattered throughout the mass, and some detached ones, d, are represented below. Their average diameter is one-thousandth of an English inch.

retaining its irritability, be immersed in water, this fluid, on being absorbed, excites contraction, by which it is immediately expelled from among the primitive particles. When thus forced out it usually collects between the fibre and its sheath, raising the latter in the form of bullæ (figs. 301 and 302, and Art. MUSCULAR MOTION). The progress of this interesting phenomenon evinces the adhesion that exists between the fibre and its sheath. The bullæ immediately subside, by the transudation of their fluid, when the part is placed in thick syrup. I once met with a singular demonstration of the existence and properties of the sarcolemma, in finding it filled with numerous *trichinæ* (fig. 296), which had taken the place of the contractile material, the sheath preserving all its characteristic beauty and transparency.*

I discovered this remarkable membrane in Insects, Crustacea, and all the tribes of Vertebrata, in 1839, not knowing that Professor Schwann had previously described it in connection with the development of muscle in Insects and Fish.† He believes it to be a persistent portion of the membrane of the original cells of de-

* Auct. loc. cit. p. 480, pl. xvii, figs. 41-5.

† Mikros. Untersuch. p. 165.

Fig. 296.

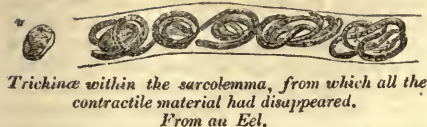

a, ovum.
b, worms in slow motion.

velopment, united to form a single tube, the septa at first resulting from their apposition having been absorbed. This opinion is undoubtedly ingenious; but, as I have yet no data from which to judge of its correctness, I neither admit nor deny it. I have seen the sarcolemma in human muscle as early as the period of birth, and have traced it at all epochs, to old age, when the atrophy of its contents has often seemed to render it more easy of detection. It also remains in muscles wasted by disease or accident at other periods of life, and no difference appears to occur in it whether the specimens examined are pale or dark-coloured, firm or flaccid. It is thickest in those classes that possess the thickest elementary fibres, viz. in Crustacea and Fish, and so thin in Birds, whose fibres are the smallest, that it is often difficult to detect it at all.

With regard to the use which this singular structure may serve in the economy of the organ, our present ignorance of the manner in which motion is excited renders any explanation that might be offered of doubtful value. But it has appeared probable to me, first, that it may act as a mechanical protector and isolator of the contractile tissue enclosed within it; secondly, that its exquisitely smooth external surface may facilitate those rapid minute motions of neighbouring fibres, one against another, which may be shown to occur in contracting muscle (see MUSCULAR MOTION); and, thirdly, that from its apparent similarity in structure to the membrane of the nervous tubules, which run among the fibres, and between which and the proper contractile tissue it seems certainly to intervene, as well as from its extensive contact and union with the surface of the contractile tissue, it may be the conducting medium of that influence, whose mode of propagation the late discovery of the loop-like termination of the nerves in muscle has hitherto only seemed to render more inexplicable than ever.

8. *Of the extremities of the elementary fibres, and their attachment to other structures.*—Every fibre is fixed to fibrous tissue, or to something analogous to it; but an accurate examination of this difficult subject gives no countenance to the ordinarily received opinion that this tissue is prolonged over the whole fibre from end to end, as its cellular sheath; nor is this view reconcilable with the physical requirements of the case. After many trials I have never succeeded in isolating a muscular fibre with the tendinous fibrillæ pertaining to it, in either Mammalia or Birds; but this may be

VOL. III.

occasionally accomplished in Fishes, and in certain muscles of insects. In these examples the minute detachment of the fibrous tissue may be seen to pass and become attached to the truncated extremity of the fibre. The fibre ends by a perfect disc, and with the whole surface of this disc the tendon is connected and continuous (fig. 297). The sarcolemma

Fig. 297.

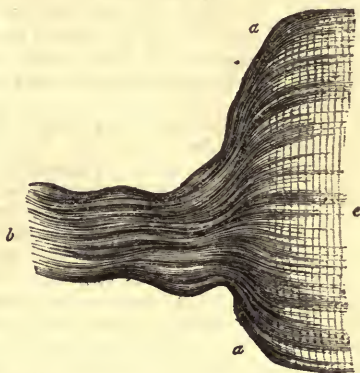

Extremity of an elementary fibre, from the Skate (*Raia Batus*), shewing its attachment to tendon.
a, a, line of union between the two structures,
b, tendon.
c, muscle.

ceases abruptly at the circumference of the terminal disc, and here some small part of the tendinous material appears to be joined to it. The same disposition may be well seen in the legs of certain insects (fig. 293). In other cases, where the muscle is fixed obliquely to a membranous surface, each fibre is obliquely truncated at its extremity, at an angle determined by the inclination of its axis, instances of which may be seen in the limbs of Crustacea, and elsewhere.

9. *Development.*—The researches of Valentin and Schwann have shewn that a muscle consists in the earliest stage of a mass of nucleated cells, which first arrange themselves in a linear series, with more or less regularity, and then unite to constitute the elementary fibres. As this process of agglutination of the cells is going forward, a deposit of contractile material gradually takes place within them, commencing on the inner surface and advancing towards the centre, till the whole is solidified. The deposition occurs in granules, which, as they come into view, are seen to be disposed in the utmost order, according to the two directions already so often mentioned. These granules are the *sarcous elements*, and being of the same size as in the perfect muscle, the transverse stripes resulting from their apposition are of the same width as in the adult; but as they are very few in number, the fibres which they compose are of corresponding tenuity. From the very first period of their formation these granules are parts of a mass and not independent of one another, for as soon as solid matter is deposited in the cells, faint

indications of a regular arrangement in granules are usually to be met with. It is common for the longitudinal lines to become well-defined before the transverse ones. When both are strongly marked, as is always the case at birth, the nuclei of the cells, which were before visible, disappear, being shrouded from view by the dark shadows caused by the multitudinous refractions of the light transmitted through the mass of granules; but, as before stated, they can still be shown to exist by immersion in a weak acid, which, while it swells the fibrinous material of the granules and obliterates their intervening lines, has no action upon the nuclei.

b. Of the unstriped elementary fibres.—This variety possesses far less interest than the other in consequence of its apparent simplicity of structure. The fibres consist of flattened bands, generally of a pale colour, bulged at frequent intervals by elongated corpuscles similar to those of striped muscle, and capable of being displayed by the same process (*fig. 298*). The texture of these fibres seems to be homogeneous. By transmitted light they have usually a soft, very finely mottled aspect, and without a darkly-shaded border. Sometimes the mottling is so decided as to appear granular, and occasionally these granules are arranged in a linear series for some distance. This condition is probably an approximation towards the structure of the striped fibre, for I have observed the granules to be about the size of the sarcous elements already described. It is generally to be seen more or less distinctly in the gizzard of Birds, and I have now and then met with it in the fresh muscle of the stomach, intestinal canal, urinary bladder, and uterus of Mammalia. The ordinary diameter of the unstriped

fibre is from $\frac{1}{3000}$ th to $\frac{1}{3000}$ th of an inch. From this account of the appearance of these fibres, it might be expected that their discrimination from other tissues would be often difficult. And, in fact, it is so to an inexperienced eye. The peculiar texture, however, the size, the soft margin, and, above all, the presence of *numerous* elongated oval corpuscles, with two or three granules in their centre, are characters which, taken together, I believe to be decisive. As a number of fibres usually take a parallel course together, the bulgings occasioned by the corpuscles give rise to partial longitudinal shadows, extending for some way beyond the corpuscles, in the intervals of the fibres. As these irregular longitudinal shadows occur pretty uniformly throughout an aggregation of fibres, and as some are necessarily out of focus, while others are in focus, the whole mass commonly presents a very confused reticulate appearance, which has given rise to an almost universal notion that these fibres do, in reality, interlace one with another, and do not run parallel. This notion, however, is, in most cases, erroneous. It is doubtful whether these fibres are invested in a sarcolemma: none has hitherto been detected in an unequivocal manner. It is also still a matter of speculation how they terminate, or whether they in all instances have a termination. In the case of the more or less circular set of fibres, inclosing the small intestine, for example, it is uncertain whether each fibre surrounds the canal once, returning into itself as a ring, or, more than once, as a spiral, or whether it passes only partially round it, the rest of the circle being completed by others. Whether the areolar tissue (the representative of the fibrous) that is always found in connection with these fibres, serves to give them an attachment by union with their extremities, or by involving them in its meshes, is also altogether unknown. In the gizzard of Birds the ends of the fibres are united to white fibrous tissue, thus making an approximation to the striped fibre, as they do in colour. But I have not been able, after diligent search, to detect the true transverse stripes, which Ficinus describes to exist in this organ.

Of the mode of aggregation of the elementary fibres.—The two kinds of fibre whose structure has now been described, are aggregated into masses of very various shape and bulk, and supplied with areolar tissue, vessels and nerves, so as together to form the organs termed muscles. But if we trace these organs downwards through the animal scale, we come to examples in which solitary fibres exist without any such appendages, and yet evidently performing the office of, and truly constituting, a perfect muscle. And even many fibres are found, so far smaller than the usual dimensions as to consist of only one or two linear series of sarcous elements, and these perhaps only visibly present near the centre of the fibre, where development is most advanced, and the contractile energy greatest. In such minute and simple forms we may perceive a transition from the striped towards the unstriped fibre,

Fig. 298.



Unstriped elementary fibres from the human colon.
a., treated with acetic acid, and shewing the corpuscles.
b., fragment of a detached fibre, not touched with acid.

the transverse lines being often irregular, broken, or faintly marked. And we may also discern a clue to the meaning of the structural condition which is found in the complicated muscles of the higher animals. The essential contractile material is the fibre, and its mass is accurately proportioned to the power demanded. If this is below that of a single elementary fibre, the fibre is reduced in proportion; if more is required than one fibre can supply, the size of this is not increased but its number multiplied. The point at which an increase in number supersedes one in size, is that which has been already stated to be the average bulk of the fibre. This differs in the different classes of animals, and corresponds with the demand there may be in each class for vascular and nervous supply. For by the very constitution of the contractile material, it can receive neither vessels nor nerves into its interior substance, and therefore it must be itself subdivided further and further in proportion to the amount of these which are to be in contact with its surface.

In the compound organs termed muscles, the fibres are usually disposed in parallel sets of 10, 20, 30, or more, surrounded and held together by a delicate areolar tissue, which penetrates more or less among the individual fibres, but does not necessarily invest each one of them from end to end, as it is frequently described to do. Where the fibres are not very large, it is often difficult to discern any areolar tissue at all in connexion with them. These first sets admit of considerable motion on one another, in consequence of the looseness of their areolar sheath. Like the elementary fibres themselves their figure is polygonal, for they in their turn are arranged (if the muscle be large enough) into secondary sets, and are flattened by being pressed together. These again are aggregated into tertiary sets, and these into still larger ones, according to the size of the particular organ. All these sets partake of the polygonal figure of the elementary fibres; except the portion that forms a part of the general exterior of the muscle, which is usually more or less rounded. As the packets of fibres are larger, so their angles are more rounded, and their surface covered with a more abundant areolar sheath, and they approach, in fact, to the condition of a perfect muscle, which is itself included in an envelope of areolar tissue. Their angles are thus rounded in consequence of the greater quantity of areolar tissue, and of the larger size of the vessels and nerves that occupy their intervals. For the same reason the elementary fibres themselves are less sharply angular, when very small, as in Birds, because the vessels accompanying them are proportionally more abundant, and occupy more space in their intervals.

The arrangement of the elementary fibres into these packets has received more attention than its importance deserves, and anatomists have endeavoured to affix definite names (*fasciculi*, *lacerti*, &c.) to certain sizes of them. But no division of this kind is to be found in nature. It may be safely said that packets of

every possible bulk exist from the simple set of two or three fibres, to those of many thousands, these last being subdivided with the greatest irregularity. And it is only in muscles possessed of some thickness that any such package in sets is to be met with. The abdominal plane muscles, which contain such an arrangement in the larger animals, are, in the smallest, composed of a single unbroken layer of elementary fibres. A similar diversity exists between muscles of different size and shape in the same animal. In the *gluteus maximus*, which is liable to pressure and change of position from its peculiar situation, the fibres are made up into *lacerti*, about one-quarter of an inch thick, surrounded with a dense areolar sheath, and attached loosely to one another; while the *glutei* situated underneath are, like the *psaos*, unprovided with such dense septa of areolar tissue, and seem more uniform throughout.

From these and many other considerations which might be adduced, it may be clearly seen that the mere aggregation of the elementary fibres in a muscle into larger or smaller sets, is determined solely by its own peculiar circumstances and exigencies, and is not of a nature to demand particular description in so general an account as the present.

The direction of the elementary fibres of voluntary muscles is usually straight, between their points of attachment, which are always some form of the fibrous tissue. This tissue may be so arranged as that the sets of muscular fibres passing from it, may be either parallel or oblique to one another, but the fibres forming any one set are generally placed in a parallel series. If the fibrous tissue form a laminar expansion on the surface of a muscle, the muscular fibres pass off from it obliquely, either to a similar expansion on the opposite surface or to a tendon. If they arise from an extensive surface of bone (i. e. of periosteum) they conduct themselves in a similar fashion, and also if they pass from a line of tendon or of bone. In all these cases the muscle may be styled *penniform*. If a thread or sheet of fibrous tissue dip into the interior of a muscle, it gives origin to the muscular fibres on both sides, and they diverge from it obliquely: such a muscle is styled *doubly penniform*. When several such sheets enter the muscle at both extremities, and give attachment to the fibres obliquely placed in the intervals, the muscle is styled *compound penniform*, as the *deltoid*.

One result of the varied arrangement of the tendinous fibres with regard to the muscular, is the production of symmetry and beauty of form; a second is convenient package; a third is the adaptation of the particular muscle to the kind and amount of exercise which is required of it. Where a great mass of fibrous tissue runs into a muscle, the number of fibres and their obliquity is very much increased, while the length of each is diminished; and, as a general result, the power of such a muscle is augmented, while the extent of its contractions is limited. The same mass of contractile material may be

arranged as a few long fibres (as in the sartorius), or as many short ones (as in the masseter). In the former case its contractions would be characterized by their extent, in the latter by their power; for, *cæteris paribus*, the extent is as the length, the power as the thickness.

The terms *origin* and *insertion* are employed with great convenience in ordinary anatomical language to denote the more fixed and the more moveable attachments of muscles. In human anatomy general consent has sanctioned their use, and even, with few exceptions, their particular application to each muscle in the body, although this assignment is in many cases arbitrary, in consequence of its being impossible to determine which attachment is the more frequently the fixed one.

The arrangement of the fibres in the heart has been already fully treated of in this work. (See HEART, Fibres of.)

In the muscular coat of the alimentary canal, of the bladder, and uterus, the unstripped fibres are disposed, as in the heart, so as to enclose a cavity, but without having, as in that organ, any point at which they can be said to commence or terminate. In the alimentary tube they are arranged in two laminae, the respective fibres of which take a course at right angles to each other. In the bladder the arrangement is reticulate. The elementary fibres form sets of variable thickness, which at numerous points send off detachments to join neighbouring bundles, whence has sprung the notion that the fibres are branched. It is manifestly, however, the sets of them only that are branched, the unstripped like the striped fibres being invariably simple from end to end. In the uterus the disposition of the fibres is essentially similar, calculated to allow of great variety in the capacity of the cavity they encircle.

Of the areolar tissue of muscles.—This tissue is much more abundant in the voluntary than in the involuntary muscles. In the former it forms an external investment, which sends septa into the intervals between the larger and smaller packets of fibres, and thus enables them to move in some degree independently of one another. The *density* of these general and partial sheaths is proportioned to the amount of pressure to which the organ may be subject, as is exemplified in the superficial muscles of their back, and in those superficial muscles generally where a fibrous aponeurosis does not perform the same office. The areolar tissue does not usually clothe every individual fibre from end to end, giving it a cellular sheath, except in cases where the elementary fibres are of large dimensions. Besides the protection the areolar tissue affords to the muscular fibres, it admits of motions between them. But it must also serve the important office of limiting undue motions of one part of a muscle on another part, by its forming a connecting bond between neighbouring bundles. But a principal use of it appears to be that of furnishing a resisting nidus in which the delicate vessels and nerves can traverse the

interstices of the fibres, and by which they can be protected from hurtful dragging during the unequal and oscillating movements of the fibres of a voluntary muscle during its state of activity. This idea is supported by the fact that scarcely any areolar tissue exists in the heart or in the unstripped muscles generally. In the heart, though the contraction is powerful, it is instantaneous or nearly so, and therefore probably more uniformly diffused, so that neighbouring fibres must be less moved on one another than in the more sustained contraction of a voluntary muscle. Moreover the mutual intertwining of even the elementary fibres in this organ is, in many parts of it, so intricate, as to contribute much to their mutual support. And in the other involuntary muscles, the contractions are slowly and evenly progressive along the fibres of the same set.

Of the bloodvessels of muscles.—The arteries and veins of muscles commonly run together, and most of the arterial branches, to within two removes from the capillaries, are accompanied by two *venæ comites*. They invariably pass more or less across the direction of the fibres, divide and subdivide, first in the intervals between the larger sets, then between the smaller sets, till the ultimate twigs insinuate themselves between the fibres composing the smallest bundles, and break up into their capillary terminations. In this course the vessels supply the areolar tissue, their own coats, and the attendant nerves. The capillary plexus of the areolar membrane consists of irregular but pretty equal-sized meshes, and contrasts strongly with that of the muscular tissue itself. The *proper capillaries* of muscle are quite characteristic in their arrangement, so that a person who has once seen them can never afterwards mistake them. They consist of longitudinal and transverse vessels, the longitudinal always following the course of the elementary fibres, and lying in the intervals between them, the transverse being short communications placed at nearly equal distances between the longitudinal ones, and crossing nearly or quite transversely over or under the fibres. The manner in which the longitudinal vessels are placed in relation to the fibres, is seen in *fig. 286*, where I have represented them as they are seen on a transverse section. They usually occupy the interstice between three or more fibres, but sometimes also the space between the contiguous surfaces of two fibres. The length of the longitudinal vessels does not usually exceed the twentieth of an inch; in other words the terminal twigs of the artery and vein pertaining to the same capillary are seldom further than that apart. The length of the transverse anastomosing capillaries necessarily varies with the thickness of the fibres over which they pass (*fig. 299*). The diameter of the capillaries of muscle varies like that of others with the size of the blood-particles of the animal. It is, however, only just sufficient to allow of the particles to pass. If a fragment of a frog's muscle, perfectly fresh, be examined, series of blood-particles will be seen in the longitudinal capillaries. These

Fig. 299.



View of the capillaries of muscle (part of the *latissimus dorsi* of a mouse, where it consists of a single sheet of fibres).

- a*, *a*, terminal twig of the artery.
b, *b*, terminal twigs of two neighbouring venous branches, anastomosing, and carrying off blood from the same capillary network *c*, *c*.
e, an elementary fibre, to show the relative size and direction of those to which the capillaries here represented are distributed.

particles are compressed and elongated, sometimes to a great extent, evidently by the narrowness of the canal which contains them. It may seem at first sight not doubtful that in the living creature these elastic blood-discs are similarly elongated in their passage through the vessels of muscle, but the admirable researches of Poiseuille will perhaps serve to explain this appearance without our being driven to suppose the presence of so formidable an obstacle to the capillary circulation through these organs. It is more probable that the contraction of the vessels and the compression of the blood-discs occur, on some of the contents of the vessels being permitted to escape by the severing of the fragment for microscopic examination. The coats of the capillaries of muscle consist of a simple diaphanous membrane, in which a few irregular-shaped cyto blasts occur at infrequent intervals.

Of the nerves of muscle.—The distribution of the nerves through muscular structures has always been a subject of great interest with those who looked to this line of inquiry for some clue to the explanation, either of that wonderful active connexion subsisting between them, or of the nature of the contractile act itself. But though the anatomical results accruing from this inquiry are of a highly satisfactory kind, considered in themselves alone,

yet they cannot be said to have hitherto contributed, in any great degree, to the elucidation of these mysterious questions. The best mode of inspecting the arrangement of the ultimate nervous twigs, is to select a very thin muscle, (as one of the abdominal muscles of any small animal, or one of the muscles of the eye of a small bird,) to steep it in weak acetic acid, and then thin it out under the compressorium. The primitive tubules of the nerve may then be readily distinguished with a power of 100 to 200 linear. They separate from one another, at first in sets, afterwards in twos, threes, or fours, and if these be followed they will be found ultimately separating from one another, forming arches, and returning either to the same bundle from which they set out or to some neighbouring one (fig. 300). In this loop-like course they accompany to some extent the minute bloodvessels, but do not accurately follow them in their last windings, since their distribution is in a different figure. They pass among the fibres of the muscle, and touch the sarcolemma as they pass; but as far as present researches have informed us, they are entirely precluded by this structure from all contact with the contractile material, and from all immediate intercourse with it. How then shall we explain the transmission of the nervous influence to a material thus enclosed? If it were wise or safe to go a single step in advance of pure observation on so abstruse a question, we might suggest, resting on the seemingly sure ground of exact anatomy, that this influence must be of a nature capable of emanating beyond the limits of the organ which furnishes it. But further than this, as to how, or to what extent this influence may so emanate,

Fig. 300.

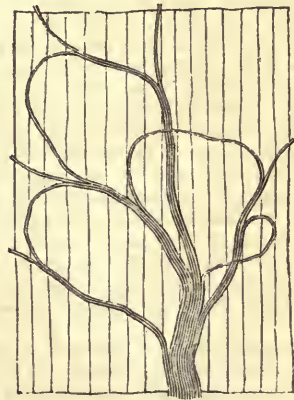

Loop-like termination of the nerves in voluntary muscle. After Burdach.

or as to what may be its nature, it would, perhaps, in the present state of knowledge, be hardly warrantable even to speculate.

d. Of the distribution of the striped and unstriped fibre in the body.—The striped fibre is met with in all the voluntary muscles, and in a few involuntary, as the constrictors of the

pharynx and the muscular coat of the œsophagus, and the heart. In the œsophagus it appears to be mingled with the other variety to a somewhat uncertain extent. In some specimens from the human subject I have been unable to detect any striped fibres in the lower half of that tube, either in the circular or longitudinal layer, but in other examples they have been traceable to within an inch of the stomach. Among the lower animals considerable differences occur, as has been well pointed out by Mr. Gulliver,* who observes that in general "the muscular fibre of animal life (striped) extended further towards the stomach in the outer than in the inner layer of the œsophageal muscular sheath." In several animals this gentleman found the striped fibres even on the stomach (as in the Rabbit, *Lepus cuniculus*, Linn., the Sheep, *Ovis aries*, Desm., the Sloth Bear, *Ursus labiatus*, Blainv.) while in many others he met with them to within a very short distance of that cavity. Dr. Todd has also shewn them to me on the glandular pouch at the cardiac extremity of the stomach in the Dormouse. It is still unknown in what manner the two varieties of fibre are arranged at this point of junction, some supposing that they are simply intermixed, others that they pass into one another by imperceptible gradations. The former of these views is that which appears most consonant with my own observations. Mr. Skey considers † that the fibres of the heart "possess a somewhat compound character of texture," and this opinion seems highly probable. They possess, it is true, the transverse stripes indicative of an arrangement of particles in parallel series, but there is frequently a want of that uniformity and precision in this appearance which so remarkably characterize voluntary muscle. The cross lines are apt to be broken and interrupted, and are sometimes difficult to discover at all. This condition is well represented by Mr. Skey in fig. 5 of his second plate. In some of the smaller and lower animals the particles never form transverse stripes. These fibres, as explained by him, are smaller than the average diameter of the voluntary muscles of the same subject by two-thirds, and in most parts of the heart they are not aggregated in parallel sets, but twine and change their relative position. Striped fibres have been found in the iris, in the small muscles of the ear, and in those muscular fasciculi that surround the urethra immediately in front of the prostate. They are also found in the sphincters of the anus and vagina.

The unstriped fibre is met with in the alimentary canal from the middle of the œsophagus to the rectum, and constitutes the double layer investing that tube. It also forms the muscular coat of the bladder and that of the uterus. The dartos owes its contractility to the presence of fibres of this variety, which, in consequence of the abundant admixture of areolar

tissue, has not hitherto been clearly recognized; but it may be detected by the addition of acetic acid, which, by bringing into view the peculiar corpuscles it contains, distinguishes it from both the white and yellow fibrous elements of the areolar tissue. But even without this chemical test, to which some may object, it is possible to discover this form of muscular fibre in the dartos, by the characteristic appearances which have been already attributed to it. Since satisfying myself of the real existence of this fibre in the dartos, I have on many occasions detected a very decisive peristaltic action advancing from one side of the scrotum to the other, and continued for a considerable period, yet of a kind which it was impossible to refer, with any degree of probability, to the cremaster. In one case particularly, occurring in the practice of Mr. Fergusson, where the tunica dartos was much hypertrophied, in connection with an old stricture of the urethra, we observed this peristaltic contraction of a very vigorous description. The fibres which have been described as peculiar to the dartos seem to be nothing more than a certain modification of the areolar tissue in that region. In the corpora cavernosa penis of the horse there is a large quantity of this kind of fibre, as may be ascertained by microscopic examination, although Professor Müller* seems indisposed to consider it really muscular. He states that "viewed in the microscope these fibres do not present any resemblance to muscular fibres," but my own examinations of them have not confirmed this statement. They appear to me to have all the characteristics of this variety, and by acetic acid are seen to contain a great number of corpuscles. Moreover they appear to consist chemically of fibrine. Professor Müller has failed in exciting contraction in them in the living horse, but this is not a conclusive fact as to their nature, for it may be and probably is the case that they do not act unless stretched by the erection of the organ. In the quiescent condition of the part they may be considered to be in a contracted state, like the muscular coat of an empty intestine, and so would naturally appear to be unaffected by the stimulus of galvanism. The erection of the penis seems with great probability to be attributable to pressure exercised on the superficial veins of the organ by a continuation of a structure analogous to the dartos, and certainly containing the unstriped muscle, which is continued over the base of the penis under the skin. The erection of the nipple also occurs, on any mechanical irritation, with a motion so very much resembling the peristaltic action of muscular fibres, that I have little doubt such would be found, constituting a layer, under the skin in that region. And it may be matter of inquiry how far the general contractility of the skin is dependent on a diffusion of this tissue, in small quantities, throughout its areolar structure. The excretory ducts of all the larger glands appear to possess a covering of fibre belonging to this

* Proceedings of the Zoological Society of London. No. 81, Sept. 1839.

† Phil. Transactions, 1837, p. 381.

* Physiology, by Baly, second edition, p. 250.

variety. Such is the case with the ductus choledochus in Birds, and probably in Mammals, and in the ureters and vasa deferentia. The bronchial tubes may be mentioned under this head as the best marked example of this arrangement. The trachealis muscle consists evidently and entirely of the unstriped fibres, and the same may be traced down the bronchial ramifications as far as the air-cells themselves, though not into them. The distinctive characters of this form of muscle may here be unequivocally discerned, and if anatomists had been better acquainted with them, there would not have been room for those disputes regarding the muscularity of the bronchial tubes which have so long attracted the interest of practical physicians. Recently, indeed, there has been added to the satisfactory evidence of anatomy the well proved fact that these fibres may be excited to contraction by the galvanic stimulus.* In the case of other glands it is still unknown how far the muscular coat invests the ramifications of the duct; it is most likely that it gradually ceases a short way within the organ, and at least it seems clear that no portion of the secreting membrane itself is ever invested by it.

e. Of the distribution of the striped and unstriped fibres in the animal kingdom.—The striped fibres have been found in all vertebrated animals, and in Insects, Crustacea, Cirropods, and Arachnida. Future researches will probably discover them even more extensively diffused. But in the lower animals, especially when they are of small size, we find, as formerly mentioned, that the distinctive characters of the two varieties begin to merge into one another and be lost. The transverse stripes grow irregular, not parallel, interrupted; a fibre at one part will possess them, at another part will be without them; and even the peculiarities of the unstriped fibres are sometimes no longer to be met with in parts which are undoubtedly muscular, as the alimentary canal of small insects. It is evident that here the elementary fibres, if of their usual bulk, would be greatly disproportioned to the requirements of the case, and consequently even the minute ultimate fibre seems to be reduced within limits which remove from it those anatomical characters by which alone we can positively aver its existence. Considering, however, the circumstances which have been already adverted to in this article, as determining the size of the elementary fibre in all animals, we should not be justified in denying the same muscular tissue to exist here which in the higher and larger forms of life assumes the figure and bulk of the elementary fibre; and by the same mode of reasoning it may be concluded, that a tissue having the same properties as the striped fibre, and indeed essentially identical with that of which they consist, may possibly be the effective agent to which are due those wonderfully vivacious movements witnessed in the bodies of many of the minutest infusoria, where the best microscope can hardly do more

than discern the organs thus put in motion. And it seems far from an unphilosophical view of the nature of ciliary motion, to refer it to the contractions of a tissue not entirely different in kind from the muscular. The elementary fibres of muscle, diminutive though they be, and hardly discernible with the eye, are yet gross organs in comparison with those which the microscope enables us to conceive capable of being formed out of them, without any necessary destruction or even injury of their contractile power.

f. Chemical constitution.—There is little to add on this subject to what will be found under the head of FIBRINE. By the aid of the microscope, however, our knowledge has been rendered somewhat more precise, as to the chemical properties of the elementary structures existing in the fibres. If any substance capable of dissolving fibrine (as liq. ammoniæ) be added to the muscular fibre, this is seen to swell, to lose more or less completely its transverse and longitudinal markings, and to exhibit at once those corpuscles or cytoblasts, which before lay concealed among the sarcous elements. These corpuscles and the sarcolemma are not affected, but the sarcous elements are almost entirely taken up. But for however long a time the fibre be exposed to the alkaline menstruum, there will always remain a kind of web, of extreme tenuity and transparency, from which the sarcous elements appear to have been withdrawn. This may be seen in a transverse section of a muscle that has been thus treated, then washed and dried. I have not been able to detect in it any sort of structure.*

(W. Bowman.)

MUSCULAR MOTION.—Under this head it is intended to consider the contractility of muscle, its source, the stimuli that excite it, and the nature of the minute movements occurring during the act of contraction.

a. Of the contractility of muscle.—This subject having already been ably discussed in this work (see CONTRACTILITY), I shall here confine myself to such a brief statement as may appear to be required by the advance of knowledge since the publication of the article in question.

1. *Is it a property inherent in the muscular fibre? Are we to believe in the 'vis insita' of Huller?*—The supporters of this opinion have always been exposed to the objection that in the cases of contraction adduced by them as the effect of a topical or immediate stimulus, the isolation of the muscle from all connexion with nervous fibrils has not been demonstrated. Moreover, what has generally been regarded as their strongest ground, viz. the statement that involuntary muscles are not capable of being excited to contraction by irritation of their nerves, has lately been shown by the numerous

[* The principal facts relating to the morbid states of Muscle will be found in the articles HEART, Morbid States of, and HYPERTROPHY and ATROPHY. An historical sketch of the subject concludes the article MUSCULAR MOTION.—ED.]

* Dr. Williams, on Diseases of the Chest, last edition, Appendix.

experiments of Müller, Valentin, and others, to be erroneous and unworthy of credit. But I have elsewhere* adduced the evidence of direct microscopical observations made on living fragments of the elementary fibre of voluntary muscle, entirely isolated from every extraneous tissue, whether nerve or vessel, to shew that this is a property inherent in this tissue, and that, whatever be its source, it is capable of being brought into action by a stimulus topically applied. Thus, when such a fragment is examined, contraction is found to occur first at its broken extremities, and if water (which has long been known to be a rapid exhauster of muscular irritability) be brought into contact with it, it is seen to absorb the fluid and to be excited to contractions, which commence at the surface. The same thing is frequently to be met with under a different form. A particle of foreign matter, as a hair or piece of dust, may be included by design or accident in the field so as to touch the side of the fibre at a single point. When this happens, the fibre will often exhibit a contraction so plain and so limited to the point touched, as to give unequivocal proof of its being the result of the irritation of pressure.

These interesting phenomena may be observed more or less satisfactorily in all animals whose fibres retain their irritability for a sufficient length of time after removal from the body, and the crab and lobster will be found the most favourably adapted for the purpose. In many reptiles and fishes, also, the steps occur slowly enough to be adequately scrutinized.

The facts in question can admit only of one explanation if it be conceded that the muscular element has been here separated from the nervous; and certainly that separation has been effected unless the nervous tubules send off from their terminal loops a set of fibrils which penetrate the sarcolemma and diffuse themselves through the contractile material within; a supposition for which there exists at present no foundation in the observations of the most diligent investigators of this subject.

They will, therefore, probably, be regarded as conclusive proof that contractility is a property inherent in the very structure of muscle, and capable of being excited to action independently of the immediate instrumentality of nerves.

The determination of this point must have a very important bearing on the question of the nature and cause of contraction, into which no small confusion has been introduced by the attempts to account for that phenomenon by various hypotheses of electrical action. That one, especially, which aims at establishing an attraction between distant points of the fibres where the nerve crosses them, (the 'zig-zag hypothesis' of Prevost and Dumas,) and which, with the wrongly interpreted facts on which it principally rests, has had an immense, though sometimes unperceived influence, ever since it was broached, on the whole question of contraction, is entirely refuted by the facts above-

mentioned. There are some others, sprung out of this, which do not here require more than a passing allusion.

2. *Source of contractility: whence derived?* This important question, like the last, is debated up to the present day, but seems at length to have become disentangled of certain loose hypotheses which have long interfered with its settlement. The discussion may be limited to such particulars as seem to be the most conclusive.

It may be observed that the contractility and development of muscle, other things being the same, are always proportionate to one another. All causes interfering with development diminish contractility. Thus muscles become atrophied and weak by disuse, by lessening their supply of blood, by cutting off their connexion with the central part of the nervous system. They are, on the contrary, augmented both in size and power by active use, during which both the vascular and nervous parts supplied to them are no doubt urged to increased activity. How is it to be decided whether these changes of contractility depend on changes of nutrition, or whether both be not a common result of changes in the amount of nervous power brought to act upon the muscles. Dr. Marshall Hall has remarked that in paralysis from disease involving the spinal cord or nerves, the wasting of the muscles is far more rapid and complete than in paralysis from affection of the brain, wherein the spinal cord and its connection with the muscles remains in a normal state; and the deduction seems at first sight plain and inevitable, that it is from the spinal cord that the contractility is derived, or at least that the integrity of the spinal system is essential to the maintenance of that property in the muscles. An ingenious experiment of Dr. John Reid's,* however, proves that this is not the case, and explains the part which the spinal system plays in respect of this property in the instances referred to. "The spinal nerves were cut across, as they lie in the lower part of the spinal canal, in four frogs, and both posterior extremities were thus insulated from their nervous connexions with the spinal cord. The muscles of one of the paralyzed limbs were daily exercised by a weak galvanic battery, while the muscles of the other limb were allowed to remain quiescent. This was continued for two months, and at the end of that time the muscles of the exercised limb retained their original size and firmness and contracted vigorously, while those of the quiescent limb had shrunk to at least one-half of their former bulk, and presented a marked contrast with those of the exercised limb. The muscles of the quiescent limb still retained their contractility, even at the end of two months; but there can be little doubt (adds Dr. Reid) that from the imperfect nutrition of the muscles and the progressing changes in their physical structure, this would in no long time have disappeared had circumstances permitted me to prolong the experiment." It is clear from this

* Edinb. Monthly Journal of Medical Science, May 1841, p. 327.

* Phil. Trans, 1840, p. 487.

description that though contractility remained, it was diminished proportionally to the wasting, in the limbs that had not been exercised.

The results of this admirably devised experiment cannot possibly be reconciled with the opinion that the spinal cord has any necessary or immediate influence in conferring contractility on muscles—that it is the source whence that property is derived. On the contrary, they show in a manner that admits of no dispute that both contractility and nutrition have been preserved together by the continued activity of the property existing in the fully developed organ at the period when the experiment was begun; and hence it is plain, and conformable to all analogy, that contractility is a property depending for its integrity on a healthy state of nutrition, which in its turn requires for its support the due exercise of the property it confers.

It might, perhaps, be argued by one disposed to uphold the electrical hypothesis of the nervous influence and muscular power, that in the foregoing experiments the galvanism supplied the place of the intercepted nervous communication, by directly furnishing the muscles with the endowment of contractility; and it is not easy to meet the objection by any decided proof to the contrary. It would be very difficult to induce oft-repeated contractions in a paralyzed muscle by any other than electrical agency; but the refutation of this view will be found in the general arguments against the identity of the nervous influence with any form of electricity.

Viewed by the light of this and other allied experiments, the variation found in the state of nutrition of paralyzed limbs is easily accounted for. In cerebral paralysis the muscles are still subject to contraction in obedience to reflected stimuli through the spinal cord, while in the complete spinal palsy and that arising from disease of the nerves, they are never excited to action; whence their firmness in the former compared with their impoverishment in the latter case. In the paralysis of the lower limbs so graphically described by Pott, and resulting from disease propagated to the cord from the vertebrae, the early symptoms are those of irritation, and consist rather of irregular contractions, probably in part reflex, and which the patient is unable to control, than of any diminution of actual power in the limbs; and it is constantly remarked that in this stage there is no loss of size in the affected parts, but rather that in the midst of a general emaciation consequent on the patient's confinement, these limbs retain their fullness, and even appear hypertrophied. Should the malady advance to disorganization of the cord, the muscles cease to be excited. They become dead to all stimuli except such as are topically applied, and being never so stimulated, soon become flabby and wasted. Thus it would appear that the spinal cord in cerebral paralysis serves to keep up contractility in the muscles, not by supplying them with it, as from a source, but by exhausting them through the contractions it excites. It is not a charger but an exhauster through its

nerves; and as exhaustion alternating with re-accumulation is necessary for healthy nutrition, and healthy nutrition induces contractility, it becomes in such cases an important though indirect agent in the maintenance of that property in the muscles. There can be little doubt that if muscles completely cut off from the nervous centres were submitted to galvanic agency at frequent intervals, they would not decrease in size, and might, if already atrophied, be even augmented in bulk and power; and perhaps some of the vaunted successes obtained by galvanism and electricity may be explained in this manner.

There appears to be no argument nor established fact on the other side which invalidates the experiment of Dr. Reid, or which does not admit of being explained on the ground which that experiment substantiates; and the whole question is still further cleared by the singular circumstance that has been often adduced, that fetuses born without brain or cord may have their muscular system developed and active.

If, to what has now been advanced, there be added the evidence before adduced, that this is a property inherent in the very structure of muscle, and that it is capable of being exerted therein independently of all communication with other tissues, it will probably no longer remain doubtful that it is a property belonging to muscle as a tissue, and that it only requires for its perfection that nutrition should be perfect. Whatever interrupts nutrition interferes with it, and it matters little whether such interruption arise from the want of its own exercise or from deficiency of arterial supply, arising from causes either local or general. Inertness of a muscle, whether the consequence of diseased nerves or otherwise, will be attended with more or less atrophy and weakness, according to its degree, and to that alone.

For full information concerning the varieties in the intensity of this power, and in its durability in muscles after systemic death or after their removal from connexion with the nervous and vascular systems, the reader is referred to the article *IRRITABILITY*.

I would merely remark in corroboration of the views there maintained, that in the animal series the size of the elementary fibres and the consequent amount of their vascular supply, independently of the more or less arterial quality of the blood, is accurately proportioned to their irritability. Thus Birds, whose irritability is most exalted and most evanescent, have the smallest fibres and the most richly supplied with blood, while Reptiles, Fish, and Crustacea, in which the irritability is most enduring, have fibres of large dimensions and provided with a vascular web of small comparative size (*fig. 286, art. MUSCLE*). The same is true as regards the heart compared with the voluntary muscles.

b. Of the stimuli of muscle.—The stimuli which induce contraction have been classed into remote and immediate. Properly speaking, the remote stimuli are stimuli to the nerves and not to the muscles: they cause a change in the

motor nerves, which are thus made to excite contraction by their immediate and topical action on the muscles. Of these the chief are volition, emotion, and impressions carried by the afferent nerves to the nervous centres and involuntarily reflected thence; but various diseases and injuries of the motor nerves, either at their origin or in their course, and pressure, heat, chemical substances, electricity, galvanism, &c. applied to their texture, are to be ranged under the same head.

The nature of the change thus induced in the motor nerves is entirely unknown. There seems, however, no ground for believing that it differs with the particular stimulus which induces it, and certainly a clear distinction ought ever to be drawn between it and its exciting cause. The nerves, when this change is induced in them, occasion the muscles to which they are distributed to contract. The stimulus they give is an immediate one, and is termed the *vis nervosa* or the nervous stimulus of muscle. It acts topically on the muscular fibre. The other immediate stimuli are physical and chemical; they are rarely exerted in the living body, except in the case of the hollow muscles. It has already been stated that trustworthy experiments have lately shown these to be under the influence of motor nerves derived from the spinal marrow, but it seems probable that some at least are normally excited to contract by direct stimulation, to one form of which, that of stretching or distension, they are peculiarly liable from their arrangement as investments to cavities. All muscles, however, may be made to contract by physical and chemical stimuli applied to their fibres.

The effects of water and mechanical pressure as immediate stimuli have been already alluded to. Chemical substances may be seen to act similarly, if they be not so powerful as to destroy the texture of the part; and it is probable that electrical forces have a like agency. An interesting phenomenon has been pointed out by Dr. Stokes,* which seems to show very clearly that contractions of voluntary muscles may be excited by an immediate stimulus in the living body. In various cases of phthisis, and in others, particularly those attended with emaciation, a sharp tap with the fingers on any muscular part is instantly followed by a contraction, evidenced by the rise of a defined firm swelling at the point struck, enduring several seconds before it gradually subsides. This is often so prominent as to throw a shadow along the skin, and for the moment it might almost be mistaken for a solid tumour. That it is limited to the point struck is full proof of its being a direct effect of the irritation, and not produced through the intervention of nerves; for a contraction excited in the latter mode would be diffused over the part to which the nervous twigs irritated were supplied, and would therefore frequently extend to some distance.

c. On the visible changes occurring in muscle

* On Diseases of the Chest, p. 397. See also Dr. Guy, in the new edition of Hooper's Physician's Vade Mecum, p. 92.

during contraction.—1. *Of the changes essential to the act.*—A muscle in action becomes shorter and thicker, and it is well ascertained by experiments often repeated that these changes in its relative dimensions are accurately proportioned to one another. The whole organ neither gains nor loses in bulk.

What is true of the organ is true of the tissue—in contraction it increases in diameter and shortens in a corresponding degree. This is all that can be said in general respecting the visible features of this remarkable phenomenon. Late investigations, instead of explaining the manner in which contraction is effected, by shewing its dependence on forces previously understood, have only served to point out the inadequacy of the coarse and mechanical hypotheses which physiologists have been so prone to confide in, and to make it more than probable that they must ever be content to repose upon the fact above stated as the simplest which the most refined microscopic analysis can ever disclose.

The intimate connexion between the nerves and muscles, both in rest and action, and the exquisite organization displayed in the structure of those muscles which are most quick and energetic in their movements, have powerfully contributed to excite the hope that a clue to the discovery of the physical mechanism of contraction would one day be found. It may be thought, therefore, a subject of disappointment that when at length a close insight into its visible characters has been obtained, and the minutest particles which the best instruments can discern have been brought under observation during their state of activity, the only change that can be appreciated in them is that which was long ago known by accurate experiment to occur in the aggregate mass, viz. that they become shorter and thicker.

All muscle, after systemic death or after removal from the body, undergoes a contraction, termed the *rigor mortis*, which has received much attention in all that relates to the mode of its approach, its course and duration, and the practical bearings it presents. (See DEATH.) This phenomenon may be varied by the application of stimuli, and is eminently suited for the display of the minute changes occurring in muscle during its active state.

The muscle with striped fibres is peculiarly adapted for the display of these changes; for its texture not being homogeneous, but marked throughout with perfect regularity into spaces or particles so minute as to require to be very highly magnified before they can be even seen at all, the anatomist is provided with the means of detecting movements, which, without this circumstance, must have remained concealed. It is accordingly by the study of this variety of the tissue that the results just alluded to have been obtained.

When a fragment retaining its contractility is torn up into its elementary fibres, these are seen to undergo a slow movement at certain points, especially where they have suffered violence, as at their broken extremities. This movement consists of a shortening and thicken-

ing of the material composing the fibre, as is shown by the general outline of the part, but especially by the appearances visible in its interior. The transverse stripes, both light and dark, become longer and thinner; in other words, the discs expand in circumference, flatten and approximate to one another; or to use another form of expression, the fibrillæ become shorter and thicker, both in the particles composing them and the material connecting those particles (*fig. 301*).

Fig. 301.

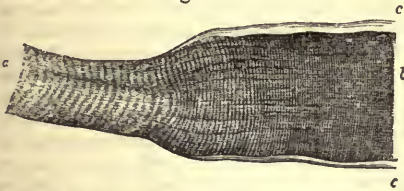

Fragment of an elementary fibre (from the eel) partially contracted in water. Magnified 300 diam.

a, uncontracted part.
b, contracted part, along the border of which, at *c, c*, the sarcolemma is raised from the surface by the water that has been absorbed, that has thereby caused the contraction, and by it has been expelled from the contractile mass.

These changes are always local, or partial, and it is most evident from the characters they constantly present, that they are not limited to any determinate regions, points, or segments, but occur indifferently wherever the exciting cause may chance to be exerted. Neither discs nor fibrillæ appear to have the smallest share, as aggregations of particles bearing those particular forms, in producing the phenomena of contraction. A contraction is never bounded to a particular number of discs or fibrillæ, and is never accurately limited by the interval between two discs. It constantly happens that at the edge of the contracted part several discs are only partially engaged in it. A contraction generally, when commencing at the broken end of a fibre, occupies its whole width there; but when it commences at the border of the fibre it may be confined to a portion of many discs. And, further, a contraction never occupies the whole length of a fibre or fibrilla at once. A contraction excited in an elementary fibre by the contact of a hair extends into the mass equally in all directions, as we might suppose it would do, if the mass were homogeneous.

In a word, an attentive study of these interesting phenomena has convinced me that in the bare fact of contraction the *build* of the fibre is an item of no importance whatever: the exquisite symmetry displayed in the apposition of its component particles is, as it were, disregarded and overlooked, while the whole process is to be referred to the material itself, the ultimate tissue, whose property is *contractility*. This property appears to reside both in the particles and the substance connecting them.

The ultimate movements, therefore, on which contraction depends, whatever they may consist in, are molecular, and far beyond the reach of sense.

It will be perceived that this view of the subject is the only one which can harmonize the fact of contraction in voluntary muscle with the same phenomenon in structures which have no complicated internal arrangement of particles. In regarding contractility, therefore, as a property of the living muscular fibre *in general*, it is meant that it resides in it as a property without which it would not be muscle, and in such a manner that no particle, however microscopic, can be detached from muscle which does not of itself, and independently of the rest, possess this property, as long as it possesses vitality.

It follows from what has been advanced that those hypotheses which refer contraction to a force exerted between determinate but distant points of the fibre, as where the nervous fibrillæ cross it, or at intervals such as Müller* has sometimes seen in insects, must fall to the ground. They are so entirely incompatible with the facts above stated that it can scarcely be necessary to dwell at length on the other reasons for rejecting them, or on the explanation of the phenomena adduced in their support. The main fact on which they have been built is that long ago mentioned by Hales, and more recently studied with minute care by Prevost and Dumas, viz. that in the abdominal muscles of the frog detached and excited by galvanism, the elementary fibres are seen to be thrown more or less into a zig-zag form. It is evident that in interpreting what they saw these eminent physiologists mistook the relaxed fibres for contracted ones. In conducting such experiments many precautions are required, and at the best, nothing of the real process of contraction can be witnessed. As Müller correctly remarks, the muscle is too thick to be seen under a high power. Besides, the shock of galvanism causes only an instantaneous contraction, during which the muscle is so agitated that it is in vain to attempt to examine its condition. It gets out of the focus of the instrument. What is seen afterwards is not the contraction but its result, viz. an approximation of the extremities of the fibres. If the galvanic shock has acted uniformly on all the fibres (which is rare), they all remain straight; but if on a part only, those which have escaped contraction are thrown into zig-zags by having their ends brought nearer through their cellular connexion with neighbouring contracted fibres. It is most natural that the precise point of such flexures should often be determined by the passage of nerves or vessels across the fibres. This is corroborated by the circumstance that relaxed fibres fall at once into zig-zags when their ends are made to approach by mechanical means.

M. M. Prevost and Dumas have themselves drawn attention to an example of shortening without zig-zags in the case of the distended abdominal muscles of the female frog before spawning. They found that the fibres of those muscles when cut across remained straight, after shortening from 145 to 107 millimetres.

* Physiology by Baly, p. 889.

Independently of the immense disadvantage at which the hypothesis in question supposes the force to act, (viz. either between the particles at the retiring angles only of the zig-zags, or between the distant angles themselves,) it seems quite inconsistent with the able experiments of Schwann, which show that the power of a muscle diminishes in a direct ratio with the degree of its contraction. With these experiments, indeed, any hypothesis is at variance which is based on the idea of an attraction between isolated and separate points or particles, as, for example, the sarcous elements, for it cannot be conceived but that such an attractive force would augment in a multiplying ratio with the proximity of the points attracted.

2. *On passive and active contraction.* *Passive contraction.*—Passive contraction is that which every muscle is continually prone to undergo, independently of stimuli, and by the mere quality of its tissue. The muscles are ever kept on the stretch by the nature of their position and attachments, and cannot have their ends so approximated by attitude or otherwise, as that their tendency to shorten themselves shall cease. If, for example, the rectus muscle of the thigh have its extremities brought as near together as can be effected artificially by posture, they would yet be found to approach still nearer on being freed from their attachment to the bones. This tendency to contract has been distinguished by the term *retractility*, from its being manifested by the retraction that occurs when the belly of a muscle is cut across. But, in this instance, the retraction would appear to be in part caused by an active contraction excited by the stimulus of the injury. It has also been styled *tonicity*. The passive contraction of muscles continually opposes their elongation by the action of antagonists, and restores them when that action ceases. It is that which accommodates them to an attitude artificially given, when no muscular effort is required to maintain it. When no active contraction is present in a limb, the passive contraction remains, and being brought to a state of equilibrium in all the muscles by their mutual antagonism, the limb is said to be at rest. This is the general condition during sleep. The passive contractility of muscles, therefore, is being ever exerted, without being attended by fatigue; there seems no good reason for supposing it to be a property different from active contractility; it is rather the necessary condition of that property, in its passive or unstimulated state. Passive contraction is a vital act, for it ceases with the *rigor mortis*.

Active contraction.—This is the form of contraction which is attended with those manifestations of power or force that specially characterize muscle. It is always excited by a stimulus, and is always exerted in opposition to another force within the body, which it is able more or less completely to master. The opposing force is generally the passive contractility of antagonist muscles, but it may be the elasticity of parts, or, in the case of hollow muscles, the resistance of their own contents. Active

contraction is partial in extent and duration. It requires intervals of rest, being attended with exhaustion of the power which produces it, which exhaustion in the voluntary muscles is attended with the sensation termed *muscular fatigue*.

3. *Of the differences between the minute movements of muscle in passive and active contraction.* *In passive contraction.*—It is, perhaps, impossible in the higher animals to observe the nature of the microscopic movements occurring during the passive shortening of a muscle; but in the lower and smaller forms of life this may sometimes be accomplished. It may always appear doubtful, however, whether any contraction that may be here witnessed be entirely of the passive kind, and consequently the movements here noticed are not worthy of implicit reliance. But it is more easy and quite as satisfactory to bring a muscle under inspection, which is still in situ and in equilibrium with its antagonists; in such, contractile force is still present, though its effects are neutralized. This may be done in various small animals; perhaps the tail of small fish or of the tadpole of the common frog is the best adapted for the purpose. In the latter, when deprived of its thick tegument, I have succeeded in gaining such a view, and have found the contraction to be quite uniform throughout, the transverse stripes being stationary and equidistant. This is nothing more than might have been expected on *a priori* grounds. The contraction being the effect of the passive exercise of the property shared equally by all parts of the tissue, would be equal in equal masses, and as the elementary fibres are of precisely equal width and substance from end to end, no part of them could predominate in action, as long as no special stimulus was applied. It may be concluded, therefore, that passive contraction is attended by a movement absolutely uniform throughout the whole mass of an elementary fibre or of a muscle.

In active contraction.—The case is far otherwise in active contraction, as may now be considered proved by a considerable body of evidence.

It might be argued, prior to direct proof, that active contraction, being the answer to a stimulus, must be partial, at least at its commencement, since no stimulus can be applied at the same instant to every particle of a muscle.

Certain features of the contractions witnessed in fragments removed from the body, and examined in water under the microscope, have a close bearing on the present question. It has been already said that such contractions are uniformly partial; but they present two further varieties, either remaining in the part where they first occur, or leaving it as they engage others in the neighbourhood. The accidental circumstances under which the fragments are placed explain these varieties. In the former case the fragments are free to move; their ends approach in proportion to the amount of contraction, and as there is no force to extend them again when the contractile force ceases to be manifested in them, and advances to fresh parts,

the contraction has the appearance of being permanent. In the latter case, certain parts of the fibre (as its broken extremities) are fixed more or less firmly, so as to offer a resistance to the contraction that takes place, this resistance enabling the contractile force advancing to new parts to obliterate the traces of contraction in the parts in which it is subsiding, by stretching them. The ends usually become fixed in consequence of their being the first to thicken from contraction and from their thus receiving the pressure of the lamina of mica or glass with which it is requisite to cover the object, and they are the first to contract, because irritated both by being broken and also by the water, which is absorbed soonest where the sheath is deficient. This fixing of the ends brings the fibres in question nearly into the condition under which they exist in the living body, where it has already been explained that there is always a resistance to be overcome in active contraction. This particular variety of the phenomenon, therefore, deserves special study. Those animals whose muscles are most tenacious of their contractility are the best suited for examination, and among these the young crab or lobster may be most easily obtained. In an elementary fibre from the claw, laid out on glass, and then covered with a wet lamina of mica, the following phenomena are always to be observed. The ends become first contracted and fixed. Then contractions commence at isolated spots along the margin of the fibre, which they cause to bulge. At first they only engage a very limited amount of the mass, spreading into its interior equally in all directions, and being marked by a close approximation of the transverse stripes. These contractions pull upon the remainder of the fibre only in the direction of its length, so that along its edge the transverse stripes in the intervals are very much widened and distorted. These contractions are never stationary, but oscillate from end to end, relinquishing on the one hand what they gain on the other. When they are numerous along the same margin they interfere most irregularly with one another, dragging one another as though striving for the mastery, the larger ones continually overcoming the smaller, then subsiding as though spent, stretched again by new spots of contraction, and again, after a short period of repose, engaged in their turn by some advancing wave: this is the first stage of the phenomenon. (Fig. 302.) The contractions increase in number and extent, and gradually engage the whole substance of the fibre. There is still the same struggle, the same alternate action and repose in individual parts, but as the contractions by degrees predominate, the ends of the fibre are drawn more and more near, (intermediate portions by their contraction receiving some of the pressure,) until at last the whole fragment is reduced to a third of its original length, and stiffened with the *rigor mortis*.

The muscular tissue in these animals is very tough, but where it is more fragile, as in the Frog, it may give way in the intervals between spots of contraction, and become ruptured and

Fig. 302.



Border of an elementary fibre of a young Crab, shewing a spot of contraction (b) and the sarcolemma elevated in the form of bullæ by the expressed water (a). Magnified 300 diam.

disorganized in various degrees.* In fishes I have seen a succession of phenomena similar to what has been described in the Crab; waves of contraction advancing and receding, but gradually augmenting in bulk, till the whole fibre was finally contracted. (Fig. 303.)

Fig. 303.

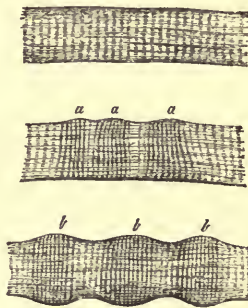

Stages of contraction seen on one occasion in an elementary fibre of the Skate. The uppermost state is that previous to the commencement of contraction.

a, a, a, successive 'waves' of contraction seen moving along one margin of the fibre, marked by a bulging of the margin, by an approximation of the transverse stripes, and by a consequent darkening of the spots.

b, b, b, similar 'waves' still moving along the fibre, but engaging its whole thickness.

In all these examples, as long as the ends of the fragment are fixed, and will not yield to the convellent force, that force is seen to be exerted in a momentary manner in successive portions of the mass. In proportion as they yield to it, the resistance which enabled the contraction of new parts to stretch those from which it was receding is removed, and the appearances of contraction remain. A distinction is required between the contractile force and the contraction resulting from its exercise. The latter will be permanent, if no force from without be exerted to obliterate it by stretching, for a contracted muscle has no power of extending itself; there is no repellent force between its molecules. From these phenomena, therefore, it is possible to eliminate the appearances resulting from a subsided force, and to judge of

* Phil. Trans. 1840, p. 490, pl. xix. fig. 75.

the mode and duration of action of the force itself. Thus sifted, they prove that, even when directly stimulated by water after removal from the body, a muscle contracts in successive portions, never in its totality at once, and that no particle of it is capable of exhibiting an active contraction for more than an instant of time.

The appearances presented by muscle that has been ruptured by its own inordinate contraction in fatal tetanus in the human subject will supply the link wanting to connect the foregoing phenomena with those occurring in healthy contraction during life: for tetanic spasm differs from sustained voluntary contraction only in its amount and protracted duration, and in its being independent of the will; none of which circumstances are of essential importance in regard to the nature of the act of contraction itself.

The muscles are so arranged in the body that no amount of contraction which the mechanism of the bony and ligamentous framework will permit one of them to undergo, can by possibility occasion the rupture of a relaxed antagonist: to be ruptured the antagonist must be itself contracted. But a muscle, if contracting beyond its natural amount, may be so resisted by mechanical powers, in or out of the body, as to rupture itself. Hence, the contraction of a muscle is a necessary condition, and generally the essential cause of its own rupture: the other condition being a force greater than the tenacity of the ruptured part, holding its ends asunder; this latter may be either the active or passive contraction of antagonists, or mere mechanical resistance. But it is evident that for a muscle to be ruptured by its own contraction, that contraction must be partial, as is shewn in the case of the Frog's muscle already mentioned. An examination of muscle ruptured in tetanus is found to bear out these observations in the fullest manner.* The elementary fibres present numerous hulges of a fusiform shape, in which the transverse stripes are very close. These swellings or contracted parts are separated from one another by intervals of various lengths, in which the fibre has either entirely given way or is more or less stretched and disorganized. These appearances are met with after all contractility has departed; they are the vestiges of the spasm during life. Yet in other muscles, which have been likewise convulsed, but not ruptured, they are not found. Their presence is, therefore, the result of the rupture. They admit only of the following explanation: the contractile force has operated at the points contracted, and by its excess the intermediate portions have been stretched to laceration. Having once given way, the contracted parts have become isolated, and can no longer have been extended after the subsidence of their contractile force; they consequently retain the form and appearances they possessed, when surprised, as it were, by the rupture they have themselves produced of the intervening parts.

Supposing, for a moment, that active contraction were a universal and equable act, and

that by the superior power of an antagonist a weak muscle had been ruptured, the appearances resulting would manifestly be entirely different from those now detailed. The fibres beyond their ruptured point would have their transverse stripes uniformly approximated.

From the preceding facts I conclude, 1st, that active contraction never occurs in the whole mass of a muscle at once, nor in the whole of any one elementary fibre, but is always partial at any one instant of time; 2dly, that no active contraction of a muscle, however apparently prolonged, is more than instantaneous in any one of its parts or particles; and therefore, 3dly, that the sustained active contraction of a muscle is an act compounded of an infinite number of partial and momentary contractions, incessantly changing their place, and engaging new parts in succession; for every portion of the tissue must take its due share in the act.

Two phenomena yet remain to be mentioned, which, by admitting of a satisfactory explanation on this view of the subject, give strong testimony to its correctness. The first is the muscular sound heard on applying the ear to a muscle in action. It resembles, according to Dr. Wollaston's apt simile,* the distant rumbling of carriage wheels, or an exceedingly rapid and faint tremulous vibration, which, when well marked, has a metallic tone. It is the sound of friction, and appears to be occasioned by those movements of the neighbouring fibres upon one another, with which the partial contractions must be attended in their incessant oscillations. The other phenomenon is one, the existence of which has been recently ascertained by MM. Becquerel and Breschet,† viz. that a muscle during contraction augments in temperature. They have found this increase to be usually more than 1° Fahr., but sometimes, when the exertion has been continued for five minutes, as in sawing a piece of wood, it has been double that amount. This development of heat seems to be in a great measure attributable to, and even a necessary consequence of, the friction just alluded to.

Thus it would appear that active contraction consists in a disturbance of that state of equilibrium ordinarily existing in muscles when at rest; that their different portions successively undergo momentary contractions, and that there is always a considerable part of each fibre uncontracted. This will account for the remarkable fact that detached fragments of the voluntary fibre will contract by two-thirds of their length, though an entire muscle, in its natural situation, cannot shorten by more than one-third. This great capacity of contraction in the tissue would be without a purpose, if it were not that it only admits of momentary exertion, and therefore requires that in the organ successive parts should take up the act, and by so doing, render it, as a whole, continuous. In an active fibre the contracting parts are continually

* Phil. Trans. 1811.

† Recherches sur la chaleur animale, au moyen des appareils thermo-electriques; par MM. Becquerel et Breschet, Membres de l'Institut. Archives du Museum, tom. i. p. 402.

* Phil. Trans. 1841, p. 69.

dragging on those in which the contractile force has just subsided, and which intervene between them and the extremities of the fibre. These are thereby instantly stretched, and come to serve the temporary purpose of a tendon; but one which resists extension more by its passive contractility than by its mere tenacity. It is these parts which in tetanic spasm suffer laceration; which happens in consequence of the contraction excited by the *vis nervosa*, being then too powerful to be resisted by the passive contractility.

The preceding account of the minute changes occurring during contraction rests on data furnished by the striped form of muscular fibre; but there is nothing contained in it, which seems at variance with the little that is positively known regarding the contractions of the other form. The differences between the contractions of the two varieties are almost certainly confined to the manner of exercise, and do not extend to the essential nature of the act. Though the unstriped fibre has not been studied by the microscope during its active state, with the same success as the other, yet the similarity of the gross changes observed in it by the naked eye, to those seen in voluntary muscle, forbid us to doubt the identity of the phenomenon, in all that essentially constitutes it an act of contraction.

From the knowledge we possess, we are perhaps entitled to hazard some further conjectures respecting the differences in the mode of exercise of the contractile power in different cases. In whatever that mysterious power may consist, it would appear that the structural modifications of the two kinds of fibres are intimately connected with the manner in which it is capable of being exerted. Wherever the striped structure occurs, we witness an aptitude for quick, energetic, and rapidly repeated movements, while, where it is deficient, they are sluggish, progressive, and more sustained. The varieties in the character of contractions performed by striped muscles are very striking, especially that of the heart, as compared with the prolonged action of the voluntary muscles. In both there is an alternate momentary action and repose of every contractile particle, but in the heart the contraction is universal at one instant, and the repose equally universal at the next, while, in the prolonged action of the voluntary muscles, contractions of certain parts of each fibre always co-exist with repose of other parts.*

The contractions of voluntary muscles differ greatly from one another in duration, energy, and extent. Nothing is more wonderful, if it be well considered, than the power the will possesses of regulating the amount of stimulus which it is able to give to the muscles, and that of transmitting it with uniformity during a given period. Dr. Wollaston † was of opi-

nion, that the phenomenon of the muscular sound affords a proof that the *duration* of a muscle's contraction depends on the application to it of a succession of distinct impulses; and this idea, according very nearly, as it does, with the later evidence of observation, appears, on the whole, the most satisfactory that has been advanced on this abstruse subject. He also thought that the intensity of a contraction corresponds with the rapidity with which these impulses are transmitted to it, and this likewise may be, in part, true. But there is, in addition to this, in all probability, a difference in the intensity of the stimulus itself in different cases, producing a difference in the size of each wave, a difference in the amount of contractile energy exerted in each, and a difference in the rapidity with which the waves oscillate along the fibre. The *extent* of the contraction (the duration and intensity being the same) will manifestly depend on the amount of the length of the fibre which is contracted at once. But we are ignorant whether this variation in amount is effected by a variety in the number of waves, or in the extent of the fibre engaged by each of them.

The ancients appear to have been quite ignorant of the nature of muscles. Plato and Aristotle attributed to them so trivial an use, as to think that, like fat, or a kind of clothing, they kept out heat in summer and cold in winter.* The nerves and tendons were confounded with the muscles, as they commonly are at this day, by the vulgar. Borelli, in his elaborate work, *De motu animalium*, † thinks it requisite (in 173†) to adduce arguments against the doctrine that muscle and flesh are different, the former composed of an aggregation of tendinous fibres, the latter a certain villous substance incrustated by the blood upon their exterior, a fact showing the extremely loose notions that prevailed on this subject even up to a comparatively recent period. The fibres so obviously composing the essential part of muscle have been the subject of the most extraordinary speculations, probably ever since it was discovered that they were endowed with contractility, the property which, on a superficial aspect, seemed the most closely associated with life. And it is by no means surprising, that when the microscope began to open a new world to view, it was applied with ardour to the investigation of this tissue. It is not easy to appreciate justly the accounts given of it by some of the earlier micrographers, in consequence of the indeterminate meaning of many of the terms they employed, and the imperfection of the means at their disposal for accurate definition and measurement of the objects they describe. Robert Hooke, however, had probably a correct general knowledge of the elementary fibres of voluntary muscle, and possibly even saw the fibrillæ into which they often split; for we find him in 1678 speaking of the "fibres which seemed like a necklace of pearl in the micro-

* By the expression 'universal at one instant,' I do not mean *absolutely* so, for observation and the presence of the muscular sound both declare that the contraction, even of the heart, though so apparently momentary, is progressive.

† Philos. Trans. 1811.

* Vesalius, vol. i. p. 182.

† Propos. ii.

scope.* Previous to him no author appears to have examined them. But Leeuwenhoek,† his friend and correspondent, makes continual mention of his examinations of the muscular fibre of various animals. This acute and enthusiastic observer clearly recognized the important fact, that each elementary fibre is a perfect and separate organ in itself; he was astonished to find that in all animals, the largest as well as the smallest, these fibres are excessively minute; he discovered the manner in which they are aggregated, and invested by areolar tissue; and by boiling and drying a muscle and then making transverse sections of it, he ascertained those of voluntary muscle to be polygonal and solid. He described the cross lines, which he conceived to be on the surface only and to be the coils of a spiral thread. To this structure he attributed the active power of the fibre, comparing it to an elastic coil of wire. He further saw the longitudinal lines visible on the elementary fibre, and considered them to be an evidence of a still minuter composition by fibrillæ. All these points are well illustrated by figures, which leave no doubt of his meaning; but, as his results are scattered through a great number of letters, much of what he accomplished seems to have been overlooked by later writers. Leeuwenhoek concluded that in contraction the cross markings approximate, but I cannot discover that he speaks of having seen this. He confounded the cross markings seen on tendon with those of muscle, and fell into the prevalent error of attributing contractility to the tendons. Malpighi incidentally mentions the minute structure of muscle in only one passage of his works.‡ He appears to have seen the transverse stripes of the elementary fibre, and to have also likened them to those of tendon. Contemporary with Leeuwenhoek was de Heide,§ who, in 1698, published some observations on muscular fibre, describing and figuring the transverse markings. In 1741, Muys,|| in a voluminous work, with good plates, gave all that was previously known, and added many observations of his own. His book, however, is learned rather than profound. He separates the elementary fibres into the simple and reticulated, and seems to have considered the stripes to be the effect either of minute zigzags during contraction or of a spiral form of the fibrillæ.

Prochaska¶ next produced an excellent treatise on muscle, in which he explained, with great clearness, the figure, size, and solidity of the elementary fibre, and the appearances of the fibrillæ into which it divides. He fell into the error, however, of confounding the transverse markings in the intervals of the discs, with other creasings or flexuosities which never

exist in the living body, but continually present themselves, in the dead fibre, from mechanical causes. All these he attributed to lateral pressure made on the fibre and fibrillæ by vessels, nerves, and areolar tissue, which he erroneously imagined to penetrate the interior of the fibre. Prochaska injected muscle with great success,* and found the vessels so numerous that he was induced to believe contraction to depend on distension of the vessels, throwing the fibrillæ into zigzags.

Fontana,† a few years afterwards, gave a much more accurate account of the fibre than had previously appeared, and one remarkable for its simplicity. According to him the elementary fibre consists of fibrillæ, marked at equal distances by dark lines, which by their lateral apposition occasion the appearance of cross striæ. Hence he styled the fibre a *primitive fasciculus*. By this term, which has been generally adopted, undue importance is attributed to the longitudinal cleavage, for the elementary fibre may as justly be called a *pile* as a *bundle*. It is not, however, in strictness, either one or the other.

In the period that has elapsed since Fontana's description was published, up to the last few years, no real addition has been made to our knowledge, and so discredited or forgotten, at least in this country, were the labours of the authors already enumerated, that the anatomy of the muscular fibre was taken up as a new inquiry in 1818 by Sir Everard Home and Mr. Bauer.‡ The latter very excellent observer must have been deceived by the imperfection of his glasses, which do not seem to have been adapted to so minute a structure, for his results, as published by Sir E. Home, have had the effect of retarding rather than of advancing our knowledge, by raising doubts as to the credibility of any conclusions founded on microscopical research. In 1832, Dr. Hodgkin and Mr. Lister§ re-discovered the transverse markings on the elementary fibre of voluntary muscle and of the heart, and pointed out, as Muys and Fontana had done, that their presence was a character by which this could be distinguished from the fibre of the uterus, bladder, &c., which latter they consequently denied to be muscular. Since then, many inquirers, both in this country and abroad, have taken up the subject with improved instruments.

Among those who have arrived at conclusions similar to those of Fontana may be mentioned the names of Lauth, Müller, Schwann, and Henle. Others, however, have entertained very opposite and, as I believe, erroneous views of the composition of the fibre. Mandl¶ conceives the cross markings to be produced by a

* Posthumous Works by Waller, 1707,—Life, p. xx.

† Epist. Physiologicæ, passim.

‡ De Bombyce, p. 9, 10, written before the year 1687.

§ Experimenta circa sanguinis missionem, fibras motrices, &c. Amstel. 1698.

|| Investigatio fabricæ, &c. Lugd. Bat. 1741.

¶ De carne musculari. Viennæ, 1778.

* Some of these preparations were lately shewn me by Baron Larrey, to whom they were presented by Prochaska himself, during the occupation of Vienna by the French.

† Sur le Venin de la Vipère, &c. 1781.

‡ Phil. Trans. 1818 & 1826.

§ Appendix to Translation of Dr. Edwards's work, De l'Influence des Agens Physiques sur la Vie.

¶ Traité pratique du Microscopie, p. 74-5. Paris, 1839.

spiral thread of areolar tissue investing the fibre, and Mr. Skey* describes them as an external structure, independent of the fibrillæ, which he believes to be arranged in band-like sets around a glutinous substance in the axis of the fibre. Ficius† falls into the old error of Prochaska, of imagining the striæ to be the result of minute flexures of the fibrillæ, and, like him, he confounds with them the secondary flexures of the whole fibre. Hence, says he, the appearance of globules or particles is false, and only exists during contraction. Other opinions still I have had occasion to allude to in the course of the article *MUSCLE*, which, as before remarked, is founded on observations which have been now two years before the public.‡

All the best observers are agreed as to the existence of certain appearances, and the discrepancies we encounter in the interpretation of them ought not to bring discredit on all researches of this sort. They place, indeed, in a strong light the difficulty of the inquiry, and the necessity for repeated, varied, and unbiassed observation, with the best instruments we can command. But we are too familiar with conflicting and even opposite statements concerning visible facts, occurring daily under the eyes of every one, to suppose it possible that any kind of investigation will ever be free from those causes of error, which lie in man's nature, in his own *microcosm*, and the effects of which can only be neutralized by the common consent of numerous independent observers. As for those difficulties, whatever they may be, which are inherent in the nature of the subject, we cannot doubt that they will be, in due time, appreciated and overcome.

Some of the opinions concerning the nature of contraction, entertained by the earlier observers, have been already mentioned; another, which seems to have been grafted on the doctrine of the vital spirits, was, that these spirits were directed into the fibres and distended them, thus causing them to tumify and shorten. Accordingly, some (as Robert Hooke and Cowper) considered each fibre or fibrilla to be hollow; which need not excite surprise, when we find the great Mascagni§ believing each to be a lymphatic vessel. The first hint of another very noted hypothesis is to be found in the *Memoirs of the French Academy, 1724*:—L'Abbé de Molières there says,|| “Les fibres charnues qui s'étendent selon la longueur du muscle, et dont le raccourcissement fait son action, se divisent en un grand nombre de petites fibres de même nature longitudinales aussi, et qui sont liées les unes aux autres par des filets nerveux transversaux disposés le long des fibres de distance en distance. De plus, les petites fibres charnues ne sont pas droites, mais pliées en zigzags, dont les angles se

trouvent aux endroits, où sont les filets transversaux.” Hales* examined the abdominal muscles of small living frogs, and saw them thrown into zigzags during contraction, as he imagined; but he mistook the uncontracted for contracted fibres, as I have explained.† Prevost and Dumas, at a later period,‡ described the same zigzag flexure of the fibres during contraction, and further imagined it to be an electrical effect produced by the passage of the nerves across them at their angles of flexure. This doctrine was too captivating not to obtain very general credence, especially as it seemed to fall in with a notion, at that time very current among speculative physiologists, that the nervous influence is a form of electricity. But its validity has of late begun to be questioned; Professor Owen,§ in small filariæ and in a species of vesicularia, observed a fact opposed to it, viz. the bulging of the (unstriped) fibres near their centre, without their falling out of the straight line, in contraction. A similar fact was observed in the case of the (unstriped) muscles of the *Polypifera*, by Dr. A. Farre;|| and Dr. Allen Thomson,¶ on repeating the experiment of Hales and Prevost on the Frog, “observed single fibres continuing in contraction, and being simply shortened, and not falling into zigzag plicæ; and he was led to suspect, from this and other circumstances, that the zigzag arrangement was not produced until after the act of contraction had ceased.” M. Lauth, after a careful investigation, concludes** that a fibre may shorten with or without zigzag inflection. Such, I believe, was the state of this question in 1840, when I published the observations,†† on part of which the account of the nature of contraction, given in the present article, is principally based. In the following year I added‡‡ a note, on the appearances met with in human muscle ruptured by tetanic spasm, and which seemed to me to prove that the conclusions I had previously drawn from the phenomena of the *rigor mortis* were true as regards the act of contraction, as it occurs in the *living body*.

BIBLIOGRAPHY.—To the following works may be added the several systematic treatises on descriptive anatomy, and on general anatomy and physiology. Hooke, *Posth. Works*, by Waller, 1707. *Experiments and Observations of Robert Hooke*, &c. by W. Derham, 1726. *Malpighi, De Bombycibus*, p. 9, 10. *Leeuwenhoek, Phil. Transact.* 1674, 1677, 1683, &c. *Epist. Physiolog. passim.* *De Heide, Experimenta circa sanguinis missionem, fibras motrices, urticam marinam*, &c. Amstelod. 1686 and 1698. *Croone, De ratione motus musculorum*, Lond. 1664. *Muys, An account of several observations concerning the frame and texture of the muscles*, *Phil. Trans.* 1714. *De car-*

* *Hæmastatics*, p. 59.

† *Phil. Trans.* 1840.

‡ *Majendie's Journal*, 1825.

§ *Hunter's Works by Palmer*, vol. iv. p. 261—2, *note*.

|| *Phil. Trans.* 1838, pp. 394 and 396.

¶ Quoted by Owen, *loc. citat.*

** *L'Institut. No. 73*, quoted by Müller in his *Physiology, Baly's Transl.*, p. 888.

†† *Phil. Trans.* 1840, pt. ii.

‡‡ *Phil. Trans.* 1841, pt. ii.

* *Phil. Trans.* 1837.

† *De Fibræ Muscularis Formâ et Structurâ*. Lipsiæ, 1836.

‡ *Phil. Trans.* 1840.

§ *Prodromo della grande Anatomia—da Franc. Autmarchi*, Firenze, 1819.

|| *Malgaigne, Anat. Chirurgicale*, vol. i. p. 102. Paris, 1838.

nis musculosæ structurâ, Lugd. Bat. 1730. Investigatio fabricæ, quæ in partibus muscularibus component. extat. Lugd. Bat. 1741. *Borelli*, De motu animalium. Ed. Neapoli, 1734. *Cowper*, Myotomia Reformata. Introduct. *Haller*, Element. Phys. lib. xi. *Hales*, Statical Essays, Lond. 1741. *Prochaska*, De carne musculari, Vindobon. 1778. *Fontana*, Traité sur le venin de la vipère, Flor. 1781. *J. Hunter*, Croonian Lectures, 1781, Works by Palmer, vol. iv., notes by Owen, Lond. 1838. *G. R. Treviranus*, Vermischte Schriften, Gött. 1816. Beiträge zur Aufklärung, &c. *P. Mascagni*, Prodomo della grande anatomia, Firenze, 1819. *Home* and *Bauer*, Phil. Trans. 1818 and 1826. *Milne Edwards*, Mémoire sur la struct. element. &c. Paris, 1823; Ann. des Sciences, 1826. *Prevoost & Dumas*, Majendie Journal de Physiologie, 1825. *Hodgkin* and *Lister*, Appendix to a Translation of W. F. Edwards "on the Influence of Physical Agents on Life;" and Annals of Philosophy, 1827. *Valentin*, Histor. evolutionis syst. musc. prolusio. Wratislav. 1832; Ueber den Verlauf und die letzten Enden der Nerven. *F. C. Emmert*, Ueber Endigungsweise der Nerven in den Muskeln, Bern. 1836. *E. Burdach*, Beitrag zur Mikroskopisch. Anatomie der Nerven, Königsburg, 1837. *Roulin*, Majendie Journal, vol. i. *G. H. Meyer*, Diss. Inaug. de Muscul. in duct. efferent. gland. Berol. 1837. *Krohn*, Müller's Archiv. Jahrg. 1837; Heft. 3, 4; Brit. and For. Med. Rev. Ap. 1838. *Ficinus*, De fibræ muscularis formâ et structurâ, Lipsiæ, 1836. *Schwann*, in Müller's Physiology by *Baly*, Lond. 1837-41. *Baly*, in the same, pt. iv. description of plate. *Lauth*, l'Institut, No 73. *Shay*, Phil. Trans. 1837. *Malgaigne*, Anatomie Chirurg. vol. i. *Mandl*, Anatomie Microscopique; Traité Pratique du Microscope, Paris, 1839. *Guliver*, Observations on the musc. fibres of the œsoph. and heart, &c. Zoolog. Proceed. No. 81, 1839. *Henle*, Allgemeine Anatomie, Socmmering, 6ter Band. 1841. *Palicki*, De musculosa cordis structurâ, Wratisl. 1839. *Barry*, Phil Trans. 1839-40-41-42. *Bowman*, Phil. Trans. 1840-41.

(W. Bowman.)

MUSCULAR SYSTEM, (COMPARATIVE ANATOMY OF).—The muscular system of animals, as the term is generally understood, is composed of masses or fasciculi of highly irritable filaments, by the contractions of which the movements of the body, whether voluntary or involuntary, are effected, and the arrangement of these moving powers, their size and strength, forms and general disposition, must of course vary *ad infinitum* in the different classes of animals, in conformity with the varieties of their external form, or the innumerable kinds of apparatus conferred, for special purposes, upon particular tribes or even species of living beings. Of these detailed accounts are elsewhere given in those articles which treat of the structure and anatomy of each class entering into the composition of the animal kingdom. Nevertheless, it has been deemed advisable, upon the present occasion, to collect together in one view the principal facts connected with general myology, and to state, as briefly and concisely as the nature of the subject will allow, those grand physiological points which an extended review of the comparative organization and development of the muscular system reveals to the anatomical observer, in order to concatenate the leading facts recorded in other pages of this work.

It may be laid down as an axiom universal

in its application, that *the condition of the muscular system in any race of animals must be dependent upon, or at least in strict conformity with, the development of the nervous apparatus, by the influence of which muscular movements are excited, controlled, directed, and associated.*

Thus, as we advance from lower to more elevated forms of living creatures, it is easy to perceive that in exact proportion as the nervous system makes its appearance, and becomes progressively more elaborately organized, the muscles themselves become developed and assume a perfection of structure and precision of movement adapted to the increasing exigencies of the animal economy; nay, it has now been satisfactorily established that even among the highest races of the animal creation, during the progress of embryo development, the most intimate relation is observable between the state of the nervous centres and the condition of the nascent muscles as they become gradually formed and perfected. In the lowest Zoophytes where nervous fibres of any kind are not perceptible, even under the most rigid microscopical examination, the contractile tissue of the body is equally diffused and devoid of aggregation into filaments or fasciculi of muscular fibre, and precisely under the same conditions the first rudiment of the vertebrate embryo, being as yet entirely devoid of nerves, is also destitute of distinct muscles, the movements of which could only be associated and rendered efficacious by means of nervous intercommunication; and this complete want of aggregation of the elements of muscular tissue is as remarkable throughout all the *Acrite* division of the animal world as it is in the nervous matter entering into the composition of their bodies, which, although its presence is not to be detected by our senses, is reasonably supposed to exist in a diffused state even in the lowest tribes of animated beings. As soon as nervous threads become apparent, and long before ganglionic masses of neurine are developed to such an extent as to entitle them to be regarded as centres of innervation, the muscular tissue, in like manner, assumes a different and far more perfect character; the elementary molecules composing muscular fibre are then distinctly visible, and assuming a definite arrangement become grouped in longitudinal series, exhibiting contractile bands and fascicles placed in precise directions, and capable of effecting movements of a more decided character than could possibly be exercised in creatures deprived of nervous cords, whereby the contractions of numerous muscular fasciculi might be associated and made to cooperate for the accomplishment of a given purpose.

Moreover, it must be obvious that, in that great division of the animal creation which is characterized by the existence of nervous filaments, the ganglionic centres being as yet imperceptible, or at least where any have been detected, in a very rudimentary state of development (the *NEMATONEURA* of Professor Owen); such a condition of the nervous apparatus involves, as a necessary consequence, important circumstances connected with the general economy of the beings so organized as

regards their means of relation with the external world. Having as yet no ganglia developed sufficiently important, from their size or situation, to merit the title of brains, or fit to be regarded as constituting a common sensorium, whereunto information derived from remote parts of the body may be conveyed, localized instruments of sensation would be as yet superfluous, and consequently, with the exception of the generally diffused sense of touch which, from its extreme delicacy, seems in these lowest forms of existence to supply to a certain extent the deficiency of other means of perception, instruments of sensation are not as yet conferred. The presence of a localized organ of sense, analogous to an eye or an ear, must obviously be useless to a creature possessed of no sensorial centre, to which information, derived through the medium of that sense, may be transmitted, and organs of the higher senses are, therefore, as yet entirely wanting throughout the NEMATONEUROSE division of the animal kingdom,* as, *à fortiori*, they are necessarily deficient throughout the ACRITE classes. In like manner the existence of external locomotive members, moved by any powerful or elaborately constructed muscular apparatus, is not to be expected in animals that possess not ganglia capable of presiding over voluntary muscular motion. Limbs, therefore, properly so called, are not as yet developed; and, if in some of the most perfect Epizoa, the rudiments of such structures become apparent, it is only because the animals possessing them are so nearly allied to the Articulata, in their general structure, that the nervous ganglia in them are beginning to be developed, and thus they can only be looked upon as the transition steps leading by an almost imperceptible gradation from one great type of animal organism to another of a more elevated character.

In the ARTICULATA (HOMOGANGLIATA, Owen), brains, or ruling ganglionic centres, for the first time make their appearance in a sufficient state of development to correspond with organs of sense of a localized character, or to animate systems of muscles adapted to wield locomotive limbs, and combine complex actions now essentially connected with the more perfect attributes bestowed on forms of life capable of more extensive relations with surrounding objects. Still, however, an exact correspondence exists between the progressive expansion of the nervous centres and the gradual

* In laying this down as an important physiological axiom, a few words of explanation will be required by those, who, adopting Ehrenberg's views, regard the red spots observable upon numerous Animalcules and Zoophytes as being the eyes of those creatures. That many species of such animals possess red spots occupying definite positions upon different parts of their bodies, no one will be disposed to deny who has paid the slightest attention to their economy and organization; but that these red spots are eyes, we think, for the reasons above stated, may reasonably be doubted, more especially as it has not even been proved by observation or experiment that they possess either the structure, or the functions of any visual apparatus, with which we are acquainted.

appearance of limbs moved by a distinct muscular apparatus, which become progressively superadded to the annulose body or trunk of the articulated animal, and in precisely the same manner does the advancement of the nervous system from a less perfect to a more concentrated condition evidently precede the appearance of external appendages, subservient to the exercise of more exalted powers of sensation, or increased capabilities of locomotion. The humblest annulose forms, as for example the *Leech* and the *Earthworm*, possessing, as they do, a nervous system consisting of an extended series of numerous pairs of feeble ganglia, none of which are as yet sufficiently potent to control any complex muscular apparatus, or to appreciate impressions derived from without with much nicety or precision, are necessarily deprived of outward limbs, or complicated instruments of sense; their soft and flexible integument is unequal to sustain any jointed members whatever, and the first rude vestiges of simple eyes, *ocelli*, are all that can be allowed for the purposes of vision. By degrees the nervous ganglia becoming fewer in number as they coalesce into larger and proportionately more energetic masses, the moving organs of the body become perfected in the same ratio; limbs, almost impotent as yet, but still sketching out the articulated legs hereafter to be perfected, make their appearance, and the apodous Annelidan, the humble inhabitant of the water, is promoted to a terrestrial existence; jointed feet at length become appended to the segments of the still worm-like body, small and feeble at first, as in the *Iulus terrestris* and the other vegetable-eating MYRIAPODS, but speedily, in proportion as the individual segments of the body become enlarged and strengthened, and the motor ganglia acquire increased energy, assuming larger dimensions and greater perfection of structure, until the annulose animal attains the strength and activity of the carnivorous *Scolopendra*, and becomes fitted for a life of rapine and destruction.

Advancing from the *Scolopendra*, which as yet is only able to creep upon the surface of the ground, we are at length conducted to the far more active and highly gifted races of INSECTS, properly so called, in which the development and perfection of the muscular system is advanced to a condition adapting these wonderful little beings to an aerial existence, and in making the transition from Myriapod to the Insect the carrying out of the same great law is most obviously and conspicuously illustrated. The nervous ganglia, still numerous and proportionately feeble even in the *Scolopendra*, become in the aerial insect reduced in number until they are collected into a few large and potent masses; senses of a wonderfully exalted description, correspondent with the increased size of the encephalic ganglia, replace the simpler organs of the less exalted Articulata; those segments of the body whereunto locomotive members are appended coalesce and become fused together into a dense and strong thoracic armour able to sustain the violent efforts of the powerful muscles now re-

quired for flight; the corresponding ganglia contained within the thorax exhibit a size and development proportioned to that of the muscles they are destined to animate; and the winged Insect becomes thus competent to the exhibition of feats of strength and activity not to be paralleled in any other race of living beings.

On taking a survey of the molluscous or of the vertebrate divisions of the animal creation, the same great law is every where apparent, and we are reminded, on all hands, that a strict parallelism exists between the condition of the locomotive system, whatever may be its character, and the perfection of the nervous apparatus, whereby muscular movements are controlled and directed. As a necessary consequence of the above intimate and inseparable relation, which invariably exists between the organs of motion and those of innervation; and allowing, as modern Zoologists all admit, that the nervous system, whatever may be its condition, is to be regarded as the ruling primary portion of the animal economy, we are naturally led, therefore, in reviewing the muscular system generally, to take this great physiological axiom as our guide, and beginning with the simplest forms of life to trace the first appearances and successive complication of the motor organs as we advance through the different classes of animated beings.

In the Cuvierian classification of the Règne Animal all the lower animals, originally confounded under the general name of Zoophytes, are included in one great division, called *RADIATA*, from the circumstance that many forms of these animals exhibit more or less of a radiated arrangement in the general outline of their bodies. For the term *RADIATA*, in the article *ANIMAL KINGDOM* of this Cyclopædia, Dr. Grant has substituted that of "*CYCLONEURA*," acknowledging, at the same time, that the name selected by him was of equally partial application, and consequently unsatisfactory; inasmuch as, in the great majority of the animals ranged under it, so far from any nerves being visible, "disposed in a circular manner around the oral extremity of the body," not a trace or vestige of nervous fibre is by any means discoverable; and, moreover, many of the animals thus grouped under one denomination are so remote and dissimilar from each other in every feature of their economy, that it is impossible to regard them even as being organized according to the same type. As regards the condition of their muscular system, the most striking differences are at once perceptible; the *Sponges*, the *Polyps* properly so called,* the *Polygastrica*, and the *Acalephæ*, have the texture of their bodies so soft and gelatinous, that a mus-

cular fibre is by any means apparent in any of them; while, on the other hand, the *Echinoderms* have muscular systems constructed upon exceedingly elaborate and complex principles. Taking the nervous system for our guide, it is at once evident that the presence of nerves and of muscles goes hand in hand, and the *RADIATA* of Cuvier or the *CYCLONEURA* of Grant is at once separable into two great groups, one division being without either visible nerves or muscles, while the other is found to possess both. Classifying them, therefore, according to this principle, and adding to the list of radiated animals some which, in the article *ANIMAL KINGDOM*, have, as we think, been erroneously included in the *Diploneurose* (articulated) sub-kingdom, they readily range themselves under the following denominations:—

ACRITA.

Animals with neither nerves nor muscles.

Agastrica.
Polypifera.
Polygastrica.
Acalephæ.
Stereelminthia.

NEMATONEURA — Animals possessed both of nerves and muscles, either without perceptible ganglionic centres of innervation, or where these do exist, they are extremely rudimentary, and not arranged in any parallel series. This division will include

Cælelmintha,
Bryozoa,
Rotifera,
Epizoa,
Echinodermata.

The term *Agastrica* is here proposed to include those lowest forms of animal existence which obviously form the transition from the Vegetable to the Animal Kingdom; many of them indeed seeming rather to belong to the former than to the latter division of the organized world. Such are, for example, the confervoid animalcules, which, in their structure and mode of reproduction, are evidently nearly allied to vegetables, although from the seemingly spontaneous movements of which some, the *Oscillatoria*, &c. are capable, they have been claimed by Zoologists as belonging to their department. The *Sponges* (*Porifera*, Grant) are equally allied to vegetables in the nature of the living parenchyma that invests and forms their porous or reticulated skeletons; and most intimately related to these, notwithstanding the different texture of their framework, are many of the lithophytous *Corallines* and *Fungia*, the solid portions of their skeleton being in like manner deposited in an organized soft tissue, the animal nature of which is by no means as yet clearly established. All the above plant-like forms agree, however, in one grand and striking circumstance,—they are devoid of any stomachal or digestive cavity, a feature of their economy which of itself would be sufficient to raise a doubt whether they are strictly entitled to be regarded as animals or classed with the vegetable creation.

* In the article referred to, polypiform animals, with ciliated tentacula around the mouth, are classed with the *Polypifera*. Recent observations made by Lister, Milne Edwards, Ehrenberg, and Dr. Arthur Farre, have, however, since shown such creatures to be so far removed in their general organization from the true Polyps, that they now constitute a distinct class under the title of *Bryozoa*.

We need scarcely say that in the *Agastrica* no muscular system whatever can be detected, the living portions of their bodies being entirely made up of a soft granular parenchyma which only dubiously exhibits contractile movements under any circumstances.

In the *Polypiphera* we find a very extensive group of animals naturally allied to each other in the general details of their economy, but offering very great diversity of structure and external form. In the simplest or gelatinous *Polyps* (*Hydridae*) the acrite condition of the nervous and muscular tissues is most conspicuously exemplified. Examined under the microscope, the entire substance of the minute gelatinous bag composing the body of the Hydra seems to consist of a glairy material, wherein are suspended coloured globules that constantly change their relative positions, and move about from place to place as the creature contracts, or extends different parts of its substance, but not a fibre or filament is discernible passing in any direction, nevertheless the movements of the Hydra appear to be performed with facility, and its powers of locomotion are considerable.

In the *Alcyonidae* and other compound cortical *Polyps*, muscles of any kind are equally invisible, and the contractions observable either in the substance of the common body or in the numerous hydriform mouths that minister to the support of the general mass, seem to be entirely due to the approximation of molecules diffused through the entire substance of the animal, rather than dependent upon any thing like muscular structure; nevertheless it has been stated, though perhaps erroneously, that some families (the *Pennatulidae*) are able to swim from place to place by consentaneous movements of the polyps and polyp-bearing arms with which many species are provided.

The tubular *Polyps* are equally devoid of any thing like muscular fibre, nevertheless the soft and uncalcified membrane that connects the *Polyps* to the cells wherein they are lodged, and the hydriform *Polyps* themselves, are endowed with the capability of performing all the movements required to protrude the flower-like bodies from the cups that contain them, and to seize and swallow the materials required for their support.

But in every group of animals, as we approach the most highly organized members of that group, we find the characters of a more exalted type of organization beginning to manifest themselves, and thus in the *Actiniadae*, which are obviously osculent between the Acrite *Polyps* and animals possessing a true muscular system, a fibrous arrangement of the contracting portions of the body becomes very distinctly recognisable, and a nervous filament may be displayed under favourable circumstances passing round the oral extremity of the creature, and thus closely approximating the nematoneurose type of structure. The infusorial animalcules (*Polygastrica*, Ehren.) seem, as far as relates to their muscular system at least, to be strictly acrite animals, but such is their extreme minuteness, that much uncertainty

still necessarily exists concerning their intimate organization. Their locomotive apparatus most frequently consists of fringes of vibratile cilia variously disposed, the movements of which are most probably dependent upon the existence of a peculiar vital tissue distinct from muscle. In many species, e. g. the *Proteus* (*Amœba diffluens*), the contractions of the body are extensive, so that even the outward form of the animalcule is perpetually changing, and some, the *Vorticellæ*, are attached to highly irritable pedicles of exquisite tenuity, that may be straightened or suddenly thrown into close spiral coils by some inherent power, the nature of which is as yet quite incomprehensible. In some, as for instance *Chilodon uncinatus*, moveable hooks are found to be appended to the surface of the animalcule, and some (*Nassula*) are provided with a peculiar dental apparatus, consisting of a minute cylinder of horny filaments; nevertheless no appearance of muscular or nervous fibre has as yet been detected even in the largest and most conspicuous species.

The *ACALEPHÆ* next claim our notice as members of the Acrite division of the animal creation, and in every point of their economy they strictly conform to the general characters belonging to this type of organization. (See *ACRITA*.) Their bodies are soft, pellucid, and gelatinous, without any trace of muscular fibre being perceptible in their composition; their digestive canals are excavated in the parenchyma of the body, not contained in any abdominal cavity, and the canals through which nutriment is conveyed to different parts of the system are entirely devoid of proper external coats; neither, as we believe, do nerves exist in any of the class, although, as we are well aware, two eminent observers have entertained a contrary opinion. Professor Grant,* in his account of the anatomy of *Cydippe pileus*, describes a double ring of nervous fibre as surrounding one end of the alimentary canal of that beautiful little Acaleph, and has even figured ganglia distributed at intervals upon these circular cords, from which secondary nerves are described as emanating. Such a circumstance as the existence of nerves and ganglia in an animal confessedly acrite, and presenting no traces of that type of structure which, in all other cases, invariably accompanies so elevated a condition of the nervous system, from its very singularity was well calculated to attract the notice of the physiologist, and we are ourselves quite satisfied that the distinguished professor has been led into error upon this point, most probably from having mistaken the circular canals, described by Delle Chiaje and others, as surrounding the oral extremity of the *Beroes*, and which are indeed frequently filled with an opaline fluid, for nervous fibre.†

* Vide *Transact. of the Zoological Society of London*, vol. i. and the figure at p. 109, vol. i. of this work.

† At the Birmingham meeting of the British Association, during a very interesting discussion upon this point, it was agreed by Mr. Forbes and Mr. Thompson, whose qualifications for such re-

Professor Ehrenberg has more recently announced that he had detected a nervous filament encircling the margin of the disc in one of the pulmonigrade *Acalephæ*, and connecting the red spots, which he is pleased, as we think without sufficient reason, to call *eyes*, with each other. Such a nervous system would, at least, be anomalous; and, notwithstanding the justly high reputation of the eminent professor of Berlin, we cannot but think that the interests of physiology require us to pause before we assent to the views of Professor Ehrenberg, as relates to the nature of the filament in question.

In the *Sterelmintha* or parenchymatous Entozoa of Cuvier, the same acrite condition, both of the nervous and muscular systems, is still observable in the lower forms belonging to this group of internal parasites, which being, for the most part, in their natural situations either enclosed in cells or closely imbedded in the substance of the viscera of other animals, could not be expected to have any power of locomotion conferred upon them; their bodies are, therefore, in the simplest species (such as the Hydatids, *Cysticerci*) mere membranous bags of homogeneous texture, and without a trace of fibre in their composition: their powers of moving are proportionately feeble, and are limited in fact to slight contractions, which are but indistinctly perceptible on the application of stimuli to the surface of the living animal.

In the Tape-worms (*Tæniæ*) the presence either of nerve or muscle is equally imperceptible, and the whole structure strictly conformable to the Acrite type. As, however, we mount higher in the scale of organization among these parasites, we again find how nearly succeeding types of structure are made to approximate, and even to a certain extent to become blended, as it were, with each other. In the Flukes (*Distoma*) and kindred genera, and in many of the Acanthocephalous *Sterelmintha*, although their structure is evidently parenchymatous, the skin, without presenting any decided appearance of muscular fibre, becomes more coriaceous and contractile, and at the same time nervous filaments become dubiously perceptible: a transition is obviously in progress, and thus we are gradually introduced to another and a more elevated series of animals.

The NEMATONEURA, as is obvious from every part of their economy, are gifted with higher attributes, and permitted to enjoy a more extended intercourse with external objects than any creatures comprehended under the preceding division. They are no longer rooted to one spot or imprisoned in enclosed cavities, but, on the contrary, are for the most part erratic in their habits, and in many of them the locomotive system is so efficiently constructed that their movements, exhibiting considerable activity and energy, argue the possession of distinct and precisely arranged muscles,

searches are well known, that, although they had examined several hundred specimens of the *Beroë* in question, for the purpose of ascertaining this important fact, their endeavours to detect the nervous system referred to had been entirely unsuccessful.

and display such combination and consentaneous action of different parts of the body co-operating to produce a given result, that the existence of an intercommunication throughout the system by means of nerves might readily be predicated, even had not anatomy revealed to us that such animals actually possess a nervous apparatus. It would seem indeed to be clearly indicated by the physiological relations that exist between the two systems, that the possession of muscular fibre arranged in distinct fasciculi involves, as a matter of course, the co-existence of nervous threads, whereby the actions of distinct and distant muscles may be associated for the attainment of a common object; and accordingly we find that these two important additions to the animal economy make their appearance simultaneously. No large ganglionic masses are as yet developed of sufficient importance to be regarded as constituting a common sensorium, to which the perceptions derived from external senses must be referred, and from whence mandates of volition can be supposed to emanate. Senses, therefore, that is, localized and special senses, cannot as yet be given; the traces of individuality are but feebly recognizable; the vital powers are still, to a great extent, diffused throughout the different tissues of the body, and not collected and concentrated, as in animals possessed of brains, that is, of centralized and dominant aggregations of neurine; and, as a consequence of this important circumstance, some of the most striking characters common to the ZOOPHYTES still linger in this division of creation; the radiated form is yet extensively met with, multiplication by mechanical division of the body is still, to a certain extent, possible, and severed portions of the body are found to be reproduced by growth from the mutilated part.

The CœLELMINTHA or cavitory intestinal worms, living in the interior of other animals, differ in so many points from the Acrite Entozoa, that Cuvier, although in the *Règne Animal* he was content to group them together in the same class, was obliged to separate them into two distinct orders, calling the STERELMINTHA "*intestinaux parenchymateux*," while the more highly organized are designated "*intestinaux cavitaires*." The Cœlelmintha, in fact, are organized in accordance with quite a different type of structure, as must be at once evident upon the slightest comparison between them. The digestive apparatus is now no longer composed of tubes excavated out of the general mass of the body, and presenting no outlet for the escape of egesta, but a distinct alimentary canal now makes its appearance, suspended in a capacious abdominal cavity, wherein, moreover, are lodged the male and female organs of generation, which in the Cœlelmintha are generally found in different individuals. The parietes of the body are in these worms obviously muscular, and are composed of contractile fibres arranged in superposed strata and affecting different directions. Towards the exterior of the body they are disposed longitudinally, but the inner layers assume a circular or spiral

arrangement; such a disposition providing for the extension or shortening or lateral inflexions of the worm, and enabling the animals so constructed to move about with facility in the cavities wherein they reside.

Nevertheless, at this, its first appearance in the animal series, muscular fibre has not as yet attained to the perfection of structure that it offers in the higher classes. The fibres are as yet indistinct, soft, and gelatinous; they appear to be deficient in fibrin; neither do they, when examined with the microscope, present the transverse striæ that are so characteristic of the muscular tissue in a more advanced condition. The little fascicles are, moreover, extremely short, and run but a little distance before they disappear, and are succeeded by others. Their whole appearance, in fact, is that of muscle in a rudimentary condition, and very accurately resembles the nascent muscular tissue when it first becomes apparent in the embryo of the vertebrate animal. The nervous system accompanying this condition of the muscles is extremely simple; a delicate ring surrounds the commencement of the œsophagus, by which, perhaps, the muscles of the mouth are associated during the act of imbibing nourishment, and prolonged from this ring are two long and thread-like nerves, one running along the dorsal and the other along the ventral aspect of the body, and passing quite from one extremity to the other, but without any perceptible ganglionic enlargements in their course.* Having, therefore, no brains or central masses to which perceptions could be referred, localized organs of sense are likewise wanting in all the CELELMINTHA. The BRYOZOA which, while naturalists were ignorant of their more complicated organization, were, until a recent period, confounded with the Polyps, are, from their entire structure, very justly entitled to a much higher position in the scale of animals, and undoubtedly belong to the Nematoneurose type. These little beings inhabit transparent cells of very elaborate and delicate construction, from the mouth of which they protrude the anterior portion of their bodies when in search of food. Although from their general appearance the Bryozoa might easily be, and in fact have been until recently, erroneously regarded as Polyps, the differences between the two classes are exceedingly striking and important. The Bryozoa, instead of having the tentacula that surround the oral aperture quite simple and filamentary, as the Polyps have, are furnished with ciliated tentacula, and from the rapid ciliary movement which is incessantly going on, while the arms are expanded, strong currents are formed in the surrounding water, all of which impinging upon the oral orifice bring to the mouth such nutritive materials as are necessary for the support of the creature. The digestive apparatus is no longer a closed

sacculus, as in the Polyps, but, on the contrary, presents a very elaborate structure, consisting of a gizzard, stomach, and distinct intestinal canal, terminated by an anal aperture, though which the fœces are ejected; and, moreover, the whole of the digestive viscera float loosely in a visceral cavity wherein they are suspended. In addition to this, the mouth of the cell occupied by the Bryozoon is defended by a most delicate and complicated opercular apparatus, requiring a very perfect set of muscles to perform all the required movements connected with the protrusion and retraction of the body, so that there is abundant reason for separating the animals in question from the Acrite Zoophytes.

As relates to their muscular system, rudimentary in its development as it must still necessarily be, many circumstances of great interest have been brought to light by the patient investigations of Dr. Arthur Farre, to whose valuable memoir* we are indebted for the following particulars, which we give at some length, more especially as they will serve not only to elucidate this part of our subject, but to correct several important errors that have been promulgated relative to the ROTIFERA, an important class of animals next to be noticed, of very analogous structure.

For the purpose of drawing the protruded Bryozoon into its retreat two distinct sets of muscles are provided, one set acting upon the *animal* and the other upon the flexible operculum that closes the cell. The muscles for the retraction of the *animal* are contained in the visceral cavity, and consist of two bundles of delicate thread-like cords, the one set arising from the bottom of the cell to be inserted about the base of the stomach, the other also arising from the bottom of the cell and passing up free by the sides of the pharynx to be inserted around the line of junction between this organ and the tentacula.

The muscles provided for the retraction of the operculum consist of six flattened bundles of fibres, which act upon the flexible portion of the cell and a delicate circle of setæ placed around its orifice. It is at once evident therefore that the muscular system in the Bryozoa is capable of great precision of action, and the fasciculi are most accurately adjusted. Nevertheless if the intimate structure of this form of muscle be investigated, it is found not to have attained to full perfection. "It would appear," says Dr. Arthur Farre, "as if muscular fibre were here reduced to its simplest condition. The filaments are totally disconnected, and are arranged one above the other in a single series. They pass straight and parallel from their origin to their insertion, and have a uniform diameter throughout their course, except that each filament generally presents a small knot upon its centre, which is most apparent when it is in a state of contraction, at which time the whole filament also is obviously thicker than when relaxed. The filaments have a watery

* The dorsal nervous cord of the *Ascaris*, first described by Cloquet, (*Anatomie des vers intestinaux*,) seems to have been overlooked by the learned writer of the article "Animal Kingdom," who has arranged the Entozoa as being diploneurose animals.

* Dr. A. Farre, on the structure of Ciliobrachiate Polypi. Phil. Trans. part 2 for 1837.

transparency and smooth surface, and under the highest powers of the microscope present neither an appearance of cross markings nor of a linear arrangement of globules." Besides the retractor muscles in the Bryozoa there likewise exists a muscular membrane which lines the cell, and forms the parietes of the body, in which fibres are distinctly apparent, running transversely: these by their contraction compressing the visceral cavity and the fluid which it contains will tend to elongate the body of the Bryozoon, and assist in effecting its protrusion; although, as Dr. Farre supposes, this process is principally accomplished by the cooperation of the alimentary canal, which has the power of straightening itself from the sigmoid flexure, into which it is thrown when the animal is retracted.

The condition of the nervous system in the Bryozoa has not been as yet made out, a circumstance at which no one will be surprised who considers the extreme difficulty of microscopic researches concerning the structure of animals so minute as these; but from the close affinity that there decidedly is between these animals and the Rotifera, there can be little doubt that a similar arrangement exists in both.

In the ROTIFERA or Wheel Animalcules, the nervous system, according to Ehrenberg, consists of several filaments communicating with minute ganglia dispersed in different parts of the body, although without any obvious arrangement or symmetrical disposition, so that the muscular apparatus in these beautiful animals presents itself in a very perfect state of development. The ciliated organs around the mouth, which are apparently the representatives of the ciliated arms in the Bryozoa, are retracted by a special set of muscles derived from the interior of the membrane that lines the shell and circumscribes the visceral cavity, and the antagonists to these are the delicate parietes of the visceral cavity itself, which acting upon the fluid therein contained, causes the extrusion of the ciliated lobes, whenever the wheel-like organs are required to be put in motion.*

But besides the muscular bands, that, in the Rotifera, are appropriated to the protrusion and retraction of the wheel-bearing organs, others are connected with a peculiar prehensile apparatus placed at the hinder extremity of the body, and forming an instrument of very great importance in the economy of these creatures. It consists of a prehensile forceps, the blades of which are worked by distinct muscles; and by the assistance of this organ the action of the wheel-like cilia is at once changed from that of a locomotive power into a means of procuring and seizing food. If these forceps are not

employed, the apparently rotatory organs propel the little animal rapidly through the water; but does it choose to take hold of some foreign body by means of its forceps, and thus anchor itself in a given spot, the use of the wheels is entirely changed, their rotation merely producing currents or rather a powerful whirlpool in the water, which sucks from a distance every thing within its influence, and thus brings food into the mouth.

The next class of animals, the EPIZOA, present us with a beautiful series of gradations of development, clearly demonstrating the inseparable relation that must exist between the nervous and locomotive systems. The Epizoa seem, indeed, to be the osculant group interposed between the Intestinal worms and the Articulated classes, and exhibit in a permanent condition the progressively improving external articulated limbs, which are only permitted to attain their full development in higher races of the animal creation. The Epizoa, like the Cœlelmintha, are parasitic in their habits, living, however, upon the external surface, and not in the interior of other animals. They are principally found fixed to the eyes, the skin, the gills, or even the inside of the mouth of fishes, or to the branchial organs of various forms of aquatic animals, from which they suck the materials necessary for their support, and at the same time are freely exposed to the influences of the surrounding medium for the purpose of respiration. In the humblest of these parasites the structure of the body is scarcely superior to that of many Cœlelmintha, suckers and prehensile organs placed in the vicinity of the mouth being their only means of adhering to the surface upon which they live; but in the *Lerneans* the first appearance of outward limbs begins to be perceptible, not as yet recognisable as legs or locomotive agents, but not the less on that account the first rude sproutings of members that are to be by degrees perfected in more highly privileged genera. Some of these Lerneans, indeed, present most grotesque shapes, and almost exactly resemble the embryos of Vertebrate animals at the period when the first buddings of limbs begin to project from the sides of the body. This resemblance, indeed, is far more real than it would at first appear, inasmuch as there is a parallelism to be established between the permanent condition of the Lernean and the transitory state of the embryo at the corresponding period of its development that is strictly physiological. The condition of the nervous system in them both is precisely similar, exhibiting in both cases the nematoneurose type; the same rudimentary condition of the muscular system is consequently equally met with in the embryo and in the Lernean, but as the nervous system in the former is rapidly advancing to a more exalted state of development, so do the limbs and the muscles appertaining to them improve in the same ratio.

In the higher genera of EPIZOA minute ganglia exist in connexion with the nervous filaments, and in such the limbs are of course more exactly formed and begin to sketch out

* It seems more than probable that the transverse muscular fibres that occur in the parietal membrane of the Rotifera have been mistaken by Ehrenberg for vascular canals, described by the observer as emanating from a dorsal vessel; such at least is the opinion of Dr. Arthur Farre in the memoir above referred to, an opinion which quite coincides with the result of our own observations upon this subject.

as it were the limbs of Crustaceans and other Articulata.

The study of the muscular system in the extensive class ECHINODERMATA, the last of the nematoneurose division of the animal world, is invested with considerable interest on account of the very different kinds of locomotive apparatus that successively make their appearance; for as the outward form of these elaborately constructed creatures changes through all the phases represented by the *Encrinite*, the *Starfishes*, the *Echinus*, the *Holothuria*, and the worm-like *Siponculus*, the muscles successively assume a different arrangement.

The *Encrinite* in its outward form might be mistaken for a polyp, the jointed calcareous stem whereby it is fixed to the rock, the body and rays around the mouth, as well as the appendages to the stem, being all in their essential structure exactly comparable to those cortical polyps, that have an internal jointed calcareous basis of support. The numerous pieces that compose the skeleton of the Encrinite are all invested with a living contractile crust, whereby, in fact, they were secreted, and which forms the bond that connects them together. The living crust that covers the Encrinite can scarcely, indeed, as yet be looked upon as being muscular, so soft and acrite does its composition appear to be; nevertheless in these Echinoderms it seems to be the only moving power employed, and by its slow contractions bends the arms, or rays, or stem in any given direction.

In the long-armed Starfishes, such as the *Comatula*, *Gorgonocephali*, and *Ophiuri*, the slender and flexible rays around the body are in like manner covered with a living contracting skin, more dense and coriaceous than that of the Encrinite, but still presenting very dubious appearances of muscular fibre, whereby the movements of the rays are effected. The rays themselves constitute the instruments of progression, and by their aid these Polyp-like creatures crawl at the bottom of the sea, or by entwining them around the sea-weed that covers the rocks climb in search of food.

In *Asterius* and kindred forms the exterior of the body is still encrusted with the same contractile covering, and can be bent to a certain extent; but in these short-armed Starfishes the rays have become so short and devoid of flexibility that they can no longer be useful for the purposes of locomotion: an additional muscular apparatus is therefore now conferred in the extraordinary system of protrusible suckers, that become the chief agents in walking, or in seizing prey.

As we advance from the *Asteridæ* we find that the rays at length totally disappear: the body assumes a pentagonal form (*Palmipes*), then circular (*Scutella*), and at last is enclosed in an ovoid or globular shell, as in *Echinus*, *Cidaris*, &c. In these spherical Echinoderms the external soft and living crust that still covers the exterior of the shell presents obvious claims to muscularity, more especially where it passes on to the articulated spines that are attached to the surface of the shell and now

become the principal means of progression. The suckers, however, that formed the only locomotive organs in the *Asteridæ* still are met with in the *Echinidæ*,—these and the spines constituting an apparatus for locomotion, which, for its complexity, is unparalleled in the animal creation. In the Echinidæ, moreover, a strangely constructed set of dental organs are developed, and for these likewise special muscles are appointed, for a description of which the reader is referred elsewhere. (See ECHINODERMATA.)

In the *Holothuridæ* the shell of the Echinus is no longer secreted, and the living integument itself constitutes the whole parietes of the body, which now becomes quite soft and flexible, clearly commencing that transition which is to connect the Echinodermata with the Annulose division of the animal kingdom. The suckers of the last family are, however, still persistent and form the principal means of moving from place to place. The texture of the fleshy skin of the *Holothuria* is dense and coriaceous, and strong bands of muscular fibre arranged in five divisions pass in a longitudinal direction, from one end of the body to the other, between which circular and transverse fasciculi are distinctly perceptible. Imbedded in the muscular walls that enclose the visceral sac of the *Holothuridæ*, delicate nervous filaments are to be detected passing along the body from end to end, and most probably these are connected together by a circular filament surrounding the œsophagus. Ganglia, if they exist at all, have, from their minute size, hitherto escaped observation; and, as might be expected from such a condition of the nervous system, the muscular contractions of the fibrous integument, although associated through the medium of the nerves, and consequently far stronger and more energetic than in the lower asteroid Echinoderms, are still almost entirely uncontrolled by the influence of volition; nay, so remarkably is this the case, that in most species of *Holothuria*, upon the application of the slightest stimulus to the exterior of the body, or even by simply taking them out of the water in which they live, such violent and general contractions of the whole integument are excited that the intestines and other viscera are forced extensively through the anal orifice, and it is almost impossible for the anatomist to procure a specimen of these creatures without finding it more or less spoiled from this circumstance.

Lastly, in the *Siponculi* the vermiform appearance is completely established, the longitudinal and circular muscles that bound the visceral cavity are strongly and distinctly developed, the complicated apparatus of foot-like suckers has disappeared, minute ganglia are visible towards the anterior end of the body, and we arrive at the annulose condition, that characterizes the next great division of the animal creation, which now offers itself to our contemplation.

HOMOGANGLIATA (Owen).—The third great natural group of living beings consists of creatures having the exterior of their bodies divided into rings or segments arranged behind each

other in a longitudinal series, and generally furnished with lateral appendages of different kinds symmetrically disposed, which are subservient to many and very various purposes. The nervous system, moreover, throughout the entire range of this extensive series assumes a new and constant arrangement in itself, quite sufficient to characterize this sub-kingdom of animated nature, and with the different modifications of this portion of their economy are intimately connected the progressive changes observable in the structure and habits of the different classes included therein.

In the simplest conceivable condition under which a Homogangliate animal could exist, and doubtless among the lowest of the red-blooded worms and most imperfect forms of insect larvæ such a condition might be pointed out, the body would consist of a long succession of similar rings, each of which would contain an appropriate nervous apparatus consisting of a pair of ganglia symmetrically disposed on each side of the mesian line, from which nerves proceed for the innervation of the segment in which the brains or ganglia were placed. These ganglia in each segment communicate with each other and likewise with the pairs that precede and follow them by inter-communicating nervous filaments, and thus the entire series of individual brains or ganglia is united into one system made up of as many pairs as there would be rings entering into the composition of the body. There is, however, a remarkable difference between the anterior pair of ganglia and those placed in the succeeding segments. The first pair is invariably situated *above* the œsophagus on its dorsal aspect, while all the rest are arranged *beneath* the alimentary canal along the ventral region of the animal, so that the nervous cords that join the first and second pairs of ganglia embrace the œsophageal tube. The *supra-œsophageal* pair of brains invariably communicates with the instruments of the senses whenever such exist, and therefore is very justly comparable to the *encephalon* of higher animals; while the succeeding chain of sub-œsophageal ganglia animate the muscles of the different segments of the body, and may therefore be looked upon with great reason as representing the spinal cord of the Vertebrata.

But while the ganglia either of the head or of the ventral cord are thus numerous, as we have supposed them to be, in the lowest worm, they are as yet by far too small and devoid of energy in such a dispersed condition to correspond with organs connected with the higher senses, or even to wield muscles of sufficient power to support the weight of the body raised on articulated limbs. Therefore, before senses can be given or active limbs bestowed, a process of concentration must be gone through, the encephalic masses must be enlarged and thus rendered more perfect, the ganglionic centres that influence muscular movements reduced in number and made proportionately more energetic, and exactly in the ratio in which this improvement is effected in the nervous system, do the muscles become by degrees stronger and more efficient, and the limbs appended to the

body more active and useful as locomotive agents. This, however, will be best exemplified by a rapid survey of the principal classes that compose the division of animals we are now considering.

In the lowest Annelidans, as for example the *Gordius* or hair-worm, so impotent are the minute ganglia bestowed, that even the rings upon the exterior of the body are scarcely indicated, and not the least vestiges either of limbs, tentacula, or eyes are to be detected. In the *Leeches* even, although the number of ganglia is in them considerably diminished, and rings of the body more strongly marked, external limbs cannot as yet be given, their place being supplied by the suctorial discs of the head and tail; nevertheless, even in these aquatic Annelides, the encephalic masses are sufficiently advanced to permit organs of vision to be granted, and accordingly for the first time in the animal series (as far as our own belief goes) are real eyes met with. The muscular system in these humble worms consists exclusively of the contractile walls of the body, the fibres of which are arranged in three strata, superposed one upon the other, and pass in different directions, one stratum being composed of longitudinal, another of obliquely spiral, and another of annular fibres surrounding the body of the animal; but these are sufficient for progression, all the movements of contraction, elongation, or flexure of the body being provided for by this simple arrangement.

In the *Nereis*, *Aphrodite*, and other erratic worms, external appendages become developed from the lateral aspects of the different segments, in the shape of bundles of setæ, moved by muscles appropriated to each set, and these constitute the first rudiments of locomotive limbs. The senses are at the same time improved in their condition, tentacula or feelers are found appended to the head, and the eyes become larger and more conspicuous, although still presenting the form of simple specks or ocelli.

In the MYRIAPODA the limbs become articulated, and of sufficient strength to permit of a terrestrial existence, each one of the numerous legs having a distinct set of muscles appropriated to its movements, in addition to the muscular apparatus, whereby the segments of the as yet flexible and elongated body are endowed with motion, and which of course represent the strata of the muscular covering of the Leech, strengthened and endowed with the capability of more precise action, in proportion as the cuticular skeleton has become more dense and distinctly jointed. Antennæ are, moreover, now placed upon the head resembling those of Insects, no doubt constituting organs of sense of a similar nature, and the eyes in Scolopendræ are found to be very distinct and perfectly organized, but still only ocelli resembling the simple eyes of Insects.

In the admirably constructed class of INSECTS, creatures adapted to an aerial existence, and consequently requiring the utmost exertion of muscular power to sustain their bodies in the air, the muscular system of the locomotive

articulated appendages, the legs and wings, must undergo a still further improvement, and the means whereby this is accomplished are sufficiently manifest. The nervous ganglia are accumulated into a few large and powerful centres of innervation; the rings of the body, to which the locomotive organs are attached, are dilated and strengthened in proportion to the force of the muscles placed within, and constitute three thoracic rings of such firmness and inflexibility that they may well be looked upon as forming a distinct division of the exoskeleton, and give rise to the distinction laid down by entomologists between the head, the thoracic, and the abdominal segments that enter into the composition of an insect's body. But the same concentration of the nervous system, which permits an Insect to possess the extraordinary powers of flight with which it is gifted, allows by the increased perfection given to the brain, the possession of elaborately constructed senses. The eyes assume a complexity of structure that is truly wonderful, the sense of touch attains extreme delicacy, and indubitably the means of smelling, of tasting, and of hearing are now conferred, however incapable we may be of pointing out the mode in which they are exercised; nay, it is extremely probable that capabilities of perception of which we can form no idea, are bestowed upon the Insect races commensurate with the activity of their movements and the wide range of duties they are appointed to perform.

During the metamorphosis to which Insects are subject, that is to say during the advancement of these creatures from an embryo condition to their mature or perfect state, changes are constantly in progress, both in the nature and arrangement of the locomotive organs, and of course as these changes are effected, the entire disposition and even the vital properties of the muscular system appropriated to their movements undergo a considerable modification. The larvæ of many genera have externally the appearance of the simplest worm, being provided with not even any vestiges of the locomotive apparatus that subsequently is to be developed: even the rings or segments of the body are entirely soft, the cuticular covering being of extreme tenuity, and the tegumentary muscles, as a natural consequence, proportionally rudimentary in their structure. In such larvæ the nervous system exhibits the lowest condition found among the apodous Annelidans, and the eyes and external senses are, if they exist at all, of the humblest possible character. This is the case, for example, in the maggots of many Dipterous and Hymenopterous Insects.

In others, as for instance in the caterpillars of the Lepidoptera, the locomotive powers are of a slightly ameliorated description: the larva possesses a distinct head, and to the succeeding segments, rudely constructed limbs named *legs*, and others bearing still less resemblance to the locomotive members of the future insect, to which the name of *pro-legs* has been appropriated, are the only instruments of progression. Even in the most perfect larvæ, as in those of

the aquatic Beetles, the form is elongated and resembles that of an Annelidan; the legs are comparatively feeble and of small size, and simple ocelli replace the compound eyes that afterwards become developed in the perfect Insect.

During the progress of the metamorphosis, the nervous system within is undergoing a process of concentration precisely comparable to that which has been noticed in advancing from the lower to the higher classes of ARTICULATA. The ganglia coalesce and become less numerous, the encephalic pair attain a higher development, and as this is accomplished the legs and wings of the mature being sprout from the sides of the segments appropriated to sustain them, enclosed in and defended by cases of cuticle temporarily provided, which constitute the covering of the pupa or chrysalis, until at length, the aggregation of the previously separated ganglia being completed and the brain perfected to the extent required, the pupa-case is thrown off, the newly-formed limbs expand, and the insect, with its newly-acquired limbs, possesses an additional system of muscles, which have been developed with their growth, and only arrive at their full state of perfection when the body has ceased to grow, and the generative system, having attained its complete proportions, proclaims the animal mature and able to propagate its species.

The addition of wings, indeed, to the body of flying insects would seem to be a provision specially connected with the distribution of the progeny to which they are to give birth, and all the phenomena connected with their development and that of the muscular apparatus provided for their movements to have relation to this great and closing act of the insect's existence. The period of time during which these animals live in their imperfect or wingless state, during which many of them have important offices assigned to them, constitutes, in most cases, by far the longest portion of their lives, and some aquatic larvæ, indeed, reside for months or even years in the water under their immature or wingless form, which perish in a few hours after they have been gifted with the means of aerial locomotion. Had they never been furnished with wings, it is abundantly evident that the species of such insects could never have been dispersed beyond the precincts of the pond or the ditch in which the parent had passed her existence, but the brief space allowed them to enjoy life in the winged condition is sufficient for the achievement of the great object in view, and the *Ephemeron* and the little *Gnat*, while they appear to be only sporting out their evening's life amid the sunbeams, are, in fact, disseminating their offspring through different localities.

The next class of HOMOGANGLIATE animals comprises the ARACHNIDANS, the *Scorpions* and the *Spiders*, animals visibly intended to be destroyers, appointed to keep within due limits the different races of the Insect world, and by assisting in the great work of destruction that is on all sides in progress against them, to prevent their fertility from

becoming prejudicial to the other members of the animal creation. The tyrant must necessarily be stronger and more sagacious than the victims intended to be subdued, and accordingly, in the Arachnida, the great law that has hitherto been our guide in tracing the development of the muscular system is carried out one step further. The coalescence of the nervous ganglia and consequent concentration of the skeleton is found in these creatures to be more conspicuous than even among the Insects themselves: even the head and thorax, which in the last class were distinct from each other, now become fused into one piece, forming the *cephalo-thorax* of the creatures under consideration. The limbs and the jaws are thus rendered stronger and more formidable, and the muscles whereby they are wielded attain the fullest development permitted amongst articulated animals. Among the CRUSTACEA forming the last class of this important sub-kingdom of creation, we find a series of aquatic Articulata running parallel as relates to the condition of their muscular system with the terrestrial Articulata, and exhibiting precisely the same relations between the state of concentration of the nervous system, and the degree of efficiency conferred upon their locomotive apparatus. The humblest forms of Crustaceans have all the segments of the body distinct and moveable, and, moreover, in their elongated shape resemble the larvæ of aquatic Insects. In these the articulated limbs appended to the different segments of the body are extremely feeble, and only adapted to natation; but proceeding upwards in the scale the locomotive members assume a more effective appearance, and the segments supporting them run together, and become consolidated. Whilst the muscles of the trunk preponderate in their development, as in the Shrimps and Macrourous Decapods, the limbs are of secondary importance as instruments of locomotion, and the largely developed tail forms a strong and powerful oar, a means of propulsion best fitted to their natorial habits; but as we approach the shore and meet with Crustaceans, adapted to a littoral existence, the muscles of the trunk become diminished in importance in proportion as the legs acquire additional strength. The concentration of the segments of the trunk is carried out to the greatest possible extent in the Brachyurous Decapods, and the Crabs are thus enabled to leave the sea and prowl about upon the beach, or even to exchange an aquatic for a terrestrial existence; and, as in the case of the *Land Crabs*, to reside during a greater part of the year at a distance from their native element.

It is, however, interesting to observe that in the most highly organized of the CRUSTACEANS, the *Brachyura*, the complete centralization of the body and nervous ganglia is effected, as in the case of Insects, in a slow and gradual manner, and that their muscular system undergoes a metamorphosis scarcely less remarkable than that observed among the Insects themselves. The *Crab* on first leaving the egg is almost in the condition of a long-tailed Shrimp,

and the locomotive limbs scarcely to be recognized as being worthy of such a title, being not only rudimentary in their size but exclusively adapted for swimming; and it is only after several times casting its shell and passing through distinct gradations of form, that the muscles of the legs attain the preponderance over those of the trunk and become strong enough for progression on land.

The fourth grand division of the animal kingdom, comprising the MOLLUSCA of Cuvier, is characterized by the dispersed condition of the nervous ganglia, which, throughout the extensive series of creatures constructed according to this type, are distributed without any symmetrical arrangement in different parts of the body, whence the Mollusca have been named by Professor Grant CYCLO-GANGLIATA, and more recently by Professor Owen HETERO-GANGLIATA, the latter term being, as we conceive, the preferable of the two. In the Mollusca the general outline of the body participates, more or less, in the want of symmetry that is so conspicuous in the disposition of the ganglia composing the nervous system, and the muscular apparatus does not exhibit that precision and regularity which is visible among all the Articulata. There is no longer, in fact, any frame-work, but when a shell is present, as, for example, in the *Snails* and kindred forms, both terrestrial and marine, it is only in those parts of the body that are protrusible from the testaceous covering that the tegument exhibits this decided muscularity, the mantle lining the shell being constantly thin and membranous.

But the most strongly developed part of the muscular covering of a gasteropod is the broad fleshy disc attached to the ventral surface of the body which constitutes the apparatus of locomotion, and gives the name conferred by zoologists upon the entire class. This disc, or *foot*, as it is likewise called, is entirely made up of contractile fibres, disposed in various directions, so as to confer all the capabilities of movement necessary for securing progression along the plane surfaces over which these sluggish animals are destined to crawl.

Having, as yet, no internal skeleton developed, and being equally destitute of any thing like an external articulated frame-work, it must be evident that if creatures of this description are to be provided with organs requiring to be moved by subordinate sets of muscles, seeing that there is no firm point of attachment to be found, as is the case among Insects or the Vertebrata, recourse must be had to a new plan, and accordingly few more remarkable deviations from what is generally met with in other animals can be pointed out than we meet with in the extensive class under consideration. The parts of the mouth, the tentacles, the eyes, and those parts of the male generative system needed for copulation, are in many instances so constructed that they may, when not in use, be completely retracted into the general cavity of the body and packed up amongst the viscera by means of a mechanism quite peculiar, and of which a particular account is elsewhere given. (See GASTEROPODA.)

In the PTEROPOD MOLLUSCA, we likewise find the entire body enclosed in a muscular bag, forming what is called the visceral sac, but the locomotive organs present themselves under a different aspect. These consist of two muscular flaps or wings, appended to the opposite sides of the neck, which form, in fact, two oars or paddles, wherewith the little Pteropods row themselves about from place to place, or gambol gaily among the waves, which sometimes, in the northern oceans, swarm with countless multitudes of them. The lateral fins in question were regarded by Cuvier as being likewise subservient to respiration, an opinion, however, which Eschricht satisfactorily confutes. The latter writer, moreover, points out a little circumstance worth recording, namely, that the wings are not distinct and separate organs as at first they would appear, but that the muscles moving them pass continuously in a crucial direction through the neck of the animal from one wing to the opposite, so as to convert the whole apparatus into an exact representation of the double paddle used by the Greenlander, in rowing his *kujac*, or canoe, over the very seas frequented by the Pteropods, in such abundance.

In the Carnivorous CEPHALOPODA the muscular sac composing the body, the parietes of the head, and the long and flexible arms with their curiously constructed sucking cups appended, are all made up of variously disposed contractile fibres; but these are too fully and well described in another place to require more than a passing notice in this general survey. (See CEPHALOPODA.)

Arrived at the vertebrate division of the animal series, we at once find the moving powers assuming a complexity of arrangement and precision of action, proportional to the elaborate construction of the internal osseous, or cartilaginous skeleton, which now forms the framework of the body, and must be regarded as entering into the composition of several distinct systems of organs appointed to different offices, and physiologically independent of each other. Each of these systems, or sets of muscles, indeed, is developed for special purposes, and so far are they from progressively presenting themselves, in a gradually improving condition, as we rise from lower to more elevated orders of Vertebrate animals, that the physiologist must be prepared to expect every irregularity in this respect; important organs, or sets of organs, that in the lowest Vertebrata are found to be most elaborate and complex in their structure, are not unfrequently either wholly or partially obliterated, as we ascend the scale of animal life, and others equally important to the animals possessed of them, are only met with in certain races, that are endowed with peculiar habits or capabilities.

But, what is still more startling to the anatomist, who has confined his dissections to the examination of the muscular system as it exists in mature or complete animals, and has consequently been accustomed to describe as being permanent and invariable the origins and in-

sertions of every muscle, that he meets with, the study of embryogeny reveals to the philosophical enquirer a series of changes in progress, as relates to the arrangement or even the existence of various parts of the animal economy, involving changes as remarkable, in all the muscular apparatus connected therewith.

In order, therefore, fully to lay before the reader, with as much brevity as perspicuity will allow, phenomena so important as those which next offer themselves to our notice, it will be advisable, first, to enumerate the principal systems of muscles that enter into the composition of a completely formed Vertebrate creature, premising that each may be but feebly developed in proportion to the rest, and many of them, indeed, absolutely wanting in a given animal, and afterwards to examine separately the varieties of arrangement met with in the animal series in relation to each, and likewise the metamorphoses that accompany embryonic development.

Without overburdening with detail this interesting enquiry, or unnecessarily multiplying divisions of the muscular apparatus, we shall content ourselves with grouping all the muscles of a Vertebrate animal, as belonging to one or other of the following systems, each of which will demand separate examination.

1. *Vertebral system*, muscles directly acting upon the spine and cranial vertebrae.
2. *Costal system*, muscles moving the ribs and parietes of the thorax and abdomen.
3. *Hyoid system*, muscles acting upon the os hyoides and branchial arches.
4. *Opercular system*, muscles moving the operculum of fishes.
5. *Muscles of the limbs*.
6. Muscles acting upon the *lower jaw* and serving for mastication.
7. *Tegumentary system*, muscles acting upon the skin and its appendages.
8. *Vocal system*, muscles of the voice.
9. *Diaphragm*.
10. *Lingual system*.
11. *Ocular system*, muscles moving the eye-ball and its appendages.
12. *Aural system*, muscles acting upon the ossicles of hearing and moving the external ear.
13. *Nasal system*, muscles acting upon moveable parts of the nose.
14. *Generative system*, muscles attached to the apparatus of generation.

1. The muscular apparatus peculiarly appropriated to the movements of the vertebral chain of bones presents its maximum of development in the osseous fishes, in which animals locomotion being principally accomplished by the lateral sweepings of the broadly expanded vertical tail, every arrangement has been made to increase the depth of the spinal column and to extend the surface presented by the superior and inferior spinous processes to the greatest possible degree, not only by lengthening inordinately those processes themselves, but likewise by appending to their extremities additional pieces derived apparently from the exo-skeleton. The muscles destined to act upon the flexible spine of the fish are propor-

tionate to the violence of the impulse required in moving the tail, and occupying the lateral regions of the body, extend quite from the head to the caudal fin, constituting almost the entire bulk of the animal, and possessing sufficient strength from their combined contractions to scull the fish through the water with surprising velocity, or even to enable the salmon to throw itself up the cataract, that bars its progress up the river, where it is commissioned to lay its eggs.

During the changes that accompany the development of the tadpole, which by its metamorphosis into a frog is literally converted from the condition of a fish into that of a reptile, the transmutation observable in the condition of the muscles acting upon the spine are not less remarkable, than those witnessed in the vertebral column itself. Whilst in its tadpole state the frog is, as regards its powers of locomotion, strictly a fish, and rows itself about entirely by the movements of its expanded vertical tail exactly as fishes do, but as the limbs of the reptile gradually make their appearance the lateral muscles of the spine that previously formed the bulk of the creature are absorbed and disappear, the hitherto flexible and elongated vertebral column becomes short and but little gifted with motion, and its muscles in the same ratio grow feeble and unimportant.

In the other forms of Reptiles, as well as in Birds and Mammalia, the muscular system acting upon the vertebral chain presents great uniformity of character, the number and strength of the muscular fasciculi being exaggerated, or diminished in different regions in proportion as mobility is permitted, the movements of the spine being generally diminished, and trammelled in exactly the same ratio as the locomotive limbs become more perfect and efficient.

2. The costal muscles form a system apart, quite independent of those connected with the vertebral column, and exactly keeping pace with the development of the skeleton of the thorax. In Fishes a thoracic cavity cannot be said to exist, inasmuch as the ribs that enclose the viscera seem rather processes fixed to the spine, in order to give a greater extent of surface for the attachment of muscles destined to act upon the tail, than properly the representatives of the costal elements of the skeleton; neither do ribs exist in the tadpole, or even in the perfect frog. Even in those Batrachia that are most gifted in this particular, minute cornicula appended to the apices of the transverse processes of the vertebræ are the only rudiments of a costal system of bones, and these muscles are vainly looked for.

In the Tortoises and Turtles likewise, although both *vertebral* and *sternal* ribs are present, and so hugely developed that they constitute the great bulk of the carapax covering these strange reptiles, such is the immobility of the dorsal shield, and so securely are the ribs conjoined by suture, that any muscular apparatus destined to act upon them would have been obviously superfluous.

In Serpents, however, the case is widely different; for in these lithe and limbless crea-

tures the ribs are made to serve as most important locomotive agents, and their movements must be proportionably free. Dorsal ribs only are here met with, but these being now moveably articulated to the sides of the spinal column, and moreover acting at their opposite extremity upon the ventral scuta, perform the duties of internal legs, and being continued in an unbroken series from the very atlas nearly to the termination of the tail, it is not difficult to imagine the numbers and complexity of the additional muscles now provided, to wield organs so numerous and important.

In Lizards and in Birds the thorax assumes its most complete state of development, and exhibits both dorsal and sternal ribs articulated to each other and capable of extensive movements; muscles are therefore given to act upon both the dorsal and the sternal series.

Lastly, in the mammiferous races the anterior costal bones are once more removed, their place being occupied by elastic cartilages, the resiliency of which to some extent antagonizes those muscles which act upon the moveable portions of the thorax.

The *sternum*, or rather the sternal system of bones, although frequently found to enter largely into the composition of a thoracic cavity, seems rather to be in relation with the anterior extremity, and the muscles derived from it principally subservient to the motions of those limbs. Thus in the frog and toad we have a largely developed sternum without either ribs or thorax; and in the case of Birds, the strict correspondence between the condition of the sternum and the powers of flight is most strikingly exemplified.

3. Perhaps the most interesting lesson to be derived from such a survey of the muscular system of vertebrate animals as this, is taught by an examination of the hyoid apparatus, and of the muscles connected with it, in the different members of the vertebrate series, and also during the different phases of embryonic development, in any of the air-breathing or more elevated classes. It is in Fishes that this part of the skeleton exhibits the greatest complexity of structure, and forms a most elaborate framework of branchial arches, destined to support the gills, which some writers have been tempted erroneously to consider identical with the thorax of the air-breathing races. The branchial or hyoid organs are in fact substitutes for the thoracic or pulmonary portion of the skeleton, and in exact proportion as the latter becomes more complete, and better adapted to aerial respiration, does the former shrink in its dimensions and become simplified by the obliteration of successive portions, which previously entered into its composition, and a consequent remodeling, as it were, of the muscles connected therewith. Thus during the metamorphosis of the tadpole, the branchial arches that before were largely developed, are progressively found to disappear as the lungs assume their office, and the whole hyoid system of bones and muscles changed so as to become adapted to the performance of totally different functions.

The permanent or adult condition of the

hyoid apparatus likewise undergoes a progressive simplification as we examine it in the more elevated forms of Vertebrata. Thus, in the bird it still consists of elements, that in the mammiferous animal may be dispensed with. The cornea, the last remnants of the branchial arches, are still largely developed in many quadrupeds, and in fact it is only when we arrive at the human species that we see the pieces composing the hyoid portion of the skeleton reduced to their simplest condition, and the muscles appended thereto correspondently reduced in their number and modified as regards the functions they perform.

4. The muscles that act upon the opercular openings in Fishes are, of course, peculiar to animals possessed of a branchial respiratory system.

5. The muscles of the limbs exhibit perhaps greater varieties than any others belonging to the animal economy, their existence and relative size being entirely dependent upon the kind of progression conferred on any given race or family of the vertebrate creation. It would seem indeed that an inverse proportion always exists between the condition of this system of muscles and those that act upon the trunk—the large development of the one set rendering the other of secondary importance. Thus in the generality of the osseous Fishes the enormous bulk of the lateral muscles of the trunk renders any great strength of limb unnecessary, and the muscles moving the pectoral and ventral fins, the representatives of the arms and legs, are proportionately small and feeble; but in the Plagiostome Cartilaginous Fishes, the *Skates* and *Rays*, the conditions are precisely reversed; the muscles of the trunk shrink into comparative insignificance, and the enormously developed hands, which here form the great bulk of the body, moved as they are by muscles of corresponding power, form the great agents in locomotion, and by their vigorous flappings raise these creatures from the bottom of the sea, their usual resting-place.

The phenomena attendant upon the growth of the limbs in Amphibious Reptiles beautifully exemplify the same circumstances. In the *Lepido-siren*, that possesses still the form and the scales of a fish, although it breathes both with gills and lungs, the legs or fins, for it is difficult to say to which appellation they are best entitled, are of the simplest possible structure, each consisting but of a simple, tapering stem, so flexible and feeble that it can scarcely be deemed at all useful for the purposes of locomotion.

In the *Siren lacertina* we have still the long and flexible body of an eel, the tail obviously forming the chief, or, indeed, the only effective agent in progression. Nevertheless, seeing that this Amphibian being possessed of lungs can breathe the air, the first sproutings of legs are here manifest. Two rudimentary limbs corresponding with the anterior pair of other reptiles, and terminated by four extremely imperfect toes, are appended to a feeble scapular apparatus, and thus the Siren is allowed to raise its head at least out of the marsh where it re-

sides, and obtain a supply of the atmospheric fluid.

The *Proteus* is, in form, almost as fish-like as the Siren, and its tail is still a strong and muscular oar; the limbs nevertheless are slightly more developed; and besides the imperfect anterior extremities, each of which is terminated by three toes, a rudimentary pelvis and pelvic extremity are now sketched out, the latter presenting two little toes, but hardly as yet sufficiently complete to be useful as locomotive organs.

Equally striking examples of the gradual development of locomotive extremities are found in those reptiles whereby the transition is effected, between the Ophidian and Saurian types of structure; thus in the genus *Anguis*, as for example, in the common English blind-worm (*Anguis fragilis*), although externally it would appear to be as strictly apodous as the generality of other serpents, yet on stripping off the skin, these reptiles are found to possess the first rudiments of limbs, that are afterwards to be made efficient in more highly gifted genera; a little pelvis is distinctly discernible, imbedded in the muscles towards the hinder part of the body; and, in front, a sternum, scapula, and clavicle, may all be perceived hidden beneath the integument, although no traces of legs or feet are as yet to be detected.

In other serpents more nearly approximated to the quadrupedal Saurians, as in the genus named *Bimanes* (*Chrottes*, Cuv.) in addition to the scapular apparatus, two short anterior extremities armed with toes, moved by tolerably complete muscles, are met with, whilst the hinder legs are wanting. In *Bipes*, on the contrary, it is the pelvic pair of legs that are developed, the place of the anterior being only indicated by the existence of the frame-work and muscles of the shoulder. Lastly, in the Saurians and Tortoises the quadrupedal type is fully adopted, and the muscles of the limbs assume an importance proportionate to the duties they have to perform.

Still more interesting is it to watch the daily growth of the muscles that make their appearance, as the legs of the Frog are slowly formed, budding, as it were, from the sides of the Tadpole, and vicariously taking the office of those, that previously constituted the locomotive apparatus; the vertebral system of muscles, whereby the tail of the aquatic animal is moved, being entirely obliterated as the limbs advance to maturity.

6. The masticatory muscles, or those connected with those movements of the lower jaw that are concerned in the preparation of food, present great uniformity of arrangement throughout all the Vertebral orders, and obviously constitute a distinct and isolated group, the development of which is in exact relation with that of the rest of the manducatory apparatus.

7. The tegumentary system of muscles, although only represented in the human body by a few detached and isolated remnants, constitutes among many of the lower animals a very important part of their economy, either

destined to act upon the skin itself or upon cuticular structures of very diversified shape, which are occasionally developed in different regions of the body, and not unfrequently appropriated to the performance of important duties. In those quadrupeds that have their backs covered with strong spines, such as the Echidna, the Porcupine, and the Hedgehog, the cutaneous muscles, usually named *panniculus carnosus*, are met with in their most complete form, since in these creatures every quill or spine is moved by muscular bands connected with its base, that serve to erect or depress it at pleasure. The crests and other moveable appendages to the skin met with among Birds, are equally furnished with the means of motion by strengthening particular parts of the muscular apparatus in question.

In *Reptiles*, on account of the nature of their corneous integument, the muscles of the skin are but slightly developed, or indeed most generally are not to be detected. - But in *Fishes* they once more present themselves, under a novel and most important aspect. The *zygos* fins in these aquatic Vertebrata are, as is elsewhere shewn (vide *PISCES*), derivations from the exo-skeleton, and consequently all the slips of muscle, that act upon the individual rays of the dorsal, caudal, or anal fins, however anomalous their nature may appear without such a key to their real character, are obviously merely portions of the tegumentary system of muscles here elevated into an importance not witnessed in other animals, where the exo-skeleton is less decidedly appropriated to the purposes of locomotion.

8. The muscles whereby vocal sounds are modulated, are equally entitled to be looked upon as a distinct and superadded system only conferred upon certain races of Vertebrata, and that under very various conditions. In *Fishes* these muscles are of course absolutely wanting, and even amongst the air-breathing *Reptiles* they are so imperfectly developed as scarcely to be regarded as vocal organs. But in *Birds* and *Mammalia* they assume a higher form, and are variously located and more or less numerous in exact proportion as the voice is perfected. In *Birds*, indeed, the vocal muscles are principally placed at the thoracic extremity of the trachea, but in *Quadrupeds* and in *Man*, at the opposite end, the whole machinery being thus so completely altered that even analogies between the different sets of muscles are not easily pointed out.

9. The *diaphragm* is an apparatus exclusively conferred upon the *Mammiferous* Vertebrata, since in these only is the thoracic cavity separated from the abdomen by a muscular septum.

10. The muscles of the tongue must likewise be regarded as forming a distinct group, increasing in complexity and extent of motion, in proportion as the organ to which they belong assumes greater importance, either as an instrument for the prehension of food, or as an agent in mastication.

11. The ocular system of muscles may be divided into those which act on the eyeball,

and those employed in moving the palpebral appendages. The former when complete consist of four *recti*, two *obliqui*, and the *chouanoid* or suspensary muscle, which not unfrequently is distinctly divided into four. The *recti* are invariably met with and present few variations worthy of notice. The *obliquus superior* in *Mammals* passes through a pulley, which is not the case in other *Vertebrata*, while the *chouanoid* muscle is principally met with in *Quadrupeds*.

The muscles of the eyelids are most perfectly developed in *Birds*, in which distinct muscles are appropriated to the movements of the upper and lower eyelid as well as to the nictitating membrane, which in the feathered races has a proper set of muscles appointed to draw it over the eye not met with in other classes.

12. The muscles of the auditory apparatus become fully developed only in the *mammiferous* ear, where four little muscles are invariably found connected with the *ossicula auditus*, as in the human subject. The muscles appointed for the movements of the external ear are, however, in many *Quadrupeds* much more numerous than in *Man*; in fact, in the human ear they merely exist, in a rudimentary condition.

13. The nasal apparatus has likewise a system of muscles of its own, although the instances in which it is met with in anything like a complete state of development are comparatively rare. In *Fishes*, *Reptiles*, and *Birds* these muscles, indeed, can hardly be said to exist; and even in the generality of *Mammals* they are feeble and unimportant. It is only in the *proboscidean* species, that the nasal muscles assume their full complexity, and the trunk of the elephant is in modern times the only example, wherein the anatomist can contemplate them.

14. The muscles of the generative system are only found to exist, as a distinct set, in the *Mammalia*, as in these alone is the urethral canal complete, and a perfect ejaculatory apparatus given.

Thus, therefore, we may learn from this short survey, that so far from finding in the human frame the fullest and most elaborately constructed examples of the various divisions of the muscular system, or, in other words, a typical condition of that part of the animal economy, the human anatomist, in many instances, has only an opportunity of examining the vestiges or rudiments of organs, that in the lower animals attain to a far more complete development.

(T. Rymcr Jones.)

MYRIAPODA, (from the Greek *μυριας*, ten thousand, *i. e.* numerous, and *πους*, a foot.) the name of an important and highly interesting class of articulated animals, intermediate in their structure and appearance between the *Annelidans* and the *Insecta*, properly so called; approximating the former in the worm-like form of their bodies, which are composed of a great number of rings or seg-

ments, and likewise allied to the latter by the construction of their jointed locomotive legs; these, however, instead of being only six in number, as in the true Insects, are, in the Myriapoda, always at least twelve, and frequently extremely numerous, being appended to all the segments of the elongated body, whence the names "Centipedes" and "Millepedes," by which these creatures are commonly designated. All the members of the class are apterous; they exhibit externally a succession of cylindrical or compressed rings, each of which sustains one or more, frequently two pairs of jointed feet, all of very similar construction, being generally terminated by a single sharp claw. There is no consolidation of the anterior segments into a thorax resembling that of the Insecta, although many celebrated Entomologists are disposed to regard the three anterior rings as the representatives of the thoracic segments. Upon the head are placed two antennæ or feelers, which, in one large group, are short, stunted, and composed of seven articulations, whilst in others these organs are long and setaceous, presenting a much greater number of distinct joints. Compound or simple eyes, allied in their structure to those of Insects, are generally, but not always, present. The mouth is formidable, and, in many respects, resembles that of Insects, being furnished with strong mandibles, adapted to devour either animal or vegetable substances. All the species breathe air by means of lateral stigmata and tracheal tubes, a circumstance whereby they are at once distinguishable from the CRUSTACEA. Their jointed legs remove them from the ANNELIDA, while they differ from the Insecta in many important particulars, but more especially in the progressive growth of their bodies, by the production of new segments, and the development of additional locomotive limbs, the number of which increases with the age of the animal, while, on the contrary, in Insects, the segments that existed at birth are found to coalesce into a smaller number, and the prolegs of the larvæ become obliterated when the Insect attains its complete hexapod condition.

All the Myriapoda are terrestrial in their habits, lurking beneath stones or in the crevices of houses. Many of them inhabit decaying timber, or are found beneath the bark of trees, where they devour such vegetable substances as are adapted to their support; or, in the case of the more highly organized species, wage war against other animals, upon which they feed.

The classification of the Myriapoda has hitherto been and still is exceedingly imperfect and unsatisfactory, apparently in consequence of their very wide distribution and the general similarity of their appearance. Our countryman, Dr. Leach, in his zoological miscellany, was one of the first who gave a general arrangement of these animals, which was adopted by Latreille; but he appears only to have examined the European species. In Griffiths' Translation of Cuvier's Animal Kingdom, Mr. J. E. Gray, of the British Museum,

gave the figures of some exotic genera; but of these the Editor left the descriptions very imperfect, and only made slight references to them in the explanations of the plates. Since that time Dr. J. F. Brandt published a monograph of the *Myriapoda chilognatha*,* in which he pointed out several new genera and re-named many, previously established by Mr. Gray. More recently M. P. Gervais has published his studies on Myriapods,† consisting of a revision of the class and a list of the species, but having overlooked the slight notes given of Mr. Gray's genera, has in one or two instances been led into error. Under these circumstances it is, with very great satisfaction, that we are able, by the permission of Mr. Gray, who has kindly placed his manuscript at our disposal, to lay before our readers the following review of the entire class.

Order I. *CHILOGNATHA*, Latr.

(*Julus*, Linn.)

Antennæ seven jointed; rings of the body furnished with two pairs of legs.

Fam. 1. *JULIDÆ*. Body cylindrical, smooth, rolling up into a spiral form and composed of many joints. Each segment formed of three imbricated parts, the upper part covering the body and sides of the abdomen. Antennæ short, thick. Eyes many in a group.

Gen. 1. *JULUS*. (Fig. 304, 1, 2, 3.)

2d, 3d, 4th, and 5th joint of antenna elongated, attenuated; 2d longest, 5th and 6th longer than the rest.

Fig. 304.

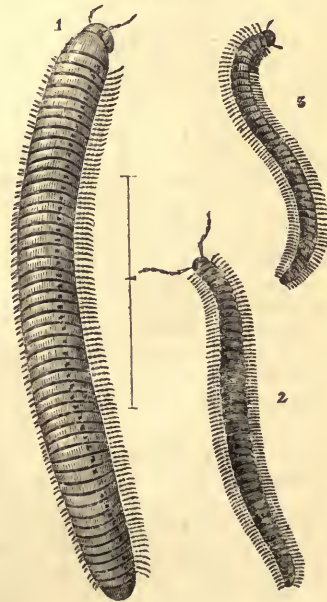

Julus.

* Bull. Soc. Imp. Moscow.

† Annales des Sciences Naturelles for 1837.

Gen. 2. *SPHÆROBOLUS*. Brandt.
2d, 3d, 4th, and 5th joint of antenna short, roundish, equal; the 2d rather longer than the rest, the 5th and 6th nearly equal.

Gen. 3. *SPEROSTREPTUS*. Brandt.
Lower lip with a semilunar pit in the middle and without any tubercles. Eyes many, in lunate tubercles.

Gen. 4. *SPEROPÆUS*. Brandt.
Lower lip with two transverse oblong tubercles separated by a transverse groove.

Gen. 5. *SPEROCYCLISTUS*. Brandt.
Lower lip flat, with tubercles placed in an impression in the centre of its base.

Fam. 2. CRASPEDOSOMADÆ.

Body cylindrical (striated), consisting of many joints, each formed by a single piece, antennæ slender. Legs 48 pairs or more. Eyes many, in a linear series or triangular patch.

Gen. 1. *CRASPEDOSOMA*. Leach.
Body elongate, depressed. Rings with a compressed lateral edge. Eyes in a triangular patch.

Gen. 2. *CYLINDROSOMA*. Gray.
Body elongate, quite cylindrical, with very indistinct longitudinal striæ. Eyes in a small oblong, kidney-shaped patch.

Gen. 3. *REASIA*. Gray.
Body subcylindrical, striated longitudinally. Eyes in a nearly linear patch.

Gen. 4. *CAMBALA*. Gray. *Platyulus*, Gervaise.
Body rather depressed. Eyes in a double line on each side of the back of the head.

Fam. 3. POLYDESMIDÆ.

Legs 31 pairs. Eyes none or only single tubercles, situated just on the outer side of the tentacles.

Gen. 1. *POLYDESMUS*. Latr.
Body elongate, depressed: rings slightly edged at the sides, forming an interrupted margin. Antennæ with rather long joints.

Gen. 2. *FONTARIA*. Gray.
Like *Polydesmus*, but the margin of the body is rude, and forms a continuous edge.

Gen. 3. *STENONIA*. Gray.
The body slender, the rings subquadrate, with toothed extended lateral edges.

Gen. 4. *STOSATEA*. Gray.
Body slender, subcylindrical; the lateral margin forming a very slight ridge.

Fam. 4. GLOMERIDÆ.

Body depressed; rings 11; semilunar. Eyes 8, placed in an arched line on each side of the head. Antennæ inserted on the upper front part of the head.

Gen. 1. *GLOMERIS*. Latr.
The first dorsal ring striated in the middle of the side. (Fig. 305.)

Fig. 305.



Gen. 2. *LAMISCA*. Gray. *Glomeris*, β. Brandt.

Fam. 5. ZEPHRONIADÆ.

Body depressed; rings 12; semilunar. Eyes many in a circular group. Antennæ on the side of the head. (Fig. 306, a b c d.)

Fig. 306.



Gen. 1. *ZEPHRONIA*. Gray. *Spharopocus*. Brandt.

Antennæ 6-jointed, penultimate joints short, last largest, oblong, rounded at the tip. (Fig. 306.)

Gen. 2. *SPHÆROTHERJA*. Brandt. *Zephronia*, part. Gervais.

Antenna 7-jointed, 6th joint nearly oblong, last joint smallest, truncate at the tip.

Fam. 6. POLYXENIDÆ.

Body depressed; rings 6; soft, semilunar, with a tuft of scales on each side; feet 12-12. Eyes many in a group.

Gen. 1. *POLYXENUS*. Latr. (Fig. 307.)

Fig. 307.



Polyxenus lagurus.

Order II. CHILOPODA. Latr.

Antennæ of 14 joints or more. Segments of the body flattened, each bearing only one pair of feet.

Fam. 1. SCUTIGERIDÆ.

Antennæ filiform, very long. Legs very long. Eyes reticulate.

Gen. 1. *SCUTIGERA*. Lamarck.
Feet 15 pairs or more. (Fig. 308, *Scutigera livida*.)

Fig. 308.

*Scutigera livida.*

Fam. 2. SCOLOPENDRIDÆ.

Antennæ tapering, moniliform, moderate. Legs numerous, moderate. Eyes numerous in groups, or wanting.

Gen. 1. LITHOBIUS.

Segments of the body 17, imbricate. Eyes many, gregarious. Antennæ 20 to 40 jointed. (Fig. 309, *Lithobius forficatus*.)

Fig. 309.

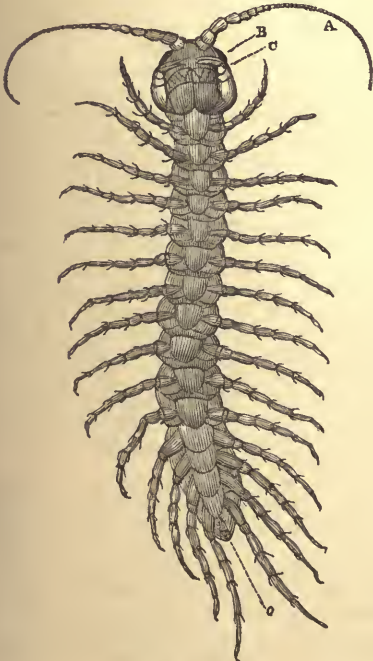
*Lithobius.*

Gen. 2. SCOLOPENDRA.

Eyes 4-4. Stemmatisform. Antennæ setaceous, 17 or 20 jointed. Body of 23 depressed rings. Feet 21 pairs, hinder longest, with the first joint spinulose (Fig. 310.)

Fig. 310.

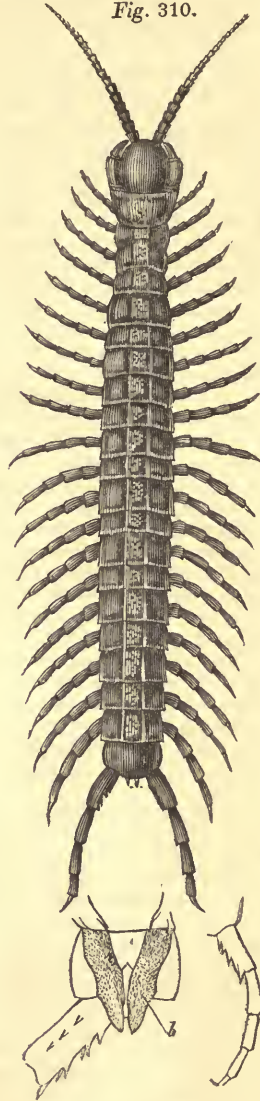

Gen. 3. CRYPTOPS.

Eyes inconspicuous. Antennæ setaceous, 17 jointed. Feet 21 pairs, hinder longest, not spinous.

Gen. 4. STRIGAMIA. Gray. (*Geophilus*.)

Eyes none. Antennæ 14 jointed, moniliform, rather elongate. Body linear, depressed. Feet very numerous, fifty pairs or more.

The whole body of a Myriapod consists of a succession of similar rings or segments of various form and consistency, the number of which would seem to be constant in the mature

or adult animal, but subject to important and very remarkable varieties during the progress of its growth. In the lower forms, such as *Julus* (fig. 304), the texture of the segments is hard, crustaceous, and brittle; but in the Scolopendroid races, the rings are flattened and covered above and below with tough and coriaceous scutæ. In all the Chilopoda each segment supports only a single pair of ambulatory legs, which resemble in many respects those of insects, but terminate invariably in a simple claw. In the Chilognatha, on the contrary, with the exception of a few of the most anterior, and likewise of the terminal or anal segments, each ring has two pairs of feet attached to its under surface, consisting apparently of two half segments conjoined; and this view of their composition is further strengthened by the fact, that a deep transverse indentation or groove is always visible upon the dorsal surface, dividing the otherwise apparently single ring into an anterior and a posterior moiety, to each of which is fixed a pair of short and very feeble legs, composed of several distinct articulations. The three first segments in *Julus* form exceptions, however, to this arrangement, each of these supporting only a single pair of ambulatory feet, and these segments have been supposed by some authors to represent the thoracic segments of the true insects. The seventh ring, likewise, in the female, has one pair deficient, they being replaced by the orifices leading to the sexual organs. The anal and penultimate segments are completely apodal in the Julidæ, whilst, on the contrary, in some of the Chilognatha, the size of the locomotive limbs increases progressively as we approach the caudal extremity, the last segment supporting the longest pair, which are directed backwards, so as to have in some measure the appearance of a furcate tail.

In the *Scolopendridæ* (*Chilopoda*, Latr.), a family which embraces those forms of Myriapoda that are most nearly allied to Insects, we have a race of carnivorous Myriapods, possessed of strong and active limbs, varying in number in different genera from fifteen to twenty-one pairs, by the aid of which they can run with considerable rapidity, and are able, owing to the flexibility of their long and jointed bodies, to wind their way with facility among the lurking places of Insects, against which they carry on an unrelenting warfare. All of them are found carefully to avoid the light, and generally to frequent damp situations, more especially where decaying animal or vegetable substances abound. They lurk, therefore, under stones or pieces of old wood, or are met with beneath the bark of trees, localities which from their structure they are peculiarly adapted to occupy.

In the following account of the anatomy of these creatures we shall select the Scolopendræ, properly so called, for particular description, as being the largest and, consequently, most commonly met with in our collections, noticing, however, as we proceed,

such peculiarities as may be worthy of notice in other genera.

The Scolopendræ have their bodies composed of twenty-one segments exclusive of the head, to each of which is attached a pair of jointed legs. The segments are all of them more or less quadrilateral in their shape, their transverse diameter being generally the longest, but their size is very variable and irregular. The whole body is depressed, each segment, consisting of a dorsal and a ventral plate of soft but corneous consistency, formed by a thickening of the cuticle in those regions of the body, while the sides to which the legs are appended, and where, moreover, the respiratory spiracles are situated, are soft and of a coriaceous texture.

The legs are all five-jointed and terminated in a simple sharp horny claw: those appended to the segments in the neighbourhood of the head are comparatively small, but as they approximate the hinder part of the body they increase in size and strength, the last pair being turned backwards so as scarcely to be useful as locomotive agents.

The head, and more especially the parts entering into the construction of the oral apparatus of these Myriapoda, present many difficult inquiries to the scientific entomologist, who would attempt to identify them with apparently corresponding structures met with in the organization of the mouth of insects, and accordingly we are not at all surprised to find that no two authors agree as to the names that are most applicable to the different pieces belonging to this portion of their economy. The Myriapoda, be it remembered, are obviously an osculant or transition group allied at once to the Annelidans, to the Insecta, to the Arachnidans, and to the Crustacea. It is by no means surprising, therefore, that, in the construction of almost every part of their bodies, we find an organization intermediate between these important divisions of articulated animals, as we shall again and again have occasion to notice. But, perhaps, in no part of their economy is this intermediate structure better exemplified than in the mouth of the Scolopendra, to the different portions of which all writers appear to have given names rather in conformity with their own preconceptions than with any real affinities that have been pointed out, or any general view of the real nature of such appendages. With all respect for the opinions of preceding writers, we shall, on this account, endeavour, in the following description, to avoid as much as possible technicalities peculiar to the orismology of any particular branch of zoological science.

The head of a Scolopendra, or that portion of the creature which supports the instruments of sensation and the organs employed for the prehension of food, appears, when viewed superficially, to consist of two segments, one a circular shield-like plate, constituting the real head, that exists only upon the dorsal aspect of the body, in which are inserted the antennæ, and which, moreover, contains the eyes and

overlaps the greater number of the pieces belonging to the mouth. The second segment, by far the larger and the stronger of the two, and, in fact, from the density of its corneous envelope, the strongest segment of the whole body, is entirely devoted to the support and movement of a pair of sharp bi-articulate and hooked fangs resembling jaws, that move transversely like the (so-called) mandibles of a Spider, but which are in reality only modifications of the ambulatory feet converted into instruments for killing prey, each being perforated near its sharp termination with a long oval slit, through which venom is said to be instilled into the wound inflicted by this formidable weapon.

The head properly so called, namely the circular shield-like plate seen upon the dorsal surface at the anterior extremity of the body, although apparently consisting of a simple horny disc, is doubtless composed of several segments conjoined superiorly; indeed, these are completely confused, and inferiorly are too soft and membranous to be distinguished, except by the presence of those articulated appendages, which, although forming parts of the mouth, are still merely repetitions of the jointed legs affixed to the other segments of the body. Thus the most superficial plate, with its articulated appendage, the *labium* and *labial palpus* of entomologists, is but an incomplete ventral scutum, with its articulated limb in a rudimentary condition as compared with those of the body, and is even armed with a distinct claw, as are the locomotive legs. In like manner the second pair, the *maxilla* of authors, are legs but one step further removed from their normal form, but not more so than are the poison-fangs already described. In the third pair or mandibles we have a leg reduced to its terminal claw, and that is broad and serrated so as to become useful in manducation. Lastly, the corneous and serrated piece (the *labrum*) seems to be the last vestige left of limbs of this description, the two horny remnants of legs having become consolidated with each other and with the dorsal head-plate, so as to form the anterior boundary of the mouth.

Alimentary canal.—The alimentary canal in all the Myriapoda is of extremely simple construction, and both in its form and general arrangement, very nearly resembles that of the larvæ of Lepidopterous Insects. In *Julus terrestris* (fig. 311) the œsophagus (*h*) is seen to be of considerable capacity, in accordance with the nature of the coarse food upon which these vegetable-eating species live. The stomach is long and bowel-like, extending from the termination of the œsophagus to the insertion of the hepatic vessels. To this succeeds a wide and sacculated colon, which passes directly to the anal segment of the body, where it terminates.

In the Scolopendroid genera the same conformation of the alimentary apparatus is met with, the stomach and intestine passing straight from the mouth to the anus without any peculiarities of structure worthy of notice.

In *Lithobius forficatus*, which we may take as a specimen of one of the Chilopod Myria-

poda, a very similar arrangement exists; the œsophagus, which is proportionately narrow, ends in a simple stomachal enlargement of an oblong shape, and this terminates in a straight bowel, the point of separation between the one and the other being only indicated by the entrance of the biliary vessels.

The glands connected with the alimentary apparatus closely resemble those of the insect larva. Two convoluted salivary tubes are seen folded up at the sides of the œsophagus, where their convolutions are interwolved into a species of ravel (fig. 311, *i*) with the origins of the hepatic vessels (*h*), which latter, after a tortuous course, are inserted, as in Insects, at the termination of the stomachal portion of the digestive tube.

Respiratory System.—The Myriapoda respire in the same manner as Insects by means of lateral spiracles and tracheal tubes. The spiracular orifices are, in the Scolopendridæ, very conspicuous, as, for example, in *Lithobius*, (fig. 312,) where the corneous lips of the apertures leading to the tracheæ (*s, s, s, s*) are seen situated behind the origins of the legs, upon the sides of the 2d, 4th, 6th, 9th, 11th, 13th, and 15th segments, occurring upon the alternate segments, except in the case of the 8th, where there is one missed. The tracheæ derived from these spiracles pass inwards to be distributed upon all the viscera, ramifying in every part of the body, and thus conveying air throughout the system. In structure these air-vessels exactly resemble those of true Insects, and are equally characterized by the existence of a spiral fibre in their interior, whereby they are always kept permeable.

Circulatory system.—In the nature of their circulatory apparatus the Myriapoda are closely related to the Insects properly so called. A long dorsal vessel passes from the tail towards the head along the mesial line of the body. The sides of this vessel, on clearing away the

Fig. 311.

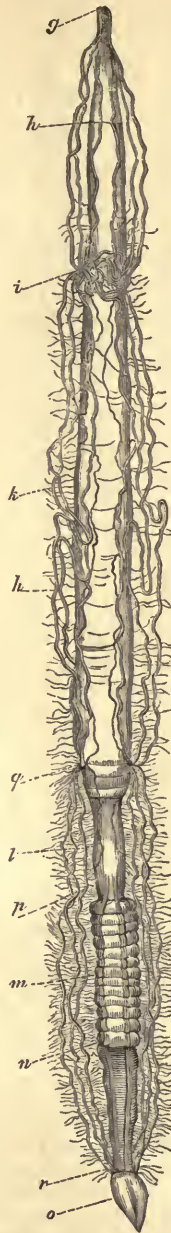

fat which surrounds it on all sides, are seen to be perforated at intervals with numerous valvular orifices, through which the circulating fluid gains free admission from the general cavity of the body, and by the undulatory contractions of the dorsal heart thus constructed is forced forward toward the head. Arrived in the neighbourhood of the œsophagus, the dorsal heart is seen to give off several vessels, and according to the opinion of Mr. Newport and Mr. Lord,* there is reason to suppose that a vascular system more complete than has as yet been proved to exist in any of the true Insects may be pointed out in this region of the body. The dorsal vessel itself, when examined under a microscope, is distinctly muscular, being formed of circular flat bands that surround the cavity of the tube, so that doubtless the action of this heart, in the larger species at least, is sufficiently energetic.

Foramina repugnatoria.—These are a series of orifices which in the Julidæ are seen upon the lateral aspect of every segment of the body, and communicate with as many minute membranous sacculi placed within the body. These sacculi, both from their position and relations, forcibly remind us of the series of respiratory sacs met with in the Leech and other air-breathing Annelidans, but in *Julus* they are supposed to be merely organs of secretion from which some offensive fluid is poured for the protection of the animal.

Nervous system.—The nervous system of the Myriapoda, as in all the Articulata, exhibits a double series of ganglia connected by cords of inter-communication. The supra-œsophageal ganglion, situated within the cephalic segment of the body as relates to its development, seems to hold a place intermediate between that of the Annelida and of Insects, or perhaps more strictly speaking, corresponds with the larva condition of the latter. The ventral chain of ganglia is numerous in proportion to the number of segments which enter into the composition of the body, their number decreasing as the locomotive limbs over which they preside become more fully developed and capable of more vigorous action. Thus in *Julus* and *Geophilus*, where the limbs are extremely numerous and feeble, the ganglia in their number and small size approximate the condition they exhibit in the *Nereis* or more elevated Annelides, but in *Scolopendra* (fig. 313) the more powerful limbs and stronger muscles required by their carnivorous habits demand greater development of the centres of the nervous system.

* Vide Med. Gazette for 1837.

Fig. 312.



Fig. 313.

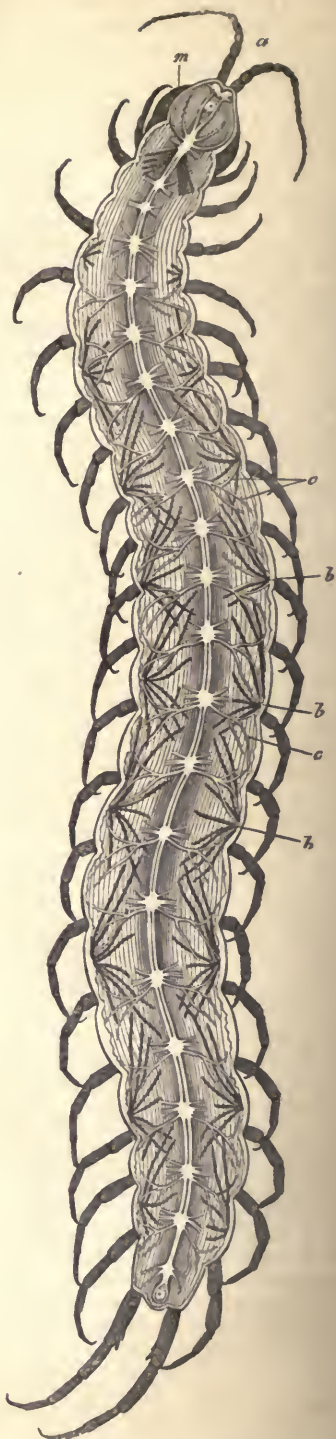

Senses.—In the structure of their organs of sensation likewise, the Myriapoda so nearly

resemble Insect larvæ that little can be said concerning them in addition to what the reader will find elsewhere stated. (See articles ANNELIDA, CRUSTACEA, ARACHNIDA, INSECTA.) The *antennæ* upon the head, which are invariably two in number, correspond in all essential circumstances with those met with in Insects, and doubtless perform the same functions. The *eyes* when present, which is not the case in all the genera, exhibit the form of simple ocelli congregated upon the head, and arranged in lines or triangular patches; but in no case do they exhibit the appearance of a really compound eye, such as is possessed by the generality of Insects in their perfect state. With respect to the other senses, touch, taste, and smell, but little is known except by conjecture, and presuming them to exist we can only suppose them to be conferred in the same manner as in the real Insect.

Generative system.—A remarkable difference exists between the Chilognatha and the Scolopendroid Centipedes with respect to the position of the organs of generation. In the former the external openings, both of the male and female genitals, are situated near the anterior extremity of the body, as is the case among the Annelida; whilst in the Chilopodous genera, which exhibit a higher grade of organization, the generative apertures are found in the caudal segment as in the Insects.

In *Lithobius* the structure of these parts is in both sexes very simple. In the male there are three long and convoluted secreting tubes resembling the simplest form of the testis in Insects, wherein, doubtless, the seminal fluid is elaborated. These are united at their terminations so as to form a kind of common receptacle, from which two tubes proceed to the root of the intromittent organ, at which point they are joined by four smaller auxiliary vessels, which seem to take their origin in masses of fatty substance. The penis is a horny cylindrical tube that can be protruded from beneath a valvular plate which covers the anal orifice (fig. 309, o).

The female apparatus consists of a single sacculated ovary, occupying the mesian line of the body. From this proceeds a narrow excretory duct, which, however, prior to its termination beneath the anal segment becomes considerably dilated into a cavity that has been improperly named *uterus*. Here it receives two sets of supplementary vessels, the one a pair of wide cœca, the other composed of four convoluted vessels apparently destined to secrete some additional covering to the eggs before their extrusion. The female generative orifice, situated in the anal segment, is covered with a horny plate and furnished with a pair of small horny forceps calculated to assist in copulation.

The male generative organs of Scolopendra present a very peculiar structure; but these we have already described elsewhere (see GENERATION, ORGANS OF).

The male generative organs of *Julus* (fig. 314, A) are two elongated and partially convoluted tubes placed side by side beneath the alimentary canal immediately above the nervous system.

The excretory ducts or terminations of these tubes run towards the *anterior* part of the body, where they terminate in two organs of intromission (a), which pass out at the under surface

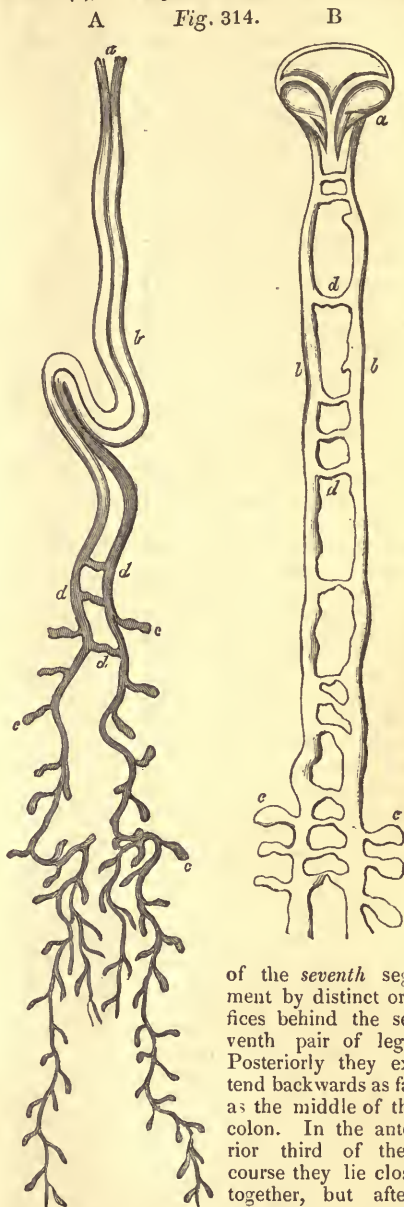

Fig. 314.

of the seventh segment by distinct orifices behind the seventh pair of legs. Posteriorly they extend backwards as far as the middle of the colon. In the anterior third of their course they lie close together, but afterwards separate, become smaller, and have developed from their sides at short distances a number of minute glandular cœca, or transparent vesicles (c), which doubtless constitute the secreting portions of the apparatus or proper testes of the animal. The two efferent ducts, whereby the secretion of these cœca is conveyed out of the body, inter-communicate freely by short transverse canals (fig. 13, d d), and from the sacculated

appearance that they present towards their termination appear in some species to perform likewise the office of reservoirs for the seminal fluid. In a large African species Mr. Newport found the double organ of intromission to be prehensile (fig. 314, B, *a*), each part having the form of a distinct claw between the moveable joints, of which passes out the elongated half corneous penis. These parts are covered in anteriorly by a horny valve somewhat of a triangular form, and the whole occupies an oval space on the under surface of the seventh segment, corresponding to that usually occupied by the legs. "With regard to the product of secretion in these organs," observes Mr. Newport, "I have never yet found any thing but a granulous fluid in the cœca, apparently similar to the granules in the higher animals from which Spermatozoa are produced, but this might have arisen from the immature recent specimens I was alone able to obtain. It would be interesting to ascertain whether these germs of Spermatozoa are produced in the cœca as there seems reason to believe, as we shall presently find that the ova in the female are secreted in sacs which appear to be analogous to these cœca in the male organs. I am inclined to think that the Spermatozoa are not developed until the granulous fluid has passed into the efferential ducts at the season of impregnation."

The female organs of the *Julidæ* (fig. 315) are described with equal minuteness in the paper above referred to, from which we extract the following exceedingly valuable observations, as nearly as possible in the words of Mr. Newport himself, to whom we are also indebted for the illustrative figures. In the female *Julus*, the organs of reproduction are as simple as those of the male. They consist of a single elongated bag or oviduct, covered on its exterior surface with a very great number of ovisacs or cœca of various sizes, each of which secretes but a single ovum. This oviduct extends backwards beneath the alimentary canal, from its



Fig. 315.

double vaginal outlet (*a a*), which is situated in the fourth segment behind the second pair of legs, as far as the posterior part of the rectum close to the anus, where it ends in a *cul-de-sac* (*d*). It is most nearly in contact with the alimentary canal on its upper surface, but is separated from it by adipose tissue; in the pregnant female it is smooth, and distended with ova that have passed into it from the ovisacs, and are ready to be deposited immediately after intercourse with the male. The ova at the anal extremity, that is, at the commencement, of the duct are as perfect as those near the vaginal outlets. The oviduct contains within its cavity, at least from seventy to eighty of these perfect eggs awaiting impregnation, arranged in two or more irregular rows, and greatly distending its sides. In some of the larger species of the genus there are four and in others five rows of eggs, the number of which is much greater than in our native species. The ovisacs (fig. 315 and 316, *c c*)

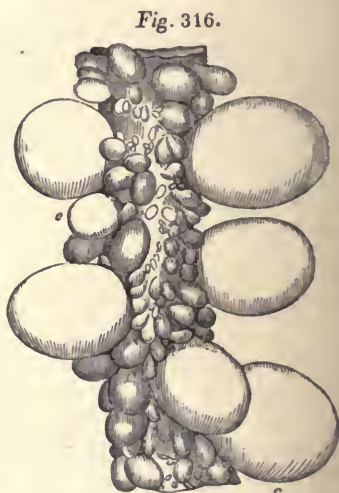

Fig. 316.

are little sacculi, distributed thickly to the number of many hundreds over the whole exterior of the oviduct, from its posterior or cœcal extremity to within a short distance of its vaginal outlets. Each ovisac, whatever be its state of development, contains but a single ovum, every part of which is produced in it, from the germinal vesicle in the most rudimentary form to the yolk, albuminous fluid, and shell. This fact deserves particular consideration. A large proportion of the ova in the ovisacs never arrive at maturity, but are retarded in their growth by the more rapid development of others that are near them, so that on examining an oviduct partially distended with ova, the greater number of ovisacs in different states of development, are at the sides and on the under-surface of the duct, in parts which correspond to the interstices between the fully developed eggs, that have passed into the oviduct, or are still forming on its exterior. One row of ovisacs usually exists on each side of the duct near its upper part, but most of the ovisacs in the course of development are at its sides.

The structure of the duct and of its numerous ovisacs is best seen in those specimens that have not yet arrived at maturity, or in those which have just deposited one laying of eggs. In these individuals the oviduct, to within a short distance of its division into two outlets, is studded with minute ovisacs, each filled with the rudiments of its minute ovum. Its general appearance in a female, that has recently deposited its eggs, is completely botruoidal, very like the ovary of Birds, some ova being always fully developed, and ready to pass into the oviduct, while others are in various stages of development, many of which are imperceptible except with the aid of a powerful lens.

But the most remarkable condition of the female organs in the Julidæ is their double vaginal outlet, as in Crustacea, although the oviduct itself is a single tube until near its termination, where it is divided into two short canals, which from a slight opacity at their base, where they join the single duct, appear, when seen by transmitted light, to be separated from it by a valve or duplicature of the lining mucous membrane. The vaginal orifices are simply two nipple-shaped portions of the tegument, with somewhat oval apertures surrounded by a corneous ring, from which is developed a circle of minute hairs. They are situated on the under surface of the fourth segment of the body, and correspond in position to the insertion of the legs in the third segment.

Ova.—We have already seen from Mr. Newport's description of the female generative system of *Julus*, that the ova are formed in separate ovisacs, from which they issue completely constituted eggs, into the cavity of the ovarium or common duct, through which they are expelled from the body after impregnation; and we now proceed to lay before the reader the important results of the investigations of that distinguished anatomist relative to the structure of the ova themselves, and the progress of embryonic development. The existence of the ovisacs in *Julus* as single isolated capsules on the exterior of the oviduct, in each of which a single egg is produced, is, Mr. Newport observes, a circumstance particularly favourable to a minute examination of the ovum in all its states, especially as ova are found at the same time in every stage of development. The smallest ovisacs appeared like very minute glandiform bodies, developed, as it were, immediately from the structure of the duct itself, and in these the rudiments of the future egg had already begun to be produced. The smallest rudiments of eggs examined were of an elongated shape, and as yet not more than three, or at most four blood-globules in diameter. They appeared already to have distinct parietes, and to be filled with very minute graniform cells of a uniform size, slightly opaque, and of a yellow colour. The diameter of these cells, as nearly as could be ascertained by direct comparison, was equal to about one-third of that of a blood-globule. In the midst of these cells there was a larger but much more delicate structure of a circular

form and equal in size to about two of the cells, but whether this was the *germinal vesicle* or its *macula* could not be determined. Other ovisacs twice the size of the foregoing were filled with similar contents, and from the opacity and yellow colour of the graniform cells, it was evident that they constituted the yolk in one of its earliest stages. At a later period both the yolk and its including vesicle are inclosed in a distinct membrane—the *membrana vitelli*, and before its escape into the oviduct all the parts of a perfect egg, namely, the *yelk*, the *germinal vesicle* with its *macula*, the *membrana vitelli*, the *albumen*, and likewise the *shell* lined by the *membrana externa* or *chorion*, are completely formed.

Evolution of the embryo.—The development of the young *Julus* Mr. Newport divides into several distinct and well-marked periods, during each of which phenomena are presented of the utmost interest, both to the physiologist and in an entomological point of view.

The first period extends from the deposition of the egg to the gradual bursting of the shell, and exposure of the embryo within it, occupying the space of twenty-five entire days, during which the egg acquires a sensible increase of bulk.

On the nineteenth day there was a complete alteration in its form; it was more obtuse at both ends, and had become much larger, and the outline of the embryo, coiled up within the shell and nearly filling the whole interior, was very distinct, although, as yet, there were no rudiments of limbs or even of a division of the body into distinct segments. On the following day, the twentieth, the outline of the embryo was more apparent, and on its concave or ventral surface there were faint traces of a division of the body into six segments (*fig. 317**).

Up to this period Mr. Newport was unable to detect any funis or umbilical cord attached to the embryo, although, in consequence of Rathke's observations in Crustacea, such a structure was particularly sought for, the whole body still appearing to be formed of cells of different sizes.

From this time the egg became every day larger until the *twenty-fifth* day, when it was greatly distended and began to assume a kidney-shaped appearance, and commenced bursting longitudinally in the median line of the dorsal surface, the back of the soft and perfectly white embryo gradually pressing through the opening.

In the *second period of development* the embryo is exposed to a new medium, and perhaps derives the means of its further growth from external sources, although it is still enveloped in the fetal membranes and retains its connection with the shell.

The liberation of the embryo is a remarkably slow process as compared with the escape of other animals from the egg. In Mr. Newport's observations, from ten to twelve hours

* This and the succeeding figures are copied from Mr. Newport's paper, before quoted. The objects have been magnified twenty-five diameters.



elapsed before the body of the young myriapod was so far liberated as to remain only partially enclosed between the two halves of the shell, as represented in *fig. 318*, being still attached to its interior by a pedicle or funis (*fig. 319, d*). So remarkable is its condition at this period that it strongly resembles the expansion of the germ in the seed of a plant, rather than the evolution of a living animal. The embryo is perfectly motionless, and the bursting of its shell appears to be effected not by any direct effort of its own, since, up to this time, it has acquired only the form and external semblance of a living animal; but, by the force of expansion of the growing body, the development of which being greatest along the dorsal or larger curvature, exerts, in consequence, a greater degree of force against the middle of the dorsal than the corresponding part of the ventral surface; the head and tail of the embryo acting as a fulcrum against the ventral surface only at the ends of the shell, and thus bending it into the kidney-shaped form it assumes, while the dorsal surface of the embryo is gradually pressed through the opening. From the comparative rapidity of its enlargement immediately after the shell is fissured, Mr. Newport observes, that it seems as if the stimulus given to it by exposure to a new medium, atmospheric air, were the great means of exciting its evolution.

The embryo is now formed of eight distinct segments (*fig. 319*), including the head, the ninth or anal segment being still indistinct. The head is more defined in its outline, and firmer in texture than other parts of the body, and is inflected against the under surface of the prothorax (2) or second segment, from which it is divided on the upper part by a deep transverse line: at its sides it exhibits a faint trace of the future antennæ. The four thoracic segments also exhibit on their ventral surface little nipple-shaped extensions, three of which on each side are the rudiments of future legs. When viewed from above, the body of the embryo appears compressed and wedge-shaped, its greatest diameter being in the second and third segments, while each succeeding segment is more and more contracted. Mr. Newport was unable at this period to detect any separate internal organs, the whole embryo being still a congeries of vesicles or cells, in the midst of which there seemed to be some faint traces of the commencement of an alimentary canal.

"At the end of the first day," continues Mr. Newport, "I carefully removed the embryo and shell into diluted spirits of wine, and, on ex-

amination beneath the microscope, found the body of the embryo covered with an exceedingly delicate cuticle, through which the cells it was formed of were distinctly visible. It was also completely enclosed in a smooth and perfectly transparent membrane (*fig. 319, c*), which seemed to contain a clear fluid, interposed between it and the embryo. This membrane I regard as the analogue of the *amnion*, the *vitelline* or investing membrane of the embryo in the higher animals, and identical with the *membrana vitelli*, before described, as the proper membrane of the yolk in the egg of *Julus*. It is a shut sac that completely invests the embryo, except at its funnel-shaped termination at the extremity of the body (*fig. 319, d*), where it is constricted, and together with another membrane (*e*), which in the unburst egg is external to this and lines the interior of the shell, assists to form the cord or proper funis (*d*).

"The funis enters the body of the embryo at the posterior part of the dorsal surface of the future penultimate segment, where the mucro or spine exists in the adult animal, and not at the dorsal surface of the thoracic region, as seen by Rathke in the Crustacea. The proper anal or terminal segment is, as yet, but imperfectly developed. In the funis (*d*), I also observed some exceedingly delicate structures that exhibited all the appearance of vessels. They seemed to enter the body by two sets, that were spread over and entirely lost in the membrane (*e*). Whether these were indeed vessels, or merely folds of the membrane I am not certain. The membrane (*e*) in which they appeared adheres closely to the shell and retains the embryo in connection with it by means of the funis. In the unburst egg, this is also a shut sac like the amnion, and forms the *membrana externa* or chorion (?), the second or outer investing membrane of the ovum lining the interior of the shell.

"The detection of these two investing membranes of the embryo in Myriapoda may," says Mr. Newport, "be regarded with some interest in reference to the analogies which they bear to similar structures in Vertebrata, since they shew the persistence of one universal law in the mode of development of the germ."

On the *third day* the embryo had considerably increased in size, but was still perfectly motionless and attached to the shell by the funis. This attachment continues for many days, during which the embryo remains partially protected by the two halves of the shell. When examined at this period in the recent state, all the parts of its body are still indistinct, but in specimens that have been for some time in 'spirits of wine, the divisions between the segments are well marked. The rudiments of the legs are more developed, but those of the second and third segments less than the fifth, so that not only at the bursting of its shell, as noticed by Savi, but also for several days afterwards the embryo is completely apodal, the future limbs existing only in a rudimentary state. Posteriorly to the fifth segment, the body is more soft and delicate, and the segments less clearly defined. This results from

Fig. 318.



Fig. 319.

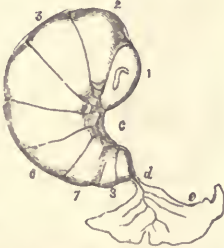

the circumstance that it is at this part of the body that the future new segments are to be produced.

On the *fourth day*, Mr. Newport first observed some faint traces of a single eye, or *ocellus*, on each side of the head. The embryo had now further increased in size, and the rudiments of its future legs had become larger and more obtuse, an appearance which the newly-formed limbs of the Articulata often exhibit previously to their further elongation. Traces of the formation of internal organs were now evident through the tegument at the posterior part of the body, and the funis was contracted as if about to separate. Internally the body was still formed of cells aggregated together, but differing more in size than at any previous period, as if they were becoming fused into separate tissues, and in the midst of them and closely surrounded on all sides was the newly-formed alimentary canal. The canal was now more opaque, and when pressed out of the body more firmly adhered together than any other internal structure, and was distinctly composed of an aggregation of very minute cells. Around the sides of the body muscular structure was also in the course of development, but as yet was exceedingly indistinct, inasmuch that Mr. Newport could discover no perfect fibre, a fact that sufficiently accounts for the entire absence of spontaneous motion in the embryo up to this period.

A new process was now about to commence—the development of new segments. On the third day, as has been already stated, the posterior part of the body is less distinctly divided into segments than the anterior, the first five segments being most distinctly marked. The sixth and seventh are now more defined. It is in the membrane *f*, *fig. 321*, that connects the seventh with the eighth segment at the posterior margin of which last the funis (*d*) enters, and which segment is permanent as the *penultimate* throughout the life of the animal, that the formation of new segments is taking place. At this period it is only a little ill-defined space that unites the seventh and eighth segments into one mass, but in proportion as the anterior parts of the body become developed, this part is also enlarged, not as a single structure, but as a multiplication or repetition of separate similar structures.

On the *ninth day* the changes have advanced much further (*fig. 320*); not only have the future new segments become more distinct, but transverse depressions are also seen on the dorsal surface of the original segments, shewing their division into double ones, as in the perfect animal. The rudiments of the legs are now further developed, and their transparent distal extremities are seen through the investing membrane applied closely together and extended along the ventral surface of the body, as in the

nymphs or pupæ of true Insects. The antennæ and ocelli are more apparent, and the embryo itself has increased at least one-third of its original dimensions. It is still attached by the funis to the shell, but this attachment is daily becoming more fragile, and is now separated by very slight causes. The embryo has thus continued to grow through nine succeeding days, since the bursting of its shell, without any visible means of nourishment, the nutriment supplied by the yolk having been exhausted before that occurrence. Hence it becomes a matter of inquiry from whence it now derives its means of growth? Whether it has already sufficient materials derived from the egg, and stored up within itself for its future development, or whether the external inclosing membrane may not still contribute to the function of nutrition by absorbing fluid condensed from the air of the humid locality in which it resides. The probability of this last supposition, says Mr. Newport, is somewhat countenanced by the fact that I have constantly observed the membranes of the embryo at this period covered with microscopic drops of fluid, but whether this is fluid condensed on the membranes from the atmosphere of the dwelling, or whether it results from the transudation of that which was contained in the amnion, remains for future inquiry.

Up to this period the embryo gives not the slightest evidence of spontaneous or voluntary motion. Internally it is still composed of cells of different sizes that are now in the course of producing muscular and other structures. In some parts of its body no arrangement of them seems as yet to have taken place, the cells being merely aggregated together. Cells of three very distinct sizes now exist. The diameter of the largest of these is nearly three times that of the second size, and the second again are nearly twice and a half the size of the smallest. The smallest sized cells fill up the interspaces between the others, and appear as if breaking down to form interstitial or cellular substance, while the second sized cells are arranged in rows to form particular structures.

In the midst of these cells the alimentary canal is now nearly complete, but Mr. Newport was unable to observe its connexion with the funis. At its anal extremity it is a little dilated, and extends forward as a short straight intestine, the *rectum*, until it arrives at a part where a valve seems about to be formed. The diameter of the canal is there enlarged, and on its surface are three distinct longitudinal muscular bands. The so-called *hepatic vessels* also exist as distinct tubes inserted one on each side into the alimentary canal at the constricted or valve-like part above noticed. The canal is then continued forwards until it is again dilated into the proper stomach, and terminates or rather commences in a narrow oesophagus. It is much longer than the body of the embryo, being convoluted or folded upon itself in its lower portion, to adapt it to the changes that the body undergoes in the enlargement and elongation of its segments. It is not yet separated from the now forming structures by any distinct

Fig. 19.



investment, either adipose or peritoneal, except only what belongs to itself; but is closely surrounded by cells of the second and third size.

On the *tenth day* the great circulatory or dorsal vessel was distinctly seen through the amnion and skin. This doubtless had existed much earlier, although not observed. It was exceedingly well marked, but Mr. Newport was as yet unable to detect any motion in it. The head of the embryo had now begun to assume the peculiar corneous appearance common to the larvæ of true insects; its body had much increased in size, and the amnion was still covered with microscopic drops of fluid.

On the *eleventh day* the head was more distinct, and the antennæ appeared at its sides like short crescent-shaped clubs, with their terminations directed forwards. Above them the single ocelli were distinctly seen. All the segments, posterior to the third, exhibited the transverse line that indicated the division into double segments, and the posterior segments were much increased in size.

On the morning of the *seventeenth day* (fig. 321) Mr. Newport found all the embryos ready to leave the amnion.

Some of them were already detached from the shell; others were still connected to it. Their increase of bulk within the last few hours had been very great. The body was now more straightened, the head less inflected under the thorax, and the eye was a dark-coloured spot above and behind the antennæ. The segments of the body were divided by distinct reduplicatures of the proper tegument, and the legs folded side by side against the ventral surface were much further extended beneath the amnion (*b, a*). The transverse divisions of the first six segments strongly marked the original segments, and the amnion, now about to burst, was tightly extended over the dorsal surface, and by the elongation of the body was rendered more distinct on the ventral. The great increase in the length of the animal was mainly occasioned by the growth of the posterior segments, more especially those in the antepenultimate space, the proper germinal space or membrane (*f*), the faint divisions of which into new segments were now distinctly seen through the amnion. The seven anterior segments, including the head, were greatly enlarged, and the hitherto minute anal and penultimate segments (8, 9), in the first of which the remains of the funis (*d*) forms a rudimentary spine, had also become enlarged, and were now fast acquiring the form they afterwards retain throughout the life of the animal. Some of the specimens soon threw off their covering and entered the third period of development.

The animal was now greatly enlarged, and possessed three pairs of legs, but it still lay with these newly developed legs coiled up without voluntary motion. The amnion had

been fissured at its anterior dorsal surface, and slipped off backwards from the posterior segments, and lay at the anal extremity, while the animal itself, with its limbs coiled up, appeared as if exhausted with these its first spontaneous efforts. No other signs of animal existence were given than occasional slight movements of the antennæ. The embryos thus passed from their apparently inanimate to an animated state of existence, from a condition in which they appeared merely to vegetate, endowed with no voluntary or instinctive powers, but like the vegetable formed entirely of an aggregation of cells, totally incapable of spontaneous motion, to one in which they became active beings, gradually acquiring voluntary and instinctive faculties both as regards the means of procuring nourishment and of preserving themselves from injury.

In *about an hour* after leaving the amnion the young *Julus* exhibited a marked change. Its head was elongated on the prothorax (2), the parts of the mouth were distinctly moveable, and the eye, a single ocellus on each side of the head, acquired a darker colour. The whole body had been increased at least one-fourth in bulk since leaving the amnion. It now measured about a line in length, and exhibited very distinctly the nine original segments. The seven anterior of these were strongly marked. In the *germinal space*, (fig. 321, *f*;) between the original seventh and eighth segments, *six new segments* were now developed. These were still very small, the length of the whole being equal only to that of one of the original segments. At the present time they did not form independent divisions of the body, but were covered by the common tegument, and thus appeared like supplementary parts of the seventh segment produced from the germinal membrane and interposed between the seventh and the penultimate segment (8), which, as before stated, is a permanent segment throughout the life of the animal. This latter fact shews that it is not merely by an elongation and division of the terminal segment that the body of the *Julus* is developed, but that it arrives at its perfect state by an actual production of entirely new segments; that these are new growths or formations which are in progress long before they are apparent to the eye, and that the original segments of the ovum into which the animal is first moulded are permanent segments throughout its whole life.

But still more curious is it that not only have new segments been formed as described, but that the common tegument by which they are now covered and which also invests the whole body as the true skin, has already begun to be detached preparatory to its being thrown off, as is shewn in the fact that the new segments are now seen beneath it; and it is further remarkable that this deciduation of the first skin of the animal had actually commenced before the bursting of the amnion. These circumstances explain the cause of the very quiescent state of the young *Julus*, and its almost and perhaps entire abstinence from food whilst this skin remains on its body. It is not until this skin

Fig. 321.

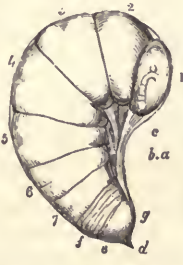

is thrown off that the new segments become elongated, and the *Julus* then appears suddenly to have acquired six new divisions to its body.

The production of new legs is equally curious. Up to the present period the animal has but six legs (*fig. 322, b a*), but four additional pairs are nevertheless in the course of formation. These at present exist only as eight minute nipple-shaped prominences on the under surface of the sixth and seventh segments (*b c*), four on each, covered by the common tegument, which, we have seen, is becoming deciduous. The three single pairs of legs that now exist as the only locomotive organs are attached, one pair to the prothorax or second segment, one to the third and one to the fifth segment. The fourth, or segment intermediate between these last, never possesses any legs, but in the female contains the outlets of the organs of generation. The general appearance of the animal has now become less delicate, the head has acquired a darker colour, and a faint broad patch (*fig. 322, p*) is now making its appearance at the anterior part of the seventh segment.

This patch, which is permanent through all the earlier changes of the animal, is of the greatest utility in determining the production of new segments. It is in the segment immediately posterior to this that the male organs find their outlet, a circumstance the more remarkable from the fact that

this outlet is in the anterior part of the original germinal space, and at the bursting of the egg this is very near the termination of the body. Such was the condition of the young *Julus* one hour after leaving the amnion. It soon began to exhibit its animal powers, to shew the instincts peculiar to its species, and to be sensibly affected by external causes. In less than six hours from the bursting of the amnion the little creatures were in motion. At first the antennæ were the organs employed. They were moved slowly to and fro, and seemed to gain power by use. In a short time the limbs began to be extended, and the animal slowly raised itself upon them for the first time. Its first efforts at locomotion were exceedingly feeble, but it gradually gained strength. At the end of twelve hours the embryos crawled slowly about, but moving the antennæ briskly. On exposing them to a strong light a marked effect was produced in their movements. They evidently were greatly affected by it, and seemed instinctively to shun it. This was the first marked exhibition of instinct. Locomotion was at first performed very slowly but with instinctive care. The anal segment, previously to each step, was expanded like the anal leg of the larva of an insect, and being first attached like a true pro-

leg, and its step, as it were, measured, its body was carried forwards by an effort that extended, as in insects, from segment to segment.

At *twenty-four hours* after escaping from the amnion the young animals were lying together in a heap, but when disturbed seemed to have acquired more power of moving: they remained quiet except when aroused, and had not yet taken food. The only marked difference in their appearance, excepting that they had still further increased in size, was in the nipple-shaped protuberances on the sixth and seventh segments, the rudiments of future legs. These were now more distinct and mammiform. Ten hours later in the day they assumed still more the appearance of nipples projecting from the under surface of the segments. When examined in specimens that had been placed in spirits of wine, it became evident that these projections were occasioned by the development under the deciduous tegument of four new, but exceedingly minute legs, complete in all their parts, each covered by its proper skin. The claws to the legs of the other segments were also more strongly marked. The new segments (*f*) were more developed, although still covered by the common tegument, and, as in the preceding state, forming only one division of the body, while a small space behind them indicated the point from which other new segments were to be produced.

On the *nineteenth day*, Mr. Newport found that the animals had acquired a little darker colour, but were still remaining quiet in their cells, and did not appear to have taken food. The enlargement of the body had not extended to the *prothorax*, which did not increase in size in proportion to the rest. The double pairs of new legs to the sixth and seventh segments were now distinctly visible through the external tegument, which had begun to be separated from the under surface of the old segments, to which up to this period it had closely adhered. The patch on the side of the seventh segment had become darker, and the new segments were further advanced.

On the *twenty-first day* (*fig. 323*) the young *Julus* still remained coiled up and perfectly

Fig. 323.

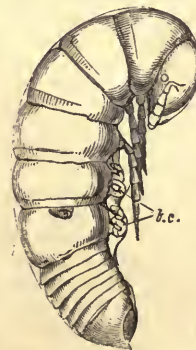

quiescent, with their legs disposed side by side along the under surface of the body, like the pupæ of Lepidopterous Insects. The new legs had considerably increased in size, as well as the whole animal, although it had not taken food. The animal was still partially coiled up, but the skin that covered its body was greatly distended, more especially along the ventral surface. It was less able to move than before, the period

of throwing off this skin being fast approaching: the double legs of the sixth and seventh

segments, inclosed in their proper skin, were now more elongated and very much enlarged, and the new segments were further developed as well as the germinal membrane. The external tegument was more extensively separated from the whole body, especially at the posterior part, and the head was retracted within it and bent on the under part of the thorax. It was thus evident that this tegument was not of recent formation, that it simply enclosed the animal as the whole had been previously enclosed in the amnion, as is proved by the circumstance that it extended smoothly over the whole body, antennæ and legs, and did not follow the inflection or reduplication of the proper surface of the animal like the true skin beneath it, but passed directly over the segments, and was simply protruded or distended by the growth of parts beneath, as in the instance of the new legs (*b*). Up to this period, therefore, observes Mr. Newport, the young *Julus* must still be regarded as in the embryo condition, although for a day or two after bursting the amnion, it possessed the power of locomotion and evinced some development of instinct. At its next change of skin, when it enters what Mr. Newport regards as the fourth period of its development, and when it has acquired fourteen pairs of legs, it assumes for the first time a condition analogous to the larva state of true insects on bursting from the ovum; the difference between the two being that the analogue of this tegument of the embryo in insects is slipped off at the bursting of the amnion on leaving the shell, while that of the Myriapod is not thrown off until some days after it has entirely left the ovum. This embryo condition of the animal will therefore explain the circumstance of its first acquiring a slight power of locomotion, and then remaining perfectly quiescent without taking food to prepare for this change—the third period of its embryo life.

The lower portion of the alimentary canal is at this time distinctly visible through the new segments, exhibiting a corrugated or folded appearance, an arrangement doubtless intended to allow of its sudden extension at the period of throwing off the skin and elongation of the segments. The colon is of a very dark colour and exhibits its thickened peculiar structure with its longitudinal muscular bands. Around its posterior part, Mr. Newport observed an aggregation of what appeared to be globular cells. They seemed to be part of the organs of generation in the course of development. At first they were regarded as hepatic vessels, but this Mr. Newport considers could hardly be the case from the fact that each of these organs directly enters the canal as a straight vessel, but they might be vessels folded up to be unfolded suddenly, as in the case of the alimentary canal.

By the *twenty-sixth day* the young *Julus* casts off the covering in which it had hitherto been infolded, and enters the *fourth period of development*, having now seven pairs of legs and fifteen segments to its body (*fig. 324*).

In this condition the antennæ were found to have become elongated by at least one-third of

their original length, and exhibited six distinct joints. The eye still consisted of a single ocellus, but this was now surrounded by a darker coloured portion of the tegument. The new

Fig. 324.



legs (*b c*) were equal in size and length to the original ones, but were evidently more feeble. The transverse markings on the seven anterior segments (2-7) were very distinct, and the large brown patch on the seventh segment was much darker in colour. The whole body of the animal was considerably elongated. This was produced chiefly by the extension of the new segments (7 *g*) formed by the germinal membrane at the posterior part of the seventh, and which, in the early part of the last period, seemed to form a single distinct segment covered by the common tegument. The most anterior of these segments (8), now the eighth of the whole body, had acquired an extent equal on its upper surface to the preceding segment, but was shorter on its ventral surface. Like the preceding original segments it was divided into two regions by a transverse depressed line. The next segment in succession to this, the ninth, had also become enlarged to about one-third of the size of the eighth, and was, like it, marked transversely. The next four segments were each more developed than in the preceding state, but not to so great an extent as the others. The two remaining segments (14 15), the penultimate and anal, had undergone no change. They had simply acquired a little extension at the apex of the segment, and were now covered with a few scattered hairs. It is thus proved that the body is elongated, not by the division of the newly formed segments into others, but always by the formation of new ones in the germinal membrane that extends from the posterior margin of the antepenultimate segment to the penultimate, which last segment, with the anal, undergoes no change. That segment is always furthest advanced in growth which is immediately posterior to the last segment that possesses legs, and then the next in succession, until we arrive at the terminal ones—the penultimate and the anal—that never possess legs.

By the forty-fifth day more new segments had evidently been developed by the germinal

membrane, soon to be exposed by another change of skin that was about to take place. The *Julus* ceased to eat, became torpid, and lay coiled up in a spiral form. The tegument of the body began to assume a whitish crustaceous appearance, and the animals secreted themselves beneath any dry covering, but avoided parts too wet. The principal changes in their general appearance were in the eyes, each ocellus being much more distinct, and in the germinal space, which was developed to its greatest extent, and distinctly exhibited the six new segments.

The change of skin, according to Mr. Newport, is effected in the following manner. The young *Julus*, when about to cast its integument, bends its body in a semicircular form, with its head inflected against the under surface of the second segment. In this condition it remains for several hours with its legs widely separated and the dorsal surface of the segments extended. The head is then more forcibly bent on the sternum, and a longitudinal fissure takes place in the middle of the epicranium, and is immediately extended outwards on each side posteriorly to the antennæ in the course of other sutures, the analogues of which Mr. Newport has described as the triangular and epicranial sutures. Through the opening thus formed in its covering the head is then carefully withdrawn, and with it the antennæ and parts of the mouth, and afterwards the anterior segments and single pairs of legs. The first and apparently the most difficult part of the shedding of the skin is its detachment from the posterior segments of the body and from the interior of the colon. To effect this the animal, which has been previously lying coiled up in a circular form, first straightens its whole body; it then forcibly contracts and shortens itself, especially at the posterior part, and by this means becomes greatly enlarged in bulk at its middle portion, but smaller at its extremities. During these efforts, which are some of the most powerful it is able to make, the skin becomes loosened from its posterior parts, and while still contracting its segments, the anal extremity, and with it the entire lining of the colon, become completely detached, and from these it gently withdraws itself within the old skin in which the body is encased as from the finger of a glove. This is precisely what takes place in the shifting of the skin in insects. Having effected this part of its labour all the posterior segments are again shortened; the animal once more disposes itself in a circular form, and after repeated exertions succeeds in bursting the tegument of the head in the part just described. As in the case of true insects the young *Julus* entirely empties the alimentary canal by voiding its feces and ceasing to eat for one or two days preparatory to undergoing each transformation. When examined immediately before the change there are no other symptoms of new legs than slight elevations of the skin, and this perhaps accounts for the length of time occupied in the change, the new legs requiring time for further development before the old skin is thrown off.

Having cast its skin and thus attained the

fifth period of development, the young *Julus* (*fig.* 325) has three ocelli on each side

Fig. 325.

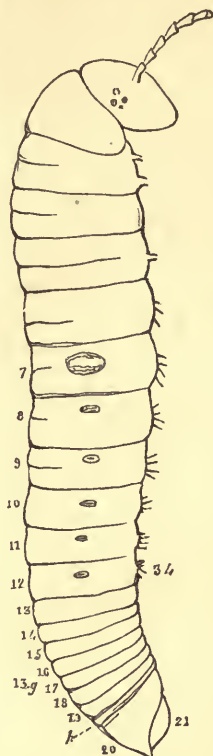
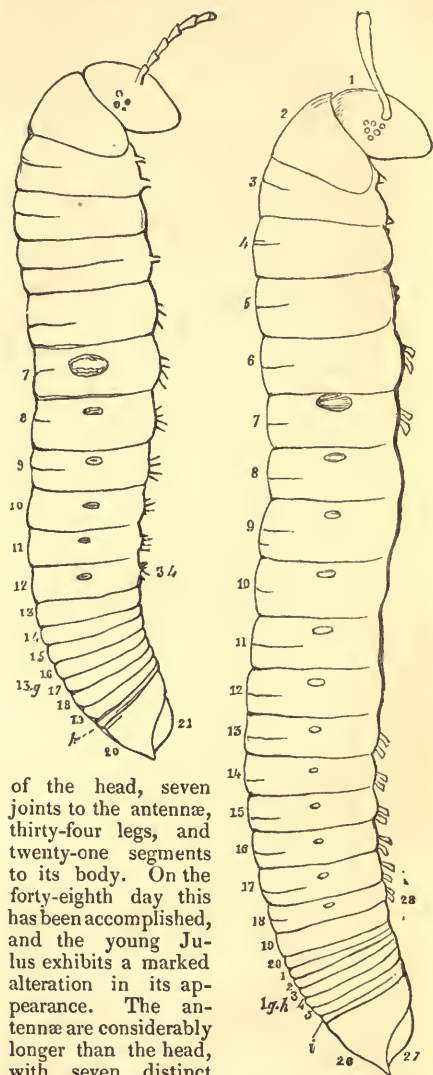

Fig. 326.



of the head, seven joints to the antennæ, thirty-four legs, and twenty-one segments to its body. On the forty-eighth day this has been accomplished, and the young *Julus* exhibits a marked alteration in its appearance. The antennæ are considerably longer than the head, with seven distinct joints, and, as in the adult, the apical one is short and inserted into the sixth. The single eye has disappeared, and in its stead three distinct ocelli, arranged in a triangle, have been developed. The new segments of the body produced at the former change of the animal, from the eighth to the twelfth inclusive, (8-12), are now of the same size as the original ones, and each has developed from it two additional pairs of legs, so that the whole number of legs is now thirty-four. The thirteenth, or, if we may so name it, germinal segment of the last period, is less developed than the preceding ones, and is distinguished from them by the circumstances that it is smaller, possesses no legs, and has no lateral

spot which exists on each of the preceding segments to the seventh, marking the existence of the *foramina repugnatoria*. The germinal space (13-19) which existed in the preceding period and was then seen to be forming segments, is now developed into six new apodal segments, from the 14th to the 19th inclusive, very much smaller and shorter than the rest, and a germinal space (*h*) is again forming between the last of these and the penultimate segment of the body, which, as above stated, undergoes no marked change. The whole body is thus composed of twenty-one segments, including the head. The first twelve of these are now perfectly developed, as well as the last two, the intermediate ones being only in their preparatory states. The animals at this period ate voraciously some decayed leaves, rotten elm-bark, and raw potato.

On the sixty-third day the *Julus* again changed its skin, and entered its sixth period of development (*fig.* 326). It then had acquired twenty-seven segments to its body, which had greatly increased in size and was of a brown colour. It had now six distinct ocelli on each side of the head, and all the segments to the eighteenth inclusive were furnished with legs, of which it had now fifty-eight. Six additional new segments had also been developed to its body, as in the preceding changes anterior to the penultimate segment (1 *g h* 1 2 3 4 5 6), and the germinal membrane behind them (*i*) was still in further course of development, the penultimate segment (26) remaining always unchanged. The six segments (28) from which legs had been developed had also the *foramina repugnatoria* marked with small spots, while the spots on the preceding six had become larger and darker in colour, and the animal might now be regarded as having acquired all the essential parts of its body, its subsequent growth doubtless being effected by a repetition of the same interesting phenomena.

The observations of Monsieur Gervais relative to the development of the Scolopendroid Myriapoda, are the only ones on record with which we are acquainted; and although these are extremely desultory and incomplete when compared with the masterly researches of Mr. Newport concerning the Julidæ, detailed above, they seem to shew that the changes undergone by the Scolopendridæ, before they arrive at maturity, are scarcely less important than those we have been considering. M. Gervais studied more particularly the growth of *Lithobius*, (*fig.* 309,) Scolopendræ, which possess, when mature, fifteen pairs of feet, and also some individuals belonging to the genus *Geophilus*. A young *Lithobius* captured in the month of May was found as yet to possess only seven pairs of feet, ten segments in its body, two eyes on each side of its head, and but eight joints in its antennæ. Moreover, that only one segment, the anal, was deprived of feet, a circumstance which at once forms a remarkable difference between the young *Lithobii* and the young *Julii*, which latter have several apodal segments at the posterior extremity of the body. By the eighth of June the same *Lithobius* had fourteen joints in the antennæ, and

eight pairs of legs, together with eleven segments to its body, including an apodal one for the anal segment.

Another *Lithobius* of nearly the same age had already three eyes on each side, and a third only ten pairs of feet, of which the two posterior were still rudimentary and scarcely formed. In another example, even when all the fifteen legs were present, the creature had not as yet got its full complement of eyes, there being only eight stemmata on each side, whilst in the adult animal the optic facets are numerous.

It appears manifest, therefore, that the *Lithobii*, like the *Julii*, have the number of their segments increased as well as of their legs, and of the joints of their antennæ; and, moreover, that the number of their eyes increases with their age, a remarkable fact, which M. Gervais seems to have been the first to signalize.

With respect to the manner in which the number of pairs of feet and of segments is increased as the young *Lithobius* grows older, M. Gervais gives us the following information: "Examined upon the ventral surface of the body, the pedigerous segments of an adult *Lithobius* are found to be nearly of size equal, but examined from above where they are, as it were, imbricated, some appear larger and others smaller. The largest of the pedigerous segments are the 1st, 3d, 5th, 7th, 8th, 10th, 12th, 13th, and 14th, the three last corresponding inferiorly to four half segments, and consequently to four pairs of feet. The 2d, 4th, 6th, 9th, and 11th, are smaller, and feet already exist upon these smallest segments even before the dorsal portion is developed, so that what is permanently observable in one of the posterior segments, which has superiorly only one shield, obtains also at this period for two of the posterior segments, which have as yet but one dorsal plate, the smaller of the two dorsal plates not having as yet made its appearance. This fact is remarkable, for if we suppose the same phenomenon to be constant with all the rings, it is easy to explain how at all ages there are fewer dorsal segments than there are pairs of feet."

As relates to the *Geophili*, M. Gervais assures us the process is, in them, altogether changed, another proof of the numerous differences met with in the physiology of the various genera of the class under consideration, but not having completed his researches upon this subject, the author of the memoir from which we have quoted has not as yet informed us of the result of his observations concerning the *Geophilidæ*.

BIBLIOGRAPHY.—The literature of the anatomy and physiology of these animals is very limited. The reader may refer to the following works:—*Newport*, Philosophical Transactions for 1841. *Savi*, Osservazione per servire alla storia di una specie di *Julus* communissima. Bologna, 1817. Bulletin des Sciences Naturelles, Dec. 1823. *Memorie scientifiche di Paolo Savi*, Pisa, 1828. *De Geer*, Abhandlungen zur Geschichte der Insekten, 4to. 1762. *Waga*, Revue zoologique, par la Société Cuvierienne, 1839. *T. Rymer Jones*, General outline of the animal kingdom. Lond. 1841.

(*T. Rymer Jones.*)

NECK. Gr. *τραχηλος*; Lat. *collum, cervix*; Fr. *le cou*; Ital. *il collo*; Ger. *der Hals*. This word denotes that contracted, ribless portion of the trunk or column of support, which, in vertebrate animals, immediately sustains the head. Disease and accidental lesions so frequently submit it to surgical examinations and operative treatment, that familiar acquaintance with its intricate anatomy is of indispensable necessity to the practitioner.

The order which I shall adopt in the ensuing article is, first, to describe fully and in order the muscles and fasciæ of the neck, and subsequently the various regions into which it may be divided with the parts contained in them; the earlier portion giving, as it were, a mere skeleton view or diagram of the anatomy; the latter presenting the organs in their more natural, or regional arrangement, and treating of them in their living relations to disease, casualty, and surgical operation. I should recommend the student of this important part to pursue a similar plan; first, namely, thoroughly to impress on his mind those relatively firm and fixed textures which admit of practical use as landmarks, and not, till this task is completed and these anatomical boundary lines are vividly and individually before him, to fill up his sketch with important organs, or perplex his mind with their surgical relations.

I. THE MUSCLES.

The muscles of the posterior region of the neck and those of the shoulder having been described in a previous article (see BACK), the remainder may be considered in three classes—1. those which most nearly cleave to the vertebræ, are attached to their processes, and principally affect their motions; 2. those, chiefly in or near the median plane, which belong to the cervical portions of the respiratory and digestive apparatus, to the pharynx, larynx, tongue, and os hyoides; 3. the superficial muscles of the side of the neck, the sternocleidomastoideus, and the platysma myoides. The *first class* includes—1. *anteriorly*, the longus colli and rectus capitis anticus major; 2. *laterally*, the scalenus anticus, scalenus posticus, and inter-transversales, with which may be reckoned the rectus capitis lateralis and rectus capitis anticus minor.

1. *Anterior vertebral muscles*.—*M. longus colli* (*Pre-dorso-atloïdien*: Chauss.) is a thin elongated muscle, which occupies an extent in the pre-vertebral region, corresponding to the three upper dorsal and to all the cervical vertebræ. In form it is triangular, having its base at the bodies of these vertebræ, and its truncated apex at the middle transverse processes of the cervical region, and consists of three distinct, though united, parts, which would be represented by the three sides of such a triangle. One portion, the largest, is nearly vertical, next to the median line, and a direct flexor of the spine: it originates from the bodies of the three upper dorsal and four lower cervical vertebræ, as also from the intervening fibro-cartilages, and, ascending, is inserted by two slips into the anterior surface of the bodies

of the second and third vertebræ. The second part is directed from the transverse processes of the third, fourth, and fifth cervical vertebræ, at which it arises by tendinous slips,—upward and inward to be inserted into the anterior tubercle of the atlas, and it so continues to that bone the previous insertion of the muscle. The remaining part detaches itself from the main body of the muscle at the bottom of the neck, and ascends obliquely outward, to infix itself by small tendons at the anterior tubercles of the transverse processes of the third and fourth cervical vertebræ. The muscle may, in short, be described as passing from the bodies of the three upper dorsal and four lower to those of the three remaining cervical vertebræ, receiving above an oblique reinforcement from the middle transverse processes of the neck, to which it has likewise below detached slips of insertion.

M. rectus capitis anticus major (*Grand-trachelo-basilaire*: Dumas) lies closely on the vertebræ in the upper part of the neck, to the outside of the preceding muscle. It is an elongated, but thickish, muscle, arising by tendinous slips from the anterior tubercles of the transverse processes of the third, fourth, and fifth cervical vertebræ. These become fleshy, unite as they ascend, and are inserted into the under surface of the basilar process of the occipital bone, beside the median line, and just behind the spine, which attaches the raphe of the pharynx. Its inner edge overlaps the longus colli. These muscles correspond anteriorly to the great vessels of the neck, to the nerves which accompany them, and to the cervical portions of the respiratory and digestive tubes, but are separated by their own dense fascia from immediate relation to these parts. Their deep surface is in intimate connection with all the vertebræ and intervertebral discs, to which they correspond. Their action is inconsiderable; the rectus will slightly rotate and bend the head to its own side, or in conjunction with its fellow directly flex it. The longus colli, cooperating with its fellow, bends the cervical spine; or, acting singly, can slightly rotate by its higher fibres toward, by its lower fibres away from, the side on which the contraction occurs.

2. *Lateral vertebral muscles*.—*The inter-transversales colli* are almost described by their name. They form, on each side, a double series of small square muscles, occupying the spaces between the adjoining transverse processes, which afford them attachment by both borders of their surface. Arising from the lips, which the channelled upper surface of each transverse process presents, they ascend in each space to the borders of the process immediately above, and are there inserted. Between the inter-transversales antici and postici the spinal nerves of the region emerge, and the vertebral artery ascends.

Strictly analogous to these are the two small muscles which pass to the occiput from the transverse process of the atlas, the *rectus capitis lateralis* and *rectus capitis anticus minor*. The former would represent a posterior, the latter an anterior inter-transversalis. The former

passes from the upper edge of the transverse process of the atlas to the transverse or jugular process of the occiput: the latter, on a plane anterior to this, from the anterior root of the transverse process and side of the anterior arch, inclines upward and a little inward, to be inserted into the basilar process of the occipital bone behind the rectus capitis anticus major, between its outer edge and the foramen magnum. The rectus capitis lateralis separates the vertebral artery from the jugular vein.

These muscles in approximating their points of attachment can give lateral flexion to the neck and to the head.

The *sculeni* (*Costo-trachelien*: Chauss.) are situated at the lower lateral part of the neck, extending from the transverse processes to the first two ribs, and are of triangular form. They have been variously described by different anatomists, some considering their fleshy mass as a single muscle, others distinguishing in it two, three, and even five parts. I shall adopt the more usual modern division, which recognises two muscles, *scalenus anticus* and *scalenus posticus*.

Scalenus anticus arises from the third, fourth, and fifth cervical vertebrae, at the anterior tubercles and notched extremities of their transverse processes, by slips of tendon, to which muscular fibres directly succeed, and descends with an inclination outward and forward to be inserted by a flat strong tendon into a roughness about the middle of the anterior third of the first rib. This insertion is important as affording a guide to the position of the subclavian artery, which, in arching over the rib, lies behind this tendon and separates it from the insertion of the *scalenus posticus*. It is triangular in shape and fleshy in nearly its whole extent: *externally* it presents a free border, from behind which emerge the elements of the brachial plexus and the subclavian artery; *internally* its origin adjoins that of the rectus capitis anticus major, from which it is demarked by the arteria cervicalis ascendens, and toward its insertion is separated from the longus colli by a space in which the vertebral artery ascends; its *anterior* surface is crossed from above by the phrenic nerve, and transversely by branches of the thyroid axis; its *deep* surface is separated from the *scalenus posticus* by the emerging trunks of the nerves, and the space between them, broadening towards the first rib, includes there the brachial plexus and subclavian artery—the latter being below and in front of the former, and in immediate contact with the rib.

Scalenus posticus, larger than the preceding, behind which it is situated, arises by six tendons, to which muscular fibres directly succeed, from the posterior tubercles of the transverse processes of the six last cervical vertebrae. The first slip (often partly derived from the atlas) is joined, as it descends, by the others in succession, and a large triangular muscle results, which has its base at the transverse processes and its apex at the second rib. It is inserted, first, by an anterior broad slip into the outer edge of the first rib, from the tubercle behind as far forward as the arterial impression in

front; secondly, by a smaller slip, which is prolonged from the posterior surface of the muscle to the upper edge of the second rib near its tuberosity. This muscle corresponds *anteriorly* to the *scalenus anticus*, from which it is separated by the brachial plexus and subclavian artery; *posteriorly* to the levator anguli scapulae; by its *inner* edge to its points of origin; by its *outer* edge to the serratus magnus and transversalis colli artery, to branches of the cervical and brachial plexus of nerves, and to the sterno-mastoid muscle; lastly, by its *inferior-internal* edge to the longus colli, from which it is divided by the anterior branch of the first dorsal nerve, and by the (generally) common trunk of the deep cervical and first intercostal arteries.

The action of the *scaleni*, as of the muscles previously described, consists rather in maintaining steadiness and resisting lateralisation of the neck, than in effecting any considerable movement. They may, however, in a slight degree, bend the neck laterally. The vertebrae being fixed, their muscles by acting together may elevate the first two ribs and so assist in inspiration. The *scalenus anticus* can, from its advanced insertion, act more effectually thus. This action is illustrated in all deeper inspirations; for these differ from ordinary breathing therein, that the chest is expanded by the elevation of the ribs and sternum, in its antero-posterior and transverse diameters, in addition to the ordinary increase of capacity which it gains by the descent of the diaphragm; and, in order to the effective action of the intercostals, the first rib must be rendered immovable. The *scaleni*, in raising the anterior extremity of the first ribs, favour the advance of the sternum, and then rigidly fixing these bones enable the intercostal muscles to give to the ribs beneath that slight axial rotation by which the transverse diameter of the chest is increased.*

The intrinsic muscles of the larynx having already been described (see LARYNX), and those of the pharynx being for future description (see PHARYNX), our *second class* will comprise only the muscles of the os hyoides and tongue, viz. depressors of the os hyoides, the *sterno-hyoid*, *omo-hyoid*, and *sterno-thyroid*, with its continuation the *thyro-hyoid*; its elevators, the *digastric*, *stylo-hyoid*, *mylo-hyoid*, *genio-hyoid*; muscles of the tongue, *hyo-glossus*, *genio-hyo-glossus*, and *lingualis*.

The *sterno-hyoid* and *sterno-thyroid* are two riband-like muscles, having respectively the attachments denoted by their names,—situated beside the median line, so as to be divided

* Within the last year I have observed in two subjects an importantly anomalous insertion of the *scalenus anticus*. Its main bulk of tendon passed on both sides to an insertion *behind* the artery, a very small slip only taking the usual course. The strong flat tendon, which is usually so trustworthy a guide to the artery, would in these cases have involved an operator in the misfortune of surrounding the nerve with his ligature; and the circumstance illustrates the necessity of trying the effect of temporary pressure on a supposed arterial trunk, before conclusively tightening the ligature around it.

from their fellows on the opposite side only by the mesial raphe of the cervical fascia,—covering the trachea, thyroid body, with a portion of the larynx, and overlapping the sheath of the carotid vessels. They are isolated from each other, and from the other muscles of their neighbourhood, by processes of the cervical aponeurosis. The *sterno-hyoid* arises just within the thorax from the deep surface of the manubrium sterni, from the cartilage of the first rib, and from the ligament of the sterno-clavicular joint, and is separated from that of the opposite side by nearly the whole breadth of the sternum. As it ascends, it more nearly approaches its fellow, and the two are inserted side by side into the under surface of the body of the *os hyoides*, in close connexion, by their outer edges, with the *omo-hyoid* muscles, which are inserted beside them. The *sterno-hyoid* lies in its whole length on the *sterno-thyroid* muscle and its prolongation the *thyro-hyoid*, and these separate it from immediate contact with the important organs to which it is related.

The *sterno-thyroid* is broader and rises lower within the chest,—from the cartilage of the second rib, and from the adjoining surface of the sternum, on which it extends almost to the median line: its fibres ascend nearly vertically, and terminate at an oblique fibrous arch on the ala of the thyroid cartilage, and at the tubercles, to which this arch is attached; hence a muscle of similar volume is prolonged, (which may be described as rising from the oblique cord and from its points of attachment, but which, in direction, size, and form, accurately continues the *sterno-thyroid*), and, after a course of an inch and a half, is inserted into the body and part of the cornu of the *os hyoides*, beneath the *omo-hyoid* and *sterno-hyoid*, and superficially to the *thyro-hyoid* membrane. To this is given the name of *thyro-hyoid*.

The *sterno-thyroid* and *thyro-hyoid* are covered throughout by the *sterno-hyoid* and in part by the *sterno-mastoid* and *omo-hyoid* muscles. The *sterno-thyroid* corresponds by its inner edge to the inferior thyroid vein,—by its outer edge receives the terminal branch of the *descendens noni*, by its deep surface covers the thyroid body and many of its vessels, the trachea and part of the larynx, and the sheath of the carotid vessels: by its origin it enters into the mediastinum, covers the great arterial trunks springing from the arch of the aorta and the *brachio-cephalic* veins. From these parts it is separated by the remains of the thymus gland. The *thyro-hyoid* muscle covers the superior laryngeal nerve and artery as they pierce the wall of the larynx. These muscles are fleshy in their whole extent, with exception of the short tendinous fibres, by which they have their origin and insertion: the *sterno-thyroid* has frequently a transverse tendinous intersection in some part of its course.

The *omo-hyoid* is a slender but long bi-ventral muscle, obliquely extending from the superior costa of the scapula to the *os hyoides*. It arises by short tendinous fibres at the root of the coracoid process, from the ligament which crosses the coracoid notch, and from the ad-

joining part of the costa, directs itself with a slight ascent towards the median line, and, in emerging from behind the clavicle, frequently derives a few fibres from its posterior edge. It contracts to a flattened tendon as it passes beneath the *sterno-mastoid*, and abruptly changes its direction from a nearly horizontal to a vertical course, by undergoing a trochlear reflexion in a loop of the cervical fascia,—and, again becoming fleshy, ascends beside and parallel to the outer edge of the *sterno-hyoid*, to which it is closely united,—to be inserted into the lower border of the hyoid bone at the junction of its body and cornu. The very important relations of this muscle will be more fully given in the detailed surgical anatomy of the region. It may for the present suffice to say, that, in crossing the direction of the *sterno-mastoid* muscle, it furnishes the subdividing line of the great triangles of the neck; that its posterior belly lies parallel to and just above the subclavian artery and brachial plexus, is covered by the *platysma* and partly by the *trapezius*, *clavicle* and *subclavius*, and crosses the *scaleni* and *phrenic* nerve: that its looped tendon is covered by the *sterno-mastoid*, and lies on the sheath of the carotid vessels, across which its anterior belly continues obliquely to run.

The two *omo-hyoid* muscles acting in concert are capable of depressing the *os hyoides*; but their chief action is of a different nature. Being contained in their whole bent course within a sheath of cervical fascia, they affect this membrane by their contraction, tensely spanning it across the median line in a space which extends from the hyoid bone to its clavicular attachment. This appears to be one of the consensual movements in the act of deglutition, designed to give, during that act, additional efficacy to the protection against atmospheric pressure, which Burns has shown to be an important function of the fascia of the neck.*

The *digastric* muscle is likewise, as its name imports, double-bellied; it passes from the mastoid process of the temporal bone to the symphysis of the jaw, but is looped down in its course to the side of the *os hyoides*. Its temporal attachment is to the groove, which is named from it, on the inner surface of the mastoid process: a large fleshy belly proceeds from this origin downward and forward, contracts to a round tendon, which usually pierces the *stylo-hyoid* muscle, traverses an aponeurotic ring lined by synovial membrane, which strongly binds it to the hyoid bone, near its lesser cornu, and is then reflected upward, expanding again to a strong muscular belly, which fixes itself by short aponeurotic fibres into the lower border of the jaw, at an oval depression beside the symphysis. Its tendon, just after passing through the fibrous pulley that maintains its curve, gives off a fascial process toward the median line: this attaches itself strongly along the upper edge of the hyoid bone, and

* *Surg. Anat. of Head and Neck*, p. 36. Glasgow, 1824.

internally joins a similar process from the opposite side to form with it a tendinous expansion, (often assisted by a few fleshy fibres from the anterior belly of the digastric,) which reaches from the os hyoides as far as the jaw, and contributes to support the floor of the mouth.

The relations of this muscle are complicated and important: the convexity of its curve is the upper limit of the anterior triangle of the neck; its concavity bounds a space, the area of which extends within the jaw to the myloid ridge, containing various parts, and named from the muscle the *digastric space*; its posterior belly crosses the external and internal carotid, the facial, lingual, and occipital branches of the former, the internal jugular vein, the three divisions of the eighth, the ninth, and the sympathetic nerve, the side of the pharynx, the trachelo-mastoid and styloid muscles, and the *hyo-glossus*. The *sterno-mastoid* and *splenius* cover its origin; the *portio dura* emerges at its anterior edge, along which the posterior aural artery runs, and round which the posterior part of the parotid gland is folded. Its anterior belly and tendon support the submaxillary gland, are covered by fascia and platysma, and correspond to the *mylo-hyoid* muscle, which is covered and strengthened by the aponeurotic expansion derived from the digastric.

The action of this muscle varies according to the fixity of the jaw: when the mouth is firmly closed, the contraction of the two bellies will draw the hyoid bone vertically upward, and communicate to the pharynx the movement of elevation, which adapts it for receiving the masticated food. A firm closure of the jaw, a contraction of the digastric muscles, and consequent shortening of the pharynx, (indicated by rising of the pomum Adami,) are well known acts in the process of deglutition. When the hyoid bone is fixed by its depressors (and perhaps in some degree retracted by the joint actions of the posterior belly of the digastric and of the *omo-hyoid*), the anterior belly, both passively as a reflected cord, and actively, in virtue of its muscular fibres, depresses the lower jaw and opens the mouth. Simultaneously, too, with its act of raising the pharynx, this muscle must tighten, by its posterior belly, the mesial aponeurotic expansion, which joins it to its fellow; and, by so doing, must assist the *mylo-hyoid* in raising the floor and reducing the capacity of the mouth. It fulfils, therefore, important uses in the mechanism of deglutition.

The *stylo-hyoid* muscle is an accessory to the posterior belly of the digastric, and arises from the outer surface of the styloid process, about midway from its base, by a small round tendon, which soon swells into an elongated body. This lies along the posterior belly of the digastric, parallel to its anterior edge, and, when it reaches the os hyoides, is inserted into the outer surface of that bone, at the union of its body and cornu, by short aponeurotic fibres. It usually divides, just previously to its insertion, to give passage to the tendon of the digastric. The *portio dura* of the seventh pair emerges between its origin and that of the digastric: in

other respects its relations so entirely agree with those of the descending belly of that muscle, as do likewise its uses, that no particular description of these is necessary.

The *mylo-hyoid* muscles are so mutually dependent that they might almost be described as a single muscle. They arise on either side from the oblique or myloid ridge on the buccal surface of the lower jaw in its whole extent, i. e. from opposite the last molar tooth to the neighbourhood of the symphysis. The fleshy fibres, that succeed the short aponeurosis of origin, proceed parallelly toward the median line, and are inserted into a raphe, which reaches from the symphysis of the jaw to the body of the hyoid bone, and likewise into the upper border of the body of that bone. The anterior fibres are short; those which succeed progressively increase in length, and the posterior, which are fixed to the hyoid bone, are of all the longest. Each muscle is, therefore, triangular, having an outer edge by which it rises from the jaw, an inner edge of union with its fellow, and a posterior edge, which is seen to extend, in the digastric space, from the posterior extremity of the myloid ridge to the upper edge of the body of the hyoid bone, close to its cornu. The under surface of the muscle corresponds to the submaxillary gland and to the insertion of the digastric; its upper surface sustains the tongue and floor of the mouth,—from the mucous membrane of which it is separated by Wharton's duct, the sub-lingual gland, and gustatory nerve; it also corresponds to the *hyo-glossus*, *genio-hyoideus*, and *genio-hyo-glossus*, and to the termination of the lingual artery and nerve. The duct of the sub-maxillary gland winds round its posterior edge, in proceeding to open beside the *frænum lingue*. The habitual state of this muscle is one in which it is rendered, with its fellow, convex downward by pressure of the superincumbent parts; and so its surfaces cannot strictly be said to face upward and downward, but with a modification of these directions respectively inward and outward. Thus the two muscles furnish a concave floor to the mouth, and it is only in their contraction, which accordingly diminishes the cavity, that this becomes strictly horizontal. Their action, especially when assisted by other muscles, is to propel the masticated food by lessening the capacity of the mouth.

The *hyo-glossus* is a thin quadrilateral plane of parallel muscular fibres, having the attachments which its name indicates. It rises from the entire length of the great cornu and adjoining part of the body of the os hyoides, on their upper surface, and ascends to be inserted into the side of the tongue. From beneath its anterior thicker edge the lingual artery emerges; its posterior thin border receives the insertion of the *stylo-glossus*; its deep surface corresponds to the *genio-hyo-glossus* and *lingualis*, from the former of which it is partly separated by the lingual artery; its external face is separated from the *mylo-hyoid* muscle by the lingual and gustatory nerves and duct of the sub-maxillary gland.

The *stylo-glossus* arises, as a round fleshy bundle, from the tip of the styloid process, and from the adjoining part of the stylo-maxillary ligament, becomes flattened into divergent parts, as it approaches the side of the tongue at the posterior border of the hyo-glossus, after a short course downward, forward, and inward, and is there inserted. A part is continued for some distance along the hyo-glossus, crossing the direction of its fibres, and interwoven with them; other fibres seem to bend into the substance of the tongue, near its base and at right angles to its axis. Its surface corresponds to the parotid gland, external carotid artery, internal pterygoid muscle, and mucous membrane of the mouth; deeply, it lies on the internal carotid artery, the superior constrictor of the pharynx, the tonsil and hyo-glossus.

The *genio-hyo-glossus* is a large, fan-shaped muscle, radiating from within the symphysis of the jaw to the entire length of the tongue, and constituting, with its fellow, the chief muscular bulk of that fleshy organ. It rises by a strong square mass of short tendinous fibres from the upper genial tubercle, and the fleshy fibres, which succeed, immediately and widely diverge; the highest bend upward and somewhat forward to the tip of the tongue; those, which next follow, occupy its entire remaining length, spreading with more or less obliquity into the substance of the organ, through which on a section they may be followed even to the dorsum: some of these may be traced beyond the posterior edge of the hyo-glossus, expanding on the side of the pharynx just above the hyoid attachment of the middle constrictor, and constituting the so-called lingual origin of the superior constrictor, (see PHARYNX); the remaining fibres complete the semicircular spread of the muscle, by passing downward and backward, to be inserted into the upper border of the body of the os hyoides. This muscle is opposed by its entire mesial surface to its fellow: their tubercles of origin are almost blended on the symphysis, and their fleshy fibres are only to be distinguished by a thin intermediate layer of adipose tissue: their upper edges raise the mucous membrane of the mouth on either side of the frænum; their lower edges extend to the hyoid bone in perfect parallelism to each other, and to the genio-hyoidei, which cover them; their outer surfaces, partly covered by the hyo-glossi, form with these on each side the inner wall of a triangular space (roofed by the mucous membrane and floored by the mylo-hyoid muscle) in which lie the terminal branches of the lingual and gustatory nerves, the lingual artery, the sublingual gland, and the excretory duct of the submaxillary.

Close to the implantation of this muscle in the tongue, between its fibres and those of the hyo-glossus, and crossing the direction of both, is a small bundle of fleshy fibres, which runs longitudinally from base to apex, and, since it has no fixed attachment, may most fitly be considered among the intrinsic muscles of the organ; it has been named *lingualis*. (See TONGUE.)

The *genio-hyoideus* is a strong cylindrical muscle intimately associated with the genio-hyo-glossus, and ordinarily co-operating with its posterior fibres. It rises by a square tendon from the inferior genial tubercle, beside its fellow of the opposite side and just below the genio-hyo-glossus. From this origin it directs itself backward and downward, and is inserted into the upper surface of the body of the os hyoides. Its insertion is somewhat broader than its origin: its inner surface corresponds to that of the opposite side; its upper surface is parallel to the genio-hyo-glossus, which it supports; its under surface rests on the mylo-hyoid, beside its raphe; its outer surface has similar relations to that of the genio-hyo-glossus, contributing with it to form the inner wall of the sub-lingual space just described.

The action of the extrinsic muscles of the tongue is modified and more nicely adapted to the delicate offices of speech by the co-operation of other and intrinsic muscles. These will be described in a future article (see TONGUE). Those already considered operate on the tongue *en masse*;—elevate, advance, depress or retract it, shift its volume to either side, and direct its extremity, by a kind of circumduction, over a wide range of surface. Thus, the stylo-glossus can elevate and retract, the hyo-glossus depress and lateralise; the anterior fibres of the genio-hyo-glossi, with the linguales, regulate the motions of the tip, while the genio-hyoid and adjunct fibres of the genio-hyo-glossi can cooperate in these movements by shifting the base of support in any direction. As the genio-hyo-glossus is of largest bulk, so is it of most various office in the tongue; by its posterior fibres it gives an elevation to the os hyoides by which the tongue is protruded from the mouth; or, half antagonizing this action by its middle fibres, it may so forcibly hollow the dorsum of the tongue as to direct its apex within the incisor teeth, and, with aid of the stylo-glossi, enable it to sweep the concavity of the palate; or, by this co-operating with either hyo-glossus and with the opposite linguales and stylo-glossus, the tongue may be made, as it were, to probe with its eminently tactile extremity the entire length of the alveolar arches, or by a yet more definite contraction to exert suction on any spot with which its dorsum can have contact.

The *third class* includes the sterno-cleido-mastoideus and the platysma myoides.

The *sterno-cleido-mastoideus* is a long and powerful muscle, obliquely crossing the side of the neck, from the neighbourhood of the sterno-clavicular joint to the mastoid process of the temporal bone. It is fleshy in almost its whole extent; flattened at the extremities, but rather prismatic in the intermediate portion; and the anterior edge, which is more particularly continuous with the sternal origin of the muscle, and which, in certain positions of the neck, raises the integuments in a well-known diagonal relief, considerably exceeds the thickness of the posterior border. The name of the muscle is a summary of its attachments. It arises by two heads, which are usually

separated by a distinct cellular interspace, corresponding to the sterno-clavicular articulation: 1. from the anterior surface of the first bone of the sternum close to its clavicular joint, by a very strong flat tendon which is directed upward and backward for the space of more than an inch, before terminating in fleshy fibres; 2. from the upper edge of the inner third of the clavicle by a thin origin composed of parallel aponeurotic fibres, which directly become fleshy, and take a nearly vertical course. As these two bundles ascend, the sternal, more oblique in its course, seems to overlap the other, and, both by difference of direction and by a line of cellular separation, can often be distinguished from it in the lower two-thirds of the neck; but in approaching the mastoid process they are indistinguishably fused together. The insertion is, 1. by a strong and rounded tendon into the mastoid process, of which it seems to embrace the tip and anterior border; 2. by a thin aponeurosis along the posterior edge of the process, and about a third of the superior semicircular line, which is continued into it.

This muscle, to which I shall have abundant occasion to refer in speaking of the surgical anatomy of the neck, has very important relations: the space between its heads corresponds to the bifurcation of the arteria innominata; and the broad band-like muscle, as it ascends, crosses in succession the subclavian and carotid arteries, the jugular and subclavian veins, the hypo-glossal, pneumogastric, phrenic, sympathetic, spinal accessory nerves, and a portion of the cervical plexus; the sterno-hyoid, sterno-thyroid, omo-hyoid, scaleni, levator anguli scapulae, splenius, and digastric muscles, besides many lymphatic glands and branches from several of the nervous and vascular trunks which have been enumerated. Its superficial aspect corresponds to the integuments and platysma, to the external jugular vein and superficial branches of the cervical plexus; its thick anterior edge bounds the anterior triangle of the neck, receives branches from the external carotid artery or from its thyroid branch, and corresponds above to the parotid gland and posterior aurial artery; its thin posterior edge limits the other great triangle of the neck, is pierced by the spinal accessory nerve, corresponds to a chain of lymphatic glands, and is wound round by the nerves and vein which lie on the surface of the muscle.

The two sterno-mastoid muscles acting together directly bend the head on the chest, and their joint action is well illustrated in an endeavour to raise the head from the supine position. But when the head is thrown far back, a predominance is given to the posterior fibres of the muscle, which being attached behind the line of the occipito-vertebral articulation, become then capable of increasing this direction of the head. The sterno-mastoid of one side, acting singly, rotates the head and flexes it with a lateral inclination to its own side, so as to bring the side of the head nearer to the shoulder, and to turn the face in the opposite direction.

The *platysma myoides* (*latissimus colli* of Albinus) is a broad, thin, membraniform muscle, which covers the side of the neck and lower part of the face, and is in its whole course subcutaneous. It arises by scattered fibres in the superficial fascia below the clavicle, and covers by its origin the upper part of the pectoralis major and deltoid, as also the space between those muscles, which corresponds to the coracoid process. This origin does not extend within an inch or two of the median line, but reaches as far outwardly as the acromial process. The fibres become more closely aggregated as they ascend, and the muscle accordingly narrows. Its direction is obliquely upward and to the median line; it passes over the base of the lower jaw, and its fibres again spread to their insertion: those which are posterior lose themselves in the skin covering the parotid gland and masseter muscle; others from this neighbourhood bend forward toward the angle of the mouth, and in some subjects constitute a very distinct horizontal *retractor anguli oris*, which is generally known as the *risorius Santorini*: some fibres from the middle of the muscle obtain a more fixed insertion about the base of the jaw and into the skin covering it; while the anterior portion of the muscle, which is most constant in its relations, is inserted into the lower lip by blending its fibres with those of the depressor labii inferioris, and by decussating toward the border of the lip and in the substance of the chin with the mesial fibres of its fellow.

This muscle is subcutaneous in its whole extent, and by its extremities intimately attached to the deep surface of the skin which covers it. In approximating its extreme attachments, it wrinkles the skin in a direction transverse to that of its fleshy fibres. It is a single and partial relique in the human subject of that general muscular investment, which fulfils various functions in different orders of Mammalia, as an appendage of the tegumentary system: rolling the hedge-hog in a ball, erecting the quills of the porcupine, and the bristles of the boar, or dislodging insects from the hide of grazing cattle. Its relations to the deeper parts in the neck will be detailed hereafter: between it and the cervical aponeurosis lie chiefly, cutaneous nerves and veins; branches from the cervical division of the portio dura are distributed to its upper portion, reaching the deep surface just below the angle of the jaw, and branches from the cervical plexus crossing the sterno-mastoid partly supply the platysma, partly pierce it in their course to the skin; the superficial pectoral branches lie beneath it till they reach the clavicle; the external jugular vein lies immediately beneath this muscle, and runs nearly parallel to its fibres, crossing transversely those of the sterno-mastoideus.

II.—FASCIAE OF THE NECK.

1. The *superficial fascia*, or *subcutaneous areolar tissue*, presents characters in common with the same structure in other parts of the body, and is universally continuous with that

general investment; being prolonged without interruption, below, into the superficial fascia of the chest,—above, into that of the head and face. It consists here, as elsewhere, of two layers, which have the local peculiarity of being separated by the platysma myoides in the greater part of their extent. Its deeper layer occurs in the form of delicate, scarce, lax, fatless areolar tissue, interposed between the

proper aponeurosis of the region and the platysma myoides, furnishing means for the loose gliding of this muscle, and continued, without adhesion or sensible change, into the adjoining regions. Its *subcutaneous layer* is of coarser materials and of less uniform thickness, is in close union with the skin, and follows its movements: it contains the variable amount of fat, which the region presents; and so, though it

Fig. 327.

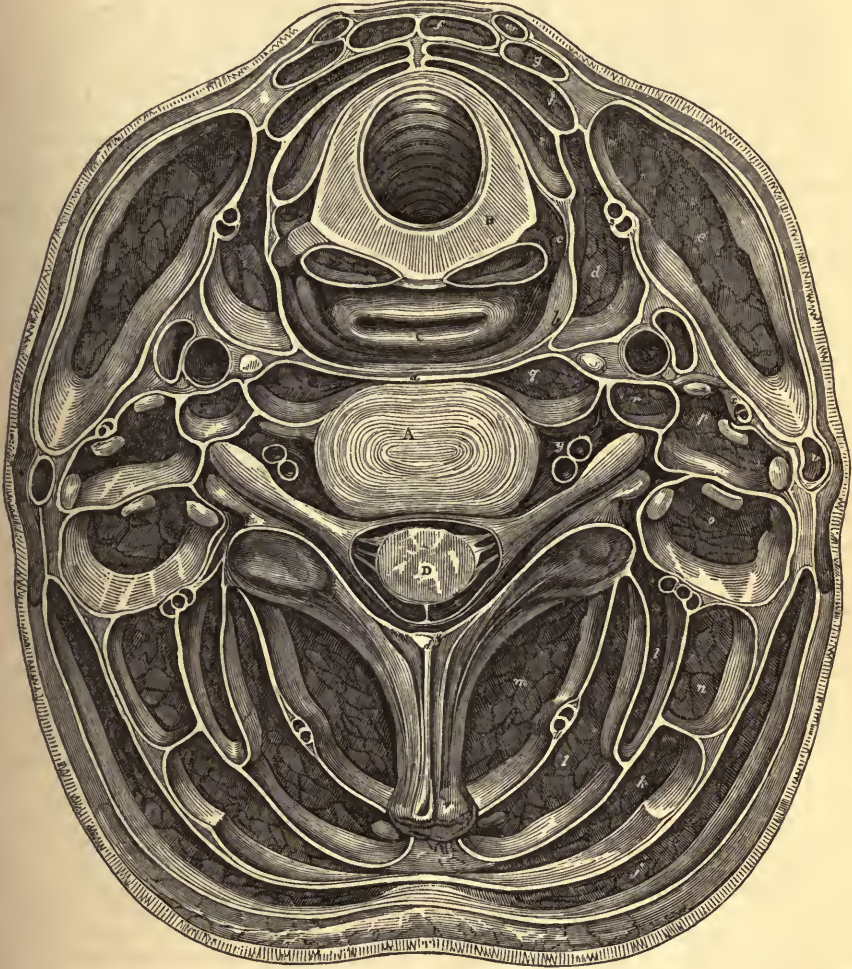

Transverse horizontal section of the neck, seen from above.

- | | |
|--|-------------------------------------|
| A, fourth cervical vertebra. | j, trapezius. |
| B, cricoid cartilage. | k, splenius. |
| C, pharynx. | l, complexus. |
| D, Medulla spinalis. | m, semi-spinalis and multifidus. |
| a, prevertebral aponeurosis. | n, levator anguli scapulae. |
| b, posterior pharyngeal aponeurosis. | o, scalenus posticus. |
| c, middle constrictor. | p, scalenus anticus. |
| d, thyroid body. | q, longus colli. |
| e, sterno-mastoid muscle, in the space behind which is seen a section of the great vessels, and of their sheath. | r, rectus capitis anticus major. |
| f, sterno-hyoideus. | s, superior thyroid vessels. |
| g, omo-hyoideus. | t, ascending cervical vessels. |
| h, sterno-thyroideus. | u, deep cervical vessels. |
| i, crico-hyoideus. | v, external jugular vein. |
| | w, anterior jugular vein. |
| | x, platysma and superficial fascia. |

constitutes, in lean subjects, a manifest and resisting lamina, yet, in those of an opposite character, it is rendered indistinct by the predominant adipose tissue which occupies its areolæ. Along the side of the neck, from the clavicle to the jaw, these layers are kept asunder by the platysma myoides, which adds, as it were, a third lamina to the subcutaneous expansion; but both in front and behind, where the muscle ceases, they are in close relation, and constitute a single covering to those regions of the neck. The deep layer of this fascia is traversed by the cutaneous nerves and vessels, including the external jugular vein.

2. The *cervical fascia* is a proper aponeurotic investment of this region, and corresponds in its general characters to the fibrous sheathings of the limbs. Like these, it not only forms a general, compressive, and modelling cincture for the part, but, by various secondary splittings, furnishes dissepiments which isolate the different organs, and allot to each its proper sheath or fascial chamber. It may be briefly, but insufficiently, described as originating from a kind of *linea alba*, or mesial commissure in front, and in its backward course to the spinous processes furnishing a separate investment to every organ which it encounters, and attaching itself, both below and above, to the chief bony eminences which present themselves. (A section of it, as it thus *cellulates* the neck, is represented, with Bourguery's almost invariable accuracy, in a lithograph, (vol. vi. pl. 10,) from which the accompanying woodcut is copied.) It requires, in at least many regions of the neck, a more particular description than this summary contains; and I shall accordingly proceed to consider such portions of it with some detail. The *sterno-cleido-mastoideus* is ensheathed through its whole extent; the fascia, on reaching its anterior edge, is bi-laminated, encloses the muscle, and becomes again single at its posterior border. When this sheath is laid open by removing its anterior wall, and the muscle carefully everted from its prismatic cell, it will be seen that the posterior lamina is of greater strength than the removed anterior one; and this surface is the one from which the dissector may most conveniently trace the further spread of the membrane. He will find that the cervical fascia (of which the portion covering the *sterno-cleido-mastoideus* is but a secondary slip) extends itself from behind that muscle in all directions; inwardly to the mesial line,—outwardly to the trapezius,—upwardly to the jaw,—downwardly to the clavicle. *a.* Traced *inwardly*, its arrangement differs in the upper and lower parts of the neck: 1. in that below the *os hyoides* a superficial lamina covers the subhyoid muscles, joins its fellow in the median line, and is fixed below to the interclavicular notch of the sternum; a second, thin process divides the *sterno-thyroid* from the *sterno-hyoid* muscle; a third, stronger one, passing between the *sterno-thyroid* and air-tube, covers this latter organ and the thyroid body, is attached below to the inner surface of the manubrium sterni, internally joins the layer from the opposite side, and helps with

it to form a raphe, reaching from the *os hyoides* to the sternal notch. Previously to the divisions here mentioned, the fascia encloses the flat tendon and anterior belly of the *omo-hyoid* muscle; and in a line, which will presently be more particularly indicated, covers the carotid artery, jugular vein, and *nervus vagus*. Just external to these parts, along the outer edge of the jugular vein, it detaches a delicate process, which passes behind the vessels, separating them from the sympathetic nerve, and is continued inwardly to join its fellow from the opposite side, as a cellular clothing to the *œsophagus*. 2. Above the *os hyoides*, the arrangement of the fascia is simpler; covering the *nylo-hyoid* and *submaxillary* gland, and inclosing the anterior belly of the *digastric*, it is fixed to the lower border of the *symphysis*, and hence to a mesial raphe as far as the *os hyoides*. It has some deep connexions, to which I shall return directly; and, to the sheath of the great cervical vessels it preserves the same relations as below, its deepest process losing itself on the pharynx. *b.* Traced *upwardly*, the fascia is seen to split on the inferior edge of the *digastric* muscle; the superficial lamina is attached, behind, to the *mastoid* process,—in front, joining the part last described, to the lower edge of the jaw,—and, intermediately, ascends upon the *parotid* gland, which it invests; the deeper layer is fixed to the *styloid* process of the temporal bone, and gives origin to a remarkable septal slip, (sometimes called the *stylo-maxillary* ligament,) which, just in front of the posterior belly of the *digastric*, passes outwardly, is inserted into the deep surface of the superficial lamina and into the angle of the jaw, so serving to separate the space, circumscribed by the *digastric* muscle, into two parts, and isolating the *parotid* gland, which occupies the posterior of these, from the *submaxillary*, which is situated in the anterior one. Further, this deep layer (joined by a slip from the fascia, which covers the *submaxillary* gland and is attached to the jaw) prolongs itself around *Wharton's duct*, between the *mylo-hyoid* and *hyoglossal* muscles, and likewise furnishes origin to the investing cellular tissue of the pharynx. *c.* Below, the cervical fascia attaches itself around the insertions of the muscles, which it incloses, viz. towards the median line to the notch of the sternum, and—with the *sub-hyoid* muscles—to the deep surface of the *manubrium* and to the cartilage of the first rib, and then to the clavicle in its entire length, both around and between the *sterno-cleido-mastoid* and *trapezius*. In descending to the clavicle, it ensheathes the posterior belly of the *omo-hyoid*; and a firm process of it, folded around this muscle and directed backward to the *levator anguli scapulae*, is infixed along the superior costa of that bone, and circumscribes the so-called *omo-hyoid* space. *d.* Traced *outwardly and backwardly* the fascia covers in the interval between the *trapezius* and *sterno-mastoid* (posterior triangle) from the clavicle to the occiput, and, on arriving at the anterior edge of the *trapezius*, splits to enclose it. The further distribution of it, in this direction, is in ac-

Fig. 328.

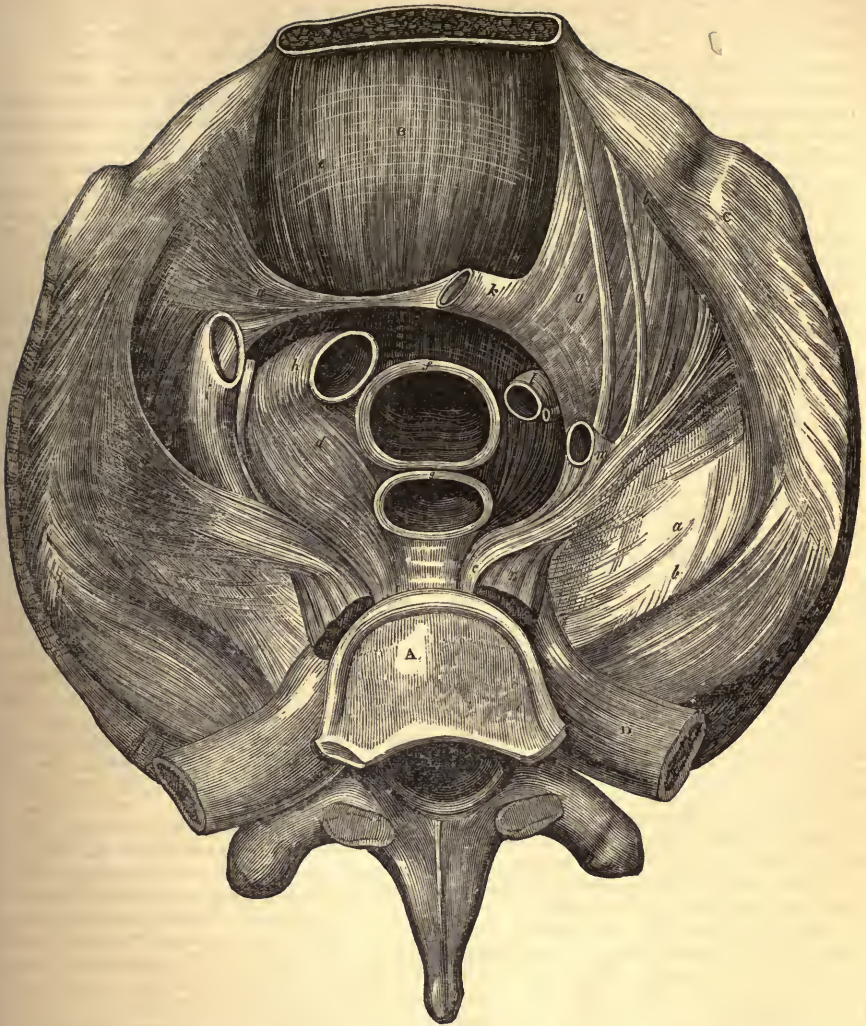

Shows from below the cervico-thoracic septum constituting the roof of the thorax, and giving passage to the great vessels. It represents a transverse and horizontal section through the second intervertebral disc, and parts at the same level.

A, second dorsal vertebra.
 B, transverse division of the manubrium sterni.
 C, first ribs.
 D, vertebral extremity of second ribs.
 a, a, fascia, extending between the great vessels and first two ribs.
 b, b, its insertion at the first ribs.
 c, c, its insertion at the second vertebræ.
 d, d, lamina between the great vessels, attached centrally to them,—in front to the sternum, where it forms a cul-de-sac,—and behind to the second dorsal vertebra.

e, the aponeurosis, extending within the sternum.
 f, the trachea.
 g, the œsophagus.
 h, the arteria innominata.
 i, the right vena innominata.
 k, the left vena innominata; transverse band uniting the two sides of the aponeurosis.
 l, the left carotid artery.
 m, the left subclavian artery.
 n, section of the musc. long. colli.

cordance with the general law of its arrangement for the separation of muscles; is destitute of any particular surgical interest, and forms no exception to the general observations given in a preceding article. (See BACK.)

A portion (but a very distinct portion) of this great aponeurosis is the *pre-vertebral* fascia. It extends from the occiput—to which it is

fixed in front of the *recti capitis antici*—to the inlet of the chest, where it adheres, beside the longus colli, to the neck of the first rib; it binds down the pre-vertebral muscles, is attached deeply to the tips of the transverse processes, and receives by its surface a septal slip from the cervical fascia just externally to the sheath of the vessels. An important process is

the prolongation which it sends downward on the scaleni; and which partly fixes itself to the rib around the attachments of those muscles, partly extends itself, as a strong infundibulum on the brachial plexus and subclavian vessels. From this—their fascial sheath—an horizontal slip detaches itself and passes forward to the posterior surface of the clavicle, where it fixes itself by two laminae; the upper of these is inserted just above the attachment of the subclavius muscle, while the lower is continued into the sheath which that muscle derives from the coraco-costal fascia. The horizontal process separates the cavity of the axilla from the lower triangle of the neck, and the vaginal prolongation, contracting as it descends, becomes lost in the sheath of the axillary vessels.

Finally, as these various layers of fascia attach themselves about the inlet of the thorax, (the sub-hyoid part of the cervical aponeurosis in front, and the pre-vertebral behind,) they are connected to one another and to the large vascular and mucous canals, which traverse that passage, by certain horizontal processes of fibrous membrane, which constitute together a kind of diaphragm, or *cervico-thoracic septum*. Viewed from below this would seem a vaulted membrane, overarching the tops of the pleurae, and giving infundibular passage to the great arterial and venous trunks and to the trachea; viewed from above it would present the various deep implantations of the cervical fascia, and a surface without aperture or breach of continuity, prolonging itself in several directions round the canals, which it thus indirectly transmits. The obvious use of these arrangements is to supply adequate resistance to the atmospheric pressure, which, were it not borne off by the tension of these fasciæ, would at each inspiratory effort tend to flatten the trachea, or to rush through the upper strait of the thorax. Allan Burns, who in this country first drew attention to the importance of the cervical fascia, carefully illustrates its functions in health, and the inconveniences which accompany its destruction. (Op. cit.)

III.—REGIONAL DISTRIBUTION AND SURGICAL ANATOMY OF THE NECK.

The posterior parts of the neck having been described in a previous article (see BACK), the present will be restricted to an account of its anterior aspect.

The cervical vertebrae (by their bodies, intervening fibro-cartilaginous discs, and transverse processes), together with the anterior and lateral vertebral muscles, already described, compose the skeleton and supporting fabric of this region; the anterior fibres of the trapezii, as they descend on either side to the inner edge of the acromio-clavicular arch, form its lateral boundaries; the larynx and trachea (covered by their own extrinsic riband-like muscles, and partly covering the pharynx and œsophagus) separate the nearly symmetrical halves of the neck by constituting along its median line a marked columnar relief, in the recesses beside which lie the great cervical vessels; the base of the skull and the oblique line of the jaw are

the upper limits of the region; the clavicle (just behind which the great vascular and nervous trunks of the upper extremity course) bounds it below; the skin, the platysma myoides (in its cellular covering), and the cervical aponeurosis are stretched across it as general investments; while the last-named fascia ensheathes the various parts by special processes from its deeper surface.

Thus, in general terms, the structure of the neck may be described; but, for the more precise and particular account, which the importance of its anatomy renders necessary, a division of it into spaces of small extent is convenient. The arrangement, which I propose following, differs but little from that usually adopted, and, perhaps, somewhat exceeds it in precision.

The upper limits of the neck having been stated as the oblique line of the jaw and the base of the skull (which parts, as we shall presently see, are brought into relation by the attachments of the constrictor pharyngis superior), our highest region has in that direction these parts for its boundary, and extends below as far as the curve of the muscle, from which it is named the *digastric* space.

A small space that can hardly be referred to the digastric,—from which it is separated by the vaginal process of the temporal bone, and by attachments of fascia,—and which, from the importance of its contents, deserves careful consideration, is the *posterior pharyngeal*; it lies closely beneath the base of the skull, (from the vaginal process to the median line) between the pharynx and spine, and includes the carotid, jugular, and condylic canals, and the organs traversing them.

If now an oblique line be carried across the neck, from the sterno-clavicular articulation to the tip of the mastoid process, it divides, as a diagonal, the remaining quadrilateral surface of the neck into two triangles; an anterior one having its apex at the sterno-clavicular joint, and its base along the posterior belly of the digastric muscle; a posterior one, having, its base at the inner two-thirds of the clavicle,—its apex at the mastoid process,—its posterior side formed by the trapezius,—its anterior border defined by the imaginary line which demarks it from the anterior triangle. The omo-hyoid muscle, in its reflected course, crosses both these triangles, subdividing them; and since the angle of its bend falls just on the line of their separation, and since it proceeds from behind the outer third of the clavicle to the body of the hyoid bone, it acts as a second diagonal in the neck, dividing each into an upper and a lower triangular space. These four triangles will be described in detail; and since the sterno-mastoid (which is too substantial to be treated as a mere boundary-line) enters into all of them, and has to parts of each relations of the extremest practical importance, some separate, chiefly recapitulatory, consideration will be given to its relative anatomy. Finally, to ensure for the organs of the median line the consideration they require (the usefulness of which mainly depends on their being

viewed connectedly), it may be well to take them in that relation.

Thus, (1) a *region of the median line*, (2) an *antero-inferior*, (3) an *antero-superior*, (4) a *postero-superior*, and (5) a *postero-inferior triangle*, (6) a *digastric*, and (7) a *posterior pharyngeal space*, are to be severally considered; and a few preliminary remarks may be given to the tegumentary parts, which are more or less common to all.

The *skin* is fine, thin, and extensible, especially below and in front; becoming coarser and more adherent toward the upper part of the posterior triangle; it frequently presents some transverse wrinkling above the hyoid bone, which seems to depend on the *platysma myoides*; here, too, the follicles are larger and more abundant than in the other parts of the neck, and, in the male subject, the surface is overgrown by the beard. The *subcutaneous cellular tissue* has already been described; in the upper part of the posterior triangle it becomes almost inseparably confounded with the cervical aponeurosis; the *platysma myoides* lies between its layers and keeps them apart over the greater surface of the neck; the fibres of this muscle are absent in the lower part of the anterior, and upper part of the posterior triangle, and at these spots the two layers of the superficial fascia fall together and are nearly confounded. In the deeper lamina of this texture, subjacent to the *platysma* in the parts where it lies, run the *superficial veins and nerves*. The *external jugular vein* commences in the parotid gland, usually by radicles, which correspond to the terminal branches of the external carotid artery, temporal, internal maxillary, and transverse facial; pierces the fascia near the angle of the jaw, and directs itself almost vertically toward the middle of the clavicle, in the deep layer of superficial fascia: just at the edge of the clavicular insertion of the sterno-mastoid muscle it bends inward, pierces the aponeurosis, and discharges itself into the subclavian vein. It thus very obliquely crosses the sterno-cleido-mastoideus from its anterior to its posterior edge, separated from that muscle by its fascial sheath; the auricular nerve runs upward parallel to its posterior border; the *platysma* covers it in its whole course with fibres which cross its direction; its place of discharge into the subclavian vein is usually just opposite the *scalenus anticus*, covered by fascia and by the sterno-mastoid muscle. It receives superficial occipital, superior and posterior scapular veins; branches from the posterior triangle of the neck, and from the trapezius; it has uncertain and irregular communication with the anterior jugular vein, and receives a certain, though not regular, branch from the internal jugular; this is usually given to it at the lower part of the parotid, or on its emergence from that gland, and occasionally seems to constitute its commencement. Obvious surgical inferences from the anatomy of this vein are: the relief that its communication with the internal jugular enables it to give, when opened in cases of cerebral congestion; the eligibility of its line of

passage over the thick belly of the sterno-mastoid for that mode of venesection; the necessity for dividing some fibres of the *platysma* transversely to their length (by an incision nearly in the direction of the sterno-mastoid) in order to obtain a clear opening and free jet of blood; the need for care in this operation, but still more in proportion as the vein is wounded lower in the neck, to hinder the possibility of air being inspired through its cavity.

The *anterior jugular vein* is an irregular subcutaneous supplement to the external: it commences in the submental region, near the hyoid bone; descends vertically beside the median line, receiving branches from the larynx, and sometimes from the thyroid body; on arriving at the sternum, or near that bone, it bends horizontally outward, piercing the fascia, and runs behind the origin of the sterno-mastoid, to throw itself into the subclavian vein, somewhat within the termination of the external jugular. It generally has free communications with its fellow and with the internal and external jugular. Its size is in inverse proportion to that of the external; and, in absence of this, it is generally a very considerable branch; it is sometimes single and mesial; but more usually two exist, which are commonly of unequal calibre.

The *superficial nerves* are of two classes, being partly derived from the cervical plexus, partly from the *portio dura*.

The cervical plexus sends its superficial branchings in three directions: the *mastoid and auricular* pass upward; the *anterior cervical* runs forward; the *supra-clavicular* and *supra-acromial*, as their names denote, descend more or less obliquely.

The *mastoid*, originating from the second cervical nerve, winds upwardly across the *splenius*, and almost parallel with the posterior edge of the sterno-mastoid, which it crosses in its ascent. It pierces the fascia soon after its origin, and becomes subcutaneous. Its distribution is entirely to the skin of the mastoid and occipital regions. The *auricular*, rising from the second and third cervical nerves by a trunk, common to it with the anterior cervical, directly pierces the fascia, loops round the posterior edge of the sterno-mastoid, and ascends across its surface (the fascial sheath intervening) toward the angle of the jaw; where, after supplying twigs to the integuments over the parotid gland, it divides into terminal branches, which are distributed to the external and internal surfaces of the auricle and to the adjoining integument, in a manner which need not be particularised in the present article. In crossing the sterno-mastoid it is parallel to the external jugular vein, and behind it. The *anterior cervical* rises in common with the last, and pierces the fascia in its company; bends at right angles across the sterno-mastoid muscle, and is itself crossed by the external jugular vein. On arriving at the edge of the muscle, it divides into many twigs, which, traversing the *platysma* at several spots, distribute themselves to the skin of the anterior triangle of the neck, and to that of the adjacent part of the digastric

space. This nerve, where crossed by the external jugular vein, gives one or two minute twigs, which follow its direction toward the angle of the jaw.

The *supra-clavicular* and *super-acromial* are the two superficial branches in which the plexus terminates: as they descend, they divide into a lash of twigs, which diverge in the posterior triangle of the neck, and at various heights pierce its fascia, become subjacent to the platysma, and contribute to supply it. Their ultimate branching takes a very wide range: the inner filaments obliquely cross the clavicular origin of the sterno-mastoid; the outer, the anterior fibres of the trapezius; the middle ones, the clavicle itself; and are distributed, in their respective regions, to the integuments of the scapula, shoulder, chest, and sternum.

The branch from the *portio dura*, which enters the neck, is the lower division of its cervico-facial part. From near the angle of the jaw, where it traverses the fascia, it passes toward the hyoid bone, and supplies the platysma from its deeper side. Some of these twigs, approaching the cutaneous surface of the muscle in the anterior triangle of the neck, communicate with filaments of the anterior cervical nerve.

1. *Mesial region of the neck.*—This presents different relations, as considered above or below the level of the *os hyoides*.

Above the os hyoides, and extending from the body of that bone to the symphysis of the lower jaw, is the narrow space which separates the anterior bellies of the digastric muscles. It is an elongated triangle, broadest below—where the tendons of the digastrics are kept apart by the body of the hyoid bone—having its apex above, where these, having expanded into the fleshy anterior bellies, are infixed side by side at the median line of the jaw. The platysmata in their cellular sheath cover this space, and sometimes decussate across it with each other. The cervical aponeurosis likewise extends over it, adhering to its bony limits, and strengthened by the tendinous slip, which is derived from the digastric. Deeper than the digastrics are seen the fibres of the mylo-hyoid muscles, meeting in the median raphe, which runs along the space. The natural direction of this raphe is almost antero-posterior, and that of the fibres which meet in it almost horizontally transverse: but when (as in any operation on this part of the neck) the head is thrown back and the chin elevated, the raphe presents a considerable downward slope, and the fibres of the mylo-hyoid have a corresponding obliquity. The same observation applies to the deeper fibres which course from the tubercles within the symphysis to the body of the hyoid bone—those, namely, of the genio-hyoid and genio-hyo-glossal muscles. This little region can hardly be said to have any special surgical relations; it contains neither vessels nor nerves of size; its injuries only assume importance when they extend beyond it into the adjoining digastric space; its diseases derive no peculiarities from their situation, and for the most part belong to

the integuments, which are vascular, highly folliculated, and in the male densely bearded: sycosis often extends to them, and they are a frequent seat of sebaceous tumours.

Below the os hyoides, the anatomy, which involves the surgical relations of the larynx and trachea, becomes of extreme importance. Between the two layers of the fascia superficialis the platysma no longer intervenes; they accordingly lie together and are blended. The vaginal processes of cervical fascia, which have isolated the sub-hyoid muscles, become united into a strong and single raphe along the middle line, from above to within a short distance of the sternal notch; but here the layers remain distinct, a superficial one fixing itself to the notch and to the interclavicular ligament, while the deeper one descends with the muscles into the mediastinum. The interval contains loose cellular tissue, and sometimes (as Burns noticed) an absorbent gland. Accordingly, in the very median line, an operator may expose the larynx, trachea, or thyroid body without dividing or displacing any portion of muscle; but a lateral deviation from this imaginary line would imply an exposure of the sub-hyoid muscles on one side or on the other. Indeed, the muscles so nearly approach to the line in question, and constitute in their laminar arrangement so useful a guide to the subjacent parts, that the bare possibility of avoiding them is wisely neglected, and the surgeon learns from them his nearness to the organs which they cover.

In tracing, from the hyoid bone downward, the irregular profile of the air-tube, the finger may distinguish through the integument the following changes of outline. 1. A horizontal semicircular notch, limited below by the prominent angle of the thyroid cartilage, and corresponding, in the interval of the muscles, to the thyro-hyoid membrane; the lateral parts of this give passage, as we shall presently see, to the laryngeal artery and nerve, but its mesial part, with which alone we are now occupied, has only a small twig from the thyroid artery ramifying over it: the membrane is thick, and composed of strong vertical fibres in the median line; it becomes weaker and of laxer tissue in proceeding backward. Its deep aspect contributes to the skeleton of the pharynx, and corresponds to the epiglottis, from the attached portion of which it is separated only by cellular tissue and the epiglottidean gland; while, above, the mucous membrane, in being folded forward to the epiglottis, intervenes between it and the membrane. This notch is frequently invaded by the knife of the suicide; and there is perhaps no part of the neck on which a gash may be inflicted with less serious injury: the large vessels are far removed, and the larynx lies below the blade, which may, if near to the hyoid bone, enter the pharynx above the epiglottidean fold of mucous membrane, leaving the epiglottis unhurt, or, if more nearly approached to the thyroid border of the space, may partly or entirely sever that cartilage from its inferior attachments. No special surgical operation belongs to the space; if indeed we

except a proposal made by M. Malgaigne* for reaching the larynx through it, which has not yet received the sanction of practice.

2. The angle, in which the alæ of the thyroid cartilage meet, having—under the quaint name of *pomum Adami*—its extreme prominence above. Within it are the essential organs of voice, which, buckler-like, it protects: the inward aspect of its angle attaches the vocal ligaments; its outward jutting marks their length, and measures the development of the larynx. Hence the *pomum Adami*, as indicating by its prominence that matured growth of the organs of voice, which belongs to male puberty, is a physiological character of sex. Desault's mode of laryngotomy consists in a vertical division of this angle from below upward, and has the recommendations of easy performance and of efficiency for the extraction of a foreign body. That it invades parts of high functional endowment and extreme irritability,—that ossification of the cartilage may unexpectedly prevent its completion,—that perfect reunion of the divided structure is uncertain—are alleged as objections to it, and perhaps over-estimated as such; for to the first may be answered, that the operation is of *relief*, and hence little likely to aggravate an irritation, the cause of which it removes; to the second may be conceded, that the mode of operation is not eligible for cases likely to present the bony deposit referred to; and against the third may be adduced the evidence of the French surgeons, by whom chiefly the operation has been performed, that the parts are as quickly repaired, and their functions as completely recovered, as after any other mode of operative procedure. As regards its anatomy, nothing can be easier than to lay bare the *pomum Adami*; a division of the skin, of the superficial and proper fasciæ, with some lateral displacement of the sub-hyoid muscles, will suffice for its exposure: and, for its division,—the closest following of the medial line, in order that the knife may pass *between* the vocal ligaments, leaving both uninjured, is the chief precaution to be observed. The upper edge of the glottis is on a level just below that of the superior thyroid notch. The prominence of the thyroid cartilage and the unyielding support which the borders of its arched surface receive from the bony column behind it, render it liable to be crushed by any considerable, direct, antero-posterior violence. Such has, more than once, been the cause of immediate death where a straightforward blow has reached the larynx in prize-fighting; and such, too, is a not infrequent effect in death by hanging, especially where, as in the English mode of judicial execution, the rope is made to tighten itself jerkingly. The thyroid cartilage is sometimes partially divided in attempts at self-destruction, which it commonly frustrates by defending more important parts.

3. A depression which answers to the crico-thyroid ligament: it is here that the usual operation for urgent glottic dyspnoea is performed. The common integuments and the fascial raphe

cover the little interspace in question, which is safely reached—between the crico-thyroidæ—by displacing in a slight extent the sub-hyoid muscles. It has about half an inch of transverse breadth, and about a third of an inch of height,—is bounded by the inferior thyroid notch and by the anterior part of the circumference of the cricoid cartilage; which borders give attachment to the strong yellow elastic membrane that closes the space. This depression is so readily felt through the integuments—its boundaries are so definite and its relations so simple, as to render it a peculiarly eligible spot for bronchotomy, when suddenly and urgently required. A small artery sometimes forms, with its fellow of the opposite side, a transverse communication across this membrane, and its presence has been much insisted on as a circumstance of practical importance: it is of extreme minuteness, and by no means constantly present: it is the *crico-thyroid*, and arises from the thyroid branch of the external carotid, near the upper angle of the thyroid body, and runs across the membrane toward the median line. The necessity for haste is commonly of too urgent a character to admit of any deliberate, layer-by-layer, dissective operation: a single steady puncture with a canulated trocar, or with a bistoury—directly followed by a tube—is the usual mode of conducting it. In such instances the minute artery can hardly be avoided with certainty, but neither can its division be injurious, since the closely fitting canula will secure the cavity of the air-tube against its trifling hemorrhage. In the rarer cases, where time is allowed for a slower division of the tissues, it would be desirable not to puncture the membrane till the artery, if present, had been disposed of. It usually lies near to the border of the cricoid cartilage, and might easily be drawn downward away from injury; or its division might be rendered harmless by torsion, or by a fine ligature. In the more extemporaneous mode of laryngotomy the bistoury should be guided flatly, close beneath the thyroid cartilage; in so making a transverse division of the membrane, it is parallel to the line of the artery, but above its usual position.

4. The slight prominence of the cricoid cartilage, and the series of tracheal rings—becoming progressively deeper toward the sternum,—are next felt. In some subjects their chain is seemingly interrupted by a transverse fleshy eminence (which, however, is in health generally imperceptible through the skin), the isthmus of the thyroid gland. To the lateral portions of this body I shall presently return: the isthmus is its only part having relations in the median line, which it crosses to a very variable extent. Most frequently it measures about half an inch in breadth, and corresponds by its middle to the second ring of the trachea: but from this, its normal extent may vary on the one hand to the extreme of entire absence—on the other to that of being an uncontracted, flattened union of the lateral lobes, which it may so equal in its vertical dimension. Downward from its lower edge, in front of the remaining rings of the

* Médecine Opératoire, 1840, p. 517.

trachea, passes the inferior thyroid venous plexus, on a level with which would be found, in rare cases, the middle thyroid artery (of Neubauer) ascending from the aortic arch: these vessels are covered by a layer of fascia dividing them from the sterno-thyroid muscles. These parts are variously involved in the two remaining modes of bronchotomy; one of which—the tracheal—consists in dividing three or four rings of the tube, below the isthmus of the thyroid gland; the other—the crico-tracheal—in dividing its upper rings and with them the cricoid cartilage of the larynx. The first—*tracheotomy*—(after a vertical division of the tegumentary parts and a separation of the muscles from the lower part of the larynx to the sternum) exposes the tube in that portion of its extent in which it is deepest and most nearly related to vessels. The operator is required to bear in mind the possible presence of a middle-inferior thyroid artery, lest he wound it inadvertently; he must avoid, or, before opening the air-tube, must secure the inferior thyroid veins; in recollecting the great lateral mobility of the trachea and its close parallelism to the carotid arteries in the lower part of the neck, he must guard against any oblique glancing of his knife, by which these great vessels might be injured; in proceeding to divide the cartilaginous rings, he must commence below and on a completely exposed part of the tube, and with the blunt border of his knife toward the middle line of the sternum, and with its point directed slightly upward, lest (as might happen in neglect of these precautions) the great vena innominata, transversely crossing the tube just below the level of the sternum, or the large arterial trunks, which are there diverging from the median line, should sustain injury: nor must he rudely transfix the tube and encounter the risk of puncturing parts, normally or abnormally behind it.* The second operation, *crico-tracheotomy*, first proposed by Boyer,† pretends to preference over that just mentioned, on the ground of obtaining an equally free opening with less invasion of important parts. Indeed, although M. Boyer, in proposing it, seems to have considered the section of the thyroid isthmus inevitable, and accordingly included its division in his estimate of risks,—perhaps even that objection might be withdrawn from the operation, if performed in exact agreement with his description; since the finger may depress the thyroid body to an extent which

admits a safe division of the first two rings of the trachea. But it seems to have escaped his notice, while theorising on the operation, that a section of the cricoid cartilage must be *useless*, unless *abused*; that a rigid ring, divided at one point of its circumference, remains unloosened; that a single section of the cricoid cartilage could not be made available as a means for increased access to the air-tube, over and above that afforded by division of the trachea, except by employing on it a disruptive force, that should effect a counter-fracture at some other part of its circumference. Such violence on such an organ M. Boyer was far too judicious a surgeon to have sanctioned; and from the single instance, appended (p. 142 *bis*) to his speculations on the subject, it appears probable that the upward extension of his opening in the air-tube was useless; that an incision through the upper rings of the trachea sufficed for the escape of the foreign body; and that, in all essential particulars, the crico-tracheal operation is but tracheotomy at a higher than ordinary level, complicated with an unadvantageous and therefore objectionable intrusion on the larynx.

2. The *antero-inferior triangle* adjoins inwardly the space last described, is bounded outwardly by the decussation of the omo-hyoid muscle (which separates it from the superior compartment of the great anterior triangle) with the imaginary diagonal, which demarks it from the postero-inferior or supra-clavicular space. Its various parts and contents require some separate description. As regards the integuments, it will be remembered that the platysma only partly covers this space, and that the anterior jugular vein, when it exists, is contained in the lower part of its course. The sterno-cleido-mastoideus follows the outer side of the triangle, but extend over it by its sternal border, so as to cover a large portion of its area. Beneath this muscle, the stronger deep layer of the cervical fascia is extended and splits internally to enclose the sterno-thyroides, which likewise encroaches on the space by its inner side. Under this fascia the common carotid artery (beside which are the jugular vein and the pneumogastric nerve) ascends vertically, and is slightly overlapped from within by the thyroid body. The anatomy of the space is well developed, in considering the best mode of reaching the carotid artery: a vertical incision falling on the sterno-clavicular joint exposes the superficial fascia and part of the platysma; these being divided, the sheath of the sterno-mastoid is seen, and on its being opened the sternal fibres of the muscle present themselves, obliquely ascending outward: their division and displacement exposes the posterior layer of their fascial investment, which is here seen to ensheath the sterno-thyroid muscle: the descending branch of the lingual nerve (*descendens noni*) seems almost embedded in the deep layer of the aponeurosis, and reaches the outer edge of this muscle in the upper part of the space:—beneath the stratum of parts so constituted, the carotid lies with the associated organs: the jugular vein is on its outer side,

* In suggesting the possibility of injuring organs abnormally situated behind the trachea, the text particularly refers to the occasional passage of a right subclavian artery, from the left part of the arch, either between the œsophagus and trachea, or behind both those tubes. The anomaly is not a very rare one; and a case is reported, in which the artery, so running, was pierced by a bone, arrested in and perforating the œsophagus. (*Dublin Hospital Reports*, vol. ii.) The irregularities of the aorta itself, quoted by Tiedemann from Hommel and Malacarne, are of almost unique occurrence, hardly furnishing an additional argument for that uniform caution, which the above less infrequent abnormality makes imperative.

† *Maladies Chirurgicales*, vol. vii. p. 131.

the *nervus vagus* lies deeply between the two vessels and behind them; the cellular membrane, which invests and binds them together, appears to form an indistinct septum to isolate the artery; crossing the front of the sheath,—from the median line toward the jugular trunk, opposite which they pierce—are many veins, of which some are occasionally considerable in size: they are branches from the larynx, trachea, thyroid body, and sub-hyoid muscles, and among them, when it exists, must be counted the anterior jugular: they are capable of causing much inconvenience to the operator, and require to be carefully managed: on the left side, the internal jugular vein itself, inclining toward the median line below, slightly overlaps the artery: the posterior layer of the sheath of these vessels is a thin process of the fascia interposed between them and the sympathetic nerve, which descends vertically behind: separated in like manner from the great vessels, we find the inferior thyroid artery, which ascends in an obliquely serpentine course to the lower angle of the thyroid body, and the recurrent laryngeal nerve, mounting (on a plane deeper than that artery, internal to which it is situated) toward the posterior part of the cricoid cartilage; the nerve is therefore very nearly approached to the hindermost part of the tracheal cartilages, and, on the left side, ascends between them and the œsophagus, closely applied to the latter.*

* The *cardiac branches of the sympathetic*,—although they require notice in connexion with the anatomy of the large vessels,—have little particular interest in regard of the surgical operations, which are practised on these, and some account of them is therefore better appended in a note than blended with the text. They are seldom or never distinctly seen in operations; and the rule for their management is but a part of the general principle (which ought to be supreme in every surgical exposure of an artery, and the neglect of which has been, I doubt not, at the root of most unsuccessful issues) that the disturbance of surrounding parts, and the denudation of the artery, should both be in the very least degree, which will permit the ligature of the vessel to be accomplished. The cervical cord of the sympathetic lies, as already mentioned, behind the sheath of the cervical vessels, and presents three ganglia, from which, and from the cord, various branches originate. Of these ganglia,—the uppermost has often above an inch in length, is of tapering rounded form, and is situated in the posterior pharyngeal region, on the second and third vertebræ: the second, of smaller size and inconstant occurrence, usually lies upon the inferior thyroid artery: the third, frequently confused with the first dorsal ganglion, is deeply imbedded behind the origin of the vertebral artery. From these sources, assisted and reinforced by the pneumogastric and other nerves, the cardiac branches originate in a manner and succession which will be described in a future article. (See SYMPATHETIC NERVE.) In descending, they lie posterior to the sheath, and the superior one internally to it, close to the trachea, and, on the left side, to the œsophagus. When they approach the inlet of the thorax, they comport themselves variously in regard of the subclavian artery; sometimes passing behind it, on each side, and furnishing twigs, which cross its anterior surface; sometimes, on the contrary, crossing its front by their main branches; and sometimes so dividing as to envelop the artery in an abundant nervous plexus. They are very irregular;

The *thyroid body* belongs to this space by its lateral parts, and, when of moderate development, overlaps the carotid sheath: It consists of symmetrical lobular halves, united by the isthmus already alluded to: its lobes are pear-shaped, on a section, the small end being upward; they are plump outwardly where the fascia gives them a smooth envelope, but hollowed inwardly where they adapt themselves to the air-tube: the isthmus commonly connects the lobes by their lower part only, by over-bridging the trachea at about its second and third rings: the apex of each lobe reaches to the ala of the thyroid cartilage, covering the fibres of the constrictor pharyngis, which arise there, and receiving the superior thyroid artery from the external carotid: the circumference of the organ presents, then, upward a crescentic sinus in which the angle of the thyroid cartilage, the crico-thyroid membrane and muscles, the cricoid cartilage, the first one, two or three rings of the trachea are seen: its thick outer margin,—running from the apex to the third, fourth, or fifth ring of the trachea—corresponds in that extent to the carotid artery, which it more or less overhangs, and below to the recurrent nerve of the larynx; by the extremity of this border the inferior artery reaches it from the thyroid axis; the inferior margin gives exit to veins, which have already been mentioned, and not infrequently receives by its middle a fifth artery from the arch of the aorta or from the arteria innominata.

From the remarkable vascularity of this body, so disproportionate to its volume and apparent unimportance in the œconomy, it readily falls into the heterogeneous group which the German anatomists have named “*Blood-ganglia*” (*blut-knoten*). From the same circumstance, and from the probably vicarious function which it seems to discharge, it is extremely liable to hypertrophy, the different forms of which, attended by whatever structural change, are confounded under the name of *goltre* or *bronchocele*. From the account given of its anatomy, the symptoms of its enlargement may be surmised; for it is obvious that a tumour, so related to the windpipe and so checked in its outward growth by tense aponeuroses, must gravely affect respiration. Overlapping the common carotid arteries, the tumour derives from them a strong and often visible impulse; and, over and above the jerk, which they communicate to it, a general thrill of distensive pulsation, arising from its own almost erectile vascularity, may be felt by the surgeon. Superficial observation might fail to distinguish such a tumour from carotid aneurism, but anatomy establishes the diagnosis; for, in each movement of deglutition, the diseased mass accompanies the larynx, and is seen to rise and fall in the neck. Attempts at extirpating but, in all cases, largely communicate with the recurrent nerves, behind the subclavian arteries, and furnish numerous continuations, which descending around the three great vascular trunks to the arch of the aorta, hence prolong themselves to the base of the heart.

goitres by the knife have been almost superseded by the discovery, that iodine exerts a marked controul over many enlargements of the thyroid body; and it would evince other boldness than that of knowledge, lightly to undertake the excision of a tumour so importantly connected. The jugular vein, the carotid artery, the pneumogastric nerve, which on each side the diseased body would overlap,—the trachea and œsophagus, which it would almost encircle, might indeed be avoided in an attempt at its removal; but the enormous venous as well as arterial hæmorrhage that must occur, and the extreme likelihood of dividing the recurrent nerves, would involve a not small possibility of accelerating the fatal result, and deter every prudent surgeon from attempting an operation of such extraordinary risk, except under circumstances that might justify the most favourable remote prognosis. The ligature of its nutrient arteries has been advocated as a cure for bronchocele; but, although this mode of procedure presents fewer anatomical difficulties than that last mentioned, yet, from surgical considerations of its extreme uncertainty and unsafe protraction, it seems little entitled to preference.

On the left side, the *œsophagus*, inclining from the median line, presents itself in the antero-inferior triangle. It only half emerges from behind the trachea (which still covers its right portion), and closely lies on the vertebræ: it continues the canal of the pharynx, from a line of abrupt distinction opposite the lower edge of the cricoid cartilage, downward. It is at its commencement that this tube most frequently interests the surgeon, by becoming the seat of stricture, or by arresting and fixing foreign bodies. To this space the operation of œsophagotomy belongs; and the left side is, for obvious reasons of convenience, chosen for its performance. In Mr. Arnott's instructive paper on the subject the following directions occur, which may serve to illustrate the anatomy of the region in regard of the operation in question: "The situation of the external incision will, in some measure, depend upon that of the body to be removed, but as the pharynx, tapering gradually in its descent, terminates in the œsophagus immediately under the larynx, it is here that a bulky substance is most apt to be detained. In reaching the œsophagus at this place, taking as a centre a spot corresponding to the level of the lower margin of the cricoid cartilage and the first ring of the trachea, the only parts of consequence, whose injury is to be dreaded, are the inferior thyroïdal artery and recurrent nerve, (the superior thyroïdal artery being too high to run any risk;) but these will not be wounded, if the same plan is adopted as that in the case related, of separating the deeper-seated parts by the handle of the scalpel and the finger instead of by the knife. Here they were not seen during the operation, in fact they were not within the sphere of the wound, for, on examining the parts after death, the artery and nerve were found below and on the inner side of it. Still I am satisfied by trials on the

dead body, that the artery is likely to be divided if the operation is completed by the knife, and hence the expediency of proceeding deliberately, cutting but little at a time, sponging carefully, so as to see and avoid the artery, if possible, or to tie it immediately when cut. The recurrent nerve runs less risk as it reaches the side of the trachea, to which it is attached in its ascent, lower down. I do not allude to the carotid artery as being exposed to any peril. I think, with Mr. Allan Burns, that he must be wanton indeed in the use of his knife, who hurts this vessel. In making the incision into the œsophagus, it is to be remembered that the recurrent nerve runs in the angle between this tube and the trachea, and therefore the incision is to be made a little behind this angle."*

3. *Antero-superior triangle*.—This pretty nearly corresponds to the depression which in lean subjects is seen at the side of the neck beneath the jaw and in front of the sternocleido-mastoid muscle. It is bounded behind by the diagonal line to which we have so often referred; the posterior belly of the digastric and the superior belly of the omo-hyoid constitute, respectively, its upper and lower borders, and their convergence to the hyoid bone anteriorly forms its apex. The fascia superficialis, enclosing the *platysma myoides*, extends uninterruptedly over its borders; and the cervical aponeurosis splitting at each, extends singly over the area which they enclose: the transverse processes of the vertebræ, covered by muscular attachment and by the pre-vertebral aponeurosis, form its floor. The common carotid artery enters it below, and, at about the level of the lower border of the third vertebra, divides into the internal carotid, which continues to the cranium in the direction of the trunk, and the external, which runs and ramifies in more superficial parts; the sympathetic, as in other regions of the neck, lies between the posterior layer of the sheath of the vessels and the pre-vertebral fascia; the superior laryngeal nerve lies in the same interval, obliquely bending from above to the posterior part of the thyro-hyoid membrane behind the vessels: it is on the confines of this triangle and the digastric space that the posterior belly of that muscle, accompanied by the stylo-hyoid muscle above and the lingual nerve below, arches across the external and internal carotids, and at about this level the stylo-glossus and stylo-pharyngeus with the glosso-pharyngeal nerve intervene between those large arteries. It is only below this crossing that the vessels fall under our present consideration, and their study may be facilitated by extending an arbitrary line of division from the *os hyoides* (at the apex of the space) transversely backward. Such a line would have below it the trunk, bifurcation and continuing branches of the common carotid, and the origin from the external of the superior thyroid artery alone; while, above the level referred to, the continued secondary trunks would be seen, and many of the branches

* *Medico-Chirurgical Transactions*, vol. xviii.

which spring from the external one, viz. the occipital passing obliquely toward the mastoid process, under cover of the posterior belly of the digastric, and hooked round by the hypoglossal nerve; the muscular, which is not invariably present, inclining outward to the sterno-mastoides; the lingual and facial (divided by an imaginary prolongation of the cornu of the os hyoides from the superior thyroid) entering the digastric space, the former transversely by running along the cornu of the os hyoides between the hyo-glossus and middle constrictor, the latter more obliquely ascending; and the pharyngeal artery deeply running upward beside the pharynx. To all these branches a more particular description has been given in a previous article, than would be suitable to the present one; and to that the reader is referred for the details of their distribution. (See CAROTID.) The jugular vein descends externally to the internal, as to the common carotid, the vagus lying, as in the lower region of the neck, between the two vessels and rather behind them. The vein receives several branches, in traversing this triangle, from the larynx and tongue, and usually the facial vein: all these, since they come from within, must cross in front of the artery, and sometimes form an intricate plexus, which much embarrasses an operator. In front of the sheath descends, with a slight inward obliquity, the branch of the lingual nerve, which at the lower part of the space, and while lying over the vein, forms a reversed arch of communication with the cervical plexus, whence branches are distributed to the sub-hyoid muscles. The integuments and platysma require no particular notice; their veins and nerves have already been described; among the former must be reckoned the anterior jugular; the space contains a great number of lymphatic glands, a long chain of which (*glandulæ concatenatæ*) lies along the outer side of the sheath of the vessels, while some also lie about the thyroid and lingual arteries on the inner side of the sheath. The surgical relations of this space are chiefly confined to the arteries: ligature of the common carotid or of either of its branches may easily be performed here, since the vessels lie under a much less thickness and variety of parts than below. A vertical incision falling on the point of intersection of the omo-hyoid and sterno-mastoid muscles, and successively dividing the superficial fascia (in which the platysma and cutaneous nerves are contained) and the cervical aponeurosis (a single layer, as it stretches across the space, but, of course, double where it encloses the sterno-mastoid,) exposes the sheath of the vessels, the veins which transversely cross its arterial portion, and the descending noni which runs on the part of its wall corresponding to the jugular vein: and here, as he might open the sheath lower or higher, the surgeon would expose the common carotid or its branches; and, in remembering that the internal (so named from its distribution only) lies at first external to and behind the other, he would be able to isolate and

secure either of these at his option. In any attempt to tie the branches of the external carotid, a clear notion of their respective relations to the hyoid bone is of indispensable necessity; and, in ascending toward the digastricus, it must be remembered that the lingual nerve crosses the carotid sheath but just below the border of that muscle, and that it and the facial vein are consequently exposed to injury. Attempts at suicide by cutting the throat seldom succeed; the incision is usually made closely either above or below the hyoid bone; in the former case entering the digastric regions, and dividing, with the muscles of the tongue, the lingual and perhaps the facial artery; in the latter case, traversing the thyro-hyoid membrane, penetrating the pharynx, perhaps implicating the epiglottis, dividing the thyroid artery, and very rarely reaching the external carotid. The mode of searching for these vessels must vary according to circumstances, but, in all essential particulars, may readily be deduced from their anatomy.

4. The *postero-superior triangle* is a large space of singularly little interest, having its inferior boundary fixed by the omo-hyoid muscle, its anterior by the diagonal which intersects this, its posterior by the edge of the trapezius, and its apex by the mastoid process. It contains, below, a part of the brachial plexus (the anterior branches, namely, of the fifth and sixth cervical nerves, which directly pass beneath the omo-hyoid muscle into the adjoining inferior triangle,) the whole of the cervical plexus and many of its branches, the spinal accessory nerve, obliquely crossing from the sterno-mastoid to the trapezius, which it enters near its clavicular insertion, and some ramifications from the arteria transversalis colli, which, under the name of superficial cervical, ascend in the space, supply its cellular membrane and lymphatic glands, and ultimately inosculate with descending twigs from the occipital. The pre-vertebral fascia covers its deep parts; the common cervical extends between its borders; the platysma myoides exists as a covering for it only in its lower part.

5. The *postero-inferior triangle*, (that of the subclavian artery,) is one of manifold importance. The well-known lines of the omo-hyoid and clavicle limit its area above and below, the former dividing it from the space last considered, the latter from the pectoral region; intersecting the omo-hyoid, our imaginary diagonal, as it stretches from the centre of the sterno-clavicular joint upward and outward, bounds it internally, and constitutes an arbitrary but most useful separation between the space, exclusively appropriated to the subclavian artery with its branches and that internally adjoining it, (the antero-inferior,) which is the proper territory of the carotid. The parts forming its deep or posterior wall are, the transverse processes of the lower cervical vertebræ and head of the first rib, the outer edge of the longus colli and the broad lower part of the *scalenus posticus*: its inferior wall presents the upper surface of the first rib, and within the curve of this bone a part of the upper inlet of the

thorax, at which during life the pleura bulgingly rises, deriving considerable support from the horizontal inflexion of the cervico-thoracic fascial septum. Externally to the curve of the rib, (with the coracoid process bounding it outwardly, the clavicle in front, and the superior costa of the scapula behind,) is the space through which vessels and nerves connect the cervical and axillary regions; to the borders of which, deep layers of aponeuroses are so fixed that the regions only communicate in the line of the vessels, within the infundibulum of pre-vertebral fascia. Its anterior or covering wall presents, in addition to the platysma and subcutaneous areolar tissue, which in all directions extend beyond its margins, the cervical fascia, as a single layer (except where it splits at the trapezius and sterno-mastoid) fixed to the clavicle below, and enclosing the omo-hyoid above. From the higher part of its posterior wall, originating at the anterior tubercles of the transverse processes, descends the scalenus anticus to fix itself in the floor of the space, on the upper surface of the rib, anteriorly. It intercepts, like a flying buttress, a space between itself and the posterior wall, occupied by the brachial plexus and subclavian artery, round all which, as also round the subclavian vein, which lies in front of the scalenus, the prevertebral aponeurosis is folded and prolongs itself as a funnel; it is from this, that the slip of fascia is derived, which passes to the clavicle, in the manner described above, as a horizontal process, dividing the axilla from the neck.

As the distributive anatomy of the vessels and nerves will be detailed in a future article, (*vide* SPINAL NERVES, SUBCLAVIAN ARTERY), their arrangement will now be only sketched, in its regard to surgical relations. The many important points of distinction between the right and left sides of the body in this region will presently be considered, the description meanwhile applying to both indifferently. The subclavian artery, from the sterno-clavicular joint outward, over-arches the floor of this region, presenting upwards a convexity in the interspace of the scapuli, downwards a concavity, which adapts itself to the pleura and to the rib. It gives off, as from an axis, branches from the four cardinal points of its circumference: 1. downwards the internal mammary, which, crossed at its origin by the phrenic nerve, descends within the cartilages of the ribs; 2. upwards the vertebral, which, after a course of an inch between the scalenus anticus and longus colli, enters the canal of the transverse processes, usually at the sixth; 3. forwards the thyroid axis, a short trunk giving origin to the inferior thyroid branch (already seen obliquely ascending behind the carotid sheath), the ascending cervical, which mounts beside the phrenic nerve, along the scalenus anticus, and two transverse branches, which direct themselves outwardly, crossing that muscle,—the transversalis humeri along the clavicle, the transversalis colli higher, amid the branches of the brachial plexus and winding round the scalenus posticus to gain the inner edge of the

scapula; lastly, 4. backwards an artery, which, directing itself to the neck of the rib, subdivides there into two branches, one of which descends across the rib to the thorax, the superior intercostal, while the other continues, between the neck of the rib and the seventh cervical transverse process, the backward direction of the common trunk, and then ascends among the deep muscles of the dorsal region—the arteria cervicalis profunda. The course of the subclavian artery is conveniently divided into three stages; a last or distal one, in which after having passed behind the scalenus anticus, it has, behind it, the scalenus posticus, below it the groove of the rib, above it (extending likewise a little behind) the brachial plexus of nerves, in front of it the coverings of the space we are considering, a familiar knowledge of which is here especially needed, since it is in this portion of its course that the artery is usually tied for axillary aneurism: a second stage, in which it lies between the scapuli, its convexity toward their origin from which the brachial plexus divides it, its concavity reposing on the pleura; and a first or tracheal portion of its course, differently related on the two sides of the body, but thus far alike in both, that from it the branches originate, that its concavity is to the pleura and its convexity, almost at right angles to the direction of the carotid, looks upward; that it is related, behind, to the sympathetic and to the last cervical transverse process,—in front, to the vagus and phrenic nerves and to the jugular and subclavian veins,—inwardly to the carotid artery. The circumstances of difference are mainly due to the fact, that, while on the right side a common brachio-cephalic trunk exists—the arteria innominata,—which lies at no great depth from the sternum, so that its branches diverge to their respective destinations from a comparatively superficial and single point, behind the sterno-clavicular joint; on the left side, contrarily, the carotid and subclavian arise separately from the arch, the latter, at a vast depth from the surface, actually beside the vertebra; with the exception of having a thoracic commencement (nearly corresponding to the tracheal *half* of the arteria innominata), the left carotid can scarcely be said to differ importantly from the right, at least in virtue of its own course; it is somewhat deeper, lies in front of the œsophagus from the inclination of that tube, has the thoracic duct ascending at its outer side, and is, as will be explained directly, overlapped by the jugular vein in the lower part of the neck. The subclavian artery on the right side passes from its origin almost transversely to the scalene space, covered by the muscles which have been enumerated, crossed at right angles by the phrenic and pneumo-gastric nerves and by the jugular vein; the left subclavian, on the other hand, reaches the groove on the rib after a very deep and a very oblique course; it can scarcely be said to have any transverse direction, but gradually by an inclination outwards and forwards, approaches the rib during its ascent, so that, traced toward its origin from the tracheal edge

of the scaleni, it would appear, instead of having, as its fellow has, a certain length of transverse course, to bend abruptly toward the arch of the aorta, becoming deeper and deeper; or, in other words, while the right subclavian has a considerable extent at its highest level, from the sterno-clavicular joint to the scalene space, the left has comparatively but a culminating point, to which it suddenly rises and from which it quickly sinks. Thus the nerves, which cross the course of the right, are nearly parallel to that of the left: and the relation of the jugular vein is similarly changed, while the subclavian vein, having a longer course than on the right side, obliquely crosses the thoracic portion of its artery.

The anatomy of the veins requires some separate notice: in crossing the scalenus anticus at its insertion, the *subclavian vein* is, on both sides, anterior to the artery, from which the tendon divides it, and somewhat inferior to it; the *jugular vein* in the upper part of the neck descends as already mentioned, beside the internal and common carotid arteries, to which it is external, similarly on both sides. The union of these veins, however, to form the *venæ innominatæ* differs in the following manner. On the right side, the jugular vein, inclining from its artery below, joins the subclavian on the insertion of the scalenus anticus: the arrangement of these important parts is such that they form together an elongated triangle, of which the carotid artery is the inner side, the jugular vein the outer, and the first stage of the subclavian the base, here crossed at a right angle by the pneumogastric nerve, (which reflects its recurrent branch upward and inward behind the artery,) and more outwardly by the phrenic: from this point of junction the innominate vein runs toward the pericardium on the pulmonary side of its artery, that is, externally to it and on an inferior plane. On the opposite side the jugular vein, anticipating its ultimate destination, obliquely bends toward the right side, overlapping the carotid artery, in front of which it receives the subclavian vein by its outer side: the resulting *vena innominata sinistra* runs almost transversely across the arch to join its fellow at the right extremity of this. The vertebral vein opens into the innominate, just internally to the confluence which forms that trunk. On the left side it crosses the subclavian artery: on the right side it is usually, though not always, behind it.

The *thoracic duct*, mounting from the mediastinum, passes behind the arch, emerges between the carotid and subclavian arteries in the root of the neck, and, curving abruptly downwards, outwards, and forwards, crosses the latter artery and discharges its contents by a valvular opening into the subclavian vein close to the angle of its confluence with the jugular.

The surgical relations of this region regard the subclavian artery and the operations which are practised on it. Of these the most usual is its ligature on the outside of the scalene space, where lying upon the upper surface of the rib. An incision, corresponding to the middle of the clavicle, through the skin, super-

ficial fascia, and platysma, and through the strong single layer of cervical aponeurosis which is fixed to the bone,—extending, if necessary, to the origin of the sterno-mastoid and to its sheath, with careful avoidance of the external jugular vein, here bending round the outer edge of the muscle,—opens a space, wherein loose cellular tissue alone veils the continuation of the pre-vertebral fascia, which is prolonging itself from the scaleni around the subclavian vessels: a division of this lamina, as near as possible to the costal attachment of the scalenus anticus, completes the exposure of the artery, which is recognised by the finger, as it emerges from behind the tendon of that muscle, in immediate contact with the rib. The steps of the operation thus considered seem of no great difficulty, and are, in fact, so long as the parts retain their normal bearings, of extremely easy performance: the artery is at an inconsiderable depth; its relations are singularly definite and unembarrassed. But such is not their practical facility, under circumstances which necessitate the operation. To tie the subclavian artery for axillary aneurism may be one of the most difficult operations in surgery, involving extreme patience and much manual skill in him who undertakes it; for the disease, as it extends, not only fills the axilla, but encroaches on the neck, thrusting up the clavicle, and obliterating the interval between that bone and the omo-hyoid muscle. The operation might almost be compared to one of tying the axillary artery in its normal relations from above the clavicle. It lies at the bottom of a deep and narrow cavity, in which the operator must be guided entirely by the sense of touch, and can only apply this under the disadvantage of distance. The circumstances of such a case are well given by the late Mr. Todd of Dublin,* who states that, “so much was the relation of parts altered by the magnitude of the tumour and consequent elevation of the clavicle, that the omo-hyoid was situated an inch below this bone, and it was found necessary to draw it up from its concealment, and to cut it across, that the subjacent parts might become accessible.” It must be under the influence of such changes that the aneurismal sac, by encroaching on the very seat of the operation, becomes liable to injury, and may, as I have witnessed, be actually transfixed by the needle. The relation of the brachial plexus is commonly such that it lies on a plane posterior to the artery, and for the greater part above it; occasionally, however, its last root passes in front of the vessel, and in the disguised condition of parts is not readily to be distinguished from it; since the touch fails in its ordinary discrimination, where exercised with so much difficulty, and it is hardly practicable to apply the test of compression to the supposed arterial trunk, in the view of ascertaining its relation to the tumour, without unintentionally extending the same pressure to the subjacent artery and mis-informing one’s-

* Dublin Hospital Reports, vol. iii.

self accordingly. It must have been through these means of fallacy that I have seen a most cautious and experienced operator deceived: he compressed the supposed artery, raised on the aneurism-needle, with his finger; the pulsation ceased, the ligature was tightened, and the severe pain occasioned by this step at once declared the error (which was in the course of a few moments remedied, and the operation ultimately and entirely successful); the convexity of the needle was doubtless resting on the artery, and compressed it upon the surface of the rib.

The application of a ligature to the subclavian artery on the tracheal side of the scaleni presents, perhaps, fewer merely mechanical difficulties than that just described, but involves a disturbance of more important organs, and requires perfect acquaintance with their anatomy. A separation of the sternocleido-mastoideus from its inferior attachment, and a division of the sterno-hyoid and sterno-thyroid muscles and of their sheaths (including that deep layer which lies beneath the sterno-thyroideus and immediately covers the vessel) will expose the artery.* The jugular vein is seen crossing it, close to the scalenus, at the outer part of the wound, behind which lies the phrenic nerve; at the inner part of the wound the bifurcation of the *arteria innominata* is brought into view, and the subclavian is seen diverging from the carotid. Between this point and the border of the jugular vein, from half an inch to an inch of artery intervenes, about midway on which the *nervus vagus* crosses at a right angle. If the nerve require to be drawn aside, this manœuvre must be executed with the utmost delicacy and gentleness;† and the operator

* The description in the text is confined to the mode of tying the *right* subclavian artery, on which alone, as yet, the operation has been performed. As regards the left, the course of the *vagus* and phrenic nerves (which run parallel to the vessel), and of the thoracic duct (which almost surrounds it) would enormously multiply the risks of the operation; and the increasing depth and oblique descent of the artery, as traced from the scalenus inwardly, would, it is believed, defeat every endeavour to effect its adequate exposure. Should it be desirable to secure the vessel internally to its passage over the rib, the most available method would probably be that of tying it in the scalene space. This operation was performed in a single instance by Dupuytren in 1819 with success. The section of the *scalenus anticus*, if it were carefully executed, would be less perilous than on the right side, and might, under favourable circumstances, afford a sufficient space, between the branches of the artery and the aneurismal sac, to admit the safe application of a ligature. A complete division of the clavicular origin of the *sterno-cleido-mastoideus* would be required; and it would be necessary to obtain a distinct view of the phrenic nerve, before cutting the *scalenus*: the internal mammary artery might, as M. Malgaigne remarks, be injured even more readily than the nerve, if this incision were carelessly extended toward the median line.

† It is difficult, in reading the record, or in witnessing the progress of unsuccessful cases of operation at this part of the neck, to avoid believing that a neglect of cautious tenderness in managing the *pneumogastric* nerve, has tended to compromise the safety of the patient. No surgeon, who considers its vital importance to the functions and

should not fail to remember his dangerous proximity to the pleura. The view of these parts is obscured by considerable venous hæmorrhage, which is here especially inconvenient, from the imperative necessity which exists for clearly seeing the artery and ascertaining the position of its branches before making any attempt to pass the needle. It is considered desirable to apply the ligature on the inner side of the vertebral branch, and as near to it as possible: yet, even under the most favourable circumstances, the adhesive actions at the seat of ligature must be seriously disturbed, both by the near direct stream of the carotid, and by the recurrent ties of the vertebral, mammary, and thyroid arteries. The single instance, in which I have seen this rare operation performed, was by my friend, Mr. Partridge, who brought to bear on its execution a perfect familiarity with every actual relation, and with every possible contingency; nor could it have been confidently undertaken, or safely conducted, by one of inferior resources. The case was in so far favourable, that the tumour was small, the position of parts unaltered, the arteries regular and free from disease, and the venous hæmorrhage not so troublesome as in many cases it certainly would be; the parts were clearly seen, and the artery secured without the least unnecessary disturbance of contiguous parts. Yet, I confess the impression, which I derived from this single instance of operation, and from frequent consideration of the parts in a great variety of subjects, to have been, that ligature of the *arteria innominata* would in all cases be as easy, and, in many, far easier to perform, would (by involving organs of less delicacy and importance, than those interested in the tracheal ligature of the subclavian) render hæmorrhage a less embarrassing obstacle, and would afford a better prospect of undisturbed adhesion in the artery. The steps, necessary for exposing the one, require so little modification, to become equally adapted for the other, that the surgeon might even be determined in his choice of either, by considerations developing themselves during the operation, by greater or smaller branchless extent of the subclavian artery, by the vertebral vein obscuring a large portion of this, or by other circumstances of the kind.

Although the *arteria innominata* cannot in anatomical strictness be considered as belonging to the neck, yet, in regard both of disease and of surgical operation, its affinity to that region is so close as to warrant its mention in this place. It rises from the convexity of the arch of the aorta, just as that main vessel, having terminated its ascent, inclines leftward. This point is in young subjects the highest level to which the aorta attains; but, as Cruveilhier notices, in old age the extreme part of the arch, which corresponds to the origin of the left subclavian artery, is higher. In early life, too, from incomplete development of the sternum, the convexity of the arch more nearly

nutrition of the lung, can avoid viewing any unnecessary disturbance or rude traction of it as eminently perilous.

approaches the root of the neck than in adult growth, and, as also the branches arising from it, may more easily be endangered in tracheotomy and other operations in the neighbourhood. Its length is somewhat above an inch: its direction obliquely upward and outward, toward the sterno-clavicular joint, opposite to which it divides. In this course it corresponds, behind, to the trachea,—in front to the sternum, from which the remains of the thymus gland, the origin of the sterno-hyoid and sterno-thyroid muscles, and (close to its origin) the transverse crossing of the left vena innominata separate it,—externally, to its accompanying vein, and, mediately, to the pleura,—internally, to the left carotid from which it is separated by a triangular interval in which the thymus, or its remnant, lies upon the trachea.

The frequency of its undue extension beyond the precise limit assigned to it, and consequent appearance in the sub-hyoid region of the neck, together with the fact of its often furnishing a middle inferior thyroid artery, are contingencies never to be disregarded in operations thereabout.

This artery has now been tied for cure of aneurism at least six times; unsuccessfully—it is true—but with such nearness to success as not to forbid cautious repetition. The mode of procedure adopted by Dr. Mott consisted in a transverse division of the skin, muscles, and fasciæ along the edge of the clavicle and sternum,—in raising these, and taking the sub-clavian and carotid arteries (which he seems to have denuded to some extent) as guides to the innominata, in drawing the jugular vein, the vagus, phrenic and recurrent nerves outwards, in pressing the pleura carefully downwards with the convexity of the needle, while he carried its point from below upwards around the vessel.

6. *The digastric space* is bounded below by the curve of the digastric muscle, and extends above within the angle and horizontal ramus of the jaw, so that, if considered as a triangle, it may be described as having its base represented by the internal oblique (or myloid) ridge of the lower jaw, and an imaginary prolongation of this to the root of the mastoid process,—its anterior border formed by the ascending belly of the digastric muscle,—its posterior by the descending fibres of the same; and its apex will obviously be at the point of their reflexion by the hyoid bone. The skin, the superficial fascia with the platysma, and the cervical aponeurosis, wall it in, and that part of the inferior maxilla which lies beneath the oblique line, to the basal edge of which the fascia adheres, overhangs it; its deep surface is constituted by the mylo-hyoid muscle and by the side of the tongue and pharynx in front, by the vaginal and styloid processes of the temporal bone behind. A fibrous slip, reflected outwardly from the styloid process to the angle of the jaw, and to the deep surface of the aponeurosis, distinctly divides the digastric space into two parts. Of these, the *posterior* is the smaller; its vertical extent is to the temporo-maxillary articulation: backwards it is bounded by the auditory canal

and mastoid process; inwardly, by the vaginal plate, the styloid process and its muscles. In the anterior direction the border of the jaw, together with the septum just described, are its limits: whence it seems, within the neck of the jaw, to prolong itself as an interspace between the attachments of the pterygoid muscles.

Between the unyielding walls of this narrow space, the *parotid gland* contracts itself into a wedge-like form, reaches in the one direction to the styloid process and is folded round it, in the other is prolonged with the maxillary vessels between the insertions of the pterygoidei. In its substance the external carotid ascends to its terminal subdivision,—the portio dura curves from the stylo-mastoid foramen, and breaks into the lash of communicating branches, known as *pes anserinus*,—the roots of the external jugular vein unite to assume that name,—and junctions of the portio dura with the superficial temporal nerve, and with the auricular branch of the cervical plexus, are met with. Its remarkable impaction behind the jaw is probably designed for affecting its function by the mechanical stimulus of the masticatory movements. Its enlargement may inconveniently hinder these motions, and, where accompanied by much induration, actually lock the jaw. The merely anatomical difficulties of extirpating the parotid gland have probably been somewhat over-rated; but cases requiring the operation must be of exceeding rareness. Absorbent glands lie on many points of its surface, and in its substance; their enlargement is frequent, and has been mistaken, in several instances, for an affection of the parotid itself.

The arteries met with in this space are all branches of the external carotid: the occipital and auricular follow its posterior border, the latter usually traversing a part of the gland; the temporal artery emerges at the upper, the transverse facial at the anterior edge of the parotid, while from its deep portion the internal maxillary passes forward, within the neck of the jaw, toward the zygomatic fossa.

The *anterior* division of the digastric space considerably exceeds the posterior in size: its vertical extent behind is from the curve of the digastric up to the outward surface of the buccal mucous membrane, where reflected from the molar alveoli to the side of the tongue; but anteriorly it seems to be limited by the lower surface of the mylo-hyoid muscle, and so to be shallower; though, in reality, this is not the case, for the muscle referred to merely forms a partial septum, dividing the shallow and superficial part, just mentioned, from a deeper, sublingual portion of great importance. The anterior division of the digastric space may accordingly be considered as bounded above by the mucous membrane of the mouth in its reflexion from the oblique line of the jaw to the border of the tongue, in an extent reaching from the base of the coronoid process to the symphysis; and, internally, by the side of the tongue, (presenting the muscular substance of the genio-hyoideus, genio-hyoglossus, hyoglossus, and stylo-glossus,) and by that of the pharynx. It is only in front that the mylo-hyoid muscle, as

a partial septum, divides a superficial space from the general submucous tract; and it is necessary to understand this arrangement, in order to apprehend the mode in which the submaxillary gland approaches the mucous membrane of the mouth: the gland lies in the superficial division of the space, and it is round the posterior edge of the mylo-hyoid muscle that its duct is reflected in proceeding to discharge itself, which by so entering the sublingual space it is enabled to do. The anterior division of the digastric space contains, superficially the gland just mentioned, the facial artery and vein with some of their branches, the mylo-hyoid twig from the third division of the fifth, and many lymphatic ganglia. The gland receives a thin capsular investment from the deep surface of the fascia, closing the space, and this prolongation contracts and condenses itself round the posterior extremity and duct, accompanying these in their turn round the mylo-hyoid, and furnishing the duct with a dense fibrous tunic. The artery enters the space from below, by passing beneath the posterior belly of the digastric muscle, very tortuously winds through the submaxillary gland, and bends over the basal edge of the jaw a little in front of the masseter. It furnishes a deep ascending branch (the tonsillary) near the angle of the jaw and many glandular twigs; but its only considerable branch in this region is the sub-mental, which runs toward the median line just beneath the jaw, and, supplying the mylo-hyoid muscle on which it is applied, and the anterior belly of the digastric, terminates by freely communicating with its fellow. The sub-mental branch derives additional importance from the frequency of an anomalous distribution, by which, piercing the mylo-hyoid muscle and entering the sublingual space, it partly discharges the functions of the lingual artery in supplying the sublingual gland. The facial vein lies behind the artery, and quits the space below in passing over the digastric and stylo-hyoid muscles, which divide it from the artery. Its usual or chief termination is in the internal jugular; but it frequently contributes more or less to form the external or the anterior jugular vein. The mylo-hyoid nerve runs parallel to the origin of the muscle, which gives it its name, and supplies it and the anterior belly of the digastric. The lymphatic glands are numerous and important: they receive the absorbent vessels from the face and likewise from the mouth and pharynx, are the frequent seat of strumous inflammation, readily sympathize in disordered conditions of the fauces and alveoli, and take an active part in propagating the malignant influence of cancerous ulcerations on the face. These parts are all covered in by the aponeurosis,—which fixes itself to the base of the jaw,—and by the platysma and superficial fascia,—which continue themselves on the face. They are readily accessible to the surgeon, but seldom subjected to any operation of importance. The deep or sublingual portion of the digastric space has its roof formed by the mucous membrane, which, between the tongue and alveolar arch, constitutes the floor of the mouth:

the side of the tongue and the continuous surface of the pharynx, as already described, compose its inner wall; and it follows from the previous description that, in part at least, the mylo-hyoid is its floor. The gustatory nerve runs through it beneath the mucous membrane, which it supplies: the hypo-glossal, describing a parallel but inferior curve, is distributed in succession to the muscles of the inner wall of the space; the glosso-pharyngeal between these two in height, but confined to the root of the tongue, bends inwardly beneath the stylo-glossus; the lingual artery, emerging from under cover of the hypo-glossus, which has hidden its tortuous ascent, divides anteriorly into two branches; a ranine, which follows the curved border of the tongue to its tip, where it archingly unites with its fellow; a sublingual, which directing itself a little outward, supplies the third salivary gland: this little body lies on the divergent fibres of the genio-glossus, near their origin, and close beneath the membrane of the mouth: finally, the duct of the submaxillary gland, traversing the space obliquely, crosses its contents, and communicates with the cavity of the mouth just beside the frœnum. This space is the seat of ranula (a tumour formed by obstruction of the submaxillary duct), and of some salivary concretions; in both which complaints the distended canal is brought so immediately beneath the mucous membrane, which it raises, that other parts are little liable to injury: here, too, it is that the surgeon, when obliged to divide the frœnum linguæ, must cautiously cut the too tight fold near to the symphysis, and vertically, lest, in extending his incision backward, he should wound the ranine artery. Sharp instruments penetrating downward beside the tongue may wound the sublingual artery, and the consequent hæmorrhage, distending the submucous space, raise the reflected membrane on each side into swellings of such size, as to suggest imminent peril of suffocation.*

7. The small region to which, under the name of *posterior pharyngeal*, I propose giving brief notice, has for its roof the basilar portion of the occiput and petrous part of the temporal bone, and presents in this direction the orifices of the jugular, carotid, and anterior condylic canals: it extends downwards between the pharynx and vertebræ into the anterior triangle of the neck, and is separated from the posterior division of the digastric space, within which it lies, by the styloid and vaginal processes, and by the attachment to these of a strong layer of fascia, which passes beneath the digastric muscle. The internal carotid artery, surrounded by branches from the superior cervical ganglion,

* Such an accident I have seen arise from the inadvertent thrust of a tobacco-pipe; the swelling was very considerable on both sides, and produced alarming distress. Cold (aided, no doubt, by the pressure of the effused blood) succeeded in staying the hæmorrhage; had this not been the case, it would have been necessary to expose the lingual artery on the cornu of the os hyoides and to secure it; or, had its ligature not sufficed, likewise to tie the adjoining trunk of the facial, from which the sublingual branch is occasionally derived.

ascends here; and since, from the angle of the jaw to the base of the skull, it lies beside the pharynx, covered by the lateral parts of that cylinder, it is liable to be involved in a punctured wound from the mouth; and this unfortunate accident has not unfrequently occurred in operations on the tonsil, which organ in its swollen state is so closely applied to the internal carotid artery, that if it were transixed by a bistoury in an outward direction, the vessel could hardly escape. Hence the importance of care, in relieving tonsillary abscesses, to direct the point of the instrument, as much as possible, towards the median line, and to select for incision that part of the cyst which most nearly adjoins the palate. The jugular vein emerges behind the artery and runs downwardly along its outer side: of the three divisions of the eighth nerve, which leave the cranium in front of the vein, the glosso-pharyngeal is applied to the outer, the vagus and spinal accessory to the inner part of its circumference. The muscular branch of the latter winds from within behind the vein, and obliquely descends to the sterno-mastoid: the vagus continues to descend vertically along its inner side, but both the glosso-pharyngeal and hypo-glossal nerves obliquely cross between it and the artery, and subsequently arch over the latter in their passage to the tongue. From its relations to the vertebræ in this space, the pharynx may participate in their diseased conditions, and give vent to abscesses, dependent on caries of the cervical spine. The surgeon may sometimes assist his diagnosis of complaints so situated, by introducing his finger into the pharynx.*

8. Lastly, I proceed to recapitulate, briefly and in connexion, the practical relations of the *sterno-cleido-mastoideus* in regard of the spaces which have been described. Its clavicular origin is in the inferior division of the posterior triangle, covers the subclavian artery in the first and second portions of its course, and in many instances extends this origin so far outwardly as to hide the vessel during a considerable part of its third stage; it likewise, of course, covers many parts lying between it and the artery,—the jugular and subclavian veins, the vagus and phrenic nerves, the scalenus anticus and omo-hyoid muscles, and the origin and divergence of many arterial branches: these fibres obviously require division, varying according to circumstances, when the subclavian artery is to be exposed. The interval between its origins corresponds to the sterno-clavicular joint, and, on the right side, to the bifurcation of the *arteria innominata*: along the cellular line, prolonged from this interval, (which answers to the diagonal dividing the two great triangles,) M. Sedillot proposes to penetrate, without section of

muscular fibre, in order to reach the common carotid artery. The sternal head of the muscle, directing itself backward, obliquely crosses, in the inferior segment of the great anterior triangle, the sheath of the vessels, from which the sub-hyoid muscles partly divide it. In order to reach the common carotid artery these fibres are accordingly cut asunder, except where the operator prefers the anatomical *finesse* of M. Sedillot's plan. Tracing the muscle in the middle of the neck, we find it a most serviceable guide in operations on the common carotid, and on its primary or secondary branches. A vertical incision directed to the point of its intersection with the omo-hyoid muscle (nearly opposite the cricoid cartilage) enables the surgeon conveniently to draw these muscles aside, and to expose, according as the wound is higher or lower, the external and internal carotids, or the trunk from which they originate, and, in close connexion with the anterior layer of their sheath, the descending branch of the hypo-glossal. Finally, about and above the level of the hyoid bone, the anterior edge of the sterno-mastoid, with the posterior belly of the digastric, and the cornu of the os hyoides, furnish definite marks for discovering the superior thyroid, the lingual, the facial or the continued external carotid artery; since, in the space so bounded, the last named vessel vertically ascends, the first almost horizontally advances, and the other two pass to their destinations with intermediate obliquity.

IV.—ADDITIONAL PRACTICAL OBSERVATIONS.

It yet remains, in conclusion, briefly to review some circumstances in the anatomy of the neck, which particularly bear on its diseases and on the operations undertaken for their cure. 1. In endeavouring to form a *diagnosis of tumours* in this region, the surgeon will, in the first place, remember their extreme liability to deceptive pulsation, and will neglect no precaution for ascertaining their relation to the large arterial trunks. The glands, which lie about the common and external carotid arteries, in the anterior triangle of the neck, and those which are situated in the supra-clavicular space, are particularly subject, when enlarged, to derive pulsation from the vessels to which they are respectively contiguous. The history of the case,—the signs afforded by auscultation,—the manner in which a non-aneurismal tumour may frequently be moved away from the artery that communicates an impulse to it,—the marked difference even to the unpractised hand, between the mere jerk of elevation in the one case, and the thrilling diastole in the other, are materials for distinction, to which it is here enough to allude. Nor must it be forgotten, that, from the nearness of the aortic arch to the root of the neck, its aneurisms, as they grow upwards and clear the strait of the thorax, may simulate the characters of a like disease in the carotid or subclavian artery. Cases constantly occur, (and may be found abundantly quoted in systematic surgical works,) in which tumours of this kind,

* A case has lately occurred to the writer illustrating this fact. It was one of neuralgia; the pain was of extreme severity and obstinacy; it affected the occipital region, and was referred to the great occipital nerve. An examination through the pharynx succeeded in detecting, as its probable cause, a firm (apparently bony) tumour, connected with the transverse processes, between which that nerve emerges.

rising in the vicinity of the sterno-clavicular articulation, have been mistaken for aneurisms of the innominata, on the one side, or of the carotid or subclavian on the other, according as they have, in their growth, deviated right or left from the median line. Burns records a case, in which an aneurism so originating from the aorta, was even falsely attributed to the right subclavian: it bulged first on the acromial side of the sterno-mastoid muscle, "a point, where no one would expect a tumour to present, which had worked its way from within the chest."* This is an extreme and rare instance; but not so are the misapprehensions, previously alluded to: it is certain, and matter of frequent experience, that aneurisms of the arch, where they escape from the resisting stricture of the sternum and clavicles, project so abruptly, as to have the appearance of belonging to the artery, over which their fundus is situated. They frequently have (as in the case which Burns quotes from Sir Astley Cooper) a Florence-flask-like form, the neck of which may be narrow, and the fundus high in the neck. In several such cases the deception has been so complete, as to suggest to the surgeon the propriety of tying the common carotid below its supposed aneurism:† but no instance is on record, as I believe, of the adoption of so calamitous a proceeding. It is, indeed, true and almost self-evident that an aneurismal swelling, formed at the root of the carotid, will commonly first be perceived in the small interval between the heads of the sterno-mastoid, and, in its further growth, may displace these, or cause their absorption:—that one connected with the arteria innominata is likely to project nearer to the trachea, and on the inner side of the sterno-mastoid:—that one originating from the subclavian will usually rise on the outer side of the same muscle; and that the force of the pulse is generally diminished in the branches of a trunk affected with aneurism:‡ yet, while such facts may have their weight, as excluding certain tumours from the respective categories of subclavian, carotid, or innominata aneurism, and as so assisting the negative diagnosis of these diseases,—it admits of no doubt that they are insufficient to establish grounds for positive recognition. The aortic aneurism may imitate every circumstance of position in the neck, which has been mentioned; and can hardly fail by its abnormal pressure to affect the circulation through the contiguous artery, and to weaken the pulse of its branches. To other criteria, than the mere symptom of external prominence, the cautious surgeon will look for a safe diagnosis of swellings in the root of the neck. The minutest inquiry into the history of the patient during the period, which preceded any outward projection of the tumour, and into the actual state of his thoracic organs and of their functions (with notice of every pain, palpitation, or dyspnoea),—an observation of any existing impediment to the return of blood, as evidenced

by venous congestion,*— and complete and careful stethoscopy, are all requisite to that study of the particular case, which alone can justify an opinion.

2. An important subject for mention, in regard to the surgical anatomy of the neck, is the provision for collateral circulation, when the main trunks are obliterated. Mr. Burns, in discussing the question of tying the arteria innominata, speaks of these natural resources in the spirit of confidence, which has been familiar to English surgery, since the time of its profound lawgiver, John Hunter: "We entertained no dread of the circulation being supported in the right arm; nay, we reduced it to a demonstration. On the dead subject, I tied the arteria innominata with two ligatures, and cut across the vessel in the space between them, without hurting any of the surrounding vessels. Afterwards, even coarse injection impelled into the aorta, passed freely by the anastomosing vessels into the arteries of the right arm, filling them and all the vessels of the head completely." The fluid passed (as the blood would, under similar circumstances, pass in the living subject) from the carotid of the left side to that of the right, through the mesial inosculations of the thyroid, lingual, facial, temporal, occipital, and (not least) cerebral arteries: from the left subclavian, in like manner, chiefly through the thyroid and vertebral branches; and thus a regurgitant stream would flow into the main vessels, up to the very site of ligature. Partly through the continued trunk of the tied vessel, so reinforced by its fellow, and partly by secondary communications (as of the occipital with the cervicalis profunda, of the facial with the internal maxillary, of the pharyngeal and palatine arteries) the blood is distributed in its legitimate destination. If the subclavian alone be obliterated at its commencement, the inferior thyroid and vertebral (communicating with their fellows, but still more largely with the carotid of the same side) helped by the muscular branches of the occipital, will convey the derived current. If the ligature have been applied beyond the scaleni, the transverse branches of the thyroid axis, by their free inosculations with the articular branches of the axillary, and with its subsc-

* An interesting case is given by Professor Pattison, in his Appendix to the edition of Burns, (on the Surgical Anatomy of the Head and Neck,) from which I have already quoted. A person who had suffered during six months with obscure pains about the lower region of the neck, which were attributed to rheumatism, died comatose. It was found on dissection that there arose from above the arteria innominata a large tumour, which projected forwards, adhering to the sternum, which its pressure had rendered carious; and that "the transverse vein, formed by the union of the left subclavian and jugular veins, presented a very uncommon appearance. It had more the character of a ligamentous cord than of a distended vessel; and when opened, it was found filled with coagulable lymph, which completely obliterated its cavity. On being traced downwards towards the right aricle, the vein was seen to terminate at the sternal aspect of the aneurismal tumour, that portion of it which crossed the tumour having from pressure become obliterated."

* Op. cit. p. 62 et seq.

† Hodgson, Diseases of Arteries, p. 90.

‡ Vide Cyclopædia of Surgery, vol. i. p. 237.

pular branch, abundantly restore the circulation. Should the carotid have been tied, its mesial communications, already mentioned, especially those within the skull, and about the thyroid gland,—assisted at those places and elsewhere by anastomoses with the subclavian,—adequately fulfil their vicarious duty. So abundant are these various communications, that the ligature of a main trunk, in the dead subject, in no degree interferes with the distension of its branches by fine injection: if we inject water, or any equally fluid material, through one carotid artery, it freely returns by the other. Under these circumstances, it excites our surprise that the cure of aneurism by ligature should be so certain; for the amount of circulation through the affected vessel can at first be little affected, and the arrest and ultimate cure of the disease must be referred rather to the withdrawal of a distensive impulse than to any considerable derivation of current. It seems to have been considered, in operating for aneurism, that, so long as no large branch arose from the vessel closely on the cardiac side of the ligature, it mattered not what branches might arise on its distal side,—how large, or how near. In many instances secondary hæmorrhage, inducing death, has manifestly depended on defective adhesion at the distal side of the ligature, and for an obvious reason. The condition of that part of the artery has been neglected: it has been thought unimportant though a large vessel should arise just beyond the ligature; or, if a great length of artery have been injudiciously denuded, the cardiac portion has had an exclusive preference of security given to it, by the ligature being drawn as high as possible in that direction. If an equal attention were bestowed on both sides of the proposed seat of ligature,—if like care were taken, in both directions, to avoid the likelihood of disturbance to the adhesive process by side currents,—if, where the artery has been much denuded, (instead of a single thread being applied at the cardiac extremity of that isolated portion, by which plan the succeeding part of the tube,—though separated from its connexions, and likely to ulcerate or slough,—is yet left open to the stream of recurrent blood,) a second ligature were placed at the distal limit of the endangered part, there would seem no greater reason to anticipate the occurrence of secondary hæmorrhage than when arteries are tied after an amputation.

3. *Anomalous arrangement* of the cervical vessels is a contingency which the surgeon must bear in mind. Most of these are comprehended in the abnormalities of the arch already described. (See *AORTA*.) The existence of a median inferior thyroid artery, derived from the arch, or from the arteria innominata;—the irregular passage of the right subclavian artery from the left side, behind the œsophagus, or between that tube and the trachea;—an early division of the carotid, even to nearly the level of the sternum, or so late a one, that the common trunk furnishes many, or most, of the branches normally originating

from the external;—the absence of an arteria innominata, its branches arising separately from the arch, or in irregular combination with those of the left side; the occasional origin of the vertebral from the common carotid,* are the deviations which it most behoves the practitioner to remember.

4. Certain veins in the neck have an anatomical disposition, rendering them liable, when opened in surgical operations, to become channels for inspiration of air to the cavities of the heart, the fatal tendency of which is well known. The internal jugular, innominata, and subclavian veins are, as M. Bérard notices, “at the root of the neck, so firmly united by fascial laminae and cords to the adjacent bones and muscles, that they do not collapse on division, but gape:” and it is obvious that this circumstance (but for which they would be flattened, and rendered impervious, by the atmospheric pressure on their outward surface) must expose them remarkably (perhaps alone) to a dangerous participation in the *inhaustive* movements of breathing. M. Velpeau (who has written a paper of excellent critical research on the subject†) recommends the following precautions in approaching veins of the nature described (*veines canalisées*): studiously to avoid wounding them,—to detach no deeply fixed tumour from its adhesions, without having previously commanded the vessels at its base,—and to maintain no unnecessary tension on the fasciæ, by forced positions of the shoulder.

For the *BIBLIOGRAPHY* see that of *ANATOMY* (*INTRODUCTION*), and the references under the various articles referred to. One work may be particularized, as belonging to the region, and as having, more than any book of the age, given an impetus to the study of anatomy in that most practical form, which interests the surgeon by unfolding the relations of disease and of operative measures. Through the happy combination referred to, the mere barren description of regions has become *surgical anatomy*; and to Dr. Colles of Dublin, and Allan Burns of Glasgow, belongs the merit of having, first in this country, illustrated that natural connexion, which gives to anatomy the interest of application, and to practice the security of knowledge.

(John Simon.)

NERVOUS SYSTEM.—In proportion as our knowledge of the intimate texture of animal and vegetable organisms advances, the doctrine gains ground that many of the phenomena, called vital, are to be attributed to the special endowments of distinct forms of animal or vegetable matter; distinct as regards their anatomical characters as well as their chemical composition; distinct, therefore, as

* A single instance has occurred to me in the dissecting-room, of an arrangement, which I believe to be very rare. An innominata (for so its origin and course entitled it to be named) divided at the sterno-clavicular joint into common carotid and vertebral: the right subclavian arose from the descending part of the arch, and directed itself to the scalene space by passing behind the œsophagus.

† Médecine Opératoire; and Lettre sur l'Introduction de l'Air dans les Veines. Paris, 1838.

regards their physical properties; and, as appears not unreasonable to conclude, capable of manifesting a distinct series of vital forces.

If great strength and power of resistance be requisite, a particular form of animal matter (gelatine) is united with an earthy material to constitute bone; for the development of strength, combined with elasticity or flexibility, this same kind of animal matter, or a modification of it, is again employed, containing none or a very slight proportion of earthy material, and forming the various kinds of cartilage and ligament; but for the play of the active powers of life—for the development of living movements—whether in the performance of the nutritive functions, in growth and reproduction, or in the display of muscular force and activity, two substances, the most complex in chemical constitution of any in the body, and possessing the greatest atomic weight, are made use of to form the structures, on which these remarkable phenomena depend, namely, *muscle* and *nerve*. These structures are composed respectively of fibrine and albumen; they are organized in analogous forms, and by their mutual reactions they exhibit the marvellous effects which animal power is capable of producing.

GENERAL OBSERVATIONS ON THE DISPOSITION AND COMPOSITION OF THE NERVOUS MATTER, THE NATURE OF NERVOUS ACTIONS, AND THE SUBDIVISIONS OF THE NERVOUS SYSTEM.

The nervous matter presents the singular peculiarity that it alone, of all the varied forms of animal texture, is directly influenced by the mental acts of animals. It is that part of the organism through the immediate agency of which mind operates upon body and body upon mind. Through this connexion with the psychical principle of the animal, sensation is produced, and volition is enabled to exercise its influence on muscular organs. And in the whole range of the mysterious phenomena, which the student of nature meets with, there is nothing so inscrutable as the fact that the workings of the mind can disturb and impair the organization of the nervous matter; or, on the other hand, that the disorganization of the nervous matter is capable of deranging mental manifestations.

The existence of this remarkable and peculiar kind of organic matter is limited to the animal kingdom, and is therefore one of the characteristic features of animals as distinguished from plants. It is obviously the presence of a psychical agent controlling and directing certain bodily acts of animals, which has called into existence the particular apparatus which the nervous matter is employed to form.

In the largest proportion of the animal kingdom, the nervous matter is so disposed or arranged as to form a system complete in itself, and distinct from, although connected with, the other textures and organs. This is called the NERVOUS SYSTEM—the development of which has always a direct relation

to the bodily organization and psychical endowments of the animal.

The nervous matter is accumulated into masses, forming what are denominated CENTRES of nervous actions; and it is also developed in the form of fibres, filaments, or minute threads, which, when bound together, constitute the NERVES. The latter are *intertunical* in their office; they establish a communication between the nervous centres and the various parts of the body, and vice versa; they conduct the impulses of the centres to the periphery, and carry the impressions made upon the peripheral nervous ramifications to the centres. Nor are the nerves mere passive instruments in the performance of their functions; but produce their proper effects through their susceptibility to undergo molecular change under the influence of appropriate stimuli.

The centres are the great sources of nervous power; they are the laboratories in which the nervous force is generated. The mind appears to be more immediately connected with one of them, which, pre-eminent on that account, exerts a certain control or influence over its fellows.

In the centres there are two kinds of nervous matter, distinguished by certain anatomical characters and by certain physiological properties and uses. The one is globular or vesicular in structure, grey in colour—*dynamic* as regards office. The other is fibrous, its fibres being tubes containing nervous matter; it is white in colour, and is devoted to act as a *conductor* of impulses to and from the grey matter. The white matter is that of which the nerves are composed, and the two kinds of matter do not occur together any where but in the nervous centres; in fact, their co-existence in any part of the nervous system is sufficient to constitute that part a centre of nervous action.

In the lowest creatures the existence of nervous matter is as yet problematical. It is supposed by some physiologists that it is diffused in a molecular form throughout the body of the animal, and the muscular tissue being likewise disposed in a similar way, the one may act upon the other at every point. Were this supposition true, it might be further conjectured that, under such circumstances, only one kind of nervous matter, *the dynamic*, would exist; for as the office of the white nervous matter is chiefly to propagate or conduct to distant parts the changes which originate in the grey matter, the former would not be required in animals, in which the elements of the grey matter are in contact with those of the other textures at every part of the body.

The form in which nervous matter first develops itself as a distinct tissue is in that of threads or cords, into the composition of which areolar tissue and bloodvessels generally enter. The class of animals in which this arrangement prevails has been designated by Mr. Owen *Nematoneura*; and, in many of these at least, the existence and the disposition of grey matter have yet to be ascertained.

The nervous matter of both kinds is a sub-

stance of extreme softness and delicacy, liable to break up under the least pressure; the nervous tissue owes much of its physical tenacity to the other tissues which are associated with it, and to the numerous bloodvessels which play among its elements.

The chemical composition of this matter has been an object of investigation with several observers, but it is remarkable that few comparative analyses of the two kinds of nervous matter have been made with a view to determine on what the differences between them depend; and, indeed, such an analytical investigation is as yet a great desideratum. The part which has chiefly been selected for analysis is the brain, in which doubtless both kinds of nervous matter were indiscriminately examined.

Among the earliest investigations of this kind were those of Leming; some time afterwards Thouret examined the brain; and still later Fourcroy. The last writer notices the large admixture of water with the cerebral substance, and points it out as one of those animal substances in which water exists in the largest proportion; from constituting, as it does, three-fourths or four-fifths, and in many instances seven-eighths of its weight. Vauquelin's analysis, made in 1812, gave a considerable insight into the true composition of the brain. This chemist showed that the cerebral substance is an emulsive mixture of albumen, fatty matter, and of water, the last holding in solution certain saline and other ingredients common to the brain with other parts of the body. By solution in boiling alcohol, Vauquelin was enabled to obtain the two constituents of the fatty substance, namely, the elaine and stearine (margarine). Vauquelin also recognised the presence of phosphorus in the brain. His analysis yielded the following result:—

Albumen	7.00
Cerebral fat	{ stearine . . . 4.53 } { elaine . . . 0.70 } . . . 5.23
Phosphorus	1.50
Osmazome	1.12
Acids, salts, sulphur	5.15
Water	80.00
	100.00

John, who specially analysed the grey nervous matter, states that it is deficient in fatty matter, and that its albumen is less tenacious than that of the white. And Lassaigue states that the grey substance is deficient in white fatty matter, but contains a greater proportion of red, 3.7 per cent. being the amount contained in the grey, and 0.9 per cent. in the white.*

Vauquelin remarks that the medulla oblongata and the medulla spinalis have the same composition as the brain, but contain a much greater quantity of cerebral fat, with less albumen, osmazome, and water.

M. Couerbe's elaborate analysis does not appear to be entitled to much confidence, since the

compounds into which he resolved the cerebral matter did not, on analysis, always present the same composition. This variation of elementary constitution he attributed to physiological differences in individuals.

The latest and apparently the most complete analysis of the brain is that by Frey, published in the *Annales de Chimie* for 1841. In the main his results agree with those of Vauquelin.

He states that the cerebral mass is formed, as had been already shown by Vauquelin, of an albuminous matter containing a great quantity of water, and which is found mixed with a peculiar fatty matter; and that these different substances exist in the following proportions, seven parts of albumen, five parts of fatty matter, and eighty parts of water.

The chemical examination of the albuminous matter yields nothing of importance. This substance is insoluble in water, in alcohol, and in ether. M. Frey's principal care has been to determine the composition of the fatty matter, and this he has endeavoured to do by an analysis of the brain in different animals, but principally in man.

His method of proceeding is, to cut the brain into small pieces, and to treat it with successive portions of boiling alcohol, leaving them for some days in contact with the spirit. The object of this is to remove from it its large quantity of water, which interferes with the action of ether upon it. The coagulated mass thus obtained is submitted to pressure, is divided rapidly in a mortar, and is then treated by ether, first cold and subsequently hot; the resulting fluids when submitted to distillation yield a viscid residue, which is called the ethereal product.

The principles which he extracts from the brain by this method, are—1. a white substance called *cerebric acid*; 2. cholesterine; 3. a peculiar fatty acid called *oleophosphoric*; 4. traces of elaine, margarine, and fatty acids. These principles are not always found in an isolated state; for the cerebric acid is often combined with soda or phosphate of lime; and the oleophosphoric acid is commonly found in the state of a salt of soda.

Cerebric acid, when purified, is white, and is in the form of crystalline grains. It dissolves without residue in boiling alcohol, is almost insoluble in cold ether, more soluble in boiling ether. It has the remarkable property of swelling up, like starch, in boiling water, but appears to be insoluble in that liquid. It enters into fusion at a high temperature, approaching closely that at which it is decomposed, and is combustible. It contains no sulphur, but some phosphorus. The result of its analysis by Frey is 66.7 per cent. of carbon, 10.6 of hydrogen, 2.3 of nitrogen, 0.9 of phosphorus, 19.5 of oxygen.

Oleophosphoric acid is separated from cerebric acid by its solubility in ether. It is still accompanied by elaine and cholesterine, which are withdrawn from it by alcohol and ether. This acid is of a viscid consistence, insoluble in cold alcohol, but dissolving readily in boiling alcohol; it is insoluble in ether. Placed

* Valentin Reper. 1837, p. 186.

in contact with soda, potass, and ammonia, it immediately gives soapy compounds. It forms compounds insoluble in water with other bases. M. Fremy has observed a remarkable transformation of oleo-phosphoric acid. When boiled for a long time in water or alcohol, it gradually loses its viscosity and becomes a fluid oil, which is pure elaine, while the liquor contains phosphoric acid. This decomposition becomes very rapid, when the liquor is rendered slightly acid. Although M. Fremy's attempts to form this acid directly, by uniting elaine and phosphoric acid, were unsuccessful, he still deems it probable that this acid may consist of the elements in question and be analogous to the compound of sulphuric acid and elaine, or sulph-oleic acid. It contains from 1.9 to 2 per cent. of phosphorus in the condition of phosphoric acid.

M. Fremy also finds, as Couerbe had previ-

	Infants.	Youth.	Adults.	Old Men.	Idiots.
Albumen	7.00	10.20	9.40	8.65	8.40
Cerebral fat	3.45	5.30	6.10	4.32	5.00
Phosphorus	0.80	1.65	1.80	1.00	0.85
Osmazome and salts	5.96	8.59	10.19	12.18	14.82
Water	82.79	74.26	72.51	73.85	70.93
	100.00	100.00	100.00	100.00	100.00

From these comparative analyses it appears that the *minimum* of phosphorus exists in infancy, in idiotcy, and in old age; and that the *maximum* of water is found in the infant. This latter fact is of practical interest, and affords some explanation of the greater tendency to liquid effusions in early childhood than in more advanced life.

Nervous actions.—In order to offer a clear explanation of the working of the nervous system, it will not be amiss to quote a few examples of actions effected through its instrumentality.

Let me, however, first remark, that as the mind is connected more especially with the nervous system, so that system becomes the channel of its mandates, as well as of impressions conveyed to it. But there can be no doubt that the nervous system can act independently of the mind, and that certain actions which need the intervention of nerves and nervous centres, are accomplished without the consciousness of the individual, and sometimes in spite of his Will.

It seems, therefore, a correct, as it is certainly a convenient arrangement of nervous acts, to divide them into those in which the mind is concerned, either as an agent or as a recipient, (*mental nervous acts,*) and into those which result from mere modifications in the nervous matter, quite independent of mental interference (*physical nervous acts*).

Let me illustrate this division by examples. Any ordinary act of the will, the voluntary movement of the arm for instance, is effected by a mechanism to which the first impulse is given by a change in the mind; I will to move my arm; this mental change affects the nerves of the arm, which excite certain muscles to act.

ously done, that cholesterine may be extracted from the brain in considerable quantity. He obtains it by boiling the ethereal product in alcohol rendered strongly alkaline by potass. A cerebrate, an oleate, and a phosphate of potass are thus obtained, with glycerine and cholesterine. On cooling, the alcohol deposits the cerebrate and phosphate of potass and the cholesterine; and in treating the deposit by cold ether, we remove all the cholesterine, which may be purified by subsequent crystallizations.

In preparations of the brain, preserved in spirits, a substance of crystalline character, which resembles cholesterine, is apt to form round the piece.

The quantity of phosphorus varies considerably in different periods of life, and is greatly diminished in idiotcy. The following table from some analyses of L'Héritié will illustrate this statement.

That the nerves are the channels for conveying this influence of the will is proved, beyond all doubt, by experiment and disease. If their continuity with the brain be injured, the power is necessarily lost, although the will itself continue unimpaired.

We *feel* through the instrumentality of the nerves. In writing, I am conscious, through the sensibility of my fingers, that I hold a pen in my hand. Were that sensibility destroyed, although the power of holding the pen remained, I should lose the consciousness of its presence between my fingers, and they would cease to grasp it. This sensibility is due to the communication of the nerves with the brain, for any solution of continuity destroys it; nor can any part be said to be *sensible* or to possess *sensibility* which does not communicate with the brain through the nerves. And various parts differ as regards the *degree* of sensibility which they enjoy, according to the number of nerves distributed to them, and perhaps also according to the manner in which the nerves are connected with them. A touch on the skin covering the olecranon is scarcely felt, whilst the finest point impinging with the slightest force on the skin of the tip of the finger is instantly perceived.

Sensations differ in *kind* as well as in *degree*. The power by which we are made sensible of contact, or by which, under the influence of undue stimulation, we become conscious of pain, is called *common sensibility*. Doubtless nearly all textures possess this to a certain degree. Tendon and cartilage enjoy a very much less amount of it than skin and muscle. But we can also appreciate the influence of light, of sound, of odor, of flavour, and we are enabled to do this by means of particular

nerves. This power is that of *special sensibility*. The nerves, which convey these impressions of special sensation to the mind, are incapable of responding in any other way, even to a mechanical stimulus. When the retina is stimulated with the point of a needle, the sensation of a flash of light is produced: when the auditory nerve is excited by a mechanical impulse upon the tympanum, sound is heard.

The mechanism (so to speak) of sensations of whatever kind is exactly in the reverse direction to that of voluntary motions. In the latter the change begins in the mind and ends in the body; in the former the impression is made first on the body and is conveyed to the mind. In both cases mental change, whether active or passive, is necessarily associated with the nervous act.

There are other actions in which the mind is concerned, although the *will* does not take any share in them. These are, such as may be produced under the influence of those sudden, momentary, and involuntary mental changes, which are called *emotions*, and which may be excited, either by an impression conveyed to the mind from some external cause, through the senses, or by some change in the mind itself, arising in the train of its thoughts. Who has not felt the thrill which pervades every part of the frame, in listening to some harrowing tale of woe? or, when the imagination, in its musings, conjures up before the mental vision some fearful scene of lamentation and wretchedness? How keenly do the emotions of joy and sorrow, anger and pity, cause themselves to be felt at every point of the system. The blush of shame, the pale curling lip of anger, "the eye in a fine frenzy rolling," are all examples of the emotions of the mind influencing bodily actions. The changes which the countenance undergoes in accordance with varying states of the mind result from the same cause. The will may acquire the power of controlling to a great extent this influence of emotion upon the expression of the features; but to attain this faculty in great perfection requires great strength of will and frequency of exercise. Few men ever acquired such controul over the play of the features, and such power of resisting the influence of emotion as well as of imitating that influence, as Garrick and Talleyrand.

The power of the emotions over the nervous system is shewn not merely in those actions which the will may controul, but also in others, which, as being in no degree voluntary, and therefore in a great measure disconnected from the animal functions, have been called *organic*. Upon none of these does emotion exert more influence than upon the circulation. In blushing, in the deadly paleness of the blood-deserted cheek, in the cold sweat of fear, in the depression of the heart from syncope, we find unequivocal instances of actions of an involuntary kind, produced by this influence. Many of the sensations which are felt in grief, fear, anxiety, or in the paroxysm of hysteria, are in a great measure due to local changes in the capillary circulation caused by the power of emotion over it. It would seem that there is

no part of the nervous system which mental emotion may not reach; and no fact of more general application than this, to the explanation of the multifarious forms of morbid sensation.

Of the physical nervous actions.—When the eyelid is raised so as to admit light suddenly to the bottom of the eye, the pupil instantly contracts, nor is the individual conscious of the change which is taking place in it, and he is equally unable to controul or prevent it. The degree of contraction appears to be proportionate to the intensity of the stimulus.

When a morsel of food is applied to the isthmus faucium, an action of deglutition is instantly induced. The palato-pharyngei muscles and the constrictors of the pharynx are immediately brought into play. This action is entirely involuntary, and cannot be controlled by the power of the will; it may be brought on even in the state of coma, when the individual is insensible to any external impression, and the fact is one of practical application, as shewing how persons in that state may be made to swallow by bringing the morsel into contact with the mucous membrane of the pharynx. Moreover it is an action which the will cannot imitate unless there be something to be swallowed. If the fauces be completely clear of any solid or fluid, this action cannot be performed; to call it into play, we instinctively bring mucus or saliva to the region of the fauces, and that stimulus brings about the required action. We have here, then, an instance of an action, which may take place despite of the will, which the will cannot imitate, which may be produced when consciousness and will are in abeyance: it is, therefore, an action independent of the mind's influence, and which may fairly be ascribed to a cause purely physical.

The sudden application of cold to the surface of the body or to any part of it, more especially to the face, causes an immediate and involuntary excitement of the muscles of respiration, and may be quoted as an instance of an action of similar kind to those mentioned in preceding paragraphs. The will may control this action to a limited extent, but never entirely.

A large number of movements in the living body, and especially of those which are commonly called *organic*, might be referred to as examples of physical nervous actions, in which the stimulus acts independently of the mind. These actions may be produced by a physical change taking place in the nervous centre and propagated directly to the muscular texture of the part (the moving power), as in the case of convulsive movements produced by irritant diseases of a nervous centre; but the ordinary manner in which they are effected is by the application of a stimulus to a surface. Through afferent nerves this stimulus affects the nervous centre, and produces a change there, which excites certain other nerves proceeding from that centre to the organ in which the movement occurs. To take, as an example, the act of deglutition above referred to. The morsel of food stimulates certain nerves, *the*

glosso-pharyngeal, which are freely distributed upon the mucous surface of the pharynx. This stimulus causes a change in the medulla oblongata, in which those nerves are implanted, and that change is propagated thence by the *pharyngeal branches of the vagus* to the muscles which contract the pharynx in the act of deglutition.

In such an action the change in the nerves by which the muscular contraction is excited must take place in a two-fold direction,—*first*, from the circumference to the centre, from the point of application of the stimulus to that at which the nerves become implanted in the centre; and, *secondly*, from centre to circumference, from the point at which the stimulus falls upon the centre to that where the nervous fibres mingle themselves with the muscles of the part to be moved. The stimulus, which is *incident* upon the nervous centre, is said to be *reflected* by it to the muscular textures, the immediate agents of the required movement. Hence Dr. Marshall Hall has proposed to distinguish a special system of *incident* and *reflex* nerves, or of *excito-motory* nerves, the former being *excitator*, the latter *motor*. This distinction, considered anatomically, is as yet quite hypothetical, for we have no unequivocal proof that the nerves of sensation and volition, which in their ordinary mode of action are *afferent* and *efferent* as regards the brain, may not be competent by the relation which they must necessarily bear to the spinal cord, to perform the actions which are thus assigned to a distinct system. The determination of this point depends more upon the solution of certain problems respecting the anatomical constitution of the nervous centres, than upon any purely physiological experiments. It will be made the subject of careful examination at a subsequent part of this article.

The great peculiarity of this class of nervous actions is their *independence of the mind*. An act of the mind forms no *necessary* part of their mechanism. At the same time there are certain of them which do not take place without the mind being conscious of the change. The act of deglutition above referred to, although quite independent of the mind, does not generally take place without being *felt*. But the change in the pupil, consequent upon the stimulus of light acting through reflex nerves upon the iris, is not at all perceived by the individual, and is therefore in every respect independent of mental change. Let it be remembered, then, that there are some physical nervous actions which the mind is not conscious of, and others of which the mind will always, or at least generally, take cognizance.

We may conclude this brief reference to nervous actions by the following classification of them:—

Psychical or mental nervous actions:—

Actions of perception.

Actions of emotion.

Actions of volition.

Physical nervous actions:—

Actions from a physical change originating in the nervous centre; as in disease.

Reflex actions—

a, with consciousness.

b, without consciousness.

Anatomical subdivision of the nervous system.—The nervous centres, as they are found in the Vertebrate series, are distinguished as the brain, or encephalon, the spinal cord (*medulla spinalis*), the ganglions. In the Invertebrata, the centres all bear the anatomical characters of ganglions, although, doubtless, they present some analogy in office to those specially distinguished among Vertebrata. Their arrangement varies considerably according to the differences of form of the various invertebrate classes.

The brain and spinal cord, and the system of nerves connected with them, constitute the *cerebro-spinal* portion of the nervous system, which Bichat distinguished as the *nervous system of animal life*, a distinction which, as it was dependent on his untenable hypothesis of the *two lives*, ought now to be discarded. The only subdivision of the nervous system which can be conveniently adopted must rest upon the basis of anatomy. There is not a sufficient distinctness of function in different portions of the nervous system to justify the separation of them on physiological grounds.

There are very numerous ganglions connected with the *cerebro-spinal* system. These are the ganglions on the posterior roots of spinal nerves, the ganglion of the fifth pair, those of the *glosso-pharyngeal*, and of the *vagus*. They are conveniently distinguished as *cerebro-spinal ganglions*.

A large portion of the nervous system is made up entirely of ganglions, with their connecting cords and nerves, which ramify in a plexiform manner among various internal viscera and upon the coats of bloodvessels. In the vertebrated animals, where it is highly developed, it is disposed as a chain of ganglia on each side of the spine, and at the base of the skull, near the foramina, through which the spinal and encephalic nerves pass out; and at all these situations it forms a very intimate connexion with the nerves of the brain and spinal cord.

This portion of the nervous system exhibits many peculiarities referable to its composition, its mode of arrangement, and its connexion with the organs among which its nerves ramify, which, at least, entitle it to be considered apart from the *cerebro-spinal* system; and many go so far as to affirm its entire independence of that system, and to assign to it a peculiar action, different from that of the nerves connected with the brain and spinal cord. Bichat calls it the *nervous system of organic life*. Previous to his time it was known as the *great intercostal nerve* (*nervus intercostalis*), the *great sympathetic nerve* (*nervus sympathicus magnus*), and now it is very commonly described under the latter name. The term *visceral nerve* has also been proposed for it. It has also been distinguished as the *ganglionic system*. It is difficult to find an unexceptionable name for it which does not involve the adoption of some theory respecting its function. On the whole, the terms *sympathetic nerve* and *ganglionic system* are those which appear liable to fewest objections, although by

no means free from them, and they will be employed in the course of this article.

Such are the only subdivisions of the nervous system which anatomy appears to warrant. Others have been proposed; but as they are founded upon physiological opinions which are as yet hypothetical, it is unnecessary to discuss them at present.

Having thus given a brief and general account of the nervous system and of nervous matter, we proceed to consider the anatomy and physiology of this system under the following divisions:—I. THE GENERAL ANATOMY OF NERVES. II. THE COMPARATIVE ANATOMY OF THE NERVOUS SYSTEM OR ITS DISPOSITION THROUGHOUT THE ANIMAL KINGDOM. III. THE ANATOMY OF THE NERVOUS CENTRES, THE GANGLIA, BRAIN, AND SPINAL CORD. IV. AND LASTLY, THE OFFICE OF THE NERVOUS SYSTEM AND THE FUNCTIONS OF ITS VARIOUS PARTS.

NERVE.—(*νεῦρον, nervus; Germ. nerve; Fr. nerf.*) The nerves perform the *internuncial* office in the nervous system by maintaining communications between the various organs and tissues and the nervous centres. They are bundles of threads of various size, surrounded by sheaths of membrane, with more or less of areolar tissue interposed.

The nerves of the cerebro-spinal system and of the great sympathetic exhibit such different characters as regards their anatomy, that they may be examined separately.

Cerebro-spinal nerves.—In examining a cerebro-spinal nerve, we find it invested by a sheath of membrane, which has adherent to its inner surface thin layers of areolar tissue which pass, like so many partitions, between the threads or fibres of which the nerve is composed. This sheath is commonly called the *neurilemma*; it is analogous to the sheath which surrounds muscles. Its office is chiefly mechanical, namely, that of binding the constituent fibrillæ and fascicles of the nerve together, so as to protect them and to support the delicate plexus of capillary bloodvessels from which they derive their nutriment.

The neurilemma is composed of fibres of the white fibrous kind. It exhibits to the naked eye the appearance of a fibrous membrane, white and almost silvery; and its microscopic characters are those of the white fibrous element, although not presenting much appearance of wavy fibres. The fibres are, for the most part, parallel to the axis of the nerve; but there are some which cross the nerve at right angles, or appear to pass spirally round it. The septa between the secondary bundles of the nerves seem to consist of a less perfect fibrous tissue, containing the remains of numerous cytotlasts. A yellow fibrous tissue of the finest kind exists here in very small quantity.

The bloodvessels are distributed upon the external investing sheath and upon the septa. In some of the large nerves, the sciatic for example, these may be often seen minutely injected with blood. They are disposed somewhat similarly to those of muscles, running

parallel to the fibres and fascicles of the nerve. The capillaries are among the smallest in the body; they form oblong meshes of considerable length, completed at long intervals by vessels which cross the fibres of the nerve more or less in the transverse direction. Henle assigns to them, when empty, a diameter not exceeding $\frac{1}{5000}$ th of an inch. These bloodvessels are generally derived from neighbouring arterial branches; sometimes a special vessel accompanies a nervous trunk, and even perforates it, passing along its central axis, as is well known to descriptive anatomists in the sciatic and the optic nerves.

After the external part of the neurilemma has been dissected off, the nerve may be torn by needles and divided into secondary bundles and fibres. The ultimate fibre can then be readily distinguished by the aid of the microscope, from its being incapable of further subdivision by mechanical means; and an accurate knowledge of its structure is of the utmost importance to the formation of correct opinions respecting the actions of the nervous system.

The ultimate (or, as it is also called, the primitive) nervous fibre, is a tube composed of a fine transparent homogeneous membrane, in a great degree resembling the *sarcolemma* of muscle. It is elastic, like that membrane, perfectly homogeneous, and, according to Schwann, in young nerves has the nuclei of cells connected with it. It may be called the *tubular membrane* of nerve (*a*, *fig.* 329). The contents of this tube consist in a soft, semifluid, whitish, pulpy substance, which is readily pressed out of its cut extremity. In the nerve that is quite fresh, having been taken from an animal just dead, this pulpy matter is quite transparent and apparently homogeneous. The tube membrane presents the appearance of a delicate line, resem-

Fig. 329.

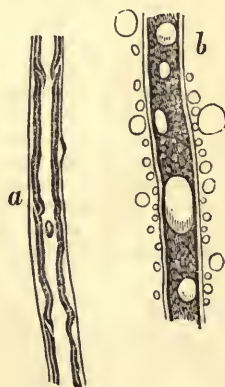

Nerve tubes altered by re-agents.

a, tube altered by water. The light external line is the tubular membrane; the dark inner double-edged one, broken here and there, is the white substance of Schwann. *b*, shows the change produced by the action of ether on the nerve-tube of the common eel; several oil globules have coalesced in the interior, and others have accumulated around the exterior of the tube.

bling, when perfectly fresh and unaltered by re-agents, the margin of an oil globule. When the nerve-tube has been treated with water, or has been allowed to remain a little time on a piece of glass, we observe within the tubular membrane a double-edged layer of a whitish material of different refracting power from either that which occupies the centre of the nerve-tube or the tubular membrane itself. The later after death the nerve is examined, the more distinct does this inner layer become. The addition of water, alcohol, and other re-agents always renders it more evident, and seems to destroy the apparent homogeneity of the pulpy contents of the nerve tube. This layer within the tubular membrane is that which, according to Schwann, gives to the nerve-tubes their white colour; it is therefore called by him *the white substance*. Within this and occupying the centre of the tube is a transparent, somewhat flattened, band, which is extremely delicate, and in which it seems impossible to recognize any more definite structure.

Thus Remak and others describe three distinct parts in the nerve fibre:—1, the outer investing membrane, *tubular membrane*; 2, an inner layer of membrane (*the white substance* of Schwann) lying immediately within the first; 3, a central substance of nervous matter, called *flattened band* by Remak, and supposed by him to consist of several filaments, or the *axis-cylinder* of Rosenthal and Purkinje.

It is evident that the contained matter of the nerve-tube is extremely soft: it yields under very slight pressure, and may be readily made to pass from one part of the tube to another. When pressed out of the nerve tube, it is apt to assume the appearance and form of globules varying in shape and size, which are easily distinguished from the true nervous globules by the absence of nucleus. Firm pressure will also completely empty the tubular membrane, and thus afford us a good opportunity of examining its structure, which has always appeared to present the same homogeneity as the *sarcolemma* of muscles to which we have compared it. Some observers, however, admit a complexity of structure in this tubular membrane; an appearance of longitudinal fibres has been noticed by Valentin and Rosenthal, and the former describes a fibrous arrangement, as of oblique fibres winding in opposite directions, surrounding the tube.*

The addition of water causes the contents of the tubular membrane to separate from the inner surface of the tube, owing to a shrivelling or coagulation which it excites in the nervous pulp. Alcohol produces a similar effect, but occasions a more perfect coagulation of the soft nervous matter; and it is particularly worthy of observation, that the complication of structure remarked by various observers and above described, in the tubular membrane as well as in its contents, is never seen in the perfectly fresh nerve, but is always rendered visible by keeping or by the influence of various re-agents. And

* The spiral arrangement of fibres described by Barry is attributed by him to the membranous layer which forms within the tubular membrane, the white substance of Schwann.

this fact may well excite a doubt as to the reality of the complex structure of the nerve-tube, as described in the preceding paragraphs.

In a word, the real structure of the primitive nerve fibre appears to be a tube composed of homogeneous membrane, containing a delicate, soft, pulpy, semi-fluid and transparent medulla or nervous substance, which is readily disturbed by manipulation, and altered by the addition of the simplest substances—even water. The tubes when quite fresh are perfectly cylindrical; but pressure or separation alters them in shape likewise, probably by disturbing the position of the nervous matter, pushing more than is natural into one part, and consequently diminishing the bulk of the contents of another part: the latter will consequently collapse, and the former become enlarged, distended, and even varicose. (*Fig. 330.*) The margins of nerve-tubes that have been separated, for this reason constantly appear wavy, and at other times distinct swellings or enlargements form in the course of the fibre, separated by constricted portions. These swellings sometimes occupy one side of the tube only: in shape they are globular or ovoidal, and more frequently involve the whole tube; they exist at irregular intervals

Fig. 330.

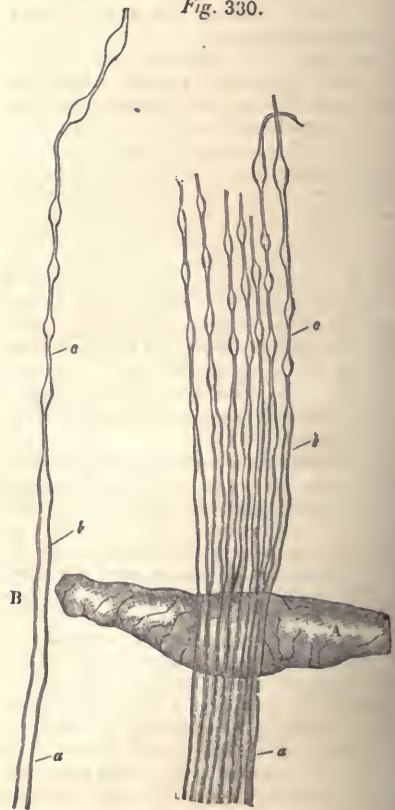

A, Nerve tubes becoming varicose at their entrance into the spinal cord. At *a, b, c* the gradual diminution of the thickness of the wall is seen. B, A single nerve tube, cylindrical at one part, varicose in the rest. (From Valentin.)

from each other, and are extremely variable in shape and size. Two conditions appear to favour the production of this varicose state of the nerve-tube,—namely, a feeble power of resistance in the tubular membrane, and, secondly, perhaps, a semi-fluid state of the contained nervous pulp; and hence we find that some nerve-tubes are much more prone to become *varicose* than others. In the nerves of pure sense the tubes are very delicate in structure and very apt to exhibit this change of form, and in the brain and spinal cord they exhibit the same tendency. Ehrenberg supposed formerly that these varicosities were natural and existed during life, and that they afforded a valuable morphological character of the nerves of pure sense and the cerebro-spinal centres. But many circumstances favour the opinion that the varicosities are accidental; thus, the very irregularities above noticed in their shape, size, form, and number on a single tube are not likely to occur in the natural state. Moreover, in a piece of the brain or spinal cord not much pressed nor torn, the cylinders may be distinctly seen: even in the manipulated specimens the varicose tubes form only a small portion of the whole. And in those nerves whose fibres are not prone to become varicose, such as muscular nerves, they may be made so by firm pressure and violence in manipulation. In the nerve-tubes of young animals, in whom the tissues are more tender and contain more abundant water, these changes are also very apt to take place.

A cerebro-spinal nerve, then, consists of a congeries of fascicles or bundles of the nerve-fibres or nerve-tubes (and we shall use these terms synonymously) above described, enveloped and bound together by fibrous membrane, the nerve-sheath. The nerve-tubes lie side by side, parallel, and sometimes have a wavy course within the general sheath (*fig.* 331). The relation of the nerve-tubes to each

Fig. 331.



Diagram to illustrate the wavy course of the nerve tubes within the neurilemma.

other is simply that of juxta-position. All observers, from Fontana down to those of the present day, agree in denying the existence of any inosculation or anastomosis between the fibres in vertebrate animals; and it seems almost certain that this complete isolation of the nerve-tubes is not limited to those of the nerves, properly so called, but may be observed in the nervous centres also. When a piece of nerve is examined on a dark ground, as an opaque object, with an object glass of a quarter of an inch focus, the disposition and relation of its component tubules are more beautifully seen than by any other mode of examination. The primitive fibres present the appearance of a series of transparent tubes, containing an exquisitely delicate, soft, pearly-white material.

In point of size the nerve tubes present considerable variety even in the same trunk, while they maintain an identity of structure. The smallest tubes have very delicate walls, and are more easily rendered varicose than the larger ones. The following table gives a statement of the results of the admeasurement of the cerebro-spinal tubules in Man and other Vertebrata.

Man, and other Mammalia, from $\frac{1}{1223}$ to $\frac{1}{8550}$ of an inch.

Birds, $\frac{1}{3000}$ to $\frac{1}{3000}$ of an inch.

Reptiles, Frog, $\frac{1}{1260}$ to $\frac{1}{3280}$ of an inch.

Fish, Eel, $\frac{1}{1043}$ of an inch.

Codfish, optic nerve, $\frac{1}{850}$ of an inch.

It has already been remarked that no such thing as subdivision or branching of the primitive tubules takes place in the cerebro-spinal nerves of the vertebrate series. Whatever be the connection which each primitive tubule forms with the nervous centre, or with the textures to which it is distributed at its periphery, it passes from one point to the other without any change, save perhaps in size, and without any communication with neighbouring tubules, beyond simple juxta-position, or investment by a common sheath. This fact was recognized by Fontana, whose description of the structure of nerve, although drawn up from observations made at a great disadvantage through the imperfection of his instruments, corresponds in all essential particulars with modern observations.* And as there is the same absence of subdivision in the continuations of these nerve-tubes in the nervous centres, we may fairly infer that each point on the periphery which is in contact with a nerve-tube, is, as it were, represented by that same nerve-tube in the centre.

The structure of the cerebro-spinal nerve admits of an obvious comparison with that of the striped muscle. Both are composed of bundles of fibres, united by a sheath, which also passes between the bundles, and is a nidus for the support of the nutrient vessels. Both admit of being subdivided into primitive fibres, which are very analogous in structure. The primitive fibre of muscle (*primitive fasciculus* of some authors) consists of the true muscular tissue, or sarcois elements contained in a transparent sheath of homogeneous elastic membrane called *sarcolemma* by Mr. Bowman. The peculiar morphological characters of the primitive fibre depend upon the arrangement of the sarcois particles within this transparent tube; and to this arrangement is due any further subdivision of which the primitive muscular fibre may be susceptible. So is it with the primitive nerve-fibre: its *tubular membrane* is strictly analogous in structure and other characters with the sarcolemma. It contains the elements of the true nervous tissue or *neurine*, and this admits of a certain subdivision which may be rendered more apparent under the influence of reagents, and which is variously interpreted by different observers, and has been compared to

* Fontana sur le venin de la vipere.

the separation which takes place in the fat cells between the solid and the fluid elements of fat. As the combination of the primitive muscular fibres, in a common sheath, forms the muscle, so the union of the primitive nervous fibres, in a similar way, forms the nerve. And as the primitive fibre of muscle passes undivided from one point of the muscle to another, so the nerve tube exhibits no subdivision in its course.

Branching of nerves.—The main trunk of a nerve breaks up into its component bundles, as it passes from centre to periphery, yielding up branches to the various parts it is destined to connect with the nervous centre. These branches generally come off at acute angles, and soon plunge into the muscles and other parts to which they tend, dividing and subdividing as they proceed. Such is the most common mode of subdivision, but there are many exceptions: sometimes a branch separates from the parent trunk at an acute angle, and then turns to run in an opposite direction, forming an arch, from the convexity of which several branches are given off. Such a nerve is said to be *recurrent*; the inferior laryngeal nerve takes this course. The anastomotic arches between the emerging spinal nerves, round the vertebral laminae, are also exceptions to the separation at acute angles.

Before a branch separates, it often happens that the parent trunk presents an enlargement for some distance above the point of visible separation. This is due to the fact that the fibres which compose the future branch begin to loosen their connection with the trunk for some way before they actually leave it; and the connecting areolar membrane becomes consequently looser and more abundant. Hence the trunk of the nerve appears enlarged, without any increase in the number of its nervous elements. This may be well seen in the auricular nerve of the neck, as it winds upwards over the sterno-mastoid muscle.

Anastomosis of nerves.—In their branchings nerves subdivide, not only to pass immediately to their muscles or other distant parts, but also to connect themselves by certain of their filaments with other nerves, and to follow the course of the latter, whether onward or retrograde, peripherad or centrad, instead of adhering completely to that of the primary trunk. By these means, nervous filaments connected with very different parts of the brain and spinal cord become bound together in the same fasciculus, and a nerve is formed compounded of tubes possessing very opposite functions. The *anastomosis* of nerves thus formed differs very obviously from the more correctly named anastomosis of bloodvessels, for in the latter case the canals of the anastomosing vessels are made to communicate and their contents are mingled; but in the former the nerve filaments are simply placed in juxta-position. There is no fusion of the one into the other, no admixture of the pulpy contents of the nerve-tubes, which continue their course as perfectly insulated as if they were placed singly and had no connexion with others.

The simplest kind of anastomosis is that which occurs in the formation of almost every

spinal nerve. The anterior and the posterior roots of these nerves, emerging from different parts of the spinal cord, and possessing, as is now proved, very different functions, are united after passing through the dura mater, and bound together as one nerve; the component tubules being so completely intermixed that the future ramifications of the nerve may enjoy the double function derived from the diverse endowment of the originally component tubules.

And even in a nervous trunk thus formed there occurs a remarkable interchange of place between the component filaments, which are thereby made to decussate each other within the trunk of the nerve (*fig. 332*). Bichat says, "I amused myself one day in attentively following all the filaments of the sciatic nerve some distance

Fig. 332.

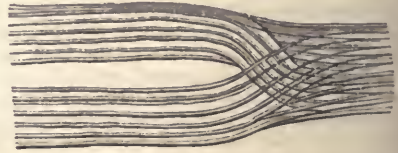

Diagram to show the decussation of the primitive fibres within the trunk of a nerve. (After Valentin.)

down the limb: those filaments which formed the exterior of the trunk above, I found, in greatest part, forming its centre below."* Kronenberg states that in some nerves these communications are so frequent that one cannot follow a single fascicle for any distance; whilst in other nerves, as the external cutaneous nerve of the arm, he found some bundles which passed through a distance of upwards of six inches without uniting with neighbouring ones. This is an anatomical fact of no mean importance, as applicable to the explanation of many apparently anomalous symptoms in neuralgic and other nervous affections.

A second form of anastomosis may be best explained by referring to that with which all who have made the superficial dissection of the neck must be familiar,—namely, the anastomosis of the descending branch of the ninth with the cervical plexus. Certain fibres, which pass from the medulla oblongata as part of the ninth nerve, leave that nerve as it crosses over the carotid artery, pass down in front of the artery, and apply themselves to a descending branch of the cervical plexus, forming in front of the carotid artery and jugular vein an arch with the concavity directed upwards, several nerves passing from the convexity to neighbouring muscles. A little careful dissection shows that some of the nervous filaments which are given off from the convexity are derived from the ninth nerve, and others from the descending branch of the cervical plexus; whilst others seem to form a complete arch and to be equally connected with both nerves. If we trace them from the ninth nerve, we find them passing upwards and backwards into the descending branch of the cervical

* Anat. Générale, t. i. p. 128, ed. 1801.

plexus, and so returning to the spinal cord. The nervous arch which is thus formed must evidently establish a communication between the cervical region of the spinal cord and that portion of the medulla oblongata whence the ninth nerve appears to arise.

We find in connexion with the optic nerve a remarkable example of this kind of anastomosis, which, as in the instance just mentioned, serves more to connect different portions of the nervous centre than to associate particular nerves. In the optic tracts of man three series of fibres may be distinguished, one which passes to the retina of the same side, another series which goes to the retina of the opposite side, decussating with the corresponding fibres from that side, and a third which passes from right to left, being apparently identified with or fused into one another at what is called the commissure, and forming a series of nervous arches, which serve to connect the opposite sides of the brain. These arches are convex towards the eyes and concave towards the brain. In the mole, in which I have failed to discover an optic nerve, this commissural band exists alone, the other two series of fibres being absent. Mr. Mayo has given a representation of these three sets of fibres belonging to the human chiasma in his admirable plates of the brain.

Volkman gives an account of several anastomoses of this kind which he distinguishes by the expression "verschmelzungen," to which that of "fusion" appears sufficiently to correspond. The fibres of one nerve appear as if they had been fused into those of an adjacent one, and thus return to some part of the cerebro-spinal centre different from that at which it had emerged. The instances cited by Volkman are as follows: 1. In the calf he has found an anastomosis between the fourth pair of nerves and the first branch of the fifth pair, forming an arch from the convexity of which several branches passed off in a peripheral direction. By far the greater part of these appeared, on microscopic examination, to receive their fibres from the fourth; while those fibres of the fifth which contributed to the formation of the nervous arch, passed centripetally to the brain, bound up in the sheath of the fourth nerve. 2. A similar nervous arch is found very generally among mammifera between the second or third cervical nerve and the accessory. Certain fibres, when traced from the former nerve, appeared to pass to the centre in the sheath of the latter. This anastomosis Volkman found in the human subject, and in horses, dogs, calves, and cats.*

Another example of this kind of anastomosis has been described by Gerber, but I am not aware whether his statements have been confirmed by other observers. This consists of one or more simple loops contained in one and the same neurilemma. Certain primitive fibres emerge from and return to the nervous centre, forming a loop, with convexity directed towards the periphery, without connecting themselves with any peripheral texture or going beyond the nerve-sheath. Gerber has disig-

nated these loops *nervi nervorum*, from a supposed rather fanciful analogy to the *vasa vasorum*.

Plexuses.—The plexuses are nervous anastomoses of the most complicated and extensive kind. Those which are connected with the spinal nerves are found in the neck, the axillæ, the loins, and the sacral region, and are well described by anatomists. There are also plexuses connected with the fifth nerve, the portio dura of the seventh, the glosso-pharyngeal, and the par vagum. Each plexus is formed by the breaking up of a certain number of nervous trunks, the subdivisions of which unite together to form secondary nerves, and these again, by further interchange of fibres, give rise to nerves which emerge from the plexus, and consequently in their construction may derive their fibres from several of the trunks that enter the plexus.

The object of the various kinds of anastomosis of nerves above enumerated appears to be to associate together nervous fibres connected with different parts of the brain or spinal cord. Thus nerve-tubes of different properties or endowments become united together in one sheath, forming compound nerves; and certain sets of muscles, instead of receiving their nerves from a very limited portion of the cerebro-spinal centre, are supplied from a considerable extent of that centre, and each muscle may probably receive nerves which arise in different and distant parts of the spinal cord or brain, an arrangement whereby remote parts of those centres may be brought into connection with neighbouring muscles or other parts, or even with a single muscle.

Origin of nerves.—The connexion of a nerve with the nervous centre is called by descriptive anatomists its origin. The determination of the exact nature of this connexion is of the last importance to the adoption of a correct theory of nervous action. Yet but little is known upon this subject. The fibres of the nerves are continuous with some of those fibres of the centre, in passing into which they experience considerable diminution of size and perhaps some change of texture, (see fig. 330, A,) as evinced by their much greater tendency to become varicose under mechanical means than we generally find in the nerves themselves. Thus far we may confidently assert, that *every nerve at its central extremity forms a connexion with grey matter*. This fact, proved by anatomy to be constant and universal, may be considered as a law of the morphology of nerve which has the most important bearing upon its physiological action. What is the precise nature of the connexion between the two kinds of nervous matter in the centres has not yet been determined. We can see the white nerve-tubes passing between the elements of the grey matter and the vascular plexus, in the meshes of which they are deposited; but whether they form any continuity of substance with those elements, or simply come into contact with them, has yet to be demonstrated. We shall recur to this interesting and important question in the article NERVOUS CENTRES.

Termination of nerves.—Under this term

* Müller's Archiv.

we describe the peripheral connexion of nerves with the various tissues and organs, and it is much to be regretted that our knowledge in reference to that connexion is scarcely more complete or accurate than that of their origin. The only instance in which we can speak pretty confidently respecting the peripheral connection of nerves, is with regard to muscles. In the striped muscle, nerves appear to form loops, the convexities of which are directed across the fibres of the muscles. Each nerve-fibre passes at first parallel to the direction of the muscular fibres, and then crosses them in an arched form to pass back into the bundle from which it had emerged, or to be mingled with the fibres of some neighbouring bundle, passing back in it to the centre, probably to some part of it different from the place of origin of the nerve. As far as present means of observation enable us to judge, there does not appear to be any other connexion between the nerve-tubes and the muscular fibres beyond the simple contact of the tubular membrane of the former with the sarcolemma of the latter. We have no evidence of any mingling of the true nerve-substance with the sarcous elements, and, therefore, we are forced to conclude that whatever be the nature of the influence which nerve exerts upon muscle to provoke it to contraction, that influence is exercised through the two layers of homogeneous membrane which form the investments of the nervous and sarcous elements respectively.

The best mode of observing the disposition of nerve in muscle is to examine under the microscope very thin and transparent muscles of some small animals. The abdominal muscles of the frog first afforded to Hales, and long after him to Prevost and Dumas, this opportunity; the muscles of the eyeball in small birds were used by Valentin; Burdach examined the muscles of the frog's tongue; I have found the intercostal muscles of the mouse very suitable for the purpose.

Peripheral expansion of nerves on sentient surfaces.—With regard to the disposition of nerves on sentient surfaces (the skin, for example) the most probable view appears to be that they are disposed in a plexiform manner. The nervous trunks pass toward the surface dividing and subdividing, the ramifications passing backwards to the centre in conjunction with neighbouring bundles; so that, whilst a very intricate plexus is formed, the looped arrangement, similar to that described in muscle, prevails, the convexities of the loops being directed towards the deep surface of the integuments. Gerber states, that in those parts of the skin which are provided with papillæ, the nerve-loops pass into the bases of the papillæ and form an element of their composition; and he adds, that in some instances the nerve-tube which forms the loop exhibits tortuosities or convolutions similar to those which are seen upon bloodvessels. According to the same author, in parts of the skin where the tactile sensibility is acute, the meshes of the nervous plexus are extremely small, whilst they are of large size where the skin is not highly sensitive.

The arrangement of the primitive fibres in loops has been seen by Henle on some parts of mucous membrane, in the membrana nictitans of the frog for example, and in the mucous membrane of the throat in the same animal. A similar disposition has been described and delineated by Valentin on the pulps of the teeth. (Fig. 333.)

Fig. 333.

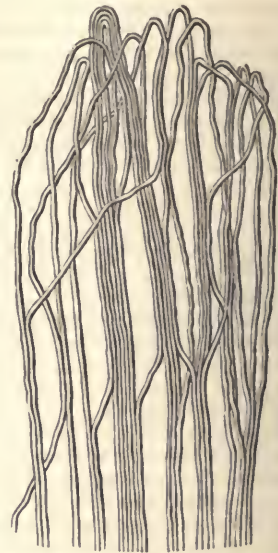

Terminal nerves on the sac of the second molar tooth of the lower jaw in the sheep, showing the arrangement in loops. (From Valentin.)

Retina and optic nerve.—The examination of the peripheral connexions of the nerves of pure sense has not thrown light on the general question. The peripheral expansion of the optic nerve or the retina presents all the elements of a nervous centre; the grey matter is present in it in considerable quantity, and certain fibres continuous with the primitive nerve-tubes are likewise expanded in it. But the connexion of these fibres with the grey matter has not been detected here any more than in the centres themselves, nor has any arrangement of looping or of plexuses been demonstrated. Mr. Bowman has been led, by recent examinations, to the opinion that these fibres are the central parts of the nerve-fibre (the bands of Remak) which have been deprived of the tubular membrane and of the white substance of Schwann. It is worthy of notice that the so called optic nerve itself presents certain peculiar characters, which entitle it more to be regarded as a prolongation of the nervous centre rather than as a distinct nerve. The nerve-tubes which are met with in it are for the most part of very minute size; they admit of separation with great difficulty, owing to their not being disposed in fascicles like those of other cerebrospinal nerves: they appear to be surrounded by and deposited in an abundant granular blastema, in which there seems to be some scattered elements of grey matter. These

characters, with the peculiar construction of the peripheral expansion, would induce me to regard what is generally described as the optic nerve as a process of the brain itself, around the peripheral portion of which a dioptric apparatus has been disposed in order to produce those refractions in the rays of light which are necessary to the formation of an image upon the retina. And my friend, Mr. Bowman, has been led to adopt a similar conclusion from examining the structure of the retina and optic nerve.

Olfactory nerves.—The true olfactory nerves are very numerous and pass from the bulb of the olfactory process or olfactory nerve of descriptive anatomists. The peculiar characters of this process, as distinguishing it from a nerve properly so called, have long attracted attention. In truth, this process has the characters of a portion of the brain in a much more obvious way than the optic nerve, for it contains a larger portion of grey matter which adheres as a distinct layer to the white matter, as in the formation of the convolutions; and, moreover, its anterior extremity or bulb contains a ventricle which may easily be demonstrated in a recent brain. It is from this bulb that the minute threads, which may be properly called olfactory nerves, take their rise and pass down through the foramina of the cribriform plate. Nothing satisfactory is known as to the disposition of the ultimate ramification of these nerves upon the Schneiderian mucous membrane. The statement of Valentin that they form loops similar to those of cutaneous nerves is probably correct. It is not improbable that the papillæ described by Treviranus were particles of columnar epithelium to which cilia are attached.

Auditory nerve.—The auditory nerve exhibits characters sufficiently distinct from the portio dura of the seventh, beside which it lies, to have led the anatomists of former days to separate it under the name of *portio mollis*. In fact, it possesses all the appearance of cerebral substance, and it wants the fasciculated disposition which mere nerves exhibit. Its fibres are delicate and very prone to become varicose, and, as in the case of the olfactory process, it passes out of the cranium, not as a trunk, but by means of several minute filaments of various size which pierce the foramina of the cribriform floor of the internal auditory foramen. Most observers express themselves in favour of the opinion that the terminal filaments are disposed in a looped form upon the membranous labyrinth and the cochlea. Valentin describes and delineates a plexiform arrangement, with loopings of some of the primitive fibres; others of them, however, he says, do not affect this disposition, but appear to have free extremities. And this description corresponds with that which Henle has given. This author states that from researches which he has made upon the lamina spiralis of mammifera and the ampullæ of the frog, he has no doubt of the existence of fibres which pass from one fascicle to another in a looped form; but he finds it difficult to determine whether all the tubes contained in each fascicle form similar loops. Wagner delineates the looped arrangement, and Pappenheim adopts the same view. Mr. Wharton Jones states that

the tubular structure of the nervous filaments ceases among grains of nervous matter, arranged into a sort of expansion, (see ORGAN OF HEARING), and he denies the existence of an arrangement in loops. My own observation leads me to concur in this description; and I would add that there seem to be here, as in the retina, some elements of the grey nervous matter scattered among the primitive filaments. This fact did not escape Valentin, for he remarks the existence of "very large globules" among the primitive fibres, similar to what he and Purkinje had noticed in the grey matter of the olfactory bulbs.* If this view of the peripheral expansion of the auditory nerve be correct, its analogy with the optic is very obvious; and it may be conjectured of the ear, as in reference to the eye, that around a process from the brain an apparatus has been organized fitted to transmit and modify sonorous undulations.

In the present state of observation we should not be justified in making any positive statement with reference to either the central or peripheral connexions of the nerves, beyond the following: that at the centres the grey and white elements are always associated, and that nerves may be truly said to arise out of grey matter; and that at the periphery, the nervous fibres, which in their progress from centre to circumference were bound together, become separated, and connect themselves, probably by intimate adhesion, with the elementary parts of the tissues and organs to which they are distributed.

Of the ganglionic nerves.—Without more exact information respecting the minute anatomy of these nerves, our knowledge of the peculiar function of the ganglionic system must be very incomplete. The following questions suggest themselves in reference to this system. 1. Are its anatomical characters sufficiently distinct from those of the cerebro-spinal system to warrant us in separating it from that system, if only for purposes of description? 2. Is it an independent system, as some have conjectured, giving fibres to the cerebro-spinal nerves as well as receiving some from them. 3. If it be an independent system, wherein consist the peculiar features by which its fibres are to be distinguished from those of cerebro-spinal nerves?

There are many features belonging to this system which justify its separation from that of the brain and spinal cord. The great number of ganglions connected with it, suggests the propriety of designating it *ganglionic* system, nor does the existence of ganglions on the posterior roots of spinal nerves render this appellation less proper; for in this system every nerve, nay every fibre, is connected with or passes through one or more ganglions. The external aspect of these nerves is very characteristic. Their neurilemma is very dense, and has more of the silvery appearance of white fibrous tissue than the sheaths of cerebro-spinal nerves; they want the fasciculated character of the latter nerves, and their colour has a diffused greyish or greyish red hue. The smaller ramifications are exceedingly delicate and appear to be soft,

* Valentin, über den Verlauf und die letzten Enden der Nerven, p. 63.

and therefore have been classed among the *nervi molles* by anatomists. In its peripheral distribution this nerve is prone to attach itself to the coats of bloodvessels, so much so, in fact, as to give it the character of an arterial or venous nerve; for, with a very few exceptions, it is always conveyed to organs along the bloodvessels which are distributed to them. In its distribution it is entirely or almost confined to the trunk, and probably has no connexion with the extremities; or, if it have, that connexion must be by very few fibres, and those attached exclusively to the larger trunks of bloodvessels. The peripheral ramifications of this nerve are always plexiform, and being distributed on some non-symmetrical parts, the plexuses which are derived from opposite sides of the body meet and anastomose along the mesial plane. The solar plexus, for example, derives filaments from the right and left trunks of the sympathetic, and the plexuses which accompany the superior and inferior mesenteric arteries, are also supplied from each side. Of the precise nature of these plexuses nothing is known: it is obvious, however, that their median anastomoses constitute a very peculiar feature, which strikingly distinguishes the sympathetic from the cerebro-spinal nerves, which do not anastomose along the mesial line. If in these anastomoses the looped arrangement exist, it might be conjectured to form a commissural connection between opposite and symmetrical portions of the sympathetic or of the brain or spinal cord.

To determine the independence of this portion of the nervous system on the brain and spinal cord, it would be necessary to shew either that it possessed peculiar fibres distinct in characters from the cerebro-spinal fibres, which originated in the ganglia, and were occasionally bound up with cerebro-spinal nerves, or that fibres belonging to the ganglionic nerves, although exhibiting no essential difference from the cerebro-spinal, had their origin from the ganglia and not from the brain or spinal cord. The present state of the investigations into this subject does not enable us to determine these points; but there can be no doubt that at least a large proportion of the fibres which compose the sympathetic exhibit no essential difference from those of the cerebro-spinal nerves.

When a portion of a sympathetic nerve is examined under the microscope, it is found to contain an unusually large quantity of white fibrous tissue, the fibres of which are arranged longitudinally. Crossing these are some fine circular fibres (of yellow elastic tissue) which are placed at some distance apart from each other. When the nerve is torn up by needles, numerous small oval cells may be seen among the fibres, their long axes being parallel to the fibres; these cells become much more visible when the fibrous tissue has been acted upon by acetic acid. They are scattered among the other elements of the nerve, and are probably persistent nuclei of the same kind as those which exist in muscle and other tissues. Numerous nerve-tubes are also seen entering into the formation of these nerves. These tubes appear to correspond in structure exactly with those

of the cerebro-spinal system; they present the same clear outline, and contain a semifluid pulpy matter, which is acted upon in a similar way by reagents as that in the nerve-tubes of the cerebro-spinal system. They resemble, however, the nerve-tubes of the brain or spinal cord more than those of nerves, for they are much smaller and more delicate than the latter, and more prone to form varicosities. They lie side by side of each other as in other nerves, and do not inosculate. The number of these nerve-tubes seems to vary in different parts of the sympathetic, apparently without regard to the size of the nerve, so that a small nerve may contain several nerve-tubes, while a large one contains but a few. In the abdominal ramifications the nerve-tubes are very numerous, and also in the cardiac nerves, while the sympathetic trunk in the neck contains but a few, which are situated quite in the centre of the nerve.

So far all observers appear to agree in their statements respecting the elementary composition of this nerve, and so far its intimate structure justifies the opinion that in its functions it must be intimately connected with the cerebro-spinal nerves. A coarser anatomy had already taught us that this nerve has extensive communications with the cerebro-spinal system, with all the encephalic nerves, excepting those of pure sense, and with all the spinal nerves by their anterior and posterior roots. It is now evident from microscopic observation that the object of these communications must be to enable cerebro-spinal nerve-tubes to pass into the sympathetic system; and, in short, that these communications may be regarded as so many origins of the sympathetic from the brain and spinal cord.

It remains to inquire whether there is any good foundation for the doctrine that the sympathetic nerve contains distinct and peculiar fibres, (*grey fibres* of some authors,) which are independent of the brain and spinal cord, and which by anastomosing with cerebral or spinal nerves may confer upon them, to a certain extent, the peculiar endowment which is supposed to characterise the nerves of the former kind.

Retzius and Müller appear to have been the first to put forward distinctly the opinion that certain cerebro-spinal nerves received particular fibres from the sympathetic, as the latter received filaments from the former. And Müller* suggested that both the ganglionic and the cerebro-spinal nerves should be looked upon as compound in structure; "that the ganglionic nerves contain motor, sensitive, and organic fibres, of which the latter kind alone have the power of regulating the vegetative processes, and have a special relation to the ganglia; that the cerebro-spinal nerves are likewise composed of motor, sensitive, and organic fibres, of which those of each kind have their specific destination, and run their course together without uniting with the others; that the ganglionic nerve consequently differs only in having numerous ganglia, and in containing a large number of grey fibres, which give it a proportionally greyer colour; while,

* Müller's Physiology, by Baly, p. 710, 2d edit.

in the cerebro-spinal system, the grey fibres are less numerous, and are seen as grey fasciculi lying in the larger mass of white fibres."

Neither Retzius nor Muller has given a clear description of these organic fibres as seen by them. Muller quotes and adopts Remak's account of the microscopic examination of these fibres. "They are," according to the latter anatomist, "much more minute than the cerebro-spinal fibres; they are perfectly homogeneous, that is to say, not composed, as far as can be distinguished with the microscope, of a tube and contained portion; and are so pale and transparent that in a strong light they are not visible; lastly, a completely characteristic appearance is produced by the small roundish or oval bodies which here and there beset their surface." They are almost gelatinous in their nature; they have on their surface the appearance of fine longitudinal lines, and are easily resolved into very fine fibres.*

Schwann seems to confirm this description, and to regard the organic fibre as a less perfectly developed state of the nerve-tube of the cerebro-spinal system.

Henle in his description of the grey or soft nerves gives the following account of these fibres (fig. 334). They are flat fibres, very clear, of homo-



Fig. 334.

Gelatinous nervous fibres from a soft nerve in the Calf (from Henle.)

- A, fibre resolving itself into fibrillae.
- B, A fibre doubled on itself, shewing the flattened character.
- C, Two fibres lying in juxtaposition.
 - a, a, a, nuclei.
 - c, a nuclear fibre (*Kernfaser*.)
 - d, a fibrilla.

geneous appearance, in diameter from 0.002 to 0.003 of a line ($\frac{1}{8000}$ th to $\frac{1}{1000}$ th of an inch), with numerous nuclei of cells, round and oval, most of them laid flat, and arranged at nearly equal distances, many presenting regular nucleoli, and pointed at their opposite poles. Their longest diameter is generally parallel to the longitudinal axis of the nerve. Sometimes one of these fibres resolves itself into more delicate fibrillae, resembling the primitive fibre of cellular tissue. Acetic acid dissolves them, and leaves the nuclei untouched. Henle admits that the greyish colour of the nerves depends on the quantity of these fibres; the greater the

number of nerve-tubes, the more the bundle resembles an ordinary cerebro-spinal nerve. In the roots of the sympathetic the number of the grey fibres is in large proportion, there being four to six of them for one nerve-tube, so that each nerve-tube appears surrounded by the nucleated fibres.*

Valentin, who admits the existence of fibres of a similar kind to those described by Henle, maintains that they are continuations of the sheaths of the globules which exist in the ganglia, and which are prolonged from them into the nervous trunks, and they serve as an envelope or protecting sheath to the cerebro-spinal nerve-tubes. Henle, who had formerly regarded these fibres as nerves distributed to the contractile cellular tissue and to vessels, ("the slight development of the nerves of these tissues seeming to correspond to the imperfection of their contractile power,") now expresses great doubts as to their nature and office, and proposes to call them *gelatinous nervous fibres*; "a name," he says, "which has no other end but to designate their presence in certain nerves, in the same way as we continue to call the fibres of cellular tissue, which are met with in tendons, tendinous fibres."

Müller conjectures that they may serve the purpose of establishing a communication between the ganglia; in short, that they are so many commissures between these centres.†

Purkinje and Rosenthal describe the organic nerve-fibre as the same as the central axis of the cerebro-spinal nerve-tube deprived of its investing membrane, and from comparing the sympathetic fibres with the cerebro-spinal fibre in the young embryo, they state their opinion that the latter, in an early stage of development, is identical with the former, but they do not appear to recognise, as Remak did, any continuity between these organic fibres and the ganglionic globules.‡

Volkman and Bidder have lately put forward an examination of this question; and these observers maintain the existence of a series of fibres peculiar to the sympathetic and distinct from those of the brain and spinal cord. Their work, however, contains many statements so much at variance with those of preceding writers, and with what I have myself seen, that I am led to entertain a strong suspicion that there must have been some fallacy affecting their observations throughout.

The sympathetic fibre, according to these writers, differs from the cerebro-spinal fibre in the following particulars; it exhibits at its margin a single contour, instead of the double one which is so constant a feature of the cerebro-spinal fibre, especially when examined some time after death; the distinction between a containing tube and the pulpy contents is not manifest; the fibre has sometimes a greyish aspect, which the authors regard as independent of any admixture with material foreign to that of the nerve-fibre itself; it is much smaller than the cerebro-spinal fibre, nearly one-half; in the cerebro-spinal as well as the sympathetic

* Müller's Physiology, translated by Baly, p. 720, and Remak Obs. anat. et microscop. de system. nervos. structurâ.

* Henle, Allgemeine Anat.

† Archiv. 1839, p. ccv.

‡ De Formatione granulosâ, Vratislav. 1839.

nerves both kinds of fibres may be found, but in the latter these peculiar fibres are enormously predominant, so that $\frac{1}{100}$ ths of their elements, or even a larger proportion, are composed of them; in passing into neighbouring trunks they run as often centrad as to the periphery. When the sympathetic fibres occur in cerebro-spinal nerves, they are collected into separate bundles. The nervous branches which go to the involuntary muscles contain almost exclusively the smaller or sympathetic fibres. Mucous membranes are almost exclusively supplied by these fibres. The viscera of the chest and abdomen receive nerves which are made up almost exclusively of sympathetic fibres.

[These statements are quite at variance with the results of my observations, as well as of those of Henle and Valentin.]

The authors remark a considerable difference as regards the relation which these peculiar fibres bear to the cerebro-spinal centres in Frogs, Mammalia, Birds, and Fishes. In frogs the fine fibres originate in greatest part from the ganglions on the posterior roots of spinal nerves and from those of the sympathetic. In Mammalia the brain and spinal cord are not the only sources of the sympathetic fibres. The ganglia also probably give off some. In birds the ganglion of the vagus is a probable source of sympathetic fibres; and in fishes the great thickness of the branches of the vagus, which are very rich in the fine fibres compared with the small size of its roots which are deficient in them, indicates that the ganglion of that nerve is a source of very numerous sympathetic fibres.

The anatomical statements of these writers would, if founded in fact, go far to confirm the opinions of those physiologists who uphold the independence of the sympathetic system, and to prove the ganglia to be distinct centres of nervous influence. It is impossible to enter further upon the discussion of this question at present, without introducing physiological arguments. In a subsequent part of the article we shall return to the subject.*

Nerves of Invertebrata.—In those Invertebrata in which a definite arrangement of the nervous system has been made out, the same elements of the nervous matter are to be found as in the Vertebrata. The grey matter consists of globules with nuclei and nucleoli precisely like those of the human brain. From the ganglia the nerves radiate; the nerve-tubes, which are very delicate and transparent in the recent state, contain a soft pulpy matter easily altered by re-agents. They are themselves collected into bundles which are surrounded by a clear transparent membrane, of the same kind as the sarcolemma of muscle, which accompanies and surrounds the branches of the nerves. As the nerve-tubes separate from the primary trunk into smaller fascicles, these sheaths bifurcate, so as to adapt themselves to the new branches. From the clear outline of the

sheath, and the faintness and indistinctness of the margins of the nerve-tubes contained within it, this arrangement in the smaller nerves has very much the appearance of a bifurcation of the nerve-tubes themselves. There seems, however, no reason to believe that the nerve-tubes of Invertebrata follow a different law from that which regulates their disposition in the Vertebrate series. It is likewise highly probable that the relations of these nerve-tubes to both periphery and centre are essentially the same as in Vertebrata. Plexuses occur much more rarely, according to Valentin, in the nerves of Invertebrata.

Of the development of nerve.—We can add nothing to the account given by Schwann of the development of nerve. The following is quoted from Wagner's Physiology.

"The nerves appear to be formed after the same manner as the muscles, viz. by the fusion of a number of primary cells arranged in rows into a secondary cell. The primary nervous cell, however, has not yet been seen with perfect precision, by reason of the difficulty of distinguishing nervous cells whilst yet in their primary state, from the indifferent cells out of which entire organs are evolved. When first a nerve can be distinguished as such, it presents itself as a pale cord with longitudinal fibrillation, and in this cord a multitude of nuclei are apparent. (Fig. 335, a.) It is easy to detach individual filaments from a cord

Fig. 335.

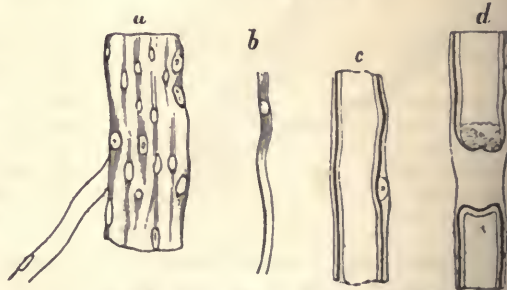

of this kind, as the figure just referred to shows, in the interior of which many nuclei are included, similar to those of the primitive muscular fasciculus, but at a greater distance from one another. The filaments are pale, granulated, and (as appears by their farther development) hollow. At this period, as in muscle, a secondary deposit takes place upon the inner aspect of the cell-membrane of the secondary nervous cell. This secondary deposit is a fatty white-coloured substance, and it is through this that the nerve acquires its opacity (fig. 335, b). Superiorly the fibril is still pale; inferiorly, the deposition of the white substance has occurred, and its effect in rendering the fibril dark is obvious. With the advance of the secondary deposit, the fibrils become so thick, that the double outline of their parietes comes into view and they acquire a tubular appearance (c). On the occurrence of this secondary deposit the nuclei of the cells are generally absorbed; yet a few may still be found to remain for some time

* Die Selbständigkeit des sympathischen Nervensystems, &c. von Bidder und Volkmann.

longer, when they are observed lying outwardly between the deposited substance and the cell-membrane, as in the muscles (c). The remaining cavity appears to be filled by a pretty consistent substance, the band of Remak, and discovered by him. In the adult a nerve, consequently, consists, 1st, of an outer pale thin cell-membrane—the membrane of the original constituent cells, which becomes visible, when the white substance is destroyed by degrees (d); 2d, of a white fatty substance deposited on the inner aspect of the cell-membrane, and of greater or less thickness; 3d, of a substance, which is less thickly firm or consistent, included within the cells, *the band of Remak*."

From the description given in the foregoing pages, we have seen that the prevailing anatomical element of nerves is a tube composed of homogeneous membrane containing a soft pulpy matter, the true nervous substance, divisible into the white substance of Schwann and the band of Remak, and that through the medium of these nerve-tubes or fibres the grey matter of the central masses is brought into connection with the peripheral textures and organs.

Whether the fibres which Henle has designated gelatinous fibres, which resemble very much the central band of the nerve-tubes deprived of tubular membrane and white substance, perform a similar office, or whether they serve to establish a connection between the grey matter of the several nervous centres, are questions which we must leave for future consideration.

The sagacity of Galen long ago pointed out that every part, which is capable of motion, and at the same time possesses sensibility, must receive two classes of nerves, motor and sensitive. And it was reserved for the genius of Bell in our own times to demonstrate that the office of a nerve depends upon the powers or endowments of its component fibres or tubules, and that a nervous trunk may be made up of fibres of different endowments lying in juxtaposition with each other.

It is at the roots of the nerves that tubules of distinct endowments are isolated from each other. Thus Bell's experiments, which have been confirmed by subsequent observations, shewed that the anterior roots of spinal nerves were motor, and the posterior sensitive; and the determination of this important fact is the foundation of all our knowledge of the physiology of nerves.

The difference in the powers or endowments of the nerve-tubes does not appear to depend upon any variety in their structure, or other physical characters, (size perhaps excepted,) for repeated examination has failed to detect any such, but rather upon their peripheral and central connexions. A sensitive nerve, while it is organized at its periphery in such a manner as to adapt it to the reception of impressions, must be connected with that part of the brain whose office it is to perceive the changes which such impressions can produce. And a motor nerve must be on the one hand connected with muscular fibres, and on the other associated with

such a part of the brain or other nervous centre as is capable of exciting in it that change which when communicated to a muscle will stimulate it to contract.

The precise mechanism of those nervous acts, which I would distinguish as purely physical, by reason of their independence of the mind, is as yet unknown. It is still undetermined whether a distinct series of fibres (excitomotory) is necessary for them, or whether they may not be performed by the same fibres which are the channels of the mandates of the will, and of the impressions of those stimuli which are capable of producing sensation.

(R. B. Todd.)

NERVOUS SYSTEM, Comparative Anatomy of.*—In the following article it is intended to describe the anatomy of the nervous system in the different classes of animals as they rise upwards in the scale.

ACRITA.—The class acrita consists of animals whose very characteristic is, that in them the nervous system is molecular, consisting of globules diffused through the cellular tissue of their bodies. Amongst them we distinguish, first, the *Polygastrica*, which are minute microscopic animals, furnished with numerous digestive cavities, in whom no nervous filaments have as yet been traced; still they, many of them, possess eye-specks, they show some indications of the sense of taste, and perform their various motions in the different fluids as if under the well-directed guidance of nervous power. These animals appear as a punctiform homogeneous mass, in which a nervous system does not as yet exist in a distinct form: the nervous matter may be, perhaps, every where diffused through the cellular tissue of their body. These latter remarks will equally apply to the next class—the *Porifera*; of which the *spongia officinalis* may be cited as an example. Its texture is soft and gelatinous, and is probably made up of nervous and muscular globules.

POLYPIFERA.—No nervous filaments have been discovered, or described, in any of the various forms and sizes of polyiferous animals, excepting in the genus actinia, respecting which a doubt, almost amounting to a denial of the statement, exists. The actinia may be considered as an isolated polypus; it has no calcareous skeleton, and fixes itself to the rocks by its fleshy base. Spix, a German anatomist of high repute, gave plates of its nervous system thirty years ago, and described it as consisting of filaments with minute ganglia, surrounding the fleshy base just mentioned, from which were given off nerves to the different parts. [Professor Rymer Jones believes he has detected a delicate nervous thread, passing round the roots of the tentacles, embedded in a strong circular band of muscle, which surrounds the orifice of the stomach.] Mr. Bell, in dissecting several of these actinia, has not been able to detect any nervous filaments;

* The Editor is responsible for the passages included between brackets.

Cuvier has also been unable to make out any traces of a nervous system, and doubted the accuracy of the statement made by Spix. These animals are, however, extremely sensible to the touch, when expanded, and to the light when exposed to its influence. This would indicate some degree of nervous sensibility, but which we can conceive to be afforded by the nervous elements being distributed in their homogeneous structure in a manner similar to the preceding classes. In the next class, the *Acalepha*, which consists of gelatinous marine animals, Trembley,* Gœde,† Carus,‡ and other anatomists have failed to detect any distinct nervous filaments. Dr. Grant,§ however, describes what he considers a nervous system in the *Beroë pileus*, and describes it as "consisting of a double circular nervous filament, situated around the oral extremity of the body, which sends off minute filaments in each of the spaces between the eight longitudinal bands of ciliæ; these eight points, from which the longitudinal filaments come off, present minute ganglionic enlargements." This statement has been recently called in question, and it is probable that the nervous system in these animals is diffused throughout the gelatinous mass of which their bodies are composed. Dr. Milne Edwards describes and figures part of the nervous system in a larger species of *Beroë* (*Lesueuria vitrea*), as radiating from a single small ganglion which is closely connected with a coloured eye-speck, situated at the middle of the superior extremity of the body.||

RADIATA.—In the next group of animals, the Radiata, nervous filaments are for the first time discoverable; and this being the case, it is important that we should notice what form and direction they assume: it is that of a ray and a central point, or a nerve and a ganglion; of these several are developed; and as it is the very essence of a nervous system that it should consist of ganglions united and not separated, threads of communication are developed, called commissures, and a ganglionic system is formed, the inferiority of which is expressed in the Echinodermata by the perfect equality of all the ganglions: these ganglions are also situated at an equal distance from each other, and are determined in their number and origin by the general organization of the animals: thus we shall find that in the Asterias, or star-fish, with five rays, there are five ganglions (with radiating nerves) sending off commissures, which, inasmuch as they are situated on a spherical surface, unite them in the form of a ring. (See ECHINODERMATA, fig. 23, p. 44, vol. ii.) This ring we may call the primary nervous ring; it is that form which we shall hereafter recognize as the essential base of even the

most varied forms of a nervous system. It is only in the genus Asterias that a nervous system has been distinctly seen; and we are indebted to Tiedemann for the first description of it, in his Monograph of the Echinodermata.* In a small species of this genus, it consisted of a circular cord around the mouth, from which proceeded a filament along each ray, having, at its origin, a minute ganglionic enlargement; the nervous ring rested upon the extreme edge of the central aperture in the calcareous frame-work of the body, and the filaments rested on the inferior surface of the rays, concealed by and at the base of the tubular feet and suckers. Two other filaments, much shorter than those just described, according to Tiedemann,† are given off from each of these ganglionic enlargements, to be distributed to the stomach and other viscera. And Ehrenberg affirms that the red points situated at the extremity of each ray are eyes, and receive nerves connected with special ganglia. The statement, however, has not received confirmation from any subsequent observer; but Mr. E. Forbes describes a kind of protective apparatus appertaining to these points, consisting of a peculiar arrangement of the spines around them. [The existence of ganglia is questioned by many observers. Microscopic examination would decide the point.]

In the Echinus no nervous filaments have hitherto been discovered; but in the genus Holothuria, Cuvier observes, "that there appears to be a very attenuated nervous cord around the œsophagus."‡ This Delle Chiaje denies entirely.§ Dr. Grant, however, describes their nervous system to exist in the form of a collar around the anterior part of the body, giving off longitudinal filaments.||

[It is remarkable that, although the nervous system be very obscurely developed in these animals, the action of the muscular integument is extremely powerful. The slightest irritation of the surface is sufficient to occasion forcible contraction of the integument to such a degree that the thin membranes of the cloaca become lacerated, and large portions of the intestine and other viscera are forced from the anal aperture. "So common is this occurrence," says Professor Rymer Jones, "that the older anatomists were led to suppose that, by a natural instinct, the animals, when seized, vomited their own bowels. It is, in fact, extremely difficult to obtain perfect specimens of the Holothuridæ from the constant occurrence of this accident."]

We may next ask what are the characteristics of an increase in development of the primary nervous ring just mentioned, as the fundamental form of every nervous system. They are precisely these: either that it is in itself more highly developed, or that it is multiplied and repeated several times. This we shall find illustrated in nature; the former in the Mol-

* Mémoires pour servir à l'histoire d'un genre de polypes d'eau douce, 1774.

† Beitrage zur Anatomie und Physiologie der Medusen, 1816.

‡ Anatomie Comparée, vol. i.

§ Lectures on Comparative Anatomy.

|| Ann. des Sc. Nat. n. s., t. xvi., and Owen's Lectures, by White, p. 106.

* Anatomie der Röhrenholothurie, &c. 1820.

† Loc. cit.

‡ Règne Animal, vol. iv.

§ Memoir sull'asteria, &c. 1823.

|| Lectures on Comparative Anatomy.

lusca, the latter in the Articulata. In the Mollusca, what is it that constitutes an increase in development of the primary nervous ring, the characteristic form of the nervous system of that class?

1. The greater volume of a central medullary mass, and its situation on the dorsal aspect of the animal.

2. A small number of ganglia in the primary nervous ring, proportioned to the development of the muscular system, one predominating in size over the rest, especially if that one be situated on the dorsal aspect of the animal. These ganglia are disposed unsymmetrically throughout the body, whence Professor Owen has designated these animals, in reference to their nervous system, *Heterogangliata*.

MOLLUSCA.—1. *Tunicata*.—Many of the Tunicata, the lowest of them, approach in character the Zoophytes; for no particular medullary mass constituting a nervous system is discoverable in the soft texture of their bodies, except in but few of the genera, principally in the forms of *Ascidia*. In the *Ascidia mammillata* (fig. 336), Cuvier describes and figures the nervous system* as consisting of a single oblong ganglion, situated near the anus of the animal, and between that and the branchial

Fig. 336.



Ascidia Mammillata, (after Cuvier,) shewing the single ganglion between the branchial and anal orifices.

* Anatomie des Mollusques.

orifice; from this ganglion branches are given off, some of which, passing to the œsophagus, encompass it in the form of a ring.

[Mr. Garner, in his valuable paper on the nervous system of molluscous animals, describes the nervous system of *Phallusia intestinalis*. The single yellowish ganglion lies upon the muscular coat between the two orifices. One set of filaments coming from it surrounds the branchial orifice, and gives nerves to its tentacula, appearing to meet on the opposite side, forming a nerve which seems to run along the edge of the elongated branchial fold. The other set supply the muscular tunic and go towards the mouth. In *Cynthia* and those tunicata that have thick muscular tunics, the ganglion is not visible external to the muscular sac, it being situated in its interior.

As the actions of these animals are extremely simple, so is their nervous system: by the branchial orifice water is drawn in to supply the branchiæ and to convey nutrient matters to the mouth. It is propelled by the action of numerous cilia which cover the surfaces with which it comes in contact. Through the anal orifice are expelled both the current which supplied the respiratory surface and that which passes through the digestive canal. Each orifice is provided with a sphincter muscle, which may oppose the entrance of various matters at one orifice, or resist their exit at the other. These muscles receive filaments from the ganglion. The animal is surrounded by a muscular sac, which by its contraction can compress and empty its general cavity. This, too, receives some nervous filaments. The solitary ganglion of this ascidian seems to regulate the actions of its orifices of ingestion and egestion, and of its enveloping sac on which depends the slight locomotive power of the free species. We are not prepared to deny to even this simple being that prevailing attribute of animals, a will, and therefore it may be assumed that its actions are partly volitional and partly reflex (mental and physical)—while some are, no doubt, due simply to the inherent irritability of its muscular tunic.

2. *Conchifera*.—In this order the nervous system is precisely adapted to the functions these animals have to perform. These are ingestion of the food, respiration, and locomotion. Their nervous centres or ganglia are, consequently, placed in immediate relation to the organs destined to those functions; but as one pair communicate with the others, it may be presumed to exercise an influence over them, and to be the principal centre, the analogue of the brain in the higher animals, the focus of sensation and volition.

The œsophageal or labial ganglia are for this reason the most important. They are two in number; they are situated more or less near the mouth, and are united by a transverse branch which arches over it. From these ganglia nerves are given off to the mouth, and to the tentacles, and to the anterior parts of the viscera. Each ganglion has a branch of communication to the pedal ganglion and also to the branchial ganglion.

Second in importance is the branchial ganglion. In those Conchifers in which the two branchiæ are conjoined, the ganglion continues single; where they are separate, it becomes subdivided. From this ganglion or these ganglia nerves are derived to the branchiæ and to the respiratory siphons, when present, to the posterior parts of the viscera, and to the posterior adductor muscle, also to the mantle.

Fig. 337.

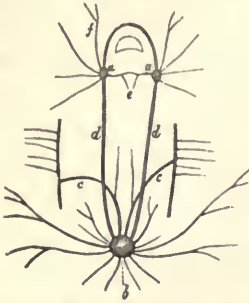

Nervous system of the Oyster, (*Ostrea*).

a, a, anterior ganglia. b, posterior ganglion. c, c, branches to branchia. d, d, connecting trunks. e, transverse branch uniting anterior ganglia.

In the oyster (fig. 337), the cockle (*Cardium*), and many others, the branchiæ are united, and there is consequently but one branchial ganglion.

In the mussel (*Mytilus*), in the scallop (*Pecten*) (fig. 338), &c. the branchiæ are separated and the ganglion is divided into two; their connection, however, is maintained by a commissural band. The branchial ganglia or ganglion are also united to the anterior or œsophageal ones.

Fig. 338.

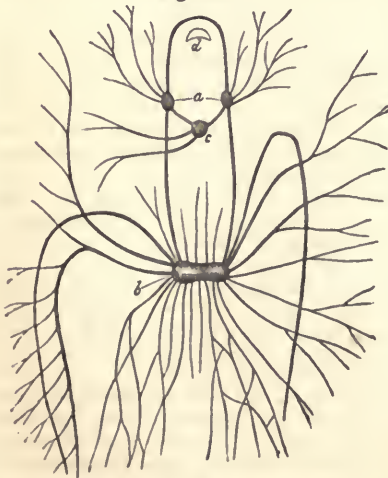

Nervous system of *Pecten* (Scallop).

a, anterior ganglia. b, branchial ganglion. c, pedal ganglion. d, œsophagus.

A third ganglion, the *pedal*, is not developed in all the genera; and this circumstance,

as well as its position and the distribution of its nerves, throws much light upon its function. It is immediately connected with the œsophageal ganglia by two nerves; it is always developed in the substance of the foot, generally at its base, and its size is always proportioned to the power and dimensions of that organ.

In the genus *Ostracea* it is entirely absent; for the foot is wanting, and whatever locomotive power is enjoyed by these animals is performed by the rapid closure of their shells through the action of the adductor muscle.

The arrangement of the nervous system in *Conchifera* is of the highest physiological interest. It affords a beautiful example of a complete analysis of the more complicated nervous system of the vertebrata. We have here an anterior pair of ganglia, from which filaments proceed to all parts of the body, associated too with the ingestive faculty; they are connected with whatever degree of psychological endowment the animal possesses and form its sensorium commune; they are the source of its voluntary actions. The respiratory organs likewise have their special centre in the branchial ganglion or ganglia, the development of which is always proportioned to that of the branchiæ. And there is a special centre provided for the locomotive organ, too, whose development is strictly in relation with its size and activity, and which is absent when that organ does not exist. And it must be observed that these special ganglia (respiratory and pedal), although unconnected with each other, communicate with the œsophageal ganglia.

Have we not here distinctly marked out the cerebrum (the centre of volition and sensation), the medulla oblongata (the respiratory centre), and the cerebellum (locomotive centre), as they occur in the higher vertebrata? And in the aggregate of the chords by which the œsophageal ganglia communicate with the pedal and branchial ones, do we not see the analogue of at least a portion of the spinal cord, that portion which consists of afferent and efferent nerves to and from the brain? The nervous system is distinctly adapted to the wants of the animals and their limited psychological endowment, and the same law prevails throughout the scale of animals. It is not the nervous system which develops the powers and instincts of the animal; on the contrary, these latter determine the development of the nervous system. This is well illustrated by a comparison of the oyster and the mussel. These mollusks differ only in a greater locomotive power belonging to the mussel, to effect which it possesses an organ called the foot; the oyster is devoid of such an organ. The mussel has an additional ganglion (the pedal) which the oyster has not, and this ganglion is not an isolated centre, but, like the branchial ganglion, is connected by distinct filaments with the anterior or cerebral ganglia.

A large series of careful dissections of the nervous system of these and other Invertebrata well displayed is a great desideratum in our public museums. We are happy to perceive that this want is likely to be supplied by the

Council of the College of Surgeons under the judicious direction of Professor Owen. The beautiful preparations of the nervous system of the mussel and other animals by our friend Mr. Goadby, cannot fail to excite the delight and admiration of every friend to the advancement of Physiology. One is not less astonished at his remarkable power of manipulation, as displayed in the dissection of the soft and fragile nerves of these delicate animals, than at the great ingenuity with which he has displayed and perpetuated these witnesses to his anatomical skill. We hope, for the sake of science, that, under the liberal patronage of the College Council, Mr. Goadby will be able to form a large collection of dissections of the Invertebrate Nervous System; and sure we are, that in nothing can the Council contribute more to promote the designs of John Hunter than in making his Museum the depository of such a series by such an artist.]

3. *Gasteropoda*.—[In this order of Mollusks the locomotive function is freely enjoyed, and is effected in many of the genera by a powerful muscular organ, which generally acts as a sucker and enables the animal to adhere forcibly to the surface and draw itself on in a crawling manner—the well known mode of progression of the common snail and slug. In other genera the foot is modified according to the objects to which the animals adhere, or locomotion is performed by portions of the mantle adapted to act as oars or fins in swimming.

The respiratory function, whether adapted to an aquatic or a terrestrial mode of existence, is much more highly developed in these animals than in the preceding order. Their digestive system, too, is more perfect, the accessory organs being more fully developed. We perceive, too, the unequivocal existence of a visual organ. There are also special organs (tentacles) for the exercise of the sense of touch, and it has been supposed that the power of smell and that of hearing existed, although the respective seats of these senses cannot be determined.

It is well known that if the surface of a snail or slug be touched ever so slightly, a contraction of the part so stimulated will immediately take place. This is probably due to the inherent irritability of the subdermic muscular layers, or it may result from the reflexion of the impression upon the motor organs from some nervous centre with which the nerves of the skin are in connexion. It seems very unlikely that we can refer it to a sensibility of the surface, for the observations of Ferussac clearly imply that the terrestrial Gasteropods present no signs of pain when injured or wounded. We cannot, therefore, agree with Professor R. Jones in assigning tactile sensibility to the general cutaneous surface of these animals, nor do we think it necessary to regard the phenomenon in question (as Dr. Carpenter suggests) as an example of motion excited by a reflected impression, which is not accompanied with sensation; but rather as an instance of muscular contraction, produced by the immediate influence of the stimulus on the irritable fibre.

Now this more active exercise of certain functions necessarily implies a greater development of the nervous system; but the same general plan as that described in the Conchifers prevails. The principal part of the nervous apparatus is connected with the œsophagus, and has communications with the other ganglia. There is also a centre of locomotion, and a respiratory centre.*

The œsophageal nervous centre is developed either as two small ganglia, situate on either side of the œsophagus, or as a single large ganglion placed on the median line and above the œsophagus; or, lastly, a single ganglion is formed beneath the œsophagus. In each of these varieties the common type of a nervous ring or collar around the œsophagus is preserved, however the situation of the cephalic centre or the number of its ganglia may differ.

The centre of locomotion consists of two ganglia, from which nerves proceed to the foot and to the mouth; which latter, however, is sometimes supplied from distinct ganglia. These ganglia are connected to each other by commissural nerves and also to the cephalic centre.

The respiratory apparatus and the viscera receive nerves from a proper centre, which sometimes is formed by one ganglion, sometimes by two separate ones, which, however, have a connexion with the cephalic ganglia. The branchial and the pedal ganglia are sometimes conjoined, and in some genera there is a still further concentration, so as to form a common centre from which nerves are distributed to all the organs.

The following examples will serve to illustrate the principal points in the nervous system of these animals:—

In *Patella* (limpet) there are two ganglia situate on either side of the œsophagus (A, *fig.* 339). From these ganglia the tentacles and

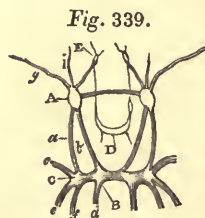

Nervous system of *Patella vulgaris* (Limpet).

A, cerebral ganglia. B, pedal ganglion. C, branchial ganglion. a, filament of communication from cerebral to branchial ganglion. b, filament of communication from cerebral to pedal ganglion. E, labial ganglia. D, connecting band between labial ganglia.

eyes are supplied with nerves, and they are connected to each other by a simple nervous band which passes above the œsophagus. From the posterior part of each ganglion two nerves pass back: the outer one terminates in the branchial ganglion, and the inner one in the pedal. The apparatus for mastication in this animal being complicated, it is supplied from a transverse band or two ganglia, situated beneath the œsophagus, and connected with the anterior or cerebral ganglia. This band is connected with two ganglia that supply the lips, called *labial*

* See article GASTEROPODA, p. 394, vol. ii., and Dr. Carpenter's Lectures on the Nervous System, Lond. Med. Gazette for 1841.

ganglia. They appear to be peculiar to Patella, but are found more distinctly developed in the Cephalopoda.

Fig. 340.

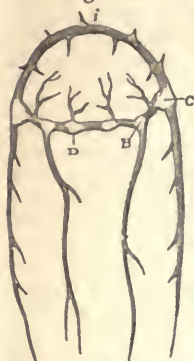
Nervous system of *Chiton Marmoratus*.

B, pedal ganglion. C, branchial ganglion. D, pharyngeal ganglion. i, upper portion of nervous ring (cerebral ganglion.)

In *Aplysia* there is an anterior or cerebral ganglion resulting from the function of two above the œsophagus (c, fig. 341), from which small nerves pass to form the pharyngeal ganglion (p) beneath the pharynx: from this two nerves pass backwards to form the pedal ganglion, which also gives nerves to supply the mantle (P), and in the posterior part of the body there is an additional ganglion, the branchial (B, fig. 341).

Fig. 341.

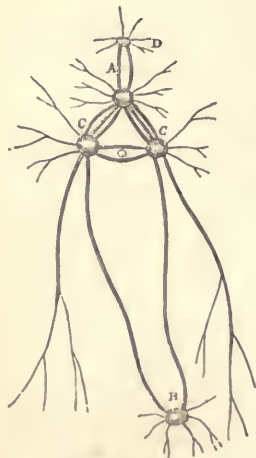
Nervous system of *Aplysia*.

In *Scyllæa*, according to Mr. Garner, the brain is entirely supra-œsophageal; it appears to be composed of four united ganglia, probably the cerebral and branchial. The foot has become too insignificant to require appropriate ganglia. Mr. Garner has noticed two minute black spots, one on each side of the brain, composed probably of black pigment, which he considers to be rudimentary of eyes.

Fig. 342.

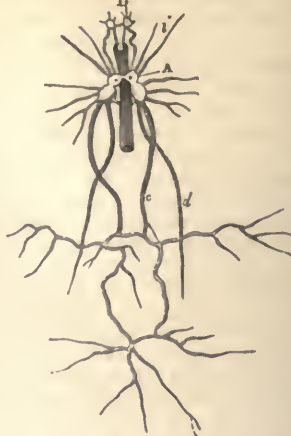
Nervous system of *Scyllæa Pelagica*.

A, cerebral ganglion. D, pharyngeal ganglion. c, d, i, visceral branches.

In *Limax ater* (common slug) the nervous system is apparently much more simple; but on a little examination it will be found to consist of the same essential parts. A large supra-œsophageal ganglion, bilobed, constitutes the brain (a, fig. 343), from each side of which a pair of nerves passes downwards to join a large sub-œsophageal ganglion, which supplies nerves to the respiratory sac and to the foot or locomotive apparatus. And the pharyngeal ganglia are, as in Patella, connected with the anterior ganglion. In the sub-œsophageal ganglion we see, conjoined, the pedal and branchial ganglia.

Fig. 343.



In *Buccinum undatum* the principal nervous mass is sub-œsophageal, and from it nerves pass to the branchiæ and viscera, and also to the foot and integument. The former nerves form a ganglion, which may be regarded as the branchial ganglion.*

For the nervous systems of *Pteropoda* and *Cephalopoda*, see the articles under those titles.

Nervous system of the common black slug (*limax ater*).

a, supra-œsophageal ganglion. b, infra-œsophageal ganglion. d, anterior sub-œsophageal ganglia.

ARTICULATA.—In taking a general survey of the structure of the articulated animals, we observe that their body is divided into a certain definite number of segments, each one of which

* See Garner's paper, loc. cit.

may be considered as a repetition of the other; of these, the most anterior acquires the greatest development, and is called the head. So in examining their nervous system, we shall find that a primary nervous ring (formed of a ganglion and two semi-circular radiating nerves) is contained in each segment. This ring, no longer closed, as in the preceding classes, but open, varies in degree of development, according as the segment which encloses it is in a high or low degree of development: thus, in the cephalic segment, or head, we shall always find developed a cerebral or supra-œsophageal ganglion; and, inasmuch as when a true nervous system was first formed—was first separated from the punctiform homogeneous mass of the gelatinous acrita—commissures were found uniting the primary masses of medullary substance (as we saw in the Asterias), so ought we to find, in the Articulata, commissures uniting the primary nervous rings; which latter are now become longitudinal, and the commissures of the nervous ring itself are now become radiating nerves. We ought also to find that these commissures depend, in degree of development and in situation, on the same characters of the primary nervous ring, and consequently on the ganglia thereon developed.

We may next ask, what will mark the high or low degree of organization of a nervous system composed of several primary nervous rings? The researches of philosophical anatomy inform us, that, first, a low degree will be characterized by an *undetermined* number of those rings—by a nearly equal development of the whole, and by the central mass of nervous matter accumulated on them being situated on the ventral surface of the animal. Secondly, a higher degree of organization exists when the primary nervous rings are repeated in a determinate manner—when some of them predominate in development over the others, and their central medullary masses, or ganglions, are situated on the dorsal aspect of the animal. Again, as regards the uniting commissures, these will, of course, depend, in degree of development, on the organization of the ganglions united by them; and the more perfect and the more intimate is the connexion established by these commissures, the more highly organized is the nervous system.

In the Articulata about to be described, we shall always find the most anterior nervous ring developing a ganglion on its superior surface—a true cerebral ganglion. We shall find this nervous ring repeated in the other segments of the body, but in a much more imperfect manner, for ganglions are developed only on the ventral surface of the animal; and from this latter circumstance, they, as well as their commissures, cannot be highly developed.

1. *Entozoa*.—In the lower forms of Entozoa, as in the tœnia and cysticercus, no nervous system is discoverable. These animals consist of a gelatinous, more or less homogeneous mass, in which no distinct nervous system exists. In the *Distoma hepaticum*, the nervous system consists, according to Bojanus,* of a

nervous collar or ring, with two lateral ganglions entwining the œsophagus, and two nerves which are distributed on the posterior part of the body. In the *Ascaris lumbricoides*, the nervous system consists of a thin double filament, without ganglia, situated in the median line of the abdomen, which separates to enclose the opening of the vulva, and to encompass the œsophagus at the lower part of the mouth. In the *Strongylus gigas*, according to Otto,* the median nervous filament consists of very closely approximated ganglia, thus advancing a step higher in organization, and approaching to the character of the true articulated classes.

2. *Rotifera*.—The Rotifera are minute microscopic animals: in them Ehrenberg has discovered and described a rather complex nervous organization, sufficiently so to justify their being ranked thus high in the scale of animated beings.† In the *Hydatina senta*, according to this anatomist, the nervous system consists of two closely approximated filaments running along the abdomen, and giving off lateral branches in their course forwards: arrived at the anterior part of the body, these nerves form a large ganglion, and then ascend to embrace the œsophagus in the form of a ring, on which minute ganglia are developed, giving off numerous filaments to the surrounding parts. There are four of these lateral ganglia, besides the large supra-œsophageal ganglion.

3. *Cirrhopoda*.—In the Cirrhopoda, the abdominal nervous cords have regular ganglia developed on them, and there is a nervous collar round the œsophagus, as in the preceding classes. Cuvier observes,‡ that in a species of *Lepas* he found two nervous cords situated on the ventral surface of the body, with five double ganglia developed on them, from which were given off lateral filaments to supply the curled feet. Anteriorly, and at the lower part of the mouth, these cords separated more widely, to encircle the œsophagus, above which they developed a quadrilobate ganglion, from which were given off four nerves to the viscera and muscles.

4. *Annelida*.—The nervous system of the Annelida consists of a varied number of ganglia, united by double longitudinal commissures, running along the ventral surface of the body, from which lateral filaments are given off. There is also a supra-œsophageal ganglion, which, being connected by lateral nervous cords with the first pair of infra-œsophageal ganglia, form a ring or collar, surrounding the œsophagus: this we at once recognize as the most anterior of the column of primary nervous rings, with the ganglion developed on its superior surface. I have examined the nervous system in the genera *Lumbricus*, *Aphrodita*, and *Hirudo*; the general plan was the same in all. In the *Lumbricus terrestris*, or common earth-worm, a nervous cord passed along the whole ventral surface of the animal, and presented, in a small species, the appearance

* Berliner Magazin, 1814, p. 178.

† Organisation Systematik der Infusions-Thierchen, Berlin, 1830.

‡ Anat. des Mollusques.

* Isis, 1821, vol. i. p. 168.

of an irregular white line, the structure of which, when viewed under a lens, appeared to consist of a number of closely approximated nervous threads. In a larger species the nervous cord had a more jointed, knotted appearance, and its structure was more homogeneous; the ganglia were, however, but very imperfectly developed, for at each segment of the body of the worm, the nervous cord only offered an enlargement or swelling of rather an elongated form (*fig. 344, d*): the first or most anterior

Fig. 344.

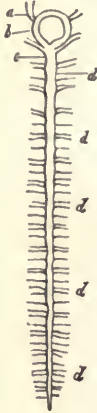

Upper fourth of the nervous cord of *Lumbricus terrestris* (earthworm).

a, supra-oesophageal or cerebral ganglion. *c*, infra-oesophageal ganglion. *b, b*, lateral nervous cords, forming the oral primary nervous ring. *d, d, d, d*, enlargements of the ventral cord, or imperfect ganglia, developed on the ventral surfaces of the series of primary nervous rings.

of these (the infra-oesophageal ganglion) was the largest (*c*). These enlargements were more closely approximated towards the anterior part of the body; from each of them were given off two pair of nerves, one passing to the right, the other to the left, to supply the integuments. From the more attenuated intervening portions of the cord, a single pair of filaments was given off; these filaments we at once recognize as the commissures of the nervous ring of the Radiata and Mollusca; they pass round the body and approach each other on the dorsal surface, but do not unite: in this way is an open nervous ring formed. The infra-oesophageal ganglion before mentioned diverged at its anterior part, sent upwards two lateral nervous cords (*b*), which developed a large bilobate cerebral or supra-oesophageal ganglion (*a*) of a transversely elongated oval form, thus forming a distinct nervous ring, embracing the oesophagus. From the angles formed by the divergence of the infra-oesophageal ganglia, a nerve of rather firm texture was given off; another filament had its origin from the lateral and ascending portions of the nervous collar; and from the cerebral ganglion two pairs of nerves passed forwards to supply the parts about the head. In the Aphrodita, a marine Annelide, the nervous

cord had a more flattened appearance: it was about equal in width throughout its whole length, and presented similar enlargements in its course, from which nerves were given off, as in the Lumbricus; no nerve, however, arose from the intervening spaces. In the Leech, the abdominal nervous cord was surrounded by several delicate vessels, and at the anterior part of the commissures was distinctly seen to be composed of two separated columns: the ganglia were very distinct, of a round form, and twenty-four in number,—the last four or five were more closely approximated; from each were given off two diverging pair of lateral filaments, which passed to supply the muscles and viscera. The cerebral ganglion is bilobed, and sends off ten distinct optic nerves besides many smaller filaments to the integument and other parts of the head; each optic nerve terminates by expanding upon the base of a black eye-speck or ocellus.*

According to Brandt, a simple nervous filament is continued from the oesophageal ganglion along the dorsal aspect of the alimentary canal. "This," says Professor Owen, "is an interesting structure, since it offers the first trace of a distinct system of nerves, usually called the stomato-gastric in Entomology, and to which our great sympathetic and nervus vagus seem answerable."

These four classes comprise the whole of the helminthoid Articulata; and on reviewing the statements just made with regard to their nervous system, we observe that the lowest of them bear a great analogy to the Acrita and some of the Tunicata, in having no distinct nervous system discoverable; that where such does exist in the higher orders of them, it bears more or less the character before noticed as the type of the Articulata, which was, it will be recollected, a series of primary nervous rings connected by commissures; that in the Ascaris the ganglia are so imperfectly developed, and consequently their commissures, that the whole has the appearance of only a single nervous filament. As we proceed through the Rotifera and Cirrhopoda, we observe the ganglia rather more perfectly developed, but undetermined in number. In the highest of the Annelides, as the Leech, we find distinct ganglia developed and arranged in a determinate numerical series. Again, the cerebral ganglion, from being at first little more than a simple enlargement on the superior surface of the anterior primary nervous ring, has acquired, in the Leech, the form of a distinct ganglion.

We next pass to the examination of the Entomoid Articulata, in which we shall find the cerebral ganglion becoming more and more developed, and the ventral ganglia more determined as to number, and more concentrated as to situation; their longitudinal commissures have been supposed to possess two distinct nervous tracts, composed of motor and sensitive columns, giving origin to nerves having sentient and motiferous properties.

1. *Crustacea*.—In the lowest of them, the Crustacea, the nervous system presents nu-

* Owen's Lectures, p. 141.

merous forms and degrees of organization. In the common *Talitrus*, an inferior genus, it consists of a regular series of ganglia, developed at an equal distance from each other, united by two distinctly separated longitudinal cords, from which are given off transverse nerves. I have found the same arrangement in the genus *Oniscus*, in which also a close analogy to the nervous system of the Annelides was apparent. In the *Cymothoa*, an animal a little higher in the scale, these longitudinal columns have become closely approximated, and the ganglia have coalesced transversely. Rising higher in the scale, we find a still greater degree of concentration and coalescence in the Decapoda, this being directed to two principal points—the thorax in the long-tailed Decapods, and the thorax and abdomen in the short-tailed ones. With regard to the former, I have examined the nervous system in the genera *Crangon*, *Processa*, and *Pagurus*, in all of which it presented a similarity in development. In the lengthened abdomen the longitudinal cords were very closely approximated, and the ganglia developed were nearly of an equal size, and equidistant from each other; from them were given off transverse nerves. In the thorax, the ganglia were very closely approximated indeed, longitudinally, so as nearly to have the appearance of one nervous mass, from which were given off large transverse nerves to the neighbouring parts, and from the anterior part of which there passed off two long nervous cords, which encircled the œsophagus, and developed a ganglion on its superior part. In the short-tailed Decapods, as in the common edible crab, the abdominal ganglia have coalesced into one large nervous mass, from which radiate nerves to the legs, &c.; from its anterior part there pass two long filaments, connecting it with the coalesced ganglia in the thorax. There is a supra-œsophageal ganglion, as in the preceding, but it is comparatively small.

2. *Myriapoda*.—Amongst the Myriapoda, the next class, we find the nervous system again beginning by a low state of organization, similar to the lower Crustacea, this being principally characterized by a considerable number of ganglions. In the *Scolopendra morsitans*, the nervous system consists of a series of twenty-one double ganglia, situated on the ventral surface of the body, connected by intervening distinctly double longitudinal cords. From each ganglion are given off lateral nerves to supply the neighbouring muscles, viscera, and feet. Those ganglia are nearly all equal in size excepting the first, which is the largest, and from which are given off additional nerves to supply the maxillæ, &c. Beyond this first sub-œsophageal ganglion, and from its anterior part, proceed the longitudinal connecting cords, which diverge to encircle the œsophagus, above which they meet and develop a bilobate supra-œsophageal ganglion. (See MYRIAPODA, (fig. 313.) [Mr. Newport's recent researches on the nervous system of Myriapoda favour the opinion that a distinct series of excitomotory

fibres connected with the ganglia of the segments (and not with the cerebral ganglion) exist in these animals. See the forthcoming volume of the Philosophical Transactions, 1843.]

3. *Arachnida*.—In the Arachnida the nervous system is more concentrated, and the ganglia are fewer; they may be considered, indeed, as intermediate in the development of this system between the Insecta and Crustacea. In the Scorpions, according to Dr. Grant,* “the ganglia of the trunk have formed one large nervous mass, from which all the nerves of the legs and the surrounding parts take their rise as from a single ganglion.” The cerebral ganglion is comparatively small, and, according to Cuvier and Carus,† the two nervous cords, proceeding thence, unite at intervals to form seven ganglions, the last of which belongs to the tail. Grant observes,‡ that the motor column is very loosely connected with the two inferior or sensitive columns, particularly in the region of the abdomen, and that this conformation is more obvious here than in any other of the Articulata. In Spiders, the nervous system consists, according to Professor Owen's description, of a brain, a bilobed ganglion which supplies the optic nerves, and also two large nerves to the mandibles. From it a short and thick collar, embracing the gullet, extends to a second very considerable stellate or radiated ganglion, situate below the stomach upon the plastron. From this ganglion five principal nerves are sent off on each side, “the first to the pediform maxillary palpi, the second to the more pediform labial palpi, which are usually longer than the rest of the legs, and used by many spiders rather as instruments of exploration than of locomotion; the three posterior nerves supply the remaining legs, which answer to the thoracic legs of Hexapod Insects. The nervous axis is prolonged beyond this great ganglion, as two distinct chords, into the beginning of the abdomen, where, in the *Epira* diadema, it divides into a kind of cauda equina; but in the *Mygale* a third ganglion of very small size is formed from which the nerves diverge to supply the teguments of the abdomen and its contents.” * * * “The stomatogastric nerves are sent off from the posterior and lateral parts of the brain and form on each side a reticulate ganglion, which distributes filaments to the stomach.” §

4. *Insecta*.—We have now to examine the last and highest class of articulated animals—the Insecta, in which we shall find the nervous system very highly organized, leading us by strict analogies to the Vertebrata. It consists, in almost every order, of a ganglionic nervous cord, running along the abdominal surface, as in the preceding classes, and of a similar supra-œsophageal nervous mass, called by Cuvier the brain, from which are given off eight pairs of nerves and two single ones. This nervous cord consists of a varied number of ganglia, giving off lateral nervous filaments, and connected to

* Lectures on Comparative Anatomy.

† Op. cit.

‡ Op. cit.

§ Owen's Lectures, by White, p. 255.

each other by sensitive columns. A tract has also been recently described by Mr. Newport,* passing along the dorsal surface of these columns, and giving off lateral nervous branches; this has been regarded as a molar tract. Minute anatomy has also unfolded to us what may be considered as the analogue of the respiratory system of nerves, and a par vagum.

These points we will now notice in detail, commencing with the Hemipterous Insecta, in which the nervous system is least perfectly organized. In the perfect state of the *Ranatra linearis* the nervous system consists (besides the supra-oesophageal nervous accumulation) of a small round ganglion (fig. 345, *a*), situated below the oesophagus at its very commence-

Fig. 345.



Ventral nervous cord of *Ranatra linearis* (perfect state), magnified to about twice the natural size.

a, small round sub-oesophageal ganglion. *b*, large quadrilobate thoracic ganglion. *c, c*, filaments passing down the lengthened abdomen.

ment; from this two longitudinal commissures pass to join with a large quadrilobate ganglion (*b*), situated at the further extremity of the thorax. From each side of this ganglion there are given off three nervous threads, passing superiorly, transversely, and inferiorly; and from the lower part of the ganglion, which is slightly fusiform in shape, there are given off two bundles of most minute and delicate nervous filaments (*cc*), each containing five branches, which pass downwards into the lengthened abdomen to supply the parts situated in that region; there is also a supra-oesophageal nervous accumulation. In the Orthoptera the nervous system presents a certain degree of concentration worthy of notice. In the perfect state of a species of

Acrydium there are two comparatively large thoracic ganglia, very near each other, and connected, as usual, by commissures; in the abdomen there are five ganglia of much smaller size, connected in a similar manner, and giving off lateral filaments: the first and second of these abdominal ganglia are some distance from each other; the three last are much more closely approximated, and are rather larger and more distinct; the cerebral ganglion is of small size.

Proceeding with the Coleoptera, we find that many of the Lamellicornes, in their perfect state, have a singular and rather unusual mode of development of their nervous system; the ganglia are but few in number, closely approximated, and the two posterior ones give off numerous radiating filaments: this is the case with the larva of the *Oryctes nasicornis*, according to a dissection by Swammerdam.* In the *Geotrupes stercorarius* (fig. 346), perfect

Fig. 346.

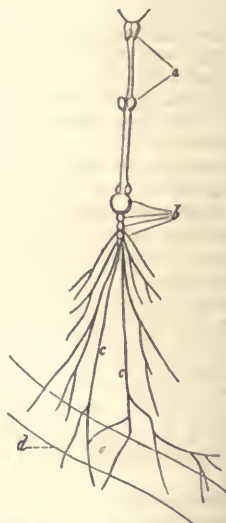

Ventral nervous cord of *Geotrupes stercorarius* (perfect state), magnified to about three times the natural size.

a, bilobate thoracic ganglia. *b*, abdominal ganglia. *c, c*, filaments to the intestine. *d*, intestine.

state, another of the Lamellicornes, there are found in the thorax two distinctly bilobate ganglia (*a*), connected by longitudinal commissures, and one smaller ganglion at the junction of the thorax with the abdomen, immediately contiguous with which are one large and three smaller ganglia, very closely approximated to each other (*b*); the last was the longest, of rather a fusiform shape, and gave off radiating nervous filaments, particularly two long branches to the abdominal viscera and adjacent parts (*c, c*). The more usual form, however, of the nervous system, is such as will be described in the subsequent species.

* Philosophical Transactions for 1832 and 1834.

* Biblia Naturæ.

In the larva of *Dyticus marginalis* (*fig. 347*), the nervous system consists of a distinctly bilobate supra-oesophageal ganglion (*a*), from

Fig. 347.



Ventral nervous cord of Dyticus marginalis (larva state), magnified to about twice the natural size.

a, bilobate supra-oesophageal or cerebral ganglion. *b*, nerves passing to the antennæ. *c*, *c*, nerves passing to the eyes. *d*, infra-oesophageal ganglion, with the nerves passing to the maxilla, mandibles, and labium. *e*, *e*, *e*, *e*, thoracic and abdominal ganglia. *f*, *f*, nervous filaments passing to the caudal extremity of the larva.

which are given off nerves to the antennæ, and the eyes (*b*, *c*), and of twelve abdominal ganglia, connected by longitudinal cords (*c*). The difference in distance of these ganglia is very remarkable, and worthy of mention. The first, or true infra-oesophageal ganglion (*d*) is situated as usual; between this and the second a long space intervenes, and the connecting cords are firm and distinct; the spaces between the second, third, fourth, and fifth are about equal, and not more than one-third the distance between the first described; the remaining seven are so closely approximated as to touch each other: from the terminal ganglion are given off long and minute nervous filaments, which may be traced down to the caudal extremity of the larva.

In the Hymenoptera a very great concen-

tration and increased development of the nervous system is met with. In the *Bee* the cerebral ganglion is of a large proportional size; from its anterior part are given off two nerves, which pass forward to the base of the antenna, and have their origin marked by a very distinct conical-shaped ganglionic enlargement. In the thorax all the ganglia coalesce into one central large ganglion, and a smaller one closely attached to it, giving off lateral nervous filaments; in the abdomen there are five smaller ganglia; they are connected by commissures, as in the preceding classes, the double nature of which is distinctly seen by a lens: the first abdominal ganglion is situated at some distance from the thoracic ganglion; the second and third are much nearer together, but the fourth and fifth are quite closely approximated: from them are given off radiating nerves.

The most highly developed nervous system in the Articulata occurs in the Lepidoptera, the characters of which we shall next describe. In the larva of the *Saturnia pavonia minor* (*fig. 348*), the nervous system consists of a bilobate supra-oesophageal or cerebral ganglion, and of twelve sub-oesophageal or abdominal ganglia (*a*), united by longitudinal fissures.

The cerebral ganglion consists of two closely approximated oblong ovate medullary masses, giving off nerves supplying the eyes and the antennæ, and a pair of nerves from its anterior and lower parts, which takes a direction forwards, and which meeting inwards and joining, forms a ganglion: from the posterior surface of this ganglion arises a nerve (the recurrent of Lyonnet) which passes backward beneath the cerebral ganglion along the oesophagus, and gives off filaments to it and the stomach.* The existence of this nerve, and particularly its situation, is of very high importance, according to the laws of philosophical anatomy: the branching filaments it sends off form nervous rings, which are important in being open below and not above, and in developing a ganglion on the dorsal aspect of the animal; this, we shall find presently, leads by strong analogies to the Vertebrata. The cerebral ganglion is supported or produced by two lateral nervous filaments, which, having their origin at its posterior part, pass downwards by the sides of the oesophagus, at the inferior part of which they converge, and are connected with the first sub-oesophageal ganglion; in this way a nervous collar or ring is formed, which encircles the oesophagus. This first inferior ganglion (*b*) is of rather a quadrilateral form; it gives off a pair of nerves to the maxillæ and to the labium (*c*, *d*), which have their origin within, the termination of the lateral commissures just described. The second ganglion is longitudinally continuous with the first; from them are given off lateral nerves. The (supposed) motor and sensitive connecting nervous columns are widely separate between the second and third ganglia, and between the third and fourth; between all the others they are very closely

* This nerve is considered by Mr. Newport as the analogue of the par vagum.

o, a, a, a, a, ganglia of the ventral cord. *b*, first infra-oesophageal ganglion. *c, c*, nerves passing to the maxilla. *d, d*, nerves passing to the labium. *e, e, e, e*, lateral nerves arising from the ganglia. *f, f*, nerves passing off at the angle of separation between the longitudinal cords, divided into—*g, g*, right and left transverse filaments, supposed to be respiratory nerves; *h*, terminal ganglion; *i, i*, nerves passing to the caudal extremity of the larva.

Ventral nervous cord of *Saturnia pavonia minor* (larva state), magnified to four times the natural size.



Fig. 348.

approximated, though by a lens the fissure or mark of separation may in some be perceived. The abdominal ganglia are of a lengthened ovoid form; and when viewed through a lens, have a dense opaque white appearance; two in particular appear encased as it were in a neurilemma, and have a distinctly bilobate appearance; in others there appears quite a nucleus of opaque nervous matter (8 & 9); from each of them are given off three lateral pairs of nerves, some of which pass to supply the viscera, while others pass round the body of the larva to near the dorsal vessel, thus forming a nervous ring, open superiorly, which being repeated in each segment, and the whole connected by commissures, forms a continuous series at once recognised as a column of primary nervous rings, the type of the nervous system of the articulata; the eleventh and twelfth ganglia are closely joined to each other, and from the latter are given off two radiating pairs of nerves, passing to the caudal extremity of the larva. There is also a minute nerve (fig. 348, *f*), which I have traced in this larva passing off at the angle of separation between the divided longitudinal cords connecting the second and third, and the third and fourth abdominal ganglia, and which, midway between these ganglia, divided into a right and left transverse filament (*g, g*), each of which had connexion with the lateral nerves arising from the ganglia themselves. Some have considered these nerves as sympathetic, others as motor, but from their principal branches going to supply the tracheæ, I consider, with Mr. Newport, that they must be respiratory nerves.

I have examined the nervous cord in the larva of *Pontia brassica*, *Cossus ligniperda*, two species of *Arctia*, and have found the disposition of the ganglia, &c. to be the same; as the insect, however, advances towards maturity, considerable and important changes take place in the nervous system. Heroldt has described and figured them in the *Pontia brassica*,* and Mr. Newport has investigated them with the minutest accuracy in the *Sphinx ligustri*.† It appears that during the pupa state a contraction of the nervous columns takes place, the ganglia (more particularly the second, third, fourth, and fifth) become approximated; the distance between the cerebral ganglion and the first sub-oesophageal ganglion becomes much less, and the oesophageal ring becomes much smaller; this is preparatory to the subsequent concentration and junction which we find in the perfect insect. When this latter phenomenon takes place, the ganglia just mentioned become consolidated together, and the oral nervous ring is scarcely perceptible: this is the case in the perfect state of *Mormo maura* (fig. 349), where also the abdominal ganglia are small (*c c*), and (owing to the disappearance of two of the thoracic ganglia) are situated at some distance from these latter, which are of large size (*b b*), and the nervous

* *Entwicklungsgeschichte des Schmetterlings.*

† *Phil. Trans. for 1832 and 1834.*

matter of which they are composed appears more dense and opaque in its texture.*

Fig. 349.

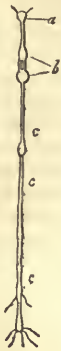

Ventral nervous cord of *Mormo maura* (perfect state), magnified to about twice the natural size.

a, infra-oesophageal ganglion. b, large thoracic ganglia. c, c, c, small abdominal ganglia.

In Insects we observe a remarkable correspondence between the disposition of the nervous system and the form of the animal, and this is conspicuous not only in the adult but also in the larva state. Indeed the changes which take place in the arrangement of the nervous system as the creature passes from its immature to its mature condition, are sufficient to indicate that the same law which influences that alteration of form, promotes the adaptation of the nervous system to it; and yet, notwithstanding its apparent complication, the nervous system of insects has the same physiological signification as that of Mollusks. A cephalic ganglion, with which are united the nerves of the organs of sense, is so connected with the remaining ganglia, that its influence can extend throughout the whole system. Each segment is provided with a ganglion, which has no power beyond the limits of the segment, and which cannot act consentaneously with its fellows, except under the direction of the cephalic ganglion. The pedal ganglion of Mollusca is in insects represented by the aggregate of these ganglia of the segments, which are also doubtless the centres of the respiratory actions. And those nerves which, arising from the cephalic ganglion, are distributed to the digestive organs, the stomato-gastric nerves, are analogous to the sympathetic or to the vagus.

[It has been supposed by some anatomists that a distinct isolation of motor and sensitive function occurs in the ganglionic and non-ganglionic cords of the abdominal nervous chain of

* This is, however, but a rough sketch of the interesting changes that take place in the nervous system during the progress of the insect from its larva to its perfect state. Those who are interested in the matter, I beg leave to refer to Mr. Newport's highly valuable paper, where, as I have before observed, the changes of the *Sphinx ligustri* are detailed with minute accuracy. See also INSECTA.

insects, as well as of other Articulata (See fig. 411, art. INSECTA, vol. ii. p. 952.) But there are many objections to this hypothesis, which, indeed, must be regarded as quite untenable. It has been founded upon the anatomical fact, which is true as regards the vertebrata, that sensitive nerves have ganglia while the motor ones are devoid of them. But it is going too far to compare nerves and centres, and to argue from the nerves of vertebrata respecting the centres of Invertebrata. Moreover, as Prof. Owen remarks, the presence of ganglia on the sensitive roots of spinal nerves is not their constant character. This hypothesis also received some support from a doctrine which was countenanced by Bell, namely, that the columns of the spinal cord of vertebrata corresponded in function with that of the roots of the nerves, the anterior columns being motor as the anterior roots were, and the posterior columns and roots being sensitive. But this doctrine is utterly without foundation, as will be shewn in a subsequent part of this article. Prof. Owen adduces an important fact respecting two nearly allied Crustacea, which further invalidates the supposed difference of function of the ganglionic and non-ganglionic columns. "In the lobster (*Astacus*) and in the hermit-crab (*Pagurus*) we have two opposite conditions of a large and important part of the trunk. In the lobster the abdomen or tail is encased in a series of calcareous rings forming a hard and insensible chain armour, but as it is almost the exclusive organ by which the animal swims, it enjoys considerable motor power, a large portion of the muscular system being devoted to it. In the hermit-crab, on the other hand, the muscular system is almost abrogated in the long abdomen, for this in fact takes no share in the locomotive functions of the body: it is occupied by part of the alimentary canal and by glandular organs: the sensibility of the external integument is not impaired or destroyed by the deposition of calcareous particles in its tissue, but it retains the necessary faculty of testing the smooth and unirritating condition of the inner surface of the deserted shell which the animal chooses for its abode: minute acetabula are developed in groups upon this sensitive integument, to which also delicate ciliated processes are attached. The muscular system is reduced to a few minute fasciculi of fibres regulating the action of the small terminal claspers. Now," adds Professor Owen, "if, as has been conjectured, the ganglionic enlargements of the abdominal cords monopolize the sensorial functions, and the non-ganglionic tracts the motor powers, we ought to find the nerves, which supply the muscles of tail constructed almost exclusively for locomotion, to be derived from non-ganglionic columns; whilst in the tail, which is almost as exclusively sensitive, the ganglia ought to have been large and numerous for the supply of nerves to the integument. The contrary, however, is the fact; six well-developed ganglia distribute nerves to the muscular fibres of the lobster's tail; non-ganglionic columns supply the sensitive tail of the

hermit crab. One ganglion, indeed, is present in the Pagurus, but both its situation and office alike militate against the hypothesis of its special subserviency to sensation: it is developed upon the end of the smooth abdominal chords, and seems to have been called into existence solely to regulate the actions of the muscles of the claspers by which the hermit keeps firm hold of the columella of its borrowed dwelling."*]

On reviewing these statements of the nervous system of the entomoid Articulata, we observe that the superior ganglion of the primary nervous ring, or the cerebral ganglion, passes through several degrees of complication from the Crustacea, where it presents only slight traces of a division laterally up to the Insecta, as in the bee for instance, where it preponderates greatly in size over the ganglions, and where the sensorial nerves arising from it present distinct ganglionic enlargements. The anterior or cephalic primary nervous ring itself we see to be gradually decreasing in size from the Crustacea, where it is large and lengthened, to the highest Insecta, the Lepidoptera, where it is much smaller, and almost coalescing the superior and inferior ganglions developed on it into one ganglion. We observe that the number of primary nervous rings, with their ganglia, gradually becomes more constricted from the Crustacea through the Myriapoda (where they are developed in an undetermined length) and the Arachnida, where they are much fewer, to the Insecta, where, in their larva state, they approach the Annelides, but in their perfect state we find them developed in a regular series, and more concentrated in the regions of the head, thorax, and abdomen. These anatomical details, together with the complicated nature of the longitudinal commissures, a distinct system of nerves supposed to be for respiration, and a par vagum, demonstrate a close analogy between the ganglionic cord of the Insecta and the spinal cord of the Vertebrata, and may be considered as reasonable grounds for ranking this interesting tribe of animals the highest of the Articulata.

Further details respecting the anatomy of the nervous system of Insects will be found in the article INSECTA.

VERTEBRATA.—We now pass to the last and highest group, the Vertebrata, where the primary nervous rings of the preceding classes have become ganglions, and their commissures have become primary nervous rings. In each segment of their bodies there is but one ganglion developed, but that one large, and situated on the dorsal aspect, and each one in the different segments is united to the other by commissures, thus forming a large median nervous mass, the primary characteristic of a true cerebral system. This will be, of course, subject to infinite modifications and degrees of organization. In the lower Vertebrata the ganglia and their commissures will be nearly

equally developed; in the higher ones the ganglionic formation will predominate; and as these animals are characterized by this predominance of ganglion, its great development takes place in that part of their body which is itself the most highly developed, the head, and the ganglionic mass itself is called the brain. On the contrary, the development of the commissures, or of the longitudinal fibres, takes place in the opposing point to the head, viz. the trunk, and from that results what is called familiarly the spinal marrow. Again, as it is the very characteristic of the nervous matter to accumulate and develop itself on the dorsal aspect in preference, it can easily be conceived that as the ganglionic nervous matter, or brain, increases in development, so will it influence the *direction* of the spinal marrow, and, indeed, also of the whole body. For instance, in the lower nervous formations the brain and spinal marrow are perfectly horizontal. As the former proceeds in development, an angle, at first very acute, is formed, which gradually decreases until, in the human brain, the most perfect of all, it becomes a complete right angle. Another important point is, the *number* of ganglia and commissures that may be developed. We have already observed that each segment of the body of the Vertebrata contains a ganglion and a primary nervous ring: the number, therefore, of these latter is unfixed and variable, and depends entirely on the number of the segments of the body, or, in other words, the length of the spinal cord depends on the length of the animal. But, with regard to the masses of ganglionic nervous matter situated in that segment of the body which is the most highly developed—the head—they ought to be developed in a manner fixed and determined; and such, indeed, is the case: a division into *three* is observable in the brains of all the Vertebrata, an anterior portion or cerebrum, a posterior portion or cerebellum, a median portion, the tubercula quadrigemina. Thus the number of ganglia forming the brain, the most highly organized part of the nervous mass, is definite and invariable, while the number of ganglia forming the spinal cord, the least highly organized part of the nervous mass, is indefinite and variable. The three portions of the cerebral mass, the anterior, median, and posterior, will be designated by the names of *first, second, and third cerebral masses*; and we shall endeavour to point out the analogies which each of these portions bears in the brains of the different animals, as we ascend the scale, respecting which anatomists have various opinions.

These observations being premised, we pass to the consideration of the vertebrated classes, individually, in the manner proposed, commencing with the lowest, the fishes.

1. *Pisces*.—In these animals the nervous system presents an immense variety of forms and degrees of development. Even in the Cyclostomata, a division into brain and spinal marrow (in the general acceptation of the terms) is evident: in the former, a division into three

* Owen's Lectures, p. 171-72.

is at once seen; in the latter, the ganglia are numerous and undetermined. We will notice these parts separately.

The spinal cord* (*fig. 351, g*), is remarkable for its great relative size in this class of animals: it is continued (with but very few exceptions) the whole length of the vertebral column, even into the caudal vertebræ, and it has on its anterior and posterior aspects a longitudinal fissure (*fig. 351, h*), the latter being the deepest; internally it is hollowed out by a canal (*i*) which traverses it in its whole extent, and which, at the upper part, immediately posterior to or underneath the cerebellum, forms a considerable dilatation or enlargement—the fourth ventricle (*fig. 352, e*). The posterior fissure extends to this canal. In a river lamprey (*Petromyzon fluviatilis*), weighing 570 grains, the brain weighs only four-tenths of a grain, while the spinal cord weighs three grains, the proportions being as 100 : 750. We thus observe how much the latter preponderates in size, being seven and a half times heavier than the brain. It is inclosed in a semicartilaginous case, and I satisfactorily traced it into the extreme point of the caudal extremity of the animal: it presents a thin flattened appearance, so much so that no trace of a central canal is perceptible; but immediately posterior to the brain, the rudimentary corpora restiformia of the two lateral longitudinal columns diverge to form a large excavation, which is covered over by a net-work of delicate vessels, a sort of plexus choroides; this is the fourth ventricle.

Amongst the true osseous fishes I have found a canal traversing the spinal marrow with this dilatation or ventricle at its superior portion, in the eel (*Anguilla*), perch (*Percu fluviatilis*), gurnard (*Trigla gurnardus*), cod (*Gadus morhua*), mackarel (*Scomber vulgaris*), pike (*Esox lucius*), roach (*Leuciscus rutilus*), dace (*Leuciscus vulgaris*), chub (*Leuciscus —?*), carp (*Cyprinus carpio*), and skate (*Raia —?*). In the gurnard there are six pair of ganglia developed on the superior surface, immediately posterior to the cerebellum, at the origins of the nerves distributed to the large pectoral fins; this remarkable conformation only exists in this genus. In all the other species the spinal cord is of nearly equal diameter throughout, excepting towards its termination; and in the dace I traced it running to the extremity of the tail, and ending in a point: in the moon fish (*Tetrodon mola*) it is remarkably short, and terminates in a true cauda equina.

[A similar exception to the usual length of the spinal cord in fishes, is found in the *Lophius piscatorius*, in which that organ ceases as high as the eighth vertebra, and in one instance observed by Leuret as high as the second. The rest of the canal is occupied by cauda equina.]

The superior portion of the spinal cord, which takes the name of medulla oblongata, is large and

* In the description of the spinal cord the terms anterior and posterior are used in the same signification as in the human subject; anterior to signify the surface next the bodies of the vertebræ, posterior that next the spinous processes.

broad in most fishes: on it are perceptible the corpora pyramidalia and restiformia; the *Livaria* are not yet developed. The former, situated on either side of the anterior longitudinal groove, are flattened and broad, and are distinctly seen continuous with the crura cerebri, the pons Varolii being wanting. The corpora restiformia, or cerebellic fasciculi, are situated posteriorly; they separate (as before observed) at their upper part to form the fourth ventricle, and pass afterwards into the cerebellum. According to Leuret there is no decussation of the fibres of the spinal cord in fishes.

[A singular little fish which has lately attracted the attention of naturalists, and for the reception of which Mr. Yarrell has instituted the genus *Amphiorus*, exhibits the apparent anomaly of an absence of all outward distinction between the brain and spinal cord. It is the *Amphiorus lanceolatus*, of which a very perfect specimen has lately been presented to the Museum of King's College, London, by Professor Edward Forbes.

An elaborate examination of the anatomy of this little creature has been published by Mr. John Goodsir in the Transactions of the Royal Society of Edinburgh, from which we extract the following account of its neuroskeleton and of its nervous system.

“*Neuro-skeleton*.—The osseous system, properly so called, consists of a “*chorda dorsalis*” tapering at both ends, without the vestige of a cranium, and of a dorsal and ventral series of cells, the germs of superior and inferior inter-spinous bones and fin rays. The “*chorda dorsalis*” consists of sixty to seventy vertebræ, the divisions between which are indicated by slight bulgings, and lines passing obliquely from above downwards on the sides of the column. In this way a separation into individual vertebræ is rather indicated than proved to exist; for although the column has certainly a tendency to divide at the points above-mentioned, yet that division is rather artificial than natural. There is no difficulty in ascertaining above sixty divisions, those at each end above the number stated run so much into one another that no correct result can be obtained.

“The *chorda dorsalis* is formed externally of a fibrous sheath, and internally of an immense number of laminae, each of the size and shape of a section of the column at the place where it is situated. When any portion of the column is removed, these plates may be pushed out from the tubular sheath, like a pile of coins. They have no great adhesion to one another, are of the consistence of parchment, and appear like flattened bladders, as if formed of two tough fibrous membranes pressed together.

“As the fibres of the sheath are principally circular, provision is made for longitudinal strains on the column by the addition of a superior and inferior vertebral ligament, as strong cords stretching along its dorsal and ventral aspects. The superior ligament lies immediately under the spinal cord, and may be recognized as a very tough filament, when the column is torn asunder, or some of the vertebræ removed. The inferior ligament may be



Fig. 350.

The nervous system of *Amphioxus lanceolatus*. *a, a*, the spinal cord; *b*, the first pair of nerves; *c*, the dorsal; *d*, the ventral branch of the second pair.

raised from the inferior surface of the column in the form of a tough ribbon. From the sides of the column aponeurotic laminae pass off to form septa of attachment between the muscular bundles; and along the mesial plane above the column, a similar lamina separates the superior bundles of each side, and by splitting below and running into the sides of the column, forms a fibrous canal for the spinal cord. Foramina exist all along the sides of this canal for the passage of the nerves. A similar septum is situated along the inferior part of the column, from the part where the inferior muscular bundles unite at the anus, to the extremity of the tail. Along the superior edge of the aponeurotic septum, between the dorsal muscular bundles, and stretching from the anterior point of the vertebral column to a point beyond the anus, and half embedded between the superior extremities of the muscles, is a series of closed cells of a flattened cylindrical form, adhering firmly to one another by their bases, so as to present the appearance of a tube flattened on the sides with septa at regular distances. Each of these cells is full of a transparent fluid, in the centre of which is an irregular mass of semi-opaque globules, apparently cells. This series of cylindrical sacs consists of the rudiments of inter-spinous bones, and probably of fin rays, and is attached below to the fibrous inter-muscular septa, half covered on each side by the lateral muscles, and en- closed above by the tegu- mentary fold which constitutes the dorsal fin.

"A similar series of cells, with the same relations, is situated on the ventral surface of the body, and stretches from the spot where the abdominal folds terminate, to a point nearly opposite the termination of the dorsal series.

"Nervous system.—The spinal cord is

situated on the upper surface of the chorda dorsalis, enclosed in the canal formed in the manner above described. When the whole length of this canal is displayed by removing the muscles, and then carefully opened, the spinal cord is seen lying in the interior, with nerves passing out from it on each side. It stretches along the whole length of the spine, is acuminate at both ends, and exhibits not the slightest trace of cerebral development. In its middle third, where it is most developed, it has the form of a ribbon, the thickness of which is about one-fourth or one-fifth of its breadth; and along this portion, also, it presents on its upper surface a broad, but shallow groove. The other two-thirds of the cord are not so flat, and are not grooved above, are smaller than the middle third, and taper gradually; the one towards the anterior, the other towards the posterior extremity of the vertebral column. A streak of black pigment runs along the middle of the upper surface of the cord. It is situated in the groove already described, and is in greater abundance anteriorly and posteriorly, where the nerves pass off at shorter intervals, than at the middle or broadest part of the organ. From fifty-five to sixty nerves pass off from each side of the cord; but, as the anterior and posterior vertebræ are very minute, and run into one another, and as the spinal cord itself almost disappears at the two extremities, it is impossible to ascertain the exact number, either of vertebræ or of spinal nerves. These nerves are not connected to the spinal marrow by double roots, but are inserted at once into its edges in the form of simple cords.

"The nerves pass out of the intervertebral foramina of the membranous spinal canal, divide into two sets of branches, one of which run up between the dorsal muscular bundles (dorsal branches); the other (ventral branches) run obliquely downwards and backwards on the surface of the fibrous sheath of the vertebral column; attach themselves to the antero-posterior aspect of each of the inferior muscular bundles, and may be distinctly traced beyond the extremity of each bundle. When an entire animal is examined by transmitted light, and a sufficient magnifying power, the anterior extremity of the spinal cord is observed, as before mentioned, to terminate in a minute filament above the anterior extremity of the vertebral column. The first pair of nerves is excessively minute, and passes into the membranous parts at the anterior superior angle of the mouth. The second pair is considerably larger, and, like the first pair, passes out of the canal in front of the anterior muscular bundle. The second pair immediately sends a considerable branch (corresponding to the dorsal branches of the other nerves) upwards and backwards, along the anterior edge of the first dorsal muscular bundle. This branch joins the dorsal branch of the third pair, and, passing on, joins a considerable number of these in succession, and at last becomes too minute to be traced farther. After sending off this dorsal branch, the second pair passes downwards and back-

wards on each side above the hyoid apparatus, and joins all the ventral branches of the other spinal nerves in succession, as its dorsal branch did along the back. This ventral branch of the second pair is very conspicuous, and may be easily traced along the line formed by the inferior extremities of the ventral divisions of the muscular bundles, the ventral branches of the other nerves joining it at acute angles between each bundle. It may be traced beyond the anus, but is lost sight of near the extremity of the tail. Twigs undoubtedly pass from the spinal and lateral nerves towards the abdominal surface of the body, but, on account of their minuteness, and the difficulty of detecting them in detached portions of the abdominal membrane, they could not be satisfactorily seen.

"When a portion of the spinal cord is examined under a sufficient magnifying power, it is seen to be composed entirely of nucleated cells, very loosely attached to one another, but enclosed in an excessively delicate covering of pia mater. The cells are not arranged in any definite direction, except in the middle third of the cord, where they assume a longitudinal linear direction, but without altering their primitive spherical form. The black pigment, formerly mentioned as existing more particularly on the upper surface and groove, is observed to be more abundant opposite the origin of the nerves; and, as it is regularly arranged in this manner in dark masses along the anterior and posterior thirds of the cord, the organ in these places, on superficial inspection, resembles much the abdominal ganglionic cord of an annulose animal. Along the middle third the pigment is not so regular, but appears in spots at short intervals. When any portion of the cord, however, is slightly compressed, and microscopically examined, it becomes evident that there is, along the groove and mesial line of its upper surface, a band, consisting of cells of a larger size than those composing the rest of the organ. Some of these cells only are filled with black pigment, but all of them contain a fluid of a brown tint, which renders the tract of large cells distinctly visible. When the compression is increased the cells burst; and the fluid which flows from the central tract is seen to contain jet-black granules, which may be detected as they escape from the cells.

"The nerves consist of primitive fibres, of a cylindrical shape, with faint longitudinal striae. The primitive fibres of a trunk pass off into a branch, in the usual way, without dividing; and, where the trunks join the spinal cord, the primitive fibres are seen to approach close to it, but without passing into it. The greater part of the slightly protuberant origin consisting of the nucleated cells of the cord, with a few pigment cells interspersed, the exact mode of termination of the central extremities of the primitive nervous fibres could not be detected."

We hope we may be excused for quoting the following additional remarks.

"One of the most remarkable peculiarities

in the Lancelet is the absence of the brain. Retzius, indeed, describes the spinal marrow as terminating considerably behind the anterior extremity of the chorda dorsalis, in a brain which exhibits scarcely any dilatation; but careful examination of the dissection of my own specimen, which I have also submitted to the inspection of Dr. John Reid, and of other competent judges, has convinced me that the spinal cord, which may be traced with the greatest ease to within 1-16th of an inch of the extremity of the chorda dorsalis, does not dilate into a brain at all. It may be urged that we ought to consider the anterior half of the middle third of the spinal marrow, where it is most developed, to be the brain, and all that portion of the chorda dorsalis which is in connection with the branchial cavity, as the cranium. That this does not express the true relation of the parts, is evident from the fact, that this portion of the cord, to its very extremity, gives off nerves, which are too numerous to be considered as cerebral, but more especially from the mode of distribution of the first and second pairs, which, in my opinion, proves the anterior pointed extremity to be the representative of the brain of the more highly developed vertebrata. A brain of such simplicity necessarily precludes, on anatomical grounds alone, the existence of organs of vision and of hearing. These special organs, developed in the vertebrata at least, in a direct relation with the cephalic integuments and the brain, could not exist, even in the form of appreciable germs, in the Lancelet. The black spot which Retzius took for the rudiment of an eye may probably have been, what also deceived me at first, a portion of the black mud which floats about in the branchial cavity, and which adheres obstinately to the parts in the neighbourhood of the oral filaments. The first pair of nerves, although very minute, in accordance with the slight development of the parts about the snout, and the want of special organs of sense, might, from their position and relations, be considered as corresponding to the trifacial in the higher vertebrata. The second pair appears to be the vagus, not only from its distribution as a longitudinal filament on each side of the body, as in other fishes, but also from its relations to the hyoid apparatus and branchial cavity, to which division of organs the eighth pair of fishes is specially devoted. The distribution of a branch of this nerve, however, along the base of the dorsal fin, and the course of the posterior part of the main branch, would appear to shew that this nerve, which I have provisionally denominated the vagus, is, in fact, the trifacial, which, in the higher fishes, is not only distributed to all the fins, but holds exactly the same relations to the dorsal and anal fins, and to the spinal nerves, as the nerve now under consideration in the Lancelet.

"The peculiarities in the structure of the spinal cord are not less remarkable than those of its configuration. It is difficult to understand, according to the received opinions on the subject, how a spinal cord destitute of

primitive fibres or tubes, and composed altogether of isolated cells, arranged in a linear direction only towards the middle of the cord, can transmit influences in any given direction; and more especially how the tract of black or grey matter, if it exercises any peculiar function (excito-motory) communicates with the origin of the nerves. The nerves, also, are remarkable, originating in single roots, and containing in their composition one kind only of primitive fibres (cylindrical)."]

Fig. 351.



Brain and portion of spinal marrow of *Gadus morhua* (Cod-fish), about natural size.

The brain, especially in the lowest of the fishes, presents quite the appearance of a series of ganglia developed on the superior surface of the cords of the spinal marrow (fig. 351, a, b, c). In many species it is extremely small, and by no means fills the cranial cavity; in the mackerel, the volume of the brain and of the cavity destined to receive it are nearly equal. Its very small size is at once evident by comparing its weight with that of the whole body of the animal: thus in a chub, weighing 842 scruples, the brain weighed only one scruple, the proportions being as 100 : 84200; in a carp, weighing 11280 grains, the brain weighed only fourteen grains, the proportions being as 100 : 80600; in a roach, weighing 5030 grains, the brain weighed only nine grains and a half, the proportions being as 100 : 52,900; and, as before observed, in a lamprey weighing 370 grains, the brain weighed only four-tenths of a grain, the proportions being as 100 : 142,500. [In Leuret's table a discrepancy still more striking may be observed. This author gives as a mean the proportion 1 : 5668.*] We thus observe how small is the proportion which the size of the brain bears to that of the rest of the body, and consequently how imperfect is as yet the development of the encephalic mass.

* *Système nerveux*, t. i. p. 153.

On taking a general review of the conformation of the cerebral masses forming the brain of fishes, we find it to consist of a suite of ganglia arranged behind each other—two pairs and a single one: 1st, there are two ganglia or lobes, situated the most anteriorly, the *olfactory lobes*; immediately behind which are two others, generally of larger size, the *optic lobes*; and behind these, again, is a single ganglion or lobe, situated in the median line, the *cerebellum*. On the inferior surface, immediately underneath the optic lobes, are two more ganglia. The names that have been given to these parts are extremely various; and respecting the relations and analogies which they bear to the brain of the higher animals, great difference of opinion exists.

1st. The olfactory tubercles, or *first cerebral mass* (figs. 351 and 352, a, a), which, with Arasky,* Serres,† Desmoulins,‡ Carus,§ and Tiedemann,|| and contrary to Collins,¶ Monro,** Camper,†† Ebel,‡‡ Treviranus,§§ and Cuvier,|||| I consider as analogous to the cerebral hemispheres of man, are generally of small size, and contain no cavity (fig. 351, b). In the eel they consist of three pairs of ganglia, which increase in comparative size from before to behind; in the carp and mackerel, of only one

Fig. 352.



Brain and portion of spinal marrow of *Leuciscus* (Chub), about natural size.

a, first cerebral mass or olfactory tubercle. b, second cerebral mass or optic lobe. c, third cerebral mass or cerebellum. d, spinal marrow, with its posterior longitudinal fissure. e, fourth ventricle. k, olfactory nerve. l, tuberculous enlargement of the olfactory nerve.

* *De piscium cerebro*.

† *Anatomic Comparée du Cerveau*.

‡ *Comparative Description of the Brain in the Four Classes of Vertebrated Animals*.

§ *Anatomic Comparée*.

|| *Anatomy of the Fœtal Brain*. This anatomist considers them as more particularly "analogous to the corpora striata, on the external borders of which the membranous hemispheres are not yet elevated."

¶ *System of Anatomy*.

** *Anat. of Fishes*.

†† *Memoir on the Ear of Fishes*, 1762—1774.

‡‡ *Observationes Neurologiæ ex Anatome Comparata*, 1788.

§§ *Memoir on the Brain*, 1817.

|||| *Leçons d'Anatomic Comparée*.

ganglion, situated in the median line; in the perch, gurnard, cod, pike, roach, chub, carp, and dace, of a pair of ganglia, and this is the most usual arrangement. In the skate, one of the Plagiostome fishes, where the brain is altogether more highly developed, there is one large ganglion or cerebral mass; it is solid, but in some of the sharks it contains a cavity. From these eminences, whatever be their number, the olfactory nerves (processes or lobes) arise (*figs.* 350 and 351, *k, k*), which, running together in an osseous canal for some little distance, diverge, and form large tubercles on the cribriform plate of the ethmoid bone (*fig.* 352, *l*); from these tubercles nerves arise, which are distributed to the pituitary membrane of the nose.

2dly. The optic lobes, or *second cerebral mass* (*figs.* 351 and 352, *c, b*), which Collins,* Monro,* Camper,* Ebel,* Treviranus,* and Cuvier,* considered as analogous to the cerebral hemispheres of the mammalia, but which, with Serres,† Desmoulins,‡ Arsaky,† Carus,† and Tiedemann,† I consider as analogous to the tubercula quadrigemina, are generally of large size in fishes, and contain internal tubercles and cavities, which communicate with the fourth ventricle. These masses may be said to arrive in this class at their maximum of development, and we may recollect to have traced out their first rudiments in the cerebral ganglion of the Gasteropodous Mollusca, and to have noticed their successive complication of development in the varied classes of articulated animals. In the lamprey these optic lobes are larger and more developed than any other parts of the brain; and this is what we should be led to expect from the low organization and vermiform nature of these Cyclostomous fishes; they contained in their interior a cavity. In the eel, perch, cod (*fig.* 351, *c*), gurnard, mackerel, pike, roach, chub (*fig.* 352, *b*), carp, and dace, true osseous fishes, the optic lobes are well developed, and, excepting in the eel, much larger than the olfactory tubercles before them; they are hollow, and contained tubercles, which vary in number, size, and position. In the eel there are two of these tubercles in each hollow lobe, equal in size, and situated posteriorly; in the cod there are also two, the outermost being the largest, and smooth, the inner one being smaller, and constricted in the middle (*fig.* 351, *e*); in the mackerel there are two, the anterior one being exceedingly small, the posterior much larger, slightly convoluted, somewhat resembling the Greek letter γ ; in the pike there are two, and the floor of the cavity had a striated appearance; in the roach there is only one large tubercle; and in the carp there are two, the anterior being rather long, and passing backwards in a curved manner. From these lobes the optic nerves (*fig.* 351, *l*) arise, and cross each other, without, however, any other connexion than mere cellular tissue. The third, fourth, and sixth pairs have also their origins from these ganglia.

[The optic lobes have a direct relation in

point of volume with that of the eyes, and in the pleuronecta, in which the eyes are of unequal size, Gottsche states that the optic lobes are unequal.]

The tubercles situated on the inferior surface of the brain, and immediately beneath the optic lobes just described, are generally of small size, and seldom contain a cavity; between them are the infundibulum and pituitary gland, generally of very large proportional size. Respecting their analogies and names, very much difference of opinion exists. Haller termed them the inferior protuberances of the olfactory nerves;* Cuvier considered them as the true optic lobes;† Dr. Grant calls them the cerebral hemispheres, and supposes they are the representatives of those parts in the higher animals;‡ Serres considers them appendages to the optic nerves, and analogous to the tuber cinereum;§ Vicq d'Azyr,|| Arsaky,¶ and Carus, consider them analogous to the corpora mammillaria of higher animals;** Tiedemann†† does not decide upon this point, but judges (from the situation and form of the tubercles) that the latter hypothesis is the more probable one.

3dly. The cerebellum, or *third cerebral mass* (*fig.* 351, *f*; *fig.* 352, *c*), is but imperfectly developed in fishes; it is generally of a round form, and covers in the cavity formed by the divergence of the two cords of the spinal marrow and an enlargement of its canal, the fourth ventricle. In the lamprey there are scarcely any traces of a cerebellum, a thin transverse band of medullary matter being all that stands for it; the fourth ventricle is here, therefore, quite open and exposed. In the eel it is large, and of a rounded form; in the perch its summit is directed backwards; in the mackerel, forwards; in the cod (*fig.* 351, *f*) and pike it consists of a tongue-shaped lobe; in the gurnard, roach, chub (*fig.* 352, *c*), and dace, it is round, and of moderate size; in the carp it is also of a rounded form, but immediately behind and below it is situated another ganglion of smaller size, on each of which is a larger ganglion, principally destined for the origin of the branchial nerves, thus rendering the structure of the cerebellum very complicated, and its size very voluminous. In the Plagiostome fishes the cerebellum is much more highly developed. In the skate it is of large relative size, furnished with two lateral appendages, the commencement of lateral hemispheres, on the external surface of which transverse and longitudinal striæ were developed.

On reviewing these statements of the nervous system of the fishes, we observe two things that more particularly mark its low organization—the equality and the horizontal position of the brain and spinal marrow. In fact, as regards

* Opera minora, vol. ii.

† Anatomie Comparée.

‡ Lectures on Comparative Anatomy.

§ Anatomie Comparée du Cerveau.

|| Opera minora.

¶ De piscium cerebro.

** Anatomie Comparée.

†† Anatomy of the Fœtal Brain.

* Op. cit.

† Op. cit.

the mass of nervous matter, it is greatly in favour of the spinal marrow, though, as regards complexity of structure, the brain preponderates. Again, the extreme smallness of this latter compared to the rest of the body, the simple formation of the different masses composing it, and the predominance of the median one, (which in the lower animals is the only one developed,) are points that also mark its low degree of development. Still the groundwork of the most important structures has been laid, and we shall trace these identical parts in the succeeding classes of animals through various modifications of form and phases of development.

2 and 3. AMPHIBIA AND REPTILIA.—We now proceed to the Amphibia, the Batrachia of Cuvier, which, in a system of arrangement, must be considered as a class distinct from the true Reptilia; but their nervous system presenting so great a similarity in structure and conformation to that class, and, indeed, differing only in an inferiority of development, we will, to save time and space, notice the two classes of Amphibia and true Reptilia conjointly. The nervous system in these animals bears a great similarity in structure and development to the fishes.

The spinal cord presents much the same character as in the class just described, with regard to its relative size, its extent, (excepting in the frog,) and its physical conformation. In a species of Triton weighing 39 grains, the spinal marrow weighed $\frac{1}{4}$ grain, and the brain only $\frac{1}{4}$ grain, the proportion being as 100 to 180. We thus observe that the weight of the spinal marrow preponderates over that of the brain, although not to so great an extent as in the fishes, in consequence of the increased development of the latter. In most of the Amphibia, and in all the Reptilia, the spinal cord passes down the whole length of the caudal vertebræ, as in the fishes, but to this the frog forms an exception. In that animal it descends no lower in its adult state than barely midway between the anterior and posterior extremities, and terminates by a few nervous filaments, which pass downwards towards the sacrum; in the young and tadpole state, however, it is prolonged into the coccygeal vertebræ, and terminates in a point. The form and structure of the spinal cord, and of the medulla oblongata, differ but little from what has been described in the fishes. In the triton and frog there is a longitudinal fissure on its anterior and posterior aspects and a central canal communicating with the cavity of the fourth ventricle which is very large, covered over by a vascular plexus, is formed in the same manner, and bears great resemblance to the fourth ventricle described in the lamprey: in the lumbar region the spinal cord is thickened where the nerves of the extremities are given off; in the tadpole state, however, no such enlargement is visible. Amongst the true Reptilia, in the ringed snake (*Coluber natrix*), lizard (*Lacerta viridis*), and turtle (*Testudo mydas*, fig. 353), the spinal cord has an anterior and posterior longitudinal fissure, and a central canal (g) communicating

with the fourth ventricle (h), which in the ringed snake and lizard is small, but deep; in the turtle, large, but shallow, and partly covered in by the cerebellum. According to Bojanus,* the spinal cord in the Chelonia becomes enlarged where the nerves for the anterior and posterior extremities are given off, and very thin between those enlargements. Carus† has observed the same enlargements, but in a less degree, in a young crocodile.

The brain is composed of a suite of ganglia approaching very much in form and character to the fishes, especially the Rays and Sharks. In the triton (*Triton cristata*), frog (*Rana temporaria*), viper (*Coluber verus*), ringed snake (*Coluber natrix*), lizard (*Lacerta viridis*, fig. 354), and turtle (*Testudo mydas*, fig. 353),

Fig. 353.



a, first cerebral mass or cerebral hemispheres. b*, first cerebral mass cut open, shewing its internal cavity and tubercle. b, second cerebral mass or optic lobe. c*, second cerebral mass cut open, shewing the small internal cavity. c, third cerebral mass or cerebellum, turned slightly upwards. f, posterior longitudinal fissure of spinal cord. g, central canal of spinal cord. h, fourth ventricle. i, olfactory nerve. k, bulbous enlargement at the origin of the olfactory nerve cut open, shewing its internal cavity. l, bristle shewing the communication between the cavity of the olfactory nerve and the cerebral hemisphere. m, bristle shewing the communication between the cavity of the optic lobe and the fourth ventricle. n, bristle passed along the central canal of the spinal cord. o, bristle passed under the cerebellum to raise it upwards, to shew the fourth ventricle more distinctly.

Brain and portion of spinal marrow of *Testudo mydas* (turtle), about natural size.

it fills the cranial cavity destined to receive it, though that cavity is very small when compared with the whole head; thus the size of the head is no criterion for the size of the brain. Its weight, too, when compared with the body, is another proof of its small size. In a turtle weighing upwards of 50 pounds, the brain (with the olfactory nerves, and a very small portion of the spinal marrow), weighed only 77 grains, the proportions being as 100:454,500; and, as before observed, in a triton weighing 39 grains, the brain weighed only $\frac{1}{4}$ grain, the proportions being as 100:27,300.

On taking a general review of its structure, we find, as before, three principal parts to oc-

* *Anatome testudininis Europææ.*

† *Op. cit. vol. i. p. 78.*

copy our attention,—the olfactory tubercles, situated most anteriorly, the optic lobes, situated posteriorly to these, and the cerebellum.

1st. The olfactory tubercles, or *first cerebral mass* (figs. 352, 353, *a, a, a*), now become obviously the cerebral hemispheres, are of an increased proportional size, are commencing to cover the tubercula quadrigemina, and contain a cavity which was first developed in the Plagiostome fishes; they are very various as to form. Amongst the Amphibia, in the triton they are elongated and oblong; in the frog, more oval they are united at their anterior parts by a commissure, but posteriorly they are separated. Amongst the true Reptilia, in the viper and ringed snake they are of a rounded form, and extended laterally; in the lizard and turtle they are oval (figs. 353, 354, *a, a*); in the crocodile they are more extended laterally. On cutting into them, in the turtle there is found an oblong tubercle analogous to the corpus striatum (fig. 353, *b**), on the inner side of which is a plexus choroides. From the anterior part of these hemispheres in the different animals mentioned, the olfactory nerves arise, and run forwards to the cribriform plate of the ethmoid bone, on the upper surface of which, in the viper and lizard, they form a bulbous enlargement (fig. 354, *g*); in the turtle this is wanting, but at their origin they form a large round hollow swelling, situated immediately anterior to the cerebral hemispheres, and communicating with the cavities in their interior (fig. 353, *i, k, l*).



Fig. 354.

Brain and portion of spinal cord of *Lacerta viridis* (lizard), slightly magnified.

a, first cerebral mass or cerebral hemispheres. *b*, second cerebral mass or optic lobes. *c*, third cerebral mass or cerebellum. *d*, spinal cord, with its posterior longitudinal fissure. *e*, fourth ventricle. *f*, Pineal gland. *g*, olfactory nerves, with their bulbous enlargements.

2d. The optic lobes, or *second cerebral mass* (figs. 353, 354, *b, b, b*), are of small size, and are more solid than the same parts in the fishes, the internal cavity being smaller: we thus see them gradually approaching to the form and character of the tubercula quadrigemina of the Mammalia, and of man. In the triton, frog viper, ringed snake, lizard (fig. 354), and turtle (fig. 353); they are of a rounded form, and situated on a plane immediately posterior to the cerebral hemispheres. In all these species there is found also, immediately anterior to them, and partly covered by the cerebral hemispheres, a pair of small ganglia, analogous to the optic thalami of the human brain, on the superior surface of which was situated the pineal gland (fig. 354). These different eminences give origin to the fibres of the optic nerves.

3d. The *third cerebral mass*, or cerebellum (figs. 353, 354, *c*), presents some interesting grades of development in these two

classes of animals. In all of them it is small, in most of them extremely small, and covers in the fourth ventricle in a similar manner to what has been described in the fishes. In the triton and frog it consists of a thin transverse band of medullary matter, precisely analogous to the cerebellum of the lamprey, and, as in that animal, leaving the fourth ventricle quite open and exposed: in the viper and lizard (fig. 353) it presents a similar appearance, but the band of medullary matter is rather thicker; in the turtle (fig. 352) it consists of a tongue-shaped lobe, very similar to the cerebellum of the cod: there are very distinct lateral appendages, the rudiments of which we first observed in the Plagiostome fishes, and which we shall trace in the succeeding classes to increased degrees of development: these lateral appendages are found also in the crocodile; they lead us, by strict analogies, to the cerebellum of the birds.

On reviewing these statements of the nervous system of the Reptilia, we observe that the equality and horizontality of the brain and spinal marrow again claim our attention as marks of low organization. Still, however, the preponderance of the spinal marrow over the brain is less, while the weight of this latter, compared with the body, is greater. The first cerebral mass has increased in size; cavities are developed in its interior, and it is united into two portions, which are divided by a commissure. The second cerebral mass, or tubercula quadrigemina, has decreased in size, and the cavities are much smaller. The third cerebral mass, or cerebellum, is in the lower Reptilia imperfectly developed, but in the higher ones it is of some size, and marked by external striæ.

4. AVES.—In the class Aves, or birds, the nervous centre has acquired a high degree of development in all its parts, but particularly as regards the cerebellum, and the different portions composing the cerebral mass are arranged more above and less behind each other. The spinal cord (fig. 355, *d*) is of less relative size, and of less extent, than in the fishes and reptiles, but it still is traversed by an anterior and posterior longitudinal fissure, and still contains a central canal. In a pigeon weighing (according to Carns) eight ounces, (360 grains) the brain weighed 37 grains, and the spinal marrow only 11 grains, the proportion being as 100:30. We thus observe that the brain now preponderates in size over the spinal cord for the first time; this at once marks its increased development. Where the nerves supplying the anterior and posterior extremities are given off, the spinal cord presents distinct enlargements, the inferior of which is the largest, and is placed in the sacrum: this may be considered as the termination of the spinal cord, for Carus considers that portion passing through the coccygeal vertebra to be only a large terminal filament. A canal passes through the whole extent of the spinal cord, which, at the inferior enlargement, forms a large and remarkable excavation, called the

rhomboidal sinus: this may be seen in the goose. The medulla oblongata, with the pyramidal and cerebellar fasciculi, present similar characters to the same parts in the fishes; the corpora olivaria, and pons Varolii, are not yet developed.

The brain of birds is composed of a similar number of parts as in the reptiles, but they are more highly developed, and they are no longer arranged in a longitudinal series as formerly, but more on the top of each other. In the sea-gull (*Larus cyanorhynchus*, fig. 355), snipe (*Scolopax gallinula*), red start (*Motacilla* —?), goldfinch (*Fringilla carduelis*), fowl (*Phasianus gallus*, fig. 356), pigeon (*Columba* —?), and hawk (*Falco nisus*), the brain fills entirely the cranial cavity, this cavity now corresponding exactly with the size and form of the head. It is of increased relative size compared with the body: in a pigeon, weighing according to Carus 3360 grains, the brain weighed 37 grains; the proportions being as 100:9,100.

On taking a review of its structure, we find three principal portions, as heretofore, to occupy our attention, the conformation of each being very uniform in the whole class: 1st, the cerebral hemispheres; 2d, the optic lobes; 3d, the cerebellum.

1st. The cerebral hemispheres, or first cerebral mass, are large (figs. 355, 356, a, a), of greater relative size than any other parts of the brain, and vary but little in form; in the embryo

Fig. 355.

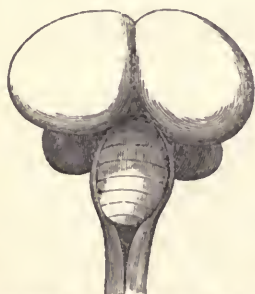

Brain and portion of spinal marrow of *Larus cyanorhynchus* (sea-gull), about natural size.

a, a, first cerebral mass or cerebral hemispheres. b, b, second cerebral mass or optic lobes. c, third cerebral mass or cerebellum, with its transverse grooves. d, spinal cord, with its posterior longitudinal fissure.

chick on the sixteenth day, however, I found them very little larger than the optic lobes (fig. 357, a). In the sea-gull and snipe they are of an oblong form, and larger posteriorly; in the hawk more round and short; in the red-start, goldfinch, pigeon, and embryo chick, on the twentieth day, more lengthened in form and covering quite the optic lobes (fig. 357, a). In the ostrich they are also lengthened and approach very much the form and characters of the same parts in the lower Mammalia. These hemispheres are united to each other by a commissure (the anterior commissure); above

Fig. 356.



Fig. 357.



Fig. 356. Brain and portion of spinal cord of *Phasianus gallus* (fowl), embryo state, age 16 days, slightly magnified.

a, a, first cerebral mass or cerebral hemispheres of a triangular form. b, b, second cerebral mass or optic lobes, touching at their inner borders. c, third cerebral mass or cerebellum, small. d, spinal cord, with its posterior longitudinal fissure. g, olfactory nerves.

Fig. 357. The same, age 20 days, slightly magnified.

a, a, first cerebral mass or cerebral hemispheres, oval in form. b, b, second cerebral mass or optic lobes, widely separated from each other. c, third cerebral mass or cerebellum, greatly increased in development and pushing asunder the optic lobes. d, spinal cord, with its posterior longitudinal fissure. g, olfactory nerves.

this there is another one, which Meckel considers as the first rudiment of the corpus callosum;* they contain cavities which are true lateral ventricles, and in which is a tubercle or enlargement corresponding to the corpus striatum of the Mammalia. From the anterior part of this primary cerebral mass the olfactory nerves arise (figs. 356, 357, g, g), and pass forwards to the cribriform plate of the ethmoid bone; their origin is marked by two distinct enlargements, which are hollow and communicate with the lateral ventricle.

2d. The optic lobes, or second cerebral mass, (fig. 355, b), are of small size, and are more widely separated from each other than in the preceding classes, though they still are connected by a medullary membrane corresponding to the roof of the aqueduct of Sylvius. In the embryo of the chick on the sixteenth day, however, these parts, as before observed, are nearly as large as the cerebral hemispheres, their inner borders touching each other, as in the reptiles and fishes (fig. 357, b): at the twentieth day they are widely separated (fig. 356 b). In the sea-gull (fig. 355), snipe, hawk, red-start, goldfinch, fowl, and pigeon, they are of a rounded form, and situated immediately beneath the cerebral hemispheres. On cutting into them in the sea-gull and pigeon, they are found to contain a cavity, which, in the former, is very small, in the latter larger, and containing a solitary dark-coloured tubercle: their cavities communicate with the third ventricle. Between these optic lobes, and immediately inferior to the cerebral hemispheres, in the pigeon, there is situated a pair of ganglia, of a flattened form (the existence of which has been before noticed in the

* Archiv. für Physiologie.

preceding classes) analogous to the optic thalami of the brain of man: between them is the canal leading to the infundibulum.

3d. The cerebellum, or *third cerebral mass*, (*fig. 355, c*), is particularly well developed, exhibiting an amazingly increased degree of organization when compared with the preceding classes, and bearing great analogy to the cerebellum of the higher animals. In the before-mentioned species it consists of a more or less rounded median lobe, with very small lateral appendages; its external surface is marked by transverse sulci, varying in number, that extend a short distance into the interior of its substance. On cutting into it in the seagull, fowl, and pigeon, the appearance of the arbor vitæ is slightly perceptible. In the embryo of the chick on the sixteenth day, however, the cerebellum is very small, not yet sufficiently developed to separate the optic lobes; very slight traces only of grooves were apparent on its surface (*fig. 356, c*). On the twentieth day it presents all the characters of the full-grown bird, both as regards relative size, position, and external striæ (*fig. 357, c*).

Fig. 358.



Brain and portion of spinal cord of *Lepus cuniculus* (rabbit), natural size, left hemisphere sliced.

a, first cerebral mass or cerebral hemispheres, slightly grooved on the external surface. *b*, corpus callosum, short. *c*, cavity of lateral ventricle. *d*, portion of corpus striatum. *e*, tænia semicircularis. *f*, hippocampus major, the superior surface sliced. *g*, masses or ganglia of the olfactory nerves, with their cavities. *h*, bristle passed, shewing the communication between the cavity of the olfactory nerve and the lateral ventricle. *k*, second cerebral mass or tubercula quadrigemina,—the anterior pair the largest. *l, l*, third cerebral mass or cerebellum, very much grooved. *d**, spinal cord, with its posterior longitudinal fissure.

On reviewing these statements of the nervous system in the birds, we observe that the brain and spinal marrow are no longer situated on the same horizontal plane, and that the preponderance is now in favour of the brain:

its weight, too, when compared with the body, is greater; and the ganglia composing it are more above, and less behind each other. The primary cerebral mass has now acquired so high a degree of development as to surpass the others in size; no convolutions are, however, yet apparent on its surface; no large commissure yet exists to unite them. The optic lobes, or median cerebral mass, are small, separated from each other, and their cavities have decreased. The cerebellum, or third cerebral mass, is large; traces of lateral lobes are evident, and external striæ are perceptible.

MAMMALIA.—In the last and highest class, the Mammalia, will be found some most interesting grades of development and structural forms of the cerebral mass to arrest our attention, and we shall observe how rapidly the different parts are added, and those already formed are more highly developed, to constitute the complex brain of the human species. The spinal cord (*figs. 358, 321, 322, 323, d**) is of still less relative size than in the preceding classes; it has an anterior and posterior longitudinal fissure. In a full-grown mouse, weighing 227 grains, the spinal marrow weighed one grain and a half, the brain six grains and a half—the proportions being as 100:22. We thus observe that the former is of much less relative size than the latter.

The following is a table shewing the relative proportions of the brain and spinal marrow in the four classes of Vertebrata:—

		Brain.	Spinal Marrow.
PISCES	Lamprey	as 100 :	750
REPTILIA . . .	Triton	as 100 :	180
AVES	Pigeon	as 100 :	30
MAMMALIA	Mouse	as 100 :	22

The spinal cord passes lower down the vertebral column than in man, but terminates by a true cauda equina, as in the bat and mouse, in which latter animal it is continued into the sacrum, but not into the caudal vertebrae, as in the preceding classes. In the bat the spinal cord descends no lower than the eleventh dorsal vertebra, a conformation rather unusual: * the fissure on its posterior surface was deep in those animals, but it becomes less evident as we approach the human species. It presents three distinct enlargements in its course: a superior one, the medulla oblongata; a median, and a posterior one, where the nerves for the extremities are given off: this is the case in the mouse and bat, though in the former animal the superior and median enlargements are so closely approximated as to render the spinal cord of great thickness in the thoracic region of the body. †

The following is a table shewing the relative proportions of the body and brain in the four classes of Vertebrata:—

* Meckel (Archiv. für Physiologie) also states, that in the hedgehog the spinal cord terminated in the thoracic vertebrae.

† Carus remarks the same thing in many of the Mammalia with a short neck; the Rodentia, for instance.

		Brain.	Body.
PISCES....	{	Carp.....	as 100 : 80,600
		Chub.....	as 100 : 84,200
		Roach.....	as 100 : 52,900
REPTILIA..	{	Lamprey...	as 100 : 142,500
		Triton.....	as 100 : 27,300
AVES.....	{	Turtle.....	as 100 : 454,500
		Pigeon.....	as 100 : 9,100
MAMMALIA	{	Sheep.....	as 100 : 22,600
		Pig.....	as 100 : 32,300
		Mouse.....	as 100 : 3,500

In the brain of the Mammalia we shall find the same parts as heretofore to occupy our attention, though at an extraordinarily increased degree of development: this, however, varying greatly in the different orders. Its direction, with regard to the spinal marrow, is no longer horizontal, as we found in the fishes and reptiles, but approaching more or less to a right angle; the first traces of which inflection were perceptible in the birds. In the bat (*Vespertilio murinus*); mouse (*Mus musculus*); rat (*Mus rattus*); rabbit (*Lepus cuniculus*, fig. 358); pig (*Sus scrofa domestica*); horse (*Equus caballus*); ass (*Equus asinus*); sheep (*Ovis ammon*); deer (*Cervus dama*); mole (*Talpa Europæa*); stoat (*Mustela euninea*); cat (*Felis catus*); and monkey (*Callithrix* —? fig. 359); the brain exactly fills the cranial cavity, that cavity corresponding with the shape and size of the head. The size and bulk of the brain are greater than in any of the preceding classes, as shown by its relative weight compared with the body. In a sheep weighing, as near as could be calculated, 7466 drachms, the brain weighed 33 drachms; the proportion of the brain to the body being as 100:22600. In a pig weighing about 7116 drachms, the brain weighed 22 drachms; the proportion being as 100:32350. The brain of a horse weighed 156 drachms. In a mouse weighing 327 grains, the brain weighed 6½ grains, the proportions being as 100:3,500.

On taking a review of the structure of the brain in Mammalia, we find that it presents a great variety of form and development in its different parts. 1. The cerebral hemispheres, or first cerebral mass, which vary greatly in their size and extent, and are united in the median line by a commissure, the corpus callosum. 2. The optic lobes, or second cerebral mass, which are here small and divided into two pairs, presenting more particularly the characters of the tubercula quadrigemina in the human brain, under which name they will in future be noticed. 3. The cerebellum, or third cerebral mass, which is greatly increased in development, and presents a division into median and lateral portions.

1st. The cerebral hemispheres, or first cerebral mass (figs. 357, 353, a) are of large size, but this varies according to the order in which they are examined. In the lower ones they resemble very much the same parts in birds, with regard to their small size and their want of convolutions. In the dolphin they are very short and broad; in the ornithorynchus they are oval, and narrowed

anteriorly. In both these animals their surfaces are smooth and unconvoluted. The same occurs in the opossum and myrmecophaga didactyla, amongst the Marsupialia. In the bat they are no longer than wide (2½ lines each way), leaving the tubercula quadrigemina quite exposed; they are of a triangular form, and perfectly smooth on their surface. In the rabbit (fig. 358, a), rat, and mouse, rodent animals, they are oblong ovate, but much narrowed anteriorly. The tubercula quadrigemina are quite exposed, but scarcely so much so as in the bat; their surfaces are smooth and unconvoluted, though in the rabbit there are a few slight furrows; on their inferior surface there is a faint groove, dividing them into lobes, the rudiments of the fissura Sylvii. In the pig, horse, ass, sheep, and deer, the hemispheres are more oval in form, more convex, and less narrowed anteriorly; they extend backwards, so as quite to cover the tubercula quadrigemina, and their surfaces are marked with numerous convolutions; the fissures of Sylvius are more strongly marked, and the division into lobes is more apparent. In the stoat and cat they are similarly shaped and convoluted on their surface, and they extend backwards, covering the tubercula quadrigemina and a portion of the cerebellum. In the monkey (fig. 359, a) they are more

Fig. 359.

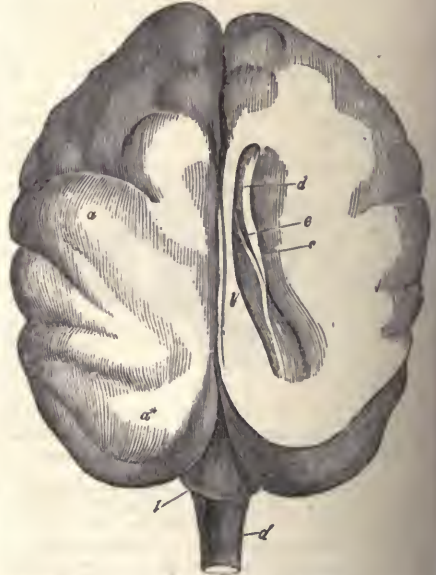

Brain of *Callithrix* —? (Monkey), natural size, right lateral ventricle exposed.

a, First cerebral mass or cerebral hemisphere, elevated and broad, and extending backwards, covering the cerebellum. a*, posterior lobe of cerebrum, free from convolutions. b, corpus callosum. c, cavity of lateral ventricle. d, portion of corpus striatum. e, tænia semicircularis. l, third cerebral mass or cerebellum. d*, spinal cord.

rounded, very much elevated, broader in the middle, and extend backwards, covering the cerebellum. The convolutions are more nume-

rous than in the preceding classes; the fissure of Sylvius is a deep groove, marking the division into anterior and median lobes, and here, for the first time, are observed the posterior lobes (*a**), as yet but of small size, narrowed posteriorly, and free from convolutions. In the orang-outang they are altogether larger, and more approaching the form and character of the human brain, covering the cerebellum entirely, and convoluted on their posterior lobes.*

These cerebral hemispheres are united by an important commissure, which makes its first appearance in mammiferous animals, the *corpus callosum*; in the lower orders, as in the bat, rabbit (*fig. 358, b*), rat, and mouse, it is very short,—shorter even than the tubercula quadrigemina; in the pig, ass, and sheep, it is longer and broader; in the stoat, cat, and monkey (*fig. 359, b*) it is increased in length and width, approaching the characters of the corpus callosum in the human adult brain.

On cutting into the cerebral hemispheres, cavities are found in their interior, the lateral ventricles. In the bat and rodent animals, as in the rabbit (*fig. 358, c*), they are of small size, but large in proportion to the hemispheres; in the pig, sheep, stoat, and cat they are larger and broader, but smaller in proportion to the hemispheres. In all these animals the anterior and descending cornua are observable; the posterior are found only in the monkey (*fig. 359, c*), where the lateral ventricles quite approach the characters of the same parts in the human adult brain. In the interior of these ventricles are to be observed the corpora striata, tænia (for the first time observable), optic thalami, and fornix. In the bat genus and Rodentia, the corpora striata are very large, forming, indeed, the greater parts of the hemispheres of the brain, and the tænia very narrow (*fig. 358, d, e*); in the pig, sheep, and cat they are oblong and smooth; in the monkey they were also oblong (*fig. 359 d, e*), and though in reality large, appear smaller, when compared with the hemispheres, than in the preceding classes,—which apparent defects of relation Tiedemann considers evidently to depend on the greater augmentation of the hemispheres. The fornix, with its appendages, is for the first time observable in this class of animals, and exists in the brains of all the animals before mentioned; in the lower orders, its relative size, particularly of the hippocampus major, is somewhat considerable.

From the anterior part of these cerebral hemispheres the olfactory nerves arise, which still possess many points of extreme interest. In the dolphin and other Cetacea, they are entirely wanting. In all the mammiferous animals before enumerated, except the Quadrumana, they consist of oblong or rounded medullary masses, situated on the cribriform plate of the ethmoid bone, from which filaments are given off to be distributed on the pituitary membrane. In the lower orders, as in the bat,

rabbit, rat, and mouse, these masses of ganglia of the olfactory nerves are situated on a plane directly anterior to the cerebral hemispheres, and may be seen on looking upon the superior face of the brain, these latter not being yet sufficiently developed anteriorly to cover them; in the pig they are nearly covered by the hemispheres; in the horse, ass, sheep, and deer, they are quite covered by them, and are only to be seen on the inferior surface of the brain; in the cat they are similarly situated, but the anterior edge of the hemispheres projects still further beyond them. In all these animals a medullary band or tract (*h*) connects them with the median lobes of the hemispheres, and in all they contain cavities (*i*), which communicate with the lateral ventricles. In the monkey the olfactory nerves (processes) consist of free, flattened, medullary bands situated on the inferior surface of the anterior lobes of the brain, precisely the same as in the human adult brain.

2dly. The optic lobes, or *second cerebral mass*, or, as they are now to be called, the tubercula quadrigemina, consist of an anterior and posterior pair of ganglia, in which cavities are no longer perceptible. They differ in size, relatively to each other as well as to the cerebral hemispheres, and in position. In the bat, rabbit (*fig. 358, k*), rat, and mouse, the *anterior* pair are the larger, and, compared with the cerebral hemispheres, are very voluminous; in the pig, horse, ass, sheep, and deer, the *anterior* pair are also the larger, but they are of *less* proportional size with the brain; in the cat and stoat the *posterior* pair are the larger; in the monkey they are nearly of *equal* size and present less relative volume, thus approaching very much the characters of the tubercula quadrigemina in the human adult brain. With regard to their position, as before observed, in the lower orders they are situated behind the cerebral hemispheres and are quite exposed, while in the higher orders they are situated underneath the hemispheres, and quite covered by them, as in the human adult brain.

3dly. The cerebellum, or *third cerebral mass* (*figs. 358, 359, l*), is remarkable for its great development; nevertheless, it passes through many grades in the different orders. In the animals before enumerated it is marked externally by transverse striæ and small convolutions, and presents a division into median and lateral lobes. The relative size of the mass itself, and of its different parts, and the number of external striæ, differ according as the animal examined is high or low in the class. In the bat it is within half a line as long as the cerebral hemispheres, the proportions being as 100 : 125; the lateral lobes are just observable, smooth on their surface, but on the large median portion there are two transverse striæ. In the rabbit (*fig. 358, l*) its proportional length in the median portion to that of the cerebral hemispheres is as 100 : 207; in the rat, as 100 : 166. The lateral lobes in both are more distinctly developed, and the striæ are better marked. In the horse its pro-

* For the length, by measurement, of the cerebral hemispheres in these different animals, see the table.

portional length is as 100 : 256. In the sheep, as 100 : 232. In the deer, as 100 : 233. The lateral lobes are very evident in all, and convolutions are observable on the external surface, particularly in the horse. In the cat its proportional length is as 100 : 200; in the stoat as 100 : 228. The external convolutions in both are numerous: in the monkey (*fig. 359, l*), the proportional length is as 100 : 305; the laminæ are numerous and small, thus approaching very much the characters of the same part in man.

The following is a table, shewing the actual and relative lengths of the cerebral hemispheres and the cerebellum in the Mammalia:—

Animal.	Length of Cerebral Hemisphere	Length of Cerebellum.	Proportions.
Bat . . .	2½ lines.	2 lines.	As 100 : 125
Rabbit .	14½ —	7 —	.. 100 : 207
Rat . . .	7½ —	4½ —	.. 100 : 166
Mouse .	4 —	2½ —	.. 100 : 160
Horse . .	64 —	25 —	.. 100 : 256
Sheep . .	36 —	15½ —	.. 100 : 232
Deer . . .	42 —	18 —	.. 100 : 233
Stoat . . .	8 —	3½ —	.. 100 : 228
Cat . . .	18 —	9 —	.. 100 : 200
Monkey	30½ —	10 —	.. 100 : 305

On cutting into its substance in many of these animals, the appearance of the arbor vitæ is more or less distinct, similar to the human cerebellum. On its inferior surface is situated its great commissure, the pons Varolii, which first makes its appearance in this class of animals, and, with the exception of the transverse fibres forming it being thinner and fewer in number, particularly in those lower orders of Mammalia where the cerebral hemispheres were small, it presents but little differences from the same part in the human adult brain. This latter remark will equally apply to the fourth ventricle, which has been an object of considerable interest, and which, from being at first an open exposed cavity, is now shut in and concealed.

[On the peculiarities of the brains of the implacental class of Mammalia, see the articles MARSUPIALIA and MONOTREMATA.]

On reviewing these statements of the nervous system in the Mammalia, we observe that the brain now preponderates greatly in bulk over the spinal marrow; this latter is also shorter, and terminates by a true cauda equina. The *first cerebral mass* has now acquired its maximum of development as regards size; the two portions of which it is composed are united by a large commissure; their exterior surface is convoluted. The *second cerebral mass* is divided into two pairs of ganglia, in which the cavities are obliterated. The *third cerebral mass* has lateral hemispheres developed, striæ and convolutions on their exterior surface, and an important commissure, the pons Varolii, on its inferior surface.

Having thus completed the investigations proposed at the commencement of this paper,

it may not in conclusion be without interest and utility to take a very rapid review of the development of the nervous system in the five large groups of animals in the system of arrangement, as follows:—

a. The nervous system (perhaps) first exists in a molecular form; that is, it is made up of globules dispersed throughout the homogeneous texture of the animal, as in the Acrita, the lower Entozoa, &c.

b. This nervous matter arranged in a longitudinal direction forms filaments. The direction which they assume is that of a ray, or nerve, and a central point, or ganglion; these latter communicate with each other by commissures, which unite them in the form of a ring. This ring is situated around the oral orifice of the animal; it takes the name of the *primary nervous ring*; and from it issue filaments in a radiated manner, as in the Echinodermata.

c. This *oral primary nervous ring* becomes more complicated in itself; ganglions are first developed on its lateral and inferior portions, from which nerves pass off in a longitudinal direction, as in the lower Mollusca, and secondly on its superior surface, as in the higher animals of this class: this superior ganglion is at first proportionally small, as in the Gasteropoda, but afterwards large, and sometimes very large, as in the Cephalopoda. It is the analogue of the tubercula quadrigemina of the higher animals.

d. This *primary nervous ring*, in its most highly developed form, now becomes repeated several times in the body of the animal; first, in an *undetermined* number, as in the Helminthoid Articulata; secondly, in a *determined* number, as in the Entomoid Articulata. These nervous rings are united by longitudinal commissures, and the most anterior one always has a highly developed ganglion on its superior surface. The uniting commissures possess two distinct nervous tracts; respiratory and sympathetic nerves exist, as in the Insecta.

e. These *primary nervous rings* are now become ganglia (brain); the uniting commissures are become primary nervous rings (spinal marrow). First, the ganglia and their commissures are nearly equally developed, and are horizontal, as in the lower Vertebrata; secondly, the ganglionic formation predominates, and its direction, with regard to the commissures, becomes more that of a right angle, as in the higher Vertebrata; thirdly, the predominance of the ganglionic formation is very much increased, and its relative direction is that of a complete right angle, as in the human species.

(John Anderson.)

NERVOUS CENTRES. (Human anatomy).—A nervous centre may be defined as a mass composed of grey and white nervous matter with which nerves are intimately connected. In a physiological point of view it is a centre of nervous action, as nerves appear to conduct to it as well as from it.

The nervous centres in the human subject are the GANGLIONS, the SPINAL CORD, and the BRAIN.

The ganglions are small masses occupying certain situations in the body. They are extremely numerous in the human body, and very variable in shape and size. One great subdivision of them, in man and the mammalia, is connected with the posterior roots of the spinal, and with certain encephalic nerves. Another class belongs to the sympathetic system. In the Invertebrata the nervous system is made up of a series of them variously disposed, with their afferent, efferent, and connecting nerves.

The spinal cord and the brain are peculiar to the great class of vertebrated animals. They may be regarded as compound ganglions, being physiologically resolvable into a series of smaller centres, which are, to a certain extent, independent of each other. Viewed anatomically, they are not so obviously divisible: in the spinal cord, in which the independent influence of separate segments may be most easily demonstrated, no anatomical subdivision is obvious, for the segments are fused together into a cylindroid body, which has a certain relation to the length and muscular activity of the animal. Indications, however, of this composite form of the spinal cord are afforded, in the marked difference of dimensions which certain parts of it present when compared with others, there being always a manifest correspondence between the size of any segment of the cord and the motor or sensitive endowment of that segment of the body which receives its nerves from it. And the case of the common gurnard (*Trigla Lyra*) may be here quoted as a remarkable instance of the development of distinct gangliform bodies on a portion of the cord, in accordance with a particular exaltation of tactile sensibility.

The brain is much more evidently made up of a series of separate centres or smaller masses, exhibiting sufficiently distinct boundaries on their surfaces, but so intimately connected by what are called *commissural* or uniting fibres, as to manifest the same kind of fusion (although to a less degree) as that noticed in the spinal cord. These gangliform bodies are so readily distinguishable from one another, that from the earliest periods of anatomical investigation each of them has been designated by a distinct name, which is generally derived from some prominent feature of the body itself, or from the name of some familiar object which it has been supposed (often fancifully) to resemble. The aggregate of these bodies is known in popular language by the name of *Brain*, (a word of Saxon origin, sometimes used in the plural); this word, however, anatomically speaking, is applicable only to the great hemispheric lobes which form the largest portion of the whole mass; and the term *Encephalon* may be more correctly used to denote the whole of the intracranial contents.

It is proposed in the present article to consider the general and descriptive anatomy of these nervous centres severally, beginning with an examination of their coverings.

COVERINGS OF THE NERVOUS CENTRES.

COVERINGS OF THE GANGLIONS. — Every

ganglion is covered by a more or less dense layer of white fibrous tissue, similar to that which forms the neurilemma of nerves. It performs precisely the same office for the elements of the ganglions that the neurilemma does for those of nerves; that is, it gives them a mechanical support, and is the medium through which bloodvessels are conveyed to their nervous matter. It is continuous with the neurilemma of the nerves which are connected with the ganglions. It is found in all forms and classes of ganglions, presenting the same essential characters. These bodies are generally surrounded by and imbedded in a considerable quantity of fat, which also involves more or less the nerves that proceed from them.

COVERINGS OF THE SPINAL CORD AND BRAIN. — These are also called the *membranes* of these centres, or the *meninges* (*μηνιγγξ*, *membrana*). They are three in number. Those of the brain are continuous with those of the spinal cord, but, as there are certain distinctive characters proper to each, it will be convenient to describe the cerebral and spinal meninges separately. They are, enumerating them from without inwards, the *dura mater*, the *arachnoid membrane*, and the *pia mater*.

The term, *mater*, *μητηρ*, originated with the Arabian anatomists, who regarded these membranes as the parents of all others in the body. Galen adopted the word *μηνιγγξ*, and distinguished the first and last of the membranes above enumerated by the adjectives *παχυτιση* and *λεπτη*. The Germans use the word *haut*, and designate these membranes as *hautige Hüllen des Gehirns und des Rückenmarkes*; *die harte Hirnhaut*, *die harte Rückenmarkshaut*, the *dura mater* of the brain and spinal cord; *die Spinnwebenhaut*, the *arachnoid*; and *die weiche Haut*, the *pia mater*.

Dura mater. — The *dura mater* is a dense membrane composed almost exclusively of white fibrous tissue. It has all the characters, physical and vital, of that texture, possessing great strength and flexibility with but little elasticity. It is freely supplied by bloodvessels, and at certain situations, which will be more particularly described by-and-bye, it separates into two laminae, which inclose prolongations of the lining membrane of the venous system, forming peculiar sanguiferous channels, which are commonly known by the name of *sinuses*. It has an apparent lamellar disposition, from the fact of its fibres being arranged in different planes. In the child a subdivision into two layers may sometimes be easily effected. Some nerves have been demonstrated in the *dura mater*; a branch of the fifth nerve has been particularly described and delineated by Arnold, as passing in a recurrent course between the laminae of the tentorium, and Pappenheim has found nervous fibres in the cerebral *dura mater* derived from the superior maxillary division of the fifth, from the fourth nerve, from the vidian, and probably also from the frontal branch of the ophthalmic.*

* Valentin Repertorium, vol. v. p. 87.

The *spinal dura mater* is in shape adapted to the vertebral canal. It is a hollow cylinder, tapering somewhat at its lower extremity to correspond with the sacral portion of the canal. It adheres very firmly all round the foramen magnum of the occipital bone. From thence it is continued down to the sacrum without forming any adhesion to bone. On the posterior and lateral surfaces it is covered by a layer of soft, oily, reddish fat, which intervenes between it and the inner surfaces of the vertebral laminae and processes, and in these situations, as well as to a less degree in front, we find a very intricate plexus of veins, some of which are of considerable size. The fatty deposit is most abundant in the sacral region. In front the *dura mater* adheres by a close areolar tissue to the posterior common ligament, and here of course the adipose tissue is deficient. At the foramen magnum the continuity of the *spinal dura mater* with that of the cranium is distinct, and here, indeed, the former appears as a funnel-shaped prolongation of the latter; both are, in truth, portions of the same membrane adapted to the difference of shape of the nervous centres with which they are respectively connected.

On the sides the *spinal dura mater* is perforated by orifices which give exit to the roots of the nerves which arise from the spinal cord. When examined from within, these foramina are found to be arranged in pairs, each pair corresponding to the point of exit of a spinal nerve. The foramen which transmits the anterior root is separated from that which gives passage to the posterior one, by a narrow slip of fibrous membrane. These foramina are slit-like in form, taking the vertical direction. On the outer surface of the *dura mater* the distinction between them is not evident without dissection, for there the fibrous membrane being prolonged from the margins of the openings around the nerves, the sheaths thus formed coalesce and surround both roots. The number of these orifices is of course the same as that of the roots of the nerves which pass through the *dura mater*.

The internal surface of the *spinal dura mater* is perfectly smooth and moist in the healthy state, owing to its being lined by the parietal layer of the arachnoid membrane. In the intervals between the orifices for the transmission of each pair of spinal nerves, it receives the pointed attachments of the *ligamentum denticulatum*, to be described more fully by-and-by.

It is evident from the preceding description that the *spinal dura mater* cannot perform the office of a periosteum to the osseous walls of the spinal canal, for at every point it is separated from them by texture of a different kind, and, moreover, the vertebrae are provided with a distinct periosteum. The prolongations of *dura mater* over the nerves at each of the intervertebral foramina serve to fix that membrane at the sides throughout the whole extent of the vertebral canal, so as to prevent its lateral displacement. At the lower extremity of the sacral canal the *dura mater* ends in a blunt

point, and from this certain processes may be traced towards the coccyx. Of these the central one is continuous with the filiform prolongation from the *pia mater*, which is inserted into the inferior extremity of the *dura mater*, and is implanted into the last bone of the coccyx. The thread-like processes which are seen on each side are the sheaths of the last sacral nerves and of the coccygeal nerve, which pass some distance in the canal before they reach the foramina for their transmission outwards.

It is easy to convince oneself that the *spinal dura mater* is far larger than would be necessary for the reception of the cord. When the fluid immediately surrounding this organ has been suffered to escape, the *dura mater* appears quite loose, flaccid, and wrinkled. By blowing air or injecting water into its canal, it may be rendered tense again. This looseness of the *dura mater* is most conspicuous at its lowest part, in the lumbar and sacral regions, where it forms, as Cruveilhier says, "autour de la queue de cheval une vaste ampoule, qui paraît n'avoir d'autre utilité que de servir de réservoir au liquide cephalo-rachidienne."

The *dura mater* adapts itself, in point of size, to the varying dimensions of the spinal canal in its different regions, which again appear to be influenced by variations in the dimensions of the spinal cord. Thus, it swells in the cervical and in the lumbar region, at both which places there are corresponding enlargements of the cord. Its most contracted portion is that which occupies the dorsal region.

Cranial dura mater.—The *dura mater* of the cranium differs in one leading circumstance from that of the spine,—namely, that it forms a periosteum to the inner surface of the cranial bones. We find it, therefore, very closely adherent to the whole interior of the cranium, and the free communication between the vessels of the *dura mater* and those of the bones serves materially to enhance the connexion between this membrane and the osseous surface. At some situations the adhesion is so very intimate that we experience great difficulty in attempting to separate the fibrous membrane from the subjacent bone. On the roofs of the orbits, the wings of the sphenoid bone, the petrous portions of the temporal bones, the margin of the occipital foramen, and opposite the sutures, the adhesion is very intimate.

This adhesion of the *dura mater* to the bones is found also to vary in degree at different periods of life. It is very intimate in old age, so much so that, in removing the calvaria, layers of bone often chip off, remaining in connexion with the fibrous membrane. In the adult, such a degree of adhesion as would give rise to this effect, ought to be regarded as morbid. In the young subject, while ossification and growth are going on, the adhesion is very intimate, so that in them great difficulty is experienced in removing the calvaria. Doubtless this intimate adhesion at this early period of life is due to the active share which the *dura mater* takes in conveying the material of nutrition and growth to the cranial parietes.

The cranial dura mater is not a simple bag. From its internal surface partition-like processes pass inwards, which serve to separate certain subdivisions of the encephalon. These are, the *falx cerebri*, the *tentorium cerebelli*, and the *falx cerebelli*.

The *falx cerebri* is a process of fibrous membrane corresponding to the mesial plane and lying in the great median fissure of the brain, where it separates the lateral hemispheres from each other. Its shape is falciform; its superior convex border corresponds to the frontal and sagittal sutures, and encloses the great longitudinal sinus; its inferior border is concave and much shorter than the superior, and corresponds to the superior surface of the corpus callosum, which connects the hemispheres of the brain. In front the falx is very narrow and almost pointed; it embraces the *crista galli* of the ethmoid bone, which appears to be enclosed between its layers. As the falx proceeds backwards it increases considerably in depth; its superior edge may be traced back to the internal occipital protuberance; its inferior edge terminates at a point corresponding to the middle line of the posterior margin of the corpus callosum. The falx cerebri contains within it, along its posterior border, a large vein, which is called the *inferior longitudinal sinus*.

The falx cerebri is continuous at its posterior border on each side with the *tentorium cerebelli*. This process is nearly horizontal in its direction; it forms a vaulted roof to a cavity (the floor of which corresponds to the occipital fossæ) in which the cerebellum is lodged. Its upper surface is convex on each side of the attachment of the posterior extremity of the falx cerebri: it supports the posterior lobes of the brain. The inferior surface is adapted to the upper convex surfaces of the cerebellar hemispheres. Its posterior and outer edge adheres to the occipital bone and to the posterior border of the petrous portion of the temporal bone, reaching as far inwards as the posterior clinoid processes of the sella Turcica. The occipital portion of this edge contains a considerable part of the lateral sinus (*fig 362, e*) and that portion which adheres to the petrous bone contains the superior petrosal sinus. The anterior or inner margin of the tentorium is concave and free in the greater part of its extent; it forms the posterior and lateral boundary of a large opening (which the sella Turcica completes in front), through which the crura cerebri and other parts connected with them pass. This margin is attached by its anterior extremities to the anterior clinoid processes, to reach which it crosses the posterior border. The crossing of these two edges at a point external to the sella Turcica gives rise to the formation of a little triangular space, the base of which corresponds to the sella Turcica; its outer angle is perforated for the transmission of the third pair of nerves, and its anterior one for that of the fourth pair.

From the inferior surface of the tentorium cerebelli at its posterior edge, a short and thick fold of very slight depth descends to the posterior edge of the foramen magnum. This is

the *falx cerebelli*; it corresponds to the median notch between the hemispheres of the cerebellum. Its anterior border is slightly concave. Two veins called *occipital sinuses* are contained in it.

The internal surface of the cranial dura mater presents the same smooth appearance as we have noticed in the spinal membrane of the same name. We observe, however, an exception to this on each side of the line along the great longitudinal sinus. Here it is very common to find the membrane presenting a peculiar cribriform appearance, which occupies a space of from half an inch to two inches in length and not more than a quarter of an inch in breadth, but exhibiting great difference in various subjects as to the number and depth of the foramina or depressions upon which the sieve-like structure depends. These depressions are caused by the presence of little bodies which grow from the layer of arachnoid that covers the brain, *glandulæ Pacchioni*, which will be described by-and-by. The anatomist may expect to find in a large proportion of adult brains a greater or less degree of adhesion between these parts of the dura mater and the edges of the hemispheres of the brain.

The dura mater is perforated by numerous orifices for the transmission of the encephalic nerves. It adheres firmly to the border of each of the foramina in the cranial bones, and is partly continued in the shape of neurilemma over the nerve that escapes through it. In the case of the optic nerve a strong fibrous sheath is prolonged from the dura mater, and at the same time that membrane appears to become continuous with the periosteum of the orbit, as if it had, opposite the optic foramen, split into two layers, one of which formed the sheath of the optic nerve, and the other applied itself to the interior of the orbit, forming a periosteum to the walls of that cavity.

Of the arteries and veins of the dura mater.—The disposition of the bloodvessels of the dura mater, both of the spine and of the cranium, deserves a special description. The former membrane derives its arteries from the numerous vessels which take their rise close to the spinal column in its various regions. These are ramifications of the abdominal and thoracic aorta or of their large primary branches. In the neck the deep cervical, the occipital, and the vertebral arteries send in numerous branches, in the back the intercostal arteries, and in the loins the lumbar arteries. These vessels pass in at the vertebral foramina, and send branches to the spinal membranes as well as to the bones themselves.

The blood which is returned from the spinal cord and its membranes, as well as from the vertebræ, is poured into a very intricate plexus of veins which surrounds the dura mater on its lateral and posterior surfaces, ramifying among the lobules of soft fat by which the exterior of that membrane is invested. This plexus is less intricate in the dorsal than in the cervical or lumbar regions; it communicates very freely with the plexus of veins which lies on the exterior of the vertebral laminae and processes (the *dorsi-spinal veins* of Dupuytren).

In front of the dura mater and situate between the outer edge of the posterior common ligament of the vertebræ and the pedicles, we find two remarkable venous sinuses which extend the whole length of the vertebral column, from the occipital foramen to the sacral region (*fig. 360*).

Fig. 360.

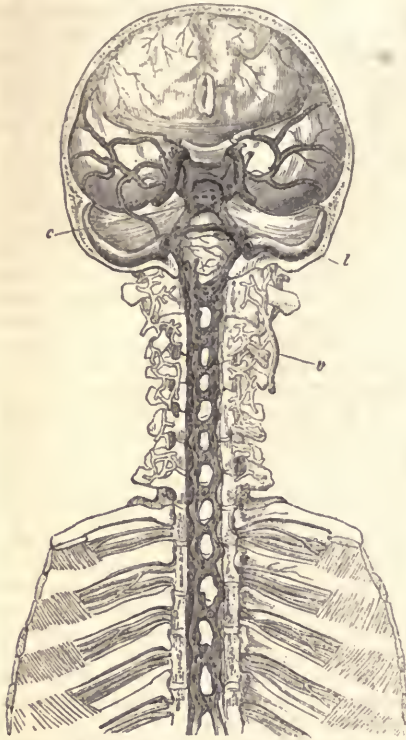

Spinal sinuses viewed from before.
(After Breschet.)

The anterior part of the basis cranii and the face have been removed, as also the bodies of the vertebræ.

l, lateral sinus descending to form its junction with the jugular vein; *c*, cavernous sinus; *v*, vertebral artery, the longitudinal sinuses with their transverse connecting veins, lying immediately behind the bodies of the vertebræ. The inferior petrosal and the cavernous sinuses appear like continuations of them within the cranium, and the transverse and circular sinuses are analogous to the transverse spinal branches.

These veins are loosely covered by a thin process, which is prolonged from each margin of the posterior common ligament, and which is sufficiently transparent to allow them to be seen through it without removing it. They have been known since the time of Fallopius, and were described by Willis as the *longitudinal spinal sinuses*. In calibre they present many inequalities, being dilated at one part and constricted at another, according to the number and size of the vessels which communicate with them. The sinuses of opposite sides run parallel to each other and communicate by cross branches, which pass between the posterior surface of the body of each vertebra and the pos-

terior common ligament. These cross branches present the same characters as the sinuses themselves, being of variable calibre, and presenting the greatest degree of dilatation at their middle. At this point these branches receive veins which emerge from the spongy texture of the bodies of the vertebræ (*basi-vertebral veins* of Breschet) (*fig. 361, d*). The vertebral sinuses diminish in

Fig. 361.

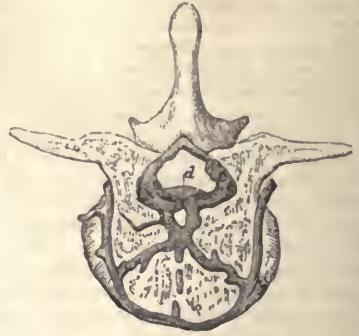

Basi-vertebral veins, converging from the spongy structure of the body of the vertebra.

size at the highest part of the vertebral canal, and passing through the anterior condyloid foramina, communicate with the internal jugular veins. In the sacral region they diminish considerably likewise, and are lost in becoming continuous with the lateral sacral veins and other small veins in that region; and they communicate with the deep and superficial vertebral veins in the neck, with the intercostal veins in the back, and with the lumbar ones in the loins. They evidently differ from the sinuses of the cranial dura mater in not being enclosed between two layers of fibrous membrane as those vessels are.

Bloodvessels of the cranial dura mater.—The bloodvessels of the cranial dura mater are much more numerous than those of the spinal, in consequence, no doubt, of that membrane performing the office of a periosteum to the cranial bones. The arteries are derived from numerous sources; in front from the ophthalmic and ethmoidal arteries, in the middle from the internal maxillary artery by the *middle meningeal*, which enters the cranium at the foramen spinosum, and by small branches from the internal carotid which have been called *inferior meningeal arteries*. Posteriorly the vertebral, the occipital, and the ascending pharyngeal supply branches which go by the name of *posterior meningeal arteries*.

The veins of the dura mater are formed similarly to those in other parts, being derived from radicles which take their rise in the membrane itself as well as from the osseous walls of the cranium, from the diploic veins of those bones. (See *BONE*, *figs. 187, 188*, vol. i.) All of them, with the occasional exception of one or two which accompany the middle meningeal artery and pass out at the foramen spinosum, pour their blood into the great venous canals enclosed between the laminae of the dura mater, which are called *Sinuses*.

The sinuses of the dura mater.—At certain situations, processes of the inner membrane of the venous system are included in canals formed by the separation of the laminae of the dura mater. The channels that are thus formed for the passage of the venous blood do not admit of being dilated beyond a certain size, and in this consists an important peculiarity in the venous system within the cranium. These channels empty themselves into the internal jugular vein, which thus forms almost the sole channel by which the venous blood is returned from the brain and its membranes as well as in a great measure from the bones of the skull. And thus is explained the rapid influence which is produced upon the brain by any impediment to the passage of the blood through the superior vena cava.

It is important to notice that the sinuses communicate with and receive blood from certain external veins which carry blood derived from parts exterior to the cranium. Among these may be enumerated the ophthalmic vein, and several small veins in the neighbourhood of the mastoid and condyloid processes, and in the parietal bones.

The following sinuses may be described.

The superior longitudinal sinus.—This sinus corresponds to the superior margin of the falx cerebri. It commences very narrow by one or two small veins from the dura mater in the vicinity of the crista galli and cribriform plate of the ethmoid bone. Thence it proceeds backwards, gradually increasing in calibre, and it terminates a little above the internal occipital protuberance by communicating with a small cavity or reservoir, situated between the layers of the dura mater there, which is called *Torcular Herophili*. If a vertical section of this sinus be made in the transverse direction, it will be seen to be triangular in shape, the apex corresponding to the falx, the base slightly curvilinear and lodged in the groove which passes along the median line of the cranial vault. When the sinus is laid open in its length by slitting up its superior wall, we find that its sides are perforated by a great number of minute orifices, which are the openings of veins passing into it from the dura mater and from the brain itself. These veins pass into the sinus chiefly at right angles to it, or in the direction from behind forwards; a few, situate in front, enter the sinus from before backwards. In the interior of the sinus we observe little bands (*trabeculae* of Haller, *chorde Willisii*), stretching across from right to left, connected only with the lateral walls and leaving a free space above and below them. These bands are numerous, and various as regards breadth. Haller has seen them so numerous that they appeared like a septum dividing the sinus into two portions, of which the superior was the larger.

The walls of the sinus, towards its inferior angle, have frequently a cribriform appearance, which puts on somewhat the aspect of erectile tissue. There is no appearance of valves in the interior of the sinus; frequently, however, the oblique entrance of a small vein into the

sinus produces a fold near the venous aperture, which, under the retrograde pressure of the column of blood, might close the orifice, and probably, when the veins open into the sinus from behind forwards, they may be protected from the regurgitation of the blood by this mechanism.

Several of the small bodies, previously alluded to by the name of Pacchionian glands, project into the cavity of the sinus through apertures in its wall. They appear as if they had worn their way by pressure and friction through the walls of the sinus, and it is here that the appearance of an erectile structure is most manifest. We cannot suppose that these bodies are bathed in the blood of the sinus, but rather that they push the lining membrane of the sinus before them. It has been supposed that these bodies are natural structures destined to perform a mechanical office somewhat on the principle of the ball-valve, but they are frequently absent altogether, and when present they have no constant relation to the venous orifices.

The inferior longitudinal sinus (sinus inferior fulcis) is a small vein lodged in the inferior part of the falx cerebri, running parallel to and a little above its inferior margin for about the two posterior thirds of its length. It gradually increases in calibre from before backwards, being formed by tributary veins from the falx; it opens into the strait sinus.

The strait sinus corresponds to the middle line, at the place where the falx cerebri unites with the tentorium cerebelli. It seems to be enclosed between the layers of the former. Like the other large sinuses, it presents in its section the form of a triangle, whose base is inferior. Its direction is from before backwards and a little downwards, with a slight degree of curvature corresponding to that of the tentorium. It corresponds at its commencement to the space between the posterior reflected portion of the corpus callosum and the quadrigeminal bodies, and here it receives two large veins (*vena magna Galeni*), which carry the blood from the interior of the ventricles, and a third vein, the inferior longitudinal sinus. It opens into the conflux of the sinuses or torcular by a round opening or sometimes by two openings, separated by a slip of fibrous membrane. This sinus likewise receives veins from the inferior surface of the posterior and middle lobes of the brain, and from the superior surface of the cerebellum.

At the posterior extremity of the straight sinus we find a reservoir somewhat polygonal in shape, which corresponds to the occipital protuberance; this is called the *Torcular Herophili*,* (the press of Herophilus), the conflux of the principal sinuses of the dura mater; it has six openings, one for the superior longitu-

* This absurd name might with great advantage be discarded, for it seems quite uncertain what precise part Herophilus intended to apply it to. The term proposed by Cruveilhier is much better, *the occipital conflux of the sinuses*. Various other names were applied to it formerly, such as *Lacuna platea*, *pelvis*, *laguncula*.

dinal sinus above; one for the straight sinus in front; two for the lateral sinuses on each side; and two for the occipital sinuses inferiorly (fig. 362, *t*).

Fig. 362.

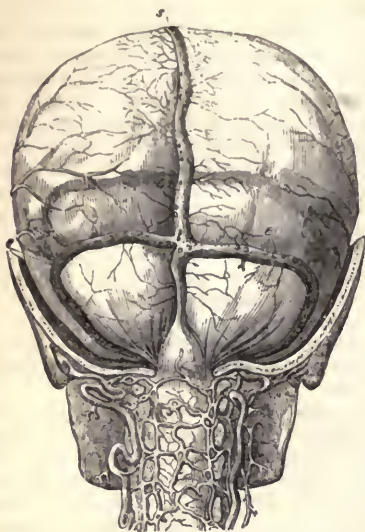

Posterior part of the cranium removed, to show the dura mater and the superior longitudinal, and the lateral sinuses, with the torcular Herophili.

e, lateral sinus; *t*, torcular Herophili; *s*, superior longitudinal sinus.

Lateral sinuses.—From each side of the conflux of the sinuses, there proceeds in a somewhat serpentine course outwards, downwards, and forwards, a wide canal, the largest of the sinuses, which conveys the blood from the torcular to the internal jugular vein. A groove exists on each side of the internal occipital protuberance, for the reception of this sinus, which marks the occipital bone, the mastoid portion of the temporal, and a small portion of the occipital bone again. In a great portion of their course, the lateral sinuses correspond to the posterior margin of the tentorium cerebelli, as far forwards as the mastoid portion of the temporal bone. Here each sinus winds downwards to reach the jugular foramen in the posterior lacerated opening. These sinuses are never equal; that of the right side being, with few exceptions, the larger, a circumstance which Vicq d'Azyr, Söemmering, and Rudolphi attributed to the fact that most persons sleep on the right side, on which account the blood is apt to accumulate to that side. They are more capacious at their termination in the jugular veins than at their commencement from the torcular. The inner surface of this sinus is like that of all the others; it is not, however, traversed by any of the bands which are found so numerous in the longitudinal sinus. Cruveilhier states that he once saw in the horizontal portion of this sinus, a few of the *Pacchionian* bodies.

In its course each lateral sinus receives veins

from the inferior surface of the brain and superior of the cerebellum; it also receives the superior petrosal sinus near the base of the petrous portion of the temporal bone. A large mastoid vein communicates with this sinus and penetrates to the exterior, where it forms one of the principal sources of the occipital vein, thus establishing a free and direct communication between the circulation within and that without the cranium.* Near the jugular foramen the lateral sinus receives the inferior petrosal.

None of the sinuses has been more frequently the seat of inflammatory disease than the lateral. Being the principal channel for the return of the venous blood from the interior of the skull, a slight morbid action within them can scarcely fail to induce a material derangement of the cerebral circulation, and the nearness of their position to the cerebellum and to the posterior lobes of the brain renders it very unlikely that those parts would escape participating in any acute disease which might arise within it.

Occipital sinuses.—These are small veins lodged between the layers of the falx cerebelli. They collect the blood from the dura mater and from the cranial bones in the immediate vicinity of the posterior margin of the foramen magnum, and from thence they pass upwards and inwards to open into the lower part of the torcular. Cruveilhier suggests that the direction and position of the occipital sinuses are best indicated by describing them as being the cords of the arcs which the lateral sinuses form.

Petrosal sinuses.—These sinuses are so named from their connection with the petrous portion of the temporal bone. The superior petrosal sinus corresponds, on each side, to the posterior superior edge of the petrous bone, along the three outer fourths of which a groove exists for its reception. This groove is interrupted in front by a depression in which the fifth nerve is lodged, so that at this place that nerve lies between the sinus and the bone. The superior petrosal sinus is about large enough to contain an ordinary sized surgeon's probe. It communicates with the lateral sinus posteriorly and with the cavernous sinus in front, and in its course it receives several small veins from the dura mater in the middle fossa of the cranium. It receives a vein from the anterior portion of the corresponding hemisphere of the cerebellum, and also, sometimes, one from the inferior surface of the brain. Small veins from the pons Varolii empty themselves into its anterior extremity.

The inferior petrosal sinuses also form an additional channel of communication between the lateral and cavernous sinuses. They are larger but shorter than the superior. In situation they correspond to the interval between the petrous bone and the occipital. They open into the inferior portion of the lateral sinus just before it unites with the jugular vein.

Transverse sinus.—This sinus establishes a communication between the petrosal and

* Cruveilhier, An. Desc. t. iii. p. 268.

cavernous sinuses of opposite sides across the basilar process of the occipital bone. Sometimes there are two running parallel to each other. Cruveilhier states that the capacity of this sinus is much greater in old than in young subjects.

Cavernous sinuses.—In point of shape these sinuses differ considerably from all the other sinuses of the dura mater. They are venous reservoirs, situated on each side of the sella Turcica, from which they are separated by the internal carotid arteries. Their name is derived from the spongy appearance which they present in their interior, owing to the existence of some filaments within them, which, by their interlacement with each other, form a reticular texture there. It was formerly supposed that the carotid arteries lay in the cavity of these sinuses and were bathed by their blood; but it is easy to demonstrate by a little careful dissection that the inner membrane of the sinus adheres loosely to the outer wall of the artery, and that the sixth nerve passes between them. In the outer wall of each cavernous sinus there are channels for the reception of those nerves, which pass from the cranium into the orbit. These are the third nerve which is placed highest up, the fourth nerve which holds the next place, and the ophthalmic portion of the fifth. The cavernous sinus receives at its anterior extremity the ophthalmic vein, which collects the blood from the eye-ball and other structures within the orbit, and which communicates also with the angular vein and with the frontal vein. (Hence the injected state of the vessels of the eye-ball when the brain is congested, as in fever.) Veins from the inferior surface of the anterior lobes of the brain also open into it, also some from the middle lobe and from the dura mater. Posteriorly it communicates with both the petrosal sinuses, and veins from the cranial bones open into its superior wall.

Circular sinus.—A communication is established between the cavernous sinuses by means of the *circular* or *coronary* sinus which embraces the pituitary body, one portion lying in front of it and the other behind it, both opening by a common free orifice into the right and left cavernous sinuses. The posterior portion of the circular sinus is much larger than its anterior portion. Its size is much greater, according to Cruveilhier, in old subjects than in young ones. It receives small veins from the pituitary body, and also from the sphenoid bone and from the dura mater.

It is impossible to examine this complicated arrangement of venous channels in connexion with the dura mater of the brain without admiring the beautiful provision which it affords against the undue accumulation of blood in the venous system within the cranium. In the first place, we observe that these veins do not admit of dilatation beyond a prescribed extent, by reason of their being enclosed between layers of an inelastic and inextensible membrane. Next, we remark the safety provision which is afforded by the frequent communication between them, so that if one chan-

nel were altogether closed or materially contracted, there are many others by which the blood could return. Nor is a local congestion likely to take place to any extent, for such is the freedom of communication between the sinuses and the veins of the exterior of the cranium, that (all being devoid of valves) an overflow would readily be received by the latter without the least impediment. Lastly, we learn the great importance and value of local depletion as an agent for relieving vascular fullness within the head, owing to the free communication between the extra- and the intra-cranial circulation, and especially of the veins; and we may infer from anatomy that local depletion would most probably be more serviceable than general, for although the latter would diminish the amount of the mass of circulating fluid, it would not affect the relation between the venous and arterial systems, whilst it is evident that the former must affect the venous system more directly than the arterial. Moreover, the free communication between the circulation within and that without the cranium may explain somewhat the advantage that is often derived from the application of an intense cold to the external surface of the head.

Of the pia mater. (Tunica intima vel vasculosa.)—The pia mater is the most internal membrane of those which have been enumerated as belonging to the spinal cord and brain.

Pia mater of the spinal cord.—This membrane stands in precisely the same relation to the spinal cord as the neurilemma does to the nerves; and as long as the spinal cord could be, as it formerly was, regarded merely as a bundle of nervous fibres, the analogy of this membrane to the nervous sheath would be perfect. It is composed almost entirely of white fibrous tissue; it closely invests the cord and supports the minute bloodvessels which carry the nutrient fluid to it. Not only does it thus form a complete sheath to the cord, but it likewise sends in processes which dip into the anterior and posterior median fissures of that organ. That which passes into the anterior median fissure is a true fold or duplicature of the pia mater; but the posterior fissure, which is much narrower than the anterior, is occupied only by a single and extremely delicate layer, which at some parts almost entirely disappears, and seems to consist merely of a few minute capillary vessels. The pia mater becomes continuous with the neurilemma of the roots of the nerves on each side of the cord, and at its inferior extremity it tapers in accordance with the shape of the spinal cord, and is prolonged as a delicate thread which is inserted into the extremity of the dura mater. This prolongation is quite gradual, so that at the upper part it encloses a portion of the medullary substance of the cord; in the greater part of its extent, however, it is merely a membranous thread, and, therefore, goes by the name *filiform prolongation* of the pia mater (*filum terminale*). The late Dr. Macartney used to regard it as highly elastic, but my friend Mr. Bowman has called my attention to the fact that it consists almost entirely of white

fibrous tissue, which cannot confer elasticity. And if a portion removed from the cord be stretched, it will be found to possess very little elasticity; but if the cord be held up by the filiform prolongation, and a slight jerking movement be communicated to it, it may be made to dance about as if by the elastic reaction of the filiform process. The movement which may be thus produced is very well calculated to deceive, and Dr. Macartney must have founded his opinion upon that experiment alone, omitting to try the effect of stretching a detached portion of the process. The fact is that when the cord is suspended in this way, the pia mater becomes stretched, and its anterior and posterior portions are approximated and the cord flattened; when it is raised with a jerk, this tension of the pia mater is diminished, and the cord returns to its previous form until it falls again, stretches the pia mater, and becomes once more flattened, producing a degree of reaction which favours its elevation, but which alone would be insufficient for that purpose. Thus it appears that the elastic reaction, which Dr. Macartney attributed to the filiform process, is in reality due to the compression and consequent flattening of the cord by the tension of the pia mater. It should be stated, further, that this process is not formed of pia mater alone, but also of a continuation of the ligamentum denticulatum on each side to be described by-and-by.

The pia mater is abundantly supplied by bloodvessels, many of which are extremely tortuous. These vessels are derived from the anterior and posterior spinal arteries. Along the anterior surface of the spinal cord in front of the anterior median fissure there is a narrow band of fibrous tissue which is stretched across this fissure like a bridge, and occupies its whole length. No such arrangement exists on the posterior surface.

The pia mater of the spinal cord possesses considerable strength and density. The nervous matter may by pressure be squeezed out of it, leaving a hollow cylindrical membrane, or it may be dissolved out by the action of liquor potassæ. In the quite recent state, while the cord is as yet firm, the pia mater may be readily dissected off, its adhesion to the cord being through the medium of numerous exceedingly minute capillary vessels. On its exterior the pia mater adheres to the visceral layer of the arachnoid membrane by means of a loose fibrous tissue.

Pia mater of the brain.—In tracing the pia mater of the spinal cord upwards, it will be found gradually to become much thinner and more delicate as it passes from the medulla oblongata to the hemispheres of the cerebellum and cerebrum. In connexion with these latter parts it becomes of extreme tenuity, and owes its physical tenacity chiefly to the intimate connexion of the visceral layer of the arachnoid membrane with it. The cerebral pia mater is almost exclusively composed of numerous ramifications of minute vessels which are accompanied by white fibrous tissue in small quantity. These vessels divide and subdivide to the last degree

of minuteness, and are admirable objects for examining the structure of capillary vessels. The pia mater adheres closely to the whole surface of the brain, cerebellum, and connecting parts, and numberless vessels pass from it into the nervous substance in contact with it. On the surface of the brain it dips down into the sulci or furrows between the convolutions, and adheres to the superficial grey matter. Wherever there is a depression or fissure of the brain, the pia mater is found dipping into it. It likewise sinks into the fissures between the laminae of the cerebellum.

We shall obtain, however, a very inadequate notion of the extent of the pia mater, if we confine our examination of it to the exterior of the brain and cerebellum. At certain situations this membrane is continued into the cavities or ventricles of these organs, where it doubtless fulfils some office connected with the support and nutrition of certain parts of them. These situations are four in number, as follow: on each side, the fissure between the crus cerebri and the middle lobe of the brain, behind, the transverse fissure between the cerebellum and cerebrum, and, lastly, the inferior extremity of the fourth ventricle.

Choroid plexus of the lateral ventricles.—These are apparently folded processes of the pia mater which enter the inferior part of the lateral ventricles on each side, and are continued upwards and forwards to their middle portions, where they become continuous with each other in the foramen commune anterius, and with a middle process, the velum. Each choroid plexus forms a somewhat cylindrical process, which, when traced from below upwards and from behind forwards, will be found to follow the direction of the lateral ventricle as far forwards as the apex of the horizontal portion of the fornix, gradually diminishing in thickness, and assuming the character of a simple membranous expansion. It projects freely into the cavity of the ventricle, having no connection with the walls of that cavity excepting along the margins of the fissure, at which it enters, where the membrane of the ventricle adheres to it, being probably reflected upon it.

Fig. 363.

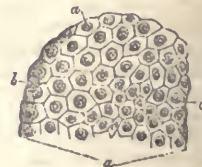

Choroid plexus of lateral ventricle in the Sheep, shewing a villous process, highly magnified, and the epithelium.

(After Valentin.)

a, villus; b, epithelium; c, nucleus of epithelium.

Very numerous and tortuous bloodvessels are contained in these processes, forming a plexus which has given name to the folds themselves.

The surface of each choroid plexus presents many slight projections or folds resembling villi, in which are contained loops and plexiform anastomoses of minute vessels, very similar to the arrangement of the vessels of the villous processes of the chorion of the ovum, or those of the tufts of the placenta. These vessels are surrounded by an epithelium which has much the appearance of that of serous membranes. From the great number of these vessels and from the delicate nature of the epithelial covering which surrounds them, it is plain that the choroid plexuses are well suited either for the purpose of pouring out fluid or of absorbing it.

Fig. 364.

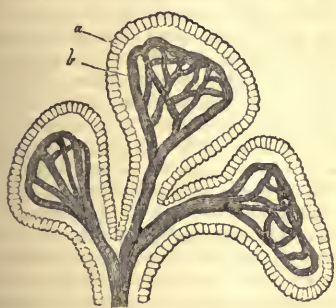

Side view of villi of the choroid plexus of the lateral ventricle in the brain of a Goose, to show the disposition of the bloodvessels. Not to obscure the view of the bloodvessels, the edge of the epithelium only has been shown.

a, epithelium; b, bloodvessels.
(After Valentin.)

The epithelium may be best seen by examining the edge of a fold. It becomes very distinct when acted upon by acetic acid. As its particles are very delicate and consist only of a single layer, they are easily detached. The cells of epithelium are most of them six-sided, and contain a clear nucleus, or several minute granules. Valentin states that cilia may be seen playing upon this surface, especially in the embryo. I have observed the peculiar punctiform or spiniform formations to which he alludes, which look like the remains of former vibratile cilia.

Velum interpositum. (*Toile Choroidienne*, Vicq d'Azyr.)—The choroid plexuses are connected to each other by the *velum interpositum*, which is a triangular fold of pia mater that passes in at the transverse fissure between the upper surface of the tubercula quadrigemina and the posterior reflected portion of the corpus callosum. This process is continuous with the pia mater of the inferior surface of the posterior lobes of the brain, and with that of the superior surface of the cerebellum, and it therefore consists of two laminae; as it passes forwards, it sends downwards a little process which embraces the pineal body; it forms the roof of the third ventricle, being interposed between that cavity and the fornix, (hence its name,) and at its sides as well as its apex its continuity

with the choroid plexuses may be readily demonstrated. At its anterior extremity it corresponds to the foramen commune arterius. The *velum interpositum* is best exposed in the dissection from above downwards by removing carefully in succession the corpus callosum and the fornix. In raising the *velum* itself, in order to disclose the cavity of the third ventricle, it is necessary to be very careful, as from the intimate connexion which the pineal body has with it towards its base, that body may be readily disturbed from its position.

Choroid plexuses of the fourth ventricle.—The choroid plexuses of the fourth ventricle are two small processes of pia mater united along the median line, presenting the same villous character as those of the lateral ventricles. These folds seem as if they had been pushed up into the fourth ventricle by the lower laminae of the inferior vermiform process. Their position may be best seen by opening the fourth ventricle from above, where they will be found lying on each side of that portion of the median lobe of the cerebellum which stops up the inferior extremity of the fourth ventricle. These plexuses are in every respect similar, as far as regards structure, to the larger ones which are found in the lateral ventricles, and, like them, exhibit a delicate epithelium upon their surface. Upon the centre of each epithelium cell Valentin states that a pigment corpuscle is deposited. (Fig. 365.)

Fig. 365.

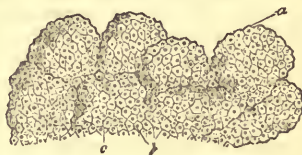

A highly magnified villus of the choroid plexus of human cerebellum. (After Valentin.)

a, the villus; b, the epithelium cells; c, the nuclei.

These internal processes of the pia mater contain minute crystalline formations, a kind of very fine sand, which, however, is not constantly present in all brains.

The grains are deposited in the meshes of the vascular plexuses. Sometimes they accumulate in masses so as to be visible to the naked eye or easily recognized by the touch. In general, however, they are microscopic, in form globular, and connect themselves with the minute vascular ramifications like little bunches of grapes. They are found principally in the choroid plexuses of the lateral ventricles, and in that portion of the *velum interpositum* which embraces the pineal body. In the former they are most numerous at that part which was called by the Wenzels *glomus*, where the choroid plexus turns up from the inferior cornu into the horizontal portion of the lateral ventricle.* As regards chemical composition this

* See Van Ghert de *plexibus choroideis*, Utrecht. 1837; Valentin, in *Soemmering Anat.*, and

sabulous matter consists chiefly of phosphate of lime with a small proportion of phosphate of magnesia, a trace of carbonate of lime, and a small quantity of animal matter.

The pia mater adheres very closely to the surface of the brain, coming for the most part into contact with grey matter. When a portion of it is raised carefully in a fresh brain, numberless extremely minute bloodvessels are seen passing from it into the cerebral substance. These are the principal nutrient vessels of the brain. On its outside the pia mater adheres partially to the arachnoid membrane. At those points which correspond to the convex portions of the convolutions the adhesion of arachnoid to pia mater is close; but at other places the latter membrane separates completely from the former.

The pia mater of the brain differs from that of the spinal cord in its great delicacy and tenuity; it wants the strength and density of the latter membrane. This is owing to its being composed almost entirely of extremely minute and delicate bloodvessels, whilst the spinal membrane consists chiefly of white fibrous tissue. The bloodvessels of the former are infinitely more numerous than those of the latter, and the reason of this probably is that the cerebral membrane is chiefly in contact with grey matter, which requires a great quantity of blood, but the spinal membrane immediately embraces white matter, which is much less vascular.

It is important, in a pathological point of view, to notice that this membrane is the medium of nutrition, not merely to the nervous matter of the brain and cord, but also to the arachnoid membrane which is immediately adherent to it, and to which it bears the same relative position as the sub-serous areolar tissues elsewhere to their respective serous membranes. Hence the difficulty, if not the impossibility, of adopting distinctions which systematic writers endeavour to make out between arachnitis and superficial inflammation of the brain. It is physically impossible that there shall be arachnitis without serious disturbance of an inflammatory kind in the circulation of the pia mater, nor can this exist without affecting the superficial layers of the grey matter of the convolutions. It may, therefore, be confidently affirmed that arachnitis, when affecting that portion of the arachnoid membrane which covers the hemispheres of the brain, is synonymous with inflammation of the superficial layers of the grey matter of the convolutions. Whatever be the point of departure, it seems impossible that inflammation of the one can exist without a similar and equal affection of the other. And thus we may explain the apparently anomalous statement of authors that inflammation of the arachnoid should give rise to a more violent train of symptoms than deep-seated inflammation of the brain. The real difference is, not between membranous and

Bergmann, über die innern Organisation des Gehirns. The last author states that he has seen the sandy deposit excessive in connexion with mental derangement.

cerebral inflammation, but between an inflammatory affection of the superficial grey matter of the convolutions, the great source and seat of the physiological activity of the brain, and a similar morbid action of the more central white substance, the function of which is in a certain sense subservient to that of the superficial grey matter.

Of the arachnoid membrane.—This membrane is intermediate to those already described. We have preferred giving the description of it last, because to understand it demands an acquaintance with the details of both those membranes.

The arachnoid is a great serous membrane pervading the entire cranio-spinal cavity. Its parietal layer adheres intimately and inseparably to the inner surface of the dura mater both cranial and spinal, and its visceral layer is attached to the outer surface of the pia mater.

In point of structure and general disposition the arachnoid membrane resembles other serous membranes, so much as to render it inexpedient to enter into any minute comparison of them. It will only be necessary to refer to such peculiarities of arrangement as may arise from the anatomical characters of the nervous centres with which it is connected.

Spinal arachnoid.—The serous character of the spinal arachnoid is best seen by examining a transverse section of the spinal cord and its membranes. If the section be made across the interval between two sets of spinal nerves, the visceral and parietal layers of the membrane may be seen in contact with each other; the parietal layer closely attached to the dura mater, the visceral layer adherent to the pia mater of the spinal cord so loosely as to leave a considerable space between it and the outer surface of that membrane.

Fig. 366.



Transverse section of spinal cord and its membranes between the fifth and sixth cervical nerves. (After Arnold.)

v, visceral layer of arachnoid membrane; s, sub-arachnoid space; c, arachnoid cavity.

We may here notice an important distinction which the student of this portion of anatomy will do well to note particularly, namely, that the space between the two layers of arachnoid membrane is the *arachnoid bag or sac*, in which it is very rare for any fluid to accumulate; and that that between the visceral layer of the arachnoid and the pia mater is the *sub-arachnoid cavity*, in which, as will be shown by-and-by, a considerable quantity of fluid exists in the natural state.

When the section is made on a level with the nerves as they emerge through the dura mater, we may notice the manner in which the arachnoid membrane is prolonged upon the nerves in the form of a loose sheath, forming little

uls-de-sac at the orifices through which the nerves escape.

Fig. 367.



Transverse section of the same on a level with the fifth cervical nerves. (After Arnold.)

The same parts are displayed as in the last figure, and the reflection of the arachnoid at the exit of the nerves is seen.

af, anterior fissure; n, n, spinal nerves.

In the interval between each pair of nerves, we find a triangular process of fibrous membrane which is inserted by its apex into the dura mater. This process lies in the sub-arachnoid cavity and adheres by its base to the pia mater. It seems to pierce both layers of the arachnoid, or to pin them down, as it were, to the dura mater.

At the foramen magnum the spinal arachnoid may be seen to be continuous with that of the brain, and here its visceral layer invests the medulla oblongata loosely. Inferiorly we trace the membrane down quite to the lowest extremity of the dura mater, and in this region the visceral layer is particularly loose and free, as it lies over the cauda equina.

When the dura mater is carefully slit up along either the anterior or the posterior surface, the arachnoid sac is laid open. It does not always happen that the parietal layer separates very readily from the visceral: frequently the two layers adhere firmly at several minute points, yet this adhesion is effected without any connecting membrane, and appears to arise from the two layers becoming dried at several corresponding points, and thus being, as it were, glued together. We may frequently observe this in specimens that have been some time kept in spirits. This point is deserving of notice, as these adhesions might be (and indeed they have been) noted as of a morbid nature.

The visceral layer of the spinal arachnoid is connected to the pia mater by means of a number of long filaments of fibrous tissue which interlace slightly, and in the areolæ thus formed the fluid is contained. This tissue is most distinct and abundant in the cervical region, and exists in very small quantity in the dorsal. It ceases nearly altogether over the cauda equina. Numerous minute bloodvessels are also to be found in it passing from the pia mater to the arachnoid. Majendie gives to this tissue the name "*tissu cellulo-vasculaire sub-arachnoïde*."

In general the adhesion of the visceral layer of the arachnoid to the subjacent pia mater is closer along the posterior than along the anterior surface of the cord.

Along the posterior surface of the cord on the median line, the sub-arachnoid space is divided by means of a septum, which is most perfect in the dorsal region, but which in the lumbar and cervical regions is cribriform or

pectiniform, as may be shown by pouring quicksilver on either side of it, which will be retained in the dorsal region, but will readily pass from right to left in the other situations. It is highly probable that this septum is a modified portion of the sub-arachnoid tissue.

The existence of this septum (erroneously described as complete) dividing the posterior part of the sub-arachnoid space into a right and a left portion, appears to have led to the opinion that this space is lined by another serous membrane, which has been called *the internal arachnoid*, by which the fluid is supposed to be secreted, and that the septum is formed by the reflection of its visceral into its parietal layer along the median plane. But there are many objections to this hypothesis. In the first place, if the septum were formed by the reflection of a serous membrane, it would be complete, and not a very imperfect one such as it is; it ought to resemble the mediastinum in the chest, or one of the processes of the peritoneum in the abdomen. Secondly, it is quite contrary to all experience to find the cavity of a serous membrane in the normal state traversed by a quantity of filamentous tissue, as the sub-arachnoid space is throughout a great part of its extent. Thirdly, were there a serous membrane in this space, the microscope ought to detect an epithelium on its inner surface, but such a structure does not exist here. Lastly, such a serous membrane must necessarily be continued into the encephalic sub-arachnoid space. But the close adhesion of the visceral layer of the arachnoid to the pia mater, opposite to the prominent parts of the cerebral convolutions, seems quite incompatible with such an arrangement.

Cerebral arachnoid.—The cerebral portion of the arachnoid exhibits essentially the same general arrangement as the spinal portion. Its parietal layer adheres very intimately to the pia mater at certain points, leaving in the intervals a considerable space for the accumulation of liquid. If we trace it over the surface of the hemispheres, it will be found to give them that smooth and uniform character which is always distinct on the recent healthy brain. The arachnoid passes from convolution to convolution, adhering closely to the pia mater over the most convex portions of those convolutions, but allowing that membrane to separate from it in the intervals between them, and to dip down to the bottom of the sulci. Hence liquid accumulated in the cerebral sub-arachnoid space will be found to take the direction of the intergyral sulci, and to cause the membrane to bulge opposite to them; and if air be blown underneath the arachnoid, it will be found to take the tortuous course of these sulci.

The arachnoid sinks into the great longitudinal fissure of the brain, lining the surfaces which bound it on each side, and passing across from right to left beneath the inferior margin of the falx, and above the corpus callosum.

On the base of the brain, the arachnoid has the same arrangement on those parts where there are convolutions, as on the superior and lateral surfaces of the hemispheres. It passes

over the fissure of Sylvius from the anterior to the middle lobe, and here its distinctness from the pia mater may be clearly demonstrated; here too it appears much stronger and more opaque than elsewhere, which is probably due to the existence of an increased quantity of fibrous tissue beneath it.

In that space on the base of the brain which is bounded on each side by the middle lobes, and which is limited in front by the optic nerves and behind by the pons Varolii, the arachnoid membrane stretches across from one middle lobe to the other, leaving a considerable space between the tuber cinereum and the pons, in which it is connected to the pia mater by several long filaments similar to those which are met with on the surface of the spinal cord. This space is favourable for the accumulation of fluid, and it communicates in front with the fissures of Sylvius and other deep fissures into which fluid might make its way. Cruveilhier calls it the *anterior sub-arachnoid space*, and regards it as the principal reservoir of the cranial serosity. Immediately in front of it we observe that the arachnoid membrane is continued around the infundibulum to the pituitary body.

In tracing the arachnoid backwards from the great longitudinal fissure of the brain, we observe that it stretches down from the posterior edge of the corpus callosum to the superior surface of the cerebellum, crossing over the tubercula quadrigemina. At this situation the arachnoid is reflected upon the venæ magnæ Galeni as they pass to the straight sinus. It was at this place that Bichat described the canal which goes by his name, through which, as he thought, a process of the arachnoid membrane was carried in to line the interior of the ventricles.

The arachnoid covers the superior surface of the cerebellum and also its inferior surface, stretching across the longitudinal fissure from one hemisphere to the other, and it is also extended downwards, and a little forwards from the superior surface of the cerebellum to the posterior surface of the medulla oblongata, below the inferior extremity of the fourth ventricle. A considerable space is thus left, situate posteriorly between the cerebellar hemispheres, and bounded in front and inferiorly by the medulla oblongata, which also forms a considerable reservoir for cerebral fluid, and communicates freely with the sub-arachnoid space of the spinal canal; but as the arachnoid is tied down somewhat more closely over the posterior surface of the spinal cord, there is an appearance of constriction where the cerebral passes into the spinal arachnoid. This space is called by Cruveilhier the *posterior sub-arachnoid space* (*posterior conflus* of Majendie). It communicates with the anterior sub-arachnoid space through the furrows around the crura cerebelli.

Of the cerebro-spinal fluid.—In examining such a dissection of the membranes of the spinal cord as that above described, we shall find that at various points the visceral layer of the arachnoid membrane appears raised up by fluid or by a bubble or two of air from

the subjacent viscus. If a small portion of this layer be taken up in a forceps, and a blow-pipe be introduced into it, air may be blown underneath it, raising it up all around the spinal cord to a considerable distance from that organ. The inflation is more easily effected in the cervical and in the lumbar regions than in the dorsal, and the air will pass down quite to the lowest part of the canal of the dura mater, where the connexion of the arachnoid membrane to the cauda equina is particularly loose. In the same way coloured fluid, or some material which may assume the solid form, as size, tallow, &c. may be injected to demonstrate this anatomical arrangement. If now we examine a transverse section, it will be observed that a considerable interval exists between the visceral layer of the arachnoid and the pia mater of the cord, and that this interval is much greater in the neck and in the loins than in the back. We observe too that the spinal cord is by no means of sufficient size to fill the spinal canal, and that as a considerable interval exists between its surface and the visceral layer of the arachnoid, so also a still greater one is found between it and the inner surface of the dura mater. Now as it is of the very nature of a serous membrane that its free and smooth surfaces should always be in contact (for it is in that way that it favours the movements of the viscus with which it is connected), it is plain that the sub-arachnoid space in the spine must, during life, be kept in a state of distension, otherwise the object of a serous membrane would not be attained.

Moreover, in tracing the arachnoid membrane upwards over the medulla oblongata and the other parts of the encephalon, we observe an evident continuity between the spinal and the cranial sub-arachnoid cavity, which is most evident at the base of the brain, where the latter possesses the greatest dimensions, so that air or fluid may be readily made to pass from one to the other. This is most conspicuous in old subjects, in which the brain being small and more or less shrunken, leaves a considerable interval between its surface and the visceral layer of the arachnoid.

On opening the spinal canal in a body recently dead, the visceral layer of the arachnoid will almost always be found raised by fluid. When a portion of the posterior wall of the spinal canal is removed in a living animal, or in one just killed, the dura mater is found to be quite tense from the fluid which is accumulated within it. In a horse, whose spinal canal I opened in the dorsal region immediately after he had been knocked down in the knacker's yard, I found the dura mater perfectly tense, and semi-transparent from being stretched so firmly over fluid. Upon making a minute-puncture in it, a fine stream of clear fluid was ejected with much force to a considerable distance, and immediately the dura mater became quite flaccid. By a little careful dissection through the dura mater and parietal layer of the arachnoid, it may be shewn that this fluid is not contained in the arachnoid sac, but in the sub-arachnoid cavity.

Fig. 368.

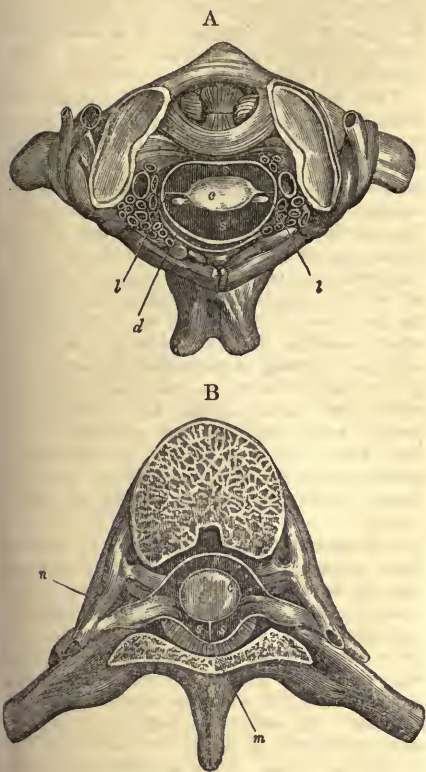
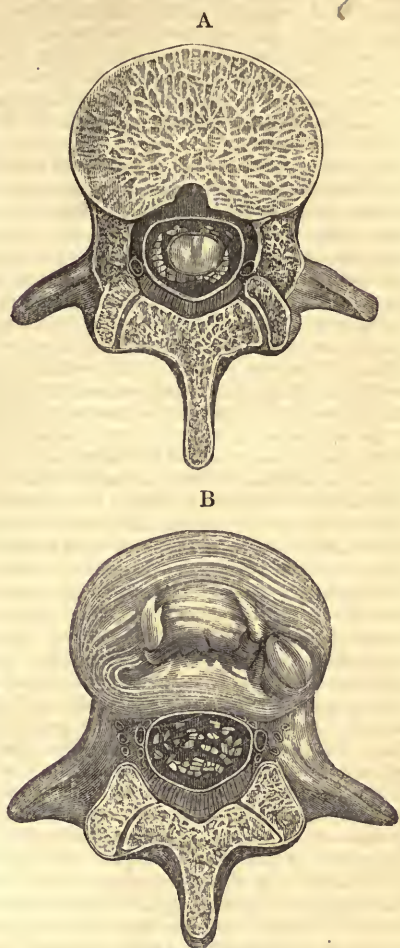

Fig. 369.



A, Transverse section of the spine at the situation of alloido-occipital articulation. (After Majendie.)

c, the spinal cord.
 d, the dura mater and arachnoid membrane.
 s, s, the sub-arachnoid space, divided into an anterior and posterior portion by
 l, the ligamentum denticulatum.

B, Section in the dorsal region. The same letters indicate similar parts as in A. m, the posterior median septum. n, the roots of the nerves.

Sections of the spine in the lumbar region.

A, shews the section of the cord as well as of many roots of nerves descending to form the cauda equina.

B, shews the section of the cauda equina. In both these regions the sub-arachnoid space is large and uninterrupted by bands or septa. The fluid permeates and surrounds the roots of the nerves.

We can thus demonstrate the existence of a fluid, which during life and in a state of health occupies the sub-arachnoid cavity and maintains the two layers of the arachnoid membrane in contact with each other. This fluid is designated by Majendie the cerebro-spinal fluid.

The first distinct recognition of this fluid in its proper locality is due to Cotunnus, who stated the results of his observations in his memoir "de Ischiade Nervosa," preserved in Sandifort's collection of dissertations. Cotunnus was led to the discovery by remarking the great disproportion between the dimensions of the spinal canal and the bulk of its contents, so that a considerable interval exists between the internal surface of the former and the spinal cord, which must be filled by something; and he attributes its having been so completely overlooked by previous anatomists to the fa-

shion of opening the head before the spine, which favoured the escape of the fluid. This anatomist was also aware that the fluid was formed and contained in the sub-arachnoid cavity.

It is, however, to M. Majendie that we are chiefly indebted for our present knowledge of the physiological history of this fluid. Majendie's first researches were given to the public in his Journal de Physiologie for the year 1827, and he has lately collected the results of his inquiries in a volume entitled "Recherches Physiologiques et Cliniques sur le Liquide Cephalo-rachidien," and published in 1842.

The cerebro-spinal fluid is found wherever

pia mater exists in connexion with brain or spinal cord, whether on the surface of these organs, or in the ventricles of the former. It serves to fill up various inequalities in the cranial or spinal walls, and it accumulates in greatest quantity in those situations where the sub-arachnoid space affords the greatest capacity.

Majendie describes four situations at which this fluid accumulates in greater quantity than at other places on the surface of the brain. The most considerable of these, which he designates the *posterior conflux*, is situated below and behind the cerebellum; it corresponds to the posterior surface of the medulla oblongata, and is covered behind by the layer of arachnoid which extends between the medulla and the cerebellum. (Vid. supr. p. 638.) It is here that, according to Majendie, a communication takes place between the fluid on the exterior and that in the ventricles, at a point corresponding to the inferior extremity of the fourth ventricle. A second, or *inferior conflux* is found immediately in front of the pons Varolii; it is situated between the crura cerebri, and contains the basilar artery. It is, in fact, only the posterior part of what Majendie designates the *anterior conflux*, which extends forwards to the commissure of the optic nerves, occupying the central depression between the middle lobes of opposite sides, and bathing in its fluid the commissure, the tuber cinereum, the infundibulum, and the trunks of the anterior cerebral arteries. It communicates with the posterior fissure beneath the crura cerebelli. The position and the extent of this conflux is indicated by the separation of the visceral layer of the arachnoid membrane over the central part of the base of the brain. Doubtless the accumulation of fluid around so many parts of important function and delicate structure, is a valuable safeguard to them against the communication of shocks from the walls of the cranium. A fourth conflux is called *superior*; it is situated behind and a little below the level of the corpus callosum, behind the pineal gland, and above the tubercula quadrigemina. It communicates around the crura cerebri with the anterior conflux, and with the posterior conflux by the fissures which separate the superior vermiform process from the hemispheres of the cerebellum. The fluid contained in it bathes the pineal gland, the tubercula quadrigemina, the superior vermiform process, and the *vena Galeni* as they empty themselves into the strait sinus.

As the fluid is in contact with pia mater, it is plain that it must surround and support the roots of all the nerves which proceed from both the brain and spinal cord, and that all the bloodvessels which penetrate or emerge from those organs, or which ramify in the pia mater, must also be bathed by it. The fluid surrounds the nerves as they emerge from the cranium or spine, and maintains contact between the layers of arachnoid membrane which compose the sheaths that accompany them in their passage outwards. Majendie states that this fluid accompanies the roots of

the fifth pair of nerves as far as the Gasserian ganglion, and that it bathes and mingles with the fibres of the ganglion itself, as well as of the three nerves which originate from it. This, however, I think extremely doubtful.

That fluid exists in the ventricles of the brain has long been known to anatomists; and it seems highly probable that this fluid is secreted by the processes of pia mater which are found in all these cavities; or possibly by the membrane which lines their surface. Does the internal fluid communicate with that in the sub-arachnoid space? Majendie affirms that a communication takes place by means of an opening which is situated at the inferior extremity of the fourth ventricle. I have not been able to satisfy myself of the existence of such an opening; the following is Majendie's description of it: "The true orifice, constant and normal, by which the cerebro-spinal fluid continually passes, either to enter the ventricles or to issue from them, may be seen at the inferior termination of the fourth ventricle, at the place named 'le bec de la plume' by the old anatomists.

"To demonstrate the existence of this orifice it is necessary to raise up, and to separate slightly from one another, the lobules of the inferior vermiform process of the cerebellum, and without breaking any of the vascular adhesions which unite this part of the cerebellum with the spinal pia mater, we perceive the angular excavation which terminates the fourth ventricle. Its surface is smooth, even (*polie*), and is prolonged as far as the ventricle of the cerebellum. Such is the anterior part of the orifice: the lateral and superior parts are formed by the choroid plexuses of the organ and by a horny medullary lamella (valve of Tarni), the extent of which is variable, and which adheres to the prominent border of the fourth ventricle. The form and dimensions of the opening vary with the individual, and with the quantity of cerebro-spinal fluid, so that when the latter exists in considerable quantity the opening can admit the extremity of a finger. Most frequently, when the quantity of the liquid is normal, the orifice does not exceed two or three lines in diameter in every direction, but it is frequently subdivided by vessels which pass from the medulla oblongata to the cerebellum. Sometimes the orifice is restricted by one or by both of the posterior cerebellar arteries which pass across it."

Such is the description of the orifice to which Majendie has given the high-sounding title "*Orifice des cavités encéphaliques*." He states that when fluid is injected into the spinal sub-arachnoid cavity, it makes its way into the ventricles of the brain through this orifice, a statement sufficiently difficult to prove. Cruveilhier, who seems to lean towards Majendie's opinion, admits nevertheless several weighty objections to it. The most important of these appears to me to be that the margins of the orifice which is brought into view by the method directed by Majendie, are irregular, and have the appearance of lacerated membrane. And it is recorded by M. Martin St. Ange, on

the authority of Cruveilhier, that in fifteen subjects in which the latter anatomist found this orifice, its margins had the torn appearance in every one; "that around the opening, here and there, there existed the debris of membranes."*

My own opinion is that this orifice does not exist naturally, but that it is produced by the violence to which the brain is subject in its removal, or in the manipulations necessary for demonstrating it. It appears to me that the fourth ventricle is closed in the same way as the inferior horn of the lateral ventricles, namely, by the reflection of its proper membrane from its floor on to the adjacent pia mater. This membrane is so extremely delicate that the slightest traction upon it is sufficient to disturb its connexions. Its existence may be best proved by the resistance which a probe pushed into the fourth ventricle from above experiences at its inferior extremity, a resistance, however, which a little force can overcome. Or, if the fourth ventricle be opened from the side, by a vertical section of the median lobe of the cerebellum some distance to one side of the median plane, and if this be done on a brain previous to its removal from the body, or on one which has been removed with great caution, so as to occasion the least possible disturbance to the parts, it will be found that the ventricle is closed below by the reflection of its proper membrane upon the pia mater. There can be no doubt that fluid driven against this membrane with force would easily rupture it, whether from within the ventricle or from the sub-arachnoid space.†

It is plain that if there be a direct communication between the fluid in the ventricles and that in the sub-arachnoid cavity at the inferior extremity of the fourth ventricle, it must take place through an opening in that portion of the pia mater which ascends into the fourth ventricle to form the choroid plexus. But it is not necessary to have recourse to such a supposition to account for the transmissibility of fluid from one cavity to the other, for the pia mater is evidently hygrometric, and will readily admit of the passage of fluid through it by endosmose, and it is highly probable that, if any interchange of fluid takes place between the intra-ventricular cavity and the sub-arachnoid space, it is accomplished through the influence of endosmose and exosmose, effected not merely by the pia mater at the inferior extremity of the fourth ventricle, but likewise by that at the inferior cornua of the lateral ventricles, and perhaps also by that of the third ventricle, at the *velum interpositum*. And it is worthy of remark, as tending to confirm this opinion, (which, so far as I am aware, has not previously been suggested,) that at each of these situations there is a conflux (to use Majendie's phrase) of the sub-arachnoid fluid.

Cruveilhier lays some stress upon the fact that in apoplexy the blood escapes from the ventricle into the sub-arachnoid space. For my own part, I would say that this occurrence takes place as often, if not more frequently, at the inferior cornua of the lateral ventricles, as at the fourth ventricle. And therefore, if such a fact be used as an argument in favour of the direct communication of the latter with the sub-arachnoid space, it ought equally to lead to the supposition of the existence of similar orifices at the former situations, the absence of which may be easily proved. Moreover it may be stated that blood sometimes extravasates into the arachnoid sac, breaking through the arachnoid membrane; it is, therefore, less difficult to conceive its bursting the pia mater, which is evidently more porous, and is the seat of those vessels from which the hemorrhage comes, a morbid condition of which is the frequent precursor of the apoplectic attack.

The best way of obtaining the sub-arachnoid fluid with a view to form an estimate of its quantity, is to open the dura mater and arachnoid in the lumbar region of the spine, having previously, by means of a trephine, made a small perforation in the skull, so as to allow the pressure of the atmosphere to bear upon the cranial contents. "If," says Cotunnus, "you open the vertebrae of the loins before the head is touched, and cut the enclosed tube of the dura mater, a great quantity of water will burst out, and after all this spontaneous flux of water is spent, if you lift up the head, and shake it toward the aperture, a more plentiful stream will burst out, as if a new fountain was unlocked. In these experiments, which I made on the bodies of near twenty adults, and which I repeated at different times, I could draw off freely from the hollow of the spine four and sometimes even five ounces of water: I commonly found it very clear in such subjects, although it sometimes inclined a little to a yellow colour; but in fetuses strangled in difficult labour, little as it was, I observed it to be always red and opaque."**

The estimate of the quantity of sub-arachnoid fluid here assigned by Cotunnus exceeds that which Majendie deduces from his experiments, who states that in general in a subject of adult age and mean size, and in moderate condition, two ounces may be regarded as the minimum quantity. Much depends upon the age and size of the subject and the state of nutrition of the nervous centres. In children the quantity is very small; in old age, when the brain and spinal cord have shrunk considerably, the quantity is large. In examining the bodies of the aged poor, as Majendie remarks, eight, ten, or twelve ounces of fluid may be obtained from the cranio-spinal cavity, according as there is a greater or less degree of atrophy of the brain.

In judging of the quantity of fluid around as well as within the cerebro-spinal centres,

* Martin St. Ange. Sur les membranes du cerveau et de la moelle epiniere.

† See the description of the fourth ventricle further on.

** From an English translation of Cotunnus's essay, entitled, *A Treatise on the Nervous Sciatica, or Nervous Hip Gout*, translated by Henry Crantz. London, 1775.

the time which has elapsed since death must be taken into account. As advancing decomposition favours the transudation of fluids through the tissues, it is plain that the longer this period is, the less liquid will be found; and the earlier after death the investigation takes place, the nearer will be the resemblance of the parts to their condition during life. On the other hand, a very advanced stage of decomposition will favour the development of liquid, wherever space may be found for its accumulation. It is, therefore, in vain for the pathologist to attempt to form an opinion respecting the quantity of the fluid found in the cranio-spinal cavity, unless the inspection have been made at an early period after death.

Practical men are too much in the habit of attributing morbid phenomena of the nervous system to the influence of the pressure of a liquid effusion upon the brain or spinal cord. Many facts tend to shew that in a large proportion of cases, especially in the adult, the occurrence of an increased quantity of fluid, either around those centres or within the ventricles, is a result, and that it is probably a result of a conservative kind, consequent upon a morbid change which depresses the general nutrition of those organs themselves. We have seen how the universal decay of the tissues, which characterizes old age, favours the increase of the cranio-spinal liquid, when it affects the brain and spinal cord. In examining the bodies of habitual drunkards, patients who die of delirium tremens, or of cirrhose of the liver, the quantity of fluid is always found to be considerable and the brain shrunk. In bed-ridden persons who have ceased to exercise their faculties for some time, whether for mental or bodily exertion, the same phenomena are witnessed. When there has been much anæmia, as in cases where death has terminated a protracted illness, in phthisis for example, or in persons who have died of hæmorrhage, or after excessive venesection, the nervous centres will be found to be small and the liquid in large quantity. In extreme cases of lead cachexy, in which the nutrition of the nervous and muscular tissues is materially diminished, I have observed similar appearances. And, when any partial atrophy of either brain or spinal cord has occurred, there will invariably be found, at a point corresponding to it on the exterior of the organ, a local accumulation of fluid occupying a depression on its surface which has been caused by the giving way of the nervous substance within.

On the other hand an increase in the quantity of the nervous substance, or an enlargement of the brain or spinal cord, consequent on an undue injection of their bloodvessels, is invariably accompanied with a diminution in the quantity of this fluid or with the total absence of it. In hypertrophy of the brain no fluid is found in the subarachnoid space, and very little or none in the ventricles. In cases of tumour of the brain encroaching upon the cranial cavity, we find no fluid; and the same is observed where chronic inflammation of the

brain has given rise to a new deposit which increases the bulk and the density of the cranial contents. In all cases where a considerable quantity of fluid has accumulated *within* the ventricles, that upon the surface is either greatly diminished or entirely disappears. In the ordinary hydrocephalus internus of children fluid is never found on the exterior of the brain.

When an arrest in the development of any portion of the cerebro-spinal axis has taken place, the space which ought to be occupied by the organ of imperfect growth is filled by liquid. In examining the heads of idiots we always find a considerable quantity of subarachnoid fluid, either general, or partial if a portion only of the brain be deficient. Or if any portion of the wall of the cranio-spinal cavity be defective, the contained viscus is protected by the accumulation of an increased quantity of liquid in the situation of the deficiency. Hence the explanation of those watery tumours which occur over various regions of the spine, in cases of *spina bifida*, in which the accumulation of water is favoured by the absence of the resisting osseous wall of the spine for a greater or less extent. And similar tumours are found projecting from the cranium, being occasioned by a protrusion of the cranial meninges through a congenital aperture, containing fluid and sometimes a portion of the encephalon itself.

Enough has been said to show, that the preternatural increase of this fluid should in general be regarded as secondary to and consequent upon the diminished size of the cerebro-spinal centre itself, and that it has most probably little or nothing to do with the manifestation of peculiar symptoms during life in the great majority of instances. Whatever be the immediate cause of the shrinking of the cerebro-spinal centre or of any portion of it, the increase of the fluid goes on *pari passu*, and in a quantity duly proportionate to the decrease of its bulk, so that it is in the highest degree improbable that, in such cases as I have enumerated, the nervous centre experiences any increased degree of pressure beyond that which it bears in the normal state. If, however, the fluid, either within or without the brain, were to increase, while that organ itself either preserved the same bulk or became enlarged, it is plain that it must experience an increased degree of compression, which doubtless would produce serious symptoms. This very rarely happens, according to my experience, as regards the subarachnoid fluid on the exterior of the brain: we more frequently meet with an increase of the fluid within the ventricles, and, in such cases, we shall find evidence of the compression in a manifestly greater firmness and density of its structure, and in this fact, that the lateral ventricles, when laid open by a horizontal section, do not collapse, as in the ordinary state of the brain, but remain quite patulous, owing to the firmness and density of their walls. And this patulous state of the ventricles may be regarded as a good indication that the fluid, collected in them, had for

some time occasioned a preternatural amount of pressure.*

Majendie infers, and as it appears to me with justice, that the cerebro-spinal fluid is secreted from the vessels of the pia mater. He states that, when a portion of the pia mater is exposed in a living animal, "an attentive eye may observe the transpiration of a liquid which evaporates, it is true, almost as soon as it appears, but which is sufficient to prevent the drying of the membrane." "To render this phenomenon of vital physics still more manifest," he adds, "it is necessary to inject a certain quantity of water, at 30° R., into the veins of the animal which is subjected to the experiment; immediately the liquid exhalation of the pia mater takes place in a more rapid manner, and consequently becomes more apparent." We ought to be content with M. Majendie's statement respecting this experiment: the point in question is by no means of sufficient consequence to warrant the repetition of so cruel an experiment.

Majendie's experiments have demonstrated further that this fluid can be as quickly regenerated as the aqueous humour of the eye. He found that on puncturing the theca of the spinal cord, and perforating both layers of arachnoid membrane, the fluid quickly escapes at first as a fine continuous jet, and afterwards *per saltum* in correspondence with the efforts of expiration. If the orifice be closed up and the animal left to go at large for twenty-four hours, the fluid is reproduced in as considerable quantity as before the first experiment.

What has been described as the movement of this liquid consists in an alternate elevation and collapse synchronous with expiration and inspiration, seen only when a portion of the cranio-spinal wall has been removed, and caused by the repletion of the venous system of the spine which occurs in the former state of the respiratory movements, and its collapse which takes place in the latter. The distended spinal veins compress the cerebro-spinal fluid, and cause it to rise towards the head in expiration; their collapse in inspiration favours the movement of the fluid in the contrary direction. We have no evidence from experiment or direct observation that there is any movement in the fluid of the ventricles; but the discovery of cilia upon the inner surface of these cavities seems to indicate that this fluid is not quite stationary within them.

The following account of the physical and chemical properties of the cerebro-spinal fluid is derived from Majendie's researches. When removed from the body a few moments after death, this fluid is remarkably limpid, and may be compared in this respect to the aqueous humour of the eye; sometimes it has a slightly yellowish tinge. In temperature it ranks among the hottest parts of the body. It has a sickly odour and a saltish taste; it is alkaline, restoring the blue colour of reddened litmus.

Lassaigne's analysis of the human fluid yielded the following result.

Water	98.564
Albumen	0.088
Osmazome	0.474
Hydrochlorate of soda and of potass	} 0.801
Animal matter and phos- phate of soda	
Carbonate of soda and phos- phate of lime	} 0.017
	99.980

According to M. Couerbe, some of the secondary organic products which he has obtained from the brain are to be found in this fluid. The following constituents are enumerated by this chemist: 1. an animal matter insoluble in alcohol and ether, but soluble in alkalis; 2. albumen; 3. cholesterine; 4. cerebrote; 5. chloride of sodium; 6. phosphate of lime; 7. salts of potass; 8. salts of magnesia.

What is the use of the cerebro-spinal fluid? An obvious mechanical use of this fluid is to protect the nervous centres with which it lies in immediate contact. By the interposition of a liquid medium between the nervous mass and the wall of the cavity in which it is placed, provision is made against a too ready conduction of vibrations from the one to the other. Were these centres surrounded by material of one kind only, the slightest vibrations or shocks would be continually felt, but when different materials on different planes are used, the surest means are provided to favour the dispersion of such vibrations.

The nervous mass floats in the midst of this fluid, being maintained in equilibrio in it by its uniform pressure on all sides, and the spinal cord, as we shall find by-and-bye, is supported by an additional mechanism which prevents its lateral displacement.

By its accumulation at the base of the brain, this fluid must protect the larger vessels and the nerves situate there from the unequal pressure of neighbouring parts.

It is not improbable also that this fluid may contribute to the nutrition of the brain and spinal cord, by holding in solution their proper nutrient elements preparatory to their absorption or addition to the nervous masses themselves; and this view would receive great support if Couerbe's analysis, which detects some of these elementary matters in the fluid, should be confirmed by the observations of other chemists. Nor must we omit to notice here, the fact ascertained by Majendie, that when certain substances which find their way readily into the blood have been injected into the veins, they may be soon after detected in this fluid, such as iodide of potassium.

Majendie observed serious symptoms to ensue upon the removal of this fluid from living dogs, but it is impossible to ascribe such symptoms solely to this cause, for the introduction of air into the subarachnoid cavity, the disturbance and consequent irritation to which the nervous centres must necessarily be ex-

* See an important paper by the late Dr. Sims on serous effusion in the brain, *Med. Chir. Trans.* vol. xix.

posed in the performance of the experiment, ought fairly to be considered to have a share, and that not an inconsiderable one, in any impairment of the nervous function that might become apparent. The sudden removal of the fluid brings on fainting or even death, effects due to shock, and analogous to those which result from the sudden removal of dropsical fluid in particular cavities, when the organs and the circulation in them have become adapted to its pressure, as in cases of ascites, hydrothorax, &c.

The interior of the arachnoid sac is moistened by an exhalation of a similar kind to that which is found in the other serous membranes. Accumulations of fluid in the arachnoid sac, however, are of very rare occurrence.

Of the glandule Pacchioni.—To these bodies we have already had occasion to refer in the description of the sinuses. We proceed now with a more special notice of them.

These bodies were first formally described by Pacchioni, and were regarded by him as conglobate glands of the dura mater, from which lymphatics proceeded to the pia mater.* They have been recognized by all subsequent anatomists under the name here assigned to them, although the idea of their physiological office suggested by Pacchioni has not met with general acceptance. Bichat suggested a more appropriate and scientific appellation in that of *cerebral granulations*. No anatomists have investigated the history of these bodies so extensively as the brothers Wenzel.†

The Pacchionian bodies are found principally along the edge of the great hemispheres of the brain on either side of the great longitudinal fissure. Here, in general, they cause the obliteration of the sac of the arachnoid for a greater or less distance by producing adhesion between the visceral layer of that membrane and that portion of its parietal layer which adheres to the angle along the superior border of the falx cerebri. In cases where these bodies are numerous and well developed, it is found very difficult to separate the dura mater from the subjacent arachnoid by reason of the firmness of the adhesion effected by them; and when this adhesion exists, the corresponding surface of the dura mater has generally a very complicated cribriform appearance. The extent of surface which they occupy is very variable. Sometimes, but very rarely, they extend along the entire edge of each cerebral hemisphere; but generally they occupy its central part for an extent of from one to three inches. Very frequently they extend outwards over the surface of the cerebral hemispheres, rarely beyond half an inch or an inch. The arachnoid membrane in their immediate vicinity is always opaque.

Bodies, somewhat similar, are also found oc-

asionally on the choroid plexuses of the lateral ventricles. Very frequently we meet with granulations of a like kind in the fringe-like process of pia mater which descends from the velum interpositum to surround the pineal gland, and also upon the little processes of that membrane which go under the name of choroid plexuses of the fourth ventricle.

Wherever these bodies are found, they show a remarkable tendency to congregate in clusters around venous trunks. In examining them along the edges of the hemispheres, we find that they are most numerous around the veins which pass from the pia mater in that situation into the superior longitudinal sinus. This tendency, probably, explains the occurrence of these bodies in some of the sinuses. They are most commonly met with in the superior longitudinal sinus, as already stated; they are also found in the lateral sinuses, and sometimes but rarely in the straight sinus. In all these situations these bodies appear to stand in a similar relation to the sinuses; they have penetrated the fibrous tunic of their walls, and pushed before them the inner or venous tunic.

In point of size and shape the Pacchionian bodies resemble minute granulations; their colour is white, like that of coagulable lymph, and not unlike that which is occasionally seen upon serous surfaces after chronic inflammation. A granular lymph, taking somewhat a similar form, is occasionally seen on the mucous membrane of the rectum after dysentery. At some parts the granulations appear simply as isolated elevations of the surface of the arachnoid membrane. At others they are collected in clusters round a common stem; and when the membrane is removed and floated in water, this bothryoidal disposition may be well displayed. A large proportion of them cause, by their pressure, an adhesion between the opposed surfaces of arachnoid membrane; and those which are attached to a stem are the most likely to project into the interior of the sinuses.

When examined by a microscope, each of these bodies appears to consist of a mass of minute granules enclosed in a membranous sac; when the body is pediculated, its stalk exhibits a series of striæ which take the direction of its length, and probably result from longitudinal folds of the membrane which forms it. Dilute acetic acid causes them to swell and gelatinifies the bodies, and sometimes displays epithelial scales upon the surface of the membrane which covers them.

The following explanation of this structure may be offered. The primary deposit of granular lymph takes place among the vessels of the pia mater. The small bodies thus formed push the arachnoid membrane before them as a sac or covering; in some instances the granular mass is only partially covered, and then it causes merely a slight projection on the surface of the visceral layer of arachnoid; but in others the mass is completely covered, and a stalk is gradually formed; and when several granular masses have been deposited immediately contiguous to each other, they may all

* Ant. Pacchioni diss. epistolaris ad Luc. Schroeckhium de glandulis conglobatis duræ meningis humanæ, &c. &c. Rom. 1705, et Opusculum Anatomicum de durâ meningē, in Opera Omnia. Rom. 1741.

† Wenzel, de penitiori cerebri structura. Turingæ, 1812.

be attached in a cluster to the same stem. The fact that epithelial particles may be seen upon the surface of the membranous sac of some of the bodies is sufficient proof that it is derived from arachnoid membrane. If this be admitted, then it seems impossible to come to any other conclusion than that the pia mater is the seat of the primary deposit, and this opinion is confirmed by the fact that we meet with the Pacchionian bodies on the internal processes of the pia mater, when we have no evidence of the existence of arachnoid membrane.

Or it might be conjectured that these bodies indicate a degenerate condition of the elementary particles of the superficial layer of the grey matter of certain convolutions, produced by frequent irritation.

Are the Pacchionian bodies natural structures?

The great frequency with which these bodies are met with in the various situations above-mentioned, has induced many, even in the present day, to regard them as normal structures, the physiological office of which is as yet unknown. But there are many facts which strongly militate against such a conclusion. In the first place it may be observed that Pacchionian bodies never occur in the earliest periods of life. In the course of a long experience in anatomical investigations I have never seen them at a period antecedent to six years. The brothers Wenzel, who made a series of special examinations with a view to determine this question, make the following statement. In children, from birth to the third year, these bodies, if they ever occur, must be very few. From the seventh to the twentieth year they sometimes are numerous. From the latter period to the fortieth year their number is considerable, and the nearer we approach the fortieth year the greater does it become. Lastly, from the fortieth to the one hundredth year these bodies are found in great numbers.

It must be further remarked that even at those periods of life when the Pacchionian bodies are found in greatest numbers, cases frequently occur in which no trace of them can be found. There is likewise the greatest variety as to their number and size, in different individuals of the same age.

It has always occurred to me to find them most numerous in cases where I had reason to know that the brain had been subject to frequent excitement during life. In persons addicted to the excessive use of spirituous liquors, in those of irritable temperament and who were frequently a prey to violent and exciting passions, they are almost uniformly highly developed.

The Pacchionian bodies are peculiar to the human subject. Nothing similar to them has been found in any of the inferior classes of animals.

In reference, then, to the question, what is the nature of these bodies, I have no difficulty in stating my opinion that the evidence greatly preponderates in favour of their morbid origin; that they are the product of a chronic very gradual irritation due to more or less frequent functional excitement of the brain itself. It is not unlikely that the friction to which the opposed surfaces of the arachnoid are conti-

nually subjected in the movements of the brain, especially when they are of a more rapid and violent kind, as under states of cerebral excitement, may contribute to the development of many of the appearances connected with these bodies. The opaque spots which are of such frequent occurrence upon the surface of the heart may be quoted as an example of a morbid change, very commonly met with, and resulting probably from the friction against each other of opposed serous surfaces. Were the Pacchionian bodies normal structures, they would not be so frequently absent from brains which afforded every other indication of being in a healthy state; nor should we find opacity of the arachnoid (a decidedly unhealthy condition) so commonly coexistent with the full development of them. Again, were they a necessary part of the healthy organism, we might expect to find them more constant as regards size, number, and the extent of surface over which they were placed.

Of the ligamentum dentatum (serrated membrane of Gordon).—This structure forms a part of the mechanical arrangements connected with the spinal cord and the roots of its nerves. It is found in the subarachnoid space, adhering on the one hand to the pia mater, and, on the other, attached at certain intervals to the dura mater.

The ligamentum dentatum consists of a narrow longitudinal band, adhering by its inner straight border to the pia mater on each lateral surface of the spinal cord, midway between the anterior and posterior roots of the spinal nerves, reaching from the highest point in the cervical region down to the filiform prolongation with which it becomes incorporated. Its outer border exhibits a series of tooth-like triangular processes which are inserted by their apices into the dura mater. The first pointed process, which is longer than the rest and less triangular in shape, is inserted into the dura mater on the margin of the occipital bone, where it stands in relation with some parts of interest. The posterior root of the sub-occipital nerve, and the filaments of origin and the resultant trunk of the spinal accessory, are on a plane posterior to it. The vertebral artery and the ninth pair of nerves are anterior to it. The number of teeth varies from eighteen to twenty-two. The last is attached to the dura mater about the level of the first or second lumbar vertebra. The points of attachment are between the points of exit of the spinal nerves, being almost always nearer the lower than the upper nerve. The intervals between each pair of dentated processes vary in different regions of the spine as the distances between the roots of the nerves vary. At its insertion into the dura mater each process pins down the visceral and parietal layers of the arachnoid membrane, probably piercing them to reach the fibrous membrane. At its lowest part, a little above the extremity of the cord, the denticulated margin ceases, and the longitudinal portion may be traced downwards, gradually diminishing in size, along each side of the filiform prolongation of the pia mater.

The dentated ligament has to the naked eye

Fig. 370.

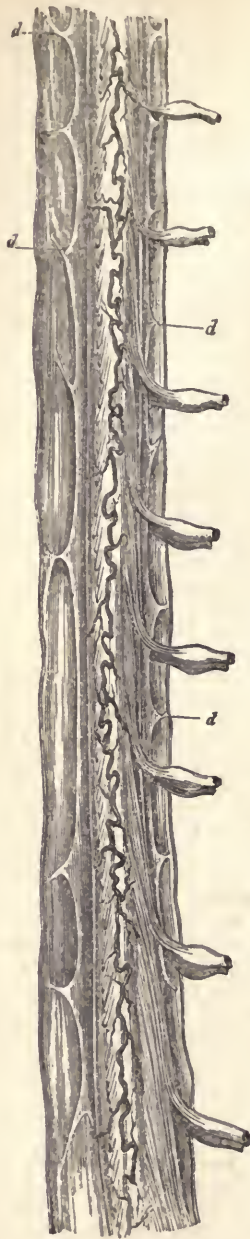

Dura mater of part of the spinal cord laid open to show the ligamentum dentatum.

d d d, dentated processes. On the right the roots of the nerves and the ganglia of the posterior roots are retained.

all the characters of white fibrous tissue, of which it is chiefly composed. In its dentated processes, however, a considerable quantity of yellow fibrous tissue may be found. The similarity of its constitution with that of the pia mater evidently justifies its being regarded as a

process of that membrane, and not, as some anatomists thought, of the dura mater, with which it has a much less intimate and extensive connexion. Its anterior and posterior surfaces are uncovered by any membrane; they are smooth, and have the glistening silvery appearance of white fibrous membrane. It is evident that during life these surfaces must be bathed by the subarachnoid fluid.

The office of this remarkable structure seems evidently to be mechanical; to preserve the spinal cord in a state of equilibrium; and to prevent lateral movement of it, whilst at the same time it forms a partition between the roots of the nerves.

General remarks on the structure of the nervous centres.—It has already been shewn in a former part of this article that the nerves properly so called are composed exclusively of one kind of nervous substance,—namely, the fibrous nervous matter, which is disposed in bundles of peculiar fibres. It is only in the nervous centres or in continuations of them that we find an union of the white and the grey nervous matter; and, indeed, it may be stated in general, that the peculiar and distinctive anatomical character of a nervous centre consists in this combination of the two kinds of nervous matter.

In the nervous centres the white matter exhibits, for the most part, the same essential characters of structure as in the nerves; that is to say, it is disposed in tubes containing a certain pulpy matter in them. It has been found, however, that these tubes are much more prone to become varicose under the influence of pressure or of any other disturbing cause. They are not, as in the nerves, bound together by areolar tissue, but are disposed in bundles and on different planes, with their nutrient bloodvessels ramifying among them, and in some situations the elements of the grey matter are interposed between them. Certain parts of the nervous centres are composed exclusively of white matter, as a portion of the hemispheres of the brain, and of the cerebellum, and the superficial parts of the spinal cord.

The white fibres which are found in the nervous centres may be distinguished according to their physiological office into four different kinds. Two of these are continuations of the fibres of the nerves, and serve to connect the nervous centres with other organs or textures, either by conveying the influence of the centres to them, or by propagating impressions from them to the centres. The former are called *efferent*, the latter *afferent* fibres. In addition to these, we find a third and large series of fibres, which serve to establish a connection between different centres, or between different portions of the same centre. These are called *commissural* fibres; they form a large portion of the mass of the brain and spinal cord. And Henle suggests that the brain contains a fourth series of fibres, associated with the operations of thought.

We remark in the nervous centres, especially in the brain and spinal cord, a greater difference as regards size between the different nerve tubes, than may be observed elsewhere, and it seems to be a constant character that they diminish

in size as they approach and enter the grey matter.

Of the grey nervous matter.—The grey nervous matter differs very materially in its anatomical characters from the white. Its elements are vesicles or cells, with nuclei and nucleoli. Although this vesicular or cell form is universally prevalent, the cells present much diversity of shape, size, and colour in different centres or even in the same centre, which apparently have reference to some peculiarity of function. The most prevalent form is that of a globular vesicle, composed of a very delicate transparent membrane. Within this membrane is contained a soft minutely granular substance, which forms the principal mass of the body, *parenchymassa* (Valentin). The grey colour of the vesicle, which becomes very manifest when a number of them is congregated together, is dependent on this granular matter. (See *fig. 371, a, b, c.*) When the vesicle bursts and its substance is broken up, the granular matter is diffused, and confuses and darkens the specimen under examination. Sometimes the outer vesicle is removed, the contained granular matter retaining the globular form. Within the external vesicle (*a, fig. 371*) there

*Fig. 371.**

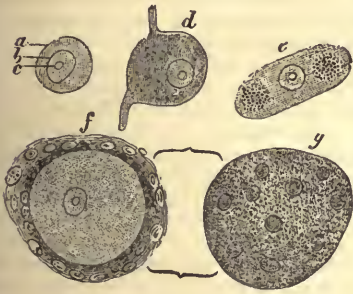

Nerve vesicles from the Gasserian ganglion of the human subject.

a, a globular vesicle with defined border; *b*, its nucleus; *c*, its nucleolus; *d*, caudate vesicle; *e*, elongated vesicle with two groups of pigment particles; *f*, vesicle surrounded by its sheath or capsule of nucleated particles; *g*, the same, the sheath only being in focus.

is another much smaller and adherent to a part of its wall, so as to be quite out of the centre of the containing vesicle. This is the nucleus (*b, fig. 371*). Its structure is apparently of the same nature as that of the external vesicle. The nucleus contains in its centre another minute and remarkably clear and brilliant body, also vesicular in structure. This is the nucleolus (*c, fig. 371*). Sometimes it is replaced by two or three much smaller but similar bodies. The softness of the vesicle admits of its yielding, whether from the disturbance occasioned in the necessary manipu-

lation or from the pressure of the neighbouring elementary parts as it lies in its proper situation. Hence it is that these vesicles exhibit a considerable diversity of form.

Very frequently we observe that, besides the granular substance above described, there are certain pigment particles of large size and dark colour, which are collected into one or two roundish or oval groups, situate at or towards one or both sides of the vesicle (*fig. 371, e*). These masses of colouring matter sometimes occupy considerable space, and enable the observer readily to detect the position of such vesicles as contain them. When the mass of pigment is placed at one side, we may compare the containing vesicle, as Volckmann has done, to a fruit which is coloured only on that side which is exposed to the sun. The aggregation of many such vesicles at any one spot gives the nervous matter there a peculiarly dark colour. A remarkable example of this is found in that portion of the crus cerebri which is known by the name of *locus niger*.

A very interesting form of nerve-vesicle is that which exhibits the greatest departure from the globular shape by the prolongation of the wall of the outer cell into one or more tail-like processes. These bodies may, from this peculiar character, be designated *caudate nerve-vesicles*. They possess the nucleus and nucleolus, as in the more simple form, and contain one or more of the masses of colouring matter; indeed, in them the quantity of pigment is generally much more considerable than in any other form. I have noted an observation which shewed two nuclei in one vesicle. They vary much in size and shape, and so also do the processes. The largest nerve-vesicles are found among those of this description. The variety in shape may depend in some degree upon the situations from which the caudate processes take their rise. In some (*fig. 371, d*) they proceed from opposite poles of the vesicles; in others they arise near each other from the same region of the vesicle, and when numerous, give to it somewhat the form of a cuttle-fish with extended tentacles. In examining the structure of one of these processes, we find it evidently exactly similar to that of the matter contained in the outer vesicle, exhibiting the same minutely granular appearance. The processes are implanted in the surrounding substance, and firmly connected with it, so as to be with great difficulty separated from it. They exhibit much strength of cohesion, but are frequently broken off quite close to their points of origin, and the broken ends present a distinctly lacerated edge (*d, fig. 371*). More rarely we are able to trace these processes to a considerable distance, and then we observe them to bifurcate or even to subdivide further, and to terminate in exceedingly fine transparent fibres, the connexion of which with the other elements of the nervous matter has not yet been ascertained.*

* I am indebted to the accurate pencil of my friend Mr. Bowman for this illustration.

* See a beautiful illustration of one of the largest of these vesicles in the second part of Mr. Bowman's and my work on Physiological Anatomy and Physiology.

It is in vain, in the present state of our knowledge, to speculate upon the use of these caudate processes. Do they constitute a bond of union between the nerve-vesicles and certain nerve-tubes? or are they commissural fibres serving to connect the grey substance of different portions of the nervous centres? Until a more extended research has made us better acquainted with the peculiarities of these vesicles in various localities, it would be premature to offer any conjecture concerning their precise relation to the other elements of the nervous centres. They exist, with different degrees of development, in the locus niger of the crus cerebri, in the laminæ of the cerebellum, in the grey matter of the spinal cord and medulla oblongata, and in the ganglions, and in the grey substance of the cerebral convolutions, in which latter situation they are generally of small size.

When a portion of grey matter from a convolution of the brain is examined with a high power in the microscope, we observe it to consist chiefly of a mass of granular matter, in which nerve-vesicles are imbedded with considerable intervals between them. Henle states, with much truth, that the superficial part of the grey matter of the convolutions seems almost entirely composed of finely granular substance, in which lie, scattered here and there, several clear vesicles which, as he remarks, look almost like openings (*fig. 372*). In the middle portion the vesicles appear larger, and the granular matter becomes less abundant, and on the most deep-seated plane the nerve-vesicles are much increased in size and lie in closer juxtaposition, being, however, covered by a thin layer of granular matter, which forms a sheath to each vesicle. Nerve-tubes are found throughout the whole depth of the grey matter. Those in the most superficial layer are extremely fine and varicose, and seem to correspond in number and situation to the vesicles. For wherever there is a nerve-vesicle, we find an extremely fine varicose nerve-tube apparently adherent to it.

Fig. 372.

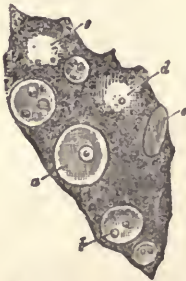

Grey substance from the surface of the cerebral hemisphere of a full-grown rabbit treated with dilute acetic acid. (After Henle.)
a, nerve-vesicle; *b*, a similar one with two nuclei; *c*, another viewed along its edge; *d*, vesicles indistinctly apparent; *e*, granular matter.

In the grey matter of the ganglions we find that the vesicles are also deposited in granular matter, which surrounds each of them as a sheath (*fig. 371, f, g*), completely investing it

on every side, and separating it from the neighbouring ones. Here, however, the sheath is formed not only of a finely granular matter, but also of numerous bodies which resemble nuclei or cytoblasts, and this sheath invests both the globular variety of nerve-vesicles and the caudate ones. Nerve-tubes lie in immediate connexion with these vesicles, and sometimes entwine themselves around them, and seem to indent their sheaths (*fig. 375*.)

Other vesicles, much more simple in form, are found in the grey matter in certain situations. The outer layer of the optic thalamus, according to Henle, contains only small homogeneous globules, analogous to the nuclei of the ganglionic globules, in immediate apposition with each other, and towards which the tubes seem to ascend in the vertical direction. Purkinje states, that a similar layer is met with in the cortical substance of the brain quite close to the medullary substance.* I find a layer of similar particles in the grey matter of the cerebellic laminæ. And, according to the report of Valentin,† Purkinje has found the interior of the ventricles in the normal state covered by an oily matter, which consists of distinct, large, transparent globules, free and lying near each other. A similar layer has been found by him in the interior of the fifth ventricle. The cavity of the rhomboidal sinus in Birds likewise contains a gelatinous mass, which consists of large globules lying close to each other.‡

Development of grey matter.—In the perfect nerve-vesicle, the cell form of primitive development is persistent. We have the nucleolus and nucleus (cytoblast) and the cell; and, according to Schwann, the only change which the full-grown cell exhibits consists in an increase of size and in the development of the pigmentary granules within. The following is Valentin's description of the development of a nerve-vesicle. In the very young embryos of Mammalia, as the sheep or calf, the cerebral mass in the course of formation contains, in the midst of a liquid and transparent blastema, transparent cells, with a reddish yellow nucleus. The wall of the cells is very thin and simple; their contents are colourless, transparent, homogeneous, and manifestly liquid; the nucleus, with well-defined contour, is generally round, sometimes central, at other times excentric, solid, and nearly of the same colour as the corpuscles of the blood. Around these primitive cells of the central nervous system, which we find likewise formed after the same type in the spinal cord, a finely granular mass becomes deposited, which probably is not at first surrounded by an enveloping cell-membrane. At this early period of formation the primitive cell still preserves its first delicacy to such a degree that the action of water causes it to burst immediately. This rupture of its membrane and effusion of its contents often take place so suddenly and quickly that they can be perceived

* Henle, loc. cit. † Über den Verlauf, &c.

‡ See further remarks on the grey matter in the account of the minute structure of the brain and spinal cord in a subsequent part of the article.

only by the movement of the nucleus, which is the consequence of it. * * * In proportion as the granular mass contracts itself within certain limits, (sich immer mehr abgrenzt,) a cell-membrane probably becomes developed around it, so that the vesicle gradually acquires its precise form and size, and its contents their proper characters, which belong to a fully formed central nervous corpuscule.* Valentin compares the development of these vesicles to that of the ovum. The nucleolus of the nerve-vesicle is always first formed, then around it the primitive cell, and around this the outer cell. This process resembles exactly that which takes place during the formation of the ovum, for the germ corresponds to the nucleolus, the germinal vesicle to the nucleus, the yolk to the contents of the outer enveloping cell, and the vitelline membrane to the delicate wall of this cell, supposing that this latter membrane always exists.†

The great simplicity in the form of the elements of the grey nervous matter is one of its most remarkable characteristics. That a tissue, which, as will be shown by-and-bye, plays so prominent a part in the nervous actions, whether they are prompted by mental change, or are purely corporeal, should exhibit scarcely any more complexity of structure than that which is found in the simplest animal or vegetable textures, or in structures that have not passed their earliest phase of development, is an anatomical fact pregnant with great physiological interest. Have this simplicity of form and delicacy of structure reference to the celerity of the nervous actions? or to that proneness to change which must be induced by the constant and unceasing round of impressions which the grey matter must receive from the ordinary nutrient actions that are going on in the body, as well as from the continual action of thought? If, according to common acceptance, we admit that the mind is in immediate connexion with the cerebral convolutions, it may well be imagined that no part of the frame can be the seat of such active change, from its being on the one hand the recipient of impressions from the body, and, on the other, from an association with the psychological principle so intimate that probably, under ordinary circumstances, an affection of the one cannot occur without being communicated to and producing a change in the other.

Another curious fact, in connexion with the intimate structure of the grey nervous matter, is the large quantity of pigment or colouring matter which exists in it, and which appears to form one of its essential constituents, more abundant in some situations than in others, but present in all. We are utterly ignorant of the design of this peculiarity of structure. If this pigment bear any resemblance of chemical composition to the colouring matter of the blood, *hematosine*,—and it is not improbable that it does,—an increased interest attaches to the practical importance of minute attention, on the part of practitioners, to avail themselves

of all the means which are capable of improving that important element of the nutrient fluid both in quantity and quality, for it is most reasonable to presume that the pigment of the nervous matter would derive its nourishment from that of the blood.

It may be further remarked that pigment occurs in connexion with the nervous system in another form besides that of incorporation with its elementary particles, that is, upon the exterior of parts of the nervous centres or of particular nerves. Examples of this may be referred to in the case of the olfactory nerve of the sheep and of other Mammalia, the bulb of which is surrounded by black pigment connected with the pia mater. It is also found sometimes on the pia mater of the spinal cord of the human subject. Valentin, who delineates a magnified view of this pigment, states that it occurs chiefly in the cervical region. In frogs, the whole spinal cord and encephalon are covered with a silvery pigment interspersed with black. The same occurs in fishes. The black pigment in connexion with the retina has an obvious use. On the choroid gland of fishes, which lies immediately contiguous to the retina and surrounds the optic nerve, there is a silvery membrane which contains a quantity of the same kind of pigment as that alluded to upon their nervous centres. On some of the ganglia of the invertebrata particles of pigment are likewise found.

Of the structure of ganglions.—The description of the minute anatomy of ganglions as well as of all other nervous centres may be regarded as the solution of the following problem: to determine the relation which the white substance of these centres bears to the grey matter on the one hand, and to the nervous trunks connected with them on the other hand.

The white substance of the ganglions consists of a series of minute nerve-tubes, as well as of some gelatinous fibres, which are continuous with those which exist in the nerves themselves. If we trace a nerve into a ganglion, it is found to break up into its component nerve-tubes, and it does so by a separation of the tubules within into smaller bundles, or single tubes. Sometimes adjoining bundles interlace, each yielding to its neighbour one or more tubes. The nerves which emerge from the ganglia derive their component nerve-tubes from different bundles, so that the same kind of interchange of tubules, which we have noticed as taking place in plexuses, occurs also in ganglia. The emerging nerves result from a further subdivision and greater intermixture of the bundles of nerve-tubes which enter the ganglions. The arrangement is well shown in *fig. 373*, where the nerve (*a*), which enters the ganglion, may be seen breaking up into a plexus, from which three branches (*b*, *b*, *b*) emerge, and it may be observed that these emerging nerves derive nerve-tubes from very different and opposite parts of the ganglionic plexus. In the meshes, which are left between the interlacing nerve-tubes, the ganglionic globules or nerve-vesicles are situate (*figs. 373, 374*). Certain fibres, according to Valen-

* Valentin, in Soemmering vom Baue, &c. t. iv. § 24.

† Loc. cit. § 25.

Fig. 373.



Second abdominal ganglion of a greenfinch, slightly compressed under the compressor. The course of the nerve-tubes only is represented. *a*, fibres passing in; *b*, emerging fibres; *c*, surrounding fibres. The meshes for the reception of ganglion globules are shown.

Fig. 374.



A small piece of the otic ganglion of the sheep, slightly compressed, showing the interlacement of the internal fibres and the grey matter. (After Valentin.)

tin, travel round the margin of the ganglion, and to these he gives the name of *umspinnende Fasern*, surrounding fibres, and some fibres pass from them to the more central ones, or from the latter to the former. Nerve-vesicles exist at the circumference of the ganglion as well as in its interior, and to them is due the peculiar grey colour of that body.

The best mode of examining these points is to select the smallest ganglia of very small animals, birds, mice, &c.; these, when subjected to compression, become very transparent, and display much of their intrinsic arrangement. Or thin slices of large ganglia may be placed under the microscope, and when torn up by needles the disposition of the nerve-vesicles and the caudate processes, when present, are rendered visible. And none is more suitable for this purpose than the Casserian ganglion of the fifth nerve, which by the absence of a dense sheath and its greater looseness of texture is more easily examined.

It is a highly important problem, in minute

anatomy, to determine whether there are any nerve-tubes which terminate in the grey matter of the ganglion, or originate in it,—which in short are not continued through the ganglion. At present we are unable to state further than that the tubes appear to have an intimate connection with the nerve-vesicles wherever the latter may be found, and that they often appear to be continuous with the sheaths of the nerve-vesicles.

Fig. 375.



Nerve vesicles from the Gasserian ganglion covered by their sheaths of nucleated particles, to show the intimate relation of the nerve-tubes to them.

t, t, nerve-tubes; *v, v*, vesicles.

There does not appear to be any material difference of structure between the ganglia of the sympathetic and those of the cerebro-spinal system, excepting, as Henle states, the existence of a greater number of gelatinous fibres in the former.

Of the cerebro-spinal centre.—The nervous mass which occupies the cavities of the cranium and spine doubtless constitutes one great centre, as there is a perfect continuity throughout all its parts. But the differences of external form and characters in some regions of it, and the obvious diversity of endowment of the nerves connected with certain portions, denote and justify an anatomical as well as a physiological subdivision of it into segments, each of which is a centre of nervous action independent of the rest, yet so connected with them that the functions of all are made to harmonize in the most perfect manner.

The subdivision which the external anatomy indicates, although not perfectly coincident with that which the differences of function would suggest, has been so long sanctioned by usage and is so convenient for description, that no advantage would be gained by adopting any other. Our description of the cerebro-spinal centre, or axis as it has also been called, will be given under the following heads: 1. the spinal cord; 2. the encephalon, including *a*, the medulla oblongata; *b*, the mesocephale; *c*, the cerebellum; *d*, the cerebrum.

1. OF THE SPINAL CORD.—Syn. *Spinal marrow*, *Medulla spinalis*; Fr. *La moëlle épinière*; Germ. *Das Rückenmark*. The following are the anatomical limits which may be assigned to the spinal cord. It occupies a large portion of the spinal canal, terminating inferiorly at a point which, in different subjects, ranges between the last dorsal and the second lumbar vertebra. Below this point the sheath formed by the dura mater contains that leath of nerves which is called the *cauda equina*, in

the centre of which lies the filiform prolongation or process of the pia mater. The superior limit of the spinal cord is marked by the plane which lies between the occipital foramen and the first vertebra of the neck. A section made in the direction of this plane separates the spinal cord from the medulla oblongata. Immediately above this plane the decussation of fibres of the anterior pyramids takes place, and may be regarded as the natural inferior limit to the medulla oblongata.

Such is the position of the spinal cord in the adult. In the fœtus at the third month of intra-uterine life, it occupies the whole spinal canal, and extends quite to the point of the sacrum. At this early period the os coccygis consists of seven vertebræ. Coincident with its reduction to its normal number of segments, is the retraction of the spinal cord within the spinal canal. If the ascent of the cord be arrested, the fœtus is born with a tail, for the changes of the coccyx become arrested also. It is remarkable that among the inferior animals there is a direct proportion between the length of the spinal cord and that of the tail. The shorter the former, or the higher in the spinal canal it may be, the less will be the latter. In animals with long tails there is no *cauda equina*, as is the case in the ox, the horse, the squirrel, &c. and the opposite is likewise true, namely, that in animals with a short tail the spinal cord is much shorter and is placed higher up in the spinal canal. In the embryo of the bat, which has a tail, the spinal cord extends downwards, but when it loses its tail the cord appears to occupy a much smaller portion of the spinal canal. In the tadpole of the frog, likewise, the spinal cord extends into the tail, but when the tail has disappeared the cord occupies only a portion of the spinal canal.*

In point of shape, the spinal cord is cylindrical, slightly flattened on its anterior and posterior surfaces, more so on the former than on the latter. At its inferior extremity it gradually tapers to a point. Sometimes, however, we observe a small tubercle immediately above this pointed extremity, situated on the posterior surface. The perfect cylindrical form of the cord is destroyed, not only by this pointed termination and the flattening before and behind, but likewise by a marked change of dimensions in certain regions. In the cervical region we observe a distinct swelling or enlargement, which begins a short distance beneath the medulla oblongata, and gradually passes into the dorsal portion, which is the smallest, as well as the most cylindrical part of the cord. This cervical enlargement (*intumescencia cervicalis*) begins opposite the third cervical vertebra, and ends about the third dorsal. The cord continues of a cylindrical form as low as about the ninth or tenth dorsal vertebra, and then passes into the lumbar swelling (*intumescencia lumbalis vel cruralis*), which occupies a space corresponding to about two vertebræ. This swelling is both shorter and of less diameter

than that in the region of the neck. The inferior extremity of the spinal cord tapers rather suddenly, and at its point is enclosed in the commencement of the filiform prolongation of the pia mater.

The bulk of the spinal cord is in the direct ratio to that of the body throughout the vertebrate series. And not only is this true with regard to the whole cord, but with respect to its segments. For when any segment supplies nerves to a greater sentient surface, or to more numerous or more powerful muscles than another, it exhibits a proportionally greater size. It is thus that we may satisfactorily explain the occurrence of the cervical and lumbar enlargements. Both supply nerves to the extremities, whilst the dorsal portion furnishes them only to the trunk. The upper extremities enjoy, in part, a high degree of tactile sensibility, and they possess great power and extent of muscular movement. That portion of the cord therefore from which the nerves to the upper extremities proceed is larger in every way than that which supplies the lower extremities, which, although provided with large and powerful muscles, do not enjoy such a range or variety of motion as the upper extremities, nor are they endowed with so exquisite a sensibility.

There are many interesting facts among the lower animals which illustrate and confirm this law. Thus, in animals which have no limbs, as serpents, the cord is of equal size throughout, excepting at its pointed extremity. It is said that in the fœtus, before the development of the limbs, no distinction of size can be discovered in the cord, and in persons in whom an arrest in the development of the upper extremities has taken place, there is no cervical enlargement. Cruveilhier refers to the case of the tortoise as strongly confirmatory of this law. That portion of the spinal cord which corresponds to the carapace, which is equally devoid of sensation and motion, is reduced to a mere thread, whilst those segments between which it lies, and from which the nerves of the extremities emanate, are of size duly proportionate to their muscular activity and their sensibility. In Fishes, the enlargements correspond to the fins which are possessed of greatest muscular power. In the gurnard there exist certain very remarkable ganglionic swellings, situate on the posterior part of the cervical segment of the cord. With these swellings nerves are connected, which are distributed to organs placed immediately behind the head on the lower part of the body. These organs are endowed with much tactile sensibility, and seem to serve the office of feelers, as the animal gropes along the bottom of the sea.

The length of the spinal cord in the adult is from sixteen to eighteen inches, according to the statement of Cruveilhier. Its circumference measures twelve lines at the smallest and eighteen lines at the most voluminous part. Chaussier states that its weight is from the nineteenth to the twenty-fifth part of that of the brain in the adult, and about the fortieth

* Cuvier's Report upon Serres' work, Sur l'Anat. Comp. du Cerveau. Par. 1824.

part in the new-born infant. The actual weight of the spinal cord in an adult male may be stated to be a little more than one ounce.

We may here again notice the interesting fact that there is a great disproportion between the size of the spinal cord and that of the vertebral canal, and that consequently a considerable space is found between the cord and its membranes which is occupied by the cerebrospinal fluid.

The consistence of the medullary substance of the spinal cord, in the fresh state, is of much greater firmness than that of the brain. This lasts, however, but for a very short time, for decomposition sets in quickly, and then the cord acquires a pultaceous consistence, and the nervous matter may be easily squeezed out of the sheath of pia mater in which it is enclosed.

The pia mater adheres very closely to the surface of the cord, as intimately as the neurilemma to a nerve. In order to examine the surface of the cord, the best mode of proceeding is to dissect off the pia mater carefully, the cord having been fixed under water. The dissector will then perceive that numerous minute vessels, accompanied by delicate processes of the membrane, penetrate the cord at all points from the deep surface of the pia mater, and to this is due the adhesion of this membrane above-mentioned. This arrangement may also be shewn by dissolving out the nervous matter through the action of liquor potassæ. The prolongations from the deep surface of the sheath may be shewn by floating the preparation in water.

The spinal cord is penetrated both on its anterior and posterior aspect by fissures, each of which corresponds to the median plane. They are separated from each other by a transverse bilaminar partition of white and grey matter, of which the grey layer is posterior. This serves to connect the equal and symmetrical portions into which the cord is divided by these fissures.

The *anterior* fissure is very distinct and easily demonstrated. A folded portion of the pia mater may be traced into it down to the commissure. The edges of this fold, as it enters the fissure, are connected by a band of white fibrous tissue, which may be traced through the whole length of the cord on the exterior of the pia mater, and indicates precisely the position of the anterior fissure, and which covers the anterior spinal artery. When this fold is carefully removed, the floor of the fissure becomes apparent, formed of a lamina of white nervous matter. This layer is perforated by a great number of minute orifices, which give to it quite the cribriform character, and are for the reception and transmission of bloodvessels. In many parts the layer appears to be composed of oblique and decussating fibres, as if the same kind of decussation which occurs at the lower part of the medulla oblongata extended through the whole length of the cord. There is not, however, any real decussation: the appearance of it results from the foramina not being always on the same

level. For, in those places where they lie quite on a level with each other, no one could suppose that such an arrangement of fibres existed. Here, as elsewhere, the fibres assume the transverse direction. The depth of the anterior fissure is not the same all down the cord; it gradually diminishes towards its lowest point; its deepest part, however, corresponds to the cervical enlargement, and here it is about one-third of the thickness of the cord measured from before backwards.

The whole cribriform layer which forms the floor of the anterior fissure constitutes a commissure between the lateral halves of the cord in their whole length. It is called the *anterior* or *white commissure* of the cord.

The *posterior* fissure is very much finer and more difficult to demonstrate than the anterior. It is not penetrated by a *fold* of the pia mater: a single and very delicate layer of that membrane is continued from its deep surface down to the floor of the fissure. It is at this situation that the spinal pia mater assumes the appearance and character of that of the brain. Here and there, within the fissure, the pia mater appears interrupted and the vessels extremely few, and in such situations the fissure becomes very indistinct and difficult to recognise. The process of pia mater becomes extremely delicate towards the lowest extremity of the cord. The posterior fissure is deeper than the anterior. Through a great part of its course it is equal to fully one-half of the thickness of the cord; in the lumbar region, however, its depth is very much less. Its floor is formed by a layer of grey matter, which connects the circuitous matter of each lateral half of the cord, and which is called the *grey commissure*. In the lumbar region, however, it does not appear to reach the grey commissure.

Arnold denies the continuity of the posterior fissure through the greater part of the cervical and dorsal regions. According to his figures it ceases on a level with the second cervical nerve and reappears about the second dorsal vertebra. This does not at all accord with my observation, nor is it confirmed by any anatomist that I know of. It appears to me that the continuity of the fissure might be more properly questioned at the lowest third of the cord, where it is often so feebly developed as to elude detection. In three out of four specimens now before me, the fissure is sufficiently distinctly marked down to quite the lowest extremity of the cord, and the posterior columns separate readily from each other along it. In the fourth, which is quite recent, the fissure at the lowest part of the cord is only to be distinguished here and there by a solitary red vessel passing to the grey commissure, and is most distinct in the cervical region. Those specimens which shew it well have been hardened in a preserving liquid, which, by constringing the substance of the posterior columns, renders the fissure much more distinct. There seems little doubt that the posterior columns have no connexion with each other as far down as the lumbar region. Below that, however, it is not improbable that they may be united across

the middle line, and that to this cause the indistinctness of the posterior fissure may be due. And this anatomical fact may be quoted as, in some degree, adverse to the theory which regards these columns as sensitive: for were they columns of sensation, it is probable that the preservation of their distinctness would have been more fully provided for.

The anterior and posterior fissures, as Cruveilhier remarks, leaving on each side a perfectly symmetrical organ, serve to demonstrate the existence of two spinal cords, one for each side of the body, and both presenting a perfect resemblance of form and structure.

There are no other fissures in the cord besides those just described. Several anatomists regard the lines of origin of the anterior and posterior roots of the nerves as constituting distinct fissures. But a little careful examination will readily convince any one that there is no real separation of the nervous substance of the cord corresponding to these lines, and that there is no anatomical indication of a subdivision into columns or segments in connexion with them. When the roots of the nerves have been removed on each side, nothing is seen but a series of foramina or depressions corresponding to the points of emergence of the nerve-fibres, of which the roots are composed.

The most natural subdivision of the spinal cord is that which is obviously indicated by its internal structure. In examining a transverse section (*fig. 376*), we observe that the interior

Fig. 376.



of each lateral portion is occupied by grey matter, disposed somewhat in a crescentic form. The concavity of the crescent is directed outwards: its anterior extremity is thick, and is separated from the surface of the cord by a considerable layer of white nervous substance. The grey matter is prolonged backwards and outwards in the form of a narrow horn, which reaches quite to the surface of the cord, and near the surface experiences a slight enlargement. This posterior horn constitutes, on each side, a natural boundary between the two columns of which each lateral half of the cord consists. All that is situate in front of the posterior horns is called the *antero-lateral* column, and this comprehends the white matter forming the sides and front of the semi-cord, limited anteriorly by the anterior fissure and posteriorly by the posterior roots of the nerves. The posterior column is situate behind the posterior horn of grey matter, and is separated from its fellow of the opposite side by the posterior fissure.

According to this view, then, the spinal cord will be found to consist of four columns, between which an obvious line of demarcation exists throughout the whole length of the organ. These are two *antero-lateral* columns

and two *posterior* columns. The former constitute by far the largest proportion of the white substance of the cord, and they envelope the anterior obtuse portion or horn of the grey matter. The white commissure at the bottom of the anterior fissure unites them. The anterior roots of the nerves are connected with them, and the posterior roots adhere to them when the cord is split up along the plane of the posterior horn. The posterior columns are small, in section triangular, placed in apposition with each other by their inner surfaces. Their apices are directed forwards, and their bases, which are slightly curvilinear, backwards. No distinct commissure of white fibres can be detected uniting these columns, save, perhaps, in the lumbar region. The connexion of the posterior roots of the nerves with them must necessarily be very slight, as they invariably separate from them in the longitudinal splitting of the cord.

The arrangement of the grey matter in the cord, as already partly explained, is as follows: In each lateral half there is a portion of grey matter, which is crescentic in form, having its concavity directed outwards and its convexity inwards towards its fellow of the opposite side. The anterior extremity or horn of the crescent is thick and roundish, and its margin has a jagged or serrated appearance, which is more conspicuous in some situations than in others. The posterior horn is directed backwards and a little outwards: it reaches the surface of the cord, and near its posterior extremity it presents a swollen or enlarged portion, which differs in colour and consistence from the rest of the crescent, being somewhat paler and softer. This portion of grey matter has been called by Rolando *substantia cinerea gelatinosa*. It is that part of the grey matter which appears to be more immediately connected with the posterior roots of the nerves.

There is an exact symmetry between the grey crescents of opposite sides, and they are united by means of the grey commissure, a layer which extends between the two crescentic portions, being attached very nearly to the central point of each. This commissure, then, when examined in its length, forms a vertical plane of grey matter, extending throughout the whole of the cord. The lateral portions are solid masses of grey matter, with which the nerve-tubes of the white substance freely intermingle, and in which, as in the grey matter elsewhere, very numerous bloodvessels ramify. There seem to be no good grounds for the opinion advanced by Mayo that these crescentic portions are hollow capsules. It was supposed by this anatomist that each crescent resembled the dentated body in the cerebellum or that in the corpus olivare; but careful examination must convince any one who takes the trouble of it that such is not the fact. It is true that the grey matter contains white fibres, but they mingle with its elements and are not enclosed within a layer of it, as described and delineated by Mayo.

When sections of the spinal cord in different regions are examined, they are found to exhibit differences of dimensions affecting both the white

and the grey matter, and remarkable varieties as regards the shape of the lateral portions of the latter. The relative proportion of the grey matter to the white appears to be much greater in the lumbar than in the cervical or dorsal regions. In the upper part of the cord the crescentic portions are narrow, and the white matter is abundant. The posterior horn appears as a thin lamella extending back to the surface, while the anterior is a small, roundish, slightly stellate mass, remote from the surface of the anterior columns. In the dorsal region the grey matter is at its minimum of development: here it appears much contracted and diminished in size, although presenting the same general form as that in the region of the neck. In the lumbar region both horns acquire a manifest increase of thickness, the posterior still extending back quite to the surface, and the anterior, more stellate than in the higher parts of the cord, separated from the corresponding surface of the cord by a much smaller quantity of white substance. At a still lower part of the cord, where the lumbar swelling begins to diminish in size, the posterior horn is short and thick, and sometimes seems not to reach quite back to the surface of the cord,—an appearance, however, which might be produced by some accidental obliquity of the section; and its posterior extremity has somewhat of the form of a hook, its hindermost portion being directed a little forwards and inwards, forming a very sharp angle with the rest of the grey substance which constitutes the horn. At the lowest part of the cord the crescentic form of the lateral portions of grey matter ceases, and the transverse section of it presents the form of a solid cylinder slightly notched on each side, and surrounded completely by the white substance. (Fig. 377.)

There are also differences deserving of notice as regards the white substance in the different regions of the cord. The largest quantity of white substance is found in the cervical enlargement, as may be shown on a transverse section. Both the antero-lateral and the posterior columns are large, but by far the greatest proportion of the mass of white substance must be assigned to the antero-lateral columns. It is also important to remark that the quantity of white substance which is placed between the posterior horns in a great part of the cervical region is augmented by the existence of two small columns of white matter, which will be more particularly described when we come to speak of the medulla oblongata. These columns extend from the inferior extremity of the fourth ventricle, very nearly as far down as the termination of the cervical enlargement, where they gradually taper to a fine point and disappear, allowing the posterior columns of the cord to come into apposition along the posterior fissure. These small columns, the *posterior pyramids* of some authors, do not appear to be completely isolated from the proper posterior columns of the cord. There is generally a very clear line of demarcation between them, visible on the posterior surface,

Fig. 377.

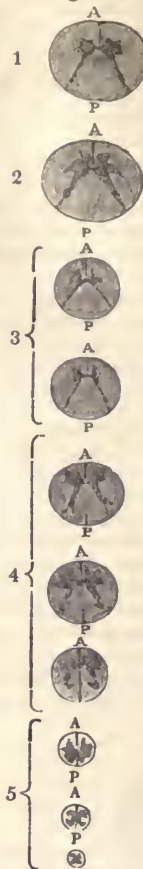

Transverse sections of the spinal cord. (After Arnold.)

- 1, cervical region at the upper part of the swelling.
 - 2, the same at the largest part of the swelling.
 - 3, dorsal region.
 - 4, lumbar region.
 - 5, pointed extremity.
- A, anterior surface.
P, posterior surface.

of the grey matter and of the posterior columns than upon the bulk of the antero-lateral ones. At the lowest point of the cord the white matter has gradually disappeared, and in the commencement of the terminal filiform process grey matter only is present, according to Remak and Valentin.

These facts lead to some interesting physiological conclusions bearing upon the function of the cord as well as of its columns. It is in the upper extremities that voluntary power and sensibility are in their most highly developed state, and accordingly the size of that portion of the cord from which the nerves of these parts emanate is greater than any other portion of the cord. Were the sensibility dependent on the grey matter or upon the posterior columns, as has been conjectured, it

by a distinct depression or fissure which passes in the length of the cord; but this fissure does not extend much deeper than the surface, nor does any distinct process of pia mater sink into it. Nevertheless, in the spinal cord, which has been hardened in alcohol or by any other chemical reagent, these columns will readily separate by tearing in the longitudinal direction, both from each other and from the posterior columns between which they are placed. They occupy rather less than one-half of the interval between the posterior roots of the nerves, excepting at their lowest part, where, from their tapering form, they obviously take up much less space.

In the dorsal region both white and grey matter are small in quantity; the posterior columns, however, do not appear to experience a diminution in size at all commensurate with the general shrinking of the organ in this region, nor with the reduced size of the antero-lateral columns.

In the lumbar region the antero-lateral columns are small; the grey matter is large in quantity, and the posterior columns appear to retain their size: they are, indeed, proportionally to the other parts of the cord, larger in this than in the cervical region, and the lumbar swelling appears to depend much more upon the large size of the grey matter and of the posterior columns than upon the bulk of the antero-lateral ones. At the lowest point of the cord the white matter has gradually disappeared, and in the commencement of the terminal filiform process grey matter only is present, according to Remak and Valentin.

might most legitimately be expected that a proportionate developement of these parts would exist in the cervical region. Yet a comparison of the cervical with the lumbar swelling demonstrates that the developement of both the grey matter and the posterior columns, (if not absolutely, certainly relatively to the bulk of the segment,) is inferior in the former to that in the latter, whence nerves are supplied to the inferior extremities in which sensibility is much less acute, and in which there is a much less perfect adjustment of the voluntary power to the muscular movements.

The difference of the respective sizes of the antero-lateral columns in those parts of the cord which supply the upper and lower extremities is perfectly consistent with the difference in the sensibility and voluntary power of those parts.* And as in the trunk these endowments are at their lowest point of developement, so the dorsal region of the cord is that which exhibits the antero-lateral columns of the smallest bulk.

In the lower parts of the body, which receive their supply of nerves from the lumbar swelling of the cord, there are certain peculiarities worthy of the attention of the physiologist. Thus the sphincter muscles of both the bladder and rectum are to a great degree independent of voluntary influence, and act independently of consciousness. The principal function of the lower extremities is that of locomotion; they are the pillars of support to the trunk, and the chief agents in the maintenance of its attitudes. And, although in these actions the will exercises a not inconsiderable control, still the principle of purely physical nervous action renders them in a great degree independent of the mind.† The reflex or excito-motory actions are much more evident in the lower than in the upper extremities; the former are much more independent of cerebral lesion than the latter. And let it be remarked that these phenomena are associated with high developement of grey matter, and with posterior columns of large size, while the antero-lateral columns are comparatively small. May not the high developement of the grey matter have reference to the exalted state of the physical nervous actions of the lower part of the body, and that of the posterior columns to the locomotive actions? To these points we shall have again to refer when we discuss the functions of the spinal cord.

Is there a central canal in the spinal cord? Many anatomists have affirmed that the spinal cord was traversed in its entire length by a canal, which was continuous with the fourth ventricle. If such a canal exist, it must be extremely difficult to demonstrate, as I have never, after numberless examinations, been

* Weber's experiments sufficiently indicate that the general as well as the tactile sensibility of the lower extremities is considerably inferior to those of the upper extremities.

† See the observations at the commencement of the article, p. 589.

able to see it. In transverse sections of the spinal cord, which have been dried upon glass, there is sometimes an appearance which may be attributed to the presence of a minute canal; but I should be more disposed to ascribe it to the patulous mouth of a bloodvessel which had been divided in making the section, for it is by no means constant even in different regions of the same spinal cord. The situation which some have assigned to this supposed canal is between the grey and white commissures; but Stilling and Wallack* place it in the grey matter. It is obvious that an artificial separation of these layers, which is easily effected, and more especially while the preparation is being dried, would give rise to the appearance of a canal upon a transverse section. It may be stated, further, that the deepest part of the longitudinal fissure is wider than any other portion of it, and, if cut across, might appear like a canal.

The observations of Tiedemann appear to me to put this question in its true light. I shall, therefore, make the following quotation from his learned work on the anatomy of the fetal brain, without, however, subscribing to the accuracy of all the statements it contains.

"The spinal marrow," says Tiedemann, "represents a hollow cylinder, the thin walls of which are bent backwards, the posterior part representing a longitudinal opening; for it is hollowed by a groove, termed *the canal of the spinal marrow*. This canal exists through the whole cylinder, and communicates with the calamus scriptorius, with the fourth ventricle, which, strictly speaking, is but a dilatation of it. During the first periods we can, without difficulty, separate the thin and flexed walls of the spinal marrow, and thus expose the canal which they contain. This canal is somewhat broader in those points where the spinal marrow sensibly enlarges exteriorly, as at the origin of the nerves for the pectoral and abdominal extremities. The mechanism of its formation is very simple: the pia mater, acquiring more extent, is folded longitudinally backwards and dips into the substance of the spinal marrow, which, as we have seen, had been previously in a fluid state. It is very evident that, in the commencement of the second, third, and even fourth months, this canal has, in proportion to the thickness of the walls of the spinal marrow, a much greater capacity than it subsequently acquires. The contraction which it undergoes in the progress of the developement of the embryo, arises from the pia mater depositing a new substance, the materials of which it derives from the blood sent by the heart, and which, augmenting the volume of the walls of the cylinder, ought necessarily to diminish the calibre of the central canal. This substance is soft, reddish, and traversed by numerous small vessels during the period of the last two months. We cannot doubt, then, that the grey substance of the spinal marrow has an origin subsequent to that of the medullary

* Untersuchungen über die Textur des Rückenmarks. Leipz. 1842.

fibrous substance, and that it is applied from within outwards on the surface of this latter. Consequently, the opinion of M. Gall, that it is formed prior to the medullary, and is, as it were, the matrix, is absolutely false with regard to the spinal marrow, for we already perceive the roots of the spinal nerves, in the second and third months, although at this period there is no cortical yet deposited in its canal."

"It is very remarkable that the canal of the spinal marrow exists constantly and during the entire life of the animal, in fishes, reptiles, and birds. I have met it in a great number of fishes, both of salt and fresh water, such as the ray (*Raia*), shark (*Squalus*), bream (*Cyprinus brama*), bandfish (*Cepolo*), pike (*Esox*), salmon, carp, &c.; and I have always found its internal surface covered with a layer of grey substance. The observations of M. Arsaky agree perfectly with mine in this respect."

"I have observed the same canal, in question, in the hawk's-bill tortoise, common tortoise, a young crocodile of the Nile, wall lizard, ringed snake, land salamander, green frog, and the common toad. In front it is continuous with the fourth ventricle, or rather it dilates to give origin to this cavity, and its interior was covered with a thin layer of cortical substance."

"Birds possess this canal both in their embryo state and in adult age. In these it forms, at its inferior part, a remarkable excavation, which Steno, Perault, Jacobæus, and some other authors have described under the name of the rhomboidal sinus. In birds, also, the grey substance occupies the interior, and is no where in greater abundance than on the walls of this sinus."

"The canal equally exists in the spinal marrow of the fetus of mammiferous animals, as also in the young animals of this class (?) F. Meckel has found it in the embryo of the rabbit; † and G. Sewell in young animals of the genus dog, sheep, ox, and horse. ‡ This latter writer observes that it was filled with a colourless fluid, nearly opaque, and of the same nature as that which existed in the ventricles. F. Meckel has even met a small canal full of fluid in the spinal marrow of some of the adult mammiferous class, such as the dog, cat, rabbit, sheep, and ox. Blaes has met it also in many adult mammiferous animals.

"Although we cannot find this canal in the spinal marrow of the human adult in its normal state of developement, still it has undoubtedly been met with; we should, then, consider it as the result of a retardation in its developement. Charles Stephen § was the first who gave a description of it; and Colombo, || Pic-

colliomini,* Bauhin, † Malpighi, ‡ Lyser, § Golles, || Morgagni, ¶ Haller, ** and M. Portal, †† have since observed it. Many of these writers have even considered it as a constant and normal disposition; an hypothesis which Varoli, Monro, Sabatier, and some other anatomists have justly opposed. Nymman proceeded even still further, for he spoke of two canals prolonged into the spinal marrow. Gall pretends to have found in the spinal marrow of new-born infants, in infants of a certain age, and even in certain adults, two canals free from all communication with the fourth ventricle, but which extended through the pons Varolii, the tubercula quadrigemina and the medulla oblongata into the interior of the optic thalami, where they formed a cavity sufficient to lodge an almond! These two supposed canals, with their termination in the optic thalami, do not exist; we must suppose that they are produced by a forced insufflation: I have never met them either in the adult or in the fetus; nor do we find them in animals in which the canal of the spinal marrow always communicates with the fourth ventricle, by means of the calamus scriptorius." ††

We shall notice further on the recent statement of Stilling and Wallack on this subject.

Bloodvessels of the spinal cord.—The arteries of the spinal cord are derived from the vertebral arteries as well as from the small vessels which ramify upon the spinal column in the cervical, dorsal, and lumbar regions.

Of these the largest and most important are the two spinal arteries which spring from the vertebral on each side, distinguished as the *anterior* and *posterior* spinal arteries.

The *anterior* spinal artery is the larger of the two. It arises from the vertebral artery near to the basilar: sometimes it comes from the basilar itself, or from the inferior cerebellar; and sometimes the arteries of opposite sides have different origins, one arising from the vertebral and the other from the basilar. It passes nearly vertically downwards, inclining inwards, in front of the medulla oblongata, and having passed for a short distance in front of the cord, it unites at an acute angle with its fellow of the opposite side, forming a single vessel, which passes down in front of the anterior median fissure, under cover of the band of white fibrous tissue which is found along the middle of the anterior surface of the cord. The artery thus formed is called the *anterior median artery* of the spinal cord.

"The anterior or median spinal artery," says Cruveilhier, "therefore, results from the anas-

* Anatom. Prælectiones, Rom. 1586.

† Theatrum Anatomicum. Francf. 1605.

‡ De cerebro, in his Opera Minora, t. ii. p. 119.

§ Culter Anatomicus. Copenhag. 1653.

|| Abrégé de l'économie du grand et petit monde. 1670.

¶ Adversar. Anatom. Aunimadv. xiv.

** Elem. Physiologie. t. iv.

†† Observ. sur un spina bifida et sur le canal de la moëlle epiniere; dans Mém. de l'Acad. des Sc. 1770.

‡‡ Dr. Bennett's translation of Tiedemann's Anatomy of the Fœtal Brain, pp. 124 et seq.

* Diss. de piscium cerebro et medulla spinali. Halle, 1813, p. 9.

† Beiträge zur Vergleichend: Anatomie, cap. ii. No. i. p. 32.

‡ Phil. Trans. for 1809.

§ De dissectione partium corporis humani, lib. iii. Par. 1545.

De re anatomicâ, Ven. 1559.

tomoses of the two anterior spinal branches of the vertebral. In one case there was no artery on the left side, but the right was twice as large as usual. The vessel is of considerable size until it has passed below the cervical enlargement of the cord, from which point down nearly to the lumbar enlargement it becomes exceedingly delicate; a little above the last-named enlargement it suddenly increases in size, again gradually diminishes as it approaches the lower end of the spinal cord, and becoming capillary is prolonged down to the sacrum, together with the fibrous string in which the spinal cord terminates."

"During its course this artery receives lateral branches from the ascending cervical and the vertebral in the neck, and from the spinal branches of the intercostal and lumbar arteries in the back and loins. Those branches penetrate the fibrous canal formed by the dura mater around each of the spinal nerves; become applied to the nervous ganglia to which they supply branches, yet intermixed with and follow the course of the corresponding nerves; send small twigs backwards to the posterior spinal arteries, and terminate in the anterior spinal trunk at variable angles, similar to those at which the nerves are attached to the cord."*

The posterior spinal arteries arise from the vertebral or from the inferior cerebellar artery; they incline backwards to the posterior surface of the spinal marrow, along which they descend in a tortuous manner, anastomosing freely with each other and with the small arteries which accompany the nerves in the intercostal foramina. A network of vessels surrounds each posterior root of a spinal nerve, derived from ramifications of those arteries. We can trace the posterior spinal arteries as low down as the lumbar region, distinct throughout their entire course.

Veins.—The blood is returned from the spinal cord by a venous plexus which emerges from the pia mater and is spread over its whole surface: opposite the roots of each nerve a small vein is formed, which passes outwards with the nerve in the same sheath, and empties itself into the large vein which is situate in the intervertebral foramen. Veins accompany the anterior and posterior spinal arteries in the upper part of their course. Branches from this plexus frequently pass to the dura mater involved in a fold of arachnoid, and thus communicate with the general plexus which surrounds the sheath.

We observe that the arteries of the spinal cord are reduced to a very minute size before they penetrate the substance of that organ. The largest vessels are therefore found on its surface or in its fissures. And it may be further remarked that when vessels of a size to be readily detected by the naked eye penetrate the substance, numerous foramina, produced by the separation of the nervous fibres, become distinctly visible. This is very obvious in the white commissure.

The purpose of such a minute subdivision of

bloodvessels, prior to their entrance into the substance of the cord, must evidently be to guard the nervous substance against the impulse of several columns of blood of large size. A similar provision, made in a more conspicuous manner, is manifest in the brain, and will be noticed by-and-by.

Of the spinal nerves.—There is a pair of spinal nerves for each intercostal foramen, and for that between the atlas and occiput. We can thus enumerate in all thirty-one pair of nerves having their origin from the spinal cord, and this number is exclusive of the spinal accessory nerve which is connected with the upper part of the cervical region.

The spinal nerves have the following very constant characters. Each has its origin by two roots, of which the anterior is distinctly inferior in size to the posterior. The ligamentum denticulatum is placed between these roots. Each root passes out through a distinct opening in the dura mater. Immediately after its emergence a ganglion is formed on each posterior root, and the anterior root lies embedded in the anterior surface of the ganglion and involved in the same sheath (fig 378), but without mingling its fibres with those of the ganglion. Beyond it,

Fig. 378.

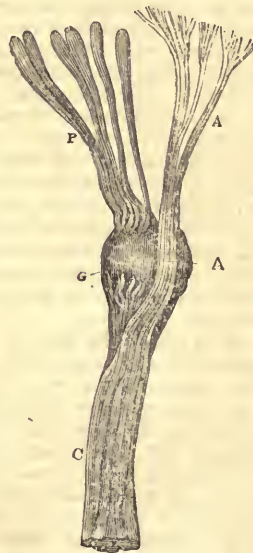

Origin of a spinal nerve. (After Bell.)

- A, A, anterior root.
- P, posterior ditto.
- G, ganglion on the posterior root.
- C, compound nerve resulting from the commingling of the fibres of both roots.

the nervous fibres of both roots intermingle, and a compound spinal nerve results. The trunk thus formed passes immediately through the intervertebral tube and divides into an anterior and posterior branch, which are distributed to the muscles and integument of the

* Cruveilhier, Anat. Descr.

trunk and the extremities. Of these branches the anterior one is generally much the larger.

An exception, however, to this arrangement occurs in the case of the first spinal nerve (the tenth pair of Willis), to which Winslow gave the appropriate name *sub-occipital nerve*, to indicate its peculiarity of character. This nerve sometimes has only one root, and that corresponds to the anterior. More generally it has two roots, of which, unlike the other spinal nerves, the anterior is the larger, containing, according to Asch, from three to five or seven bundles of filaments, whilst the posterior contains two or three, or at most four much smaller bundles. Very frequently the posterior filaments of either the right or left side unite with the spinal accessory, a slight enlargement or knot being formed at the point of junction; from this place a bundle of filaments emerges equal in size to the posterior root, and takes the ordinary course of that root, a small ganglion being formed upon it at the usual situation. Frequently, however, this ganglion is wanting. The compound nerve formed from the junction of these two roots, besides giving off communicating filaments to the sympathetic, divides as the other spinal nerves do into an anterior and posterior root, of which, however, contrary to the usual arrangement, the posterior is the larger.

The spinal nerves are arranged naturally into classes according to the regions of the spine in which they take their rise. We number eight in the cervical region, the sub-occipital included; twelve in the dorsal region; five in the lumbar, and six in the sacral regions. All the nerves, after the second, pass obliquely outwards and downwards from their emergence from the spinal cord to their exit from the vertebral canal, and this obliquity gradually increases from the higher to the lowest nerves. The roots of the nerves possess certain characters, of which some are common to all, and others are peculiar to the nerves of particular regions.

All the spinal nerves arise from the cord by separate fasciculi of filaments, which, as they approach the dura mater, converge to each other and are united together to constitute the anterior or the posterior roots. The posterior roots of opposite sides lie at a pretty uniform interval, from the upper to the lower part of the cord, indicating but a very trifling change in the thickness of the posterior column throughout their entire course. The ganglia on the posterior roots are all proportionate to the size of their respective roots.

The characters proper to the nerves of particular regions may be stated as follows:*

The *cervical nerves* exhibit much less obliquity of their roots than the other vertebral nerves. The second cervical nerve is transverse (the first passing a little upwards as well as outwards); the succeeding nerves slope downwards and outwards, the lowest being

the most oblique; the obliquity, however, never exceeds the depth of a single vertebra.

The roots of the nerves in the cervical region are of considerable size. The posterior roots bear a larger proportion to the anterior than in any other part of the spine. According to Cruveilhier, the ratio is as 3 to 1, and this estimate is probably correct. It applies not only to the entire root, but to the fasciculi of filaments which enter into their formation.

The nerves in this region increase rapidly from the first to the fifth, and then maintain nearly the same size to the eighth.

The *dorsal nerves*, with the exception of the first, which closely resembles a cervical nerve, have very peculiar characters.

There is a manifest increase in the obliquity of the roots, so that the length of each root within the spinal canal equals the height of at least two vertebrae. And it may be remarked that the apparent obliquity is less than the real, for each root remains in contact with the cord for a short distance after its actual emergence from the substance of it, so that the point of separation is some way below the point of emergence.

The interval between the roots is greater in the dorsal region than any other segment of the cord. The bundles, which compose the roots, are smaller than elsewhere.

We observe a very slight disproportion between the anterior and posterior roots in the dorsal region. The latter, however, still maintain predominance of size.

Lumbar region.—From the dorsal region to its terminal extremity the surface of the spinal cord is covered both on its anterior and posterior aspects by the fasciculi of origin of the lumbar and sacral nerves. They emerge very close to each other upon those surfaces, and the intervals between the sets of fascicles proper to each root are extremely short, so that they form an uninterrupted series of bundles on each surface.

The proportion of the posterior to the anterior roots in the lumbar region is as 2 to 1 according to Cruveilhier, or as $1\frac{1}{2}$ to 1, which seems to me to be nearer the truth. And there does not appear to be any material difference in point of size between the posterior and anterior fascicles.*

A very interesting feature in the origin of the lumbar and sacral nerves may be seen by observing the relation to each other of the anterior and posterior roots of opposite sides on the respective surfaces of the cord. The anterior roots of opposite sides may be seen to approximate the median line gradually as they descend, until at the lowest points they almost touch. On the contrary, the posterior roots continue nearly in the same sequence all the way down. It may, therefore, be supposed that in the tapering of the cord the anterior

* In the succeeding statements I have followed Cruveilhier's description, which I have verified, excepting in a few points which are specified.

* M. Blandin assigns the following proportions of the posterior to the anterior roots in the several regions; in the cervical region as 2 : 1; in the dorsal region as 1 : 1; and in the lumbar and sacral regions as $1\frac{1}{2}$: 1.

fibres of the antero-lateral columns separate most quickly from it.

The direction of these roots is almost vertical, and their length within the canal of the dura mater is very considerable. The aggregate of them forms the *cauda equina*.

I have not observed that the situation in which the ganglia of the sacral nerves are formed is different from others. They are contained, as elsewhere, in sheaths of dura mater, and lie in the sacral foramina, surrounded by fat, and from the looseness of their connection with the walls of those foramina they may be very easily detached.

I cannot confirm Cruveilhier's statement that the anterior and posterior roots in the sacral region together form the ganglia.

The roots of the sacral nerves gradually diminish in size, so that the lowest are smaller than any others which emerge from the spinal cord.

In connecting the peculiar anatomical characters of the spinal nerves in the various regions with their physiological action, some interesting points are presented to our notice.

The great size of the cervical nerves is quite in conformity with the exalted vital actions of the upper extremities. And the predominance of the posterior over the anterior roots, both positive, and as compared with other regions, corresponds with the great development of sensation in the upper limbs.

The posterior root of the second cervical nerve, as has been noticed by Longet, is considerably larger than the anterior, as 3 : 1; and it is from this source that the occipital and mastoid nerves, the sensitive nerves of the integument in the occipital region, derive their filaments.

In the dorsal region the almost equality of the anterior and posterior roots and the small size of both is consistent with the absence of any great degree of development either of the sensitive or motor power. Or if, as there is some reason for believing, many of the movements in that segment of the body which is supplied from this region of the cord be of the excito-motory kind, then we might suppose that each posterior root contains an excitor filament for each motor one in the anterior root; and if the sensitive fibres are superadded to the former (allowance being made for the smaller size of sensitive fibres,) the slight predominance of the posterior root may be accounted for.

Lastly, the increased muscular activity of the lower extremities and their greater sensibility as compared with the dorsal segment, renders necessary the increase of size which the roots of the lumbar and sacral nerves experience. And it may be conjectured that the predominance of the posterior roots has reference to the exalted sensibility of some parts of the lower limbs.

One of the most important problems in the anatomy of the spinal cord is to determine the precise relation which the roots of the nerves bear to the columns of the cord and to the grey matter. As far as coarse dissection enables me to determine, I would venture to make the fol-

lowing statement, founded upon my own observations.

The anterior roots derive their fibres wholly from the antero-lateral columns. Of these fibres it is probable that some are continuous with the longitudinal fibres of the cord, and that others pass into the grey matter. This, however, is very difficult, if it be possible, of demonstration by the ordinary modes of dissection. The posterior roots adhere to the posterior part of the antero-lateral columns, and derive their fibres chiefly from that source. I have never, in numerous dissections, seen any thing to induce me to believe that the posterior columns contribute to the formation of the posterior roots. If they do, it must be by few and extremely delicate fibres. It seems highly probable (although the demonstration of the fact is attended with great difficulty) that the fibres of the posterior roots have a similar disposition to that described for the anterior, and that some pass into the posterior horn of the grey matter, and others are continuous with the longitudinal fibres.

Various conflicting statements have been made by the anatomists who have written upon the spinal cord, with regard to the actual connection of the roots of the nerves with the proper substance of the organ. Nor is this to be wondered at, when we consider the great delicacy of the investigation. It is very easy to trace any set of filaments to the pia mater; but after they have passed beyond that covering, the nervous fibres lose their main support and their bond of union, and they separate from each other. Their exquisite delicacy and microscopic size render any further dissection of them extremely difficult. Mr. Grainger, in his excellent treatise on the spinal cord,* recommends certain precautions which I have adopted with advantage. The cord should be examined *immediately after death*, as the delay even of a few hours increases the softness of the medullary substance. Great advantage is derived from placing the cord, immediately after its removal, in a very weak mixture of alcohol and water, as by these means firmness is given to the parts without rendering them crisp and brittle, as happens if strong alcohol be used. The parts should be dissected with very fine instruments under water. "I have met with most success," says Mr. Grainger, "by dividing the pia mater at the median fissure, and very cautiously raising it as far as the lateral furrow, leaving its connection with the fibres of the nerves intact; it is then necessary to open either the anterior or posterior lateral fissure according to the root examined, at a little distance above the exact place where the nerve which is to be dissected is attached to the cord, when by cautiously proceeding to open the fissure, the threads which dip into the grey matter are perceived." Mr. Grainger recommends the adoption of a similar mode of dissection for the cranial nerves, care being taken in every case not to disturb the connec-

* Observations on the Structure and Functions of the Spinal Cord, p. 37. Lond. 1837.

tion of the pia mater with the nervous fibres themselves. He also very properly cautions the dissector against a deceptive appearance connected with the passage of those blood-vessels which enter the lateral fissure, in order to reach the internal grey substance. "Without due precaution," he adds, "these vascular branches may themselves be readily mistaken for nervous fibrils; but they are especially liable to be productive of error, because, when they are made tense, they cause those portions of the longitudinal fibres of the cord, which are left between them to assume exactly the appearance of flat transverse fibres; this circumstance probably misled Gall, and induced him to suppose that all the fibres of the spinal nerves were connected with the grey substance."

The following is Mr. Grainger's account of the result of his examinations conducted with the precautions above specified.

"After repeated examinations, I satisfied myself that each root was connected both with the external fibrous part of the cord and the internal grey substance. The following is what appears to be the structure: after the two roots have perforated the theca vertebralis, and so reached the surface of the cord, it is well known that their fibres begin to separate from each other; of these fibres, some are lost in the white substance, whilst others, entering more deeply into the lateral furrows, are found to continue their course, nearly at a right angle with the spinal cord itself, as far as the grey substance in which they are lost. But this arrangement has no resemblance to the distinct division into fasciculi, depicted by Mr. Mayo; on the contrary, it is with great care only that small, delicate, individual threads or striæ, as it were, are traced, dipping into the lateral fissure, and at length joining the grey matter. This difficulty is owing to the fact that whilst the fibres on the outer surface of the pia mater adhere very intimately with that strong membrane, on its inner surface, the membrane becomes so extremely delicate, that the fibres lose much of their firmness, and break on the application of the least force; an accident which always happens if the pia mater be raised from the surface of the spinal cord, beyond the point where the nerves are attached. When the filaments have penetrated into the fissure, they lose their rounded figure and become flattened, and are then seen passing to the grey substance at a right angle to the longitudinal fibres. It is extremely difficult, owing to the delicacy of the parts, to determine the exact relations which exist between the above filaments and the grey matter; but in a few dissections I have been able to perceive these fibrils running like delicate striæ in the grey substance. In one instance the fibres, being more distinct than usual, an appearance was presented having a remarkable resemblance to that which is seen on making a section of the corpus striatum in a recent brain, after the method of Spurzheim. My friend and colleague, Mr. Cooper, in this case counted distinctly five separate fibrils passing from the

anterior root of one nerve, and there were some other fibres derived from the same root, which were not so plainly seen."

"From numerous examinations," continues Mr. Grainger, "I am induced to believe that whenever the white fibres of the nervous system become connected with the grey substance, whether in the different masses of the brain, in the spinal cord, or in the ganglions, the arrangement is similar to what is seen in the section of the corpus striatum to which reference has just been made. The fibres become as it were encrusted with the grey matter, a disposition which may even be seen by a careful inspection in the convolutions of the cerebrum, in which the radiating fibres of the crus cerebri are observed like delicate striæ."

I have repeated the dissections of the roots of the nerves in the manner described by Mr. Grainger, and am enabled to confirm his general results. It appeared to me, however, that considerably the greater number of the fibres passed in at right angles, whilst those which might be supposed to take an upward course were few and indistinct, and seemed rather to pass obliquely inwards and slightly upwards than to approach the vertical direction. In short, when the fibres had penetrated the medullary substance, they seemed to diverge from one another,—those which occupied a central position preserving much more of parallelism than either the upper or the lower ones. It is extremely difficult to demonstrate the direct continuity between the fibres of the nervous roots and those of the cord. Valentin has, indeed, depicted the transition of nerve fibres into the spinal cord (see fig. 330, p. 592) as seen by the microscope; but these may be passing to the grey matter of the cord. The continuity of the fibres of the nerves with the longitudinal fibres of the cord would probably take place at the surface of the latter in greater numbers than at more deeply-seated planes. In the dissections above described, such fibres would be very apt to be destroyed or to be overlooked. Mr. Grainger, in the work before referred to, speaks evidently with much greater confidence of the connexion of the roots of the nerves with the grey matter than of their continuity with the longitudinal fibres. He expresses his conviction, however, that such a continuity does exist, although the exact mode of connexion and the situation at which it occurs cannot be demonstrated.

This question, respecting the precise relation of the roots of the nerves to the cord, is one of those in which physiology in a certain sense takes the lead of anatomy. Experiment has made it certain that while the spinal cord serves as a propagator of nervous power to and from the brain, as in the ordinary sensations and voluntary movements of the trunk and extremities, it is likewise capable of acting as an independent nervous centre, and that movements of a very definite character may be produced in parts connected with it, even after all communication between it and the brain has been cut off. And it has been supposed by one of the most zealous labourers in this depart-

ment of physiology, that a distinct series of nervous fibres is directed to each class of actions, those, namely, of sensation and volition, and those which are independent of the brain. Mr. Grainger was the first who offered a distinct solution to the anatomical problem which arose out of this hypothesis. Probable as his explanation appears to be, a candid review of the observations which have been hitherto made obliges me to state my opinion that the question is still *sub judice*, and that further research is necessary to prove unequivocally that of the fibres composing the roots of the nerves, some pass upwards and enter the brain, and others do not pass beyond the grey matter of the spinal cord. And this inquiry demands more than ordinary care, for the mind of an observer would be easily biased by so attractive an hypothesis as that above referred to.

It is not from physiological experiment nor from coarse dissections that we can expect a

solution of this difficult but most important problem. We must look to the microscopical analysis of the anatomical elements of the spinal cord, as well as of the encephalon, for the most exact results upon all questions connected with the working of these centres. In a subsequent part of the article I shall give an account of the present state of our knowledge of this most interesting subject, having first examined the coarser anatomy of the several parts of the encephalon.

2. OF THE ENCEPHALON. Gr. *εγκεφαλον* or *εγκεφαλος* (*εν τη κεφαλη*); Fr. *l'Encephale*, *le cerveau*; Germ. *das Gehirn*; *The Brain*.—This term is used here in its strictly etymological sense to denote that part of the cerebro-spinal centre which is contained within the cavity of the cranium. Although it forms a great mass, continuous throughout, it offers certain very obvious subdivisions, which may be more conveniently described separately (*fig. 379*). Be-

Fig. 379.

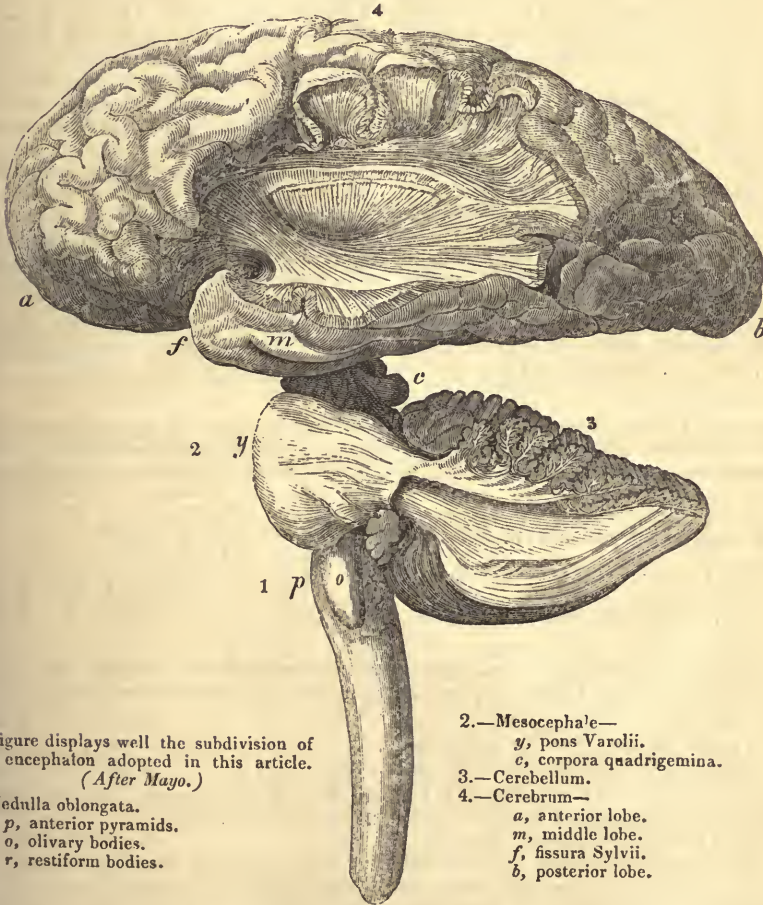

This figure displays well the subdivision of the encephalon adopted in this article. (*After Mayo.*)

- 1.—Medulla oblongata.
p, anterior pyramids.
o, olivary bodies.
r, restiform bodies.

- 2.—Mesocephale—
y, pons Varolii.
e, corpora quadrigemina.
 3.—Cerebellum.
 4.—Cerebrum—
a, anterior lobe.
m, middle lobe.
f, fissura Sylvii.
b, posterior lobe.

fore proceeding, however, to the description of these portions, it will be necessary to take a brief review of some general points connected with the entire encephalic mass.

The size of the encephalon by no means

keeps pace with that of the body. In comparing that of the four classes of vertebrate animals, we observe a manifest increase of its size as compared with the body in the following order, fishes (minimum), reptiles, birds,

mammalia.* This statement, although applicable to the encephalic mass when viewed as a whole, does not apply to certain of its parts, which are often more developed in the less perfect than in the more highly organized animals. The cerebrum and cerebellum, however, exhibit this gradual increase of development, and their enlargement is in accordance with a gradually increasing manifestation of mental faculties. And it is upon the great size of these parts that the superiority of the human brain over that of all other animals depends.

In comparing the brains of some of the larger mammalia with that of man, we observe an evident want of correspondence between the bulk of the encephalic nerves and that of the encephalon itself. This does not accord with what we have had occasion to notice respecting the spinal cord, in which large nerves were always concomitant with high development of the organ itself. The maximum weight, as Müller remarks, of a horse's brain is, according to Soemmering, 1 lb. 7 oz.; the minimum of an adult human brain 2 lb. 5½ oz.; and, nevertheless, the nerves at the base of the brain are ten times thicker in the horse than in the human subject.

This want of correspondence between the development of the mass of the body and that of the brain, as well as between the size of that organ and of the encephalic nerves, must surely be admitted to indicate an incorrectness in the assertion of the distinguished physiologist who has just been quoted, namely, that "all the primitive fibres of the nerves terminate in the brain; those of the cerebral nerves immediately, those of the spinal nerves through the medium of the spinal cord."† The human brain must evidently contain numerous other fibres besides those which are continuous with the roots of

the nerves, and it is likely that the horse's brain contains similar ones, although less numerous; it seems, therefore, impossible that the small brain of the horse can be the point of convergence of the large spinal and cerebral nerves of that animal; and if this be true as regards the horse, it is so likewise in man. It is much more probable that a large proportion of them do not extend beyond the spinal cord, and that the greater number of the fibres of the encephalic nerves do not go beyond the part in which they are immediately implanted.

It must be admitted, however, that although this disproportion is very manifest as regards the whole encephalon, it is not so evident when we compare the nerves with those segments of the organ from which they immediately arise. Thus, the medulla oblongata is always, as regards mere bulk, in the direct ratio of its nerves; the optic lobes are large when the optic nerves are so; the olfactory lobes bear a close relation to the number of the olfactory nerves, and it may be added, to the complication of the olfactory organ. It is to the cerebral hemispheres, to the cerebellum and the systems of fibres immediately connected with them that we must attribute the disproportion in question: those parts being small when the nerves are large, as in the horse, and large when the nerves are of small size, as in man.

The human encephalon weighs about 48 oz. for the male, and 44 oz. for the female.* This estimate, which was formed by Krause, does not differ very materially from that derived from Professor John Reid's careful observations made at the Royal Infirmary at Edinburgh. The following tables are extracted from a paper by this excellent anatomist in the London and Edinburgh Monthly Journal of Medical Science for April, 1843.†

TABLE I.

Average weight of the encephalon, &c. between 25 and 55 years of age, in the two sexes, and the average difference between them—Males, 53 brains weighed—Females, 34 brains weighed:—

	Male.		or	Female.		Difference in favour of Male.	
	lb. oz. dr.	lb. oz. dr.		oz. dr.	oz. dr.		
Average weight of encephalon	3 50	3½	{	2 44	8½	{	5 11
Cerebrum	43	15½		38	12		5 3½
Cerebellum	5	4		4	12½		0 7½
Cerebellum, with pons & medulla oblongata	6	3½		5	12½		0 7½ nearly

TABLE II.

Relative weight of encephalon to cerebellum, and to cerebellum with medulla oblongata and pons Varolii, between 25 and 55 years of age, in the two sexes (53 male and 34 female brains weighed).

	Male.	Female.
Relative weight of encephalon to cerebellum	as 1 to 9½	as 1 to 9½
Ditto to ditto, with pons and medulla oblongata	1 ,, 8½	1 ,, 7½

From this table it would appear that, in the female, the average cerebellum is, relative to the encephalon, a little heavier than in the male.

In a third table, which has been reduced from that published by Professor Reid, the average weight of the encephalon, cerebellum, with pons Varolii and medulla oblongata, is given over a much wider range of age than that

in the first table quoted. For this purpose 253 brains were weighed.

* According to Mr. Hamilton's investigations, the adult male brain in the Scot's head weighs, on an average, 3 lbs. 8 oz. troy; about one brain of seven is found about 4 lbs. troy; the female brain weighs 3 lbs. 4 oz.; and one of a hundred female brains weighs 4 lbs.

† Reference may also be made to an extensive series of observations on the weight of the brain by Dr. Sims, Med. Chir. Trans. vol. xix. p. 353.

* See the table at p. 623 of this volume.
 † *Physiol. transl.* by Baly, 2nd ed. p. 796.

TABLE III.
MALES.

Age. Years.	Number weighed.	Encephalon.		Cerebellum.		Cerebellum with pons & medulla ob.	
		oz.	dr.	oz.	dr.	oz.	dr.
1 to 4	5	39..	4 $\frac{2}{3}$	3..	13 $\frac{1}{2}$	4..	6 $\frac{2}{3}$
5 — 7	3	43..	10	4..	7	5..	6
7 — 10	6	46..	2 $\frac{1}{8}$	4..	10 $\frac{2}{3}$	5..	10 $\frac{1}{4}$
10 — 13	3	48..	7 $\frac{1}{2}$	4..	14	5..	12
13 — 16	5	47..	8 $\frac{2}{3}$	—	—	6..	1 $\frac{1}{2}$
16 — 20	6	52..	10	5..	4 $\frac{1}{2}$	6..	6 $\frac{1}{2}$
20 — 30	25	50..	9 $\frac{1}{2}$	5..	3 $\frac{1}{2}$	6..	2
30 — 40	23	51..	15	5..	3 $\frac{1}{2}$	6..	4 $\frac{1}{2}$
40 — 50	34	48..	13 $\frac{1}{2}$	5..	3 $\frac{1}{2}$	6..	4 $\frac{1}{4}$
50 — 60	29	50..	2	5..	5 $\frac{8}{18}$	6..	2 $\frac{2}{14}$
60 — 70	8	50..	6 $\frac{1}{2}$	5..	0	6..	2
70 & upw.	7	48..	4 $\frac{1}{2}$	4..	14	5..	14 $\frac{1}{4}$

Total male brains weighed 154.

FEMALES.

Age.	Number weighed.	Encephalon.		Cerebellum.		Cerebellum with pons & medulla ob.	
		oz.	dr.	oz.	dr.	oz.	dr.
2 to 4	6	37..	9	3..	9 $\frac{1}{2}$	4..	5
5 .. 7	3	39..	9 $\frac{1}{2}$	3..	11	4..	8 $\frac{2}{3}$
7 .. 8	3	42..	7 $\frac{1}{2}$	4..	7 $\frac{1}{2}$	5..	5 $\frac{1}{4}$
16 .. 20	8	44..	11 $\frac{1}{2}$	4..	14 $\frac{1}{8}$	5..	11
20 .. 30	18	45..	2 $\frac{3}{4}$	4..	11 $\frac{1}{8}$	5..	9 $\frac{1}{2}$
30 .. 40	23	44..	1 $\frac{1}{2}$	4..	13 $\frac{1}{2}$	5..	11
40 .. 50	18	44..	10 $\frac{1}{2}$	4..	14	5..	14 $\frac{1}{4}$
50 .. 60	5	45..	4 $\frac{1}{2}$	4..	7 $\frac{1}{2}$	5..	8 $\frac{2}{3}$
60 .. 70	11	42..	14 $\frac{1}{4}$	4..	10 $\frac{2}{17}$	5..	9
70 & upw.	2	38..	8 $\frac{1}{2}$	4..	5 $\frac{1}{2}$	5..	2 $\frac{1}{2}$

From this table we are led to conclude that the brain reaches its greatest absolute weight at an early age. The maximum is found in the table at between 16 and 20; but, as Dr. Reid states, it is plain that the apparent excess of weight at this period over that for the next forty years must have arisen from sources of fallacy incidental to insufficient data. And in the

group between 40 and 50, Dr. Reid states that some brains much below the average weight were found, so as to leave no doubt that the diminution in the average weight in that group was attributable to that circumstance.

A decided diminution in the average weight of the brain was noticed in females above 60 years of age; but, among the males, this was not apparent until a later period. Upon this point Professor Reid makes the following judicious observation, which I am anxious to quote as according with the views I have expressed at page 642 respecting liquid effusions. "We certainly did expect," he says, "also to find a similar diminution in the average weight of the male brain above 60 years of age, for we are perfectly satisfied, as the tables containing the individual facts will shew, that we more frequently meet with a greater quantity of serum under the arachnoid and in the lateral ventricles in old people than in those in the prime of life. We are also satisfied from an examination of the notes we have taken at the time the brains were examined, that a certain degree of atrophy of the convolutions of the brain over the anterior lobes, marked by the greater width of the sulci, was more common in old than in young persons. We have, however, frequently remarked these appearances in the brains of people in the prime of life who had been for some time addicted to excessive indulgence in ardent spirits."

The ratio between the weight of the body and that of the brain is greater in early age than at the subsequent periods. The following proportions were obtained by Tiedemann, in infants just born. In two boys the proportion of the brain to the body was as 1 : 5.15 and 1 : 6.63, and in two girls as 1 : 6.29 and 1 : 6.83. The following table gives Professor Reid's results from the examination of 92 bodies.

TABLE IV.

Relative weight of entire body to encephalon, cerebrum, cerebellum, cerebellum with pons Varolii and medulla oblongata, in 92 bodies.

	Ages.	Encephalon.	Number weighed.	Cerebrum.	Number weighed.	Cerebellum.	Number weighed.	Cerebellum with pons Varolii and medulla.	Number weighed.
MALES.	1 to 5 years.	1 to 8 $\frac{1}{2}$	4	1 to 9 $\frac{6}{10}$	4	1 to 88 $\frac{1}{2}$	4	1 to 76 $\frac{1}{2}$	4
	at 5 years.	1 9 $\frac{1}{10}$	2	1 10 $\frac{1}{2}$	2	1 97 $\frac{1}{2}$	2	1 81 $\frac{3}{10}$	2
	at 7 years.	1 10 $\frac{2}{11}$	2	1 11 $\frac{1}{17}$	2	1 107 $\frac{1}{2}$	2	1 93 $\frac{3}{11}$	2
	13 to 15 years.	1 15 $\frac{10}{19}$	3	1 21 $\frac{13}{19}$	3	1 142 $\frac{12}{19}$	1	1 146 $\frac{2}{19}$	1
	20 30 "	1 35 $\frac{13}{13}$	11	1 40 $\frac{27}{38}$	11	1 352 $\frac{12}{30}$	10	1 293 $\frac{2}{17}$	11
	30 40 "	1 37 $\frac{6}{11}$	6	1 41 $\frac{25}{25}$	5	1 342 $\frac{11}{11}$	5	1 306 $\frac{1}{13}$	6
	40 50 "	1 38	14	1 42 $\frac{19}{21}$	12	1 348 $\frac{1}{27}$	12	1 295 $\frac{1}{11}$	12
50 60 "	1 36 $\frac{5}{5}$	11	1 42 $\frac{1}{2}$	10	1 370 $\frac{1}{3}$	8	1 318 $\frac{1}{7}$	10	
60 70* "	1 39 $\frac{1}{5}$	4	1 44 $\frac{1}{6}$	4	1 427 $\frac{1}{3}$	4	1 348 $\frac{1}{3}$	4	
FEMALES.	2 4 "	1 8 $\frac{5}{5}$	4	1 9 $\frac{7}{10}$	4	1 84 $\frac{1}{14}$	4	1 71 $\frac{1}{12}$	4
	5 7 "
	7 10 "	1 13 $\frac{1}{3}$	3	1 15 $\frac{1}{13}$	3	1 125	3	1 105 $\frac{1}{13}$	3
	13 15 "	1 22
	16 20 "	1 30 $\frac{1}{3}$	3	1 31 $\frac{9}{12}$	3	1 283 $\frac{1}{3}$	3	1 181 $\frac{1}{3}$	3
	20 30 "	1 33 $\frac{2}{3}$	4	1 37 $\frac{2}{3}$	4	1 327 $\frac{1}{7}$	4	1 275 $\frac{1}{3}$	4
	30 40 "	1 34 $\frac{1}{3}$	8	1 39 $\frac{2}{3}$	6	1 316 $\frac{2}{3}$	5	1 285 $\frac{1}{3}$	6
	40 50 "	1 35	5	1 41 $\frac{3}{5}$	4	1 324 $\frac{6}{13}$	4	1 277 $\frac{1}{3}$	4
50 60 "	1 38 $\frac{2}{3}$	2	1 41 $\frac{3}{5}$	2	1 370 $\frac{1}{11}$	2	1 307 $\frac{2}{11}$	2	
60 and upwards.	1 38 $\frac{1}{2}$	6	1 43 $\frac{1}{2}$	6	1 346 $\frac{1}{2}$	6	1 288 $\frac{1}{10}$	6	

* One of these was above 70 years of age.

The general conclusions deducible from the preceding statements are, that the human brain reaches and maintains its highest degree of development between the ages of 20 and 60; that the female brain is materially smaller than that of the male; that the proportion of the weight of the brain to that of the body decreases with age, and the most marked diminution in this respect takes place between the ages of 20 and 30 years, although it has already begun at 5 years, and occurs very decidedly at from 13 to 15 years; and lastly, that the great preponderance of the human brain over that of most of the lower animals depends upon the great development of the cerebrum and cerebellum.

It was formerly admitted, pretty generally, that the human brain was larger, both absolutely and relatively to the size of the body, than that of any other animal. This assertion, however, must now be received with some modification. Exceptions to its superiority in absolute weight are found in the elephant and the whale. The brain of an African elephant, seventeen years old, which was dissected by Perrault, weighed 9 lbs.* The brain of an Asiatic elephant weighed, according to Allen Moulins, 10 lbs.† Sir Astley Cooper dissected an elephant's brain, which weighed 8 lbs. 1 oz. 2 grs. (avoirdupois).‡ Rudolphi found that the brain of a whale, 75 feet long, (*Balæna mysticetus*,) weighed 5 lbs. 10½ oz., and that that of a narwhal (*Monodon monoceros*,) 17 to 18 feet long, had a weight of 2 lbs. 3 oz. And there are likewise exceptions to the statement that the human brain is larger than that of other animals, relatively to the size of his body. Pozzi§ has shewn (as quoted by Tiedemann) that many small birds (for instance, the sparrow) have, in comparison to the size of their body, a larger brain than man; and Daubenton, Haller, Blumenbach, and Cuvier, found the brain of some of the smaller apes of the Rodentia, and singing birds, relatively to the size of the body, larger than in man.||

"We must seek for the cause of man's superiority," says Tiedemann, "not merely in the greater bulk of his brain in comparison to that of his body, but regard must also be had to the size of his brain with respect to the bulk and thickness of his cerebral nerves, and likewise to the degree of perfection in its structure. Soemmering was the first to show that the human brain, in comparison to the size and thickness of the nerves, is larger than that of any other animal, even the elephant and whale, both of which have an absolutely larger brain than man. Blumenbach's, Obels', Cuvier's, Treviranus', and my own researches have suffi-

ciently corroborated this. It is also satisfactorily shewn that the organization of the human brain is far superior to that of any other animal, not even excepting those apes which bear the closest resemblance to man."

The following conclusions, which Tiedemann deduces from his observations, are so important that I cannot refrain from inserting them here.*

"1. The weight of the brain of an adult male European varies between 3 lbs. 2 oz. and 4 lbs. 6 oz. The brain of men, who have distinguished themselves by their great talents is often very large. The brain of the celebrated Cuvier weighed 3 lbs. 11 oz. 4 dr. 40 grs. avoirdupois, or 4 lbs. 11 oz. 4 dr. 30 grs. troy weight. The brain of the celebrated surgeon Dupuytren weighed 4 lbs. 10 oz. troy weight. (Both of these eminent individuals, it ought to be remarked, died with the brain in a state of disease.) The brain of men, with feeble intellectual powers, is, on the contrary, often very small, particularly in congenital idiotism. The brain of an idiot, fifty years old, weighed but 1 lb. 8 oz. 4 dr., and that of another, forty years of age, weighed but 1 lb. 11 oz. 4 dr.

"2. The female brain is lighter than that of the male. It varies between 2 lbs. 8 oz. and 3 lbs. 11 oz. troy. I never found a female brain that weighed 4 lbs. The brain of a girl, an idiot, sixteen years old, weighed only 1 lb. 6 oz. 1 dr. The female brain weighs, on an average, from four to eight ounces less than that of the male; and this difference is already perceptible in a new-born child.

"3. The brain arrives, on an average, at its full size towards the seventh or eighth year. Soemmering says, erroneously, that the brain does not increase after the third year. Gall and Spurzheim, on the other hand, are of opinion that the brain continues to grow till the fourteenth year. The brothers Wenzel have shewn that the brain arrives at its full growth about the seventh year. This is confirmed by Hamilton's researches."

(The reader will perceive that these statements do not exactly accord with the results of Dr. John Reid's observations. It seems probable that the data upon which Tiedemann's conclusions were founded have been too limited in number. In calculating the weight of the brain in adolescence and adult age, some allowance should be made for the greater proportion of water at the former period; the quantities of that fluid being at those ages 72 and 74 parts in 100 respectively, according to L'Héritié.)

"4. Desmoulins is of opinion that the brain decreases in old people. From this circumstance he explains the diminution of the functions of the nervous system and intellectual powers. The truth of this assertion has not as yet been determined. The brothers Wenzel, and Hamilton deny it.

"It is remarkable that the brain of a man, eighty-two years old, was very small, and weighed but 3 lbs. 2 oz. 3 dr., and the brain of a woman, about eighty years old, weighed but

* Deser. Anatom. d'un Elephant, Mém. de l'Acad. des Sciences de Paris, t. iii.

† An anatomical account of an Elephant. Lond. 1682.

‡ Quoted in Tiedemann's paper on the Brain of the Negro. Phil. Trans. 1836.

§ Observst. Anatom. de Cerebro, an sit in homine proportione majus, quam in aliis animalibus?

|| Tiedemann's paper on the Brain of the Negro, before quoted. See also Leuret's Table, Anat. Comp. du Systeme Nerveux, t. i. p. 420.

2 lbs. 9 oz. 1 dr. I have generally found the cavity of the skull smaller in old men than in middle-aged persons. It appears to me, therefore, probable that the brain really decreases in old age, only more remarkably in some persons than in others.

"5. There is undoubtedly a very close connection between the absolute size of the brain and the intellectual powers and functions of the mind. This is evident from the remarkable smallness of the brain in cases of congenital idiotism, few much exceeding in weight the brain of a new-born child. Gall, Spurzheim, Haslam, Esquirol, and others have already observed this, which is also confirmed by my own researches. The brain of very talented men, on the other hand, is remarkable for its size.

"Anatomists differ very much as to the weight of the brain compared with the bulk and weight of the body; for the weight of the body varies so much, that it is impossible to determine accurately the proportion between it and the brain. The weight of an adult varies from 100 to 800 lbs., and changes both in health and when under the influence of disease, depending in great measure on nutrition. The weight of the brain, although different in adults, remains generally the same, unaltered by the increase or diminution of the body. Thin persons have, therefore, relative to the size of the body, a larger brain than stout people.

"From my researches I have drawn the following conclusions.

"1. The brain of a new-born child is, relative to the size of the body, the largest; the proportion is 1 : 6.

"2. The human brain is smaller, in comparison to the body, the nearer man approaches to his full growth. In the second year the proportion of the brain to the body is as 1 : 14; in the third, 1 : 18; in the fifteenth, 1 : 24. In a full-grown man, between the age of twenty and seventy years, as 1 : 35 to 45. In lean persons the proportion is often as 1 : 22 to 27; in stout persons, as 1 : 50 to 100 and more."

(This estimate, as far as regards the early ages, differs from that of Dr. John Reid, probably owing to the difference in the number weighed.)

"3. Although Aristotle has remarked that the female brain is absolutely smaller than the male, it is nevertheless not relatively smaller compared with the body; for the female body is, in general, lighter than that of the male. The female brain is for the most part even larger than the male, compared with the size of the body.

"The different degree of susceptibility and sensibility of the nervous system seems to depend on the relative size of the brain as compared with the body. (qu.?) Children and young people are more susceptible, irritable, and sensitive than adults, and have a relatively larger brain. Thin persons are more susceptible than stout. In diseases which affect the nourishment of the body, the susceptibility increases as the patients grow thinner. The susceptibility and sensibility decreases, on the other hand, with persons recovering from a

long illness, gradually as they regain their strength. The degree of sensibility in animals is also in proportion to the size of the brain. Mammalia and birds have a larger brain and are more susceptible than amphibious animals and fishes."*

Enough has been said to show, that in contrasting the brain of man and that of the lower animals, with reference to the much agitated question of the connexion of mental faculties and intellectual endowments with that organ, no one standard of comparison must be selected. We must look to absolute and relative size—we must compare the bulk of the several portions of the encephalon with each other—we must notice the size of the encephalic nerves in relation to the whole organ—and, above all, we must compare the intimate organization of brain one with the other. Unless all the features of the brains that are subjected to comparison be carefully taken into the account, erroneous conclusions will be obtained. For instance, the brain of the elephant is absolutely larger than that of man: the convolutions of the hemispheres are very highly developed, and exhibit a degree of complexity almost equal to that of the human brain. At first sight we might be led to infer a very close approximation to the human, and place the elephant very high up in the scale of cerebral development. In comparing, however, the brain of this animal with that of the monkey, the following result is obtained. The encephalon of the elephant is above that of the monkey by the superior development of the cerebral convolutions; it is equal to it, as regards the quadrageminal bodies, but from the general form of the brain, the length of its transverse diameter, the presence of olfactory eminences, the position of the cerebellum (uncovered by the posterior lobes), it must be placed on a level with that of the inferior Mammalia.†

Of the brain in different races of mankind.
—When so much diversity is observable in the form of the cranium in different races of mankind, it seems reasonable to expect a corresponding variety in the shape and other characters of the encephalon. The external form of this latter organ will correspond with that of the cranium, and its size with the capacity of that cavity. But it is plain that as the capacity of the skull is no wise necessarily affected by its shape, so the absolute bulk of the brain need not vary, although its containing case may exhibit much variety of form. The great question for the physiologist to determine is, whether, in the various races of mankind, the brain exhibits any striking peculiarities, characteristic of one or more of them, or whether it presents no more variety of shape, size, weight, and structure than may be observed in different individuals of any one of those races.

It should be premised that actual observations of the brain of different races are few. In Europe, where hitherto anatomy has chiefly

* Tiedemann on the Brain of the Negro compared with that of the European and the Orang Otang. Phil. Trans. 1836.

† Leuret, op. cit. p. 448.

been studied, the means of instituting such inquiries on a large scale have been altogether wanting. But it may be confidently expected that the many well-educated men who now visit distant climes, accompanying our fleets and armies, will not let slip the opportunities which they possess, without contributing somewhat to the solution of so interesting a question.

Many years ago it was thought that the brain of the coloured races possessed a greater quantity of colouring matter than that of the white, and this opinion appears to have originated with J. F. Meckel, who asserted that the grey substance was of a darker hue than in the European brain, and also that the medullary substance was not so white, but yellowish grey or light-brown.* Walter, Camper, Bonn, Soemmering, have, however, amply refuted this statement.

Walter denied more particularly that part of the assertion which attributed a darker colour to the white substance. He states that it is just as white as in the European, but that the cortical substance is darker, that is, of a greyish brown colour, which he attributed to the darker colour of the blood in the Negro.†

Soemmering, with a view to decide the question, dissected three perfectly fresh Negro brains in the presence of other anatomists, Professors Weichmann, Schumlanski of Petersburg, and Billman of Cassel, taking the very proper precaution to compare on the spot the fresh brain of an European. The result was that he could not discover either the cineritious or medullary substance to be in the least darker than in Europeans; he even thought that the colour was rather paler in the African than in the European brain.‡

It is true that Caldani and Rudolphi appear to have considered the grey substance darker in the Negro than in the European, the former having examined the brains of two Negroes, and the latter that of a Mulatto. But little dependence is to be placed on statements founded upon such a limited number of observations, and moreover it is well known that the aspect of the grey substance varies in different individuals according to the quantity of blood which it may contain.

Tiedemann affirms that the brain of the Negro does not present any material difference from that of other nations. Judging by Camper's rule, founded upon the measurement of the facial angle, which is smaller in the Negro than the European, it had been supposed that the latter was smaller. The results of a few cases in which the Negro brain was weighed do not confirm this statement. The brain of a Negro boy according to Soemmering weighed 2 lbs. 10 oz. 3 dr. avoirdupois, or 3 lbs. 6 oz.

* De la diversité de couleur dans la substance medullaire de Negres, Hist. de l'Acad. de Berlin, 1753. Du Cerveau des Negres, *ibid.* 1757, quoted in Tiedemann's paper.

† Epistola Anatomica ad W. Hunterum de venis oculi. Berolin. 1778.

‡ Vom Körperlichen Unterschied des Negers, p. 18.

6 dr. troy. The brain of a tall handsome Negro, about twenty years of age, weighed 2 lbs. 13 oz. 4 dr. avoirdupois, or 3 lbs. 9 oz. 4 dr. troy weight. A Negro's brain, examined by Sir Astley Cooper, weighed 3 lbs. 1 oz. or 49 oz. and that of a young Negro, aged twenty-five, short and thin, examined by Tiedemann himself, weighed 2 lbs. 3 oz. 2 dr., having been a short time kept in alcohol.

Tiedemann has also contrasted the capacity of the Negro skull with those of men of the Caucasian, Mongolian, American, and Malayan races. This was done by first weighing the skull with or without the lower jaw-bone. Then the skull was weighed, having been filled with dry millet seed through the foramen magnum. Lastly, by deducting the weight of the empty skull from that of the filled one, the capacity of the cranial cavity was obtained.

In the Ethiopian race, the range of capacity was found to be, in male skulls from 54 oz. 2 dr. 33 gr. to 31 oz. 5 dr. 16 gr. troy, in thirty-eight observations, and in female skulls from 31 oz. 4 dr. to 24 oz. 7 dr. 39 gr. in three observations.

In the Caucasian race, the capacity of male skulls of European nations was found to range between 57 oz. 3 dr. 56 gr. to 32 oz. 6 dr., in seventy-seven observations, and that of male skulls of Asiatic nations from 41 oz. 5 dr. 6 gr. to 27 oz. 6 dr. 30 gr. (a Hindoo Brahmin's head), in twenty-four observations.

The male skulls of the Mongolian race exhibited a capacity from 49 oz. 1 dr. 22 gr. to 25 oz. 0 dr. 18 gr. (a native of Nootka Sound), in eighteen observations.

In the American race the capacity of the male skulls ranged between 59 oz. and 26 oz. 1 dr. 44 gr. (a Toway Indian), in twenty-four observations.

And in the Malayan race it ranged from 49 oz. 1 dr. 45 gr. to 30 oz. 5 dr. in thirty-eight observations, and in five female skulls from 37 oz. 5 dr. to 19 oz. 2 dr. 49 gr. (a Lascar woman).

These researches certainly give no countenance to the doctrine which assigns the lowest place, in the chain of human varieties, to the Negro as regards cerebral development. So far is this from being the case, that the Ethiopian race differs to a very trifling degree from the European; and, indeed, the examples of skulls of the smallest capacity are found among Asiatic natives (Hindoos) and Americans.

The following conclusions are derived by Tiedemann from his comparison of the Negro brain with that of other races.

"1. The brain of a Negro is upon the whole quite as large as that of the European and other human races.

"2. The nerves of the Negro, relatively to the size of the brain, are not thicker than those of Europeans, as Soemmering and his followers have said.

"3. The outward form of the spinal cord, medulla oblongata, the cerebellum and cerebrum of the Negro show no important difference from that of the European.

"4. The Negro brain does not resemble that of

the orang otang more than the European brain does, except in the more symmetrical distribution of the gyri and sulci. It is not even certain that this is always the case. We cannot therefore coincide with the opinion of many naturalists, who say that the Negro has more resemblance to apes than Europeans in reference to the brain and nervous system. It is true that many ugly and degenerate Negro tribes on the coast show some similarity in their outward form and inward structure to the ape; for instance, in the greater size of the bones of the face, the projecting alveoli and teeth, the prominent cheek-bones, the recession of the chin, the flat form of the nose-bones, the projecting and strong lower jaw, the position of the foramen occipitale magnum, the relative greater length of the ossa humeri and the bones of the foramen, the flat foot, and in the length, breadth, shape, and position of the os calcis. *

* * These points certainly distinguish many Negro tribes from the Europeans, but they are not common to all the Negroes of the interior of Africa, the greater number of which are well made, and have handsome features."*

A series of researches so extensive and con-

ducted with so much care, (although the actual comparison of the brains themselves is yet wanting,) cannot allow a doubt to arise as to the conclusion which ought properly to flow from them. It would appear from them that no very marked differences exist between the brains of any of the classes of mankind—that the same relative inferiority of women to men is universally met with—and that a very diminutive state of brain may be, when not an accompaniment of idiotcy, either a part of a frame originally very small in stature, or a degenerate condition consequent upon a life of the lowest barbarism, under every possible physical impediment to the development of bodily vigour, wholly deprived of moral or intellectual culture, a state which becomes more and more degenerate in each succeeding generation, or, lastly, the effect of the mechanical compression to which many tribes subject the crania of their offspring in early infancy.

In proceeding to the examination of the human encephalon, it seems expedient to premise a few observations on the method which it is most advisable to adopt for this purpose.

Fig. 380.

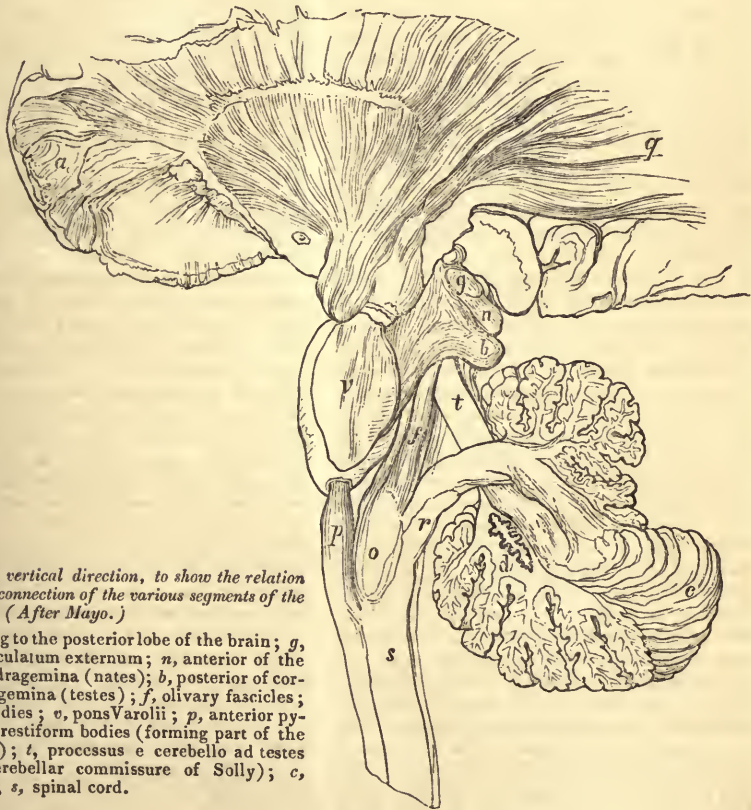

Section in the vertical direction, to show the relation and mode of connection of the various segments of the encephalon. (After Mayo.)

g, fibres passing to the posterior lobe of the brain; g, corpus geniculatum externum; n, anterior of the corpora quadragemina (nates); b, posterior of corpora quadragemina (testes); f, olivary fascicles; o, olivary bodies; v, pons Varolii; p, anterior pyramids; r, restiform bodies (forming part of the crus cerebri); t, processus e cerebello ad testes (cerebro-cerebellar commissure of Solley); c, cerebellum; s, spinal cord.

The inferior limit of the encephalon is the

* The remaining observations of Tiedemann on the intellectual condition of the Negro merit attentive perusal. See also Prichard on the Physical

plane of the occipital foramen. In examining

History of Mankind, vol. i. p. 197, and vol. ii. p. 346.

that great nervous mass which is situate above this plane, it will be obvious, even to the most superficial observer, that it admits of a convenient subdivision into certain great segments, each of which, although extensively connected with the neighbouring ones, may yet be capable of acting as an independent centre, and, in short, possesses the anatomical as well as physiological properties of a ganglion. And on a more minute investigation the number of gangliform segments will be found to be greater than the observation of the mere surface of the encephalon would lead us to conclude. The subdivision, however, which it is most convenient for the purpose of description to adopt, is that already stated at page 650, *viz.*, 1, the *medulla oblongata*, which is immediately continuous inferiorly with the spinal cord. This segment has certain characters of structure which decidedly indicate its ganglionic nature; several nerves of considerable size and of great physiological importance are implanted in it, and its external anatomy very clearly indicates its distinctness from the spinal cord inferiorly and from the other encephalic segments above, of which that next in order proceeding from below upwards, is, 2, the *mesocephale*. To this mass, so called because of its intermediate position between the other segments, the term *isthmus* has been also very appropriately applied, as it is the connecting link between all the encephalic segments. Inferior and posterior to it is placed, 3, the *cerebellum*, which has very intimate relations to the *medulla oblongata* as well as to the segment last described, but much less extensive ones to that which forms by far the largest proportion of the encephalon, namely, 4, the *cerebrum*, which therefore occupies the principal portion of the cranial cavity.

The distinction between these different segments is very obvious on an examination of the surfaces of the brain, which indeed ought to be the first step to be taken by the anatomist. To discover how they are connected to each other and to the spinal cord, how the corresponding portions on opposite sides of the mesial plane are associated together, what fibres are common to all the segments, and what peculiar to some, and, lastly, how the grey matter is related to the white,—these are the chief objects to be attained in the dissection of the brain. No one method of dissection will suffice for this purpose. The anatomist should first make himself familiar with the simple topographical anatomy of the brain, that is, with all those parts in it which possess such characters of form or structure as may entitle them to be regarded as distinct and deserving of separate description, and have obtained for them a special appellation. The form, size, general structure, and relations of these parts should be carefully noted. And this method of examination is equally applicable to the dissection of each segment of the encephalon. But the most convenient way in which it can be conducted for ordinary practical purposes, is to commence with the cerebral hemispheres, and having studied their

general structure as displayed on a horizontal section, to examine the extent and connections of the fibres which connect the right and left hemispheres with each other (the *corpus callosum*); then to open the ventricles, examine their shape and extent, and note the various particulars connected with the numerous parts which are brought into view by exposing those cavities. The dissector may next observe how certain of the parts concealed by the lateral ventricles are connected with the *mesocephale* (the optic thalami for instance), and, having been already acquainted with the various prominences which are seen upon the surface of the latter, he may by vertical, or transverse, or horizontal sections, investigate the manner in which the white matter of this segment connects itself with that of the neighbouring ones. In examining the cerebellum, the larger fissures afford sufficient indication for a convenient subdivision of the organ, and by horizontal or vertical sections at various parts of it the connexion of the grey and white matter may be displayed, and of the latter to the *mesocephale* and *medulla oblongata*. The *medulla oblongata* has upon its surface various lines or fissures which denote the proper limits of its constituent columns, and which will be sufficient guide to the dissector in tracing the extent and connexions of each. Transverse and longitudinal sections also afford useful information respecting the structure of this segment of the encephalon and the relations of its parts.

Such is the mode of dissection from above downwards, against which it has been greatly the fashion of late years to declaim with much vehemence. But, however the advocates of a particular theory may object, there can be no doubt that this method is by far the most useful for all practical purposes. It enables the anatomist, without difficulty, to study the prominent parts or landmarks (so to speak) of the brain, without a knowledge of which it is in vain to attempt any other mode of dissection. And for pathological investigations it is the only method which can be conveniently adopted. It is plain, therefore, that all who are desirous of becoming acquainted with the anatomy of this organ should begin by making dissections in this way. An additional advantage is found, in this mode of investigation, from its great applicability to the dissection of the brains of the lower animals, of the *Mammalia* and *Birds* especially, for the purpose of comparing them with the brain of the human subject.

The method of our celebrated countryman Willis was very much the same as that above described. He removed the membranes from the posterior lobes of the hemispheres, and thus separated the latter from the subjacent parts, and by raising them as far forwards as possible he was enabled to observe the connections of the cerebral hemispheres with the *mesocephale*, and the attachments of the *foramen* behind. He also must have studied the substance of the hemisphere by horizontal section. By then dividing the posterior parts of the hemispheres horizontally along the plane of the

corpora striata, he raised a large flap consisting of the upper part of the hemispheres, with the intervening corpus callosum and the adherent fornix; and thus were exposed the inferior surface of the latter, and the cavities of the three ventricles, the fourth being shewn by a vertical section of the cerebellum on the median plane, and by the separation of the segments thus made. This is an admirable section to display the connection of the hemispheres with what Willis described as the medulla oblongata, namely, in the words of his translator, "all that substance which reaches from the inmost cavity of the callous body and conjuncture in the basis of the head to the hole of the hinder part of the head, where the same substance being yet further continued ends in the spinal marrow." The fourth, seventh, and eighth plates in Willis's work display this mode of dissection.*

The modern researches of Reil, Gall and Spurzheim, and others, directed attention more particularly to the physiological anatomy of the brain. Their principal object was to discover the mode of connexion of the several segments of the cord with each other, and of the whole encephalon with the spinal cord. And their method of dissection consisted in tracing the course of the fibres chiefly from below upwards. Reil found it necessary to harden the brain in alcohol, in order to give it such firmness as would enable him to tear portions of it in the direction of its fibres, and thus to make these latter conspicuous. There can be no doubt that layers of the brain will separate most rea-

dily when torn in the direction of their fibres; and thus this mode of preparation becomes of great importance to the anatomist, as he can thereby determine easily the direction of those fibres which form the principal portion of the part under examination. It will not, however, suffice to display the direction of all the fibres, nor indeed is any mode of preparation adequate for that purpose, which can only be accomplished by extensive and patient microscopic investigation.*

The great advantage of pursuing the dissection in the direction from below upwards consists in this, that we proceed from the more simple to the more complex. The problem which the anatomist has to solve is, Given certain columns or bundles of fibres in the medulla oblongata, to determine how they connect themselves with the other segments of the brain. But it is obvious that without some knowledge of the topography of the other more complicated parts of the encephalon, the dissector would have considerable difficulty in pursuing his researches. Nor must he content himself with the solution of this fundamental question; he is to explore for other fibres in these segments besides those which connect them with the medulla oblongata, and he has to ascertain how they comport themselves, whether as forming an integrant portion of the segment in which they are found, or serving to connect it with one or more of the others.

Although we are mainly indebted to modern anatomists for following out more completely this method of dissection, it cannot be denied that such men as Willis, Vieussens, and Malpighi were quite alive to the importance of examining the fibres of the brain, with a view to the physiological action of its different parts. No one can peruse Willis's admirable account of the brain without perceiving how completely he unites structure and function, and with what

* Thomæ Willis, *Cerebri Anatomie, nervorumque descriptio et usus*, in *Opera Omnia*, Amsterdam, 1682, cap. xiii. Also an English edition by S. Portage, London, 1684. The following extract gives the description of Willis's dissection in his own words. "Ut cerebri ita proprie dicti anatomie rite celebretur, haud vulgari sectionis modo procedendum esse existimo. Verum ubi totius *εγκεφαλου* calvaria exempti compages coram sistitur, imprimis posterior cerebri limbus, ubi cerebello ac medullæ oblongatæ connectitur, membranis undique discissis aut avulsis, a cohæsione cum partibus subjectis (quantum fieri potest) liberetur; tunc facile constabit quod cerebri substantia corporibus istis haudquaquam unitur, verum per se, nisi quod membranarum nexu superficie tenus conjungitur ab iis omnino libera ac independens fuerit: quietiam hæc cerebri puppis a vicinis partibus eo ritu divisa, si anterior reclinetur, medullæ oblongatæ crura, prorsus nuda, ac a cerebro et cerebello (nisi in quibus locis hæc illi appenduntur) omnino distincta apparebunt. * * * * *

Interioris cerebri recessus adhuc clarius patebunt, si limbus ejus a medullæ oblongatæ cohæsione, quantum fieri potest, ex omni parte separatus et elevatus, ad latera ejusdem medullæ, quibus juxta corpora striata unitur, paulo ulterius per substantiam suam secetur, simulque fornix juxta radices discissus una cum cerebro reflectatur, tunc enim cerebri compages penitus elevati, antorsum reflecti, ac in planum explicari potest, ita ut corporis callosi in aream latam expansi interior superficies tota conspici et tractari possit. Ubi, præter medullarem et nitidissimam illius substantiam, observare est plures lineas albas paralelas quæ cerebri dissepimentum rectis angulis secant; quasi essent tractus quidam, sui vestigia, in quibus spiritus animales ab uno cerebri hæmispherio in alterum migrant resiliuntque." Op. cit. cap. i. p. 5, 6.

* Reil's methods of preparing the brain are best described in his own words: "Of the methods which I have employed in preparing brains, those contained in the following directions answered best. 1. Let the brain be hardened in alcohol, and then placed in a solution either of carbonated or pure alkali, in the latter two days, in the former for a longer period, and then again hardened in alcohol if thus rendered too soft. The advantage of this method is, that the fasciculi of nervous matter are more readily separable, and the brown matter more distinguishable from the white than after simple maceration in alcohol; the grey matter is rendered by the alkali of a blacker grey, and assumes the consistence of jelly. 2. Let the brain be macerated in alcohol, in which pure or carbonated potash or ammonia has been previously dissolved; the contraction of the brain is lessened by this process. 3. Let the brain be macerated in alcohol from six to eight days, and then its superficial dissection commenced, and the separation of the deeper parts continued, as the fluid, in which the brain is kept immersed, penetrates its substance. This method appears to me better than the preceding, and would very likely be improved if the alcohol were rendered alkaline. The fibres in a brain, thus prepared, are more tenacious than otherwise, and the deeper parts are sooner exposed to the influence of the alcohol."—Mayo's translation of Reil's Eighth Essay, in the former's *Anat. and Phys. Commentaries*, p. ii. p. 50.

ingenuity he ascribes the passage of the nervous force (under the name of animal spirits) from one part to another, to the anatomical relations of those parts, and the direction of the constituent fibres. And, indeed, we may find in the writings of this great man the germs of many a theory which, in our own times, has been brought forward with a more plausible aspect, disencumbered of the quaint phraseology and superabundant metaphor so common in his day. I shall quote one remarkable instance as very much in point. Speaking of the fourth pair of nerves as connected with the corpora quadragemina, he says: "Concerning these little nerves it is observed, that when (although) many others proceed from the sides or the basis of the oblong marrow, these arise from the aforesaid Prominences in the bunching forth at the top (nates and testes). The reason of which, if I be not mistaken, is this,—we have affirmed that these prominences do receive and communicate to the brain the natural instinct delivered from the heart and bowels to the cerebel; and on the other side, or back again, do transfer towards the Præcordia, by the mediation of the cerebel, the forces of the passions or affections received from the brain; but in either action the motion of the eyes is affected with a certain manifest sympathy. For if pain, want, or any other signal trouble afflicts the viscera or the præcordia, a dejected and cast-down aspect of the eyes will declare the sense of its trouble: when on the contrary, in joy, or any pleasant affection of the præcordia or viscera, the eyes are made lively and sparkle again. In like manner the eyes do so clearly show the affections of the mind, as sadness, anger, hatred, love, and other perturbations, that those who are affected, though they should dissemble, cannot hide the feeling and intimate conceptions of the mind. Without doubt these so happen because the animal spirits tending this way and that way in this deviating place between the brain and the præcordia, do at once strike those nerves as the strings of a harp. Wherefore, from this kind of conjecture, which we have made concerning the use of these nerves, we have called them *Pathetical*, although indeed other nerves may deserve the same name."^{*}

Malpighi and Vieussens were well acquainted with the fibrous structure of the brain, and appear to have had very correct notions as to the general direction which they assume, and the parts which they serve to connect to each other. The former describes the fibres of the brain and cerebellum as taking their origin from the trough of the spinal marrow contained within the cranium (*medulla oblongata*); "for they ramify from four reflected crura of this medulla in all directions, until they end by their branched extremities in the cortex." Vieussens states that the medullary substance is composed of innumerable fibrils connected together and arranged into various fasciculi, which become very obvious when it is boiled in oil.†

* English edition of Willis's Works, p. 90, fol. Lond. 1684.

† Malpighi, *Exercitatio Epistolica de Cerebro*,

The great merit of Reil, Gall and Spurzheim, and their followers in later years, consists in their having followed out with great diligence the coarser anatomy of those fibres, and determined many important and undeniable truths. But in the statements of all anatomists, who avail themselves of no other aid than that which the naked eye affords, there is much that must necessarily be uncertain or doubtful, nor is there any other mode of removing these uncertainties but by the successful application of microscopical analysis to the whole cerebral structure.

Of the surface of the encephalon—We now proceed to examine the various points worthy of notice in the superficial anatomy of the encephalon.

The shape of the brain is determined by that of the cerebral hemispheres. A line drawn around the surface of the latter, so as to enclose them, would describe an oval, the smaller extremity of which is directed forwards.

The superior and lateral surfaces of the encephalon are convex, and have a smooth appearance from the visceral layer of the arachnoid being extended over them, adhering to the subjacent pia mater. When the membranes have been removed, the convoluted character of these surfaces, previously seen through them, becomes very manifest, as will be more particularly described by-and-by. The longitudinal and transverse diameters of these surfaces correspond to those of the cranial cavity.

The superior surface is divided along the median plane into two equal and in a great degree symmetrical portions by a fissure which passes vertically between them and receives the great falciiform process of the dura mater. In front and behind, this fissure completely divides the central lobes. In the latter situation, the tentorium cerebelli is seen at the bottom of it when the hemispheres are separated, if the encephalon be in situ; if it have been removed, however, the superior surface of the cerebellum forms the floor of the fissure. In the middle the fissure is interrupted by a horizontal lamina of white fibres, which is called the *corpus callosum*, the great commissure of the cerebral hemispheres.

The inferior surface of the encephalon also, called commonly the *base of the brain*, presents many points worthy the attention of the anatomist.

It is not all upon one level: in this respect it corresponds with the disposition of the base of the skull. We find, indeed, three segments each on a different plane, and corresponding to each of the three fossæ of the cranium. This is best observed by examining a vertical section of the head, the brain being retained in this situation, or by removing the wall of the cranium on one side quite down to its inferior surface.

The anterior segment, and that which is of

1664. Vieussens, *Neurographia Universalis*, lib. cap. x. See the whole passages quoted in Dr. Gordon's *Observations on the Structure of the Brain*, Edin. 1817, p. 21.

Fig. 381.

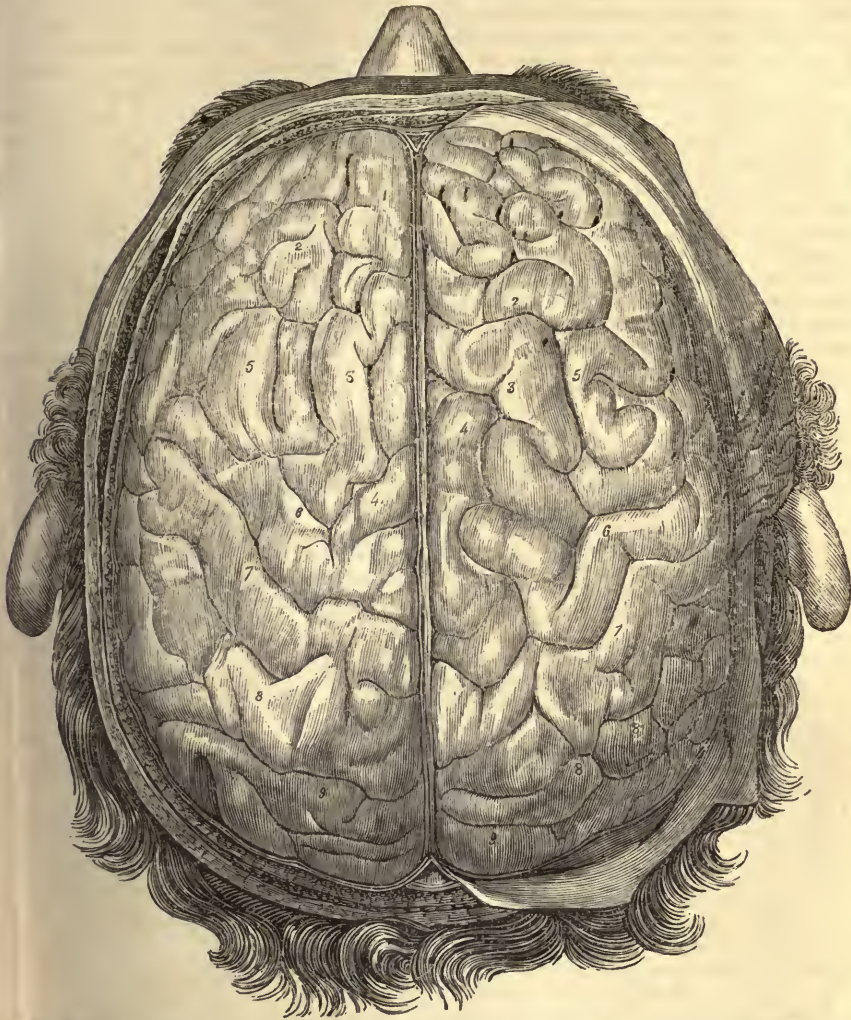

The superior and part of the lateral surfaces of the encephalon, exposed by the removal of the calvaria. The falx cerebri is seen in the longitudinal fissure. The figures on the convolutions indicate those of opposite sides which present some degree of symmetrical character. They will be referred to further on in the description of the hemispheres of the brain.

the highest level, corresponds to the anterior fossa of the cranium. It rests, therefore, upon the roofs of the orbits, and its surface is on each side slightly concave to adapt it to the form of its resting-place. The continuation of the anterior median fissure separates its right and left portion, and the attachment of the falx to the crista galli of the ethmoid makes the distinction more complete. In a distinct sulcus, parallel to and immediately on each side of the longitudinal fissure, we find the olfactory process or nerve. This segment forms the inferior surface of what anatomists commonly designate as the anterior lobes of the brain. It presents the convoluted appearance which is conspicuous on the proper cerebral surface every where. A curved fissure of considerable depth, called the

fissure of Sylvius, is the posterior limit of each anterior lobe.

The *fissure of Sylvius* corresponds on each side to the posterior concave edge of the lesser ala of the sphenoid bone, which is received into it. It may be traced from within, commencing at a triangular flat surface (*locus perforatus anticus*), which corresponds to the posterior extremity of each olfactory process. From this situation it proceeds outwards and curves backwards and a little upwards; its convexity is therefore directed forwards. Towards the lateral surface of the brain it becomes continuous with the fissures of neighbouring convolutions.

The fissure of Sylvius is of considerable depth, especially at its internal extremity, and, like all the fissures of the brain, large or small,

is lined by the pia mater. We notice here a large interval between the arachnoid and pia mater, in which a considerable accumulation of the cerebro-spinal fluid takes place, communicating with the anterior confluent of that fluid. In this space runs the middle artery of the brain, giving off its branches to the sides and floor of the fissure. When the convolutions which bound the fissure are separated, a variable number of small convolutions is found, projected from its floor as an insulated lobe, which is enclosed by a bifurcation of the fissure. This lobe constitutes the island (*insel*) of Reil.

The *middle* segment which lies immediately behind the Sylvian fissure, is on a plane much lower than the anterior, and corresponds on either side to the deep and hollow median

fossa of the cranium. It consists of two lateral very convex lobes, commonly known as the *middle lobes of the brain*, which are separated from each other by a deep depression. These lobes, which are very accurately limited in front by the fissure, have no exact boundary behind, but pass off very gradually into the *posterior lobes* of the hemispheres, as may be seen by raising up the cerebellum.

The transition from the middle to the posterior lobe of the hemisphere is only indicated by the different character of the inferior surface of the hemisphere, the former being convex, the latter concave. The subdivision, indeed, of the cerebral hemisphere into middle and posterior lobes is purely conventional, and I agree with Cruveilhier that it ought to be discarded, for it has no foundation in the anatomy

Fig. 382.

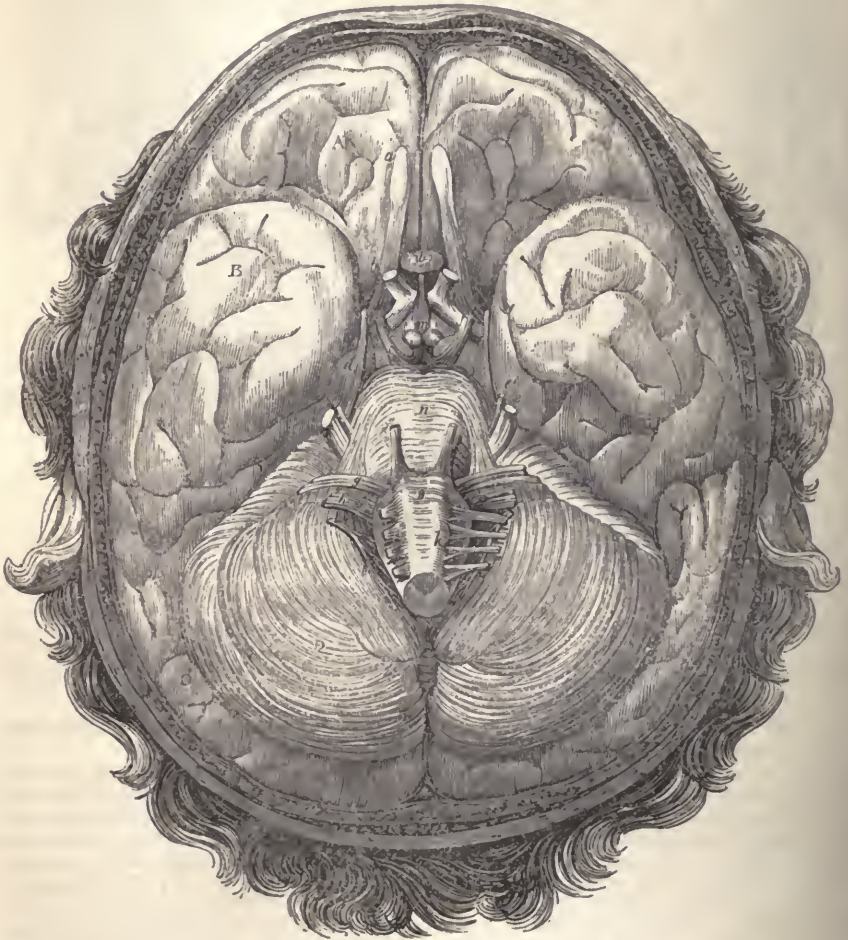

Base of encephalon viewed from below.

A, anterior lobe; B, middle lobe; C, posterior lobe; D, cerebellum; a, olfactory nerves; b, optic nerves; c, third pair of nerves; d, fourth pair of ditto; e, fifth pair—portio major; e', fifth pair—portio minor; f, sixth pair; g, seventh pair; h, filaments of origin of the glosso-pharyngeal and vagus; i, spinal accessory nerve; k, ninth nerve; l, pituitary body and process proceeding from the tuber cinereum; m, mamillary bodies; n, pons Varolii; o, medulla oblongata.

of the parts. The whole of that portion of the cerebral hemisphere which is situate behind the Sylvian fissure should be called the posterior lobe.

The hollow space between the middle lobes of the brain corresponds to the principal anterior reservoir of subarachnoid fluid. It is situate immediately above the Sella Turcica, and, indeed, the brain is, as it were, tied to the pituitary body, which is firmly lodged in this excavation of the sphenoid bone, by a funnel-shaped hollow process of nervous matter, called *pituitary process or tube*, (*m*, *l*, *fig.* 382), which, enveloped in a sheath of arachnoid membrane, is inserted into it by its small extremity. This space communicates with the anterior fissure in the middle, and with the Sylvian fissure on either side.

Commencing at the anterior fissure and passing backwards, we notice the following parts, to see which clearly it is necessary that the adherent pia mater and the arachnoid should have been previously carefully dissected away. The anterior fissure is limited by the anterior fold or reflection of the corpus callosum: behind this we find a thin layer of a lightish grey matter, which, like a triangular plate, seems to stop up the third ventricle at its inferior surface. This, indeed, which is called *tuber cinereum*, constitutes a principal part of the floor of that ventricle. The pituitary process is continuous with and is probably an extension of it. A probe introduced into the cut extremity of this process will be found to pass readily into the third ventricle.

Immediately in front of the pituitary process, the union of two white bands, which form lateral boundaries to a large portion of the tuber cinereum, the *optic tracts*, takes place along the middle line. This forms the *commissure* of the optic nerves, from which these nerves diverge. Behind the pituitary process the tuber cinereum extends back to two small pisiform bodies of an extremely white colour on their surface, *corpora mamillaria* or *albicantia* (*m*, *fig.* 382). These, we shall see by-and-bye, are connected with one of the most important of the cerebral commissures, namely, the *fornix*.

Behind the mamillary bodies we find a deep depression into which the pia mater sinks, carrying with it very numerous bloodvessels. This depression lies between two thick processes of fibrous matter, which, traced from below, pass upwards and outwards, expanding as they advance, and upon which each hemisphere is placed (to use Reil's simile) like a mushroom on its stalk. These are the *crura cerebri*, the peduncles of the cerebral hemispheres. The depression above described, which separates them, is the *intercrural* or *interpeduncular* space. When the pia mater has been removed from it, its surface appears cribriform from the perforations of the numerous minute vessels which penetrate it; it has been named by Vicq d'Azyr *substantia perforata media*. The nervous matter which forms the floor of this space has a greyish hue, and connects the crura to each other, like a bridge, whence the designation *pons Tarini*. At the interpeduncular space we see

the third pair of nerves emerging from their connexion with the crura cerebri.

The inner margin of each middle lobe of the brain is separated from the corresponding crus cerebri by a fissure which passes from behind forwards, and terminates in the fissure of Sylvius. If this fissure be followed backwards, it will be found to become continuous with a transverse fissure which separates the cerebrum from the cerebellum, and corresponds to the posterior edge of the corpus callosum. A continuity is thus established between the lateral and the transverse fissures, whence results one great fissure of semicircular form, the concavity of which is directed forwards. This is the *great cerebral fissure* of Bichat, or the *great transverse* or *horizontal fissure* (Cruveilhier.) It may be described as commencing at the fissure of Sylvius on one side, turning round the opposite cerebral peduncle, and ending at the opposite Sylvian fissure. The anterior and lateral portions of this fissure have already been noticed as the situations at which the pia mater enters the brain to form the choroid plexuses of the lateral ventricles. And it may be remarked here, how freely the subarachnoid fluid may pass along this fissure from before backwards. Parallel to this fissure we find the fourth pair of nerves as it passes to its point of exit from the cranium.

Not the least interesting and important of the objects presented at this central portion of the base of the brain is that remarkable arterial anastomosis, called the *circle of Willis*. This will be more particularly described by-and-bye; but it may be stated here, that the anterior bifurcation of the basilar artery is immediately behind the interpeduncular space, on each side of which the posterior cerebral artery passes for a short distance. The posterior communicating artery is parallel to the inner edge of the middle lobe; the subdivision of the carotid corresponds to the commencement of the Sylvian fissure; and the anterior communicating artery is at right angles with the longitudinal fissure immediately behind the anterior reflection of the corpus callosum. This anastomosis of arteries is bathed in the liquid which occupies the subarachnoid space in this situation.

The tentorium cerebelli is situate on a plane a little beneath that of the middle segment of the base of the encephalon just described. It forms a septum between the posterior lobes of the cerebral hemispheres, which are continuous with the middle segment, and the posterior segment of the encephalon, which we now proceed to describe.

The posterior segment, as occupying the posterior fossa of the cranium, is on a level considerably below that of the middle segment. The parts which are deserving of more particular notice here, are, proceeding from before, the pons Varolii (*n*, *fig.* 382), the inferior and anterior surface of the mesocephale, which is situate immediately behind the interpeduncular space, the crura cerebri appearing to emerge just above its anterior border. From its posterior edge the medulla oblongata (*o*) extends down-

wards, and a little backwards. As the brain rests on the upper surface of its hemispheres with its base upwards, the medulla oblongata is seen to occupy a notch or depression between the hemispheres of the cerebellum. The fibres of the pons Varolii are seen passing outwards and backwards into each hemisphere of the cerebellum, forming the inferior layer of each crus cerebelli. On each side of the medulla oblongata is the inferior convex surface of each hemisphere of the cerebellum marked by its fissures and laminae. The basilar artery passes in a groove along the middle of the pons from before backwards. The fifth nerve emerges from the crus cerebelli, the sixth immediately below the posterior margin of the pons, and the seventh, eighth, and ninth nerves are seen springing from each side of the medulla by a series of fascicles similar to those which form the roots of the spinal nerves.

Of the dissection of the brain from above downwards.—It will facilitate our subsequent descriptions, if, previous to examining the several segments of the encephalon in detail, I give a rapid sketch of the dissection of the brain according to the *topographical* method, proceeding from above downwards.

This dissection is commenced by making a horizontal section of one hemisphere, a little above the level of the corpus callosum. The surface, which is thus exposed, has in shape the character of a demi-oval. It is chiefly composed of white substance, which occupies the centre of the space, bounded by a wavy border of grey matter. Anatomists designate it *centrum ovale minus*. We find this is a convenient section on which to study the anatomy of the convolutions, and to give some idea of the composition of that portion of the hemispheres of the brain which is situate above the ventricles. On making a similar section of the other hemisphere at the same level, a similar surface is exposed, and the conjunction of both constitutes what Vieussens denominated the *centrum ovale majus*.

By separating the hemispheres slightly, after this section, the horizontal portion of the corpus callosum is well displayed. The continuity of its transverse fibres with the white substance of the hemispheres may be traced; and by following its anterior and posterior reflections they will be found to connect the hemispheres at their inferior as well as their superior parts. The corpus callosum, when examined in its full extent, exhibits somewhat of a vaulted shape, and is found to enter largely into the formation of the roof of the lateral ventricles.

We notice some remarkable longitudinal fibres, passing along the middle of the corpus callosum, varying greatly in development in different brains. These consist of two bundles placed in *juxta-position*, but easily separable. We may trace them throughout the whole length of the corpus callosum. They cut the transverse fibres at right angles, and may be readily dissected up from them. They seem to tie the transverse fibres together, and are probably commissural. They form what has been improperly

called the *raphé* of the corpus callosum, more correctly the *longitudinal tracts* (Vicq d'Azyr).

By scraping away the white substance, on each side of the corpus callosum, the lateral ventricles may be opened. If this be done with great care, a considerable portion of the membrane that lines the interior of each ventricle may be exposed, but such is its great delicacy that a very slight force ruptures it. When there is fluid in the ventricles, this membrane may be more easily demonstrated from its floating upon the fluid. The place at which the ventricles may be most certainly opened without the risk of injuring any of the parts contained within them, is about the eighth of an inch external to the blending of the fibres of the corpus callosum with the white substance of the centrum ovale. With the handle of a knife the fibrous matter which forms the roof of the ventricle may be torn through in the antero-posterior direction, and the cavity thereby exposed.

Each lateral ventricle consists of a horizontal and a descending portion. The former resembles in shape an inverted italic S. Its *anterior* extremity, or *cornu*, is directed outwards; the *posterior* turns inwards towards that of the opposite side. The *descending cornu* passes downwards, forwards, and inwards in a curved course with the concavity forwards and inwards, and terminates at the fissure of Sylvius. The first has been appropriately designated the *frontal* ventricle, the second the *occipital*, and the third the *sphenoidal*, from their relations to the bones after which they have been respectively named. The posterior cornu is also named the *digital*, or *uncyroid* cavity.

The anterior cornua of the lateral ventricles are separated from each other by a vertical septum situated on the median plane, very thin and transparent, the *septum lucidum*. This may be easily demonstrated on a vertical section of the brain, made a little to one side of the mesial plane, or if both lateral ventricles have been opened, by supporting the corpus callosum on each side with the handle of a knife, by which means the septum is stretched, and its extent and connections may be more readily determined. The septum is of a triangular form with curvilinear base, which is directed forwards, and fits into the anterior reflection of the corpus callosum. Posteriorly it fits in between the corpus callosum and the anterior extremity of the horizontal portion of the fornix.

The septum lucidum, although so extremely delicate and transparent, is very obviously composed of two layers, which enclose a space or cavity called the *fifth ventricle*. This may be shewn by dividing the septum horizontally from behind forwards. Each of these laminae consists, as may be easily observed by examining the margin of the section, of four layers: the outer one is derived from the lining membrane of the ventricles; immediately within this is a layer of a pale greyish matter continuous with a similar layer which covers the optic thalami and the internal surface of the third ventricle, consisting of clear nucleus-like particles homogeneous in texture; a third layer is composed

of white or fibrous matter; and a fourth consists of an extremely delicate membrane, probably covered by ciliated epithelium, which lines the internal surface of the fifth ventricle.

The fifth ventricle is closed at every point, and has, therefore, no communication with the lateral or other ventricles. It has been regarded by some as resulting merely from the artificial separation of the laminae of the septum lucidum. And it seems unlikely that in life, during health, the surface of these laminae should be otherwise than in contact, lubricated, however, by a slight moisture exhaled by the membrane. In a few rare cases fluid has been known to accumulate in this cavity.

In the fifth month of uterine life, according to Tiedemann, this ventricle communicates with the third through a small space, situate between the anterior pillars of the fornix and above the anterior commissure, and indeed it may be looked upon as a portion of the latter ventricle closed off by the formation of the fornix and septum lucidum.

The following parts are to be noticed in each lateral ventricle:—1. In the anterior horn, the *corpus striatum*, a pear-shaped eminence, the obtuse extremity of which is directed forwards and inwards. Posteriorly this body is apparently prolonged backwards into the inferior cornu of the lateral ventricle by a long tapering process which terminates there. 2. Internal and posterior to the corpus striatum is the *optic thalamus*, a gangliform body of a greyish colour, but considerably paler than that last named. 3. These two bodies are separated from each other by a superficial groove, in which lies a delicate band of fibrous matter, the *tania semicircularis*, which is covered by a lamina of horny-looking matter, *lamina cornea*, the formation of which is attributed by some to a thickening of the lining membrane of the ventricle along this groove.

The choroid plexus in a great degree covers and conceals from view the optic thalamus. It passes up from the descending cornu, and just behind the septum lucidum and anterior pillars of the fornix turns inwards to unite with its fellow of the opposite side. On its inner side it is slightly overlapped by the thin margin of the horizontal portion of the fornix.

In the posterior horn we observe, on its internal wall, a projection inwards of one of the convolutions to which the name *hippocampus minor*, or *ergot*, has been given. It is an internal convolution, covered by a layer of fibrous matter derived from the fornix. It is traversed by a deep sulcus, which may be exposed by cutting it across.

The descending horn contains a remarkable prominence, the *hippocampus major*, (also called *cornu Ammonis*), which projects into it from its inferior wall, and follows the curve of the horn. It likewise may be regarded as an internal convolution, and is covered by a layer of fibrous matter derived from the fornix, which overlaps the concavity of the hippocampus by a thin margin, called *corpus fimbriatum*. Beneath this is a peculiar disposition of grey matter connected with the hippocampus, to which the name

fascia dentata has been given. The commencement of the choroid plexus is found in this horn.

The anterior extremity of the descending horn of the lateral ventricle corresponds with the posterior extremity of the fissure of Sylvius. It is closed, not by nervous matter, but simply by the reflection of the membrane of the ventricle on the choroid plexus. This is the only provision against the escape of fluid from the ventricle. It seems highly probable, as we have already intimated, that there may be a communication at this situation, as well as at the fourth ventricle, between the fluid of the ventricles and that of the sub-arachnoid cavity by endosmose and exosmose. And the delicacy of the barrier which is opposed to the escape of fluid from the ventricle explains the occurrence of sanguineous effusions at the base of the brain from the rupture of vessels within the ventricle.

Postponing the more minute description of the parts found in the lateral ventricle, as above enumerated, we proceed with the examination of those which are brought into view beneath the corpus callosum.

The corpus callosum, which we have seen to consist of bundles of transverse fibres, passes directly from one hemisphere to the other. At its anterior and posterior extremity it is folded downwards, so as to connect those parts of the hemispheres which lie on a plane inferior to the lateral ventricles. Its anterior reflected portion, therefore, contributes to form the floor of the anterior horn, and the posterior one mingles with the fibres of the inner wall of the posterior horn. This disposition of the corpus callosum is best seen on a vertical section of the brain, which shows the vaulted form of this body. The greater abruptness of reflection of its posterior than of its anterior extremity, however, impairs in a great degree this character.

Of the fornix.—We have seen that the anterior reflection of the corpus callosum is occupied along the median plane by the vertical *septum lucidum*. This septum rests posteriorly upon the apex of a horizontal stratum of fibrous matter which forms part of a series of fibres called the *Fornix* or *Vault*. It is inconvenient to change names which have long been in use, more especially when there is no very certain scientific foundation for the adoption of a new one; otherwise the term *antero-posterior commissure*, which is suggested by the direction and the extensive connection of its fibres, might be appropriately assigned to it.

The principal portion or body of the fornix lies immediately beneath the three posterior fourths of the corpus callosum. By cutting this body across just at the posterior extremity of the septum lucidum, and dissecting the anterior segment forwards, and the posterior one backwards, its horizontal portion is exposed. In this dissection it is found that the latter portion of the corpus callosum is intimately adherent to the fornix. So close indeed is this adhesion that the separation is always attended with injury to the fornix. The deep-seated fibres of the corpus callosum seem to unite the lateral halves of the fornix.

The horizontal portion of the fornix, as exposed by this dissection, has the form of a triangle, the apex of which is directed forwards, and corresponds to the posterior angle of the septum lucidum. Its base is situate behind, and is enclosed by the posterior folded portion of the corpus callosum. The apex is prolonged into two rounded cords of fibrous matter, which pass downwards and outwards, in a somewhat curved course, with their convexity directed forwards. These are the *anterior pillars* of the fornix. As they descend, they diverge from each other. We can follow them down to the base of the brain, where they form two small tubercles, the *corpora mamillaria*, from which fibres are continued upwards and outwards into the substance of the optic thalamus.

The *posterior pillars* of the fornix are expansions of fibrous matter which are continuous with the angles of the base of its horizontal portion. These bands are continued into the lateral ventricle, and expand partly over the posterior horn, and partly over the hippocampus major in the inferior horn. The portion of the fornix which is thus continued into the inferior horn presents a fine concave edge directed inwards, which is the *corpus fimbriatum*.

It would thus appear that the fornix consists of a horizontal triangular portion (*corpus fornicis*) resting on four pillars, which take somewhat of a curved course, and form numerous connections with deep-seated and important portions of the brain. The anterior pillars are closely connected with the optic thalamus, with the tuber cinereum, with the white matter which forms the floor of the ventricle. The posterior pillars are in intimate union with the posterior and middle lobes of the brain.

The fibres of the fornix are distinctly longitudinal. So that, supposing it to be commissural in its office, it may be stated to connect the anterior lobe of the brain and the optic thalamus with the posterior and middle lobes.

The fornix is divisible into two equal and symmetrical portions, one belonging to each cerebral hemisphere. These portions are united, as has been already stated, by the deep-seated transverse fibres of the corpus callosum, and by the terminal fibres of its posterior reflexion, which form, on the inferior surface of the fornix, a peculiar appearance called the *lyra*. The transverse white fibres stand out in relief, crossing at right angles the proper fibres of the fornix. In many subjects, however, this appearance is but faintly indicated.

The horizontal portion of the fornix rests upon a triangular process of pia mater, which is introduced into the interior of the brain, at the fissure beneath the posterior reflexion of the corpus callosum. This process is the *velum interpositum* already described at page 635.

The anterior pillars of the fornix bound in front a space in which the velum interpositum and choroid plexuses unite, and through which the lateral ventricles communicate with each other. This is the *foramen commune anterius*, described by the first Monro.* If a probe be

* But previously recognised and described by Vieussens.

laid transversely in this orifice, it will have above it the anterior extremity of the fornix, in front the anterior pillars, and behind it the point of junction of the three processes of pia mater.

Of the third ventricle.—If the fornix be divided transversely at about its middle, and the segments reflected, and if the velum interpositum be removed, a fissure, the *third ventricle*, is exposed, situate between the optic thalami. This fissure extends forwards between the anterior pillars of the fornix, where it is limited by a band of white matter visible without dissection in that interval. That band is the *anterior commissure*, which lies just in front of, and as a tangent to the convex border of the anterior pillars of the fornix.

At its posterior extremity the third ventricle becomes very much contracted in all its dimensions, and is continuous with a canal which leads to the fourth ventricle (*iter a tertio ad quartum ventriculum, Aqueductus Sylvii*). The orifice of this canal is apparent at the posterior extremity of the third ventricle, and is bounded superiorly by a transverse cord of white matter, the *posterior commissure*, which extends for a short distance into the cerebral matter on either side. The base of the pineal gland rests upon this commissure.

In this stage of the dissection, a general view of the third ventricle is gained. This cavity evidently results from the apposition of the lateral halves of the brain proper, the parts which more immediately correspond being the inner surfaces of the optic thalami. The depth of the ventricle corresponds, in a great degree, to that of these bodies; but it manifestly increases towards the anterior extremity. Its floor is formed by a layer of grey matter continued from one side to the other, of the same nature as that which has been already described as covering the thalami. The deepest part of the ventricle is an infundibuliform depression, from which the tubular process, seen at the base of the brain (*fig. 382, l*), is continued down to the pituitary body. Just beyond this part is the anterior extremity of the ventricle, situate between the anterior pillars of the fornix and behind the anterior commissure; the depth of which is much less than that of the infundibulum.

The floor of the third ventricle corresponds to several parts of interest which have been enumerated along the middle of the base of the brain. Corresponding to the posterior extremity of the ventricle is the interval between the crura cerebri, the *pons Tarini*, or interpeduncular space. Next in order, in the direction from behind forwards, are the *corpora mamillaria*, which are succeeded by the *tuber cinereum* and *commissure of the optic nerves*. The anterior extremity of the ventricle corresponds to that portion of the tuber cinereum which extends between the optic commissure and the anterior reflexion of the corpus callosum.

The roof of the third ventricle is formed by the velum interpositum, already described as giving support to the horizontal portion of the fornix.

The direction of the long axis of the third ventricle is obliquely downwards and backwards. Its anterior extremity being on a higher plane than its posterior, is therefore likewise superior.

Pineal gland.—We may here conveniently notice the position and connections of the *pineal gland*. This body, rendered famous by the vague theory of Des Cartes, which viewed it as the chief source of nervous power, is placed just behind the third ventricle, resting in a superficial groove which passes along the median line between the corpora quadrigemina. It is heart-shaped, and of a grey colour. Its apex is directed backwards and downwards, and its base forwards and upwards. A process from the deep layer of the velum interpositum envelopes it and serves to retain it in its place. From each angle of its base there passes off a band of white matter which adheres to the inner surface of each optic thalamus. These processes serve to connect the pineal body to the optic thalami. They are called the *peduncles of the pineal gland*, also *habenæ*. In general they are two in number, one for each optic thalamus. They may be traced forwards as far as the anterior pillars of the fornix. Posteriorly these processes are connected along the median line by some white fibres which adhere to the base of the pineal gland, as well as to the posterior commissure beneath, and which seem to form part of the system of fibres belonging to that commissure. A pair of small bands sometimes pass off from these fibres, along the optic thalami, parallel to the peduncles above described.

It appears, then, that the pineal gland has no other connexion with the brain than that which these *habenæ* or peduncles secure for it; otherwise this body might more appropriately be regarded as an appendage to the pia mater, in which it is involved, and from which it derives its nutrition.

Grains of sand, similar in every respect to those previously described (p. 635) as connected with the internal processes of the pia mater, are found in the pineal body in a large proportion of instances in the adult. They seem to be accumulated as it were in a cavity which is situate towards its base. Hence Sommering gave to this collection of sabulous matter the name *acervulus*. When, however, the sand is abundant, it may be found upon the surface as well as in the centre.

The anterior commissure.—In examining the third ventricle, a rounded cord of very pure white matter is seen through the interval which is left by the divergence of the anterior pillars of the fornix in their descent to the base of the brain. This band is transverse, and appears to form a tangent to the convex border of those pillars. It may be traced outwards on either side through the anterior extremities of the corpora striata into the white substance of the middle lobes of the brain. A very little dissection is required to expose this cord in its entire extent. It seems placed in a canal hollowed in the cerebral matter. When exposed,

its surface is perfectly smooth, indicating that fibres do not pass from it to the wall of the canal in which it lies. Examined in its whole extent, it presents the form of a curve with anterior convexity, and becomes gradually flattened and expanded towards each extremity, its component fibres becoming divergent and mingling with the white substance of that portion of the brain.

This system of fibres possesses the characters of a commissure or bond of connection between symmetrical portions of the brain on either side of the median plane as distinctly as the corpus callosum itself.

The soft commissure.—The cavity of the third ventricle is partly occupied by a lamina of a light grey matter, which extends between the optic thalami of opposite sides. It forms a transverse horizontal plane dividing the ventricle into two portions, one above, the other below it. Sometimes it is divided and disposed as two planes. There is but little power of cohesion between its particles, so that in the recent state the separation of the thalami in the necessary manipulations will frequently cause its rupture. Hence the adjunct "soft" is appropriately applied to it, and by its connecting the thalami of opposite sides, this structure may be ranked with the other commissures. It does not extend throughout the entire length of the ventricle: both its anterior and posterior margins are concave and leave an open space between each extremity of the ventricle.

Thus far our examination includes the topographical anatomy of the cerebrum proper. The pineal body, indeed, scarcely lies within the confines of that segment of the encephalon, but from its internal relation to the third ventricle and the optic thalami, it must be included in the description of those parts. This body rests on the upper surface of that segment of the brain which lies intermediate to the cerebrum, cerebellum, and medulla oblongata, namely, the *mesocephale*. And we shall now proceed to a brief notice of this part and its connection to the other segments.

The mesocephale.—Four eminences are seen immediately behind the third ventricle. A transverse furrow separates them into an anterior and a posterior pair, and a longitudinal furrow along the median line divides the right and left pair from each other. The pineal body rests in the anterior extremity of the longitudinal depression. The anterior pair have been long named the *nates*, the posterior the *testes*. In the human subject the former are the larger. In the inferior mammalia these bodies are much more highly developed than in man, and exhibit a more marked difference of size.

The posterior of the corpora quadrigemina are apparently connected to the cerebellum by two columns of white matter, one of which passes into the central white substance of each cerebellar hemisphere. These are the *processus cerebelli ad testes*. They enter into the formation of the crura cerebelli. Each of them forms the superior layer of the crus cerebelli of its own side.

The interval between the *processus cerebelli ad testes* is occupied by a horizontal stratum of nervous matter composed of a thin layer of grey and of white matter. This is called the *valve of Vieussens*, although there is evidently nothing valvular in its nature or office. Its surface is marked by slight transverse depressions and eminences. The median lobe of the cerebellum overlaps and conceals it from view.

The valve of Vieussens* must be regarded as a portion of the median lobe of the cerebellum, which is extended forwards between the *processus cerebelli ad testes*. Its constitution is precisely the same as the laminae of that body, and the transverse markings upon its superior surface are indications of imperfectly developed fissures between the laminae.

The corpora quadrigemina form the anterior superior part of the mesocephale. They lie above the crura cerebri, upon those columns of nervous matter by which the latter bodies are connected with the medulla oblongata. These columns are continuous above with the optic thalami, and below with the central portion of the medulla oblongata, the *olivary tracts*, or *fasciculi innominati* of Cruveilhier. They are distinguished by their reddish grey colour and their close resemblance in point of structure to the optic thalami. In transverse section they appear as two columns, circular in outline, quite distinct from the surrounding greyish matter in which they seem imbedded (fig. 388, i).

The lower half of the thickness of the mesocephale is formed by transverse curved fibres with anterior convexity, which extend between the lateral lobes of the cerebellum, and of longitudinal fibres which interlace with the superior layers of those transverse fibres and cross them at right angles. The former constitute the pons Varolii, a great commissure between the hemispheres of the cerebellum; the latter are, in greater part at least, the fibres of the anterior pyramids of the medulla oblongata, which ascend through the pons, and enter into the formation of the inferior layer of each crus cerebri.

In examining the inferior surface of the mesocephale, the pons Varolii, we observe that a longitudinal groove extends along its middle from above downwards. In this lies the basilar artery. Above the anterior edge of the pons, the crura cerebri are seen emerging, and diverging from each other as they pass, to enter, stalk-like, into the inferior surface of the cerebral hemispheres. Beneath its posterior edge, the medulla oblongata is seen, its anterior and

middle columns passing through the mesocephale to the crura cerebri. On each side the fibres of the pons pass off into each hemisphere of the cerebellum and form the inferior lamina of each crus of that organ.

The cerebellum.—Some account of the general disposition of the cerebellum will serve to conclude this brief review of the topography of the brain. The superior surface of this organ is a little above the level of the quadrigeminal bodies. It is smooth and slightly convex. The lamellae of the cerebellum are visible upon it, but cannot be separated without removing the arachnoid and pia mater. A notch is seen, dividing the posterior edge into two equal portions, and a larger notch exists in front, at which the cerebellum forms its connection with the mesocephale. These notches denote a subdivision of the organ into two lateral portions, or hemispheres, and a median portion. The superior surface of the median portion is called the *superior vermiform process*; its anterior terminal laminae form the valve of Vieussens. On the inferior surface the hemispheres of the cerebellum are much more convex than on the superior. The median portion too is somewhat differently arranged on its inferior surface; it consists of a series of laminae, following a transverse direction; those in its centre are of greater transverse extent than those at either extremity, whence the appearance of a crucial figure results. This is the *inferior vermiform process*.

The posterior margin of the cerebellum is convex, and corresponds to the concave surface of the occipital bone, the falx cerebelli occupying the notch in its middle. Along the line of this margin, the pia mater sinks into a deep fissure, which takes a horizontal direction from behind forwards, and divides the cerebellum into a superior and inferior portion.

As the brain, removed from the cranium, lies with its base upwards, the medulla oblongata is seen between the lateral hemispheres of the cerebellum occupying a portion of the depression between them, in which is the inferior vermiform process (fig. 382).

The *fourth ventricle* is a lozenge-shaped cavity situated in the upper and posterior part of the medulla oblongata, and formed by the separation of its postero-lateral columns (*corpora restiformia*). The cerebellum contributes to inclose it above by means of the anterior laminae of the superior vermiform process and the valve of Vieussens, and below and behind by the inferior vermiform process (fig. 386).

We now proceed to the examination of the various segments of the encephalon, with more special reference to the structure and physiological bearing of each. It may be here remarked that, while all the segments are intimately connected with each other and are therefore mutually dependent, there is much in their structure to justify the assumption that each is capable of exercising an independent function, which is, however, liable to be modified by the influence which any one, or all of the other segments may have upon it.

OF THE MEDULLA OBLONGATA. (Fr. *moelle*

* *Valvula cerebri major* is the name which Vieussens applied to this process. He describes it as "membrana quam transversus medullaris tractus circa anteriora subit, processui vermiformi anteriori, processibus a cerebello ad testes et posticæ pontis Varolii parti adhæret et unitur." He further adds, "illam valvulæ vices gerere asserimus. Ex quo fit, ut habitû officii et magnitudinis illius ratione, ipsam valvulam cerebri majorem nominemus, ut eam a membranacis ligamentis distinguamus, quæ intra longitudinalis et lateralium sinuum cavitates valvularum minorum vices suppleat et munia præstant."—*Neurographia Unicerealis*, p. 76. Ed. Lugd. 1716.

allongée, bulbe rachidien. Germ. *das Verlängerte Mark.* Ital. *midollo allungato.*)—We begin with the description of this segment because of its immediate connection with the spinal cord, for it is plain, since this is the connecting link between that centre and the intra-cranial mass, that whatever influence the latter may exercise upon the former, must be conveyed or propagated by the medulla oblongata.

It is proper to notice that the term *medulla oblongata* has not been employed in a uniform sense by all anatomists. Willis and Vieussens comprehended under this title all the parts from the corpora striata and optic thalami (both included) down to the commencement of the spinal cord.* The same signification was adopted by the writers who immediately followed these great anatomists. Winslow considers the medulla oblongata as "one middle medullary basis common to both cerebrum and cerebellum, by the reciprocal continuity of their medullary substances."† The *crura*, or *pedunculi cerebri*, constitute its anterior part: these seem to be lost in the corpora striata, as Winslow states, and therefore they are looked upon as the peduncles of the cerebrum. Its posterior portion is called the *extremity* or *cauda* of the medulla oblongata (*queue de la moelle allongée*). It is to this latter portion that Haller restricted the term medulla oblongata, and most modern anatomists follow his example. Rolando, however, still applies the term in its more extended sense.

In the present article, we adopt the phraseology of Haller as far as regards the term *medulla oblongata*. It seems to form an upper enlarged portion of the medulla spinalis, to which it stands in somewhat the same relation as the capital to the shaft of a column. Its superior limit is indicated by the posterior edge of the pons Varolii; its inferior is denoted by a horizontal plane extended between the occipital foramen and the first vertebra. A more natural line of demarcation, however, between this part and the medulla spinalis may be found in certain decussating fibres which are seen crossing the anterior median fissure of the former at its inferior extremity. No such limit as this, however, is found on the posterior surface (fig. 383).

The medulla oblongata has somewhat of a conical shape, its base being situate above at the posterior margin of the pons. It is slightly flattened on both anterior and posterior surfaces, more so on the latter than on the former.

The medulla oblongata admits of the same primary subdivision as the medulla spinalis, namely, into two equal and symmetrical portions separated from each other by an anterior and a posterior median fissure. The former is wide but not of great depth. It is occupied by a fold of pia mater. Its floor is formed by a layer of fibrous matter which has the same cribriform appearance as that of the anterior spinal fissure. These fibres are commissural, connecting the

* See the quotation from the English edition of Willis, at p. 669.

† Winslow's Anatomy, translated by Douglas, vol. ii. p. 316. Edin. 1763.

Fig. 383.

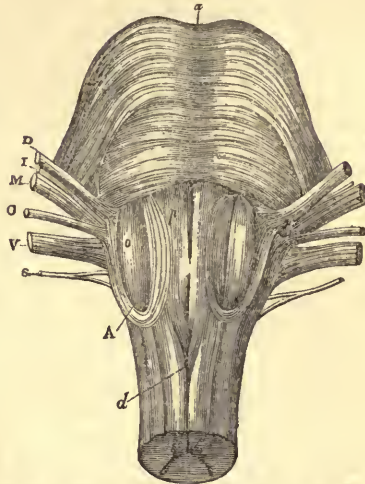

Anterior view of the medulla oblongata and pons Varolii. (After Arnold.)

- a, anterior extremity of the pons.
 - p, anterior pyramids.
 - d, decussating fibres of anterior pyramids.
 - o, olivary bodies.
 - A, arciform fibres.
 - D, portio dura
 - I, portio intermedia of Wrisberg
 - M, portio mollis
 - G, glosso-pharyngeal nerve
 - V, par vagum
 - S, spinal accessory
- } Seventh pair of nerves.
- } Eighth pair of nerves.

two portions of the medulla oblongata. The posterior fissure is very deep and narrow. It is not limited in front by a grey commissure as the posterior spinal fissure is, but by the posterior surface of the white commissure just described. A single layer of the pia mater passes into it. The continuity of the anterior fissure of the medulla oblongata and of that of the spinal cord is interrupted by the decussating fibres of the pyramids, (fig. 383, d,) but the posterior fissures are distinctly continuous with each other.

On either side of the median plane there are indications on the surface of the medulla oblongata, which suggest a subdivision of each half of the organ into four columns of nervous matter, through the medium of which it forms its connection with certain parts of the cerebrum and cerebellum on the one hand, and of the spinal cord on the other. These columns are the *anterior pyramidal*, the *olivary*, the *restiform*, and the *posterior pyramidal*.

The *anterior pyramidal column*, or *anterior pyramids*, (figs. 383, 384, 385, p,) are two prismatic bundles of fibrous matter which extend between the antero-lateral columns of the spinal cord and the lateral hemispheres of the brain. In the medulla oblongata each of these columns forms a compact body, which, when cut transversely, exhibits a triangular outline in its central portion, but that of a cylinder at either extremity. Each pyramid is limited on the outside by a superficial groove, which separates it from the olivary column, and on the inside by the anterior median fis-

Fig. 384.



Anterior view of the medulla oblongata, showing the decussation of the pyramids, and of the upper part of the spinal cord. (After Mayo.)

- p*, anterior pyramids.
o, olivary bodies.
r, restiform bodies.
d, decussating fibres.
al, antero-lateral column of the spinal cord.
c, anterior fissure of the cord, the floor of which forms the anterior commissure.

sure. Superiorly the pyramids pass into the mesocephale above the inferior fibres of the pons Varolii, and interlace with other fibres of the same system which occupy a more elevated plane. In its passage into the mesocephale, each pyramid experiences a marked constriction, which alters its form from a prism to a cylinder. The fibres, however, soon diverge and expand. As they ascend through the mesocephale they are crossed by the transverse fibres of the pons, and some grey matter occupies the interstices between them, with which it is probable that other fibres are connected, and are added to those of the pyramids, as they emerge from the mesocephale at its anterior extremity.

The pyramids gradually diminish in size towards the inferior extremity of the medulla oblongata. And here three sets of fibres may be distinctly noticed. The first, or *decussating fibres*, are the most numerous; they pass downwards and backwards into the antero-lateral column of the spinal cord on the opposite side, so that the right pyramid sends fibres into the left half of the cord, and the left pyramid into the right half of the cord. These decussating fibres consist of from three to five bundles from each pyramid, which in their descent cross and interlace with each other (figs. 384, 385, *d*). They differ in distinctness as well as in number in various subjects. The point at which the decussation takes place is about ten lines below the margin of the pons Varolii, and the interruption to the fissure, occasioned by the crossing of the fibres, occupies a space of from two to four lines. To expose these fibres clearly it is necessary to remove the pia mater carefully from the anterior surface of the medulla ob-

longata to some distance below the decussation, and it is, in general, of advantage to the preparation to place it in alcohol immediately after the removal of the pia mater.

A second set of fibres, very few in number, are continued from the pyramids directly down to the anterior surface of the cord on the same side, and appear to be continuous with some of the superficial fibres of the antero-lateral column. These fibres may be regarded as the direct channel of communication of each half of the medulla oblongata with the corresponding half of the spinal cord (fig. 385, *n*).

The third series of fibres vary considerably in point of development in different individuals. They pass between the pyramids and the postero-lateral columns of the medulla oblongata, the restiform columns. They form a series of curves with their concavities directed upwards (fig. 383, *A*), crossing beneath the inferior extremity of the olivary body, and sometimes extending over a considerable portion of its surface. I have on several occasions seen these fibres so largely developed as to cover nearly the whole surface of each olivary body. These fibres are appropriately distinguished by the name *arciformes*, from their arched course (*processus arciformes*, Santorini).

When these fibres are so numerous as to cover the surface of the olivary body, we may observe that those which are nearest the margin

Fig. 385.

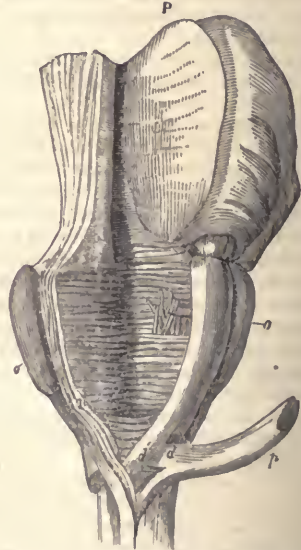

Anterior surface of the medulla oblongata, with a portion of the spinal cord and of the pons Varolii, as seen obliquely from the right side. (After Mayo.)

- P*, pons Varolii—its left half.
o, o, olivary bodies.
p, part of the right anterior pyramid, cut across near the inferior edge of the pons, and torn down, showing the passage of some of its fibres over to the left side and backwards.
d, decussating fasciculus of fibres of right pyramid.
d', decussating fasciculus of left pyramid.
n, non-decussating fibres of the right pyramid.

of the pons Varolii are the least curved, and in some rare instances the uppermost ones exhibit no more curvature than the posterior fibres of the pons.

Both Santorini and Rolando have figured these fibres in their most highly developed state. The delineation given by the latter author, whilst it serves admirably as a diagram to show the general relation of the fibres, represents them as more numerous and distinct than I have ever had an opportunity of seeing them, and likewise exhibits them as passing upwards through the pons. This is certainly not the case. These fibres appear to incorporate themselves with the restiform bodies which connect the medulla oblongata with the cerebellum.

It seems to me that the arciform fibres may be properly regarded as a part of the same system as those which form the pons Varolii. They are largely developed in some quadrupeds, although they assume a different form. The fibres which constitute what Treviranus called *the trapezium*, appear to answer the same purpose as the arciform fibres; but, by reason of the non-development of the olivary bodies on the exterior of the medulla oblongata, they do not take the curved course, which characterizes them in the human subject. These fibres cross the anterior surface of the medulla oblongata parallel to but distinct from the pons Varolii. They connect the pyramids and restiform bodies on each side.

By their continuation upwards the pyramidal bodies form a connection with the mesocephale, and also with the hemispheres of the brain through the medium principally of the corpora striata, and perhaps also of the optic thalami. Through the decussation of fibres which takes place just before the pyramids sink into the spinal cord, each cerebral hemisphere is connected with that half of the spinal cord which belongs to the opposite side of the body. By this arrangement is explained the influence which cerebral disease exercises upon the side of the body opposite to that on which it occurs. If the right hemisphere be irritated, convulsions are produced on the left side; if the right hemisphere be compressed, the left arm and leg and side of the face will be paralysed. So constant is this "crossed" influence of cerebral lesion that it can be attributed only to some uniform physical condition of the nervous centres. And that the anatomical disposition on which it depends is situate at the lower part of the medulla oblongata is proved, not only by the existence of these decussating fibres at this situation, but likewise by facts revealed by the phenomena of disease, and the results of experiment. Morbid lesions, for example, which have their seat *above* the decussation are, with rare exceptions, accompanied by affection of the opposite half of the body—those which involve the nervous centre *below* the decussation affect the body on the same side. Mechanical injury to the brain or spinal cord produces like effects. And so constantly is this the case that when we meet a case of paralysis or of convulsion affecting only one side, we confidently predict that the lesion on which it depends will be found on the opposite side of the brain.

This law of cerebral action has been known from the earliest periods of medical science, but the anatomical explanation of it, the suggestion of which dates as far back as the time of Aretæus,* has been generally admitted only within a comparatively recent period. This explanation was founded on the hypothesis of a decussation of fibres in the medulla oblongata to a greater or less extent. Santorini, indeed, laid it down that decussation took place not only in the lower part of the medulla oblongata, but likewise at the anterior and posterior margins of the pons Varolii.† But it is quite impossible, by our ordinary means of observation, to detect any such connection between the anterior pyramids elsewhere than at their inferior extremity. In many instances I have thought that the fibres of the commissure which forms the floor of the anterior fissure presented an appearance as if decussation took place along the entire length of the pyramids. But the numerous foramina by which the commissure is penetrated to give passage to vessels for the central substance of the medulla, are very apt to give rise to a fallacious appearance of this kind.

It has been stated that there are exceptions to this law of cerebral action. Such certainly must be extremely rare, for in the course of a considerable experience for many years I have not met with an unequivocal instance in which paralysis occurred on the same side with cerebral lesion. The analysis which Burdach has given of 268 cases of paralysis in which there was lesion of a single hemisphere, shows very strikingly how rare must such an exception be. Of these cases he states that 10 were accompanied with paralysis of both sides, and that 258 had hemiplegia. And of the hemiplegic cases, the paralysis occurred on the same side as the cerebral lesion in only 15.

The full explanation of these exceptions has

* Περὶ αἰτίων καὶ σημεῖων χρόνιων παθῶν, βιβλ. Α, κεφ. ζ, p. 87, Ed. Kuhn.

† Santorini must have been well acquainted with the decussating fibres of the pyramids, which he clearly describes. The whole passage is worth being quoted here. "Id autem triplici potissimum in loco animadvertere potuimus; in utraque scilicet priore, posterioreque annularis protuberantiæ crepidine atque maxime in imo medullaris caudicis quâ in spinalem abit. In priore itaque annularis protuberantiæ parte, quâ superior reflexa pro comprehendendis oblongatâ medullâ cruribus in anguli formam interius producta tenuatur, sic ex concurrentibus fibris, strictiorique agmine coeuntibus altera alteram scandit ut præter mirum implexum decussatio luculentissimè appareat. Id ipsum fermè in postica ipsius crepidine occurrit. Eo iterum in loco, qui quarto ventriculo subjicitur, præter varios fibrarum ordines et colores, in adversum latus productas et decussatas fibras commodè spectavimus. Si ea tamen evidententer uspiam conspicitur, profectò quam evidentissimè duas vix lineas infra pyramidalia atque adeo olivaria corpora conspici potest. Quâ enim in longitudinem producta linea seu rimula pyramidalia corpora discernuntur, si leniter deducatur, probè prius eo potissimum loco artissimè hærente tenui meninge nudata, non tenues decussari fibrillas, sed validos earundem fasciculos in adversa contendere, quam apertissimè demonstrabunt." *Oberv. Anat. cap. iii. § xii. p. 61. Ed. Lugd. Bat. 1739.*

yet to be discovered. The anatomical connection of each anterior pyramid with the spinal cord, however, affords some clue to it. This takes place, it will be remembered, not by the decussating fibres only, but by straight and perpendicular ones also; so that each pyramid is connected with both halves of the spinal cord, first and principally with the opposite half; and, secondly, and by much fewer fibres, with that of the same side. When those parts of the brain are affected, with which the decussating fibres are connected, the paralysis will be crossed; when, on the other hand, the direct fibres are engaged, the paralytic affection will occur on the same side of the body as that on which the lesion has occurred. But even on this explanation it is difficult to understand how these latter cases should be of such rare occurrence, and still more, how hemiplegia is so frequently accompanied with a perfect state of sensation and motion on the other side. In the present state of our knowledge, however, this is the only contribution which anatomy can offer towards the determination of this difficult question.

Of the restiform bodies.—The lateral, and, in great part, the posterior portion of the medulla

oblongata is formed on each side by a thick and rounded *rope-like* column, called the *corpus restiforme*. It is composed chiefly of fibrous matter, and its constituent fibres take a longitudinal direction. There is no line of demarcation between them and the fibres of the spinal cord, with the antero-lateral and posterior columns of which they seem to be continuous. Traced upwards, the restiform bodies pass a little outwards, and by their divergence contribute to the increased size of the medulla oblongata at its base.

To see the connexions of these bodies completely, the posterior surface of the medulla oblongata should be examined. The restiform bodies form the greater part of this surface. They increase in thickness as they ascend. Their outer margin forms a gentle curve, which is concave. Their inner border is connected in its lower portion to two small bands of fibrous matter, between which the posterior median fissure is situate; these are the *posterior pyramids* (Y, fig. 386). In its upper portion, the inner border of each restiform body is free, and forms the outer boundary of a lozenge-shaped depression, the *fourth ventricle*. Whilst the connection of the cerebellum with the posterior surface of the medulla oblongata is undisturbed, the exact relation of these bodies to the ventricle cannot be seen. It is necessary to raise up the inferior portion of the median lobe of the cerebellum, to expose the cavity of the ventricle; or this may be effected by dividing the median lobe along the middle line.

Each restiform body ascends to the hemisphere of the cerebellum of the corresponding side. The whole of its fibres appear to penetrate that organ, and contribute to the formation of its crus, and middle layer or peduncle of which it forms. This is very well shown in the analytical figure at p. 667, (fig. 380,) where *r* is the restiform body passing upwards and outwards into the hemisphere of the cerebellum.

The distinction between the restiform and olivary bodies on the surface is indicated by the line of origin of the eighth pair of nerves, which may be said to emerge along the anterior margin of the former. A narrow band of fibres, very distinct in some brains, occupies the depression between the posterior edge of the prominent olivary body and the line of emergence of these nerves. This band has been well delineated by Rolando, Reid, and others; it probably forms a part of the cerebral fibres of the medulla oblongata, and ascends through the pons.

The direction of the fibres of the restiform bodies is longitudinal. Those which are situate most posteriorly pass directly downwards, and are distinctly continuous with the posterior columns of the spinal cord. The fibres which form the lateral and anterior part of the restiform bodies pass downwards and forwards to the antero-lateral columns. A superficial groove, varying very much in distinctness in different subjects, which passes upwards from the line of

Fig. 386.

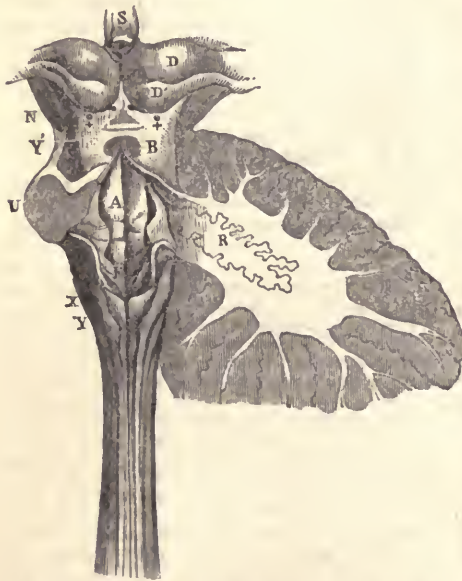

Posterior view of the medulla oblongata, with mesocephale and part of cerebellum of an infant. (After Foville.)

- S, pineal gland.
 D, nates.
 D', testes.
 +, point of emergence of fourth pair of nerves.
 Y, posterior pyramids.
 X, restiform columns.
 A, F, floor of the fourth ventricle, formed by the olivary columns, the fissure between which is the calamus scriptorius.
 Y, posterior surface of mesocephale.
 B, valve of Vicussens.
 N, anterior surface of crus cerebri.
 R, corpus dentatum or rhomboideum.

emergence of the posterior roots of the spinal nerves, indicates the distinction of these two sets of fibres. If the posterior column be separated from the antero-lateral in the spinal cord, the separation may be easily carried upwards along this line, in a specimen which has been sufficiently hardened.

From the description now given, the restiform bodies may be regarded as the connecting fibres between the cerebellum and the spinal cord. They may be designated the *cerebellar fibres* of the medulla oblongata in contradistinction to the others, which are entirely connected with the mesencephale and with the cerebrum.

Rolando describes the restiform body as containing grey matter—the *grey tubercle* of Rolando. This grey matter, however, may be more correctly regarded as a portion of the central nucleus of the medulla, from which very probably some fibres of the restiform body emerge.

The posterior pyramidal columns.—On each side of the posterior fissure we find a narrow column, sufficiently distinct from the restiform columns. These may be traced downwards through the cervical region of the cord, and even into the dorsal or lumbar, according to Foville. They taper gradually to a fine point, the situation of which varies in different subjects. Superiorly they form the inferior and part of the lateral boundary of the fourth ventricle. Their innermost fibres end abruptly in a blunt extremity, whilst the external ones are continued upwards on each side of the ventricle (fig. 386, Y).

Olivary columns.—The oval bodies, which form a relief upon the surface of the medulla oblongata, have been long known by the names *corpora olivaria*, *olivæ*. They occupy the interval between the anterior pyramids and the restiform bodies, separated, however, from the latter by the narrow band of fibrous matter above described.

The surface of each olivary body is crossed to a greater or less extent by the arciform fibres, as already described. Sometimes it is necessary to remove these fibres, in order to expose the proper texture of the olives.

The superficial layer of each olivary body is evidently fibrous, and the constituent fibres seem to take a longitudinal course. If a section be made so as to remove the prominent convexity of this body, it will be seen that the white matter of which it principally consists encloses a layer of vesicular or grey matter disposed in a peculiar manner. This grey layer presents the appearance of a waving line enclosing white matter. If the section of the olivary body be made transversely, the grey waving line is still present, but it presents a convex border outwards, and is open within, being evidently continuous with the central and less definitely disposed grey matter of the medulla. And when the section is vertical, and so as to divide the olivary body in its entire length, the convex border of the grey line is still external, but it is open towards the interior of the medulla.

This grey layer, contained within the olivary

Fig. 387.

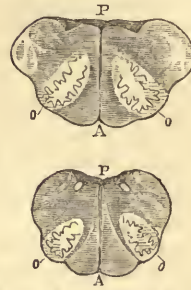

Transverse sections of the medulla oblongata.

A, anterior. P, posterior.

o, olivary bodies, in which are seen the undulating line of grey matter which forms the corpus dentatum.

body, is called the *corpus dentatum* (*corps festonné*, Fr.) It is evidently a capsule of vesicular matter continuous below with that of the cord, internally with that of the central substance of the medulla oblongata, and superiorly with that of the mesencephale (o, fig. 387). Its disposition, in a convoluted form, has doubtless reference to the packing of a certain quantity of this matter into a given space, and to the important object of bringing the vesicular and fibrous matter into connection as extensively as possible.

It has been very commonly supposed that the olivary bodies are mere gangliform masses laid upon certain ascending fibres of the medulla, and that they may be readily removed without injury to the deeper-seated parts. Either of the two following modes of dissection will, however, serve to point out the erroneusness of this view. If the anterior pyramids be removed, a concave surface is left between the two olivary bodies, in which their continuity with the central substance of the medulla is distinctly seen. This central substance, which forms a substratum on which the anterior pyramids rest, and from which it is not improbable that some of the fibres of the pyramids emerge, is of considerable density. Each olivary body appears gradually to merge into it; or, adopting another mode of description, it seems to protrude, forming a relief on the exterior, in the interval between the pyramidal and restiform bodies on each side. Or a transverse section, as in fig. 387, will exhibit a similar continuity between the olivary bodies and the central substance of the medulla.

According to this view, then, the existence of the olivary bodies in the human brain and that of the Quadrumana indicates a high development of the central substance of the medulla oblongata as compared with its other nervous columns. In all the vertebrate animals below man, the medulla oblongata increases with the bulk of the body, and like the spinal cord evidently bears a direct relation to it. This high development appears, however, to affect more especially the restiform and pyramidal bodies, and their connecting fibres, *the trapezium*. The former do not leave any

space between them, and the central columns do not extend to the surface; and from the absence of any great development of grey matter, we find no such arrangement as that which gives rise to the *corpus dentatum* in man.

The olivary or central columns of the medulla oblongata pass into the mesocephale, occupying a plane superior to that of the pyramidal fibres and of the transverse fibres. They may be traced upwards to the crus cerebri, where they seem to merge into the optic thalami, and to form a connection with the corpora quadrigemina posteriorly.

These columns are seen distinctly in their ascent to the brain in the fourth ventricle, as two cylindrical columns (A, F, fig. 386). They form the floor of that cavity and are separated from each other by the longitudinal fissure which is continued upwards from the posterior fissure of the medulla oblongata.

In the fourth ventricle the olivary columns are crossed by the fibres of origin of the portio mollis of the seventh pair of nerves, the white colour of which in the recent specimen contrasts strikingly with the greyish hue of the columns themselves. We here see distinctly that these columns are the source of origin of these nerves, and no doubt they are equally so of all the nerves which are connected with the medulla oblongata, namely, the fifth pair, the eighth, the ninth, and probably also of the sixth.

The relation of the olivary columns in their upward course, to the other constituents of the mesocephale and crura cerebri, may be conveniently demonstrated in examining transverse sections of those parts. We shall, therefore, return to this subject in describing the anatomy of those portions of the brain.

The following interpretation of the various columns of the medulla oblongata, referred to in the preceding description, has much foundation in their anatomical relations.

The olivary or central columns constitute the fundamental part of the medulla oblongata; that, on which its action as a distinct and independent centre depends, and in which the proper nerves of this segment of the encephalon are implanted. The continuity of those columns with the optic thalami and corpora quadrigemina materially enhances their physiological influence, and denotes their intimate association with some of the most important functions of the brain. And it may be added, that this connection of the medulla oblongata with parts which are ordinarily described as pertaining to the brain itself, shews that the original application of the term by Willis and Viussens to a much greater extent of the encephalon is certainly more consistent with the physiological anatomy than that which is now employed for the convenience of description. There can be no doubt that the extent of this central and fundamental portion of the nervous system is limited above by the optic thalami and below by the spinal cord.

The anterior pyramids connect the cerebral hemispheres with the spinal cord, the prin-

cipal bundles of fibres decussating each other on the middle line, so that the right pyramid is the medium of connection by the greater number of its fibres between the right hemisphere of the brain and the left half of the cord, but by a much smaller number between that same hemisphere and the right half of the cord. And so also of the left, *mutatis mutandis*. It is highly probable too that the anterior pyramids derive fibres from the locus niger of the crus cerebri and the vesicular matter of the mesocephale. These fibres, therefore, connect those segments with the spinal cord, but whether they contribute to the formation of the decussating or non-decussating bundles, or to that of both, it is impossible to determine.

The restiform bodies are evidently the connecting fibres between the hemispheres of the cerebellum and the posterior and antero-lateral columns of the spinal cord. And the posterior pyramids connect the posterior part of the medulla oblongata with the cervical and dorsal regions of the cord.

Nerves.—Numerous nerves are connected with the medulla oblongata—a fact which serves greatly to enhance its importance as a centre of nervous action. These nerves are the sixth pair, which are connected with the anterior pyramids just behind the posterior border of the pons; the ninth pair, or hypoglossal nerves, which emerge along the anterior border of the olivary body; the seventh pair (*portio mollis* and *portio dura*), which emerge just behind the upper extremity of the olivary body; and the eighth pair, which arise along the posterior margin of the olivary body.

OF THE MESOCEPHALE.—The pyramidal and olivary columns may be readily traced, as already explained, from the medulla oblongata up to the cerebral hemispheres; the former becoming united chiefly with the corpora striata, the latter with the optic thalami.

In that part of their course which is intermediate to the medulla oblongata these columns become mingled with certain transverse fibres, and with more or less of vesicular matter, and with them contribute to form a mass which is the connecting link between all the segments of the cerebellum, and may be compared to a railroad station, at which several lines meet and cross each other. This is the *mesocephale* or *mesencephale*. The name was suggested by Chaussier, inasmuch as it forms “to a certain extent the middle and central part of the encephalic organ, the bond which unites the several bundles of fibres which contribute to its formation.”

The mesocephale may be isolated from the other segments by dividing the crura cerebri just beyond the anterior margin of the pons, and the crura cerebelli as they penetrate the hemispheres, and the medulla oblongata on a level with the posterior edge of the pons. The crura cerebri emerge from it in front: the medulla oblongata is connected with its posterior surface: on either side it is prolonged into a crus cerebelli. Its inferior surface, which is very convex and looks forwards, is composed of the thick layer of arched fibres which form the

pons Varolii; and on its superior surface, which looks backwards, are the corpora quadrigemina, the processus cerebelli ad testes, and part of the floor of the fourth ventricle (*fig.* 386).

According to Chaussier, its weight is equal to about the sixtieth or sixty-fifth part of the entire brain.

We shall describe separately the inferior and the superior surfaces of this segment of the encephalon, and its intimate structure as unfolded by sections.

The inferior surface, (*pons Varolii, annular protuberance,*) convex from side to side, is interrupted along the median plane from behind forwards by a shallow groove in which the basilar artery usually lies, giving off in its course numerous minute capillaries to the nervous structure of the mesocephale.

When the pia mater has been stripped off this surface, it is seen to be very evidently composed of a series of transverse fibres which take an arched course. The fibres are collected into large fascicles separated from each other by very distinct intervals, so that there is no part where the fibrous structure is more apparent than here. They form arcs of circles, not concentric, lying one behind the other in a series nearly parallel. Owing to this want of complete parallelism the width of this surface measured from before backwards is much less at each extremity than in the centre. The anterior margin is convex, and forms a thick edge crossing the crura cerebri like a bridge; hence the term *pons* was applied by Varolius to the whole series of fibres. The posterior border is concave, less curved than the anterior, and crosses the anterior pyramids and olivary columns, as the latter does the crura cerebri. The intervening fascicles of fibres become gradually less curved as they approach the posterior margin.

These transverse fibres form a stratum of considerable thickness at the inferior surface of the mesocephale. Some grey matter is deposited between the less superficial layers which constitute it. The more deep-seated layers are penetrated and crossed at right angles by the ascending fibres of the anterior pyramids. A remarkable interlacement takes place at this situation between the vertical and transverse fibres—the latter passing alternately in front of and behind adjacent bundles of the former. Some of the vertical fibres seem to sink into and connect themselves with the grey matter.

A transverse vertical section of the mesocephale gives a more complete view of the exact extent of the transverse fibres. They are found to occupy rather more than one-third of the depth of the exposed surface. Their disposition in laminae is very apparent. Those which are nearest the centre of the mesocephale have between them considerable intervals, which are filled up by grey matter, through which pass vertically the fibres of the pyramids. The intervals between the laminae gradually diminish towards the inferior surface of the pons, and the quantity of intervening grey matter becomes proportionally less, and disappears altogether from between those laminae the in-

tervals of which are not traversed by the fibres of the pyramids.

The transverse fibres pass on either side into each hemisphere of the cerebellum, contributing with the *processus cerebelli ad testes* and the restiform bodies to form the *crura cerebelli*. They are the *inferior peduncles* of these crura.

The anatomy of these transverse fibres evidently denotes that they serve to connect the right and left cerebellar hemispheres, as *commissures*, and in a manner strikingly analogous to that in which the fibres of the corpus callosum connect the cerebral hemispheres. This view of the office of these fibres is strongly confirmed by the fact that their number is always in the direct ratio of the size of the lateral hemispheres, and that when the hemispheres are absent, these fibres no longer exist. When, therefore, the cerebellum consists only of a median lobe, there is no *pons Varolii*.

Some of the transverse fibres nearer the inferior surface appear to dip in along the median line, and to pass upwards and backwards, forming a vertical plane of fibres which divides the mesocephale into two symmetrical portions, and Chaussier imagined that a decussation took place at this situation. The groove in which the basilar artery lies is formed partly by the greater condensation which is produced along the median plane by this arrangement, and partly by the slight bulging on either side of it, caused by the ascent of the anterior pyramids. These fibres are continuous with a series of similar ones in the medulla oblongata (*antero-posterior fibres* of Cruveilhier).

The extent of the superior surface of the mesocephale may be limited in front by a line which passes from side to side just before the anterior of the corpora quadrigemina, and posteriorly by the base of the valve of Vieussens. This occupies a much greater space than the inferior surface. It is an inclined plane, and passes downwards and backwards, being concealed by the anterior laminae of the superior vermiform process of the cerebellum and the posterior border of the corpus callosum.

The *corpora* or *tubercula quadrigemina* are four rounded eminences—gangliform bodies—disposed in pairs (*fig.* 386, D, D'). The anterior pair are larger than the posterior. The former have been distinguished as the *nates*, the latter the *testes*.* These bodies are situate further forwards than the pons, and are chiefly connected with the superior surface of each crus cerebri.

The *nates* are of a deeper grey colour than the *testes*. In this respect they resemble the optic thalami. Both pairs are similar in structure to those bodies. When cut into, they appear to consist of fibrous matter intermingled with vesicular. Thin sections examined with the microscope exhibit intricate interlacings of tubular fibres with vesicular matter interposed—a true ganglionic structure.

An important fact deserves special notice as indicating that vesicular matter is found in

* In reference to these absurd appellations Willis has the following remark: "Prominentia orbicularis—quarum usus longè nobilior videtur, quam ut viliora ista natium et testium nomina mereantur."

these bodies in considerable quantity. The pia mater which adheres to their surface abounds in minute bloodvessels, and in separating it these are seen to penetrate the tubercles in vast numbers. This layer of pia mater contributes to form the velum interpositum.

The quadrigeminal bodies are the analogues of the optic lobes in birds, reptiles, and fishes. In these classes there is only a single pair of tubercles. They are of considerable size in birds, and form a conspicuous portion of their encephalon. The division into four takes place only in Mammalia. The anterior are the larger in herbivorous animals, the posterior in the Carnivora. In most quadrupeds these bodies are concealed from view by the posterior lobes of the brain; but in Rodentia they are exposed in consequence of the imperfect development of the brain in the backward direction.

The quadrigeminal bodies rest upon two processes of fibrous matter, which extend backwards to the median lobe of the cerebellum, and forwards to the optic thalami. These processes form a connection between the thalami and the quadrigeminal bodies and the cerebellum. They have been variously designated *processus cerebelli ad testes*, *processus cerebelli ad corpora quadrigemina*, *processus cerebelli ad cerebrum*.

The valve of Vieussens intervenes between these processes, and closes the fourth ventricle at its upper part.

A longitudinal groove separates the right and left pair of quadrigeminal bodies. The anterior extremity of this groove forms an expanded and somewhat flattened surface on which rests the pineal gland (*fig. 386, S*). From the posterior extremity a small band extends to the valve of Vieussens, called *frenum*. An incision made vertically downwards along the course of this groove exposes the canal through which the fourth ventricle and the third communicate (*iter a tertio ad quartum ventriculolum*). This canal communicates with the posterior part of the third ventricle by an opening which is situate beneath the posterior commissure, and with the superior extremity of the fourth ventricle beneath the valve of Vieussens.

The fourth pair of nerves are seen upon this surface, attaching themselves to the *processus cerebelli ad testes*, or to the Vieussenian valve, or to the posterior pair of quadrigeminal bodies.

Besides the anterior pyramids, the olivary columns are continued through the mesocephale to form with the former the *crura cerebri*. These columns are exposed along the floor of the fourth ventricle; higher up, however, they are surrounded by a lightish grey matter, form the superior stratum of each *crus cerebri*, separated from the quadrigeminal tubercles by the *processus cerebelli*, and finally merge into the optic thalami. Their course is well displayed in *fig. 380*, where *f* represents the olivary columns, *t* the *processus cerebelli ad testes*, and *v* the pons penetrated by *p*, the pyramids.

The olivary columns retain their greyish hue in their upward course. Their cylindrical form is very apparent on the floor of the fourth ventricle; but it is still more obvious on viewing

a transverse section, when each olivary column appears as a cylinder, to be distinguished from the rest by its roundness and its peculiar colour.

No other mode of dissection conveys so much knowledge of the anatomy of this part as a transverse section, carried from above downwards through either pair of quadrigeminal bodies, and inclined a little backwards, so as to pass through the pons. The parts which may be observed on such a section, enumerated from above downwards,—are, 1, either pair of quadrigeminal tubercles; 2, between and beneath them, the *iter cut across*; 3, on either side of this, fibrous matter; 4, below this on each side, the section of each olivary column; 5, planes of transverse fibres interlacing with longitudinal ones, and grey matter between the planes; 6, transverse fibres forming the pons Varolii.

Fig. 388.



Plan of a transverse vertical section of the mesocephale anterior to the pons, passing through the *crus cerebri*.

p, *iter a tertio ad quartum ventriculolum*. This is surmounted by a pair of the quadrigeminal tubercles.

i, *i*, olivary columns.

n, *locus niger*.

a, the inferior plane of fibres diverging upwards, which are continuous with the anterior pyramids.

From the preceding description of the mesocephale it may be concluded that two classes of elements enter into its formation. These are *intrinsic* and *extrinsic*. The former consists in the masses of vesicular matter, with which the fibrous matter, whatever be its course, is intimately connected. Such are the grey matter of the quadrigeminal bodies; that light grey matter which surrounds the olivary columns in their upward course; the darker matter which intervenes between the transverse fibrous lamellæ; and more in front, that which forms the *locus niger* of the *crus cerebri*.

The *extrinsic* elements are those which pass through this segment, being continuous with some portion of a neighbouring segment, or serving to connect the grey matter of the mesocephale with the hemispheres of the cerebrum or cerebellum, or with the medulla oblongata. The fibres which form the inferior layer of the pons are perhaps the only element that does not connect itself in some way with the grey matter of the mesocephale, since they seem simply to pass across from one *crus cerebelli* to the other. The deeper transverse fibres, the pyramids, the olivary columns, the pro-

cessus cerebelli ad testes, all connect neighbouring parts with the intrinsic matter of the mesocephale.

It is plain, then, that anatomy affords abundant grounds for the conclusion, that the mesocephale must be regarded as a distinct centre, connected by numerous bonds of union with the other segments of the brain.

If further proof of this were wanting, it would be found in the connexion of two important nerves with this segment. These are the fifth and the fourth pair. The former penetrate between the superficial fibres of the pons which spread out upon the crus cerebelli; the latter are connected with the superior surface of the mesocephale.

OF THE CEREBELLUM.—(παρεγκεφαλις, οπισθιος εγκεφαλις; Fr. *cervelet*; Germ. *Kleine Gehirn*.) This remarkable portion of the encephalon, so called from its general resemblance to the cerebrum, of which it is, as it were, the diminutive, is situate behind the mesocephale and medulla oblongata. It is lodged in a compartment of the cranium, the floor of which is formed by the fossæ of the occipital bone, and which is separated from the cavity occupied by the cerebrum, by the horizontal process of the dura mater, previously described as the *tentorium cerebelli*. This process forms a partition between the inferior surface of the posterior lobes and the superior surface of the cerebellum.

The cerebellum, like the cerebrum, is at its highest point of development in the human subject. It exists as a very distinct portion of the encephalon in all the classes of vertebrate animals, and exhibits a marked gradation of increase from Fishes, through Reptiles and Birds, up to Mammals.

In Fishes and Reptiles it consists of a single lobe, overhanging the posterior surface of the medulla oblongata, and closing the fourth ventricle partially like a valve. It is, in general in these classes, smooth on its surface, and exhibits no complication of structure, no subdivision into laminae. But in the sharks a manifest increase in size and an incipient lamellar arrangement are distinctly observable, which shew that in them this organ is more highly developed than in any other fishes.

In birds a similar complication of structure takes place to a much greater extent, and a lateral lobe or appendage is added on each side to the single central organ which constitutes the cerebellum of fishes and reptiles. And in the mammiferous series, the lateral lobes along with the central portion experience a progressive augmentation of size (proportionally to the body), and a corresponding complexity of structure up to the quadrumana and man.

The best and most obvious subdivision of the human cerebellum is into the *median lobe* and the *lateral lobes* or *hemispheres*. The former is the fundamental and primitive portion of the organ; the latter, although each exceeds the median lobe in size, and therefore they conjointly form far the largest portion of the cerebellum, are appendages, which in man assume great physiological importance. The median lobe has likewise been called *vermi-*

form process, the upper and lower laminae being distinguished as the *superior* and *inferior vermiform processes*.

From the tables already given it would appear that the cerebrum is to the cerebellum in the proportion of 8 or 9 to 1 in the adult, and in the infant, according to Chaussier, as 16 or 18 to 1. The average weight of the cerebellum is, according to Professor Reid's researches, 5 oz. 4 dr. in the male, and 4 oz. 12 dr. in the female.

The cerebellum seems to keep pace, in its development, with that of the cerebrum. It attains its greatest size, both in male and female, at the same age as the cerebrum. At the most advanced ages, however, it seems to diminish with greater rapidity than that organ.

Some variety appears to occur as regards the relative development of cerebellum to cerebrum in the adult. Chaussier remarks that he had in some instances found the cerebellum equal to a seventh or a sixth part of the weight of the cerebrum, but rarely the eleventh or twelfth.

There do not appear to be any good grounds for the assertion that the cerebellum is more developed in proportion to the brain in the female than in the male. Professor Reid's extensive series of researches show, beyond all question, that it maintains the same proportionate bulk in both sexes.

It has also been asserted that castration, or disease of the genital organs, such as would destroy the generative instinct, causes wasting of the cerebellum. If both testicles be removed, the whole cerebellum, it is said, degenerates; if only one, the hemisphere of the opposite side is affected.

The most complete refutation of this assertion is afforded by M. Leuret's series of observations of the brains of geldings and entire horses. These researches, indeed, shew that in stallions the cerebellum is proportionally smaller than in mares or geldings, and that in geldings it is larger than in mares. It is very evident from them that mutilation of the sexual organs does not cause degeneration of the cerebellum.

The shape of the cerebellum is that of "an ellipsoid flattened from above downwards."* Its principal diameter, which is transverse, is from three-and-a-half to four inches in length; the antero-posterior diameter is from two inches to two inches and a half; the anterior part is about two inches in thickness; whilst near its posterior edge it does not measure above half an inch.

At its anterior edge the cerebellum is notched, and receives fibres by which it is connected to the cerebrum and mesocephale. This notch is of considerable transverse extent, and is semilunar in shape. The greater portion of the posterior part of the mesocephale corresponds to it. By Reil this is called the *semilunar fissure*. In it we find several parts which the anatomist should study; namely, on the highest plane, the processus cerebelli ad testes, sepa-

* Cruveilhier.

Fig. 389.

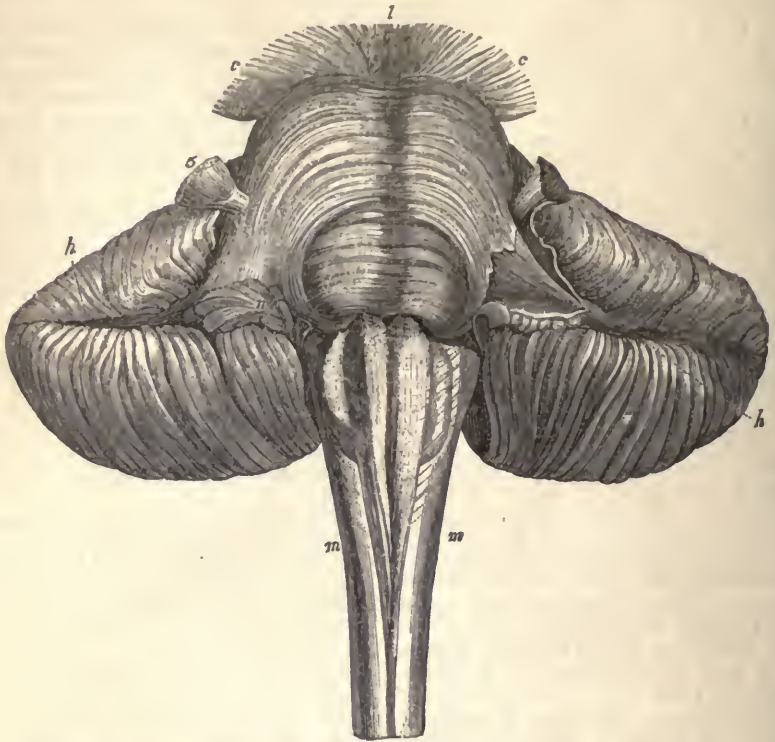

Front view of the cerebellum, with medulla oblongata and mesencephale. (After Foville.)

m, m, medulla oblongata.

h, h, semilunar fissure.

5, fifth nerve. On the left side a layer appears to be extended from this nerve which contributes to form the *crus cerebelli*.

rated by the valve of Vieussens, and, beneath these, the fibres of the restiform columns, and the right and left extremities of the pons Varolii, all of which combine to form the *crus cerebelli* or central stem of each lateral lobe.

The posterior margin is interrupted in its middle by a vertical notch, which divides it into a right and left portion. This notch is wider in front than behind, whence Reil called it the *purse-like fissure*. The term *posterior notch* is preferable. It receives the *falx cerebelli*, and at its bottom we observe a continuity between the superior and inferior laminae of the median lobe of the cerebellum.

The superior surface of the cerebellum is slightly convex, inclined backwards and downwards. It terminates in front by a concave margin, which overlaps the parts contained in the semilunar fissure. This surface is more convex along the middle than on either side. In the latter situations it is inclined and nearly plane; but in the former it resembles more the surface of a cylinder. This middle portion corresponds to what is commonly called the *superior vermiform process*: it is in fact the upper surface of the median lobe of the cerebellum.

On its inferior surface the subdivision of the

cerebellum into two symmetrical portions is very apparent, by reason of the existence of a deep fissure which proceeds from before backwards along the median line, and is continuous behind with the posterior notch. This fissure is called the *valley* (*vallecula*, Haller; *grande scissure mediane du cervelet*). It separates the hemispheres of the cerebellum, each of which presents a very convex surface, corresponding to each occipital fossa. The arachnoid membrane is extended from one to the other, towards the posterior part of the fissure, leaving a considerable space between it and the pia mater, which is traversed by some fine bundles of fibrous tissue and occupied by subarachnoid fluid. This space has already been referred to as the *posterior confus* of Majendie.

The anterior part of this fissure receives the upper and posterior portion of the medulla oblongata. The remainder of it is occupied by the inferior surface of the median lobe of the cerebellum, presenting a remarkable cruciform arrangement, which will be presently described.

Another very remarkable fissure requires a special notice. It is horizontal, and passes into the substance of the cerebellum, dividing it into an upper and an inferior portion. By

inserting the handle of a knife along the posterior margin of the cerebellum, this fissure may be shewn to pass forwards to a considerable depth, and to communicate on each side with the semilunar fissure, whilst it is interrupted in the middle posteriorly, by the notch. Its inner surface is lined by a process of pia mater, which sinks into it.

The right and left cerebellar hemispheres exhibit a general symmetry, which is, however, not always perfect, as a manifest difference is sometimes observable in their sizes. And a corresponding want of symmetry may be frequently seen in the right and left fossæ of the occipital bone.

Both the hemispheres and the median lobe are composed of an assemblage of laminæ closely applied to each other. Each lamina consists of a thin layer of white or fibrous matter, between two of grey or vesicular substance, which are continuous along the outer margin of the former. Thus the exterior of the cerebellum consists of a stratum of vesicular matter, which forms a cortex to the enclosed white or fibrous substance. The laminæ are separated from each other by fissures, and they are covered by pia mater, which adheres closely to them, and penetrates to the floors of the fissures.

The laminæ are collected into sets on the superior as well as on the inferior surface. Each set forms a lobe. Each lobe is surrounded by a deep fissure, which separates it from the next adjacent lobes.

It is necessary to distinguish the fissures which separate the laminæ from those by which the lobes are bounded. The former are very shallow: the latter are deep, and penetrate quite to the central stem of the hemisphere.

By removing the pia mater carefully from the surface of the hemispheres, and from the deep fissures, the shape and boundaries of the lobes may be clearly demonstrated. Or if a vertical section of a hemisphere be made, the deep fissures may be readily distinguished from the superficial ones which separate the laminæ; and in this way also the lobes may be demonstrated.

The floor of each deep fissure is formed by white matter. And as the deep fissures intervene between the lobes, laminæ of the lobes constitute their walls, and the superficial fissures which separate these laminæ open into them.

On the superior surface of the cerebellum two principal lobes may be distinguished. These are the *square lobe* and the *posterior superior lobe*, according to the nomenclature of Reil, whose descriptions cannot be surpassed in minuteness or accuracy. (*Fig. 390, A, P.*)

The anterior margin of the square lobe overhangs the semilunar fissure; its posterior margin is a little behind the level of the floor of the posterior notch. By careful separation of its laminæ or by a vertical section, it may be shewn to consist of eight lobules, each having a stem of fibrous matter derived from the central one of the hemisphere.

The posterior superior lobe (*P, fig. 390*) forms the posterior part of the superior surface of the cerebellum; its posterior margin is that of the hemisphere; the horizontal fissure separates it from the posterior inferior lobe. It is separated from its fellow of the opposite side by the posterior notch.

On the inferior surface of each hemisphere the following lobes are readily distinguishable. (*Fig. 391.*) We enumerate them, passing from before backwards.

1. The *amygdala*, so called from its resemblance to an enlarged tonsil. This and its fellow of the opposite side form the lateral boundaries of the anterior extremity of the valley, and are in great part covered by the medulla oblongata.

2. Behind the amygdala is the *biventral lobe*, wedge-shaped, narrow towards the valley, wide towards the semilunar fissure. Its laminæ are curved with their concavity forwards and inwards, and it is united with its fellow of the opposite side by laminæ which cross the valley forming part of the inferior vermiform process.

3. The *slender lobe*, which consists of a few laminæ curved parallel to the posterior ones of the biventral lobe.

4. The *inferior and posterior lobe*, which extends to the posterior edge of the hemisphere. The inner margin of each of these lobes constitutes the lateral boundaries of the posterior notch.

Such is the constant disposition of the superior and inferior surfaces of the cerebellum. A defect of symmetry is sometimes apparent in the inequality of corresponding lobes; but those above enumerated are always present. So definite an arrangement must obviously have some physiological import. What that may be it is impossible even to conjecture, and we must be, for the present, content with a concise statement of the facts of the anatomy. Some analogy exists between this arrangement and that of the convolutions on the surface of the brain, many of which exhibit a constancy of position and form quite as remarkable.

The median portion of the cerebellum is also composed of laminæ, which are continuous with those of the hemispheres, but their arrangement on the superior and inferior surfaces is so different as to demand a separate description. On the superior surface the laminæ are separated from each other by fissures, in the same way as those which constitute the hemispheres, and they are collected into sets forming lobes which correspond to and connect those of the lateral hemispheres. These laminæ are curved, their anterior margin being very slightly convex (*fig. 390*). The edges of these laminæ, as they lie in close apposition, resemble the segments or rings of a worm; whence the term *vermiform* has been applied to this as well as the inferior surface of the median lobe. The laminæ take for the most part a vertical direction, with the exception of the anterior and posterior ones, which pass gradually to the horizontal, the free margins of the former being directed forwards and those of the latter backwards. The pos-

Fig. 390.

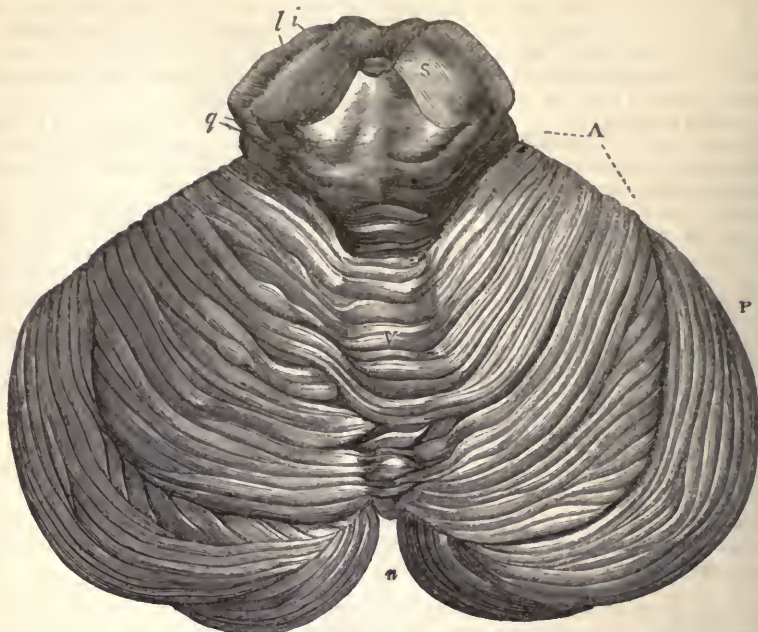

Superior surface of the cerebellum.

A, the square lobe; P, the posterior superior lobe; S, superior layer of the crus cerebri; q, tubercula quadrigemina; l, locus niger; i, inferior layer of the crus cerebri.

terior laminae form the floor of the posterior notch: the anterior form, by their adhesion to each other, the layer known by the name of *valve of Vieussens*, which fills up the interval between the *processus cerebelli ad testes*.

The laminae which form the superior surface of the median lobe, (or the superior vermiform process,) are considerably fewer than those of the hemispheres. This explains the less depth of the median lobe, when measured from before backwards, than of the hemispheres. Two or more of the laminae of the latter are united to a single lamina of the former, and thus the superior vermiform process serves as a transverse commissure to the superior laminae of the hemispheres.

The inferior surface of the median lobe, or *inferior vermiform process*, is likewise composed of laminae, which take a transverse direction and present a free convex border, with some resemblance to the rings of a worm in action. (Fig. 391.) These laminae are not all of equal transverse extent. The middle and posterior are the broadest; the anterior gradually diminish in size. Hence the body which results from the conjunction of all the laminae has a triangular form, its apex being anterior and its base posterior, corresponding to the notch between the hemispheres. The laminae which occupy its middle have a greater depth than the rest, and consequently the body is more prominent at this situation.

Certain deep fissures divide the inferior vermiform process into segments which evidently correspond with and connect the lobes into

which the hemispheres are subdivided on their inferior surface.

These segments may be very readily distinguished from each other, and the names which the accurate Reil has given them are sufficiently appropriate. By separating each segment from the adjacent ones and tracing its lateral relations, the anatomist may form a better idea than by any other means of the way in which this portion of the cerebellum is connected with the hemispheres.

The anterior extremity of the inferior vermiform process projects into the cavity of the fourth ventricle, and serves to close it at its inferior extremity. It is a pointed process, furrowed transversely, continuous by its base with the rest of the vermiform process. Reil has named it the *Nodule*. From either side of it a valve-like membrane of exquisite delicacy extends forwards and outwards towards a lobule which is attached to each crus cerebelli near to the origin of the auditory nerve. These membranes resemble very much in shape the semilunar valves of the aorta. By their attached margin they adhere to the crus cerebelli, and their free margin projects into the cavity of the fourth ventricle. Their inner extremities adhere to the nodule, and are connected to each other by a thin membrane of precisely similar texture which is a commissure to them. Reil gives to the two membranes and their intermediate connecting one the name of *posterior medullary velum*.* The lateral membranes were first de-

* The valve of Vieussens is the anterior medullary velum.

scribed by Tarin and Malacarne. When the fourth ventricle has been carefully opened in a recent cerebellum, it is very easy to demonstrate them by passing the handle of a knife under them.

The structure of these lateral wings of the inferior medullary velum is readily ascertained. Their delicacy is such that they admit of being examined by the microscope without pressure or other manipulation. They consist of tubular fibres of various sizes, taking a transverse direction, that, namely, of the long diameter of each wing, covered by a layer of nucleus-like particles as an epithelium. They seem to connect the nodule to the small lobules of the pneumo-gastric nerve above mentioned (the *flocks* of Reil), or to connect those lobules themselves as a commissure.*

The nodule pushes before it, into the fourth ventricle, a fold of the pia mater, connected with which on either side are several small granulations, or *Pachionian bodies*. It is called the *choroid plexus* of the fourth ventricle. We can easily trace it to be continuous with the pia mater which covers the lobules of the seventh pair of nerves.

Next to the nodule, below and behind it, is a small lobe, called by Reil the *spigot* (*Zapfen*), with a pointed extremity directed downwards and forwards. It consists of several small laminae separated by their fissures. Behind it is a larger lobule, which forms the most prominent

portion of the inferior vermiform process, called by Reil, from its form, the *pyramid*. Its apex is directed downwards and backwards, and it likewise consists of numerous small laminae.

These lobules of the inferior portion of the median lobe serve to connect others of the lateral hemispheres. The *spigot* connects the almond-like lobes; the *pyramid* the biventral and the slender lobes.

Posterior to the pyramid are a series of laminae which extend to the posterior notch and form its floor. These pass directly from one side to the other, their free margin being convex and directed backwards. They connect the posterior inferior lobes. And some of the most anterior of them, which do not project to the surface, connect the slender lobes as well as some of the anterior laminae of the posterior inferior lobes. These latter laminae of the inferior vermiform process, Reil distinguishes by the name of *long* and *hidden commissure* (*langen verdeckten Commissur*), and the former constitute his *short and exposed commissure* (*Kurzen und sichtbaren Commissur*).

Above the last-named commissure is a single lamina which forms a line of demarcation between the inferior and the superior vermiform processes, serving to connect the upper and posterior lobes of the hemispheres. This is the *single commissure* (*einfache quer Commissur*).

It will serve to elucidate the foregoing necessarily intricate description, if I sum up with

Fig. 391.

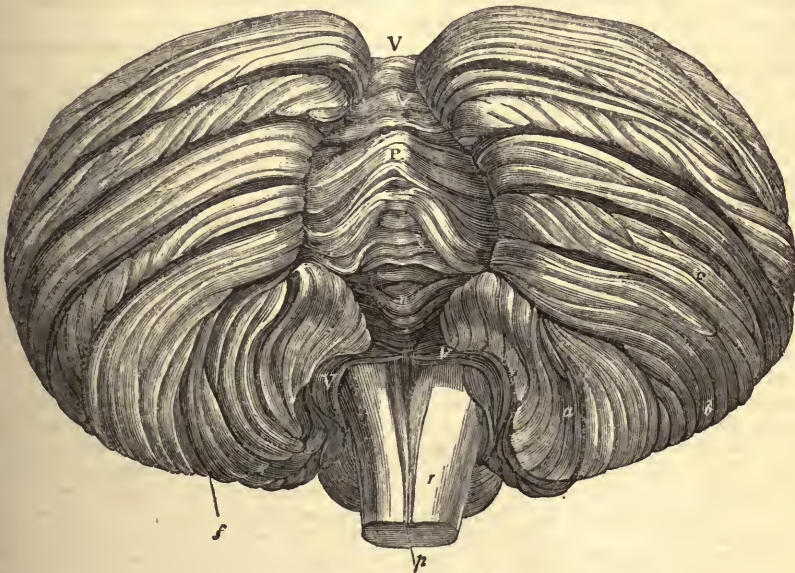

Inferior surface of the cerebellum.

V, inferior vermiform process; p, posterior pyramids; r, restiform bodies.

the following enumeration of the lobes of the hemispheres, specifying at the same time the commissures by which they are connected, i. e.

the lobes of the superior and inferior vermiform processes which serve that purpose.

1. On the superior surface of the hemispheres.

a. The square lobes, consisting of eight lobules, which are connected by as many, or nearly so, of the superior vermiform process.

* Although it does not appear that Reil used the microscope, his statement respecting the structure of these wings is perfectly correct.

b. *The upper and posterior lobes*, connected by the single commissure, to be sought for on the floor of the posterior notch.

2. On the inferior surface of the hemispheres.

a. *The amygdala*, united by the spigot.

b. *The biventral lobes*.

c. *The slender lobes*.

The biventral lobes and the anterior laminae of the slender lobes are united by the pyramid.

d. *The posterior inferior lobes*, connected by the short and exposed and the long and hidden commissures.

The flocks or lobules of the pneumogastric nerve, (*lobule of the auditory nerve*, Foville,) which are situate altogether anterior to the hemispheres and attached to each crus, are united by the posterior medullary velum, and through it appear to have some connection with the most anterior portion of the inferior vermiform process.

A vertical section of either hemisphere of the cerebellum or of its median lobe displays its structure, and serves further to demonstrate the subdivision into lobes above described. When either hemisphere is cut in the vertical direction, the surface of the section displays a beautiful ramification of fibrous matter, the smaller branches of which are enveloped by laminae of grey matter. This appearance has such a resemblance to the trunk of a tree with its boughs and branches, that it early received and has continued to retain the name of *arbor vitae*. The trunk of the tree is represented by a central nucleus of white matter, from the upper and lower surfaces of which branch off, some at a right, others at an acute angle, several laminae, each of which forms the parent stem of a number of other branches. Each of the primary branches is the foundation or central stem of a lobule. Laminae of fibrous matter are seen branching from both sides of it immediately after its separation from the nucleus. Sometimes the primary branch bifurcates, and each division of it forms the stem of what may be called a sub-lobule. The ultimate branchings are covered by a layer of grey matter. If we suppose that one of the primary branches is composed of a certain number of laminae of fibrous matter, the secondary ramifications from it will in a great degree correspond. In most instances these secondary branches subdivide into two or more tertiary ones, which, as well as the branch from which they spring, are enclosed in grey matter. (*Figs. 380, 386.*)

A vertical section of the median lobe gives quite a similar appearance to that of the hemispheres. The central nucleus breaks up into primary branches, which become the centre of the lobules of which it consists. (*Figs. 386, 393.*)

The ramifications of the central nucleus, whether of the median lobe or of the hemispheres, separate from it only in the vertical plane or from before backwards; in the latter direction, however, to a very slight extent. Hence these branches are directed only upwards, or downwards, or backwards. The

fibrous matter of the median lobe is continuous, without any line of demarcation, with that of the hemispheric lobules. By reason of this disposition of the fibrous matter, the surface which is exposed by a horizontal section through the entire cerebellum, presents a very different appearance from that which results from a vertical section. It consists of a plane of fibrous matter bounded on the sides and behind by a narrow cortex of grey matter.

The white matter consists exclusively of fibres, chiefly of the tubular kind and of all degrees of size. These, in the more distant ramifications, penetrate the vesicular matter of their grey cortex, and form some unknown connection with its elements. The grey matter consists of three layers, readily distinguishable by the naked eye from their difference of colour. The external layer is the darkest, and consists chiefly of granular and vesicular matter. The next or intermediate layer is of a light colour, and is composed of a stratum of fine nucleus-like particles. The third layer has the greatest thickness, and is immediately in contact with the fibrous matter; it is intermediate in point of colour to the other two, and consists of numerous vesicles of the caudate kind, especially with branching processes and nerve-tubes of all sizes. The dark colour of the external layer is doubtless owing in a great measure to the great numbers of capillary vessels which enter it; the greater paleness of the inner stratum is to be attributed to the intermixture of the white fibres, whilst the light colour of the middle stratum is intrinsic. From the usual dependent position of the cerebellum in the dead body, it always appears to contain more blood than the cerebrum.

Corpus dentatum.—If, in making a vertical section of either hemisphere of the cerebellum, the incision be made so as to leave two-thirds of the hemisphere on its outside, a peculiarity will be observed on the surface of the section which deserves a separate consideration. The central white nucleus is interrupted by a very remarkable undulating line of vesicular matter, which is convex towards the posterior margin of the hemisphere, but open in front towards the crus cerebelli.

This constitutes the *corpus dentatum* or *rhomboideum* of the cerebellum. It presents a remarkable resemblance to the structure of the same name which is met with in the olivary body of the medulla oblongata. It is evidently a capsule of vesicular matter which is enclosed in the inner third of the substance of the central white nucleus of the cerebellar hemisphere, being nearer its superior than its inferior surface. The peculiar undulating arrangement of it doubtless has reference to the accommodation of a certain extent of surface in a limited space. The fibrous matter enclosed by it seems derived from the process cerebelli and from the restiform body.

The central stem of fibrous matter to which the several lobules, both of the hemispheres and the median lobe of the cerebellum, adhere, (*crus cerebelli*,) is formed by three bundles of fibres, each situate on a different plane. These

are the *peduncles of the crus cerebelli*. Through them the cerebellum forms a connection with other parts of the encephalon. The superior layer or peduncle is a bundle of fibres which extends to the corpora quadrigemina, and may be traced beneath them to the optic thalami. These are the *processus cerebelli ad testes*, but from their being obviously a medium of connection between the cerebellum and the cerebrum, they may be better named *cerebro-cerebellar commissures*. It is worthy of remark, that these are the only fibres which appear to connect these two segments of the brain. The middle layer is continuous with the restiform bodies, *processus cerebelli ad medullam oblongatam*. And the inferior layer is evidently derived from the transverse fibres of the pons Varolii, which thus pass from one hemisphere to the other, and constitute a great commissure to the cerebellar hemispheres. These fibres, moreover, connect each hemisphere to the mesocephale (*fig. 380, t, r, v*).

From this triple constitution of the *crus cerebelli*, it is plain that the cerebellum may exert an influence upon, or be affected by the optic thalami or quadrigeminal bodies, the restiform columns, or the mesocephale.

Of the fourth ventricle.—This is a rhomboidal cavity, situated at the upper and posterior part of the medulla oblongata, and extending over part of the superior surface of the mesocephale. It is limited superiorly by the posterior margin of the testes, and inferiorly by the superior blunt extremity of the posterior pyramids. Its two lateral angles correspond to the entrance of the restiform bodies into the *crura cerebelli*. In fact, it is formed by the divergence of the restiform columns in their ascent to the hemispheres of the cerebellum. The median lobe of the cerebellum lies over the fourth ventricle, and conceals it from view. The anterior lobule of the inferior vermiciform process, the *nodule*, projects into it, and closes it below. On either side of this lobule a process of pia mater, with small granulations upon it, is found. These processes are the *choroid plexuses* of the fourth ventricle. Around these and thence on to the nodule, the

proper membrane of the ventricle is reflected, and thus its cavity is shut out from any communication with the subarachnoid cavity. A vertical section in the median plane, or a little to one side of it, displays this arrangement well. (*Fig. 392.*)

Along the floor of the fourth ventricle we find the central or olivary columns of the medulla oblongata extending upwards to the optic thalami. A fissure, continuous with the posterior median fissure, separates these columns, and terminates above in a canal which penetrates the mesocephale, to reach the third ventricle: *iter a tertio ad quartum ventriculum* or *aqueduct of Sylvius*. On either side of the fissure certain bundles of white fibres, continuous with the auditory nerves, join it at right angles, crossing over the olivary columns. This fissure, with its white fibres on each side, has been compared to a pen with its barbs, and hence called *calamus scriptorius*.

The fourth ventricle, although sometimes called the ventricle of the cerebellum, properly belongs to the medulla oblongata. It is present in all the vertebrate classes, and in size bears a direct proportion to that of the medulla itself.

OF THE HEMISPHERES OF THE BRAIN.—A mass of fibrous matter, covered on its exterior by a convoluted layer of vesicular matter, inflected towards the mesial plane above and below a pair of gangliform bodies, (*Optic thalami and corpora striata*), which it thus encloses in a cavity or ventricle—this, with certain fibres connecting its anterior to its posterior parts, forms a cerebral hemisphere. The hemispheres of opposite sides are applied to one another along the mesial plane, leaving the fissure-like interval called the third ventricle; and they are united by a plane of transverse fibres, the greater part of which is placed above that ventricle, but which bends down anteriorly as well as posteriorly, closing the fissure at those situations.

Of the convolutions.—That which first attracts attention in connection with the cerebral hemispheres, as affording the highest physiological as well as anatomical interest, is their convoluted surface. This can only be well displayed by stripping off the pia mater. The appearance which is then presented has been variously described by different writers. It has always seemed to me to resemble the folded surface formed by the mucous membrane of the stomach when the muscular coat is very much contracted. The *rugæ* of that membrane become enormously developed by the excessive contraction of the muscular coat: the mucous membrane not possessing any contractile power is thrown into thin folds to adapt it to the diminished capacity of the stomach. Its folded state indicates a great disproportion between the extent of the mucous surface and that of the muscular tunic. If both



Vertical section of the median lobe of cerebellum, mesocephale, and medulla oblongata, to shew the fourth ventricle.

o, corpus dentatum; *f*, posterior surface of medulla oblongata; *p*, pons Varolii; *a*, processus cerebelli ad testes; *v*, cavity of the fourth ventricle.

surfaces were equal, neither of them would be thrown into folds. In examining the surface called *centrum ovale*, which is exposed by a horizontal section through the hemisphere above the level of the corpus callosum, we obtain an explanation of the formation of the convoluted surface of the brain. That plane of fibrous matter is surrounded by an undulating margin of vesicular matter, the foldings of which give rise to the convoluted appearance of the cerebral surface. The fibrous matter is adapted to this irregular surface, not by any similar folding, but by the prolongation of its fibres into the concavities of the folds. It is only by means of these prolongations that an equality obtains between the surface of grey matter and that of fibrous matter which it covers. In brains devoid of convolutions, the vesicular and fibrous surfaces are applied to each other as two layers disposed in concentric circles. There are no irregularities in either one or the other. But any increase in the extent of the grey surface involves a corresponding complication in that of the fibrous matter, which is effected by the prolongation of the fibres at certain situations. Were we to suppose two brains in which the quantity of fibrous matter in the hemispheres was equal, the quantity of grey matter in one might be increased considerably, and therefore become convoluted without involving any other alteration in the fibrous matter than the elongation

of certain bundles of fibres at particular situations.

The existence of convolutions on the surface of the hemispheres, as contrasted with the absence of them, indicates an increase in the development of the dynamic matter. A convoluted brain, even although actually smaller than one with a smooth surface, would yet indicate a higher degree of mental power, inasmuch as it possesses a larger quantity of the vesicular matter relatively to its fibrous matter.

Cerebral convolutions are wanting in all the classes below Mammalia. They are likewise absent from the brains of many animals of the families Rodentia, Cheiroptera, Insectivora, some of the Marsupialia, and Monotremata. The brains of these Mammalia resemble very closely, as regards the characters of the cerebral hemispheres, the brain of Birds. There is not a trace of a convolution upon them, and the only fissure is the imperfectly developed one of Sylvius. The squirrel, the bat, the mole afford examples of brains deficient in convolutions. In some genera of the families Insectivora and Marsupialia, however, we find an approach to the convoluted cerebral surface in certain depressions marked on the exterior of each hemisphere. The fissure of Sylvius is more developed, and certain depressions, taking for the most part a longitudinal course, are seen on the surface of each hemisphere. The brains

Fig. 393.



Vertical section of the adult human brain. (After Arnold.)

The position of the internal convolution with reference to the corpus callosum is well displayed. The median lobe of the cerebellum has been cut through, and the fourth ventricle exposed. *a, a, a*, internal convolution, (*d'ourlet*, Foville); *c*, corpus callosum; *o*, fornix; *n*, septum lucidum; *f*, pineal body; *i*, anterior commissure; *h*, hypophysis, or pituitary body; *t*, pons Varolii; *II*, second pair of optic nerves; *IV*, fourth ventricle.

Fig. 394.



Superior surface of the right hemisphere of the adult human brain.

The undulating form of many of the convolutions is very well seen, and the general characters of the convoluted surface are displayed.

of the rabbit, the beaver, the guinea-pig, the agouti shew these fissures. They are generally regular in different individuals of the same genus, and they are symmetrical, i. e., of the same length and direction, and occupy the same place on each hemisphere.

Leuret remarks, in reference to the dogma of Gall and Spurzheim, that the presence and number of the convolutions are in direct relation to the volume of the brain, that such is far from being universally the case; and I am glad to refer to so excellent an authority in confirmation of the view which I have advocated respecting the true signification of the cerebral convolutions. According to this anatomist, the ferret, which has several well-marked convolutions on each hemisphere, has a brain no larger than that of the squirrel, which is entirely devoid of them, and which has not even the few fissures which faintly indicate their first development in the brains of the rabbit, the beaver, the agouti, &c. And these animals last named have the brain actually larger than that of the cat, the pole-cat, the roussette, (*Pteropus vulgaris*,) the unau, (*Bradypus didactylus*,) the sloth, (*Bradypus tridactylus*,) and the pangolin, all of which possess convolutions.

All mammiferous animals, excepting those mentioned in the preceding paragraphs, have convolutions which exhibit more or less of complication. This complication has evidently no connection with the general organization of the animal, inasmuch as we find animals, in the same family with those which possess numerous convolutions, exhibiting a very slight development of them. The monkeys, the dolphin, the elephant, exhibit the most numerous convolutions of any of the Mammalia inferior to man, in whose brain the convoluted surface reaches its highest point.

Each fold on the surface of the brain is ordinarily called a *convolution*, whatever be its position, size, or direction. It consists of a fold of grey matter, enclosing a process of

white or fibrous matter. On each side of it is a sulcus or groove, in which we find the same elements, a fold of grey or vesicular matter—concave externally, convex internally—the fibrous matter adhering to its convex surface. As the convolution exhibits no essential difference of structure from the sulcus, it is plain that the former portion of the brain's surface cannot differ in physiological office from the latter. We describe particular convolutions, not because they are to be regarded as endowed with special functions distinct from the less prominent portions of the cerebral surface, the sulci, which are continuous and identical in structure with them, but because they afford good indications of a particular arrangement of the surface of the hemispheres by which one brain may be conveniently compared with another, whether they belong to the same or to different groups of animals.

The folded arrangement of the surface of the hemispheres, dependent as it is upon the grey matter, is evidently destined to bring the central and deep-seated parts of the hemispheres into union with a large extent of vesicular surface.

That the disposition of the convolutions, like that of all other parts of animal bodies, follows a particular law, is well illustrated by comparing the brains of different groups of animals, in their gradation from the more simple to the more complex.

M. Leuret very justly makes a distinction between those convolutions which are constant, and to be found throughout the whole series of convoluted brains, occupying the same position, and differing only in size and extent of connections, and those which are not constant, even in the brains of the same group of animals, but are dependent on the extent of the primary ones, and the connections which they form with others near them. According to this idea we may classify the convolutions as *primary* and *secondary*.

The primary convolutions are all formed after

one type. Of this, as M. Leuret suggests, the brain of the fox may be taken as the basis. The fissure of Sylvius is well marked in this brain; it is bounded by a prominent convolution, which encloses it above, below, and behind—thus forming a curve, the concavity of which is directed forwards and downwards. Above and behind this we find a second convolution forming a similar curve and parallel to the first. It exhibits a slight undulation, and is marked by a short fissure—signs of advancing complication. Still further back and upwards there is a third convolution, parallel and curved similarly to the second; this bifurcates at one point. Above all, near the summit of the hemisphere, a fourth is found disposed in the same curved manner, but exhibiting some sinuosities or undulations at its anterior portion. A fifth convolution exists on the inferior surface of the anterior lobe and rests upon the roof of the orbit. Leuret designates it the *supra-orbital convolution*. The sixth convolution is of great extent; the principal portion of it is found on the inner surface of each hemisphere above the corpus callosum; in front it bends downwards and backwards to the fissure of Sylvius, and behind it extends to the middle lobe and forms the hippocampus major. This convolution exists in a high state of development in the human brain, and has attracted very generally the attention of anatomists. Foville describes it by the name *convolution d'ourlet*.

Such is the most simple arrangement of the convolutions. The complication of this takes place by undulations being formed in the convolutions themselves, by a subdivision of them at certain situations, by the junction of neighbouring ones through smaller folds crossing the sulci between them, and in the highest classes by the addition of totally new convolutions.

Animals, whose brains have nearly the same degree of development as that of the fox, have exactly the same convolutions, differing, however, somewhat in point of size. This increase of size is denoted by undulations formed in the course of convolutions throughout more or less of their extent. The dog may be taken as an example. M. Leuret states that, in comparing the brains of several dogs together, he found with all of them the same convolutions, differing only in the extent of undulations and the number of depressions, both of which were greatest in the largest brains. The brain of a large mastiff (*chien dogue*), a good watch-dog, of such great ferocity that he attacked the person who fed him, had all the convolutions very large and much undulated, with numerous depressions in them.

A group of animals, consisting of the cats and the hyena, exhibits another stage of increase in the development of convolutions. The same type prevails as in the fox and dog; four external convolutions, one internal, and a supra-orbital. These convolutions, however, are united to each other at numerous points by means of small folds crossing the sulci. These uniting folds form the *secondary* or *supplementary* convolutions. Nearly all the primary

convolutions have supplementary ones connected with them.

A group, which includes the sheep and other ruminant animals, exhibits much more complication in the cerebral convolutions, but still preserves the same type. The undulations and the supplementary convolutions are more numerous. The primary appear less numerous because less distinct. The anterior part of the internal convolution is much increased in development, and the supra-orbital is much more complex. In the fissure of Sylvius some small convolutions are found which are the first development of those which in the human subject constitute the *insula* of Reil.

In the brain of the elephant new convolutions are added. These consist of folds passing in a perpendicular direction; the primitive convolutions always taking a longitudinal course. These latter are divided by the former into an anterior and a posterior set. Others are found above and in front of the fissure of Sylvius; three superior convolutions are found, the continuations of which backwards are situate above the internal convolution. All the convolutions of the elephant are remarkably undulating and exhibit numerous depressions. The brain of the whale is very similar to it in this respect, and both resemble that of man.

Monkeys have not the tortuous or complicated convolutions which are found in the whale and elephant. Yet the development of the hemispheres at their posterior part, the general form of the brain, the extent and inclination of the fissure of Sylvius approximate the brain of monkeys to that of man much more nearly than the whale's or elephant's, which, notwithstanding their complicated convolutions, are generally inferior in organization, and resemble the brains of other Mammalia. The internal convolution in monkeys is simple; below and behind it forms the hippocampus, from which convolutions are prolonged backwards, forming the posterior lobe. Two superior convolutions are met with above the fissure of Sylvius, between which is placed a transverse fissure very constant, called the fissure of Rolando. The orbital convolutions are largely developed.

In comparing the human brain with that of the inferior animals, we notice great exactness of symmetry between the convolutions of opposite hemispheres in the latter, and the want of it in the former. It cannot, however, be said that the convolutions of opposite hemispheres in the human subject are absolutely unsymmetrical. A careful examination will show that the same convolutions exist on each side, but apparently of different sizes, and not closely corresponding as regards situation. My meaning will be more readily understood by referring to *fig. 381*, p. 671, where the same numbers have been affixed to corresponding convolutions. No. 1 on the right has a certain general resemblance with No. 1 on the left, which would be much more perfect but for the fissure which marks the convolution of the right he-

misphere. Again, Nos. 2, on opposite sides, resemble each other so closely that their symmetrical relation cannot be doubted. The likeness, however, is impaired by slight fissures in the convolution on the left which do not exist in that on the right side. Nos. 3 and 3 evidently correspond, but that of the right side is the larger and more undulating. And it may here be remarked that this great development of the convolution marked 3 on the right side affects materially the position, relations, and shape of those in its neighbourhood, by throwing them backwards or outwards and altering their form. Thus the position and shape of convolution 4 seems evidently modified by the large posterior undulations of convolution 3. In the brain from which the figure was taken, the convolutions on the right side are evidently larger and more highly developed than those of the left. It does not appear that there is any constancy with respect to the relative size of the convolutions of the right and left side, sometimes one side predominating, sometimes the other; nor have we any clue to discover the cause of the difference between the two hemispheres, or the reason of the variation as regards predominance of size.

In the imperfectly developed brains of the infant or young child, the convolutions are quite symmetrical. They are so likewise in idiots, or persons of very inferior intellect, and, as has been already stated, in some Negro brains.

The following convolutions of the human brain are constant in their position, although they differ much in different brains in size and development.

1. *The internal convolution*, or that of the corpus callosum, called by Foville *convolution d'ourlet* (*processo cristato*, Rolando). The principal portion of this convolution is above and parallel to the corpus callosum: in front it curves down parallel to the anterior reflection of the corpus callosum, as far as the locus perforatus, connecting itself with some of the anterior convolutions. Behind it passes in a similar manner round the posterior reflexion, connecting itself with some of the posterior convolutions, and in the middle lobe forming the hippocampus major, the anterior extremity of which is situate immediately behind the fissure of Sylvius and locus perforatus. Its horizontal portion appears to be connected with some nearly vertical ones, which seem indeed to branch off from it. (*Fig. 395, O.*)

This is the most constant and regular convolution of the brain. It exhibits with its fellow of the opposite side very exact symmetry. Its inferior or concave border is smooth and uninterrupted, and forms the superior boundary of a sulcus, which intervenes between it and the surface of the corpus callosum. It forms, to use Foville's expression, a hem or selvage to the cortical layer of the cerebral hemisphere. The fibrous matter which is inclosed by the cortical layer of this convolution consists of longitudinal fibres following the same general direction, a large number of them no doubt bending inwards into the cortical layer. These fibres are evidently commissural in their office, and will be referred to by-and-by as constituting the *superior longitudinal commissure*.

The free margin of this convolution varies in

Fig. 395.



Internal surface of the left hemisphere of the brain, shewing the connections of the internal convolution and the band of longitudinal fibres by which it is formed (d'ourlet).

C, C, corpus callosum; O, O, O, internal convolution; b, septum lucidum; a, anterior commissure; f, fornix; e, superior layer of the crus cerebri; d, inferior layer of the same separated from the former by the locus niger.

The fibres of the internal convolution are seen in the middle lobe extending to the hippocampus major.

its characters in different brains, according to the degree of tortuosity it exhibits, and the number of small fissures which are met with in it. The small folds which connect it with other convolutions on the inner surface of the hemisphere vary in number, and are generally found most numerous at its posterior part. Some of these folds are not distinctly visible unless the sulcus above it has been freely opened, as they are situated quite on its floor.

2. *The convolution of the Sylvian fissure.*—This convolution forms the immediate boundary of this great fissure. We have seen its early development in the simple brain of the fox, and we may observe it gradually rising in complexity through all the intermediate stages up to the most highly developed brains. In the elephant it is remarkably tortuous, and is connected anteriorly as well as posteriorly with convolutions which pass to the anterior and superior and to the posterior part of the brain.* In man it is also very tortuous, and the numerous folds which pass from it forwards or backwards, forming primary or secondary convolutions, render it difficult to isolate it sufficiently for the anatomist to follow it throughout its entire course. Its inner border is likewise interrupted by the connections which it forms with the convolutions of the floor of the Sylvian fissure.

3. Within the fissure of Sylvius we find that remarkable group of convolutions called by Reil *insula*, the island. It consists of a series of small folds radiating from a common centre and connected with the convolution last described by still smaller folds, which cannot be seen unless when the fissure has been very freely laid open. The centre from which the convolutions radiate is the apex of a cone, the base of which adheres to the floor of the fissure.

4. On the inferior surface of the anterior lobe there is a pair of longitudinal convolutions which enclose between them the fissure of the olfactory process. The external of these convolutions is continuous with the convolution of the Sylvian fissure.

The numerous secondary convolutions which are found over the surfaces of the brain render it difficult to distinguish the primary ones. These latter are indicated by the antero-posterior course which they take—the former being more or less vertical. The largest and most tortuous convolutions are found on that part of the external surface which corresponds to the parietal bone. Next to them, in point of size, are the convolutions of the anterior lobe, but the smallest of all are those of the posterior lobes.

The hippocampi, major and minor, are constant convolutions, which project into the lateral ventricles, the latter into its posterior, the former into its descending horn.

In general the constituent fibres of the white matter of the convolutions converge from the inner surface of the cortical layer to the centrum ovale, or if followed from the centrum ovale, they radiate to the grey surface, whether

of a convolution or of a sulcus. A remarkable exception is in the case of the internal convolution, the fibrous matter of which constitutes, as has been already explained, a longitudinal commissure. The thickness of the cortical layer is pretty uniform, at least relatively to the size of the folds themselves. Throughout its entire thickness it is mixed with fibres, which are most numerous at its adherent surface, but extremely few and scattered at its free surface.

In hydrocephalus the convolutions disappear. The fibrous matter becomes greatly expanded by the fluid accumulated in the ventricles, and when its expansion has gone so far as to equal the grey surface, the folded character of the latter disappears. This takes place precisely in the same way that the rugæ of the contracted stomach (as before referred to) become obliterated when the muscular coat relaxes and allows the full distension of the organ.

Mayo supposes that other fibres are found in the convolutions besides those which are continued into the centrum ovale. These are commissural ones, which pass from convolution to convolution—either between adjacent or distant ones—forming arches the convexities of which are directed to the centrum ovale. I have never succeeded in satisfying myself of the existence of such fibres either in the fresh brain or in that preserved in spirit. If they exist, it is evident that they must be commissural between particular convolutions. The same anatomist supposes that similar commissural fibres connect the laminæ of the cerebellum.

The principal bulk of the hemispheres is formed by fibrous substance. This is shown by the horizontal section which displays the centrum ovale. These fibres radiate from those surfaces of the optic thalami and corpora striata which are in contact with the substance of the hemisphere. Most of the fibres which emerge from these gangliform bodies pass to the grey matter of the convolutions. Some, however, turn inwards towards the mesial plane, and form the corpus callosum by their union with those of the opposite side.

It cannot be supposed that all the remaining fibres, after subtracting those which form the corpus callosum, pass through the thalami and corpora striata. The disproportion of number between the fibres of the medulla oblongata and these is too striking to allow such a hypothesis. They mingle with the vesicular matter of both; some do not pass beyond them; others are continued into the medulla oblongata, either to its olivary or its pyramidal columns.

Corpora striata and optic thalami.—The corpora striata and optic thalami bear a strong resemblance in general character and structure to ganglia. They are ovoid masses placed between the fibrous substance of the hemisphere on the one hand, and the medulla oblongata on the other. These bodies, which are best displayed by laying open the lateral ventricle (p. 675), are very closely united to each other. The corpus striatum is placed a little in front

* See Leuret, pl. xiv. representing the external surface of the elephant's brain.

ward to the outside of the thalamus. It is pear-shaped: its thick end is directed forwards and inwards, and it gradually tapers backwards into a caudate process of considerable length, which winds downwards, forwards, and inwards into the descending cornu of the lateral ventricle, at the anterior extremity of which it terminates. Placed on the outside of the thalamus, it seems to embrace it there, and to adhere very intimately to it. The *tænia semicircularis* lies in a groove between the two bodies, and as it were constricts their connecting fibres.

The corpus striatum is of a dark grey colour. A considerable portion of it projects free into the cavity of the ventricle, forming an extensive convex surface there. The rest is firmly imbedded in the fibrous substance of the hemisphere, and in position corresponds to the base of the insula, which for that reason has been called *the lobule of the corpus striatum*. The free surface as contributing to form the ventricular wall is covered by the lining membrane of the ventricle and a layer of nucleus-like particles; it is traversed by several veins. This surface is limited on the outside by the plane of fibres, which, after emerging from it, incline inwards and contribute to form the corpus callosum. On the inside it is limited by the *tænia semicircularis*, which separates it from the optic thalamus. That portion of the free surface which is seen in the inferior horn of the ventricle has, as already stated, the appearance of a caudiform prolongation of the upper portion; this probably arises from the diminution of the body in thickness at its inferior part, the portion which belongs to the inferior cornu forming the apex of a cone, of which the upper convex portion forms the curvilinear base.

When sections are made through the corpus striatum, it is found to be traversed by very numerous bundles of fibres. It is necessary that these sections should be directed obliquely from below upwards in a direction parallel to the inferior layer of the crus cerebri. The bundles are thicker and more closely approximated to each other inferiorly; but as they ascend, they diverge, and radiate, some forwards, others outwards, and others backwards; some pass nearly vertically upwards. A section made quite in the horizontal direction cuts all these fibres more or less transversely, so that the cut surface presents a grey colour interspersed with white spots of variable size, according as the bundles have been cut transversely or obliquely; but when the section is made in the oblique direction, as above directed, then the surface presents a striated appearance like numerous and regular white veins in a dark marble, the bundles of fibres being cut lengthways.

In tracing the bundles of fibres through the corpus striatum, we find that they divide and subdivide and occasionally anastomose. Each subdivision becomes clothed as it were with grey matter, which fills up the space between it and the adjacent ones. The grey matter ensheathes these bundles of fibres, as the areolar tissue does the fascicles of coarse muscles, and

it may be dissected away from them, as we remove the areolar tissue from the muscular bundles.

It is an important problem to determine the exact source of these fibres and their precise destination. There can be no doubt that many of them are continuous with the inferior plane of the crus cerebri. Of those, the major part are usually supposed to pass through to the white substance of the hemisphere, and some no doubt proceed no farther than the corpus striatum. The other fibres which are found in this body may be viewed as taking their point of departure from its vesicular matter, and radiating, some outwards into the centrum ovale, others backwards to the optic thalamus, forming a bond of connection with that body. It must be borne in mind that, as the corpus striatum is a body of considerable thickness, these fibres which emerge from it must proceed in very different planes and with varying degrees of obliquity. Other fibres are found in the corpora striata, which however do not contribute to its striation. These are the fibres of the anterior commissure.

From a comparison of the small amount of fibrous matter in the inferior plane of the crus cerebri with the immense mass which forms the white substance of the hemispheres, (even if we exclude those fibres which form commissures,) it is impossible to suppose that the latter is derived from the former only; nor, indeed, can it be admitted that even the greater part of the fibrous matter of the hemispheres is continuous with that of the crura, whether on their superior or inferior plane. A considerable portion of them doubtless, when traced from the hemispheres downwards, will be found not to pass below the corpora striata or optic thalamus.

We may regard the corpus striatum as a mass of grey matter with fibres implanted in it which connect it with the other parts of the encephalon. These parts are, 1st, the hemispheres; 2d, the optic thalami; 3d, the crura cerebri, mesocephale, and medulla oblongata. Of these last fibres it is probable, (but I am disposed to think far from certain,) that some of those which form the inferior layer of the crus pass through the corpora striata, and diverge among the other fibres of the centrum ovale.

Thus the corpora striata are connected to the optic thalami by fibres which pass from their concave or inner border to those bodies; to the convolutions of the brain by fibres continuous with some of those which form the white substance of the hemisphere, and we have seen that the convolutions of the *insula* have a very close relation to them; to the mesocephale and medulla oblongata by the fibres which form the inferior layer of the crus; and to each other by those which, emerging from them, contribute to form the corpus callosum, and also by the anterior commissure.

The vesicular matter of the corpora striata does not differ from that of the convolutions. It is traversed by a multitude of fibres. These,

however, do not form any intricate interlacement as in ganglia, but are collected into bundles of very variable size; the largest being placed at the inferior part of the body, the smallest towards the hemispheres. The free or ventricular portion of the corpus striatum contains comparatively few fibres. When a portion of the striated part of the body is examined under the microscope, the nerve-fibres, of which the bundles are composed, appear to be reduced to their smallest size, and to be very compactly applied to each other, so that they transmit very little light, and therefore put on the appearance of dark cylinders. It is only by very high powers that we can discover their fibrous structure. In many of the bundles the fibres appear to terminate at one extremity as if by forming an adhesion around a large vesicle, faint indications of the nucleus and nucleolus of which may be sometimes seen through the surrounding fibres. The appearance which the fibrous cylinders which exhibit this structure present calls to mind very strongly the representation of the nucleus of a comet with its tail. And this peculiarity of structure may be adduced as an argument that many if not the greater number of the fibres of the striated body form intimate connections with the elements of its vesicular matter.

Optic thalami.—In the internal concave surface of each corpus striatum, the optic thalamus is placed. The latter body is therefore posterior and internal to the former. The lighter colour of the optic thalamus distinguishes it at once from the corpus striatum. The optic thalami come into close relation to each other by their inner surfaces, which form the lateral boundaries of the third ventricle.

Each optic thalamus, like the corpus striatum, presents a free and an attached portion. The former projects into the ventricle—the *intra-ventricular* portion; the latter adheres to the inner side of the corpus striatum and to the mass of the hemisphere, and posteriorly, to the olivary columns, the quadrigeminal tubercles, and the processus cerebelli. The superior surface is free and forms part of the floor of the lateral ventricle; the internal surface is likewise free and forms the lateral wall of the third ventricle, being, however, interrupted in a very small space by the adhesion of the soft commissure. A portion of its external and posterior surface is also free, and projects backwards and outwards into the inferior horn of the lateral ventricle, presenting a pointed extremity in that situation. These free surfaces are smooth and moist, being covered by the membrane of the ventricles. The velum interpositum, which again is overlapped by the fornix, rests upon the superior surface of the optic thalamus.

The optic thalami are placed obliquely, so that they are nearer each other at their anterior than at their posterior extremities. Each measures about an inch and a half in length, nine to ten lines in height, and about eight lines in breadth. In colour they are very much lighter than the striated bodies, and they appear to be

covered with a delicate layer of fibrous matter. A band of fibrous matter passes along the inner surface of each from behind forwards, which posteriorly is connected to the pineal gland, and forms, with its fellow, the peduncles of that body.

Beneath the posterior free extremity of the thalamus, situated in the angle between that body and the superior surface of the crus, we find a small rounded eminence of a darkish grey colour perforated by very numerous foramina for the transmission of bloodvessels. This is the *corpus geniculatum internum*. Lower down and more external and anterior, there is another similar body, somewhat smaller and less dark, the *corpus geniculatum externum*. Both of these bodies are connected with the quadrigeminal tubercles. A band of fibrous matter passes from the testes to the external geniculate body, and from the testes to the internal one.

In point of structure the thalamus resembles a ganglion much more closely than does the corpus striatum. A light reddish grey is the colour of the surface when cut into; it has been not inappropriately compared to that of coffee mixed with a good deal of milk (*café au lait*). When thin sections are examined, they are found to consist of very numerous fibres interlacing freely, with nerve vesicles occupying their intervals. The fibres are not collected into bundles as in the corpus striatum, nor do they take a radiating course in the thalamus. The reticulation which they form is very like that in the ganglia on the posterior spinal roots.

The fibres of the optic thalami, inasmuch as they are very numerous, have extensive connections. Along its ventricular surface they are evidently continuous with those of the hemisphere, which appears to radiate from it to the grey matter of the convolutions. Posteriorly the fibres of the processus cerebelli ad testes and those of the olivary columns pass into it. The anterior pillars of the fornix are connected with it in front, and derive from it some nervous fibres; and below and within, a cylinder of fibres emerge from it to the mamillary bodies. Thus the optic thalami are connected with the hemispheres on one hand, with the olivary columns and with the cerebellum on the other hand. The quadrigeminal tubercles placed upon the processus cerebelli may have some connection with them through the latter bundles of fibres. Although these bodies have been viewed as having a special connection with the optic nerves, it does not appear that those nerves have any relation to them but through the geniculate bodies or the quadrigeminal tubercles. It is important to bear in mind respecting the optic thalami that they are directly continuous with the superior portion of the crus cerebri, so that in viewing a vertical section of the encephalon we see no line of demarcation between. The thalamus grows, as it were, from the superior extremity of the crus; it is recognised from the latter by its swelling into an ovoidal mass. It is emphatically, as Willis long ago expressed it, an

epiphysis upon the *crus cerebri*; and in this sense it may be classed with the striated bodies and the quadrigeminal tubercles, which, with the thalami, form a series of gangliform masses, disposed in pairs, one beyond the other.

The geniculate bodies, although intimately connected with the optic thalami, appear to be distinct from them, but very similar in structure. A section made into the thalamus through either of them shows a distinct line of demarcation between them. The optic tracts adhere to the lower surface of each thalamus by their inner margins, and when followed backwards are found to form a very evident connection with both the geniculate bodies.

Corpora mamillaria.—These bodies may be conveniently noticed here, as forming part of the series of gangliform masses in connection with the brain. They are of a spherical shape, covered on the exterior by very pure white matter, which is apparently derived from the anterior pillars of the fornix. When cut into, they are found to consist of a mixture of vesicular and fibrous matter, surrounded by a thin cortex of the latter. Microscopic examination proves this structure of the interior substance to be of the same nature as that of ganglia, and to resemble the optic thalamus.

The fibrous matter is connected, at the upper part of each body with the anterior pillar of the fornix, and on the outside with a fasciculus of fibres from the optic thalamus. It has been supposed that these two bundles are continuous, and that the mamillary body results from a twisting of the anterior pillar of the fornix as it changes its direction to pass into the substance of the thalamus. But the ganglionic structure of the mamillary bodies is unfavourable to this view, and renders it more probable that they are independent structures, exercising proper functions as nervous centres; and the constancy of these bodies in, at least, the mammiferous series, increases this probability.

Of the commissures of the brain.—A large number of fibres connected with the hemispheres or the two gangliform bodies just described, seem to serve the purpose of connecting different parts, either on the same side of the mesial plane, or on opposite sides of it. Those on the same side constitute the longitudinal commissures; those on opposite sides the transverse.

Of the longitudinal commissures.—These are four in number. They all evidently belong to the same system of fibres, separated from each other by the development of intermediate parts. That which is on the highest plane is the *superior longitudinal commissure*, which is the fibrous matter of the internal convolution. Internal and a little inferior to this is a second, very small, band of fibres, *longitudinal tract*, (Vicq. d'Azyr,) which passes from before backwards along the middle of the corpus callosum, parallel to the superior longitudinal commissure, from which it is separated only by the grey matter of the convolution. Both these commissures are separated by the corpus

callosum from a third, which takes a parallel course to them, namely, the *fornix*, which occupies a plane considerably inferior to both. External to this and separated from it by the ventricular projection of the optic thalamus, we find a fourth band, which passes parallel to the fornix: this is the *tania semicircularis*.

As these parts have been already described, it will be unnecessary to do much more at present than indicate the connections which they serve to maintain.

1. *The superior longitudinal commissure* connects the convolutions of the inferior surface of the anterior lobe with the hippocampus major; and as its fibres pass above the corpus callosum they form connections with some of the other convolutions on the internal surface of the hemisphere (*fig. 395*).

2. *The longitudinal tracts* of the corpus callosum may be traced from about the same region of the inferior surface of the anterior lobe as the preceding commissure, near the perforated space, and they pass backwards, winding over the posterior reflection of the corpus callosum to its inferior surface.

3. The *fornix** is, next to the corpus callosum, the most extensive of the cerebral commissures. That it consists of longitudinal fibres cannot be doubted. Although commonly described as a single structure united at the body of the fornix, and spreading backwards and forwards by its crura, it nevertheless is distinctly divisible along the middle line into two perfectly symmetrical portions. The adhesion of the transverse fibres of the corpus callosum on its upper surface, and of the terminal fibres of its posterior reflection on its inferior surface which form the *lyra*, is the principal bond of union of these two lateral halves of the fornix.

The separation of its anterior pillars in front affords strong indication of its double form. These pillars pass downwards in a curved course, through the grey matter of the tuber cinereum, to the mamillary bodies, which are connected to the optic thalami by a bundle of fibres which may be easily traced into them. This bundle is described by Reil as the *root* of the anterior pillar of the fornix. From the gangliform structure of the corpus mamillare, I prefer to regard this band as a medium of connection with the optic thalamus, and to trace the anterior pillars to the mamillary body.

The parts with which the fornix is connected in front are the optic thalami, the mamillary bodies, and the septum lucidum, which consists of fibres having the same physiological import as those of the corpus callosum, altered however in direction by the backward position of the anterior pillars, which adhere to the body of the fornix. The tuber cinereum and the grey matter which adheres to the lower half of the inner surface of each optic thalamus, are connected with it;

* This commissure is called *voûte à trois piliers* by the French, *Trigone cérébrale*, Chaussier: *Ψαλις*, *σώμα Ψαλιοειδές* of the Greeks. Mr. Solly has given an excellent delineation of the fornix in his work on the brain, pl. ix.

and as its anterior pillars pass upwards in this situation, they receive fibres from the neighbouring convolutions. These pillars remain separate from the mamillary bodies to the foramen of Monro, where they adhere to each other and form the apex of the body of the fornix. Traced backwards, the fibres of the fornix pass into the posterior and inferior horns of the lateral ventricle. In the former they connect themselves with the hippocampus minor by expanding over it, and in the latter they spread over the hippocampus major, forming the posterior pillar of the fornix, or *tænia hippocampi*.

The relation of the anterior pillars of the fornix to the foramen commune anterius has been already sufficiently described. Superiorly the fornix adheres to the corpus callosum or to the septum lucidum, and the anterior commissure crosses in front of its anterior pillars, and almost touches them.

4. The fourth longitudinal commissure is the *tænia semicircularis*. It may be traced from the corpus mamillare outwards and backwards in the groove between the optic thalamus and corpus striatum into the inferior horn of the lateral ventricle, when its fibres mingle with those of the middle lobe. It is evidently part of the same system of fibres with the fornix.

Take away the corpus callosum, the grey matter of the internal convolution, the ventricular prominence of the optic thalamus, and all these commissures fall together and become united as one and the same series of longitudinal fibres.

It is very remarkable how few fibres pass between the great mass of the cerebrium and the cerebellum. The *processus cerebelli ad testes* are the only fibres which can be regarded as forming commissures between these two segments of the encephalon, and they are of the nature of longitudinal commissures.

The *transverse commissures* are the *corpus callosum*, the *anterior commissure*, the *posterior commissure*, the *soft commissure*.

1. The *corpus callosum*, so called according to some from the density of its tissue, is the great commissure of the lateral halves of the brain proper—*commissura cerebri maxima* of Soemmering. The fasciculated character of this structure is as obvious as that of any nerve in the body, and the direction of the fibres is clearly from one hemisphere to the other.

From the description already given of the corpus callosum, it is evident that its fibres sink into the white substance of each hemisphere above the level of the corpora striata, as well as into that of the anterior and of the posterior lobes. By its principal or horizontal portion it connects the white matter of the lesser centrum ovale of each side, and by the fibres which form the anterior and posterior reflexions it connects the anterior and posterior lobes. It needs only a very superficial dissection to ascertain thus much.

To determine the precise fibres with which those of the corpus callosum are continuous,

and the relation which they bear to the lateral ventricles, demands a much more minute dissection. This must be done, according to the directions of Foville, who has given a most elaborate description of this commissure, by carefully separating it in the transverse direction from the internal convolution, on a hardened brain. Pursuing the dissection in this direction, it may be detached from the substance of the hemispheres as far outwards as the external border of the corpus callosum and optic thalamus. Along this edge the fibres curve downwards and inwards, and appear to become continuous with some of those which radiate from those bodies. The anterior and posterior fibres enclose the anterior and posterior horns of the lateral ventricles in radiating forwards and backwards from the corpora striata and optic thalami to those parts of these cavities.

This view of the connections of the corpus callosum would indicate it to be a commissure between the thalami and corpora striata, or between the crura cerebri, as Tiedemann supposed, rather than between the hemispheres. Nothing is more difficult than the dissection of the fibres of the corpus callosum beyond the internal convolution: and it cannot be regarded as in any degree certain that the connections of its fibres are limited to those above described.

The development of the corpus callosum in the fetus, prior to that of the hemispheres or convolutions, is favourable to the view of its connections maintained by Tiedemann and Foville. Comparative anatomy is, however, more in accordance with the opinions of Gall and Reil, that it is a commissure between the convolutions of opposite sides. It exists only in those animals in which convolutions are amply developed. In Fish, Reptiles, and Birds it is absent, and the Mammalia with least perfect brains, as the Rodents and Marsupialia.

The corpus callosum is a stratum of considerable thickness. Its fibres are situated on different planes, which interlace with each other so much as to render it impossible to separate any layer for any distance, and the difficulty is much increased as the fibres are nearer the white mass of the hemispheres.

2. The *anterior commissure* may be regarded as truly a bond of connection between the hemispheres, as well as between the corpora striata. It is a cylindrical cord of fibrous matter, very definite in its course and connections, and easily traced throughout its entire extent. Its situation in front of the anterior pillars of the fornix has been already described. If followed on either side from this central portion, it may be traced through the grey matter of the anterior and inferior portion of each corpus striatum into the fibrous matter of each middle lobe of the brain. Its course is curved with convexity directed forwards. As it passes outwards on each side it becomes flattened, and after it has traversed each corpus striatum, it expands considerably and its fibres

radiate extensively. It may be stated to connect the convolutions of the middle lobes and the corpora striata.

3. *The posterior commissure* is a band of fibres, extended between the posterior extremities of the optic thalami, upon which rests the base of the pineal body. Those fibres, which immediately support that body, have been distinguished as the *pineal commissure*; but as they are evidently part of the same system as those which constitute the posterior commissure, there seems no good reason for separating them.

4. *The soft commissure* is also extended between the thalami. It is composed of vesicular matter with fibres, which pass from one side to the other. The intermixture of its fibres with vesicular matter distinguishes it from the other transverse commissures already described. A layer of a similar nature connects the locus niger of each crus cerebri, and fills up the space between the crura—*interpeduncular space*. This has been already described as the *pons Tarini*, *posterior perforated space*. It consists of fibrous matter intermixed with vesicular, extended between the crura cerebri. It seems analogous to the soft commissure, and therefore entitled to be regarded as a commissure.

Of the manner in which the commissures connect the various parts between which they are placed, it is difficult to form an exact opinion. It is most probable that they form an intimate union with the grey matter of the segments which they serve to connect. It might also be conjectured that they are continuous with some of the fibres of the segments which they unite, or that they interlace with them in some intricate way, so as to come into intimate or frequent contact with them.

Tuber cinereum.—At the base of the brain we have already described a layer of pale grey matter which fills up the interval between the mamillary bodies and the optic commissure. It extends above the optic commissure forwards to the anterior reflexion of the corpus callosum, and forms intimate connections with the anterior pillars of the fornix, the optic tracts, the septum lucidum, and at the floor of the third ventricle with the optic thalami. It consists of vesicular matter with fibres, and resembles very much the soft commissure, to which it is very probably analogous in office.

The process called *infundibulum* or *pituitary process* extends from the inferior surface of the tuber cinereum down to the pituitary body. It is hollow, wide above, where it communicates with the third ventricle, and narrow below at the pituitary body. When cut across, fluid will escape from the third ventricle through it, and a probe passes readily from that cavity into it. It is composed of a layer of granules, derived, no doubt, from the epithelial lining of the third ventricle, and some vesicular matter with bloodvessels and fibrous tissue, which latter is derived from the pia mater, and the special sheath of arachnoid reflected upon it.

Pituitary body.—The process just described is the connecting link between the brain and that glandiform body, the *pituitary gland* or *hypophysis*. This body, situate in the sella Turcica, is of a rounded form, longer in the transverse than the antero-posterior direction, concave on its superior surface, into which the pituitary process is inserted. It is surrounded by dura mater, which projects over it, leaving an opening for the passage of the infundibulum.

The pituitary body is about six lines in its transverse diameter and three lines from before backwards: its weight, including the infundibulum, is about eight grains. It consists of two lobes, one anterior, the other posterior. The former is kidney-shaped and lodges the latter in the notch of its posterior edge. In point of size the anterior lobe is nearly double the posterior.

The colour of the posterior lobe is lighter than that of the anterior, and resembles that of the grey matter of the brain.

This body is proportionally larger in early life than at the later periods, and it is certainly more developed in the lower mammalia than in man. It is very large in fishes, and probably reaches its maximum of size in that class of animals.

The structure of the pituitary body resembles very much the grey cerebral matter. It is composed of large nucleated vesicles, surrounded by a granular matrix, with bundles of white fibrous tissue. This fibrous tissue either forms an essential element in its constitution, or accompanies the bloodvessels which are found in it in great numbers. Its substance is soft, but not so soft as the cerebral matter, and when pressed between the fingers is reduced to a greyish pulp, like the substance of an absorbent gland in an early stage of suppuration.

Earthy concretions have been occasionally but very rarely found in the pituitary body. This circumstance, its colour, its glandiform character, and its extra-cerebral situation in connexion with the third ventricle, give it a certain degree of analogy to the pineal body. But in this latter nervous fibres have been found, of which I have failed to discover any trace in the pituitary, nor is the pituitary body connected to the brain by fasciculi of fibres as the pineal body is. The use of both is equally involved in obscurity; but from their constancy it may be argued that their function is not unimportant. It has been supposed that the pituitary body is a large ganglion belonging to the sympathetic system: this opinion, however, wants the all-important foundation of anatomy to rest upon, inasmuch as we find that the body in question is devoid of the anatomical characters of a ganglion. It may with more propriety be classed with the glands without efferent ducts; and from its numerous vessels, and its close relation to part of the venous system within the cranium, it may be connected with the process of absorption or removal of the effete particles of the brain.

Of the ventricles of the brain.—The third ventricle results from the apposition of the lateral halves of the brain along the median plane, and the lateral ones from the folding inwards, above and below, of the convoluted surface of each hemisphere. They must not therefore be regarded as cavities hollowed in the substance of the brain: on the contrary, their walls must be viewed as part of the cerebral surface, and the eminences which project from them as convolutions. The *corpora striata* and optic thalami are from their structure entitled to be considered in this light, and still more the *hippocampi*, which, however, are somewhat complicated by the addition of the layers of white matter derived from the fornix.

The distinction between the lateral and the middle or third ventricle results from the development of the corpus callosum and of the fornix, which form horizontal strata by which the ventricles are closed in above; and the extension of the anterior pillars of the fornix downwards, and the close application of the free margin of the body of the fornix to the optic thalami, assign more complete limits to the third ventricle.

The fourth ventricle is also evidently formed by the lateral adaptation of the symmetrical halves of the medulla oblongata. The latter is obviously a continuation of it closed behind by the quadrigeminal bodies and their connecting fibres. This ventricle remains open in the embryo, uncovered by any portion of the encephalon until the full development of the cerebellum causes it to extend over it.

The fifth ventricle must be viewed as originally part of the third, which has been closed off by the full development of the septum lucidum and fornix, and the union of their lateral halves along the median plane.

All these cavities are lined by a delicate membrane nearly allied to, if not identical with, serous membranes. It is covered by an epithelium, ciliated according to Purkinje and Valentin, beneath which are delicate fibres of areolar tissue exactly of the same kind as those found in connection with serous membranes. I have never seen any basement membrane. This membrane is reflected around the processes of pia mater which are found in the ventricles, and in this respect presents an additional point of analogy to the serous membranes, the portion which lines the walls of the ventricles corresponding to the parietal layer, and that which adheres to the pia mater resembling the visceral layer of those membranes. It is the reflection of this membrane from the walls to the enclosed pia mater which serves to shut off the ventricular cavity from the sub-arachnoid space, at the anterior part of the horizontal fissure, and at the inferior extremity of the fourth ventricle. If any communication take place between the intra-ventricular and sub-arachnoid fluid, it must be, as already remarked, by transudation through this membrane.

Of the circulation in the brain.—Haller cal-

culates that the human brain receives rather more than one-fifth of the whole blood of the body. Whether this calculation be correct or no, it is certain that an organ of such great size, of such high vital endowments, so active, and which exerts so considerable an influence upon all other parts of the body, must necessarily require a large supply of the vital fluid. Four large arteries carry blood to the brain, namely, the two *internal carotids* and the two *vertebrals*. Each carotid penetrates the cranium at the foramen on the side of the sella Turcica, and almost immediately divides into three branches, the *anterior* and the *middle cerebral* arteries and the *posterior communicating* artery.

The *anterior cerebral* arteries supply the inner sides of the anterior lobes of the brain: they ascend through the great longitudinal fissure, and pass along the upper surface of the corpus callosum, giving off branches to the inner convolutions of both hemispheres of the brain. These arteries anastomose with each other just beneath the anterior margin of the corpus callosum by a transverse branch, called *anterior communicating* artery. The *middle cerebral* arteries, the largest branches of the carotid, pass outwards in the fissures of Sylvius, and supply the outer convolutions of the anterior lobes, and the principal portion of the middle lobes. At the inner extremity of each fissure of Sylvius numerous small branches of these arteries penetrate, to be distributed to the corpus striatum. The choroid arteries which supply the choroid plexus sometimes arise from these arteries, but also occasionally come from the carotid itself. The *posterior communicating* artery is an anastomotic vessel, which passes backwards along the inner margin of the middle lobe on the base of the brain, and communicates with the posterior cerebral artery, a branch of the basilar.

The *vertebral* arteries, having passed through the canals in the transverse processes of the cervical vertebrae, enter the cranium through the occipital foramen towards its anterior part. In their ascent they incline towards each other in front of the medulla oblongata, and at the posterior margin of the pons they coalesce to form a single vessel, the *basilar*, which extends the whole length of the pons.

The *vertebral* arteries furnish the *anterior* and *posterior spinal* arteries, and the *inferior cerebellar* arteries. These last vessels arise from the *vertebrals* very near their coalescence; they pass round the medulla oblongata to reach the inferior surface of the cerebellum, to which they are principally distributed.

From the basilar artery numerous small vessels penetrate the pons. At its anterior extremity it divides into four arteries, two on each side. These are, the two *superior cerebellar*, and the two *posterior cerebral* arteries.

The *superior cerebellar* arteries pass backwards round the crus cerebri, parallel to the fourth nerve, and divide into numerous branches on the upper surface of the cerebellum, some of which anastomose with branches of the inferior cerebellar artery over the posterior margin of the cerebellum. Some branches of these

arteries are distributed to the velum interpositum.

The posterior cerebral arteries are the largest branches of the basilar. They diverge and pass upwards and backwards round the crus cerebri, and reach the inferior surface of the posterior lobe, anastomosing in the median fissure with ramifications of the anterior cerebral, and on the outside with branches of the middle cerebral arteries. Numerous small vessels pass from these arteries at their origin, and penetrate the interpeduncular space, and one or two are distributed to the velum. Shortly after its origin each of these arteries receives the posterior communicating branch from the carotid.

A remarkable freedom of anastomosis exists between the arteries of the brain. This takes place not only between the smaller ramifications, but likewise between the primary trunks. The former is evident all over the surface of the cerebrum and cerebellum. The latter constitutes the well-known *circle of Willis*. This anastomosis encloses a space, somewhat of an oval figure, within which are found the optic nerves, the tuber cinereum, the infundibulum, the corpora mamillaria, and the interpeduncular space. The anterior communicating artery, between the anterior cerebral arteries, completes the circle in front. The lateral portion of the circle is formed by the posterior communicating artery, and it is completed behind by the bifurcation of the basilar into the two posterior cerebral arteries. Thus, a stoppage in either carotid, or in either vertebral, would speedily be remedied. The coalescence of the vertebals to form the basilar affords considerable security to the brain against an impediment in one vertebral; and, should the basilar be the seat of obstacle, the anastomoses of the inferior cerebellar arteries with the superior ones would ensure a sufficient supply of blood to that organ. If either or both carotids be stopped up, the posterior communicating arteries will supply a considerable quantity of blood to the intracranial portions of them; or, if one carotid be interrupted, the anterior communicating branch will be called into requisition to supply blood from the opposite side.

Interruption to the circulation in both carotids and both vertebals is productive of a complete cessation of cerebral action, and death immediately ensues, unless the circulation can be quickly restored. This was proved clearly by Sir A. Cooper's experiments on rabbits. The circulation may, however, be interrupted in both carotids, or in both vertebals, without permanent bad effect; or in one carotid or one vertebral, provided the condition of the remaining vessels be such as not to impede the circulation in them. In cases where the neighbouring anastomotic branches are not sufficient to restore the circulation to a part from which it has been cut off by the obliteration of its proper vessel, the cerebral substance of that region is apt to experience a peculiar form of softening*

* In the last volume of the Med. Chir. Trans. I have related a remarkable case in which white softening of one hemisphere followed the plugging of the common carotid on the same side by coagulum.

or wasting, which is distinguished by the absence of any discoloration by the effusion of blood, or of any new matter.

The four great channels of sanguineous supply to the brain are continued up straight from the aorta itself, or from an early stage of the subclavian. The columns of blood contained in them are propelled very directly towards the base of the brain, through wide canals. Were such columns to strike directly upon the base of the brain, there can be no doubt it would suffer materially. Considerable protection, however, is afforded to the brain; first, by the blood ascending against gravity, during at least a great portion of life; secondly, by a tortuous arrangement of both carotids and vertebals before they enter the cranial cavity; the carotid being curved like the letter S in and above the carotid canal, and the vertebral being slightly bent between the atlas and axis, then taking a horizontal sweep above the atlas, and after it has pierced the occipito-atlantal ligament, inclining obliquely upwards and inwards; thirdly, by the breaking up of the carotids into three branches; by the inclined position of the vertebals, and by their junction into a single vessel, which takes a course obliquely upwards, and afterwards subdivides into smaller branches. Such arrangements most effectually break the force of the two columns, and, as it were, scatter it in different directions.

A further conservative provision is found in the manner in which the bloodvessels penetrate the brain. The larger arterial branches run in sulci between convolutions, or at the base of the brain; smaller branches come off from them, and ramify on the pia mater, breaking up into extremely fine terminal arteries, which penetrate the brain; or these latter vessels spring directly from the larger branches, and enter the cerebral substance. As a general rule, no vessel penetrates the cortical layer of the brain, which, in point of size, is more than two removes from the capillaries; and, whenever any vessel of greater size does pierce the cerebral substance, it is at a place where the fibrous matter is external, and that part is perforated by foramina for the transmission of the vessels. Such places are the locus perforatus, the interpeduncular space, &c. The capillaries of the cerebral substance are easily seen to possess an independent diaphanous wall, with cell-nuclei disposed at intervals. The smaller arteries and veins can also be admirably studied in the pia mater of the brain.

The venous blood is collected into small veins, which are formed in the pia mater at various parts of the surface, and in the interior of the brain. The superficial veins open by short trunks into veins of the dura mater, or into the neighbouring sinuses; the superior longitudinal, the lateral, and the straight sinuses receiving the greatest number. Those from the interior form two trunks, *vena magna Galeni*, which pass out from the ventricles between the layers of the velum interpositum. The cerebral veins are devoid of valves.

We remark here, that the venous blood of the brain is returned to the centre of the circu-

lation through the same channel as that of the dura mater, of the cranial bones, and of the eyeball: the internal jugular veins are the channel towards which the venous blood of the cranium tends. An obstacle, therefore, in both or either of these vessels must affect the entire venous system of the brain, or at least that of the corresponding hemisphere. A ligature tied tightly round the neck impedes the circulation, and may cause congestion of the brain. The bodies of criminals who have died by hanging exhibit great venous congestion, both of the walls and the contents of the cranium, in consequence of the strong compression to which the veins have been submitted.

We have seen that, when the blood of one carotid artery is cut off, the parts usually supplied by it are apt to become exsanguineous and softened; and this is more especially the case if the vertebral be stopped up, or the circulation in it impeded. And it has been remarked, that these effects will follow the application of a ligature to either common carotid artery.

Notwithstanding these facts, a doctrine has received very general assent, and the support of men of high reputation, which affirms that the absolute quantity of blood in the brain cannot vary, because that organ is incompressible, and is enclosed in a spheroidal case of bone, by which it is completely exempted from the pressure of the atmosphere.

The cranium, however, although spheroidal, is not a perfectly solid case, but is perforated by very numerous foramina, both external and internal, by which large venous canals in the diploe of the bones communicate with the circulation of the integuments of the head as well as with that of the brain; so that the one cannot be materially affected without the other suffering likewise. And as the circulation in the integuments is not removed from atmospheric pressure, neither can that which is so closely connected and continuous with it, be said to be free from the same influence. Still it must be admitted, that the deep position of the central vessels, and the complicated series of channels through which they communicate with the superficial ones, protect them in some degree from the pressure of the air, and render them less amenable to its influence than the vascular system of the surface.

If it were essential to the integrity of the brain that the fluid in its bloodvessels should be protected from atmospheric pressure (as the advocates of this doctrine would have us to believe), a breach in the cranial wall would necessarily lead to the most injurious consequences; yet, how frequently has the surgeon removed a large piece of the cranium by the trephine without any untoward result! Some years ago I watched for several weeks a case in which nearly the whole of the upper part of the cranium had been removed by a process of necrosis, exposing a very large surface to the immediate pressure of the atmosphere; yet in this case no disturbance of the cerebral circulation existed. In the large and open fontanelles of infants we have a state analogous to that which art or disease produces in the adult:

yet the vast majority of infants are free from cerebral disease for the whole period during which their crania remain incomplete; and in infinitely the greatest number of cases in which children suffer from cerebral disease, the primary source of irritation is in some distant organ, and not in the brain itself.

It cannot be said that the brain is incompressible. That only is incompressible, the particles of which will not admit of being more closely packed together under the influence of pressure. That the brain is not a substance of this kind is proved by the fact that, while it is always undergoing a certain degree of pressure as essential to the integrity of its functions, a slight increase of that pressure is sufficient to produce such an amount of physical change in it as at once to interfere with its healthy action. Too much blood distributed among its elements, and too much serum effused upon its surface, are equally capable of producing such an effect.

Majendie's experiments, described in a former part of this article, show that the brain and spinal cord are surrounded by fluid, the pressure of which must antagonise that which is exerted through the bloodvessels. The removal of this fluid disturbs the functions of these centres, apparently by allowing the vessels to become too full. The pressure exerted by the former may be called the fluid pressure from without the brain; that by the blood, the pressure from within. As long as these two are balanced, the brain enjoys a healthy state of function, supposing its texture to be normal. If either prevail, more or less of disturbance will ensue. Their relative quantities, if not in just proportion, will bear an inverse ratio to each other. If there be much blood, the surrounding fluid will be totally, or in a great measure, deficient; if the brain be anæmic, the quantity of surrounding fluid will be large.

The existence of these two antagonizing forces may be taken as a proof that either of them may prevail; and, therefore, from the presence of the cerebro-spinal fluid, we may infer that the actual quantity of circulating blood in the brain is liable to variation.

The cerebro-spinal fluid is a valuable regulator of vascular fullness within the cranium, and a protector of the brain against too much pressure from within. So long as it exists in normal quantity it resists the entrance of more than a certain proportion of blood into the vessels. Under the influence of an unusual force of the heart an undue quantity of blood may be forced into the brain, the effects of which will be, first, the displacement of a part or of the whole surrounding fluid; and, secondly, the compression of the brain.

When the brain receives too little blood, the requisite degree of pressure will be maintained, and the healthy cerebral action preserved, if the surrounding fluid do not increase too rapidly. But if the brain be deprived of its due proportion of blood by some sudden depression of the heart's power, there is neither time nor source for the pouring out of a new fluid, and a state of syncope or of delirium will ensue. Such seems to be the explanation of those cases of

delirium which succeed to hæmorrhages, large bleedings, or the sudden lighting up of inflammation in the pericardium or within the heart. In nearly all these cases, however, it is important to notice that the blood is more or less damaged in quality, deficient in some of its staminal principles, or charged with some morbid matter; and this vitiated state of the vital fluid has no doubt a considerable share in the production of the morbid phenomena.*

Of the encephalic nerves.—There are no common characters possessed by these nerves, such as have been enumerated at a preceding page for the spinal nerves. They are, however, disposed in pairs, and are quite symmetrical. With the exception of the olfactory, optic, and third pair, they are all connected with the mesocephale or medulla oblongata.

The arrangement of these nerves originally proposed by Willis has been so long adopted in this country and on the continent that no advantage would arise from abandoning it, unless some other of an unexceptionable nature could be substituted for it. It has, therefore, been followed in this work, and the anatomy and physiology of the encephalic nerves have been described in articles prefixed by their numerical titles, in all cases except the olfactory and optic, and the eighth pair of nerves.†

Twelve pairs of nerves are found in connection with the base of the encephalon. Five pairs have been so classed by Willis as to form two in his arrangement, three pairs being allotted to his eighth pair of nerves, and two to his seventh. Willis's arrangement, therefore, comprises nine pairs of nerves, which he enumerates, beginning at the anterior and passing to the posterior part of the base of the brain. These are the first pair or *olfactory* nerves; the second pair or *optic*; the third pair, *motores oculorum*; the fourth pair, *pathetici*; the fifth pair; the sixth pair, *abducentes oculi*; the seventh pair, including the *portio mollis* or *auditory* nerve, and the *portio dura* or *facial* nerve; the eighth pair, including the *glosso-pharyngeal*, the *pneumo-gastric*, and the *spinal accessory*; the ninth pair or *hypoglossal*. The first cervical nerve or the *sub-occipital* was considered by Willis as an encephalic nerve and counted as the *tenth* pair.

As the cranium may be shewn to be composed of the elements of three vertebræ, it has been attempted to prove that among these nerves some may be classed with the vertebral or spinal nerves. The fifth is obviously of this kind from its anatomical characters, namely, two roots; one, small, ganglionless; the other large, ganglionic; but with the former, which is analogous to the anterior root of a spinal nerve, the third, fourth, and sixth nerves may be conjoined from their similarity in structure and distribution. Thus one *cranio-vertebral*

nerve is formed, the anterior root of which consists of the small portion of the fifth, the third, fourth, and sixth nerves; and the posterior or sensitive root, of the large portion of the fifth. A second *cranio-vertebral* nerve consists of the eighth pair, to which might be added the facial contributing to its motor portion; and a third is formed by the hypoglossal. The analogy, especially in the latter case, is far from being very obvious.

Sketch of the microscopical anatomy of the spinal cord and brain.—We conclude our account of the anatomy of the spinal cord and brain with a rapid glance at the present state of our knowledge of their minute anatomy as revealed by microscopical observation.

The elements of the two kinds of nervous matter, *fibrous* and *vesicular*, have been already sufficiently described. We shall only remark here that the great object of the anatomist's research should be to find out the precise manner in which the nerve-fibres are united with the nerve-vesicles. Of their intimate connection there can be no doubt,—much less of the influence which they are capable of exerting mutually upon each other.*

Among the peculiarities of the fibrous matter in the centres it may be here stated that the fibres pass through a much greater range of size than in the nerves; that here we meet with nerve-tubes of the largest size, and, on the other hand, with minute fibres which seem to be continuous with the branching processes of the caudate nerve-vesicles. These fibres are perfectly transparent and differ from the nerve-tubes in the absence of any of the white substance of Schwann, and of the tubular membrane.

Some idea of the relation of the vesicular and fibrous matter in different parts of the cerebro-spinal centre may be formed by examining thin sections of the several portions of them made in various directions. It is impossible to make these sections sufficiently thin to enable us to explore a large surface with a high power, for which great transparency is necessary. Such sections, however, may be examined with low powers, as Stilling and Wallach have done. It is important, however, to notice that the appearances observed in this way afford no *certain* indication of the course and direction of the nerve-fibres, nor of the situation of the finer elements of the vesicular matter. The nerve-tubes are too minute to admit of being followed with an object-glass which magnifies less than from two hundred to three hundred diameters; yet Stilling's researches have been made with a power of no more than ten or twelve diameters.

The fibrous matter of the spinal cord consists of some fibres which pass either in a vertical direction, or obliquely, taking a long course, and deviating but slightly from the parallel to the axis of the cord. The fibres of the posterior columns are the most obviously longitudinal, and those which lie quite on the surface of the antero-lateral columns follow very much the same direction. Among the elements of the grey matter, fibres are found in great numbers,

* The subject of the circulation in the cranium has been very ably discussed by Dr. G. Burrows in the Lumleian Lectures for 1843, Lond. Med. Gazette, vol. xxxii.

† The olfactory nerve is described in the article NOSE, the optic in OPTIC NERVES, and the eighth pair under the titles of its three portions.

* See the article NERVE, and pp. 646, 7, et seqq.

the direction of which is probably oblique or transverse, as considerable portions of them may be seen taking such a direction when a piece of grey matter, cut transversely, is examined under the microscope.

The grey matter of the cord contains caudate and spherical vesicles imbedded in their usual granular matrix. They are found in the horns as well as in the commissure. The caudate vesicles are most numerous, and distend in the anterior horn and at the root of the posterior one. The remainder of the posterior horn and the gelatinous substance which is found at its posterior border, resemble very closely in structure the grey matter of the cerebral convolutions.

By examining thin transverse sections of the cord, carefully hardened by immersion in spirits, a good view of the relative disposition of the grey and fibrous substances may be obtained. Stilling has carried investigations of this kind to a great extent, and has published some beautiful plates, which are quite true to nature. *Fig. 396* is copied from one of them.

Fig. 396.

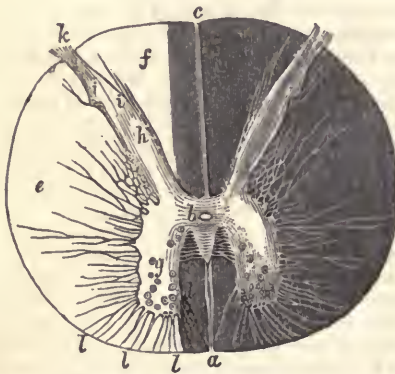

Transverse section of human spinal cord, close to the third and fourth cervical nerves. Magnified ten diameters. (From Stilling.)

f, posterior columns; *ii*, gelatinous substance of the posterior horn; *k*, posterior root; *l*, supposed anterior roots; *a*, anterior fissure; *c*, posterior fissure; *b*, grey commissure, in which a canal is contained, which, according to these writers, extends through the length of the cord; *g*, anterior horn of grey matter containing vesicles; *e*, antero-lateral column, from *k* to *a*.

It is impossible, however, to obtain any information from such examinations, except of the most general kind. On referring to the figure, the reader will perceive several lines, of the same colour and appearance as the central mass, to radiate from each horn of the grey matter to the surface of the cord, and not only to its external surface, but to that of its fissures. At whatever part of the cord the section be made, whether on a level with the roots of the nerves or between their points of emergence, the same appearance of radiating lines is seen, and the radiation will be found to extend between the central grey matter and whatever

part of the surface of the cord the pia mater comes into contact with.

Stilling and Wallach suppose that these lines are continuous with the roots of the nerves; that they are, in fact, nerve-tubes proceeding from the grey matter to form these roots. But this supposition seems quite untenable, for the following reasons: 1st, because these lines are met with in situations intermediate to the points of emergence of the nerves; 2dly, because they pass to situations, such as the surface of the fissures, from which no nerve-roots emanate; 3dly, because, if they were nerve-tubes, they could not be so distinctly seen with so low a power. It is much more probable that they may be processes of grey matter prolonged towards the surface, to which bloodvessels may pass from the pia mater, or simply bloodvessels passing from the pia mater to the grey matter. In some well-injected specimens, which Mr. Smee had the goodness to shew me lately, the bloodvessels were seen to take exactly the same direction and course as these lines.

Besides the nerve-tubes which are found in considerable numbers in the grey matter, the branching processes of the caudate vesicles are met with in it also, which may be distinguished from the nerve-tubes by the absence of the white substance of Schwann, by their greyish colour, by their branching, and by their minutely granular texture. Capillary bloodvessels are met with in great numbers, ramifying in the grey matter, where they are much more numerous than in the fibrous matter.

Stilling and Wallach describe a canal passing through the centre of the grey commissure, and extending the whole length of the cord. This is certainly visible in most regions, but not in all. It seems to me to have much more the appearance of a bloodvessel than of a canal. According to these authors, it is the persistent condition of the much-talked of canal of the spinal cord referred to at a previous page. Its situation in the grey matter seems rather opposed to this view. The point, however, is one upon which I am not prepared to express a decided opinion at present, and which deserves more extended careful examination.

From a review of the preceding statements, it is plain that a large number of fibres pass into the grey matter of the cord, and probably form some intimate connection with its minute elements; and this fact is favourable to the supposition that the spinal nerves derive their origin, at least partly, from the grey matter. It must be admitted, either that these fibres unite with the vesicles of the grey matter in some way, or that they pass up to the brain through the grey matter; the former seems the more reasonable supposition, and more consistent with the apparent oblique or transverse direction which the fibres take in the grey matter.

The minute structure of the medulla oblongata resembles in many particulars that of the spinal cord. There is not, however, so complete an isolation of the fibrous matter in it as in the latter. Excepting in the anterior pyramids, and quite on the posterior and lateral surfaces, the two kinds of nervous substance

freely intermingle. The anterior and posterior pyramids and the restiform bodies consist, at least in great part, of longitudinal fibres, but the remainder of the fibrous matter appears to be made up of transverse or oblique fibres. Most of these are doubtless connected with the roots of the many nerves which arise from the medulla oblongata. Stilling refers to special accumulations of vesicular matter connected with

the roots of each nerve, and which probably form its proper origin. These contain large vesicles. It is impossible to give an exact interpretation to all the parts which are seen by his method of examination, imperfectly defined as they are from the use of such low magnifying powers. It would be waste of time and space to do more than refer to the representation given by Stilling (*fig. 397*) of the

Fig. 397.



Transverse section of the medulla oblongata through the lower third of the olivary bodies. (From Stilling.) Magnified ten diameters.

a, anterior fissure; *b*, fissure of the calamus scriptorius; *c*, raphé; *d*, anterior columns; *e*, lateral columns; *f*, posterior columns; *g*, nucleus of the hypoglossal nerve, containing large vesicles; *h*, nucleus of the vagus nerve; *i, i*, gelatinous substance; *k, k*, roots of the vagus nerve; *l*, roots of the hypoglossal, or ninth nerve; *m*, a thick bundle of white longitudinal fibres connected with the root of the vagus; *n*, soft column (*Zartstrang*, Stilling); *o*, wedge-like column (*Keelstrang*, Stilling); *p*, transverse and arciform fibres; *q*, nucleus of the olivary bodies; *r*, the large nucleus of the pyramid; *s, s, s*, the small nuclei of the pyramid; *u*, a mass of grey substance near the nucleus of the olives (*Oliven-Nebenhern*); *v, v*, are traversed by numerous fibres passing in a transverse semicircular direction; *w*, arciform fibres; *x*, grey matter near the root of the vagus.

structure, as viewed by a magnifying power of ten diameters. Nothing can be more true to nature, so far as it goes, but its correct explanation must be sought for by diligent investigation with high powers. Numerous bloodvessels penetrate the central matter of the medulla, and no doubt many of the lines, which Stilling supposes to represent fibres, are in reality vessels passing to the grey matter.

The mesocephale has very much the same kind of structure as the medulla oblongata; transverse fibres (those of the pons) at its anterior part, longitudinal ones just behind these (pyramids), with vesicular matter freely intermixed. Its posterior part is the same in structure as the optic thalamus, and consists of numerous fibres with an abundant quantity of grey matter. The inferior layer of the crus cerebri is purely fibrous; its superior portion is identical in

structure with the optic thalamus, and the locus niger contains large caudate nerve-vesicles, with a considerable quantity of pigment contained in them.

Microscopic investigation has as yet thrown no light on the *direction* and *connections* of the fibres of the cerebrum or cerebellum. What is known upon these points is derived from coarse dissection. The tubular fibres of which the white matter is composed, appear to be disposed on different planes, and perhaps interlace with each other, so as to render it difficult to isolate any plane to any great extent. This arrangement is more obvious in the cerebellum than in the cerebrum. The grey matter of both these segments contains the ordinary elements, caudate and spherical vesicles; but in the cerebellum those of the latter variety are much larger and more distinct than those which

are met with in the brain. The peculiar structure of particular parts, as the optic thalami, corpora striata, tuber cinereum, &c. has been already described.

The grey matter of the convolutions of the brain presents the same characters throughout, excepting in certain convolutions of the posterior lobe near the posterior and inferior horns of the lateral ventricles. Here, we may observe, in a horizontal section, the grey matter of the convolutions separated into two portions by a delicate white line, well represented in *fig. 398*. This layer of light matter was first

Fig. 398.



White line in the grey matter of convolutions of the posterior lobe.

described by Vicq d'Azyr, but has attracted very little attention from subsequent anatomists. I have never looked for it without finding it. It consists of nucleated particles, similar to those in the grey matter of the cerebellum. The layer of grey matter external to it contains few nerve-fibres; that internal to it contains them in great numbers, passing into it at right angles.

It is not intended in this part of the article to discuss the physiology of the brain. But in order to develop more clearly than can be done in a mere description the connection of its several parts and the views of its structure which I believe to have the best foundation, I shall state briefly what appears to be the probable *modus operandi* of the organ, whether as the source of voluntary action or as the recipient of sensitive impressions.

It will be necessary first to state the following propositions as *postulates*.

1. The vesicular matter is the source of nervous power. In mental actions it is the part immediately associated with changes of the mind: whether in the working of the intellect, or in the exercise of the will, or in the perception of sensitive impressions.

2. The convolutions are the parts immediately concerned in the intellectual operation.

3. The simple exercise of the will, for a voluntary movement, is probably connected with the corpora striata.

4. The mere reception of sensitive impressions is connected with the optic thalami and the superior layer of the crus cerebri.

5. Mental emotions affect the posterior and superior part of the mesocephale.

6. The cerebellum is the regulator of the locomotive actions.

These propositions, which, it is admitted, although not improbable, are far from being proved, will serve as the basis of an hypothesis of the action of the brain.

In simple operations of thought, as in the exercise of the reasoning powers, or of those of the imagination, the convolutions of the brain are immediately engaged. We do not say that material changes give rise to the mental actions, but rather that the changes of the immaterial mind and those of the vesicular matter of the convolutions are simultaneous.

If an intellectual act gives rise to the exercise of the will, the change in the superficial vesicular matter is propagated by the fibres of the hemisphere to the corpus striatum, whereby the will is excited, and the change in the vesicular matter of that body is propagated along the inferior layer of the crus cerebri, and, after passing through the mesocephale, along the anterior pyramids to the spinal cord, each anterior pyramid acting upon that antero-lateral column of the cord which is on the opposite side of the body to itself.

The pyramids connect the vesicular matter of the corpora striata with that of the spinal cord; from their small size it is highly improbable that they can be viewed as continuations of spinal nerves up into the brain.

Simple solution of continuity of the fibres of the hemispheres, which does not cause pressure, nor affect in any way the corpora striata, would therefore merely cut off the communication between the seat of intellectual action and the centre of voluntary action. The will, although unaffected, is unable to keep up with the train of thought, and mental confusion is the result. The loss of speech, which sometimes precedes a paralytic attack, and which may remain even after the paralysis has been removed, may be accounted for in this way. The intellect is competent to shape the thought, but unable to excite the will, upon which the exercise of the organs of speech is so obviously dependent.

Changes, originating or excited in either hemisphere, may be propagated to the corresponding parts of the other hemisphere by the transverse commissures, the corpus callosum, anterior commissure, &c. How far both hemispheres are in simultaneous action, during the rapid changes of the mind in thought, can scarcely be determined; it seems probable, however, that, in certain acts of volition, one only is the seat of the change which prompts to the movement. If I will to move my right arm, the change by which that movement is prompted belongs to the left hemisphere and corpus striatum.

Certain cases of disease confined to one hemisphere, in which a considerable degree, at least, of intellectual power persists, denote that the sound one may suffice for the manifestation of the changes connected with thought, and it may be reasonably supposed that the

sound hemisphere may excite to action the centre of volition (*corpus striatum*) on the diseased side.

The existence of hemiplegic paralysis, then, implies an affection, *direct* or *indirect*, of the centre of volition (*corpus striatum*) on the opposite side. Pressure, or a morbid change in the physical state of its tissue originating in it or propagated to it, is all that is necessary for this purpose; and this change, like the change in the normal actions, may be of such a kind as to elude our means of observation.

When a sensation is excited, the stimulus acts from periphery to centre. The change is propagated by the sentient nerve to the optic thalamus, which, by its numberless radiations and its many commissures, is well calculated to excite all parts of either hemisphere, and even of both hemispheres. When the nerve excited is one of pure sense, the change is wrought more directly in the brain; if the fifth, or any of the nerves of the medulla oblongata, the stimulus acts directly on the part; but if a nerve of either limb be stimulated, the change must be propagated through the spinal cord.

It will be asked, if this be the *modus operandi* in sensations, how does it happen that disease of one optic thalamus does not impair sensation in one-half of the body? And how is it that such disease is much more frequently associated with hemiplegic paralysis, of a kind not to be distinguished from that which depends on diseased *corpus striatum*. The answer to the first question is as follows. The optic thalamus, or, more properly, the centre of sensations, is never wholly diseased, for this centre is not confined to the optic thalamus of descriptive anatomists, but extends to the mesocephale and olivary columns. Extensive disease of this centre would probably be fatal to sensation. But the most ample provision exists for opening up new channels of sensation if those on one side or a part of them be impeded. The centres of opposite sides are intimately connected, especially in the medulla oblongata and mesocephale, by commissural or by decussating fibres; the optic thalami of opposite sides are connected to each other by the posterior commissure and the soft commissure, and the immense multitude of fibres which radiate from each thalamus insure its connection with a considerable extent of the brain, so that a change in any part of it cannot fail to be communicated to some portion of the hemisphere. It is sufficient for mere sensation that the centre of sensibility should be affected. Intellectual change resulting from that affection depends upon fibres which radiate between it and the optic thalami.

It often happens that at the onset of a cerebral lesion *sensation* as well as *motion* is paralysed in the opposite side of the body. In a few days, however, the sensibility returns whilst the paralysis of motion remains,—a fact which is sufficient to show that the motor and sensitive power must have different channels in the centres as well as in the nerves. The primary paralysis of sensation may be due to a lesion on one side affecting the centre of sensibility,

or to the shock which that centre may have received from the sudden occurrence of lesion in some other neighbouring part. In the latter instance the recovery of sensibility takes place evidently on the subsidence of the effects of shock: in the former it may depend on the existence of other channels of sensitive impressions, independently of those involved in the lesion. Hence there may be lesion of one optic thalamus without loss of sensibility.

The answer to the second question is obtained from considering the intimate connection of the *corpus striatum* and optic thalamus. No two parts of the brain are so closely united by fibres in vast numbers passing from one to the other. Disease of the thalamus therefore may excite a morbid state of the *corpus striatum*, without producing any change in its structure, which may be recognised by the ordinary means of observation. And thus hemiplegia will take place, and remain as long as the morbid state of the *corpus striatum* remains. A lesion of the *corpus striatum* may in a similar manner affect the optic thalamus of the same side; but as that is not the only channel of sensitive impressions, a loss of sensibility does not necessarily occur.

Emotions are for the most part excited through the senses. A tale of woe, a disgusting or painful spectacle, a feat of wonderful power or skill, the sudden appearance of a person not expected, are calculated to produce corresponding emotions of pity, disgust or pain, wonder or surprise. But emotions may likewise be produced by intellectual change. The workings of the conscience may remind one of some duty neglected or some fault committed, and the emotion of pain, or pity, or remorse may ensue. Now emotion may give rise to movements independently of the will. The extraordinary influence of emotion on the countenance is well known, and this may affect one side of the face, which is paralysed to the influence of the will, or it may excite movements of the limbs, even when the will can exert no controul over them. From these facts it is plain that that part of the brain which is influenced by emotion must be so connected that the convolutions may affect it or be affected by it; that it may be readily acted on by the nerves of pure sense; that it may influence the spinal cord and the motor nerves of the face when the ordinary channels of voluntary action have been stopped. No part possesses these conditions so completely as the superior and posterior part of the mesocephale, which we have already noticed as concerned in acts of sensation. Is an emotion excited by an impression made upon one of the senses? this part becomes directly affected, and through the optic thalamus the emotional feeling causes intellectual change. The working of the intellect on the other hand may act on the seat of emotion through the same channel. And an excitement of this part may produce movement of a limb, or of all the limbs, through its influence on the spinal cord through the olivary columns.

The cerebellum influences the antero-lateral

columns of the cord, partly through the deep fibres of its great commissure, the pons Varolii, which interlace freely with the fibres of the anterior pyramids, vesicular matter being interposed, and partly through those portions of the restiform bodies which penetrate the antero-lateral columns of the spinal cord. It associates and harmonizes the movements of the trunk, and especially those of the lower extremities, for locomotion, through those portions of the restiform bodies which are continued with the posterior columns of the cord.

The crossed influence of deep lesion of either hemisphere of the cerebellum is difficult to explain in the absence of any proved decussation of the restiform bodies. The connection of the deep fibres of the pons, however, with the anterior pyramids in the mesocephale does afford some explanation. If, for instance, the left cerebellar hemisphere be the seat of lesion, these fibres will be affected, and they may influence the fibres of the left pyramid, which again will affect the right half of the cord and the right side of the body. Those fibres of the restiform bodies which incorporate themselves with the antero-lateral columns, are doubtless too few to produce much influence.

ABNORMAL ANATOMY OF NERVES AND NERVOUS CENTRES.—The great space already occupied by this article obliges me to compress into as small a compass as possible the observations which I propose to make under this head.

An interesting preliminary question is to determine to what extent nervous matter is capable of being regenerated, when any solution of its continuity may have occurred. In nerve it has long been proved that such regeneration is capable of taking place. If the nerve be simply divided, without loss of substance, union may take place immediately; but if a piece of it have been cut away, a considerable period must elapse before its complete restoration. This was satisfactorily proved by Dr. Haighton's* experiments, in which he found that the function of the inferior laryngeal nerve in dogs was restored six months after division of the vagus, but with altered tones. Tiedemann divided in a dog the nerves of the fore-foot and leg, and at the expiration of eight months observed that sensation and motion returned; after twenty-one months the sensitive power had increased considerably, and at length the dog regained the complete use of his foot. Schwann divided both sciatic nerves of a frog, in the middle of both thighs: immediately after the operation the frog's movements were very imperfect; after a month it had gained some power; but in three months it leaped as well as if no division had taken place. The sensibility of the foot, which was destroyed by the section, became nearly entirely restored; and irritation of the nerve with a needle above the cicatrix produced strong contractions in the muscles supplied from the nerve below the wound. On examination with the microscope, Schwann found that the cicatrix consisted of true nerve fibres disposed in their usual way.†

* Phil. Trans. 1795.

† Quoted in Müller's Physiology.

Müller mentions the interesting fact of the return of some degree of sensation in the flaps of skin used for the Taliacotian operation for a new nose, as an argument in favour of the reproduction of nerves. Dieffenbach, however, who has had so much experience in these operations, states that the return of sensibility is only very imperfect, which is to be expected, since the divided extremities of the same fibres cannot re-join, except in very small number.

The evidence of restoration of function in divided nerves in the human subject is imperfect, although not opposed to what has been above stated. Gruithusen's observations on the consequences of an accidental division of the dorsal nerve of the thumb in his own person are sufficiently conclusive. Eight months after the division, although the sensation had returned, it was so imperfect that the mind could form no conception of the precise point stimulated, as if the isolation of the fibres so necessary to exact sensation had been destroyed in the cicatrix, or as if the fibres of the peripheral portion of the nerve had not united with the corresponding ones in its central portion. Mr. Earle relates a case in which a part of the ulnar nerve was cut out; at the end of four years the little finger was useless, and the sensations very imperfect.

Indeed there is much difficulty in drawing conclusions from the restoration or non-restoration of function after division of nerves, for no artificial disposition of the cut extremities will insure the corresponding fibres meeting. A sensitive fibre may be joined to a motor, and thus the office of both would be neutralised; or different sensitive fibres might unite, from which doubtless some confusion as to the nature and position of the impression would ensue.

The microscopic examinations of Seiruch, Hermann, Nasse, and Klencke have rendered it certain that true nerve-fibres are reproduced in the cicatrix of a divided nerve. Nasse states that they are smaller than the natural size; and he has likewise pointed out an interesting fact, in the decrease of size of the fibres of the peripheral segment of the nerve as compared with those of the central segment, showing that a certain degree of atrophy takes place in that portion of the nerve, even after it has been separated for a short period from its connection with the nervous centre. This author never saw sensation and motion return, although he kept the animals for three quarters of a year. Perhaps this was owing to his having removed large portions of the nerves he operated upon.

With respect to the reproduction of solutions of continuity in the nervous centres, what little is known must be viewed as unfavourable to the supposition that perfect restoration of the lost parts takes place. If the brain or spinal cord be wounded, union will take place; but it does not appear from Arneemann's observations nor from Flourens's that the uniting substance is true nervous matter. Further researches are much needed upon this interesting subject.

Abnormal anatomy of the spinal cord and its membranes.—The membranes of the spinal cord are liable to those morbid changes which com-

monly affect the tissues of the same kind occurring in other parts of the body.

Inflammatory affections of the dura mater are exceedingly rare, and occur chiefly in connexion with wounds or injuries of the spine, or in extension of disease from the bones. Occasionally but very rarely we find osseous or cartilaginous deposits upon it, which are most obvious on its arachnoid surface. Blood is sometimes, but not frequently, effused externally to it, and effusions of serous fluid are still more rare. Such effusions, from the usually dependent position of the spinal canal, and from the large venous plexus which exists around the dura mater, are very likely to be pseudo-morbid, resulting from the gravitation of the fluids after death. Cancerous or fungoid tumours may originate from the dura mater, or may arise externally and grow to it afterwards. Tubercles may form between the dura mater and its arachnoid lining.

When a deficiency of more or less of the posterior osseous wall of the spinal canal occurs, we find a corresponding dilatation of the dura mater and arachnoid sac, which, being filled with water, causes an external tumour, constituting what has been called *Hydrorachis*, the consequence of *spina bifida*. These tumours are altogether dependent on the congenital imperfection of the bones of the spine, and whatever peculiar disposition of the spinal cord or its nerves may be found within them is due to an arrest of or a disturbance in the process of development of those parts. The details of the anatomy of these tumours will be found in the article SPINE.

The arachnoid.—The spinal arachnoid exhibits marks of the inflammatory process more frequently than the dura mater. But in neither membrane does this state of disease occur often, except as a complication of injury or of a morbid state of other parts, either of the vertebral column or of the spinal cord itself. The signs of an inflamed state of this membrane are lymph effused on its free surface, recent, or indurated causing more or less thickening. Adhesions between corresponding parts of the two arachnoid layers are also a good indication of a previously existing inflammation. But care must be taken not to mistake the adhesion, which is often found between points of these membranes, for inflammatory adhesion. The former occurs in minute points, and is probably a result of drying of the membranes at the points of contact; the latter is always accompanied by the formation of new matter which forms the medium of union between the layers.

Cartilaginous spots are by no means unfrequently found on the arachnoid membrane, chiefly in connection with its visceral layer. They are generally small detached laminae thoroughly incorporated with the membrane, rarely exceeding in size the flat surface of a split pea, more frequently much smaller. They generally occur on the posterior surface of the arachnoid. I have seen such deposits in cases where there were no previous symptoms to denote any affection of the central nervous system, and I am disposed

to believe that such deposits, separated as they must be from the surface of the cord, are not likely to occasion much if any irritation to that organ. They are found mostly in the dorsal and lumbar regions. Sometimes spots of bone, of similar size and shape, are found scattered over the membrane.

The pia mater.—The spinal pia mater being the seat of the vascular ramifications which contribute to the nutrition of the cord, is also subject to congestions often depending on causes quite extraneous to the spinal canal or cord. Thus the congestions which are produced in animals drowned, or asphyxiated in any other way, exist in the vessels of this membrane. The most frequent cause of congestion in these vessels, however, is the position of the corpse after death. After deaths, preceded by violent convulsions, there is always congestion of the vessels of the pia mater. But this congestion must be regarded as a consequence, not as a cause of the convulsions. The holding of the breath, which accompanies continued convulsions, gives rise to a very general congestion of the venous system.

When the congestion is very considerable, it may occasion rupture of bloodvessels and effusion of blood into the sub-arachnoid cavity. This constitutes a form of *spinal apoplexy*, which is apt to follow concussion of the cord, caused by a fall or by a blow inflicted upon the back. It may follow any of those diseases which are accompanied by convulsions—tetanus, hydrophobia, epilepsy, cerebral apoplexy.

Inflammatory affections of the membranes, deposits of tubercle or other foreign matter which may cause induration of the cord, have their primary seat among the vessels of the pia mater. Inflammation of the membranes is more apt to occur among children than in adults.

Abnormal anatomy of the spinal cord.—The absence of this organ (*amyelia*) occurs chiefly in anencephalous fetuses. In such cases the posterior wall of the spinal canal is often deficient, and the canal is occupied by a reddish, vascular pulpy substance. It is a question whether the absence of the cord, in such cases, is to be attributed to a real defect of its development or to its destruction while yet in a very delicate semi-fluid state, by the formation of a dropsical effusion, either around it or in the canal or ventricle which exists in it at an early period of its development. This latter explanation is rendered probable by the fact that all the recorded cases are of fetuses which had reached an advanced period of intra-uterine development; and in some of them movements had been distinctly felt by the mothers, which could not have taken place with a combined or definite character without the existence of the cord. And in some of the records it is affirmed that the children lived some hours and exhibited movements and even signs of sensation, or at least of excitability to stimuli. Such phenomena, if true, leave us no alternative but to suppose that the whole cord could not have been absent—some portion must have existed as the centre of these movements,

but, being of small size, it escaped the notice of the observer.

This explanation is likewise confirmed by the occurrence of cases (rare, it is true) in which the brain existed, but the spinal cord was wanting. A very able narrative of a case of this kind has lately been published by Dr. Lonsdale of Edinburgh. "The anterior and middle lobes of the brain appeared to be properly developed, and occupied their usual positions in the cranial cavity; whilst the posterior lobes were much smaller, and were partially squeezed through a large abnormal opening or deficiency in the occipital bone. The cerebellum and that part of the occipital bone in which it is normally lodged, were wanting. There was not the slightest vestige of medulla oblongata or spinal cord, and the posterior arches of the vertebræ did not exist."* The fetus had reached its full term, and its body and limbs were well formed.

An interesting feature which had been well observed in this case, although probably not peculiar to it, but hitherto overlooked, was the relation of the nerves in the cranial and spinal cavities. All the nerves of the medulla oblongata, and the first, second, and third cervical nerves, hung as loose threads in the cranial cavity or in the upper part of the spinal canal, and presented a looped arrangement, seeming to denote that such is their normal disposition in the nervous centre.

Partial deficiencies of the spinal cord, although also rare, are more frequent than the total absence of the organ. These occur in connection with other defects of development. Thus, in spina bifida much of the cord is deficient, either throughout its entire extent or in those parts where the vertebral wall is defective. In such cases it is probable that the deficiency is attributable to the destructive influence of the dropsical effusion rather than to an original defect of the organ. In cases in which the upper or the lower extremities have not been developed, the usual cervical or lumbar swelling is imperfectly developed, owing to the absence or atrophy of the fibres which would have formed the nerves to those limbs.

Excessive congenital development of the spinal cord occurs only in those monstrosities which arise from the junction or fusion of the spinal columns of two embryos.

The diseased states of the spinal cord may be enumerated as follows:—hypertrophy, atrophy, induration, softening, suppurating, deposits of tubercle or of other morbid products.

In hypertrophy, the cord is enlarged and looks full and plump, without any alteration of its consistence or of its intimate structure. It is not improbable that the elementary fibres as well as the vesicles of grey matter may be enlarged in such cases, and that the increased dimensions of the whole organ must be attributed to this cause, and not to the deposition of any new material in it. I have not, however, had any opportunity of ascertaining this point by microscopic examination.

* Edin. Med. and Surg. Journal.

Atrophy occurs in the cord generally as the result of some local pressure from a tumour developed in connection with some one of the membranes or external to them. In a case of this kind which I lately examined, the tumour consisted of a mass of scrofulous matter situated between the vertebræ and the dura mater in the upper part of the dorsal region. That part of the cord which was pressed upon by the tumour was wasted to one-half its natural size, whilst below it the cord exhibited its natural size.

Atrophy of the cord occurs as part of that general wasting of the nervous centres which accompanies advanced life, or a state of general cachexy. In persons long bedridden the cord is found in a wasted state; and in cases of extensive hysterical paralysis, in which exercise of the enfeebled limbs has been neglected, the cord will participate in the wasting of the nerves which supply the affected parts.

Induration of the cord is not of unfrequent occurrence, and appears to be the result of some abnormal nutrition analogous to if not identical with chronic inflammation—inflammation modified, perhaps, in the nature of its event by some peculiar state of the blood. The hardness occurs generally in patches, involving more or less of the thickness of the cord, and affecting the peripheral parts of the body, in proportion as it involves the immediate points of implantation of the roots of the nerves, or those roots themselves. It is generally accompanied by some discolouration of a light brownish hue, as if the first changes which gave rise to it were attended with extravasation of the colouring matter of the blood.

Sometimes, however, induration seems to result from the changes which accompany atrophy of the cord, as if from an imperfect supply of the fluids necessary for perfect nutrition.

Softening of the cord is found in two states, which are probably essentially different in their intrinsic nature and origin. One is that of red softening; the other is that of white or colourless softening. In the former the tissue of the spinal cord is much softer than it ought to be, and is readily disintegrated by a stream of water directed upon it; its colour is due to the full injection of the bloodvessels which traverse it, or to some extravasated blood. In the latter the nervous matter is reduced to a soft semifluid mass, like thick cream, without the least appearance of injected vessels. In the former the nerve fibres are more or less broken down and softened; in the latter there is little or no breaking down of the fibres, but they are attenuated and have lost the distinctive characters of the white substance and central axis to a greater or less degree. Red softening appears to be inflammatory in its origin, but white softening indicates a deficient supply of blood, and so far resembles the gangrene which occurs in external soft parts.

The anatomist should be prepared to distinguish the white softening, which is the product of a morbid process during life, from that which occurs after death as the result of decomposition, or which may be produced by violent compression of a part of the cord in opening

the spinal canal. The softening which results from decomposition, in general, occupies the greatest part of the cord or the whole of it, and does not exhibit so pure a white colour as the morbid softening. It sometimes has a greenish or a dusky hue, and is more or less fetid. The softening from injury is very circumscribed, and is surrounded by nervous matter perfectly healthy in colour and consistence. There is, moreover, generally evidence of injury to and rupture of the pia mater, the softened matter of the cord protruding through the rent in this membrane. Where the softening is morbid, it wants the abruptness which occurs in the latter case, and the diseased part gradually passes into healthy structure.

The inflammatory softening is sometimes infiltrated with purulent matter, which, if not recognizable by the naked eye, may be easily detected by the microscope and by reagents. In rare cases the pus is collected into a circumscribed abscess, occupying more or less of the thickness of the cord.

The cord may be the seat of an effusion of blood, and may thus present the condition of apoplexy, like that which is of so frequent occurrence in the brain. In such cases there may be more than one small clot occupying the central part of the cord. They are of rare occurrence, and are generally found in the upper part of the cord.

Tubercle may occur in the cord, and, as in the brain, connected with the pia mater, either deposited in a group or forming a mass which gradually encroaches upon the substance. The cervical region is that in which it most frequently is found, and it forms tumours of various sizes, each of which is generally enclosed in membranous cyst.

Cancer of the cord is a lesion of extremely rare occurrence. Ollivier relates several cases of it, but Rokitsansky remarks that he has seen but one example of a cancerous tumour in the spinal cord. It is in cases where the cancerous diathesis prevails, and where cancerous matter is deposited throughout various parts of the body, that we may look for it in the cord.

Abnormal anatomy of the brain and its membranes.—The remarks already made with reference to the membranes of the cord apply equally to those of the brain. The latter membranes, however, are more frequently found in an abnormal state than the former.

The dura mater.—There may be a general or partial deficiency of the dura mater and of the other membranes according as there is a general or partial defect in the brain itself.

The partial defect is mostly observed in the falx cerebri or in the tentorium cerebelli. The cribriform appearance of the former process is of frequent occurrence and is unaccompanied by any obvious defect in the brain, and sometimes even a considerable portion of it is wanting, while the brain is quite normal.

Acute disease of the dura mater is rare, and only occurs as an effect of wounds or injuries of the cranium, or in connection with syphilitic or strumous disease of the bones; or, independently of diseased bone, as an effect of the

syphilitic poison, like that which occurs on external fibrous membranes. A syphilitic inflammatory state of the dura mater is frequently the cause of serious affection of the brain. A condition analogous to that of *nude* will cause pressure on the brain and paralysis; and, whilst it resists the ordinary antiphlogistic treatment, will speedily yield to antisiphilitic remedies, such as mercury and iodide of potassium.

We meet with great variety as regards the firmness of adhesion of the dura mater with the cranium. There is a tendency in some perverted states of nutrition for this membrane to become incorporated with the inner table of the skull. This seldom takes place continuously, but in patches, so that in removing the calvaria a portion of the inner table of the skull remains in connection with the fibrous membrane, or a hole is left in the latter when the conversion of the fibrous membrane into bone may be complete. It is in the more advanced periods of life that this morbid condition is chiefly found; indeed we seldom open the skull of a person who has passed the age of threescore without finding more or less of it. At that period of life it may be regarded rather as one of the series of changes which accompany advancing years than as a diseased state. When, however, it occurs at the earlier ages, it must be viewed as resulting from a morbid process.

Patches of bone are frequently found in the processes of the cranial dura mater, as in the falx, tentorium. They occur more frequently in the former than in the latter. In size they vary much: they are placed between the layers of the dura mater, and are completely enclosed by them; sometimes, however, they encroach upon these layers, which then seem as if they had been completely converted into bone.

Fibrous tumours are sometimes formed at various parts of the dura mater. These vary considerably in size and number. They project inwards upon the brain, and indent that organ more or less according to their size, and sometimes they project outwards, and by causing absorption of the bone by pressure form depressions for themselves, and even wear holes in the bone by their outward growth.

Tubercles of a strumous character are sometimes deposited in connection with the dura mater. The most remarkable example I have seen of these morbid tumours is a preparation in the museum of King's College, London, taken from a patient who suffered severely from epilepsy. The internal surface of the dura mater and of the falx is covered with numerous tumours of this kind, some of which are nearly as large as a walnut, others not larger than a small filbert. This specimen belonged to the collection of the late Dr. Hooper, who has given an excellent delineation of it in his plates of the morbid anatomy of the brain.

The dura mater participates in the diseased states of the cranial bones. Cancer or fungoid disease affecting the calvaria or any part of the cranial wall which is covered by dura mater, will extend to the dura mater and subjacent parts.

When there has been a solution of continuity and a loss or removal of any portion of the cranium, the exposed surface of the dura mater is apt to throw out a growth of granulations which constitute *the fungus of the dura mater*, analogous to that which sprouts from the surface of a similar fibrous membrane—the tunica albuginea of the testicle. In point of structure this fungoid growth is the same as the granulations on the surface of external ulcers.

Effusion of blood, constituting a form of meningeal apoplexy, may occur on the external surface of the dura mater separating it from the bone; or on its internal surface, dissecting away the arachnoid membrane from its adhesion to the dura mater. The former kind is mostly if not always traumatic, that is, resulting from the application of violence to the exterior of the cranium. The latter kind is of extremely rare occurrence, and must be carefully distinguished from that variety of effusion into the arachnoid sac in which the effused blood appears to be covered by a serous membrane. This membrane, however, results from the condensation of the superficies of the clot by its friction against the parietal arachnoid, and it may be distinguished from a true serous membrane by the absence of epithelium from its free surface. Effusions of either kind generally occur on some part of the surface of the cerebral hemispheres above the level of the petrous bone.

The arachnoid membrane.—The arachnoid membrane is sometimes the seat of acute inflammation, and presents the same signs of that process as are met with in other serous membranes. The chief and, indeed, the only unequivocal sign of his condition as of recent occurrence is the exudation of plastic lymph upon the free surface of either or both layers of the membrane, with or without pus. This is attended with a highly injected state of the subjacent tissue (pia mater or dura mater, generally the former). The arachnoid itself, it will be remembered, contains no blood-vessels, but derives its nourishment from the vessels of the subserous tissue. Its apparent vascularity is due to its great tenuity and transparency, which allow the bloodvessels lying underneath to be seen through it as if they belonged to the membrane itself.

An opaque condition of the arachnoid, varying both in degree and extent, is a very common appearance of this membrane, especially at the middle and advanced periods of life. This occurs sometimes in patches; at other times it is generally diffused over the whole membrane. It is most conspicuous on the convex surface of the brain, especially towards the great longitudinal fissure, and it is frequently associated with large and numerous Pacchionian bodies. It occurs, however, very commonly at the base, and frequently opposite the conflues of the subarachnoid fluid.

The opacity of the arachnoid is commonly attributed to a former acute inflammation of the membrane, or to a chronic inflammation going on up to the time of death. But this state of the membrane is of such frequent occurrence, and is so often found in persons who

evidenced no sign of important organic change during life, that it seems scarcely correct to attribute it to such a cause. It is not meant to deny that previous inflammation or chronic inflammation is capable of causing these opaque spots, but undoubtedly other causes may produce them as well. The friction of two opposed surfaces may do it, and deposits upon the free surface of the membrane, an altered condition of the epithelium, may have the same effect. Some recent microscopical examinations convince me that morbid deposits similar to those which are formed on the coats of arteries, may be found here, and occur in those morbid states of the blood, and consequently of the whole system, which are favourable to the deposition of a morbid material throughout the arterial system, or in the substance of viscera.*

In confirmation of this view it may be stated that opacities of the arachnoid are most common after the middle period of life, and that they are then almost uniformly associated with a morbid state of the arteries of the brain and of other portions of the arterial system.

Adhesion between the opposed surface of the visceral and parietal layers of the arachnoid is (and the fact is curious) not of frequent occurrence, excepting at the convex border of the falx cerebri, where the Pacchionian bodies are found. And the intrusion of these bodies into the longitudinal sinus frequently increases the closeness of that adhesion. The cellular adhesion so common in other serous membranes is rarely found in the arachnoid.

Small plates of cartilage or of bone are sometimes found in connection with the arachnoid. Their formation is generally the result of a previous morbid deposit which has subsequently become converted into cartilage or bone.

Effusion.—Effusions take place either into the subarachnoid or the arachnoid cavity. The existence of serum, in undue quantity, in the former situation, must be looked on as an increase in the fluid which naturally occupies that space, and as we have already remarked in a former part of this article, it takes place in consequence of the failure of the normal pressure upon the vascular surface, and may rather be regarded as tending to preserve the functions of the brain than as producing an injurious pressure upon it. Indeed I have always found that in cases where an abnormal quantity of fluid existed in the subarachnoid cavity, the brain afforded no indication of its having experienced undue pressure previous to death. In such cases the brain seems to contain less blood than natural, and its anæmia is most obvious in the grey matter. Sometimes there is hyperæmia of the veins in the white matter of the hemispheres, as if the heart's force, more necessary to the venous circulation within the cranium than even to that of other parts of the body, had been prevented from exerting its influence through the capillaries upon the blood in the veins.

* It is probably to deposits of this kind that Rokitsansky refers under the title of "Gallenfettige Concretionen."

The existence of serous fluid in the arachnoid cavity is of very rare occurrence. In some instances old adhesions of the two layers of arachnoid to each other circumscribe a space in which fluid accumulates.

Blood is sometimes effused into the subarachnoid cavity. This is frequently the case in injuries of the head, the blood escaping from broken vessels of the pia mater. Sometimes the blood effused into either lateral ventricle will escape into the subarachnoid cavity, breaking down the membrane of the ventricle. If an apoplexy occur near the surface of the brain, the laceration of the cerebral substance may extend quite to the surface, and the blood may pass through the pia mater into the subarachnoid space.

In some instances we find blood in the cavity of the arachnoid (the arachnoid sac). The blood is either loose in the sac, or it is more or less closely connected with the inner surface of the membrane lining the dura mater.

In a recent communication from Mr. Prescott Hewitt, published in the last volume of the *Medico-Chirurgical Transactions*, the principal facts relating to this subject have been collected and arranged in an interesting form. Mr. Hewitt describes these effusions of blood as existing in four forms:—

“1. The extravasated blood may be either liquid or coagulated; if in the latter state, it may be in clots, or spread out in the shape of a thin membranous layer, covering a greater or less extent of the surface of the brain.

“2. Sometimes the extravasation presents itself under the shape of a false membrane, possessing more or less of the original colour of the blood.

“3. The blood may be fixed to the free surface of the arachnoid and there maintained by a membrane, which to the naked eye presents all the characters of the serous membrane itself.

“4. The blood is frequently found enclosed in a complete cyst of various degrees of thickness, which may be removed unbroken from the cavity of the serous membrane.

“The four divisions above referred to,” adds Mr. Hewitt, “may be and often are combined with each other, but in whatever state the extravasated blood has been found, it has, in the majority of cases, corresponded to the upper surface of the brain, and has been rarely met with in the cerebellar fossæ.”

It is impossible that these effusions of blood can have any other source but the minute bloodvessels of the pia mater or the dura mater, which becoming ruptured allow the blood to burst through the serous membrane by which they are covered. They occur mostly in persons of a scorbutic or hemorrhagic habit, or in whom the arteries have become brittle from abnormal deposits in them; and it is not improbable that whilst the imperfect nutrition of the arteries is going on, the serous membrane itself suffers, becomes wasted, and therefore easily yields to the force of the blood as it escapes from the bloodvessels.

Pus is found in the subarachnoid cavity

where there has been inflammation of the pia mater and arachnoid, and more rarely in the arachnoid sac.

Of the pia mater.—This membrane being the vascular membrane of the brain, and containing the nutrient vessels as well of the surface of the brain as of the visceral layer of the arachnoid, is the seat of all those changes in the condition of the bloodvessels or of their contents, which give rise to, or are caused by, morbid states either of the nervous matter or of the serous membrane.

All those changes which indicate hyperæmia or anæmia of the convolutions of the brain occur in the pia mater; and the colour of this membrane will vary according to the quantity of blood contained in its bloodvessels.

There are no definite signs which enable the anatomist to pronounce whether an hyperæmia be of the active and inflammatory kind, or passive, and dependent on some cause remote from the brain itself, or even upon a post-mortem cause, unless it be accompanied with those undoubted products of the inflammatory process, pus or lymph.

A highly injected state of the vessels of the pia mater will frequently be caused by the manner of the patient's death. Where the respiratory actions have been laboured and difficult prior to death, this is sure to occur: we find it also when death has been caused by asphyxia, however produced.

In convulsive diseases the pia mater and the whole brain become highly injected more as a consequence of the impeded circulation caused by the struggles of the patient interfering with the due exercise of the respiratory movements, than as the cause of the convulsions. Indeed, there seem good grounds for believing that convulsions are more frequently caused by a deficient supply of blood to the brain than by a superabundant flow of it to that organ.

The pia mater is the seat of the principal morbid deposits which affect the brain. Of these tubercle is among the most common; it most frequently occurs on the surface of the convolutions; but it may be found wherever the pia mater exists, either in the interior or on the outside of the brain. It occurs less frequently on the pia mater of the cerebellum than in any other situation.

The tubercular deposit in the pia mater commences by the development of minute granulations of a grey, clear, or semi-transparent material. These are deposited close to each other over a greater or less surface, forming a group, and several such groups may be formed near each other. After a time this grey material is changed into a yellow granular matter, which is sometimes enclosed in a cyst.

Tubercular matter originally deposited on the surface of the pia mater in the sulcus of a convolution may have the appearance as if it had been formed in the substance of the brain. The sulcus is obliterated, and the tubercle, enlarging towards the brain, becomes, in a short time, surrounded by cerebral matter.

Sometimes tubercle deposited in some part of the pia mater excites inflammation in the pia

mater and arachnoid immediately near it,—*tubercular meningitis*; and this may affect more or less of the substance of the brain in its vicinity, causing red softening.

Cerebral tubercle is seldom or never alone. Other organs of the body are almost invariably affected at the same time, the lymphatic or the mesenteric glands, or the lungs. It is most commonly found in children, and it is not improbable that it may lie dormant for years until roused to action by some newly-developed morbid excitant.

Connected with diseased states of the membranes of the brain, it should be remarked that in many instances acute affections of the membranes of the brain find their point of departure in inflammation of the sinuses. The sinus which is most frequently inflamed is the lateral; the inflammatory state of this spreads to the neighbouring arachnoid and pia mater, and induces all the consequences of a primary meningitis.

Of the abnormal states of the brain.—The abnormal conditions of the brain may be considered under the heads of—1, *congenital*; 2, *acquired or morbid*.

1. *Congenital abnormal conditions.*—A total defect of the brain is found in that state in which the head is wanting (*Acephalia*); and also where there is deficiency of the parietal bones of the cranium, the occipital, temporal, sphenoid, and frontal being present in an imperfect state, and there being also, in general, spina bifida of the upper cervical vertebræ, there is a deficiency of a considerable portion of the encephalon, the medulla oblongata or a portion of it being alone present (*Anencephalia*).

The acephalic state is very frequent. It is always associated with complete or nearly complete absence of the cranial bones, and frequently more or less of those of the spine. In some the trunk and extremities are perfect, but in very many there are deficiencies to a greater or less degree in the formation of these parts.

In anencephalia there is a defective state of encephalon, but not an absence of it; and it seems highly probable that this condition is due, not so much to an original arrest of development as to the occurrence of an hydrocephalic state at an early period of intra-uterine life, the accumulated fluid breaking down the newly formed nervous matter, which wants the support of the cranial bones.

The extremest degree of this defect is when a large portion of the cranial bones is wanting, and also when there is a large fissure in the spine. In other cases the spinal fissure does not exist. The cranium is largely open on its posterior and superior aspect, the head thrown back, the neck very short and thick, the eyeballs very large and prominent, and the mouth partially open, giving to the features a very hideous expression.

The hollow of the base of the cranium is, in these cases, filled up by a red, soft, highly vascular substance, continuous with the pia mater of the spinal cord. This, in general, appears to be nothing more than the cranial pia mater, which has collapsed into this state by the de-

struction of the nervous matter, and in which sometimes small masses of nervous matter may be discovered here and there. It is covered by a smooth membrane, which may be an imperfect arachnoid. In some instances, however, the tumour is of considerable size, more voluminous, according to Geoffroy St. Hilaire, than even the normal brain. It is disposed in lobes, which resemble somewhat those of the brain, and which sometimes contain a considerable quantity of serum.

In less degrees of this condition the cranial bones are more developed, the skull is less open, and the brain and its membranes exhibit a greater degree of perfection. In all the cases water is accumulated in the cerebral cavities. The following case quoted from Penchienati by Breschet in his article *Anencephalie*, in the *Dictionnaire de Médecine*, illustrates the appearances in a by no means advanced stage of the deformity. The subject was a girl which had lived three days. The corpora striata, optic thalami, were present with the hemispheres. The lateral and third ventricles were greatly enlarged. The tubercula quadrigemina retaining their vesicular condition were likewise present, and also the pineal gland. These parts presented at the superior part of the cranium a red eminence which was uncovered by the skin.

In some cases where the degree of openness of the cranium is reduced to a fissure, in front or behind, a tumour is found protruding through either fissure, consisting of the brain, imperfectly developed, inclosed in its membranes. This condition is frequently combined with a greater or less extent of spina bifida.

The partial deficiencies of the brain itself are infinitely various. Those parts which are most frequently either altogether absent or imperfectly developed, are those which are not essential to the production of the organic vital phenomena. The commissures are very frequently wanting, the smaller ones oftener than the larger, such as the corpus callosum and the pons Varolii. The hemispheres of the brain are frequently very imperfectly developed. The medulla oblongata and mesocephale rarely exhibit any material imperfection.

In all cases of idiocy there is a manifest imperfection in the development of the brain. This is sufficiently plain to the most superficial observer from the small size of the head which is so frequent a character of this state, and which is more especially remarkable in adult life, where the development of the cranium by no means keeps pace with that of the rest of the body.

As an example of the class of changes which take place in the brains of most idiots, I shall describe the appearances observed in the brain of an adult idiot which I examined in October, 1844.

On the upper surface of the brain the convolutions were not developed; the surface of both hemispheres was perfectly smooth. The tissue of Sylvius was very deep and well marked, extending upwards and backwards; at its posterior extremity there was a slight puckering

indicating a feeble development of the insula of Reil.

A few fissures and imperfectly developed convolutions were found upon the inferior surface of the middle lobe, as well as upon the lateral and inferior surfaces of the anterior lobe.

The olfactory fissures were perfect but very small; the olfactory nerves appeared natural.

The optic nerves were natural but small.

The tuber cinereum was large and well developed.

The corpora mamillaria appeared to be fused together along the median line.

The pons Varolii very narrow from before backwards; the groove which passes along its middle was imperfect.

The corpus striatum was exceedingly small, and the groove between it and the optic thalamus was greatly increased in size. The tænia semicircularis was large.

The convolution of the corpus callosum was very imperfectly developed. The hippocampus major was very small, and there could scarcely be said to be any trace of the hippocampus minor.

The fornix was well developed, as was also the corpus callosum. The longitudinal tracts on the surface of the corpus callosum were also well developed.

The pineal gland was large and situate very far forwards, corresponding very nearly to the middle of the optic thalamus. The quadrigeminal tubercles seemed imperfectly developed, and the distinction between them was badly marked.

The optic tract was small, but natural in its connections. The cerebellum was well developed: its laminæ seemed natural. The lateral ventricles were large and rather dilated. The entire brain, after having lain in spirits for some days, weighed 1 lb. 4½ oz. avoirdupois.

In some instances the hemispheres of the brain are fused together, there being little or no trace of a longitudinal fissure to separate them. This condition occurs generally in the Cyclopic monsters, or in monsters in which there is a total absence of the organs of vision. Where there is this singleness of brain there is also sometimes a fusion of the corpora striata and optic thalami of opposite sides together.

A total absence of all the transverse commissures of the brain constitutes, as Rokitansky observes, the opposite condition to that just detailed.

Idiotcy results from any change which impairs to a material extent the structure of the hemispheres of the brain and of the fibres by which they are connected to each other, as well as to the other parts of the encephalon. All the recorded instances of dissections of the brains of idiots shew that the evil consists in such an impairment of the hemispheres and their convoluted surface as must have materially prevented their proper action. This may have begun in intra-uterine life or in infancy. The brain of infants at birth is far from being fully formed, and that part of it which is imperfectly developed is that upon which depends the manifestation of mental actions, namely, the hemispheres of the brain and of the cerebellum; the

other parts, which are mostly concerned in physical nervous actions, are sufficiently perfect, being, however, generally small from the influence of the deficiency of the hemispheres.

Hypertrophy of the brain would occasion idiotcy, just as well as atrophy or imperfect development of that organ (*agenesie*). Well-marked cases of idiotcy resulting from the former cause are, however, as far as I know, yet wanting in medical records.

When there is a deficiency in any part of the cranial wall, a protrusion of a greater or less portion of the brain takes place—this constitutes *hernia cerebri* or encephalocele. It is in point of size proportionate to the size of the opening in the cranium. The tumour is covered externally by the common integuments, and the displaced portion of the brain pushes before it the dura mater and the other membranes of the brain.

The most frequent situation for *hernia cerebri* is in the occipital region of the head near the middle line, and next in point of frequency somewhere on the median line, where the bones of opposite sides remain for so long a time disunited: near the great fontanelle is a frequent site of a protrusion; sometimes it takes place on the side of the skull in the temporal region, or at the root of the nose. Such cases, however, are rare.

2. *Morbid conditions of the brain.*—*Hypertrophy.*—The examples of hypertrophy of the brain which are on record are not numerous, and it is difficult to attribute the appearances, which are said to indicate this condition, to a mere increase in the nutrition of the organ. Adopting the term, however, in deference to the high authorities who have applied it, it may be stated that the anatomical characters of a hypertrophic brain are as follows:—

The brain appears too large for the skull; on the removal of the calvaria the dura mater seems perfectly tense and filled by the brain; it appears thinner and more transparent than is quite normal, and there is no trace of fluid in the subarachnoid space.

The hemispheres are large, and their convolutions lie closely packed beside each other, and flattened. The ventricles of the brain are small, exhibiting the same condition as the fissures between the convolutions. The surface of the arachnoid as well as of the intra-ventricular eminences is dry or nearly so.

The substance of the brain is universally firm, and cuts somewhat like cartilage; it is exsanguineous, the principal accumulation of blood being in the pia mater. The colour of the grey matter becomes so changed as to be scarcely different from the white.

It is as yet uncertain what is the precise change which the brain undergoes in this condition. We know that there is an increase of substance, but whether that be an increase in the normal *size* of the fibres and vesicles of the two varieties of nervous matter which are found in the brain, or in their *number*, or whether it be a deposition of new material, with or without increase in the size or number of the ele-

mentary parts of the organ, has yet to be determined by microscopical examination.

It is most probable that the disease consists not merely in an increased, but also in a perverted nutrition, and that new material is deposited between or in the proper anatomical elements of the brain.

In some instances there is, along with the signs of increased nutrition in the brain, evidence of a similar condition of the cranial walls. The bones of the skull are, in such cases, much thicker than usual. In others, however, the bones seem to yield under the pressure from within, and they become thin, and more or less transparent in parts.

There appear to be two classes of cases in which an hypertrophic state of brain occurs. In one class the functions are carried on well, and the only sign of the morbid change is derived from the undue enlargement of the head, which becomes almost too large for the body, and too heavy for the muscles of the neck to support conveniently; in the other there may or may not be enlargement of the head, but there are marks of cerebral disturbance in more or less dullness of intellect, and in the frequent recurrence of epileptic fits.

Dr. Watson has placed upon record two instances of this enlargement of the brain's substance which are highly interesting and will serve to illustrate the varieties above alluded to.

One case was that of a young woman *æt.* 19. Her countenance was sallow, lips pale. She complained of pain in her chest and limbs, of great and increasing debility and wasting, and of nightly perspirations, and she was subject to attacks of epilepsy. She died in a prolonged epileptic paroxysm. The following appearances were observed at the post-mortem examination.

"When the surface of the brain was exposed by the removal of the skull-cap and dura mater, it was observed that the convolutions were remarkably flattened, so that the little furrows between them were nearly effaced, and the surface of the arachnoid membrane was perfectly dry. These are not very unusual, although they are unnatural appearances. I had often seen such before; and I ventured to say we should find some cause of strong pressure in the central part of the brain, effusion of serum into the ventricles, or a large extravasation of blood. But to my great surprise, and much to the discredit of my prophecy, we found nothing of the kind. The ventricles were even smaller than natural, and contained scarcely any moisture. The skull-cap was afterwards examined, and the bone was found to be uncommonly thick, dense, and heavy; and its inner surface without being rough was very irregular." The state of the bloodvessels of the brain was not noticed. It is to be regretted likewise that the weight of the brain has not been stated, for it is obvious that a gradual and pretty uniform diminution of the cranial cavity by the thickening of the bone might have produced the flattening and condensation of the brain described.

A second case recorded by Dr. Watson occurred in the practice of the late Dr. Sweetman. The patient was a little boy two years old; his

head had been gradually increasing from the age of six months until it had become so large as to prevent the child from continuing long in the upright posture. The boy was active and lively although thin. He never had any convulsion, but occasionally seemed uneasy, and then would relieve himself by laying his head upon a chair. He had never squinted, nor was he subject to drowsiness or startings during sleep, and his pupils contracted naturally. His appetite was good, and all the animal functions were properly performed. The head measured from ear to ear twelve inches, from the superciliary ridges to the occipital thirteen inches, and in circumference twenty-one inches. The brain was sound. The convolutions were distinct and retained their shape. The surfaces of the medullary matter, exposed by different sections, presented very unusual vascularity.*

In this case the yielding of the cranial walls prevented compression of the brain, whilst it admitted of the growth of the organ within. Hence, no doubt, the absence of any symptoms of compressed or irritated brain.

Hypertrophy of the brain sometimes coexists with hydrocephalus, and is congenital, and prevents by the great size of the organ the development of the cranial bones. (Otto, Rokitsky.)

Hypertrophy may affect only particular parts of the brain, as the optic thalami, the pons, and the medulla oblongata, instances of which have been placed on record.

Atrophy of the brain.—At the advanced periods of life we generally meet with more or less of wasting of the brain, resulting from a change in the nutrition of that organ which it experiences in common with all other organs, and which is only the natural result of the progress of age. It is remarkable, however, how much more of this *senile atrophy* is observed in some individuals than in others.

In cases of epilepsy of long standing I have invariably noticed wasting of the brain, affecting chiefly the convolutions, or sometimes the corpora striata, optic thalami, &c. The brain wastes likewise in cases of long-continued intemperance, the patient generally dying of delirium tremens. In such instances all parts of the brain waste, but the convolutions experience the most marked change.

The following are the marks of an atrophied state of brain. There is a considerable quantity of fluid in the subarachnoid cavity, indicating an increase in the interval between the surface of the brain and the interior of the skull. The brain has a shrunk appearance. Its texture feels firm, and in cutting the knife grates against it as in cutting cartilage. In point of colour the grey matter is frequently extremely pale, and scarcely to be distinguished from the adjacent white substance; in some instances, however, it is of a dark brownish hue. In all cases the layer of grey matter which covers the convolution is much less deep than is natural. The convolutions are evidently shrunk, and the sulci between them have greatly increased

* Lectures on the Practice of Physic, vol. i.

in width. The white substance of the brain has increased in density, and in the transverse section several vessels are cut across, the section of which occasions numerous bloody points upon the surface of the centrum ovale. The corpora striata, optic thalami, pons, and medulla oblongata are all obviously shrunk and firm in consistence.

In several instances of persons long bed-ridden, I have noticed a shrunk state of the cerebellum, with or without atrophy of the cerebrum. The layers of white matter in the cerebellar laminae look particularly small; and in the section the white layer seems to shrink in within the fold of grey matter in which it is involved.

As a constant accompaniment of the wasted brain, we find a more or less opaque condition of the arachnoid membrane, with considerably enlarged Pacchionian bodies. The ventricles of the brain, too, are generally wide and contain a good deal of fluid. There is also very frequently a diseased state of arteries, atheromatous or ossific deposits being scattered freely amongst those, which form the circle of Willis, and their principal branches.

Atrophy of particular parts of the brain is of not unfrequent occurrence, either in cases where particular nerves are atrophied, as the optic nerve, inducing atrophy of the opposite optic tract or of that of the same side, and of the quadrigeminal bodies on the side of the wasted tract; or where from previous disease of a portion of the brain the remainder of that part has wasted—as wasting of the corpus striatum from the previous existence of a small clot in it, or of a red softening.

Softening.—One of the most common changes of structure in the brain is *softening*. This is of two kinds, namely, white softening, or that without discoloration, and red softening, or that with discoloration.

White softening.—The anatomical characters of the true white softening may be thus described. The diseased portion has diminished considerably in its consistence; if it be gently rubbed with the edge of a knife it becomes obviously disturbed by an amount of friction which would produce no change upon the surface of a healthy brain; a stream of water directed upon it, even with slight force, is sufficient to break it up and separate as well as rupture its constituent fibres, while a similar stream directed against a neighbouring healthy portion produces little or no effect upon it. When examined by the microscope, its constituent fibres appear to have undergone no change but that of consistence; they exhibit varicosities, more numerous than usual, nor can any products of inflammation, or any other abnormal material, be detected among them. The bloodvessels are empty and pale. The colour is very commonly that of cream, sometimes a little more yellow.

This form of softening occurs chiefly in old persons, in whom the arteries of the brain have been more or less ossified, or in whom the vessels leading to the seat of softening have been so diseased as materially to interrupt or

diminish the quantity of blood flowing to the part. It has occurred after ligation of the common carotid artery, as must be inferred from the numerous cases of hemiplegic paralysis after this operation, on the side opposite to that of the tied artery; and I have myself recorded a remarkable example in which it was produced throughout nearly the whole hemisphere of the brain by the plugging of the common carotid artery by a dissecting aneurism.*

Any condition of the arteries of the brain, or of the general system, which may impair the nutrition of the brain, is favourable to the production of this form of softening. I have seen instances of it after inveterate contamination of the system by lead, in house-painters, who have had epileptic seizures before death, chemical examination shewing that the nervous matter of the brain contained lead in considerable quantity. It also occurs in persons dead with cerebral symptoms, epilepsy, coma, &c., in Bright's disease of the kidneys.

This softening frequently surrounds apoplectic clots, and in such cases is most probably the precursor of the apoplectic effusion. Frequently small apoplexies are found throughout a patch of softening of this kind, and sometimes the effused blood is infiltrated throughout the softened part to a great extent, and puts on an appearance which has been likened by Rostan and many others to one of the ecchymosed spots which are seen in scurvy.

A colourless softening is found in hydrocephaloid brains. This is probably due to an arrest in the nutrition of the organ, in consequence of which that condition of it which belongs to infancy (when a much larger quantity of water enters into its composition than in the later periods of life, and when the brain-substance is naturally very soft) becomes unduly developed, and water accumulates in the substance as well as in the cavities of the brain. The softening under these circumstances is generally seen most distinctly in the thin lamellar portions of the brain, such as the corpus callosum, the fornix, the Vieussenian valve, the anterior and middle commissures, the septum lucidum. These parts are so soft that unless the greatest care and gentleness are used in the removal of the brain they give way. The softening is not limited to these parts, although greatest in them; it is general throughout the brain. When, however, the hydrocephalic state has been very chronic, the substance of the hemispheres becomes condensed by the pressure from within the ventricles, and the water having thus been pressed out of it, it appears of a natural consistence, or even more dense than natural.

In all the cases of general paralysis of the insane which I have examined, the consistence of the brain generally has been considerably less than natural. There have also been marks of chronic disease of the arachnoid in various patches of opacity, which I am disposed to view rather as a deposit from an abnormal blood than as the result of what is called

* Med. Chir. Trans. vol. xxvii.

chronic inflammation. The softened condition of the brain is doubtless due to a similar cause, the blood yielding vitiated materials for the nutrition of the organ. In brains of this description the dilated and congested state of the veins, and the enlarged and lax condition of the arteries, abundantly demonstrate how sluggish had been the force by which the circulation is maintained in the capillaries, that force of attraction between the blood and the nervous matter, by which more than by any other means active nutrition is maintained.

The parts in which softening when partial is apt to occur in the brain may be thus enumerated according to the order of their frequency—the fornix and septum lucidum, the corpus striatum and optic thalamus, the mesocephale, the corpus callosum and other transverse commissures, the hemispheres of the brain, the cerebellum, the medulla oblongata.

Of the inflammatory or red softening.—Another form of softening of less frequent occurrence than that just described possesses very distinctive characters. It is generally pretty circumscribed in extent, of a diffused redness, most commonly of a bright hue; the consistence of the part is much diminished, and it readily breaks up under the stream of water. Nerve tubes are found in it, more or less varicose and friable, also red particles of the blood, and many of those large nucleated cells commonly known as exudation corpuscles, within which an active molecular motion may be often seen.

The red colour of this form of softening is due partly to the injection of the bloodvessels, and partly to the extravasation of the red particles of the blood throughout the softened part. Sometimes the red colour is absent, although the lesion is essentially the same. In such cases the colour may be yellowish and due to the presence of a less injection of the bloodvessels and a slighter extravasation of the colouring matter of the blood. Dr. Bennet states that he has found exudation corpuscles in a softening of a brilliant white colour, a fact which seems to indicate that the products of inflammation may be present without discoloration, and that all instances of white softening ought not to be considered non-inflammatory.

The researches of Dr. J. H. Bennett, of Edinburgh, are among the most important contributions to the morbid anatomy of the brain of late years. I think he has clearly established that the great characteristic of inflammatory softening is the presence of exudation corpuscles about the minute vessels, and among the elements of the softened cerebral tissue. This is in the vast majority of instances accompanied with discoloration, which sometimes is due solely to the dark colour of the exudation corpuscles themselves. When these corpuscles are not present, and especially when the softened portion of brain is free from colour, then we must regard the lesion as non-inflammatory, the result of imperfect nutrition, or as produced by physical causes coming into operation shortly before or after death. As the same process of softening which involves the cerebral structure often extends to the minute vessels, small extra-

vasations, constituting the capillary apoplexy of Cruveilhier, frequently occur where no indications of inflammation exist; in such instances the softening, although non-inflammatory, may be of a yellow colour from the effused colouring matter of the blood.

I cannot agree with Dr. Bennett in regarding white softenings as generally *post mortem*, and the result of maceration in serum. The softening of very thin parts, such as the fornix and septum lucidum, no doubt, is frequently of this character. But I have seen many instances of white softening of other parts of the brain which were not exposed to the physical conditions calculated to produce such a change of consistence.

Inflammatory softening occurs most frequently in parts which are near the great vascular surface of the pia mater; the convolutions and the white matter of the centrum ovale, the corpus striatum, and the optic thalamus are the most common situations of this lesion. In thirty-three cases collected by Durand-Fardel the softening was situated in the convolutions in thirty-one, and in nine of them the convolutions were the sole seat of softening. The following table will illustrate the statement above made; it represents the results of fifty-three cases collected from different sources.

Convulsions and white substance	22
Convulsions alone	6
White substance alone	5
Corpus striatum and optic thalamus	6
Corpus striatum alone	11
Optic thalamus alone	4
Pons Varolii	3
Crus cerebri	1
Corpus callosum	1
Walls of the ventricles, septum	1
Fornix	1
Cerebellum	1

Suppuration.—From what has been stated in the previous paragraphs it is plain that the most important sign of inflammation of the brain is red softening. Infiltration of pus is rare. Dr. Bennett states that in no single instance of numerous examinations made by him could softening be traced to the presence or infiltration of pus. This is a direct refutation of Lallemand's assertion that this form of softening owes its colour to the infiltration of pus. Pus, however, is sometimes collected into a cavity in the brain, forming an abscess. An excavation of greater or less size is formed in the substance of the brain, and this is lined by a yellowish membraniform layer, which resembles either lymph in an expanded form, or the purulent matter itself in a less liquid form, compressed into the form of a membrane by the accumulated liquid.

Pus in the brain is of slow formation, and has often become collected in considerable quantity before it betokens its presence by any symptoms. Sometimes we have the opportunity of examining it before it has acquired the yellow colour and oily consistence of laudable pus. In this stage it may be mistaken for some malignant formation; it is whitish, semi-solid, and sometimes mixed with streaks of blood. Its true nature may be recognized by micro-

scopical examination, which discloses the characteristic pus globules with little or no *liquor puris*, and by mixing some of it with liquor potassæ, when it becomes converted into a viscid material resembling white of egg.

Pus in the brain is frequently of a green colour, and very commonly exhales an extremely fetid odour.

The cerebral matter around the purulent collection is either somewhat indurated or it is in an œdematous state, or in one of inflammatory softening. When in this latter state the abscess is not so defined; the softened cerebral matter around it is broken up and mingled with pus; this, however, is rare.

An abscess of the brain may open upon the exterior and so evacuate its contents. This may occur either into the nose through the cribriform plate, or into the tympanic cavity or the external auditory meatus. It is sometimes difficult to determine whether inflammatory disease had arisen in the ear, extending to the brain and exciting the formation of abscess, or whether the abscess already formed in the brain had not burst into the ear. A cerebral abscess may empty itself into either of the ventricles.

Abscesses are most commonly found in one of the cerebral hemispheres, or in the cerebellum; they are very rarely met with in other parts of the brain. Sometimes collections of pus form upon the surface of the brain between the pia mater and the grey matter of the cerebral convolutions. And pus or puriform matter is frequently found between the arachnoid and pia mater, where there has been inflammation of either or of both those membranes. This is most common in children.

Hyperæmia and Anæmia.—An organ so largely supplied with blood as the brain, is liable to variations in the amount of that supply under various circumstances. It is unnecessary to recapitulate here the arguments already adduced to show that the opinions of those who maintain that the quantity of blood in the brain cannot vary, is erroneous. Indeed it is much to be wondered at how persons accustomed to inspect the brain post mortem could have adopted such a doctrine.

In the greatest degree of hyperæmia of the brain, all the vessels of the organ are full; the veins which lie between the convolutions are full; the vessels of the pia mater are fully injected. Often there are diffused extravasations through the areolæ of this membrane, causing a red blotch over more or less of the surface of the brain. The grey matter of the convolutions is extremely dark in colour, and if a small portion of it be examined under the microscope the minute vessels which abound in it are found distended with blood. On the surface of a section of the white matter numerous bloody points are found, being the orifices of vessels cut across. These points are sometimes very large; sometimes they are surrounded by small extravasations of blood, proceeding from the rupture of some small vessel. In this state of the brain the vessels of the choroid plexus and of the velum interpositum are very full, and also those of the dura mater.

Cerebral hyperæmia is generally caused by some obstruction to the free return of the blood to the right side of the heart. Hence we see it always after death by asphyxia, and very commonly in cases of disease of the heart. When the breathing has been seriously impeded just before death, there will always be considerable hyperæmia of the brain. Hence in judging of the nature of a cerebral hyperæmia, the anatomist may be materially assisted in coming to a correct conclusion if he can ascertain the cause of death and the symptoms immediately preceding it; a fact which clearly denotes how little is the value of mere dissection of morbid parts, unassociated with some knowledge of the symptoms manifested during life.

In the bodies of persons dead of epilepsy, during or immediately after the epileptic fit, there is always cerebral hyperæmia. In these cases the hyperæmia is due to the retardation and obstruction of the venous circulation, occasioned by the convulsive struggles of the patient and the resulting impediment to respiration. It may be caused, likewise, by an increased attraction of blood to the organ taking place at the moment of the occurrence of the fit. For the same reason, whenever death is ushered in by convulsions, the brain will be found in a state of congestion, the amount of which will vary with the quantity of blood in the body. Whatever may be the condition of the brain prior to the epileptic paroxysm, it is always in a more or less congested state during and immediately after it. The too prevalent notion that cerebral congestion is the cause of the epileptic paroxysm has but little foundation, while there is abundant evidence to prove that the epileptic paroxysm may give rise to cerebral congestion. It is well known that animals bled to death die in convulsions; and many cases of puerperal convulsions are clearly caused by excessive loss of blood resulting from parturition.

Hyperæmia of the brain is frequently found after death from depressing and exhausting maladies, typhus fever, &c., all diseases of the low typhoid type, and in cases of general paralysis. The powers by which the circulation is carried on in the vessels are greatly depressed, and the blood accumulates in them, especially in the veins.

I know of no means of distinguishing active from passive hyperæmia, excepting probably that the capillaries may be more injected in the former, and the veins more filled in the latter. To enable the anatomist to make a correct distinction, the detail of symptoms during life must be called to his assistance.

Anæmia.—This condition, the opposite to that last considered, is very common. It is frequently met with in children, and in such cases is accompanied with more or less of serous fluid, either in the subarachnoid space or within the ventricles. The brain of the ill-nourished strumous child is generally an anæmic brain.

Anæmia of the brain occurs when death has been caused, whether quickly or gradually, by the loss of blood. It is also present when the

heart, oppressed by some disease affecting its own structure, fails to propel the blood with its proper force to the brain. The delirium which comes on in rheumatic fever, when pericarditis or endocarditis commences, is indicative of an anæmic state of the brain; and in some instances in which I have had the opportunity of examining the brain, when the patient died in this delirium, I have found marked and obvious anæmia of this organ.

Anæmia of the brain, according to my observation, is of two kinds, general and partial. In the former, pallor prevails throughout the brain. This is met with, as before mentioned, in ill-nourished children; and it is also present to a remarkable degree in persons, house-painters and others, who have largely imbibed the poison of lead, as if the presence of that poison interfered greatly with the process of hæmatisis. Partial anæmia is where the deficiency of blood is observed chiefly in the grey matter. I have frequently seen the grey matter of the convolutions perfectly bloodless, and the white matter of the hemisphere covered with bloody points of congested veins. This is the condition generally met with after death from rheumatic or gouty delirium.

When the brain is very anæmic a considerable quantity of fluid is generally found beneath the arachnoid membrane, with or without a small quantity in the ventricles; or more rarely, a good deal of fluid in the ventricles, with little or no subarachnoid fluid.

Of cerebral hemorrhage.—Effused blood from one or more ruptured bloodvessels is found upon the surface, in the substance, or in the ventricles of the brain. Effusion of blood in any or all of these situations constitutes the most common form of cerebral apoplexy.

The blood is sometimes effused simply upon the surface of the brain; it is diffused beneath the arachnoid membrane, and even under the pia mater, raising up that membrane and separating it from its connection with the cerebral substance. Not unfrequently such a diffusion of blood beneath the pia mater is connected with an internal extravasation which has made its way to the surface either through broken down cerebral substance or from the ventricles.

A recent apoplexy in the substance of the brain is no more than a dark clot of blood, like a mass of black currant jelly, filling a cavity which it has formed for itself in the cerebral substance. Such is the appearance when the examination has been made a few hours or even a few days after the apoplectic fit. If the patient survive this period, we find evidence of changes in the clot and in the surrounding cerebral substance. These changes vary according to the condition of the brain prior to the apoplectic effusion.

If the brain has been quite healthy up to the occurrence of the rupture, a condition which is extremely rare, then the changes towards cicatrization take place quickly; the serum of the clot becomes absorbed; the torn brain-substance around the clot contracts; the solid matter of the clot assumes a reddish instead of a black hue; it gradually diminishes in quantity, and

the brain-substance, not contracting to the same extent as the clot has done, a cavity remains, which contains serum, and more or less of the remnant of the clot. The cerebral substance forming the wall of this cavity has a yellowish colour, somewhat of the same hue as that which is seen after extravasated blood in the subcutaneous tissue, and it is denser than is natural. After the lapse of more time the cavity contracts, and nothing remains but a spot of discoloured and somewhat indurated cerebral substance. When the apoplectic clot has been of large size, and has occasioned an extensive solution of continuity, the contraction of the surrounding substance is not sufficient to obliterate the cavity, which in such instances is occupied by a soft, loose, areolar tissue, infiltrated with fluid. In other cases the cavity is lined by a distinct membrane and is filled with fluid, forming a true cyst. Cruveilhier affirms that the most frequent sequel to the apoplectic clot is the indurated and discoloured spot of cerebral substance; next in frequency is the cavity with the loose areolar tissue; and last, the cavity lined by a membrane or the serous cyst.

The morbid condition which surrounds the apoplectic effusion is generally that of colourless softening. This state doubtless precedes the rupture which gave rise to the hemorrhage. Sometimes, however, red softening extends around it more or less; this generally follows the effusion. The existence of either of these morbid states is very unfavourable to the contraction and cicatrization of the apoplectic cyst.

It frequently happens that in the cerebral substance around an apoplectic clot we find very numerous small points of effused blood, sometimes accompanied by minute streaks following the direction of the cerebral fibres. This constitutes what is called *capillary apoplexy*. Sometimes this is the only marked appearance present, and no large clot has been formed. This occurs not uncommonly in apoplexy affecting the medulla oblongata and the mesocephale. When many such minute effusions take place very near to each other, it is easy to understand how by their coalition they may form a large apoplectic clot; and it is most probable that large effusions generally arise in this way, not from the rupture of one or even of a few vessels, but from that of numerous minute ones.

The size of the apoplectic clot varies considerably (excluding the cases of capillary apoplexy in which no coalition has taken place) from the size of a millet seed to that of a man's fist, the clot sometimes breaking up the fibrous nervous matter of the hemisphere with its surrounding grey layer, and completely occupying its interior. There is no part of the brain so favourable for the occurrence of a large apoplectic clot as the hemisphere, because its softness and magnitude afford the least resistance to the flux of blood.

Apoplectic effusions occur most frequently in the hemispheres of the brain, affecting first the corpora striata or optic thalami, and spreading from them into the white substance of the hemisphere, or sometimes breaking up their

substance and passing into the lateral ventricle of one side, and thence through the foramen of Monro into the lateral ventricle of the other side. The convolutions are the next most frequent seat of apoplexy, and after them either hemisphere of the cerebellum, and either crus cerebri. The pons, crus cerebri, crus cerebelli, are much less frequently affected by hemorrhage. These parts are denser in structure and less freely supplied with blood, and, therefore, less prone to apoplectic effusion than those before mentioned.

Cancer of the brain.—Cancer is occasionally, although very rarely, found affecting some part of the encephalon; most frequently it extends into some portion of it from the meninges.

Andral has given a good history of this diseased condition, founded upon the analysis of forty-three cases.* Of these, the hemispheres were the seat of the cancer in thirty-one, in five the cerebellum was affected, once the mesocephale, three times the pituitary body, and three times the spinal cord.

The number and size of the cancerous tumors are very various. The cancer may begin in the meninges, and attack the bone on the one hand and the brain on the other; or it may be first developed in the substance of the hemisphere. When the disease is superficial the cranial walls may become extensively implicated. I have seen the greater part of the parietal bone implicated in a cancerous tumor. Andral mentions a case in which the frontal and temporal bones were completely destroyed, and another in which the cancer, developed at the inferior surface of the brain, passed out through the foramina of the base of the cranium.

Cerebral cancer is most frequently of the soft or fungoid kind, but sometimes it occurs in the form of small hard tumours, deposited in various parts of the brain, and separated from the surrounding cerebral substance by a distinct membrane or capsule. Frequently it appears to be primary, or at least there seems no evident connection between it and any other cancerous deposit situate elsewhere. Of Andral's forty cases only ten were associated with cancer in other situations.

Tubercle of the brain.—The anatomical characters of tubercle of the brain are very definite. The colour is yellow, the more conspicuous by reason of the white or grey of the surrounding cerebral texture; the consistence cheesy. Its section affords a smooth and clean surface, but if broken up by the point of the knife, its texture appears to be minutely granular. Sometimes this tubercular matter may be picked out of a very distinct capsule. The tubercles vary very much in size, sometimes as small as a millet seed, frequently the size of a split pea, or even as large as a filbert or a walnut, rarely much larger.

The parts of the brain most frequently affected by tubercle are the cerebral hemispheres and those of the cerebellum. The mesocephale and the medulla oblongata are rarely the seat of it. It is generally situated near the surface

or near some process of pia mater; consequently it is most commonly met with in the grey matter of the brain.

Cerebral tubercle excites inflammation in the surrounding brain substance, which is then found in the state of red softening; and sometimes suppuration may be established, the tubercular matter being more or less broken down and diffused in the pus. It is thus that tubercles of the brain prove so destructive to life. They may remain quiescent and undetected and even unsuspected until some irritation, often propagated from the periphery, excites surrounding inflammation, which by reason of the presence of the foreign matter of the tubercle, is kept up, and refuses to yield to any measure of treatment. Cerebral tubercle exhibits no spontaneous tendency to soften, nor does it frequently degenerate into earthy concretions.

Entozoa.—The entozoa found in the brain are the *cysticercus cellulose*, and the *acephalocyst*, with its denizen the *echinococcus*. Like tubercles, these are always placed near the vascular surface, and they may be said more properly to infest the pia mater than the substance of the brain; by their growth, however, they encroach more or less upon it. The animals sometimes die, and their containing cysts shrink up and become converted into earthy matter, forming calcareous tumors of variable size in the substance or on the surface of the brain.

Morbid states of the ventricles of the brain.—The diseased conditions of the ventricles of the brain are referable, first, to the cavities themselves; secondly, to their contents; thirdly, to their lining membrane and to the choroid plexus.

The most frequent morbid condition of the ventricles is a state of dilatation, which is always passive, being produced by the accumulation of water in it. This retention of fluid within these cavities appears to be a true dropsy, and is in most cases connected with an external meningeal inflammation in a strumous constitution. It is in children that we most frequently meet with this dilatation of the ventricles, and in them it constitutes the disease called *hydrocephalus internus*. In adults it occurs sometimes, but extremely rarely. In the former, when the disease is of a very chronic nature, the fluid will accumulate to a very great extent, and enlarge not only the ventricles but the cranium itself to an enormous size.

In persons in advanced age, in lunatics of long standing, and in old epileptics, we frequently see a dilated state of the ventricles from distension by water. This is always associated with a wasted state of the brain; this fluid, as well as the external fluid, serving to fill up the space from which the cerebral matter had receded.

In all these cases the ventricles which experience dilatation are the lateral ventricles, the third and the fourth. In a very few instances the fifth ventricle has been found similarly dilated.

The fluid contained in the ventricles is generally a clear straw-coloured serum, varying in

* Clin. Med., t. v., p. 633.

quantity from half an ounce to several ounces. Sometimes it is milky, and has shreds of lymph floating in it; at other times it may be seropurulent, but this is extremely rare, and only occurs when the lining membrane has been the seat of acute inflammation and of inflammatory deposit.

The lining membrane of the ventricles, which in health is of extreme tenuity, becomes frequently thickened and partially opaque in chronic disease of the brain, where the ventricles are more or less dilated. In acute disease lymph is sometimes deposited upon it in large and loose flakes, easily removeable from it. And sometimes there is a deposit all over its surface of a fine granular semitransparent lymph, which gives to the internal surface of the membrane the appearance of an extremely fine and delicate reticulation.

As the choroid plexus are covered by a prolongation of the membrane of the ventricles, their investment is apt to participate in any morbid process which may take place in the former. In acute affections it will be covered with lymph, as the membrane lining the ventricles is elsewhere. When much water has been accumulated in the ventricles, the choroid plexus are pushed against their floor, flattened, and rendered pale by maceration. On the other hand, whatever causes much vascular congestion in the vessels of the brain will produce the same effect in a marked manner upon those of the choroid plexus.

Earthy concretions are sometimes found in the choroid plexus, which may probably be an augmentation of the crystalline matter found in them in their healthy state. These appear to consist chiefly of phosphate and carbonate of lime.

A very common appearance found in the choroid plexus consists in certain vesicles, very variable both in size and number. These are simple cysts, containing a straw-coloured fluid. Formerly they used to be regarded as hydatids, but they are now known to be essentially distinct from them. They occur frequently in brains which exhibit no other departure from the normal condition. Of their precise nature, and of their cause and mode of formation, nothing is known; and as they are seldom of a large size they are not likely so to disturb the functions of the brain as to give rise to symptoms by which their presence could be detected.

On the pseudo-morbid appearances of the nervous centres and their coverings.—The actual indications afforded by any departure from the normal physical condition of the nervous centres after death are so important to the attainment of right conclusions respecting the pathology of the nervous system, that it behoves the anatomist to take fully into account all those circumstances which may give rise to appearances in the cerebro-spinal centres or their membranes simulating disease. Such appearances, not inappropriately termed *pseudo-morbid*, occur in the greater or less vascular fulness of the membranes and of the centres themselves, in the variations in the quantity of fluid around

or within the brain, or around the spinal cord, and in the consistence of the nervous matter.

The circumstances which affect the amount of blood in the vessels are the mode of death and the position in which the head has been laid after death. Death by asphyxia, whether rapid or gradual, favours the accumulation of blood in the vessels of the brain. Convulsions preceding death likewise cause turgescence of these vessels. Any impediment to the circulation through the heart has the same effect, but to the greatest degree when the impediment is much felt on the right side of the heart.

The position of the head after death affects the vascular fulness by favouring the accumulation of blood in the most dependent parts. From this circumstance and from the custom of placing bodies on the back, we always find the posterior lobes of the cerebral hemispheres and the cerebellum most filled with blood, and it is on this account that the straight and other posterior sinuses of the dura mater are always filled with blood.

The quantity of fluid around the brain and spinal cord is least in the young and greatest in the old: it is influenced by the bulk of the brain or spinal cord, sometimes disappearing entirely when the brain is so large as to fill the cranial cavity; it is inversely as the quantity of blood, and therefore is considerable in cases of anæmic brain, unless the bulk of the organ have increased from some other cause. Slow deaths from chronic disease favour the accumulation of this fluid by diminishing the supply of blood to the brain. In phthisis and other lingering maladies there is almost always a considerable amount of subarachnoid fluid. The practitioner should bear in mind that the absence of subarachnoid fluid is always abnormal, and is in general due to an enlargement of the brain from hyperæmia or from some other cause.

Softening of the nervous matter may be pseudo-morbid. The spinal cord softens very soon after death; but if examined within twenty-four hours it exhibits more density than the brain. With the advance of decomposition the cord becomes extremely soft and almost diffuent. In the brain the pseudo-morbid softening is colourless, and may be readily mistaken for disease. That the brain is very prone to imbibe fluids is shown by Dr. Patterson's experiments. The brains of sheep were allowed to remain for a certain number of hours in a given quantity of water, which was rapidly absorbed. The weight of the brains was increased proportionally to the quantity of water which had been imbibed, and the parts most exposed to the fluid were found in a softened state. In one instance the brain was deprived of its membranes on one side, and six hours after death it was immersed in a mixture composed of equal parts of ox-bile and water. It weighed three ounces, seven drams, and four grains when prepared for experiment. After remaining in the mixture thirty-six hours it weighed eight ounces and one dram.* These

* On the pseudo-morbid appearances of the brain, Ed. Med. and Surg. Journ. for 1842, vol. 57.

experiments show that the brain readily imbibes fluid, and that parts in the vicinity of and bathed in fluid may present a pseudo-morbid softening from such imbibition. The fact, thus ascertained, serves to account for the more frequent occurrence of softening in the fornix and septum lucidum than in other parts of the brain. It is obvious that pseudo-morbid softening of this kind would occur only in parts within the ventricle or in the cerebral substance forming their walls, or on the surface of the brain itself, and that it is less likely to be limited to one side than the morbid softening. Now and then, however, in cases of general anasarca, where the blood is in a very watery condition and much fluid is effused, the brain exhibits a softened state from the imbibition of this fluid.

ABNORMAL ANATOMY OF NERVES.—Certain nerves are sometimes absent, from a defect in the development of the organ to which they are devoted; as the optic nerve, or the olfactory, when their respective organs are wanting. The non-development of the eye will also cause a non-development of the fourth pair and the other orbital nerves which influence the movements of the eyeball.

The morbid states of nerves are few and rare. Inflammation of a nerve rarely occurs idiopathically or primarily. Occurring from whatever cause, it would be distinguished by hyperæmia, enlargement, and by deposit of more or less of lymph or pus. In the acute inflammation the nerve would be softened; but in the chronic it would become indurated. Abscess of a nerve is of very rare occurrence.

Inflammatory affections of nerves occur chiefly in connexion with rheumatic or gouty states of the system. Sciatica is, no doubt, an inflammatory affection of the sciatic nerve of the gouty kind. In lumbago probably the muscular nerves of the lumbar muscles are similarly affected.

Atrophy is a condition into which nerves may fall from disuse or from pressure. In it the nerve-fibres shrink, their central axis wastes, and in extreme cases disappears entirely, the tubular membrane becoming plicated and assuming the characters of fibrous tissue. The nerve experiences a great diminution in size, and the wasting is obvious to the naked eye.

Hypertrophy.—Whether a nerve becomes enlarged when more work is thrown upon it, as a muscle does, is as yet quite uncertain. I am disposed to think that the nerve-fibres may acquire some increase of size; but it seems to me impossible that they should become more numerous. The number of nerve-fibres in individual nerves, as that of muscular fibres in muscles, is probably determined at their primary development,* and they undergo no change but that of length and thickness subsequently. It would not be difficult, by destroying the office of the vagus nerve on one side, to ascertain whether, after the lapse of some

time, the other, upon which its function would devolve, acquired any increase in the size of its nerve-fibres.

Certain gangliiform tumours are formed upon nerves, to which the term *neuroma* has been applied. They consist of areolar tissue and of nerve-fibres, and seem to be formed by an increased development of the areolar tissue between the nerve-fibres. These tumours vary considerably in size and number; sometimes they are not larger than a filbert or a gooseberry sometimes as large as a walnut. In genera they are few and limited to one nerve, and their size is proportionate to that of the nerve with which they are connected. In a few rare cases tumours of this kind have been found in immense numbers scattered over the whole cerebro-spinal system.

(R. B. Todd.)

NERVOUS SYSTEM, PHYSIOLOGY OF THE.—In inquiring into the physiology of the nervous system, the first step is to determine the vital endowments of nerves and of nervous centres.

When a nerve is laid bare in a living animal, and a mechanical or electrical stimulus is applied to it, we do not find as in muscle that a *visible* change in the nerve takes place; on the contrary, the nerve seems to be uninfluenced by the applied stimulus, and the evidence we have to the contrary is derived from the contraction of certain muscles, if the nerve be muscular, or from indications of pain, if it be a nerve of common sensation.

We infer, then, from the contraction of the muscle in the one case, or from the affection of the mind in the other, that the application of the stimulus has wrought a change in the nerve, which, however, is of such a nature as not to be discerned by any means of observation within our reach. We get, however, excellent proof of the excitation of the change in the nerve, from the fact that when a ligature is applied to a nerve sufficiently tight to produce a solution of continuity in the nerve fibres, the propagation of the influence of the stimulus beyond the ligature is checked. No kind nor degree of stimulation of a muscular nerve above a ligature so applied is capable of exciting muscular contraction.

The most remarkable feature which we notice in the experiment of stimulating a muscular nerve, is the *instantaneousness* with which the muscular contraction takes place. Although the muscles may be at a considerable distance from the point of the nerve to which the stimulus is applied, there seems no appreciable interval of time between the application of the stimulus and the contraction of the muscle. And the cessation of the muscular contraction, instantly upon the removal of the stimulus, is equally conspicuous.

It would appear, then, that the change in the nerve is produced and is propagated along the nerve to distant parts, as it were at one and the same moment. This rapidity of the production, and the instantaneousness of propagation of the change in the nerve, denote that the nerve fibres must be the seat of a molecular

* A similar law probably prevails with other tissues, namely, that the number of their proximate elements is determined at primary development, and that in subsequent growth these elements may increase in bulk but not in number.

change rapidly propagated along the nerve, from molecule to molecule, from the point of application of the stimulus. The change is obviously analogous to that which takes place in the particles of a piece of soft iron, in virtue of which the iron acquires the properties of a magnet, so long as it is maintained in a certain relation to a galvanic current; the magnetic power being instantly communicated when the circuit is completed, and as rapidly removed when it is interrupted.

The action of the stimulus, then, excites a *state of polarity* of the particles of the nerve stimulated; and this polar state may be induced in other particles, whether muscular or nervous, with which the nerve stimulated may be in organic connexion. Just as the polar state of the electrical apparatus is capable of being communicated to the piece of soft iron, which thereby acquires the well-known magnetic properties during the continuance of the excited polarity.

Thus, then, we learn that such is the nature of the nerve fibre, that under the application of a stimulus, mechanical, chemical, or galvanic, it is capable of generating a polar force analogous in many particulars to that of muscle; this force we call the nervous force, *vis nervosa*, or *nervous polarity*.*

And if we examine the ordinary mode of the development of the nervous force, in the usual actions of the frame, we find that under the influence of a mental stimulus, the will, it is propagated from the nervous centre along the nerves to muscles, or under the influence of a physical stimulus it is propagated along the nerves to the centres, where it is capable of exciting either a sensation or muscular motion in a secondary manner, or both.

But the application of a physical stimulus to a nervous centre may cause the development of nervous force, which may be conducted away from it by nerves which are implanted in it. And thus we learn that the same polar condition which may be produced in nerves is equally capable of being excited in nervous centres. The polar condition of the nerve fibre may be propagated to the nervous centre, or that of the nervous centre to the nerve fibre.

In some of the nervous centres, however, no *visible* change of any kind takes place upon the irritation of the nervous matter, nor does the animal seem to suffer pain. Such is the case when the hemispheres of the brain are the subject of experiment. We are not to infer from this that the nervous force is not developed in these centres, but that they have no direct connexion with the muscular system, nor have they that peculiar organization which would enable them when irritated to excite painful sensations.

There are certain nerves which when stimulated excite neither muscular motion nor com-

mon sensation or pain, but a sensation peculiar to themselves. Thus if the optic nerve be stimulated by a mechanical or galvanic stimulus, a sensation of light is produced; if the auditory nerve be stimulated in like manner, a sensation of sound is produced.

These facts prove not only that a peculiar force is generated by the nervous matter, but they also show that the nerve fibres in the centres, as well as in the nerves, possess special endowments depending, in all probability, upon their central as well as upon their peripheral connexions. Thus nerve-fibres connected with muscles are capable of exciting muscular contraction, and are therefore called *motor* or *muscular* nerves. Nerve-fibres, which are distributed to a sentient surface, as the skin or mucous membrane, and have a certain relation with that part of the nervous centre which constitutes the centre of sensation, (vide p. 711,) are when stimulated capable of exciting a feeling which may be agreeable or painful, according to the degree of stimulation. These are called *sensitive nerves*, or *nerves of common sensation*. To the class of sensitive nerves belong those which, owing no doubt to a peculiarity in their connexion with the centre, as well as to their relation to a special apparatus at their periphery, develop peculiar sensations, as the nerves of sight, hearing, taste, &c., and they have been distinguished as *nerves of special sensation*.

Very many sentient nerves are implanted in the nervous centre near to certain motor nerves, so that a stimulus applied to the former is capable of reacting upon the latter, and of exciting motion through their connexion with the muscles. Dr. M. Hall, however, ingeniously supposes that this power resides only in a particular class of nerve-fibres (and not in the ordinary sentient nerves through their closeness of relation with the ordinary motor nerves). A nerve of this kind would constitute an arc, consisting of an *incident* and a *reflex* portion, which are united at the nervous centre. The stimulus is conveyed to the centre by the incident portion, and is then reflected into the reflex or motor portion. Such nerves, Dr. Hall designates *excito-motor*. We shall examine further on the grounds of this hypothesis.

It is an important fact, which Sir C. Bell was the first clearly to prove, that nerve-fibres of different endowments may be bound together in one sheath, forming, in anatomical language, one nerve. Thus a nerve may contain sentient and motor fibres, as the median nerve in the arm, or if we admitted Dr. Hall's hypothesis, it might contain sentient, motor, and excito-motor fibres. And most nerves in the different regions of the body are of this description, i. e. *compound* nerves, made up of sentient and motor fibres bound together in the same sheath, in very different proportions. In many of these nerves, as in the spinal nerves, and the fifth pair, the separation of the fibres of motion from those of sensation exists at the implantation in the centre, and there the fibres of each endowment are collected into a separate bundle, which possesses the endowment proper to its constituent fibres. These are the roots of these

* I have been in the habit of taking this view of the nervous force in my lectures for the last four or five years, and of using the term, *nervous polarity*, as expressive of the nature of the nervous force. This term has likewise been adopted by Mr. Bowman and myself in our work on the *Physiological Anatomy and Physiology of Man*, vol. i. p. 56, and in the chapters on the Nervous System, *passim*.

nerves, of which one has been satisfactorily proved to be sentient, the other motor, the former being generally the larger, and having the peculiar feature of a ganglion being formed upon it.

There is scarcely a nerve in the body, which, in strictness, ought not to be regarded as a compound one; the physiological character of each nerve must depend on the endowment of the majority of its fibres, and the nerve will be called *sensitive* or *motor*, according to the predominance of motor or sensitive fibres in it. For example, the facial nerve, or *portio dura* of the seventh pair, is called *motor*, because it is almost wholly composed of motor fibres; but it contains, besides, in very much smaller number, some sensitive filaments which it derives from anastomoses with neighbouring nerves. The third, fourth, and sixth nerves are of similar constitution to the facial. In the ramifications of the fifth nerve, on the other hand, the filaments of sensation are predominant; those of motion being much fewer, and confined to the ramifications of its inferior maxillary division.

There is no difference between a motor, and a sensitive nerve as regards structure. Ehrenberg, indeed, endeavoured to establish that the varicose character of the fibre belonged to nerves of special sense; but subsequent observation showed this to be incorrect. We can attribute the difference of endowment of the fibres to no other cause, but to the nature of their peripheral and central connections. The same nervous force is propagated by the fibres of each kind, but whether that force is to excite motion or sensation must depend on the connection of the fibres with muscles in the one case, and with the centre of sensation in the other.

The terms *afferent* and *efferent* have been used in expressing the function of different fibres, and they are convenient terms to a certain extent. But the use of them tends to convey erroneous ideas respecting the change which takes place in a nerve when stimulated, as if that change took place only in one direction. It is true that, in a motor nerve, the stimulus ordinarily acts from the centre, and the nervous force is propagated peripherad; and on the other hand, in the sentient nerve, the stimulus is usually applied at the periphery, and the nervous force proceeds centrad. It is the place at which the stimulus is applied which usually determines the *direction* in which the nervous force travels. But there are no good grounds for supposing that the molecular change consequent upon the stimulation of a nerve is limited to that part of the nerve-fibre which is included between the point stimulated, and the centre or the muscles, where the effect of the stimulation appears; on the contrary, it is not improbable that, at whatever point the stimulus be applied, the whole length of the nerve-fibre participates in the change. This is not unlikely in the case of *motor* nerves. For a continued or violent irritation of a motor nerve, in some part of its course, causing spasm or convulsive movement of the muscles it supplies, may be propagated along

its whole length to the centre, and may there give rise to irritation of neighbouring fibres, whether motor or sensitive, exciting more convulsion and pain. The phenomena of many cases of epilepsy, in which the fit begins with irritation of a few muscles, may be referred to in illustration of this position.* And it is also very probable as regards *sensitive* nerves. If the ulnar nerve be irritated when it passes behind the internal condyle, a sensation of tingling is excited, which is referred to the sentient surface of the ring and little fingers; and if the irritation is kept up, the skin of those fingers becomes tender to the touch, its sensibility being very much exalted. This fact cannot be explained unless upon the supposition that the molecular change in the nerve-fibres, produced by the irritation, extended to the periphery as well as to the centre, exalting the excitability of their distal extremities.

It is a highly interesting physiological fact, which has an important practical bearing, that at whatever part of their course sentient nerve-fibres be irritated, the same sensation will be produced, whether the seat of the irritation be the centre, the periphery, or the middle of their course, provided only the same fibres are irritated in the same degree. Thus it frequently happens that sensations are referred to the extremities of a nerve when the existing irritation is situated at its point of implantation in the centre. The sensation of tingling or formication, in the hand or foot, arm or leg, is frequently an indication of cerebral or spinal disease; but the practitioner should not forget that precisely the same sensation may be caused by an irritation taking place in the course of the nerve. I have frequent occasion to estimate the importance of this fact in the treatment of cases of Sciatica. This disease generally consists in an irritated state of the nerve in some part of its course by a gouty matter, and it may be treated with the best effects by blisters applied over the nerve. As, however, the morbid impregnation may have taken place at any part of the course of the nerve, it is a very useful practice, when a single application fails, to apply the blisters over different parts in succession, instead of confining the vesication to one region.

This law of action of sensitive nerves gives the clue to the explanation of the extraordinary but well-attested fact, that persons who have suffered amputation will continue to feel a consciousness of the presence of the amputated limb, immediately after, and often for a long time, or even always, after its removal. I have met with two cases, in one of which the arm, in the other the leg, was amputated so long before as forty years; yet each person declared that he had the sensation of his fingers or toes as distinctly as before the operation. And not only does the consciousness above referred to exist, but likewise, when the principal nerve of the limb is irritated, the patient complains of pains or tingling, which he refers to the fingers

* I am aware that these phenomena admit of another explanation, but there is no reason why they might not likewise originate, in many cases, in irritation of a few motor fibres.

or toes.* In such cases the central segments of the amputated nerve-fibres remain; if they retain their healthy condition, they continue to represent in the sensorium the various points on the surface of the amputated limb, and likewise the muscles which they were destined to supply. If, however, the integrity of the nerve-fibres has been impaired in consequence of any morbid action which may have followed the operation, then the sensation exists imperfectly or not at all.

It may be stated in connection with this subject, and in confirmation of the view above taken, that in many cases of complete paralysis of a limb from cerebral disease, the patient, although perfectly clear in his general mental perceptions, is not conscious of the presence of the paralysed member, and really feels as if it did not exist. I have known instances in which this unconsciousness has been so great that the patient has actually mistaken the paralysed part for the limb of some other person coming in contact with him, or for some entirely foreign substance. One man fancied that his paralysed arm was his wife's, and called to her to take it away. In such cases the morbid state of the brain prohibits the development of that affection of the centre of sensation upon which the feeling of the connection of the limbs depends.†

The same law of action applies to nerves of special, as to those of common sensation. Thus, whilst ordinarily they propagate to the centre impressions made at the periphery, we find nevertheless that irritation of the nervous trunk at any part of its course may give rise to its peculiar sensation; and if the brain be stimulated at the part in which the nerve is implanted, similar sensations may be produced. The phenomena of vision and hearing which are excited in these ways are called "*subjective*;" they are familiarly known to medical men as not unfrequent precursors of more serious symptoms of cerebral disease. *Musæ volitantes*, ocular spectra, and tinnitus aurium, are the most common instances of these phenomena. Pressure on the eyeball, a galvanic current passed through it or very near it, rotation of the body, are capable of giving rise to similar phenomena, by exciting the retina or the central connections of the optic nerve, or by disturbing the circulation of the blood in them. A sense of giddiness, similar to that produced

* Müller records several instances in his *Physiology*, vol. i. p. 746. (*Eng. edition.*)

† There is a man now in King's College Hospital who suffered amputation at the upper third of the arm, and whose entire scapula, with the shoulder joint and great part of the clavicle, was removed by Mr. Ferguson within the last two months. This man still feels his fingers.

† Valentin states that persons who are the subjects of congenital imperfections, or absence of the extremities, have nevertheless the internal sensations of such limbs in their perfect state. According to the view above taken this could not be, unless the primitive nervous fibres are present in their full number in the trunks of the nerves destined for the limb. *Repertorium für Anat. und Phys.* 1836, p. 330, and note to Baly's translation of Müller's *Physiol.* vol. i. p. 747.

by the means last-named, is also a very common symptom of cerebral affection arising from a disturbed circulation, or from the blood being deficient in one or more of its staminal principles, or vitiated by some morbid element.

The stimuli of nerves.—Nervous action is ordinarily provoked by stimuli of two kinds, *mental* and *physical*. Mental stimuli are those resulting from the exercise of the will, or from thought. Physical are due to some external excitant; light, heat, sound, mechanical stimulation, chemical substances, as acids or alkalis, or electricity.

In all voluntary movements an act of the mind is the excitant of the nerve. Sensations are caused generally by the influence of physical agents upon the peripheral extremities of nerves, which communicate with the *sensorium commune*. The change thus produced in the nerve gives rise, through the medium of this communication, to a corresponding affection of the mind. A mental stimulus, however, may affect a nerve of sensation. Such stimulus would originate in that part of the brain which is the seat of the changes connected with the intellectual actions, and affecting the centre of sensation, would excite in certain sentient nerves a change similar to that which a physical stimulus applied to their peripheral extremities is capable of producing. In this way the mind is capable of exciting pain in any part. When the attention has been long directed to any particular situation, whether it has been previously the seat of pain or not, painful sensations may be excited there. Of this we have many instances in practice. In the treatment of cases of hysteria it is of great importance, on this account, to direct the attention of the patient as much as possible away from any local affection.

Motor nerves are never *immediately* excited by a physical stimulus in the ordinary actions of the body. A physical stimulus acts upon a motor nerve always through a sensitive nerve; the actions thus produced are, commonly, called *reflex actions* from the apparent reflexion of the change excited by the afferent or sensitive nerve in the nervous centre into the motor or efferent nerve. This class of actions was first pointed out and described by Prochaska, who viewed them as consisting "in reflexione impressionum sensoriarum in motorias." The contact of a foreign substance, pressure, titillation, are the ordinary physical means by which such actions may be excited. As a good example of this may be quoted the act of deglutition at the isthmus faucium.

Physical stimuli of other kinds, however, may excite motor nerves. The pressure of a morbid growth of any kind may irritate such nerves and create spasm of the muscles they supply. Any virulent fluid applied to a motor nerve will irritate in a similar way—hot water—liquor potassæ—a mineral acid—a solution of strychnine, &c. And for the same reason certain morbid matters in the blood may irritate nerves whether sensitive or motor, causing the so-called neuralgic pain in the one case, and cramp or spasm in the other.

Effects of the galvanic stimulus.—The most perfect and powerful physical stimulus of motor nerves, and that which most nearly imitates the natural mental stimulus, is the galvanic current. That the nerve should be duly excited by the galvanic current it is necessary that the current should pass *along* its fibres for however short a distance. If it pass *across* the fibre, and at *right angles* to it, it will produce no effect upon the muscles; but if it travel *along* it, even for the twentieth or a smaller portion of an inch, it will effectually excite the nerve and its muscles, just as when the will stimulates it to action.

The influence of the galvanic current upon nerves is so remarkable that it deserves the careful study of physiologists and of practitioners in medicine who often have recourse to the galvanic stimulus with the hope of rousing the dormant energies of nerves. It is to the Italian school of *Physiciens* that we owe the highly interesting series of facts which have been collected upon the influence of the galvanic current upon nerves, to Galvani, Valli, Volta, Marianini, Nobili, and, although last not least, to my distinguished friend, Professor Matteucci, of Pisa, by whose well-devised experiments and researches a flood of light has been thrown upon this hitherto obscure and difficult subject.

I shall content myself here with briefly noticing the points most deserving of attention as bearing upon the laws of action of the nerves.

1. When a galvanic current is passed for however short a distance along a nerve which contains motor fibres, muscular contractions will be excited at the moment of completing as well as at that of breaking the circuit, but not while the current is passing. These phenomena take place whatever be the direction in which the current be passed, whether from the nervous centre towards the periphery, (when the current is distinguished as the *direct current*,) or from the periphery towards the centre (when the current is styled the *inverse current*).

These effects may be produced in warm as well as in cold-blooded animals. In the former, however, the physical conditions necessary for the display of the vital forces continue for so

brief a period that cold-blooded animals should be selected for the experiments. On this account, as well as because of their peculiar susceptibility to the galvanic current, frogs are generally employed for this purpose. The most striking way of exhibiting the influence of the current, direct and inverse, upon the nerves is illustrated by the annexed woodcut. It represents a frog prepared in the manner adopted by Galvani. The integuments have been removed from the lower extremities, which have been separated from the trunk by the division of the lumbar region of the spine. The lumbar nerves are carefully raised from the muscles on which they lie, but are suffered to retain their connection with the spinal cord and with the thighs. The pelvic bones, however, are removed so as to admit of the more free separation of the extremities, as well as to isolate the nerves more completely. Each leg is immersed in a glass or cup of water, and the current is made to pass through the limbs by immersing each wire of the battery in the water of the cups. It is obvious that in one limb the current is direct, whilst in the other it is inverse.

The advantage of this arrangement is that it affords great facility in making and breaking the current without bringing the conducting wire of the battery into actual contact with either limb. One wire may be left constantly in the water, while the other can be alternately introduced or removed from it as we wish to observe the effects of completing or of breaking the current.

2. If the current be allowed to pass for a short time through the nerves of a frog, prepared as before-mentioned, contractions will no longer take place in both limbs at the same time, but only in one upon completing the circuit, in the other on breaking. And we shall always find that the contractions occur on making in the limb in which the current is direct, on breaking in the limb in which the current is inverse. I find it useful to adopt the following formula to impress this fact upon the memory; MD, BI, making direct, breaking inverse.

3. If the current continue to pass for some time longer, these phenomena cease completely

Fig. 393a.

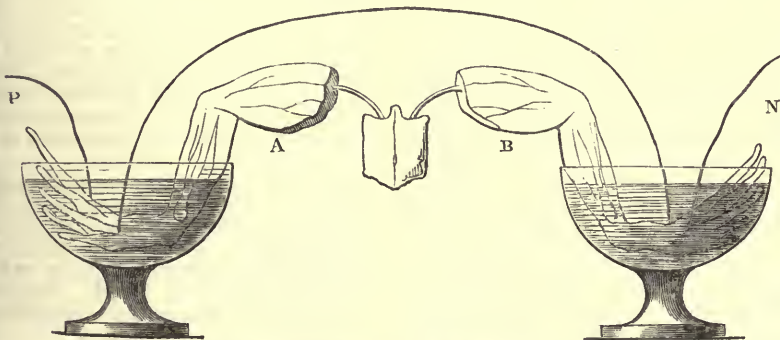

Lower extremities of the prepared Frog.

P, positive wire of the battery; N, negative ditto. In the limb A the current will be inverse; in B it will be direct.

and no contractions are produced. They may, however, be reproduced by inverting the direction of the current by transposing the conducting wires of the battery. The current will now be inverse in B, and direct in A, *fig. 398a*. Or the fact may be illustrated by another disposition of the legs of the frog. Let both feet be immersed in one vessel and the pelvis in the other. The direct current may now be passed along the nerves in both limbs at the same time, until the phenomena of contraction on making or breaking cease. Inverse the current, and the contraction will again become manifest. This fact was first discovered by Volta, and this mode of exhibiting it has been described under the title *Alternatives Voltianes*. If the inverted current continue some time, exhaustion will be produced; but on inverting it again or restoring it to its former course, the actions will recommence.

4. These effects cannot be produced unless the nerves be in a state of integrity. If a ligature be tightly applied to the nerve of either limb close to the muscles, the contractions in that limb will no longer take place. Or to give a more striking illustration of this important fact, if a drop or two of pure sulphuric ether be applied to a point of either nerve, the contractions in the limb of that side will be suspended until the effects of the ether pass off. These experiments unequivocally shew that the nerves are not merely conductors of the electrical current, but that the passage of the current through them develops in them a change which influences the contractile force of the muscles.

5. The influence of the galvanic current affords the most striking results when *motor* nerves are made the subject of the experiments, but Matteucci has shown that sensitive nerves are affected in an analogous way by the inverse and direct current. In a living rabbit the sciatic nerves were exposed, and one nerve was deviated to the direct current, the other to the inverse. Opening and closing both currents were accompanied with marked signs of pain, which, however, were greatest at the closure of the inverse current. After a short time, the signs of pain are manifested only on opening the direct current and closing the inverse.

The reader will scarcely fail to observe that both as regards the sensitive and motor nerves, the effect of the electric current, whether in causing pain or in producing contractions, is greatest when the current passes through the nerve in the course in which the nervous force would naturally proceed in the ordinary nervous actions. It is further worthy of notice that the continuance of the direct current exhausts the power of the nerve, while the reversal of the direction of the current, if not too long delayed, restores it. The continuous passage of the current, however, is not marked either by contractions or by pain. The interruption of the current by any means at once develops these phenomena; or even the diversion of a portion of it produces the same effect, as Marinini showed long ago. If, for instance, the two vessels in which the frog's paws are immersed be connected by a conductor, as an arc of copper

or silver wire, contractions will take place on making or breaking the connection; or if the wires of the battery be connected by a third wire of the same material before they dip into the cups, the same effects will be produced.

The continued transmission of an inverse current through a nerve increases to a remarkable extent its excitability. This is shewn by the following experiments: let the limbs of a frog be placed in two vessels of water and the current be passed through them in the manner above described, and let this be continued for a few minutes. After the lapse of this period, if the circuit be broken by taking one of the wires out of the water, the limb in which the current was inverse will be thrown into a state of tonic or tetanoid spasm for a few seconds, the tetanus ceasing with a clonic convulsion on the renewed completion of the circuit.*

That these phenomena are due to a *change developed in the nerve* (not to any affection of the muscles) by the passage of the galvanic current, is clearly demonstrated by applying the galvanic current to a muscle directly, having first removed as much nerve out of it as possible. The muscle will contract equally on making and breaking the circuit, whatever be the direction of the current; nor is it possible to produce tetanic spasm, however long the current may have been continued through it. The following experiment, suggested by Matteucci, also strongly confirms this view. Let the current be passed through the limbs of a frog in the ordinary way. After the current has passed for 25 or 30 minutes, cut the nerve traversed by the inverse current, at the point where it plunges into the thigh, and there will instantly ensue a violent contraction of that limb, which ceases very quickly. If, however, instead of this the nerve be cut where it issues from the spinal cord, *so as to leave a certain length of the nerve attached to the thigh*, there will be a violent contraction of the muscles, which will be followed by others, and the limb will remain in a tetanic state for 10 or 15 seconds or longer.†

The tetanoid contractions of the muscles may be produced by a rapid series of currents passed through the nerve alternately in the inverse and direct course, as by the electro-magnetic or the magneto-electric instrument. These are always greatest and last longest if a portion of the nervous centre remain connected with the limbs. E. H. Weber has lately made a very interesting series of researches by means of the magneto-electric rotation instrument developing the peculiar mode of action of particular muscles.‡

We cannot explain these remarkable phenomena on any other principle than on that which supposes the development of the nervous force to be associated with the assumption of a polar condition by the molecules of the nerves under the influence of certain stimuli. The inverse current excites a polar state of greater intensity

* Matteucci, *Phil. Trans.* 1846.

† *Comptes Rendus*, March 15, 1847.

‡ Wagner, *Wörterbuch. Art. Muskelbewegung.*

and of longer duration than the direct current : hence the tetanic contractions which remain after the interruption of the current.

It is sufficiently obvious why a contraction should occur at the moment of completing the circuit in a nerve. But why the same phenomenon should occur on breaking the circuit is not easily explained. Marianini supposed that during the passage of a direct current through a nerve a part of the electricity accumulated in it, and on the interception of the current discharged itself, traversing the nerve in an opposite direction, and thus giving rise to contractions. It is not, however, likely that such an accumulation would take place, when the conducting power of muscle is so much better than that of nerve. And further, it is evident that this will not explain the absence of contractions in the direct limb after a time on breaking the circuit.

The truth is, that when a continuous current has been passed through the limb of a frog for some time a different state of excitability is established in the nerve of each limb according to the direction which the current had taken. That in which the direct current passes becomes exhausted in its powers, while that in which the inverse current passes has its excitability augmented. In the quiescent state a nerve maintains a certain state of tension: the application of a stimulus modifies this tension and causes the nerve to assume a new polar state, which displays itself in the contraction of muscles or the excitation of a sensation or of pain. The electric current is a powerful stimulus of the nervous force, and the greatest disturbance of the quiescent state of tension is produced by making the direct current. Upon this current beginning to pass, a new state of tension is established, which is disturbed by breaking the circuit: but if the current have continued to pass too long, the maintenance of the state of unnatural tension exhausts the nervous power, and the nerve ceases to respond to any stimulus. Whilst, however, the nerve of the direct limb has assumed one condition, that of the inverse limb has taken on a different one, in which the molecules of the nerve may be conceived to have a disposition the opposite to that which the direct current would produce. Hence only two electric stimuli would restore the particles of the inverse nerve, and so disturb the state of tension into which it had been thrown, namely, making a direct current through the nerve, or simply breaking the inverse.

The tetanoid state which results from the continued passage of the inverse current through a nerve is a phenomenon resulting from the extreme augmentation of its polarity. This state is never produced by the direct current; and the instantaneousness with which it is removed by resuming the current, thereby restoring the state of tension which had been disturbed by breaking the circuit, is highly favourable to this supposition. Anything which weakens the force of the current, or diverts a portion of it from the nerve, as the contact of muscles with the nerve, or of much moisture, or the occasional reversal of the current making it direct

where it had been inverse, will materially retard and diminish, or altogether prevent the development of this phenomenon.

The rapidity with which the changes in the nerves, however they may have been excited, are propagated, and the precision with which they are perceived by the mind in the case of sentient nerves, or produced by it in the case of motor nerves, are well calculated to excite our admiration. If the communication between the nerve and the centre be cut off, the will can exert no influence upon the muscles supplied by the nerve below the section; nor will the mind perceive any stimulus applied to parts which derive their nerves from below the separation. And this for an obvious reason; because the solution of continuity of the nerve interrupts the propagation of the change which the mental or physical stimulus excites in it. In the case of the voluntary nerves, the effects of the mental stimulus are propagated no further *peripherad* than the point of section; and in that of the sensitive nerve, the change travels no further *centrad* than the same point. That this interruption is caused solely by the solution of continuity, and not by any alteration in the properties of the nerve, is proved by the fact that the lower segment of the motor nerve will still continue to respond to a physical stimulus. Mechanical or chemical irritation, or the passage of an electric current along it, will cause its muscles to contract. Such a degree of injury to a nerve as will break the continuity of the nervous matter within the tubular fibres is likewise sufficient to destroy its power as a propagator of nervous change. This effect may be produced by tying a ligature very tightly round a nerve, or by pressing it with great force between the blades of a forceps. The paralysis, which results from the compression of a nerve by a tumour or in any other way, is, no doubt, due to a similar solution of continuity in the nervous matter.

These facts strongly denote the important principle in nervous physiology, that, in propagating the influence of a stimulus, either from periphery to centre, or vice versa, the whole extent of the nerve-fibre between the point stimulated and its peripheral or central connection is the seat of change; and that the power of developing the nervous force is inherent in the nerve-fibre itself is shown by the fact that the stimulation of a muscular nerve, which has been separated from the centre, below the point of section is capable of exciting muscular action. The conducting power of a nerve, then, results from its proneness to undergo certain changes, physical or chemical, under the influence of stimuli.

We may perceive, then, how important it must be to the healthy action of nerves to preserve them in a sound physical condition. A morbid fluid impregnating a nerve at any point may irritate it, or may suspend or destroy its inherent property by modifying its nutrition or impairing its physical condition. Thus we may paralyse nerves by soaking them in a solution of opium, or of belladonna, aconite, or tobacco, in sulphuric ether, or other sedative or

narcotic substances; or, on the other hand, we may unduly excite them by applying a strong solution of strychnia. The contact of a solid body with a nerve may irritate and keep up a continual state of excitement, if it do not destroy its properties. A spiculum of bone, in contact with nervous fibres, is often the cause of the severest forms of neuralgia; inflammation may produce like effects. Various physical agents may produce similar consequences. The numbing influence of cold is explained in this way. Exposure to a continuous draught of cold air is a frequent cause of facial paralysis. The giving way of a carious tooth will immediately occasion toothache by exposing the nerves of its pulp to the irritating influence of the air, or of the fluids of the mouth. And undue heat is likewise injurious to the physical constitution, and, therefore, to the action of nerves. These facts are of great interest in reference to the pathology of nervous diseases, and suggest that the attraction of a morbid material in the blood to a nerve or set of nerves, or to that part of the nervous centre in which such nerves may be implanted, may afford satisfactory explanation of many obscure phenomena of nerves of sensation.

The organic change, whatever be its intrinsic nature, which stimuli, whether mental or physical, produce in a nerve, develops that wonderful power long known to physiologists by the name *vis nervosa*, the nervous force. This force is more or less engaged in all the functions of the body, whether organic or animal. In the former its office is to regulate, control, and harmonize; in the latter it is the main-spring of action without which none of the phenomena can take place. It is the natural excitant of muscular motion, and the display of that wondrous power depends upon its energy; without vigour in the development and application of the nervous force, a well-formed muscular system would be of little use, for it would quickly suffer in its nutrition if deprived of that exercise which is essential to it.

In the various combinations of thought which take place in the exercise of the intellect, there can be no doubt that the nervous force is called into play in the hemispheres of the brain. Here the stimulus is mental; the independent operations of the mind excite the action of the appropriate fibres of the brain, and the development of the nervous force in the brain immediately succeeds the intellectual workings. It is thus that we explain the bodily exhaustion which mental labour induces; and thus, too, we can understand the giving way of the brain—the inducement of cerebral disease—under the incessant wear and tear to which men of great intellectual powers expose it. On the other hand, physical changes in the brain, of a kind different from those which are normal to it, the circulation of too much, or too little, or of a morbid blood, may excite mental phenomena in an irregular way and give rise to delirium or mania.

Of the conditions necessary for the maintenance of the power of developing the nervous force.—From what has been already stated, it is mani-

fest that a healthy physical state of the nervous matter, whether in the nerves or in the nervous centres, constitutes the main condition necessary for preserving in them the power of developing the nervous force. And as nerves will not maintain their healthy nutrition unless they be in union with the nervous centres, this union becomes an important condition for the maintenance of this power in nerves. In the nervous centres the nerves form a connexion with the vesicular matter. We therefore infer that this connexion of the fibrous and vesicular matter is necessary for the exercise of the peculiar power of nerves, because we know of no instance, either in the human economy or in that of the inferior creatures, in which the nervous power is developed without this union.

It is true that if a motor nerve be separated from the nervous centre, its peripheral segment will evince a susceptibility to stimuli, or, in other words, it will retain the power of generating the nervous force for some time after the separation. This is, however, only for a short period, as the experiments of Longet distinctly show. Longet cut out a portion of the sciatic nerve in dogs, and irritated the lower segment of the nerve on each succeeding day by means of galvanism from a pile of twenty couples, and by mechanical irritation. The nerve ceased to be excitable *on and after the fourth day*, (“*des le quatrieme jour.*”)* These results, although they appear to differ from those obtained by Müller and Sticker, and Steinruch, are not really inconsistent with them. These observers, instead of examining and irritating the lower segment of the nerve each succeeding day after the section, allowed it to remain for an arbitrary period untouched, and then reopened the wound to try the effect of stimulating the nerve. Thus Müller and Sticker waited eleven weeks in one rabbit, five weeks in a second, and two months and a half in a dog, and in all the cases found the nerve inexcitable; and Steinruch waited four weeks, at which time he found that the power of the nerve had disappeared. It is obvious that there was nothing in any of these experiments to cast a doubt on the possibility of the nerve having lost its excitability at a much earlier period after the section, and that the selection of five or eight or eleven weeks, as the period when to inquire whether the nerve retained its excitability or not, was entirely arbitrary on the part of the experimenters.

The rapidity with which a nerve loses its power after it has been separated from the nervous centres clearly denotes that connection with the centre is a necessary condition for the nutritive activity of nerves, and is, therefore, a necessary condition for their functional activity, or, in other words, for the full development of the nervous force under its appropriate stimuli. There are, however, other facts which, inasmuch as they enhance the importance of the vesicular matter in the manifestation of nervous phenomena, give great weight to the proposition under consideration. These are—

* Longet, *Recherches Experimentales sur l'Irritabilité Musculaire*: l'Examineur Med. Dec. 1841.

1. That there is invariably an accumulation of vesicular matter around the points of implantation of nerves in the centres, as already referred to. This is true of all nerves in the vertebrata and the higher invertebrata, and we know of no reason to doubt it in the lower invertebrata. 2. The quantity of the vesicular matter around the point of implantation of a nerve is in the direct ratio of its size and of the activity of its function. Under particular circumstances the quantity of vesicular matter becomes so large as to cause a special ganglionic enlargement of the portion of the centre in which the nerve or nerves may be implanted. The cervical and lumbar enlargements of the spinal cord are due to this cause: the gangliform swellings on the upper part of the spinal cord in the gurnard (*trigla lyra*) are connected with the exalted functions of the nerves of touch distributed to the feelers, and contain a large quantity of vesicular matter. A remarkable instance of the development of vesicular nervous matter under similar circumstances is to be found in the electric lobes of the Torpedo, in which are implanted the nerves distributed to the electrical organ. These lobes are of very considerable size, much exceeding that of any other part of the brain, and they contain vesicular matter in large quantity. The nerves implanted in them are of great size.*

Such facts as those cited in the preceding paragraph denote clearly that the development of the nervous force is to a certain extent connected with the vesicular nervous matter, and to such a degree as to justify the opinion that this element of the nervous centres may be viewed as the dynamic matter, the originator of the force. At the same time it must be borne in mind that this form of nervous matter never occurs alone, and that probably the union of the two is necessary for the development of nervous power. Just as the union of two metals in the galvanic battery is necessary for the development of the current, while one of them, that, namely, which possesses the greatest affinity for the fluid interposed between them, seems to originate the current, and is on that account called the *generating* plate, whilst the other is called the *conducting* plate.

Of the nature of the nervous force.—All that we have said respecting the mode of development and the laws of the nervous force denotes its polar character.

We can no more detect by our senses any physical change in the piece of soft iron which is rendered *magnetic* by the galvanic current, than we can discover a change in the particles of a nerve stimulated to action by the same current. That both the iron and the nervous matter are thrown into an analogous state by the same agent seems highly probable. In the case of the iron the indication of the assumption and of the maintenance of the polar state is afforded by its power of attracting particles of iron; while in a muscular nerve the assumption and maintenance of the polar state are

shown by the active contraction of certain muscles, or a more tonic state of passive contraction. While the current is passing through a motor nerve there is no active contraction of the muscles; but that these organs are in a more excited state than the ordinary one of passive contraction seems evident enough, from the readiness with which they assume a tetanic condition upon the cessation of the passage of an inverse current which had been allowed to pass through their nerves for some time. And the fact demonstrated by Marianini and Matteucci, that the passage of a continuous current through a nerve will after a time exhaust its excitability, although not so quickly as a current frequently interrupted, denotes that the nerve is in an excited state during the actual passage of the galvanic current.

Is the nervous force electricity?—There is so much resemblance, as regards their mode of development and propagation, between the nervous force and electricity, that many physiologists have been led to regard these forces as identical. The nervous force, however, presents striking points of difference from electricity, which render it highly improbable that it is identical with that force, and which show that if it be so it must be an electricity of extremely low tension.

1. The ordinary tests for electricity fail to detect the existence of a galvanic current in the nerves, whether during their quiescent or their active state. The most delicate galvanometers have been employed for this purpose, in vain, by Prevost and Dumas, who were themselves advocates of the electrical theory of nervous action, by Person, by Müller, by Matteucci, and by myself. Person connected the wires of a galvanometer with the surfaces of the spinal cord in kittens and rabbits, in which spasmodic action of the muscles had been excited by the influence of nux vomica, and was unable to discover any evidence of electrical action. It had been affirmed that needles introduced into the nerves or muscles of living animals became magnetic during nervous and muscular action, so as to attract iron filings, but neither Müller nor Matteucci has succeeded in obtaining such a result from their experiments. Matteucci took the precaution of employing astatic needles for the purpose, but could detect no signs of magnetization. He also introduced the prepared limbs of a frog into the interior of a spiral covered on its inside with varnish; the extremities of this spiral were united to those of another smaller spiral, into which he introduced a wire of soft iron. The nerves of the frog were irritated to excite muscular action, and at the same time Matteucci sought to ascertain if an induced current would traverse the spirals and magnetize the wire, but to no purpose.

2. Were it to be admitted that the nervous force and electricity were identical, it cannot be doubted that the provision made for propagating the latter force in the nerves is very inadequate. The nerves are very imperfect conductors of electricity; Matteucci assigns to them a conducting power four times less than that of muscle; Weber states that they are very

* Savi, Etudes Anat. sur le Système Nerveux et sur l'Organe Electrique de la Torpille.

inferior to the metals as conductors. And from experiments made on this subject in 1845 by Dr. Miller, Mr. Bowman, and myself, we were led to conclude that nerve was infinitely a worse conductor than copper. The provision for insulation, however perfect for the nervous force, seems most insufficient for electricity, unless, perhaps, for a current of very feeble intensity. Yet we know that the nerve fibres convey the mandates of the will with the nicest precision to the muscles, and propagate the effects of physical stimuli applied to the periphery with the greatest exactness to the centre. This could scarcely be if the force so propagated were an imperfectly insulated electric current, for it is evident that in such a bundle of fibres as a nervous trunk disturbances would continually be taking place, from the secondary currents induced in neighbouring fibres by the electricity passing through those in action.

3. The firm application of a ligature to a nerve stops the propagation of the *nervous power* along that nerve below the point of application; the passage of electricity, however, is not interrupted by these means. The nervous trunk, indeed, is as good a conductor of electricity after the application of the ligature as before it, provided it do not become dry at the point of ligature.

4. If a small piece be cut out of the trunk of a nerve, and its place supplied by an electric conductor, electricity will still pass along the nerve and along the conductor; but the nervous force, excited by a stimulus applied above the section, will not be propagated through the conductor to the parts below.

5. The existence of an organ in certain animals capable of generating electricity is unfavourable to the electric nature of the nervous force. The best examples of this organ are found in the Torpedo and the Gymnotus; and experiment has placed it beyond doubt that the organ generates electricity, which is capable of giving a shock similar to that from a Leyden jar; which develops a spark during the discharge, and can effect electrolysis; by which, likewise, the galvanometer may be disturbed, and needles rendered magnetic.*

The electrical organs have no resemblance, in point of structure, to nerves; they, however, present a remarkable analogy in that respect, as well as in their physiological action, to the striped variety of muscles. They are composed of a number of prisms, each of which consists of a membrane closed at both extremities, and containing a soft albuminous substance, but subdivided by transverse very delicate septa into a multitude of small compartments. The bloodvessels and nerves are distributed upon the enclosing membrane and upon the septa, but do not penetrate the albuminous material. On these septa, according to Savi, the nerves form a network, in which the disposition of their terminal fibres differs from that in muscle in there being a true anastomosis or fusion of the primitive tubules. The analogy of the structure of the electrical prisms with that of muscular fibres is sufficiently obvious, the latter

being prismatic columns of fibrine, enclosed by a membrane, the sarcolemma, and separable into discs, the nerves and vessels being distributed upon the sarcolemma, and not penetrating the contained sarcous elements. In both these textures the anatomical disposition has evident resemblance to the artificial arrangements for generating electricity, and accordingly in one (the electric organ) true electricity is generated; in the other, as we shall see further on, either electricity, or a force in close relation to electricity, is developed. In both cases the generation of the force is independent of the nervous system; its exercise and application, however, are under the influence of that system.

The arrangement of the nerves and nervous centres is essentially different from that of muscle or of the electric organ, and so far would suggest a decided difference in the character of the force which they can develop from that produced by the latter textures.

6. A comparison of the muscular with the nervous force throws somelicht on the nature of the latter, and upon its true relation to electricity.

Matteucci has established beyond a shadow of doubt that electricity of feeble tension is generated in the ordinary nutrition of the muscles of all animals, and by a particular arrangement this may be made to assume the current form, passing from the interior to the exterior of the muscle. The source of this electricity is no doubt to be found in the chemical action which accompanies the nutrition of the muscular tissue, "principally that which takes place in the contact of the arterial blood with the muscular fibre."† The intensity of this current increases in proportion to the activity of muscular nutrition, and in proportion to the rank the animals occupy in the scale of beings. It requires a particular artificial arrangement to accumulate the electricity in such a manner as that it shall affect the galvanometer; "during life the two electric states evolved in the muscle neutralize each other at the same points from which they are evolved;" but in the arrangement of a muscular pile as devised by Matteucci, "a portion of this electricity is put in circulation just as it would be in a pile composed of acid and alkali, separated from each other by a simply conducting body."

During the *active contraction* of a muscle, however, a force is developed which has resemblance to electricity, and in his early experiments was regarded in that light by Matteucci. This power is capable of affecting the nerve of the frog in the same manner as electricity. The following experiment displays this:—Take the lower extremity of a frog and skin it; dissect out the sciatic nerve from among the muscles on the posterior part of the thigh, and then separate the thigh by cutting it across just above the knee-joint, leaving the nerve connected with the knee and leg; this preparation is the *galvanoscopic frog*, so called by Matteucci from the readiness with which it indicates an electric current; next prepare the lower extremities of a frog according to Galvani's method:

* See ELECTRICITY, ANIMAL.

† Phil. Trans. 1845, p. 294.

the nerve of the leg is to be laid upon the muscles of either thigh, and if these muscles be excited to contraction by mechanically stimulating the lumbar nerves, or the spinal cord, or by passing a galvanic current through the nerves or the cord, the muscles of the galvanoscopic leg will be simultaneously contracted. If a second and a third galvanoscopic leg be prepared, and the nerve of the second be laid on the muscles of the first, and that of the third be laid upon the muscles of the second, contractions will take place in all three whenever the muscles of the prepared thighs are thrown into contraction. Matteucci, to whom we owe the discovery of this important fact (which he terms *induced contraction**) has failed to cause a fourth leg to be thus affected.

If the galvanoscopic nerve be laid on the muscles of a frog's thigh in which tetanoid convulsions have been produced by the cessation of a long continued inverse current, the induced contractions will be likewise tetanic.†

The annexed woodcuts (figs. 398b & 398c) will serve to show the manner in which these experiments may be performed.

It is plain, then, that during the contraction of muscles, whatever be the means used to stimulate them, a force is evolved capable of exciting a nerve laid upon the exterior of the contracting muscle to such a degree as to cause contraction of the muscles it supplies. What is this force? The readiness with which it excites the nerve of the galvanoscopic leg resembles the action of electricity, and this view of its nature is favoured by the known fact that during muscular contraction heat is evolved, and in some of the marine animals, light also, according to the observations of Quatrefages. If heat and light be produced during muscular

contraction, it is not unreasonable to expect that electricity should be evolved likewise. Matteucci's experiments, however, throw some difficulty in the way of viewing it as such. He finds that this force will freely permeate very imperfect conductors of electricity, whilst it will not traverse substances which are known to conduct electricity. If gold leaf be placed upon the muscle between it and the nerve, the con-

Fig. 398b.

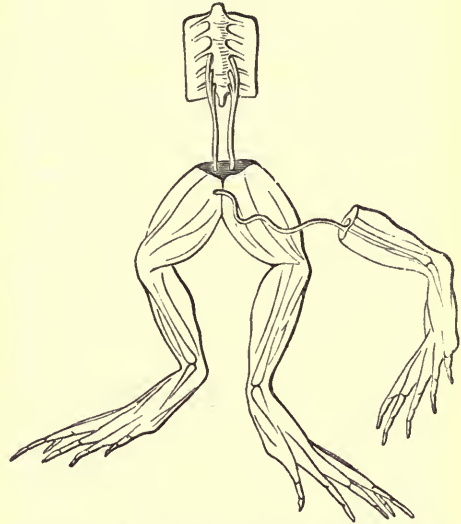

The limbs of a frog prepared according to Galvani's method, the nerve of the galvanoscopic leg being laid across the muscles of one thigh. When these muscles are thrown into contraction by any means, mechanical or galvanic, those of the leg contract at the same moment.

Fig. 398c.

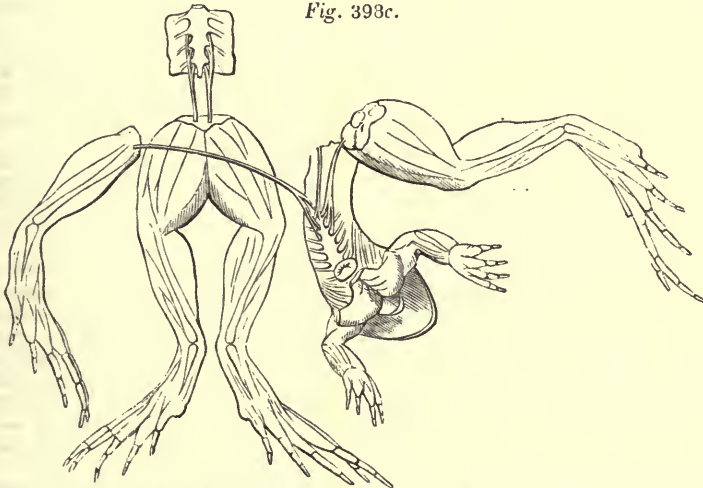

The limbs of a frog prepared after Galvani's fashion. In another frog the galvanoscopic leg is prepared, but the sciatic nerve is left in connection with the lumbar plexus and the spinal cord. If this nerve be laid across the thighs of the frog and the limbs be made to contract, contractions will be simultaneously excited in the galvanoscopic leg and also in the other one. It is plain that while the contractions in the galvanoscopic leg are excited by the direct stimulation of the sciatic nerve, those in the other leg are excited through the excitation of the spinal cord by the sensitive fibres of the same sciatic nerve.

* Phil. Trans. 1845, p. 303.

† Id. 1846, p. 487.

tractions of the galvanoscopic leg will not take place. If, however, a slight tear be made in the gold leaf, then the nerve may be excited. It is possible that this may arise from the electricity being carried off by the gold leaf, so that it does not affect the nerve at all. Matteucci never succeeded in obtaining the induced contractions when a solid body was interposed between the nerve and muscle, however thin it might have been and whatever might be its nature; for this purpose he used flakes of mica extremely thin, flakes of sulphate of lime, gold leaf, paper smeared with glue, and leaves of vegetables.*

On the other hand, in interposing some substances which are known to be bad conductors of electricity, the contractions were obtained. The induced contractions may be excited if the nerve be laid upon the skin over the muscles of the inducing frog. "The experiment," says Matteucci, "never fails of success, whether the inducing contraction be excited by the electric current or by any stimulus applied to the lumbar plexuses of the inducing frog." The use of a very bad conducting body, Venice turpentine, did not prevent the induced contractions. The nearly solid Venice turpentine was rendered more or less liquid by adding to it a little of the volatile oil of turpentine, and with this the muscles were smeared over, and the nerve of the galvanoscopic frog was wetted. To prove the bad conducting powers of the mixture employed, one pole of the exciting pile was applied to the muscle and the other to the galvanoscopic frog without exciting the least contraction. Yet the contractions were induced in the galvanoscopic frog by stimulating the muscles of the thigh. This experiment clearly proved, as Matteucci remarks, that the induced contraction may be excited through a stratum of an insulating substance that prevents the propagation not only of the muscular and proper currents, but also of that current which excites the inducing contraction.

We are forced then by the results of the remarkable experiments above detailed to adopt the conclusion at which Matteucci has himself arrived—that there is no *current* of electricity in the act of muscular contraction. What then is the evolved force? It is either an *electric discharge*† or a force very analogous to electricity, affecting nerves in a similar way, travelling apparently with great rapidity, traversing bodies which the galvanic current cannot traverse, and yet restrained by substances which freely conduct it.

I confess myself at a loss to understand how Matteucci comes to regard this as a phenomenon of the nervous force. In truth, it is a phenomenon which accompanies muscular contrac-

tion, and has no relation to the nervous force, excepting so far as that is the excitant of the muscular action. The essential point of the phenomenon is, that during the contraction of a muscle a nerve which is laid on it is stimulated just as it would be by electricity, and causes the muscles to which it is distributed to contract. The electric discharge from a muscle which is excited to contract through the exercise of nervous power is in close analogy with the electric discharge from the electrical organ of the Gymnotus or Torpedo, which is excited through the same agency.

Now the proved existence of a muscular force, the development of which is accompanied with heat, and most probably electricity, and in some instances, if the statements of Quatrefages be correct, with light, justifies us in adopting the opinion, as regards the nervous force, that this is of an analogous kind, yet exhibiting still less resemblance to electricity than the muscular force; and it strikingly illustrates the remark of Faraday, that if there be reasons for supposing that magnetism is a higher relation of force than electricity, so it may well be imagined that the nervous power may be of a still more exalted character and yet within the reach of experiment.

We are thus led to these conclusions respecting the muscular and nervous forces.

1. That both are polar forces and in close analogy with light, heat, electricity—magnetism.

2. That either may be excited by or transformed into the other—the nervous may excite the muscular, or the muscular the nervous. It seems not improbable that it is by this reaction of the muscular upon the nervous force that the muscular sense is developed, and as Matteucci has ingeniously suggested, many movements independent on the will, yet following others which may be voluntary or otherwise, may result from the same cause.

3. That the same analogy which exists between electricity and magnetism is found between these organic polar forces; the muscular being more nearly allied to the former, the nervous to the latter.

4. Both these forces are dependent on the healthy nutrition of their respective tissues, muscle and nerve, and the slightest disturbance in that process in either tissue will readily affect the intensity of the force.

5. Nevertheless there is a certain mutual dependence between these two tissues and their forces; for the exercise of each is, within certain limits, impossible without the other; and as this exercise is necessary to maintain healthy nutrition, so these forces are to a certain extent dependent on each other for their normal development. The practitioner in medicine will duly appreciate the great importance of this conclusion.

The mutual reactions of the nervous and muscular forces constitute a new and highly important field of inquiry, which, if duly cultivated, may clear up many obscurities in the physiology and pathology of the nervous system.

Having thus far considered certain generalities in the physiology of the nervous system, we may now proceed to inquire into the share

* Phil. Trans. 1845, On induced contractions.

† From a letter addressed to M. Dumas by Professor Matteucci, and published in the Comptes Rendus for March 15, 1847, it appears that he now is rather disposed to regard it as an electric discharge, as he says, "C'est après avoir prouvé que des décharges électriques de la bouteille tellement faibles qu'elles ne peuvent être montrées par aucun instrument, excepté par la grenouille, que j'ai pensé que la contraction induite pouvait être due à une décharge électrique de ce genre."

which each part of this great system takes in the production of nervous phenomena. This inquiry naturally divides itself into two branches, namely, first, the functions of nerves; secondly, those of nervous centres.

Of the functions of nerves.—Nerves are intennuncial; they possess in themselves (separate from the nervous centre) only a very limited power of developing the nervous force, and that only in response to a physical stimulus, for connection with a centre is necessary for the exercise of a mental stimulus.

In inquiring into the function of any particular nerve, the problem is to determine whether it propagates the nervous force *centrad* or *peripherad*, and whether it be connected with the *centre of sensation* or with the *centre of volition*; whether, in short, it be sensitive or motor. It must be always borne in mind that most nerves contain nerve-fibres of different endowments, and that the office of any given nerve will be determined by the endowment of the greatest portion of its fibres. When we say, therefore, that a nerve is motor or sensitive, it is not to be understood that all its fibres are exclusively of that function, and that it contains no others of a different endowment.

In enquiring into the function of a nerve, the first point to determine is its anatomy, whereby we learn whether it be distributed to muscular parts or to sentient surfaces; and then to ascertain whether its distribution in man corresponds with that in the inferior animals. Anatomy, human and comparative, affords by far the most certain grounds to enable us to decide upon the endowment of a nerve: if the nerve be distributed to muscular parts, it is evident that it cannot be a merely sentient nerve, although it may contain some sentient fibres.

Experiment upon animals recently dead also affords considerable aid in reference to questions of this kind. Mechanical or chemical or galvanic irritation of a nerve will cause muscular contractions if it be a motor nerve, and will produce no perceptible change in either nerve or muscles if it be not muscular. Under certain circumstances, however, simple irritation of a nerve, while it evinces no change in the nerve itself or in the parts with which it is connected, will affect the portion of the nervous centre in which it is implanted, and will through that excite certain motor nerves to stimulate their muscles. To affect motor nerves through sensitive ones, it is generally necessary to stimulate their peripheral fibres, the entire trunk remaining uninterrupted in its course; and it would appear as if a certain peripheral organisation, as for instance a development of papillæ on the tegumentary surface, were necessary for this purpose. Very rarely irritation of the *trunk* of a sentient nerve produces this effect; the least equivocal instance indeed in which, so far as I know, muscular action can be produced in this way, i. e., by irritation of the central segment of the trunk of a nerve, is in the case of the glosso-pharyngeal nerve. Dr. John Reid has succeeded, after section of this nerve, in producing contraction of the pharyngeal muscles by stimulating its central segment.

M.M. Longet and Matteucci affirm that a

motor nerve may be distinguished from a compound one by the different effect produced on each by opening or closing a galvanic current, according to the direction in which it passes in the nerve. We have referred above to the results of experiments on compound nerves, the sciatic for instance, by means of the electric current. Compound nerves, as has been shown by these means, may at first be affected equally on opening as on closing the circuit, whether the current be direct or inverse; but after a time they are excitable, as shown by the contraction of the muscles below the point stimulated, only on *closing the direct current* or *opening the inverse*. With a purely motor nerve, however, such as the anterior root of a spinal nerve, a different result is obtained after the first period has passed; inasmuch as the contractions of the muscles can only be excited *on opening the direct current* or *closing the inverse*.*

Experiment upon living animals likewise affords us some assistance in determining the functions of nerves. This mode of inquiry, however, must be used with great circumspection, and great caution must be observed in the interpretation of the results which it elicits. Section of a nerve paralyses its function, and occasions loss of motor or of sensitive power, according to the nature of the parts to which the nerve is distributed. Experiment of this kind, however, frequently leads to very unsatisfactory results, because it is often a matter of extreme difficulty to reach the nerve in question; the operation for that purpose may involve other parts and nerves as well, and sometimes it may be impossible to divide one nerve without injuring another immediately adjacent to it. Moreover, the shock of a severe operation frequently produces so much disturbance in the entire system of the animal as to render it extremely difficult to form any accurate opinion as to the effects of the section of the nerve under examination.

Clinical medicine gives very important aid to physiological enquiries of this nature. Disease or injury of certain nerves impairs or destroys or modifies certain functions. The various forms of partial paralysis, especially those affecting the face, may be referred to in illustration of this assertion. Thus a very distinct series of signs accompany disease of the facial nerve or the portio dura of the seventh pair; and these signs mark it very distinctly as

* Matteucci et Longet, sur la relation qui existe entre le sens du courant électrique, et les contractions musculaires dues à ce courant. Paris, 1844.

It is an extraordinary circumstance that the excitability of motor nerve-fibres should be modified by their simple juxtaposition with sensitive fibres.

I learn from a recent communication from Prof. Matteucci, (May, 1847,) that he finds that etherization in dogs modifies the excitability of the nerves, so that the mixed nerves, while connected with the nervous centre, react with the direct or inverse current as the motor nerves do, and excite contractions on opening the direct current or closing the inverse; but the moment their connection with the cord is destroyed they exhibit the phenomena of mixed nerves, causing contraction with the direct current on closing, and with the inverse on opening.

the motor nerve to the muscles of the features, and to the orbicular muscles of the eyelids. Clinical research, indeed, taken in conjunction with anatomy, forms the basis of our present accurate knowledge of the office of this nerve. In like manner we learn that loss of sensibility of the face is dependent on disease affecting the fifth nerve, and from the parts of the face which are affected by anæsthesia we can tell what portions of that great nerve are diseased. Here again anatomy and clinical medicine have mainly contributed to the advance of our knowledge. The partial palsies which affect the muscles of the eye ball likewise give very distinct interpretation to the functions of these nerves, such as the third and sixth, the action of whose muscles is well understood. Many other instances might be quoted which clearly show that, while clinical medicine and anatomy are of infinite service in building up and confirming our knowledge of the function of nerves, this knowledge, in its turn, does great service in increasing the facility with which we can distinguish disease.

Of the functions of the roots of spinal nerves.

—The greatest part of the body is supplied with nerves which are implanted in the spinal cord, or which, in anatomical language, have their origin in that nervous centre. As these nerves present very definite and constant characters as regards the manner in which they are connected with the centre, characters which are not limited to the human subject, but which belong to all classes of vertebrate animals, it was a point of primary importance to discover the object of an arrangement so peculiar as regards its anatomical characters, and so universal. To our countryman, Sir C. Bell, belongs the great merit of having seen the importance of determining this point as a preliminary step in the investigations into the nervous system; and to him must be awarded the credit of having achieved the discovery of the difference in the endowment of the anterior and of the posterior roots of these nerves. He experimented on young rabbits, by removing the posterior wall of the spinal column. "On laying bare the roots of the spinal nerves," says Sir C. Bell, "I found that I could cut across the posterior fasciculus of nerves, which took its origin from the posterior portion of the spinal marrow, without convulsing the muscles of the back; but that, on touching the anterior fasciculus with the point of the knife, the muscles of the back were immediately convulsed."*

Numerous experimenters, subsequent to Bell, obtained precisely similar results. Muller,

* Sir C. Bell's first essay on this subject was printed in 1811. In 1822 Majendie published his first essay in the *Journal de Physiologie Exp.* t. iii; in 1831 Müller's experiments were published in the *Annales des Sciences Nat.* and in *Froiep's Notizen*. Mr. Alexander Shaw has published a temperate and judicious vindication of Sir C. Bell's claims in a volume entitled, "Narrative of the Discoveries of Sir C. Bell in the Nervous System." Lond. 1839.

Valentin is so satisfied of Sir C. Bell's claim to the discovery of the distinct endowments of the roots of the spinal nerves, that he designates the law thereby determined by a title not very euphonous to English ears, *Lcx Belliana*.

however, obtained the most decisive evidence of the proper functions of the roots of the nerves, by experimenting on frogs instead of on mammalia; in the former the spinal canal is of great width, especially at its lower part, and the roots of the nerves can be exposed with great facility, whilst in the latter the operation is tedious, painful, and bloody, the spinal canal narrow, and the roots of the nerves small and difficult to get at. Moreover, the excitability of the nerves lasts very much longer in frogs than in mammalia, and on this account the former animals are well adapted for displaying the effects of section of the roots and the influence of mechanical and other stimuli upon them.

In these experiments, (which I have frequently repeated with similar results,) irritation, mechanical or galvanic, of the anterior root of the spinal nerve always provokes muscular contraction. No such effect follows irritation of the posterior root. Section of the anterior root causes paralysis of motion; section of the posterior root, paralysis of sensation. This latter effect is shown by the entire insensibility to pain evinced on pinching a toe, whilst in the limb of which the posterior roots of the nerves remained entire such irritation is evidently felt acutely. If the anterior roots of the nerves which are distributed to the lower extremities be cut on one side, and the posterior roots on the other, voluntary power without sensation will remain in the latter, and sensation without voluntary power in the former.

Valentin, Seubert, Panizza, and Longet have performed similar experiments on mammiferous animals with precisely similar effects.

I have never seen motion produced by irritation of one of the posterior roots of the spinal nerves still in connexion with the cord, excepting when the galvanic stimulus has been applied, and too strong a current has been employed. Valentin states that he has observed motions so produced in rabbits, but not in frogs and tortoises. Dr. Hall has seen them in the turtle and skate. Van Deen speaks of them as constantly occurring. But Müller denies the power of the posterior roots to excite motion, except by "traction on the cord itself." No such effect ever follows any kind of stimulation of the posterior root when it has been separated from the cord.

The conclusion which inevitably follows from these experiments is that the *anterior root of each spinal nerve is motor, and the posterior sensitive.*

Comparative anatomy confirms this conclusion, by showing that a similar arrangement of the roots of spinal nerves prevails among all classes of vertebrate animals, and that if in any particular class either the motor or sensitive power predominate, there is in correspondence with it a marked development of the anterior or posterior roots. The frequent occurrence, likewise, of paralysis of sensation and motion, as a consequence of disease within the spinal canal, also tends to the same inference.

Kronenberg finds a small nerve of communication between the posterior and the anterior root, which is looked upon by some as being

the means of giving to the anterior root the slight degree of sensitive power which Majendie attributes to it.

From the determination of the office of each root of the spinal nerves we obtain the further important result, that the nerve, which is formed by the junction of these two roots, is sensitive and motor, and that nervous fibres of different endowments may be bound together in the same sheath constituting one nerve, which is compound in its functions. And the anatomical distribution of spinal nerves, both in man and the inferior animals, to the muscles and sensitive surfaces of the trunk and extremities, is entirely confirmatory of the results thus derived from experiment.

By the use of the various means for determining the functions of nerves, above detailed, and aided by the determination of the law discovered and developed by Bell and others, as to the motor nature of the anterior and the sensitive endowment of the posterior roots, and the subsequent binding together of these fibres in one sheath to form a compound nerve, physiologists have made great advances in determining the functions of the various encephalic nerves, and our knowledge on this subject may be said to have approached more to perfection than that of any other physiological questions. The main facts connected with the anatomy and physiology of each of these nerves will be found under the articles headed by their names.

Of the functions of the nervous centres.—

In examining into the functions of the various parts of the cerebro-spinal axis I shall adhere to the definitions already adopted in the previous part of this article, and use the term *spinal cord* as denoting the nervous cylinder within the spinal canal, and the *encephalon* as the intra-cranial mass, consisting of *medulla oblongata, mesocephale, cerebellum, and cerebrum*.

Of the functions of the spinal cord.—It was long held that the spinal cord was no more than a bundle of nerves proceeding from or to the brain, and emerging at various points of the vertebral canal to be distributed to their destined regions.*

The anatomy of the organ, however, sufficiently exposed the error of this opinion. The existence of a large quantity of vesicular matter in it varying in quantity according to the bulk of its segments showed that it was more than a mere fasciculus of nerves. Although the true office of the spinal cord was known to physiologists long before, to Prochaska for example, Gall appears to have been the first who adduced the best proofs from anatomy to show that the spinal cord was not a mere appendage to the brain, but a special centre in itself. His principal arguments were derived from the want of any constant proportion in bulk between it and the brain, the spinal cord being small with a large brain, as in man, and large with a small brain, as in the inferior mammalia and in other vertebrata, from the fact that it does not taper gradually in proportion as it

gives off nerves, but on the contrary is alternately large or small according to the number and volume of the nerves which are given off from its various segments; and, lastly, from the analogy which he indicated between the spinal cord of vertebrata and the ganglionic chain of articulata, the former consisting of a series of ganglia fused together, the latter remaining separate by reason of the peculiar disposition of the bodies of these animals in distinct segments.

The determination of the functions of the nerves which are intimately connected with or implanted in the spinal cord affords some clue to the solution of the problem as to its own office. There can be no doubt that as the nerves of sensation as well as those of motion of the trunk and extremities are all, to say the least, intimately connected with the cord, this organ must be the medium of the reception and propagation of the sentient impressions made upon the one, and of the mental or physical impulses which excite the others.

If, moreover, we look to the results of experiments on the lower animals, or to the effects of injury or disease in the human body, we obtain the following important facts:—1st, that the perfect connexion of this organ, in all its integrity, with the encephalon is the essential condition for the full and complete exercise of the nervous force, whether for sensation or voluntary motion, as far as regards the trunk and extremities; 2nd, that division of the cord, so as completely to separate the lower from the upper segment, causes paralysis both of sensation and voluntary motion in the parts supplied with nerves from the lower segment; 3rd, if the section be made high up in the neck so as to separate the cord from the medulla oblongata, all the parts supplied by spinal nerves will be paralysed in the same way; by such an experiment the spinal cord remains entire, but its continuity with the encephalon is interrupted.

In cases of injury to the vertebral column it may be laid down as the rule that the higher the seat of injury the more extensive will be the paralysis. A man who has received extensive injury of the spinal cord high up in the neck is like a living head and a dead trunk, dead to its own sensations, and to all voluntary control over its movements. The same rule prevails with regard to the effects resulting from disease of the vertebræ or from any intra-spinal growth, or from a morbid state of the cord itself, there being only this difference, that where the morbid change is chronic, the paralytic effects are less marked than in injury or acute disease. In all cases the *extent* of the paralysis affords a correct indication of the seat of the solution of continuity.

If the spinal cord be divided partially in the transverse direction, there will be paralysis of parts *on the same side* with the injury. Dr. Yellowly has put on record an experiment of Sir Astley Cooper's, in which he divided the right half of the spinal cord in a dog just above the first vertebra. The effect was paralysis of the motions of the ribs on the right side, and of the right posterior and posterior extremities, with irritation of those of

* That this was Willis's view a perusal of chapters xviii. and xix. of his *Cerebri Anatomie* will shew.

the left side.* A longitudinal section of the cord along the median line in frogs does not cause paralysis; it gives rise, however, to a temporary disturbance of the functions of the cord which soon subsides.†

Continuity of the spinal cord and encephalon is then the condition necessary to establish the control of the former organ over the *voluntary* movements and *sensations* of the trunk. The disunion of the cord or any portion of it from the encephalon dissociates the cord or the separated segment of it from all participation in mental nervous actions. So long as the cord is united with the brain, it takes a certain share in mental nervous actions, in acts of sensation and volition; this, however, it loses when disease or accident separates the one from the other.

It is plain, then, that the spinal cord, although apart from the encephalon it takes no share in sensations and voluntary actions, (for then, indeed, these phenomena cannot take place as far as regards the trunk and extremities,) while united with the encephalon participates fully in sensori-volitional actions, and its integrity is quite necessary to the perfection of those actions.

I repeat that we are not justified in supposing that the mind localises itself exclusively in some or all of the gangliform bodies, the assemblage of which constitutes the encephalon; but this we may assert, with perfect justice, that when the cord has been separated from the encephalon, the mind appears as it were to cling to the latter organ, and to lose all its connection with the former.

Does then the cord, under these circumstances, lose all its power? Does it, when separated from the encephalon, shew no indication of acting as a nervous centre? Undoubtedly it does show abundant indications. A series of actions, which had attracted the notice of several physiologists, are still capable of being developed through the instrumentality of the whole cord or of any portion of it, the nerves of which may remain uninjured both as to their central and peripheral connections.

Phenomena of this nature may be produced in all vertebrate animals. They are, however, especially marked in the cold-blooded classes, in consequence of the more enduring character of the nervous force in those creatures than in the warm-blooded. Hence frogs, salamanders, snakes, turtles, fishes, have been generally selected by physiologists for exhibiting these phenomena. In the young of warm-blooded animals they are more manifest than in adults of the same class.

If a frog be pithed by dividing the line of junction of the medulla oblongata with the spinal cord, the following effects may be observed. After the first disturbance, general convulsions, &c., consequent upon the division of the cord, the animal, if placed on a table, will assume his ordinary position of rest. In some cases, however, frequent combined movements, much resembling acts of volition, will

take place for a longer or shorter time after the operation. When all such disturbance has ceased the animal remains perfectly still and as if in repose, nor does it exhibit the slightest appearance or give the least expression of pain or suffering. It is quite unable to produce any spontaneous or voluntary movement of parts supplied with nerves from below the section, that is, of the trunk or extremities. However one may try to frighten it, it remains in the same place and posture. The only appearance of voluntary motion is the winking of the eyelids, which, however, probably is not excited by the will. If, now, a toe be pinched, instantly the limb is drawn up, or the animal seems to push away the irritating agent, and then draws up the leg again into its old position. Sometimes a stimulus of this kind excites both legs, and causes them to be thrown violently backwards. A similar movement almost constantly follows stimulation of the anus. If the skin be pinched at any part, some neighbouring muscle or muscles will be thrown into action. Irritation of the anterior extremities will occasion movements of them; but it is worthy of note that these movements are seldom so energetic as those of the posterior extremities.

We may remark here, that phenomena of this kind are not confined to the trunk and extremities, which are supplied only by spinal nerves. The head and face, with which the encephalon remains in connection, exhibit similar actions. The slightest touch to the margin of either eyelid or to the surface of the conjunctiva causes instantaneous winking; the attempt to depress the lower jaw for the purpose of opening the mouth is resisted; and the act of deglutition is provoked by applying a mechanical stimulus to the back of the throat.*

Actions similar to those which take place in the decapitated frog, occur in the human subject when the spinal cord has been separated from its encephalic connections by disease or accident. In such cases it is found that although the will cannot move the paralysed parts, the lower extremities for instance, movements do occur

* Sir Gilbert Blane, in his admirable Croonian Lecture on muscular motion, having drawn the distinction between instinctive and voluntary actions, makes the following remarks. "There are facts which show that instinctive actions, even in animals endowed with brain and nerves, do not depend on sensation. I took a live kitten, a few days old, and divided the spinal marrow by cutting it across at the neck. The hind paws being then irritated by pricking them, and by touching them with a hot wire, the muscles belonging to the posterior extremities were thrown into contraction, so as to produce the motion of shrinking from the injury. The same effects were observed in another kitten after the head was entirely separated from the body." And again, "In an acephalous monster, the like phenomena were observable. It moved up its knees, when the soles of its feet were tickled; it performed the act of suction; passed urine and faeces; and swallowed food." * * * "The like takes place with regard to insects; for, after the head of a bee is separated from the body, the hinder part will sting, upon the application of such a stimulus as would excite the same action in the animal in a perfect state."

* Med. Chir. Trans. vol. i. p. 200.

† See Flourens' Experiments, Syst. Nerveux.

in them of which the individual is wholly unconscious, and which he is utterly unable to prevent. Sometimes these take place seemingly quite spontaneously; at other times they are excited by the application of a stimulus to some surface supplied by spinal nerves. The movements of this kind, which seem to occur spontaneously, exhibit so close a resemblance to voluntary actions as to render it impossible to distinguish them, did not the consciousness of the patient in some cases assure him of the inactive state of his will in reference to them.

The comparison of the phenomena which occur in pithed or decapitated animals with the actions developed in man under these morbid states, affords most conclusive evidence as to the important question of the connection of these phenomena with the mind. In a pithed or decapitated animal we can only judge of the exercise of volition or the perception of sensitive impressions by external signs. And so far as these go we are justified in maintaining that, while the mental principle is unextinguished, it nevertheless has lost its influence over or connection with that portion of the cerebro-spinal axis which is separated from the encephalon. But in the human subject we have the evidence of the individual himself, who, from his own consciousness, avows the integrity of his will and perception, but admits their dissociation from those parts of the body whose nerves are implanted in the severed portion of the cord.

Let us refer to such a case as has been already quoted. A man has fallen from a height and fractured or displaced one or more of his cervical vertebræ; we find the patient presenting the following phenomena. His trunk and extremities appear as if dead, excepting the movements of the diaphragm, while the head lives. In full possession of his mental faculties and powers, he is, nevertheless, unconscious, save from the exercise of his sight, of any changes which may affect the parts below his head, nor is the utmost effort of his will sufficient to produce a movement of any, even the smallest, of these parts. If the stunning effect of the accident have passed off, tickling the soles of the feet will be found to cause movements, of which, as well as of the application of the stimulus, the patient is *unconscious*; the introduction of a catheter into the urethra, which the patient *does not feel*, excites the penis to erection. The limbs may be irritated in various ways, but without exciting any effect which the patient can perceive, excepting movements, and these he is aware of only from his happening to see them. It is important to notice that, in cases of this kind, movements are difficult of excitation in the upper extremities, while they are aroused with great facility in the lower.

In these cases movements may be excited in both lower extremities by passing a catheter into the bladder. Sometimes internal changes, the precise nature of which we cannot always appreciate, but which are often the result of the irritation of flatus or other matters in the intestinal canal, excite movements in the lower or even in the upper extremities, and the patient is disturbed by cramps and spasmodic

movements, more or less violent, at night. It is very remarkable, that while a patient is almost wholly insensible to external stimuli, he feels and even suffers pain from cramps of this kind.

In the hemiplegic paralysis which results from an apoplectic clot, or some other lesion affecting one side of the brain, when the paralysis is complete, the influence of the will over the paralysed side is altogether cut off, sensibility, however, generally remaining. In such cases it is wonderful how easily movements may be excited in the palsied leg—very rarely in the arm—by the application of stimuli to the sole of the foot, or elsewhere with less facility. The patient, who acknowledges his utter inability to move even one of his toes, is astonished at the rapidity and extent to which the whole lower extremity may be moved by touching the sole of the foot, even with a feather. It is proper to add that there is much variety as regards the extent to which these actions take place in hemiplegic cases, owing to causes not yet fully understood; still they do occur in a large proportion of instances, and in the most marked way. Their development is frequently in the inverse proportion of the withdrawal of the power of the will. When the paralysis to volition is only imperfect, the effect of stimuli in exciting motions is less obvious, because of the restraining power of the will.

The cases of anencephalic fœtuses may be properly referred to as affording instances of similar movements. In these beings we have no movements which can be supposed to originate in any effort of the will, nor is there any proof of the existence of sensibility. Movements, however, of definite kind do occur under the influence of a stimulus applied to the surface.

Actions of the same kind, i. e., provoked by stimuli applied to some surface to which nerves are distributed, will continue to be manifested in animals after decapitation, not only in the trunk and extremities, but also in those segments of the former with which a portion of the spinal cord remains connected. If the body of a snake or an eel be divided into several segments, each one will exhibit movements for some time upon the application of a stimulus. The same thing may be observed in frogs, salamanders, turtles, and other cold-blooded creatures. It may be shown in a remarkable manner in the male frog in the early spring, during the copulating season. At this period an excessive development of the papillary texture of the integuments covering the thumbs takes place; and this seems to be connected with the tendency which the male frog exhibits during this period of sexual excitement to lay hold on any thing that is brought within the embrace of his anterior extremities and in contact with the enlarged thumbs. If the animal be made to lay hold firmly of any object, two fingers of the observer, for instance, the head and the posterior half of the trunk may be removed, and yet the anterior extremities will maintain their grasp with as much firmness as if the animal were un mutilated. And when the frog is in full vigour, they will

the left side.* A longitudinal section of the cord along the median line in frogs does not cause paralysis; it gives rise, however, to a temporary disturbance of the functions of the cord which soon subsides.†

Continuity of the spinal cord and encephalon is then the condition necessary to establish the control of the former organ over the *voluntary* movements and *sensations* of the trunk. The disunion of the cord or any portion of it from the encephalon dissociates the cord or the separated segment of it from all participation in mental nervous actions. So long as the cord is united with the brain, it takes a certain share in mental nervous actions, in acts of sensation and volition; this, however, it loses when disease or accident separates the one from the other.

It is plain, then, that the spinal cord, although apart from the encephalon it takes no share in sensations and voluntary actions, (for then, indeed, these phenomena cannot take place as far as regards the trunk and extremities,) while united with the encephalon participates fully in sensori-volitional actions, and its integrity is quite necessary to the perfection of those actions.

I repeat that we are not justified in supposing that the mind localises itself exclusively in one or all of the gangliform bodies, the assemblage of which constitutes the encephalon; but this we may assert, with perfect justice, that when the cord has been separated from the encephalon, the mind appears as it were to cling to the latter organ, and to lose all its connection with the former.

Does then the cord, under these circumstances, lose all its power? Does it, when separated from the encephalon, shew no indication of acting as a nervous centre? Undoubtedly it does show abundant indications. A series of actions, which had attracted the notice of several physiologists, are still capable of being developed through the instrumentality of the whole cord or of any portion of it, the nerves of which may remain uninjured both as to their central and peripheral connections.

Phenomena of this nature may be produced in all vertebrate animals. They are, however, especially marked in the cold-blooded classes, in consequence of the more enduring character of the nervous force in those creatures than in the warm-blooded. Hence frogs, salamanders, snakes, turtles, fishes, have been generally selected by physiologists for exhibiting these phenomena. In the young of warm-blooded animals they are more manifest than in adults of the same class.

If a frog be pithed by dividing the line of junction of the medulla oblongata with the spinal cord, the following effects may be observed. After the first disturbance, general convulsions, &c., consequent upon the division of the cord, the animal, if placed on a table, will assume his ordinary position of rest. In some cases, however, frequent combined movements, much resembling acts of volition, will

take place for a longer or shorter time after the operation. When all such disturbance has ceased the animal remains perfectly still and as if in repose, nor does it exhibit the slightest appearance or give the least expression of pain or suffering. It is quite unable to produce any spontaneous or voluntary movement of parts supplied with nerves from below the section, that is, of the trunk or extremities. However one may try to frighten it, it remains in the same place and posture. The only appearance of voluntary motion is the winking of the eyelids, which, however, probably is not excited by the will. If, now, a toe be pinched, instantly the limb is drawn up, or the animal seems to push away the irritating agent, and then draws up the leg again into its old position. Sometimes a stimulus of this kind excites both legs, and causes them to be thrown violently backwards. A similar movement almost constantly follows stimulation of the anus. If the skin be pinched at any part, some neighbouring muscle or muscles will be thrown into action. Irritation of the anterior extremities will occasion movements of them; but it is worthy of note that these movements are seldom so energetic as those of the posterior extremities.

We may remark here, that phenomena of this kind are not confined to the trunk and extremities, which are supplied only by spinal nerves. The head and face, with which the encephalon remains in connection, exhibit similar actions. The slightest touch to the margin of either eyelid or to the surface of the conjunctiva causes instantaneous winking; the attempt to depress the lower jaw for the purpose of opening the mouth is resisted; and the act of deglutition is provoked by applying a mechanical stimulus to the back of the throat.*

Actions similar to those which take place in the decapitated frog, occur in the human subject when the spinal cord has been separated from its encephalic connections by disease or accident. In such cases it is found that although the will cannot move the paralysed parts, the lower extremities for instance, movements do occur

* Sir Gilbert Blane, in his admirable Croonian Lecture on muscular motion, having drawn the distinction between instinctive and voluntary actions, makes the following remarks. "There are facts which show that instinctive actions, even in animals endowed with brain and nerves, do not depend on sensation. I took a live kitten, a few days old, and divided the spinal marrow by cutting it across at the neck. The hind paws being then irritated by pricking them, and by touching them with a hot wire, the muscles belonging to the posterior extremities were thrown into contraction, so as to produce the motion of shrinking from the injury. The same effects were observed in another kitten after the head was entirely separated from the body." And again, "In an acephalous monster, the like phenomena were observable. It moved up its knees, when the soles of its feet were tickled; it performed the act of suction; passed urine and fæces; and swallowed food." * * * "The like takes place with regard to insects; for, after the head of a bee is separated from the body, the hinder part will sting, upon the application of such a stimulus as would excite the same action in the animal in a perfect state."

* Med. Chir. Trans. vol. i. p. 200.

† See Flourens' Experiments, Syst. Nerveux.

in them of which the individual is wholly unconscious, and which he is utterly unable to prevent. Sometimes these take place seemingly quite spontaneously; at other times they are excited by the application of a stimulus to some surface supplied by spinal nerves. The movements of this kind, which seem to occur spontaneously, exhibit so close a resemblance to voluntary actions as to render it impossible to distinguish them, did not the consciousness of the patient in some cases assure him of the inactive state of his will in reference to them.

The comparison of the phenomena which occur in pithed or decapitated animals with the actions developed in man under these morbid states, affords most conclusive evidence as to the important question of the connection of these phenomena with the mind. In a pithed or decapitated animal we can only judge of the exercise of volition or the perception of sensitive impressions by external signs. And so far as these go we are justified in maintaining that, while the mental principle is unextinguished, it nevertheless has lost its influence over or connection with that portion of the cerebro-spinal axis which is separated from the encephalon. But in the human subject we have the evidence of the individual himself, who, from his own consciousness, avows the integrity of his will and perception, but admits their dissociation from those parts of the body whose nerves are implanted in the severed portion of the cord.

Let us refer to such a case as has been already quoted. A man has fallen from a height and fractured or displaced one or more of his cervical vertebræ; we find the patient presenting the following phenomena. His trunk and extremities appear as if dead, excepting the movements of the diaphragm, while the head lives. In full possession of his mental faculties and powers, he is, nevertheless, unconscious, save from the exercise of his sight, of any changes which may affect the parts below his head, nor is the utmost effort of his will sufficient to produce a movement of any, even the smallest, of these parts. If the stunning effect of the accident have passed off, tickling the soles of the feet will be found to cause movements, of which, as well as of the application of the stimulus, the patient is *unconscious*; the introduction of a catheter into the urethra, which the patient *does not feel*, excites the penis to erection. The limbs may be irritated in various ways, but without exciting any effect which the patient can perceive, excepting movements, and these he is aware of only from his happening to see them. It is important to notice that, in cases of this kind, movements are difficult of excitation in the upper extremities, while they are aroused with great facility in the lower.

In these cases movements may be excited in both lower extremities by passing a catheter into the bladder. Sometimes internal changes, the precise nature of which we cannot always appreciate, but which are often the result of the irritation of flatus or other matters in the intestinal canal, excite movements in the lower or even in the upper extremities, and the patient is disturbed by cramps and spasmodic

movements, more or less violent, at night. It is very remarkable, that while a patient is almost wholly insensible to external stimuli, he feels and even suffers pain from cramps of this kind.

In the hemiplegic paralysis which results from an apoplectic clot, or some other lesion affecting one side of the brain, when the paralysis is complete, the influence of the will over the paralysed side is altogether cut off, sensibility, however, generally remaining. In such cases it is wonderful how easily movements may be excited in the palsied leg—very rarely in the arm—by the application of stimuli to the sole of the foot, or elsewhere with less facility. The patient, who acknowledges his utter inability to move even one of his toes, is astonished at the rapidity and extent to which the whole lower extremity may be moved by touching the sole of the foot, even with a feather. It is proper to add that there is much variety as regards the extent to which these actions take place in hemiplegic cases, owing to causes not yet fully understood; still they do occur in a large proportion of instances, and in the most marked way. Their development is frequently in the inverse proportion of the withdrawal of the power of the will. When the paralysis to volition is only imperfect, the effect of stimuli in exciting motions is less obvious, because of the restraining power of the will.

The cases of anencephalic fetuses may be properly referred to as affording instances of similar movements. In these beings we have no movements which can be supposed to originate in any effort of the will, nor is there any proof of the existence of sensibility. Movements, however, of definite kind do occur under the influence of a stimulus applied to the surface.

Actions of the same kind, i. e., provoked by stimuli applied to some surface to which nerves are distributed, will continue to be manifested in animals after decapitation, not only in the trunk and extremities, but also in those segments of the former with which a portion of the spinal cord remains connected. If the body of a snake or an eel be divided into several segments, each one will exhibit movements for some time upon the application of a stimulus. The same thing may be observed in frogs, salamanders, turtles, and other cold-blooded creatures. It may be shown in a remarkable manner in the male frog in the early spring, during the copulating season. At this period an excessive development of the papillary texture of the integuments covering the thumbs takes place; and this seems to be connected with the tendency which the male frog exhibits during this period of sexual excitement to lay hold on any thing that is brought within the embrace of his anterior extremities and in contact with the enlarged thumbs. If the animal be made to lay hold firmly of any object, two fingers of the observer, for instance, the head and the posterior half of the trunk may be removed, and yet the anterior extremities will maintain their grasp with as much firmness as if the animal were un mutilated. And when the frog is in full vigour, they will

continue their hold for as long as a quarter of an hour or twenty minutes after the removal of the head and the posterior segment of the body. But let the portion of the cord which is connected with the anterior extremities be destroyed, and all such power of movement becomes completely annihilated.

In birds and mammalia phenomena of this kind are less conspicuous than in the cold-blooded animals, because in them the nervous power becomes extinct so speedily after any mutilation of the body. The power itself is no doubt more energetic, as the muscular power is, but it is less lasting.

In the articulate classes movements of precisely the same nature may be observed. The common earthworm may be divided into several pieces, and each piece will continue to writhe so long as the irritation produced by the subdivision remains, and after that has ceased, movements may be excited in any segment by stimulating its surface: the same phenomena are observable in leeches and various insects. These actions are exactly analogous to those in the segments of the divided body of a vertebrate animal. Each portion of the articulate creature has in its proper ganglion the analogue of the piece of the spinal cord remaining with the segment of the vertebrate animal. These phenomena of function, conjoined with certain anatomical resemblances, make it quite certain that the abdominal ganglionic chain of the articulates is analogous, not, as formerly supposed, to the sympathetic system, but to the cerebro-spinal centres of Vertebrata. In both the Vertebrata and the Invertebrate Articulates each segment of the body is provided with its proper ganglionic centre, which is to a certain extent independent of the rest. In the latter, the centres of the segments remain distinct, although connected by fibres which pass from one to the other; but in the former they are as it were fused together at their extremities, and from that fusion results the single cylindrical nervous centre which we call *the spinal cord*.

An experiment, to which attention has been directed by Flourens, illustrates very well the difference in the character of the actions of two portions of the spinal cord, according as the brain is connected with or dissociated from it. The spinal cord of an animal is divided about its middle; when the anterior segment (that which still retains its connection with the brain) is irritated, not only are movements of the anterior extremities produced, but the animal evinces unequivocal signs of pain; when, however, the posterior extremity is irritated, the animal seems not only insensible to pain, but unconscious even of the movements that have been excited in the posterior extremities. If a frog be divided in the back into two segments, the anterior portion crawls about, exhibiting all the indications of sensation and volition; the posterior segment remains quite motionless unless some stimulus be applied to it, when movements more or less active may be excited.

Nothing can be more conclusive than such an experiment, in illustration of the fact that connection with the encephalon is necessary to

sensation; and that movements, not only without volition, but also without consciousness, may be excited by stimulating the segments separated from it. But there is nothing in this experiment to justify the conclusion that during the entire and un mutilated state of the cerebro-spinal axis the mind has no connection with the spinal cord. The experiment only shows that when a portion of that great centre has been removed, the mind retains its connection with the higher or encephalic portion, deserting that which is merely spinal.

Direct irritation of the spinal cord is capable of exciting these movements as much as when the stimulus is applied to the skin.

All these motions cease when the spinal cord is removed; no movement of any kind, voluntary or involuntary, can then be excited, except by directly stimulating the muscles, or the nerves which supply them, and such movements want the combined and harmonious character which belongs to those which are excited through the nervous centre.

Division of all the roots of the nerves at their emergence from the spinal cord annihilates these movements as completely as the removal of the cord itself. Under such circumstances no motion can be excited by stimulation of the surface of the body, nor by irritating the cord itself; and this fact may be regarded as an unequivocal proof that the nerves, in ordinary actions, are propagators of the change produced by impressions to or from the centres; and that in the physical nervous actions the stimulus acts, not from one nerve to another directly, but through the afferent nerve upon the centre, which in its turn excites the motor nerve.

All these facts in the physiological history of the spinal cord lead unequivocally to the following conclusions respecting its office:— 1. that the spinal cord (that term being used in its simple anatomical sense, *the intra-spinal mass*) in union with the brain is the instrument of sensation and voluntary motion to the trunk and extremities; 2. that the spinal cord may be the medium for the excitation of movements *independently* of volition or sensation in parts supplied by spinal nerves, either by direct irritation of its substance, or by the influence of a stimulus conveyed to it from some surface of the trunk or extremities by its nerves distributed upon that surface.

Of the physical nervous actions of the cord.— We must pause here to make a more extended reference to those actions of the spinal cord which are capable of being excited by peripheral stimulation, and which are independent of mental change. There is no point in the physiology of the nervous system of more interest or importance than this, inasmuch as these actions are not limited to the cord, but take place in other portions of the cerebro-spinal centre, in which nerves are implanted, and even in ganglions from which nerves take their rise.

The existence of a class of actions like these has long been known to physicians and physiologists. By the name of *sympathetic actions* they excited great interest as to the mode of

their production. And anatomists explored the frequent and often intricate anastomoses of nerves in their peripheral distribution with the hope of finding in them some clue to the explanation of these phenomena.

To these actions I prefer to apply the name *physical nervous actions* to mark their peculiar characteristic, namely, *independence of the mind*, and to denote that they are the result of a physical change produced by a physical impression, and therefore, in their causation, wholly independent of mental influence. The term *excito-motory* has been applied to them by Dr. Hall. To this term, however, there appear to me to be several serious objections. First, this term implies that the excitation of motion takes place in no other way than by a mechanism similar to that by which these movements are produced. Secondly, it denotes the existence of a peculiar excito-motory power different from the ordinary *vis nervosa*, the agent in all nervous phenomena. As if this force were not capable of being roused into action at one time by a mental stimulus, at another by a physical stimulus, or at a third by a mental and physical stimulus united. Persons get into the habit of using the terms "excito-motory power," "excito-motory phenomena," as if this power, or these phenomena were something quite peculiar, quite *sui generis*, and limited to a special part of the nervous system, losing sight of the real truth that they differ from voluntary actions only in their mode of excitation, that is, by a physical and not by a mental stimulus. Thirdly, it limits the reflecting power of the nervous centres (*i. e.* the propagation of the change induced by the application of a physical stimulus at the periphery) to reflection *from* sensitive to *motor* nerves. Now there are many facts which shew that reflection may take place from a sensitive to another sensitive nerve, and many of the phenomena of sympathy admit of no other explanation excepting on this principle. And I am by no means prepared to affirm that reflection may not take place from motor to sensitive nerves, or even from motor to other motor nerves, under circumstances of an exalted polarity of the nerves and the centres. Fourthly, some of these so-called *excito-motory* phenomena have nothing to do with muscular action. Take, for example, erection of the penis: it has not been shown that muscular fibres take any part in the production of this phenomenon, or that the stimulus which gives rise to it does more than create a change in the vessels of the penis, which seems due to muscular relaxation rather than to muscular contraction. The excitation of a gland to secrete by stimulating some surface connected with it, as the mammary gland by stimulating the nipple, is no doubt a phenomenon of the same kind, but not one in which muscular fibres are excited to contract.

The term "reflex actions," in accordance with Prochaska's view of the reflecting power of the nervous centre, is objectionable inasmuch as it fails to denote fully the physical character of the phenomena; and, moreover, it is applicable only to a class of the actions in question, those, namely, in which the excitation

of a motor or sensitive nerve takes place through the primary excitation of another motor or sensitive nerve. Either this term, however, or that which I have proposed, may be used without inconvenience to science because they involve no particular theory, and yet sufficiently express some leading feature of the phenomena, *reflection* at the centre, in the one case—a physical exciting cause of a phenomenon purely physical in the other. It may be objected to the term "physical nervous action" that the actions produced by the mental stimulus are equally physical in their intrinsic nature. When, however, the term is habitually used in contrast with "mental nervous action," all practical difficulty or objection vanishes—both are physical phenomena,—but one is physical in its essence and also in its exciting cause; the other is physical in its essence, but mental in its cause. The term *physical nervous actions* may be regarded as a generic expression for all those nervous phenomena in which the mind takes no necessary share; *reflex actions* being a specific term denoting those physical nervous actions of which reflexion at the centre is a prominent character. In this sense I shall use these terms respectively.

By none were these phenomena more carefully studied than by Whytt and Prochaska. In 1764 Whytt published his "Observations on Nervous Diseases," a work full of the most valuable clinical and practical information. In the first chapter of this book, "on the structure, use, and sympathy of the nerves," he enumerates various instances of sympathetic actions, and discusses the mode of their production. To show that he regarded in this light the actions which we are now considering, I shall quote one which he adduces as an example. He says: "When the hinder toes of a frog are wounded, immediately after cutting off its head, there is either no motion at all excited in the muscles of the legs, or a very inconsiderable one. But if the toes of this animal be pinched, or wounded with a penknife, ten or fifteen minutes after decollation, the muscles not only of the legs and thighs but also of the trunk of the body are, for the most part, strongly convulsed, and the frog sometimes moves from one place to another."^{*}

Whytt's most important work, in which this subject has been most fully discussed, is the essay on the vital and other involuntary motions of animals, published ten years earlier, in 1754. This physiologist was deeply imbued with a righteous dread of materialism, which led him to such extraordinary lengths in spiritualism, that he ascribed every action and movement of the body to "the immediate energy of the mind or sentient principle;" while he completely repudiated all notion of any mechanical disposition in the intimate nature of these phenomena. As an example of his mode of reasoning upon this subject, and as further evidence that he was well acquainted with the class of actions which we now call reflex or physical, the following passage from the eleventh section of this essay may be cited:—

* Whytt's Works, 4to. edit. p. 501.

"The objection against the mind's producing the vital motions, drawn from their being involuntary, must appear extremely weak; since there are a variety of motions equally independent upon our will, which yet are certainly owing to the mind. Thus, as had been already observed, the contraction of the pupil from light, and the motions of the body from tickling, or the apprehension of it, undoubtedly flow from the mind, notwithstanding their being involuntary. The shutting of the eyelids, when a blow is aimed at the eye, is another instance of a motion performed by the mind in spite of the will; for, as the threatened blow does not, by any corporeal contact, affect the orbicular muscle of the palpebræ, its contraction must necessarily be deduced from the mind, moved to perform this action from the apprehension of something ready to hurt the eye: and if there are some who, by an effort of the will, can restrain this motion of their eyelids, yet this does not proceed so much from the mind's making no attempt, in consequence of the apprehended danger, to close the palpebræ, as from the superior eyelid's being kept up by a strong voluntary contraction of its levator muscle. We cannot, by an effort of the will, either command or restrain the erection of the penis; yet it is evidently owing to the mind: for sudden fear, or anything which fixes our attention strongly and all at once, makes this member quickly subside, though it were ever so fully erected. The titillation, therefore, of the *vesiculæ seminales* by the semen, lascivious thoughts, and other causes, only produce the erection of the penis, as they necessarily excite the mind to determine the blood in greater quantity into its cells."

Whytt's view is best explained in the following passage of the same work:—"Upon the whole, there seems to be in man one sentient and intelligent PRINCIPLE, which is equally the source of life, sense, and motion, as of reason; and which, from the law of its union with the body, exerts more or less of its power and influence as the different circumstances of the several organs actuated by it may require. That this principle operates upon the body, by the intervention of something in the brain or nerves, is, I think, likewise probable; though, as to its particular nature, I presume not to allow myself in any uncertain conjectures; but, perhaps, by means of this connecting medium, the various impressions, made on the several parts of the body, either by internal or external causes, are transmitted to and perceived by the mind; in consequence of which it may determine the nervous influence variously into different organs, and so become the cause of all the vital and involuntary motions as well as of the animal and voluntary. It seems to act necessarily and as a sentient principle only, when its power is excited in causing the former; but in producing the latter it acts freely, and both as a sentient and rational agent."*

* Op. cit., 8vo ed., p. 290.

The third fasciculus of the *Annotationes Academicæ* of Geo. Prochaska was published in 1784. It contains the *Essay on the Functions of the Nervous System*. It is impossible to speak too highly of this profound and accurate dissertation. Although short, it comprehends all the leading facts connected with the working of the nervous system, and affords abundant indications that its author had thought deeply on the subject. I know of no essay, of more modern date, which exhibits the same profound knowledge of nervous phenomena, and which is equally comprehensive. How it came to be so long neglected can only be explained by the too general incompetency of physiologists to appreciate his views. Yet his language is remarkably clear and precise. No one can have done more ample justice to his predecessors and contemporaries. His literary research was extensive and accurate, and his historical summary is most interesting and instructive. The attentive perusal of this essay more frequently than once has impressed me strongly with the conviction that Prochaska was a man of the highest mental capacity and of great power of generalization, and I shall rejoice to see his work made easily accessible to all medical readers.

A brief summary of this important work will not be out of place here.

In the first chapter, the first seven sections are occupied with an historical account of the views of preceding philosophers, beginning with Aristotle and Galen. In the eighth section, he remarks, "At length we abandon the Cartesian method of philosophizing in this part of animal physics, and embrace the Newtonian, being persuaded that the slow, nay, the most uncertain road to truth is that by hypothesis and conjecture, but that by far the more certain, more excellent, and the shorter way is that, *quæ a posteriori ad causam ducit*. Newton distinguished the inscrutable cause of the physical attractions by the name 'force of attraction'; he observed its effects, arranged them, and detected the laws of motion, and thus established a useful doctrine, honourable to human genius. In this way we ought to proceed in the study of the nervous system; the cause latent in the nervous pulp, which produces certain effects, and which hitherto has not been determined, we shall call *vis nervosa*; its observed effects, which are the functions of the nervous system, we shall arrange, and expose their laws, and in this manner we shall be able to construct a true and useful doctrine, *quæ arti medicæ novam lucem et faciem elegantiorum datura est pro certo*." Haller, he admits, had previously used the term "*vis nervosa*" to express the power by which nerves cause muscles to contract, but to Unzer he assigns the credit of having thrown the greatest light upon this subject, although he states that to accommodate himself to the times in which he wrote and to make himself more generally understood, he still used the term "animal spirits," although his doctrine was quite independent of such an hypothesis.

In the second chapter Prochaska gives an

admirable summary of the leading anatomical characters of the nervous system. His succinct description of the nervous centres is excellent, and shows that he had anticipated views which long afterwards were put forward as original. Speaking of the *crura cerebri*, he describes them thus, "*duo magna crura cerebri, in quibus omnis medulla ab utroque cerebri hemispherio collecta videtur.*" The compound origin of the fifth and spinal nerves and the existence of the ganglion on one of their roots he was well acquainted with. He concludes thus, "However complex be the mechanism of the nervous system, I think it can be divided into three parts, just as the functions themselves are conveniently divisible into three classes: namely, first, the animal organs, or those associated with the faculty of thinking, these are the brain and cerebellum; secondly, the *sensorium commune*, which consists of the medulla spinalis and oblongata, not excepting also such part of the medulla of the brain as gives immediate origin to nerves; and, thirdly, the nerves properly so called, which are prolonged from the sensorium commune to the whole body."

An examination of the comparative anatomy of the nervous system next follows, affording a clear and concise exposition of the existing state of knowledge on that subject.

The question discussed in the succeeding section is, "*quid per vim nervosam intelligitur, et quæ sint generales ejus proprietates?*" and he affirms the principle of the inherence of the *vis nervosa* in the nervous structure itself, and the development of that force by changes taking place in it. Leaving it to those who devote themselves to the study of experimental physics to inquire into the nature of the nervous force, he endeavours to determine its general properties or laws before inquiring into the special functions of the nervous system.

1. The first law which he lays down is that the *vis nervosa* requires, for its action, a stimulus. Here, likewise, he repeats the assertion, that the *vis nervosa* is an innate property of the nervous medulla—"innata pulpæ medullaris proprietas. Sicut scintilla latet in chalybe ac silice, nec prius elicitur, nisi attritus mutuus chalybis, silicisque accesserit: ita vis nervosa latet, nec actiones systematis nervosi prius producit donec stimulo applicito excitatur, quo durante durat, ablato cessat agere, et redeunte iterum reddit."

2. The stimulus necessary for the development of the nervous force is twofold, *stimulus corporis* and *stimulus animæ*. The former is any body fluid or solid applied externally or internally to the nervous system. The latter is that of the mind, which, through its connection with a part of the nervous system, is capable of influencing, to a certain extent, the rest of that system and through it the body.

3. The vigour of the nervous actions bears a direct relation to that of the nervous force and to the power of the exciting stimulus. The actions of the nervous system will be greater and more vigorous in proportion as the *vis nervosa* may be more active (*mobilior*) and the stimulus more efficacious; on the other hand,

the nervous force will be more sluggish and the stimulus less effective, where the nervous actions are more languid. A less stimulus is sufficient for a more active *vis nervosa*, as the application of a stronger stimulus may compensate for a more sluggish *vis nervosa*, yet an equal effect may be produced in the nervous actions. The nervous force, however, is not equally susceptible to every kind of stimulus; sometimes it obeys one more than another, although both may appear equally powerful: nay, sometimes it experiences a more powerful effect from the stimulus which may seem the mildest. According to Haller, the heart and intestines are more powerfully stimulated to contract by air blown into them than by water or by any poison; on the contrary, a drop of water let fall into the trachea excites violent cough, whereas air passes through it in breathing as if unfelt by it.

4. The nervous force is augmented by various circumstances. Among these he enumerates *age*—at an early age the *vis nervosa* being greater than at a more advanced period of life—*climate*, and *disease*.

5. On the other hand, the *vis nervosa* may be depressed or diminished by all causes which depress the powers of life, by the direct application of opium and other sedatives to the nervous matter.

6. "*Vis nervosa est divisibilis et absque cerebro in nervis subsistit.*" In illustration of this law he adduces the instances of nerves remaining excitable after they have been separated from the cord or from the brain; also the excitability of paralytic limbs by the electrical stimulus. And, he states, the *vis nervosa* not only remains for a long time in the spinal cord and nerves which have been separated from the brain, but even in nerves which never had any connection with the brain, as is shown by the *acephalous fœtus*, which, without a brain, and by the sole force of the nerves and medulla spinalis, if this be not deficient, lives the full time in the uterus of the mother, is nourished, grows, and, when it comes into the light, shows often no obscure signs of life. To this law he attributes the persistence of the rhythmical action of the heart after the decapitation of animals.

7. *Idiosyncrasy* is a peculiar affection of the nervous force. Among the examples of *idiosyncrasy* he enumerates, fainting at the sight of blood, the uneasiness and even terror produced in some persons by the exhalations from a cat, which may be in the same room, although unseen; fainting from the perception of particular odours.

In his third chapter Prochaska proceeds to examine the functions of nerves. He describes the mode of action of nerves, their power of receiving impressions with great facility, and of propagating them with the greatest velocity either to the centre or to the periphery. This power he calls the *vis nervosa* of nerves, which also may be called the sensibility or mobility of nerves, and to which Unzer had given the name *corporeal sense without concomitant perception*. And he shows that this power is in-

herent in the medullary pulp of the nerves, and is not simply derived from the brain, but that a certain cohesion of the medullary pulp of the nerves is necessary for the development of the *vis nervosa*, because if by compressing a nerve strongly we injure its medulla, so as to disturb the connection of its particles, the nervous force ceases in that part of the compressed nerve, nor are impressions propagated further by it, nor if that part of the nerve be stimulated can sensation or motion be produced.

Although, he says, a nerve is necessary for sense and motion, it is not it alone which feels or moves; it feels by the brain, which, when an impression made upon a nerve is conveyed to it, represents that impression to the mind; and a nerve causes motion by the muscle when an impression, communicated to the nerve, descends to the muscle and excites it to motion. He concludes thus: "Par itaque nervi, in sensu et motu ciendo, est officium, nimirum impressionem stimulum recipere, et per totam suam longitudinem celerrimè propagare, quæ dum ad cerebrum pervenit, sensus perceptionem causat, dum vero ad muscolum, ejus contractionem ciat."

Prochaska recognises the influence of the nerves upon the bloodvessels, and ascribes various familiar phenomena to this influence, either excited by direct contact of the nerves of the part, or, if the nerves be indirectly affected through the brain (*si isti nervi non immediate, sed mediante cerebro afficiantur*). Thus he refers to redness of the skin of the face occasioned by exposure to a cold wind, redness of the conjunctiva caused by some irritant, erection of the nipple of the breast by titillation, erection of the penis by similar means or through mental emotion, blushing, &c. He puts forward the notion that the augmentation of the nervous force in any part causes an attraction of fluids to that part, as sealing-wax, when rubbed with cloth, becomes electrical and attracts various small particles. To a similar attraction of fluids he ascribes muscular action and many other phenomena, such as the menstrual flux, the action of the iris, &c. He also discusses the question whether the nerves have any power over the secretions, whether they contribute in any way to the production of animal heat, and how far they are necessary to nutrition.

The fourth chapter describes the *sensorium commune*, its functions, and its seat. Here it is that Prochaska has put forward his views respecting reflex actions. External impressions, which are made upon sensitive nerves, are propagated with great velocity throughout their entire length to their origin, where, (to use his own phrase,) when they have arrived, they are reflected according to a certain law, and pass into certain and responding (*certos ac respondentes*) motor nerves, by which again being very quickly propagated to muscles they excite certain and determinate movements. This place, he says, in which, as in a centre, nerves of sense and of motion meet and communicate, and in which "the impressions of

sensitive nerves are reflected into motor nerves," is called, by a term already received by most physiologists, "*the sensorium commune*." Having referred to the various views of different physiologists as to the seat of the *sensorium commune*, he expresses his own opinion, that the *sensorium commune*, properly so called, extends throughout the medulla oblongata, the *crura cerebri* and *cerebelli*, a part of the optic thalami, and the entire spinal cord,—in a word, as far as the origins of the nerves extend. That the *sensorium commune* extends to the spinal cord is shown by those movements which continue in animals after decapitation, which cannot be effected without the cooperation of nerves which arise from the spinal cord; for if a decapitated frog be pricked, not only does it retract the stimulated part, but also it creeps, and leaps, which could not be done without the consentaneous action (*absque consensu*) of sensitive and motor nerves, the seat of which consentaneous action must be in the medulla spinalis, *superstite sensorii communis parte*.

That Prochaska viewed these acts as purely physical in their nature, is apparent from his statement, that they take place under peculiar laws, *written, as it were, by nature on the medullary pulp of the sensorium*. The general law, however, whereby the *sensorium commune* reflects sensorial into motor impressions (*impressiones sensorias in motorias reflectit*) is our preservation; so that certain motor impressions should succeed to such external impressions as might be injurious to our bodies. In illustration he refers to certain acts of this class, such as, irritation of the mucous membrane of the nose creating a violent act of expiration (sneezing) to expel the offending material from the nostril; the spasmodic closure of the glottis when a particle of food or a drop of fluid touches it, or the act of winking excited by the finger being brought close to the eye.

Prochaska points out that these reflex actions may take place with or without consciousness (*vel animâ insciâ, vel vero animâ consciâ*). In proof of this occurrence without consciousness he refers to certain acts which are observed in apoplectic patients, to the convulsions of epilepsy, and to certain actions in profound sleep; all those actions which occur in decapitated animals he refers to this class, and regards them as being regulated by the remaining portion of the *sensorium commune* which is seated in the spinal cord. "*Omnes istæ actiones ex organismo et phisicis legibus, sensorio communi propriis, fluunt, suntque, propterea, spontaneæ ac automaticæ*." Actions, however, which the mind directs and moderates by its control, although the *sensorium commune* may take its share in producing them, may be called *animal*, and not automatic.

The second paragraph of this chapter contains an excellent discussion of the question, how far the anastomoses of nerves contribute to their mutual action upon each other, or whether that takes place only through the *sensorium commune*. On this subject Prochaska adopts the opinions of Whytt, who regarded the nervous centre as essential to these actions, and in the

next paragraph he enquires whether nerves can establish any communication or consent with each other in their ganglia, and also discusses the use of ganglia, giving his assent, in some degree, to the doctrine which he assigns to Unzer and Winterl,* that external impressions are capable of being reflected by ganglia as they are reflected in the sensorium commune, and that ganglia are particular centres of sensorial impressions (*sensoria particularia*). He supposes that the action of the heart may be explained in this way through the impressions made by the blood upon its sensitive nerves which are reflected at the ganglia; † and he concludes by admitting it to be probable that besides the sensorium commune which resides in the medulla oblongata, the medulla spinalis, &c., there are *sensoria particularia* in ganglia and anastomoses of nerves (*concatenationibus nervorum*) in which external impressions are reflected, without their reaching the sensorium commune. ‡

In the fifth and last chapter Prochaska discusses the animal functions of the nervous system. He shows that the soul, *ens incorporæ prosapie*, uses the nervous system as an instrument, and that, in all animal functions, it is the *principium agens et determinans*. He describes the principal parts into which the animal functions can be conveniently resolved, as perception, judgment, will, to which may be added imagination and memory. For the exercise of these he lays down that the joint and harmonious action of the mind and brain is necessary, and he assigns to each of them a

* Unzer, *Gundriß eines Lehrgebäudes von der Sinnlichkeit der thierischen Körper*, 1768; also, *Erste Gründe einer Physiologie der eigentlichen thierischen Natur thierischer Körper*, 1771. Winterl, *Inflammationis nova theoria*, Viennæ, 1767. I have not had an opportunity of perusing any of the works of Unzer. They are, indeed, little known in this country, having first appeared at a time when German literature was scarcely at all cultivated here. The only English medical writer with whom I am acquainted, who has made distinct reference to Unzer from having apparently studied his works, is Sir Alexander Crichton, who seems to have formed a high estimate of Unzer's *Erste Gründe einer Physiol.* as I gather from his work on *Mental Derangement*, published in 1798. Dr. Baly, the learned translator of Muller's *Physiology*, also refers to Unzer; and I must express my obligations to an interesting article in Dr. Forbes's journal (the *British and Foreign Medical Review*) for July, 1847, which contains a good abstract of Unzer's views, with an account of his writings. From this it is plain that Unzer had very enlarged views with reference to the phenomena of the nervous system, and perfectly appreciated the distinction to be made between those actions with which the mind is concerned either as excitor or recipient, and those which in their causation and development are wholly independent of the mind, although not unperceived by it. The publication of Unzer's principal works and also of Prochaska's in an English dress would be a great boon to the student of the physiology of the nervous system, and would most legitimately come within the scope of the Sydenham Society.

† This is the doctrine in most favour at the present day.

‡ It is plain from the context that Prochaska had no idea of these *sensoria* having any connection with the mind, or with the mental power of perception.

different locality in the brain. In the last section he again defines the animal actions, and distinguishes them from those which are dependent on a physical exciting cause; and argues against the Stahlian doctrine, which placed each movement and function of the body under the control of the soul.

These doctrines are repeated and somewhat enlarged upon in a much later work by Prochaska, published at Vienna in 1810, entitled, "*Lehrsätze aus der Physiologie des Menschen*," a third and much enlarged edition of a text book for his lectures. The whole section on the nervous system will repay an attentive perusal, and especially the chapter headed "*Verrichtung des allgemeinen Sensoriums*," which contains a review of the doctrine of reflex actions. A later edition of the same work, somewhat compressed in some parts, published in 1820, contains a repetition and a distinct enunciation of the same doctrines (p. 92).*

It is not a little remarkable, and at the same time highly discreditably to physiologists, that views so comprehensive and so striking should have been suffered to fall into neglect and to become almost wholly forgotten, and that the peculiar power of nervous centres to develop motions in response to sensorial impressions, or, in Prochaska's language, "to reflect sensorial into motor impressions," should have been lost sight of. Le Gallois, indeed, had recognized this power, and Blane had evidently much insight into it; Mayo, likewise, had formed a very correct appreciation of it; as shown by his observations on the actions of the iris. But none of these physiologists were fully impressed with its immense importance. It is to Dr. Marshall Hall in this country and to Professor Müller in Germany that science is most indebted for awakening the attention of physi-

* Geo. Prochaska was born in 1749, and studied medicine at Vienna, where he was clinical assistant to the celebrated De Haen. He published an inaugural dissertation *de urinis*, but the works which first attracted notice were his *Questiones Physiologicæ*, Vienna, 1778; and his treatises *De Carne Musculari*, and *De Structura Nervorum*. In 1778 he was made professor of anatomy and of ophthalmic surgery at the University of Prague, where he formed a valuable cabinet of preparations of morbid parts. In 1791 he was translated to a similar chair in the University of Vienna, with the title of *Lehrer der höhern Anatomie, Physiologie, und Augenarzneykunde*. M. Dezeimeis, from whose *Dictionnaire Historique de la Médecine* (art. Prochaska) this account is abridged, remarks of him that "he was one of those who strove to reduce the laws of life to the general laws of nature, and to make physiology a branch of experimental physics." Prochaska died on the 17th of July, 1820. The works in which he propounded his views respecting the nervous system are, 1. *Annotation. Academic. fasc. iii.*, Prague, 1784. 2. *Lehrsätze aus der Physiol. des Menschen*, 1st ed., 1797, in 2 vol.; 2nd ed. 1802; 3rd ed. 1810. 3. *Opera minora Physiologici et Pathologici Argumenti*, p. i. et ii. 4. *Physiologie oder Lehre von der Natur des Menschen*, 1820. To these, perhaps, may be added a Latin edition of his *Physiology*, *Institutiones Physiologicæ Humanæ*, 1805-6; and *Disq. Anatom. Phys. Organismi Corporis Humani, ejusq. Processus Vitalis*, 1812; but neither of these works have I seen.

ologists to the existence of a power in the nervous centres which no doubt exercises a wide influence on the phenomena of living creatures; and yet it seems extraordinary that neither of these physiologists in their earlier writings should have made the slightest allusion to Prochaska, who had offered a more precise and more comprehensive, and, as I hope to show, a truer explanation of the phenomena than either of them.

I shall here cite various facts, in addition to those already adduced, which unequivocally demonstrate that a power exists in the cord of exciting movements in parts which receive nerves from it, by changes occurring in its substance, which may arise there from some modification of its nutrition developed in the cord itself, or be excited by a stimulus brought to act upon it by afferent or sensitive nerves.

But more than this: the cord has the power of reflecting the change wrought in it by impressions conducted to it into adjacent sensitive nerves, thus creating a large class of reflex phenomena under the name of reflex or radiating sensations.

When a stimulus is applied to the spinal cord, either directly or through the medium of afferent nerves, the actions excited by it are generally limited to those parts which derive their nerves from that segment of the cord which has received the stimulus. In some instances, however, parts supplied from other and even distant segments are thrown into action. Thus irritation of one leg may cause movements of one or both of the upper extremities; the introduction of a catheter into the urethra will sometimes give rise to forcible contractions of the muscles of the lower extremities or even of all the limbs. These effects are due, no doubt, to the extension of the stimulation in the cord beyond the point first acted upon; and they may be regarded as proofs that that peculiar state of physical change which nervous stimulation can excite in a centre may be propagated in the spinal cord upwards, downwards, or sideways, from the seat of the primary stimulation.

This fact was pointed out first, so far as I know, by Dr. M. Hall, who regards it as a property of the cord in its normal state. This, I am inclined to think, is an error; I believe it to be a property of the cord, only when its polarity is exalted. It is, however, an important property, and we shall, by-and-bye, make use of it in considering the mechanism of the various actions of nervous centres. Meantime we may obtain, from examining into the morbid states which are apt to arise in the spinal cord and in other parts of the cerebro-spinal centres, interesting confirmation of it.

A wound in the sole of the foot or ball of the thumb, or in some other situation favourable to the maintenance of prolonged irritation, is capable of exciting a particular region of the cord, from which the state of excitement spreads so as to involve not only the whole cord, but part of the medulla oblongata also; and in this state a large proportion of the motor nerves participate, so as to induce tonic contraction of the muscles they supply. This is the rationale

of the development of that fearful malady called *tetanus*. It consists not in an inflammatory condition of the cord or of its membranes, nor in congestion of them, but simply in a state of prolonged physical excitement, the natural polar force of the centre being greatly exalted and kept so by the constant irritation propagated to it by the nerves of the wounded part. Intestinal irritation is capable of producing a similar condition, which, if the irritation have not been allowed to remain too long, may be speedily removed by getting rid of the irritating cause. The following case illustrates this: an unhealthy looking girl, about fifteen years of age, was brought into King's College Hospital suffering from severe tonic spasms of the muscles of the spine and lower extremities. The spasms were so powerful as to produce successive paroxysms of opisthotonos, during which the trunk became bent like a bow, so that the patient rested on her occiput and on her heels. This state was speedily removed by the use of a large purgative clyster containing turpentine, which brought away a large number of ascarides from the rectum.

In cases of paraplegia from disease of the spinal cord, the paralysed parts are frequently troubled with cramps and startings occurring chiefly at night, and preventing sleep and occasioning great distress to the patient. These are very often traceable to intestinal disturbance, the presence of irritating matters, which, stimulating the mucous membrane, through its nerves excite the spinal cord, and thus produce these involuntary movements.

The rigid and contracted state of the muscles of paralysed limbs, which frequently accompanies red softening of the brain, arises from the propagation of the excited state of the diseased part of the brain to that portion of the spinal cord which is connected with it, and from which the nerves of the paralysed parts arise. These nerves likewise participate in the irritation of the cord, and thus keep the muscles in a state of continued active contraction. There is no organic lesion of the cord in these cases; its state of excitement is dependent on the cerebral irritation, and disappears if the latter yields to the influence of remedial measures.

To a similar extension of cerebral irritation, although of a much briefer duration, the convulsions of epilepsy may be attributed. The brain becomes the seat of irritation, and this spreads to the whole or a part of the spinal cord and to the nerves which arise from it. In many instances of epilepsy the convulsions are limited to one half of the body, and this is especially the case where a chronic lesion exists in the brain and forms a focus of irritation, which is propagated only to one half (the opposite) of the cord.

Some substances exert a peculiar influence upon the spinal cord and throw it into a state of considerable polar excitement. Strychnine is the most energetic substance of this class. If a certain quantity of this drug be injected into the blood or taken into the stomach of an animal, a state of general tetanus will quickly ensue, sensibility being either unaltered or some-

what exalted. The slightest touch upon the surface of the body, even a breath of wind blown upon it, will cause a general or partial convulsive movement. The whole extent of the spinal cord is in a state of excitement, and even the medulla oblongata may be involved in it, whence the closed jaws, the spasmodic state of the facial muscles, the difficult deglutition. When this polar excitement is raised to its highest degree, the slightest mechanical stimulus applied to any one point of the cord affects the whole organ and throws all the muscles which it supplies into spasmodic contraction, just as the least stimulus to peripheral parts has the same effect.

It is a very interesting fact, which I have frequently satisfied myself of by careful examination, that, however great the polar excitement may have been into which the cord has been thrown by strychnine, it exhibits no change of structure which can be detected by our means of observation. The nerve tubes and other elements entering into the formation of the cord have preserved their natural appearance in all the cases which I have examined.

Opium has the effect of creating a similar state of polarity in the cord. This is most conspicuous in cold-blooded animals; it produces a similar effect in the warm-blooded classes, but in a much less degree. Hence there is an objection to the use of opium in large doses in cases of tetanus; and experience has shewn the inefficacy and the injurious influence of this drug when administered in large quantities. When the cord is in this state of excitement, a stimulus applied to one part may excite a remote part of it with great facility.

The curious tendency already referred to, which the male frog has to grasp objects presented to them by his anterior extremities, is to be attributed in part to a spontaneous exaltation of the polar force of the cord which takes place at the copulating season, in the spring of the year, and which is associated with an extraordinary development of the papillary texture of the integument of the thumb.

This exaltation of the polar force of the cord, in connection with the generative function, is a point highly worthy of the attention of the physiologist as offering some explanation of the sympathy which exists between different organs, between those even which are remote from each other, during the rutting season, or during utero-gestation.

It is worthy of notice here that cold has a considerable influence in controlling this polar state of the spinal cord, and of other nervous centres likewise. Ice applied along the spine, or the cold douche, may be frequently employed with great benefit in cases of muscular disturbance dependent on this polar state of the cord. It seems to me more than doubtful that many of those drugs which have the character of possessing a sedative influence upon the nervous system can be employed for this purpose either with safety or advantage. This applies certainly to hydrocyanic acid and to opium in large doses; animals poisoned by these substances become convulsed before

death, and this denotes their tendency to exalt the polarity of the cord. Conium and belladonna, according to my experience, exercise the most beneficial influence of any of the sedative drugs, and I have found them very useful in restraining the cramps and startings in paralytic cases.

I have ascertained by several experiments that the inhalation of ether has considerable effect in controlling the natural polar state of the cord, as well as that which may be produced by strychnine. A pigeon deprived of its cerebral hemispheres lives in a state of sleep for a considerable time; it flies when thrown in the air, spreading and flapping its wings; stands when placed on its feet. A bird thus mutilated was made to inhale ether; it could not stand, and when thrown into the air it fell to the ground like a heavy log, its wings remaining applied to the sides of its body, or if the wings were drawn out as it was thrown into the air, they quickly collapsed. As soon as the effects of the ether had passed off, it stood and flew as before. I gave strychnine to a rabbit, a guinea-pig, and a dog, so as to excite the tetanoid state. Immediately the spasms showed themselves, I brought it under the influence of ether; the spasms ceased immediately, and the animal became perfectly relaxed; but as soon as the effects of the ether passed off, the spasms came on again, but were soon subdued by a fresh inhalation of ether. And thus I found that the life of an animal poisoned by strychnine could be greatly prolonged through successive inhalations of ether; for animals of the same kind, poisoned by equal doses of strychnine, but not subjected to the influence of ether, perished very rapidly.

The examples which show that the spinal cord possesses the power of reflecting sensitive impressions are chiefly derived from disease. Every practitioner is familiar with the pain in the knee which accompanies the early stages of disease of the hip joint. The patient sometimes refers his sufferings so exclusively to the former joint, that the disease of the latter may be entirely overlooked by his medical attendant. Yet the really painful part is healthy, while the hip joint is the seat of a morbid process. The pains which are felt in the thighs from the presence of a stone in the bladder, and the itching which is referred to the extremity of the prepuce from the same cause, are phenomena of the same nature. Pain in the right shoulder from irritation of the liver is a well-known sympathetic sensation: sometimes this pain extends over a very large surface.

Numerous other instances of similar sympathetic phenomena might be adduced, but the above are sufficient for our present purpose. Taking into account the well-proved fact that nerves form no real junction of their fibres in their anastomoses, and that there is no more than a simple juxta-position of the nerve-tubes in these anastomoses, it is plain that we must trace these fibres up to the nervous centres to discover any connection between the fibre first irritated and that to which pain is referred. In the case of hip-joint disease, the nerves of the

muscular coat of the bladder are the usual means by which the action of this viscus is promoted. It is possible that, as with the rectum, under peculiar circumstances the physical stimulus acting reflexly on the muscular fibres themselves may come in aid of that of volition; but such a mode of action is not the ordinary one. A line of argument similar to that which disproves the reflex nature of the action of the sphincter ani tells equally against that of the sphincter vesicæ. Were the action of this muscle reflex, it ought to remain perfect whenever a sufficiently large segment of the cord remains in connexion with the bladder. Now when the spinal cord is severed in any region so as to occasion paralysis of the lower extremities, there is almost always incontinence of urine from the removal of voluntary influence from the sphincter vesicæ: such ought not to be the case, if Dr. Hall's views were correct.

Respecting the cardia and the valvula coli, I shall only remark that the evidence of reflex action is extremely defective. The cardia, indeed, has no sphincter; it is closed by the lower circular fibres of the œsophagus, which keep that canal in a contracted state by their tone or passive contraction. The pylorus is provided with a sphincter muscle of great power, which closes that orifice by its passive contraction, and which in animals recently killed will continue to close the orifice as long as the muscle retains its tone. If an animal be killed during stomach digestion, the stomach may be removed, and yet the pylorus will retain the food in it even against gravity; the cardia, if a sufficient portion of the œsophagus be retained, will resist the escape of the food; but, from the absence of a true sphincter, to a much less degree than the pylorus. It is impossible that, under these circumstances, there could be any reflex action, as the stomach is removed from its connection with the nervous centre. The valvula coli appears to act simply on mechanical principles.

There is, I apprehend, no more evidence of the exclusively reflex nature of the acts of expulsion than of that of the acts of retention. The expulsion of the feces and that of the urine are voluntary acts, aided essentially by the contractile power of the muscular fibres of each viscus, and perhaps, under peculiar circumstances, by a physical excitant. Were this power reflex, the expulsion would be no doubt much more frequent and much less under control, and, therefore, productive of frequent serious inconvenience. The expulsion of perspiration is probably effected by the simplest mechanical means, the newly secreted fluid pushing before it that which was previously formed. The expulsion of the semen does, indeed, exhibit the characters of a true reflex act; but here how marked is the physical stimulus, and how necessary that it should reach a certain point of excitement before the action of expulsion responds to it! As to the expulsion of the fœtus in parturition, while I am willing to admit that the physical power of the cord excited by the sensitive nerves at the neck of the uterus may exercise some influence on the contrac-

tions of the uterus, it seems to me quite evident that the actions of this organ are reflex only to a very slight degree. In the first place, anatomy teaches us that the muscular parts of the uterus have a very trifling connexion with the spinal cord; the nerves distributed to it being few, and these only partially derived from the spinal cord. Secondly, parturition may take place even when the spinal cord has been diseased or divided so as to cut off its influence upon the inferior half of the body. Thirdly, it has lately been ascertained that in women under the influence of ether, the act of parturition may take place with vigour, although the nervous power have been very considerably depressed by the influence of that agent.

The immediate agent of expulsion in defecation, micturition, and parturition is the inherent contractility of the muscular coat of the proper organ. Being hollow muscles, the stimulus of distension is well adapted to excite them to contract. The will exercises considerable power in defecation and micturition, both upon the muscular fibres of the viscera themselves, and on the abdominal muscles. In parturition the voluntary contraction of these latter muscles may give some assistance, but the main force of expulsion is due to the contraction of the uterine muscular fibres. In all the three actions, however, the influence of the muscular fibres of the viscera respectively engaged may be materially promoted by the contractions of the abdominal muscles, which are partly voluntary and partly reflex, being excited by the pressure of the mass to be expelled on the sensitive nerves in the neighbourhood, which, acting on the spinal cord, stimulate the muscular nerves, and through them cause the muscles they supply to contract, in harmony with the muscular tunic of the expelling viscus, rectum, bladder, or uterus, as the case may be.

I may here remark, that whilst it is sufficiently evident that expulsion of the semen is a physical or reflex act, it cannot be admitted that erection of the penis is essentially so in its ordinary mode of production. This act is one of emotion—a simple emotion of the mind is sufficient to develop it: it may, however, be developed by the application of a stimulus to the penis or scrotum, when it clearly partakes of the character of a reflex act, although even under these circumstances it would be incorrect to say that emotion had no influence in its production. It is well known, however, that in cases where the spinal cord has been severely injured, severed indeed, by fracture and displacement of some of the vertebræ, erection of the penis may be produced, although the organ is insensible, and the influence of the mind over the lower half of the body is suspended, and that even a slight stimulus, as the friction of the bedclothes, or the introduction of a catheter, is sufficient for this purpose. This is clearly a purely reflex act, wholly independent of sensation or emotion; but it may be likewise produced or kept up by the irritated state of the cord itself. The painful erection of the penis, called *chordee*, which occurs in cases of inflammatory gonorrhœa, is partly a reflex phenom-

non, but is chiefly due to a change in the circulation of the penis, to an increased attraction of blood to the organ in virtue of the inflammatory state.

Enough has been said to shew that, to lay it down that every act of ingestion, of retention, of expulsion, and of exclusion, is a reflex act, is opposed to all that we know of the intimate nature of these actions. The power resident, not in the spinal cord only, but in every nervous centre in which nerves are implanted, whereby, to use Prochaska's words, sensory impressions may be converted into motor impulses, is no doubt of immense importance to the animal economy; but Dr. M. Hall has been evidently led, by an imperfect analysis of the functions we have been considering, to assign to this power too large an influence in them; and on the other hand, he has overlooked its obvious and important influence in other phenomena.

Dr. Marshall Hall also attributes to the spinal cord a direct action or influence which manifests itself, first, in the tone, and secondly, in the irritability of the muscular system.

I regret to be compelled to differ again from Dr. Hall with respect to this point, and to express my opinion that this dogma is inconsistent with established doctrines of physiology.

By the *tone* of the muscular system, I understand that state of passive contraction which every healthy muscle exhibits when not in active contraction. It is this state which gives the firm, resisting, resilient feel, which the physician knows to be characteristic of a healthy state of the muscle. By virtue of it a muscle can adapt itself to changes which may take place in the distance between its two points of attachment; and it is in virtue of this property that a muscle shortens itself when the stretching force of its antagonist has been removed. When the muscles of one side of the face have been paralysed for some short time, the features lose their balance, because the muscles of the sound side have contracted to within a smaller space, having lost the resistance of those of the opposite side. It is equality of tone which preserves the equilibrium between symmetrical muscles; it is tone or passive contraction which keeps hollow muscles quite closed, if they are empty, or firmly contracted on their contents, if not so, as the heart and intestine; the tone of the predominant flexor muscles keeps limbs, whilst at perfect rest, in a semi-flexed position; it is tone which keeps sphincter muscles in a closed state.

The question is, do the muscles derive their state of tone from the spinal cord, and is this property dependent on that organ?

This question is answered in the negative, if we can shew that there are good and sufficient grounds for affirming that muscles possess within themselves all the conditions necessary for the generation of their proper force. That muscles do enjoy these conditions is manifest from the following considerations: 1. their peculiar chemical composition, their main constituent being *fibrine*, a substance which, we know from the phenomena of the coagulation

of the blood, exhibits a remarkable tendency to contract; 2. their anatomical constitution; the arrangement in fibres, the intimate texture of those fibres, which in the muscles of the greatest power, the voluntary muscles, is highly complicated; 3. from the large quantity of blood sent to muscles, which are probably more freely supplied with that fluid than any other texture in the body, and which receive it in the greater quantity when that contractile power is more active; 4. from the fact pointed out by Mr. Bowman, that a single muscular fibre, entirely deprived of all nerves, may be made to contract by a slight stimulus applied to any part of it; 5. from the knowledge which we now possess that the mechanism of these actions may be seen by the microscope even in detached portions of muscular fibres; 6. from the fact that muscles dissociated from the nervous centres by the section of all the nerves distributed to them, retain their power of contraction for a very considerable period, long after the nerves which sink into them have lost their excitability.

All these points afford the highest degree of probability that there is no direct dependence of muscle upon the nervous centres for the development of its proper force; and that this force is the result of the nutrient actions of muscle. The only way in which the nervous system can be said to have an influence upon the muscular force is by promoting the actions of the muscles, and thereby their nutrition. If a muscle have its nerves divided, and be left to itself, its nutrition fails after a certain period, and its contractility with it; but if it be exercised daily by galvanic stimulation, its nutrition remains unimpaired, and its contractility likewise.

The tone of a muscle is nothing but the effect of the continuous development of the muscular force resulting from the natural changes in the muscle; it is this state of tension which denotes that these changes are actively proceeding, and that a uniform degree of attraction is being exerted between all the parts of the muscular fibre, in a degree proportionate to their masses, and that by this the muscles are maintained in a uniform state of tension so long as they are undisturbed by stimuli conveyed to them through the nervous system, or from some other source.

It seems, therefore, as reasonable as any proposition in physiology, to affirm that the passive contraction or tone of muscles is due to a property inherent in the muscular tissue itself, and dependent solely on its proper nutrition, and that it is not derived from any other tissue. And if this be true, it is clear that the spinal cord cannot be the source of the tone of the muscular system.

This statement is confirmed by the result of the experiment of removing the whole spinal cord in frogs or other animals. When this has been done, the limbs of the animal fall quite flaccid, the muscles being no longer capable of preserving that degree of *active* contraction which is necessary to maintain attitude. A decapitated frog will continue in the sitting

posture through the influence of the spinal cord, but, immediately this organ has been removed, the limbs fall apart from the loss of the controlling and co-ordinating influence of the nervous centres. And careful examination of the muscles in such a case as this will show that the molecular phenomena which characterise passive contraction continue in the muscular fibres. The state of *rigor mortis*, which is analogous to that of tone, comes on just as readily in animals which have been deprived of the brain and spinal cord, as in those in which these centres have been undisturbed before death. In short, healthy nutrition supplies all the conditions necessary for the maintenance of tone or passive contraction; nor is the spinal cord (although itself healthy) able to preserve the tense condition of the muscles, if they are not well nourished.

These remarks apply equally to Dr. Hall's doctrine, that the spinal cord is a direct source of irritability to the muscular system. The same arguments which prove that tone is not derived from it are of equal weight with reference to irritability.

It cannot be admitted as an argument in favour of the view which derives muscular irritability from the spinal cord, that muscles lose their firmness and waste, when they have been for some time separated from their proper nervous connections. They suffer, in this way, merely for want of a proper amount of exercise, which they cannot obtain in consequence of the influence of the will being cut off from the limb. If, however, the paralysed limb be exercised artificially, as by the galvanic current, their nutrition and their plumpness may be preserved. For this important observation we are indebted to Dr. John Reid, who likewise called attention to the confirmatory fact, that, in those palsies with which there is combined more or less of irritation of the nervous centre, the muscles do not suffer so much in their nutrition, in consequence of the exercise they undergo in the startings so frequently excited in them by the central irritation. This is not infrequently seen in cases of paraplegia from irritant disease of the spinal cord.

The supposition that the spinal cord might be the source of irritability to the muscles led Dr. Hall to the very extraordinary inference, that in hemiplegic paralysis, in which the influence of the brain is cut off from certain muscles, while that of the cord remained, *the irritability of those muscles becomes augmented*. He arrives at this conclusion by the following line of argument: assuming the cord to be the source of the irritability of the muscles, the brain may then evidently be looked upon as the exhaustor of that irritability in the voluntary actions; if, then, the influence of the brain be cut off, it naturally follows that, as the great agent of exhaustion has lost its power, the irritability, which is ever, as it were, flowing from the cord, will accumulate in the muscles. From numerous experiments I am enabled to state that in nearly all the cases of hemiplegic paralysis from cerebral lesion there is no evidence of any augmentation of the

irritability of the muscles of the palsied limbs. If the readiness with which they will respond to the galvanic stimulus be taken as a test, it may on the other hand be stated very confidently that there is evidence of the *diminution* of the irritability of the paralysed muscles, for in nearly all these cases the same current being passed through both sound and palsied limbs at the same time, the latter have contracted either not at all or with very little power as compared with the healthy limbs.

But there are exceptions to this: in some cases (and only in those in which there is more or less rigidity of the paralysed muscles) these muscles respond to the galvanic stimulus with more force and readiness than the sound ones. In these cases the palsied muscles are kept in a state of excitement by some irritant disease within the cranium, and this constant condition of more or less active contraction augments the nutrition, and therefore the irritability of the muscles.

It seems, however, most probable that in all the cases of paralysis, the excitability of the muscles to the galvanic stimulus is dependent not so much upon any change in the condition of the muscles themselves as upon the state of the nerves. If the nervous force in the nerves on the palsied side be depressed, the galvanic stimulus will produce little or no effect upon the muscles of that side, whilst those of the other side will be distinctly excited: but should the nerves participate in any excitement propagated to them from disease within the cranium, as in red softening, or an irritating tumor, or a contracting cyst, they will then respond to the galvanic current more readily than those of the opposite side.*

I have thus endeavoured to show that the spinal cord is a centre of nervous actions, *mental* and *physical*, to all parts which derive nerves from it, the mental actions, however, requiring its association with the brain. Whatever physical nervous actions occur in parts whose nerves are spinal, must be referred to *the cord alone*; and whatever mental nervous actions occur through the agency of spinal nerves must be referred to *the cord in conjunction with the brain*.

Of the office of the columns of the cord.—I shall now inquire whether the parts into which the anatomist can divide the spinal cord have special functions. These parts are, on each side of the median plane, an antero-lateral column and a posterior column. It has been a very prevalent opinion that the antero-lateral column corresponds in function with the anterior roots of the spinal nerves, and that the posterior column corresponds with the posterior roots. This doctrine might have had a good foundation if it could be proved that the posterior or sensitive roots were implanted solely in the

* I have discussed this subject more at large in a paper presented to the Royal Medico-Chirurgical Society in June last, and which will appear in the forthcoming volume of its Transactions. August, 1847.

posterior, and the anterior roots solely in the anterior columns. Nothing, however, is more certain than that both roots are implanted in the antero-lateral columns, and it is extremely doubtful that the posterior roots have any connection at all with the posterior columns. Hence, as far as anatomy enables us to judge, this distinction of function between the two columns cannot be admitted. On the contrary, anatomy indicates that the antero-lateral columns are compound in function. Their connection with the corpora striata and optic thalami, and with the mesocephale through the anterior pyramids and fasciculi innominati, their reception of both the anterior and posterior roots, and their size in each region of the cord bearing a direct proportion to that of these roots, denote that these columns with the associated vesicular matter are the seat of the principal nervous actions, both mental and physical, with which the cord is concerned.

This view of the office of the antero-lateral columns is confirmed by comparative anatomy, which shows that the bulk of the organ or the variety in the size of its various parts depends mainly on these columns.

Pathological observations are also in favour of this doctrine. They distinctly denote that lesion of the antero-lateral columns impairs the sensitive as well as the motor power to an extent proportionate to the amount of lesion. It is worthy of note, however, that while a slight lesion of the cord appears sufficient to impair or destroy the motor power, it requires a considerable extent of injury or disease to impair in any very marked degree the sensitive power. Some lesions of these columns destroy the physical nervous actions of the diseased or injured part of the cord—augmenting those of the portion below the seat of lesion, doubtless by increasing its polarity; this is seen especially in cases of injury to the cord by fractures or dislocations of the spine.

Direct experiments afford no aid in determining the functions of the columns of the cord. Attempts to expose this organ either in living or recently dead animals are surrounded with difficulties, which embarrass the experimenter and weaken the force of his inferences, if, indeed, they afford any premises from which a conclusion may be drawn. The depth at which the cord is situate in most vertebrate animals, its extreme excitability, the intimate connection of its columns with one another, so that one can scarcely be irritated without the others being affected, the proximity of the roots of its nerves to each other, and the difficulty, nay the impossibility, of stimulating any portion of the cord itself without affecting either the anterior or the posterior roots, are great impediments to accurate experiments, and sufficiently explain the discrepancies which are apparent in the recorded results of experiments undertaken by various observers. Moreover, the resultant phenomena, after experiments of this kind, are extremely difficult of interpretation, especially with reference to sensation. "The gradations of sensibility," remarks Dr. Nasse, "are almost imperceptible;

the shades are so delicately and so intimately blended, that every attempt to determine the line of transition proves inadequate. There is a great deal of truth in an expression of Calmeil, that it is much easier to appreciate a hemiparalysis of motion than a hemiparalysis of sensation. If the anterior fasciculi of the cord possess sensibility but only in a slight degree, the mere opening of the spinal canal and laying bare the cord must cause such a degree of pain as would weaken or destroy the manifestations of sensibility in the anterior fasciculi. This has not been sufficiently attended to by experimenters. Again, the practice of first irritating the posterior fasciculi, and afterwards the anterior, must have had considerable effect in producing the same alteration. It is plain, that in this way the relation which the anterior fasciculi bear to sensation must be greatly obscured; yet, with the exception of some few experiments, this has been the order of proceeding generally adopted."^{*}

All the experimenters agree in attributing to the antero-lateral columns more or less power of motion, but we gain no satisfactory information from this source respecting their sensitive power, and probably for the reasons so well expressed by Nasse in the passage above quoted. But, indeed, we do not need the appeal to experiment in reference to this question, although, if a distinct and unequivocal response could be elicited by means of it, the additional evidence would be of great value.

There is great difficulty in determining precisely the functions of the posterior columns of the cord.

Both anatomy and comparative anatomy are opposed to the view which assigns them sensitive power. In the first place, as already stated, there is no evidence to show that the posterior roots of the spinal nerves are connected with them; even Sir C. Bell, who once held that these columns were sensitive because the sensitive roots were connected with them, gave up that view, having satisfied himself that no such connection existed.† Secondly, if they were sensitive, it is not unreasonable to expect that they would exhibit an obvious enlargement at the situations which correspond to the origins of the largest sensitive nerves; so little, however, is this the case, that the posterior columns exhibit little or no variation of size throughout their entire course. Thirdly, the researches of the morbid anatomist afford evidence unfavourable to the assignment of the sensitive function to these columns. Cases are on record which show that disease of the posterior columns does not necessarily destroy sensibility; that perfect and even acute sensibility is compatible with total destruction of the posterior columns in some particular region, the posterior roots remaining intact: and others

* Nasse, *Untersuchungen zur Physiologie und Pathologie*, Bonn, 1835-36. The passage is quoted from an abstract of the work published in the *Brit. and For. Med. Review*, vol. iv.

† See his paper on the relations between the nerves of motion and of sensation and the brain. *The Nervous System*, p. 234. 8vo ed., 1844.

have occurred in which sensibility has been impaired or destroyed, while the posterior columns remained perfectly healthy. In a remarkable case related by Dr. Webster, there was complete paralysis of motion in the lower extremities, but sensibility remained; yet there was total destruction of the posterior columns in the lower part of the cervical region. Dr. Webster did me the favour to allow me to examine the spinal cord in this case, and I was struck with the complete solution of continuity of the posterior columns in the region of the neck: it was impossible in this case that the nervous force could have travelled along the course of these columns, whether from above downwards, or from below upwards. Such a case as this shows distinctly that sensation may be enjoyed in the inferior extremities *independently of the posterior columns*, and if it does not prove that these columns are not the ordinary channels through which sensitive impressions are conveyed to the brain from parts supplied by spinal nerves, it at least shows that there must be some other channel besides them for the transmission of sensitive impressions.

Other cases to the same purport are on record. Mr. Stanley published an account of a case of this kind in the twenty-third volume of the *Medico-Chirurgical Transactions*. He states, "there was no discoverable impairment of sensation in any part of either limb: on scratching, pricking, and pinching the skin, nowhere was any defect of feeling acknowledged by the patient. In the upper limbs there existed no defect, either of motion or sensation." There was inability to expel the urine or retain the fæces. The report of the post-mortem appearances in this case is not quite so exact as might be desired. The posterior half of the cord and the posterior columns are spoken of as if synonymous; now it is evident that the posterior half of the cord consists of a great deal more than the posterior columns; it includes the posterior part of the antero-lateral columns. The record of the case states as follows: "The substance of the cord throughout its posterior half or column, and in its entire length, from the pons to its lower end, had undergone the following changes of colour and consistence; it was of a dark brown colour, extremely soft and tenacious. The substance of the cord through its anterior half and entire length exhibited its natural whiteness and firm consistence; and on making a longitudinal section of the cord through its centre, and in the antero-posterior direction, the boundary line between the healthy and diseased nervous matter was seen to be most exact: it was a straight and uninterrupted line from the pons to the lower end of the cord. The roots of the spinal nerves were unaltered."

Supposing that the posterior columns are the media of sensation to parts supplied by spinal nerves, we can by no means infer that the lesion in this case recorded by Mr. Stanley was sufficient to *destroy* sensation; it cannot, however, be conceded that, if this view were correct, such a lesion could exist without impairing sensation in some way or other, inas-

much as the whole of the posterior columns were involved in a notably diseased condition.

The following case is related by Cruveilhier. A young amaurotic girl, paraplegic of movement only, died from some unknown cause. The spinal cord presented on its posterior surface in its entire length a large reddish-grey (gris-rosé) column, formed by the posterior columns. All the rest of the cord was perfectly healthy.

In a case recorded by Dr. Wm. Budd it is stated that the lower extremities were quite deprived of motion, "but with sensation unaffected." The disease was the result of a severe blow on the back from the boom of a ship, which led to a curvature of the spine, formed by prominence of the dorsal vertebrae from the fourth to the ninth inclusive. After death a portion of the cord, about two inches in length, corresponding to the curvature, was found softened in the posterior columns. The tissue was not diffuent, but became flaky and partially dissolved when a small and gentle current of water was poured on it. In this case, no more than in that of Mr. Stanley, the lesion was not enough to *destroy* sensation, but surely it was sufficient to *impair* it, if the posterior columns are to be regarded as the channels of sensation.*

Serres records the case of a woman who had been paraplegic for two months: sensibility was preserved in the lower extremities; the lesion consisted in disease of the posterior columns of the cord below the middle of the dorsal region.†

In two cases which occurred in King's College Hospital under my own care, the prominent symptom was impairment of the motor power, without injury to the sensitive; yet the seat of organic lesion in both was in the posterior columns of the cord.

Nasse, in the paper before referred to, alludes to several cases of the same nature, in which disease affected the posterior columns, but did not impair sensation.

Longet, who is a warm advocate for the identity of function between the posterior roots and posterior columns, cites some instances in which total loss of sensibility coexisted with degeneration of the posterior columns as the only lesion: in these cases, however, the posterior roots of the nerves were involved in the disease, and their function became impaired or destroyed in consequence. A case of this kind, to be conclusive upon the point in question, ought to exhibit complete destruction of the posterior columns, or of a considerable portion of them, with perfect integrity of the posterior roots and of the antero-lateral columns. If in such a case there were total loss of sensibility in the parts in nervous communication with the diseased portion of the spinal cord, then, indeed, we would be justified in affirming that the antero-lateral columns took no part in propagating sensitive impressions, and that the loss of sensibility was due to the morbid state of the posterior columns.

* *Med.-Chirurg. Trans.*, vol. xxii.

† *Anat. Comp. du Cerveau*, vol. ii., p. 221.

When to these results, obtained from pathological researches, we add those of experiment, nothing is gained which can be favourable to the attribute of sensitive power to the posterior columns of the cord. Dr. Baly's experiments on tortoises showed that movements might be excited whether the anterior or the posterior columns were irritated, much stronger motions being excited by the posterior than by the anterior columns. Longet found that motions might be excited by irritation of the posterior columns of the cord if the experiment had been made immediately after the transverse division of the cord, and he refers such motions, probably with justice, to an excited state of the cord. After a little time this subsides, and then M. Longet was able to pass the galvanic current through each or both of the posterior columns, without exciting any motions when the lower segment of the cord was acted upon, but causing pain, as evinced by loud cries and writhing of the body, when the upper segment was tried. From experiments of this kind no satisfactory deductions can be made: to irritate the posterior columns of the spinal cord in a living dog without affecting in some degree the posterior roots of the nerves, appears to me to be quite impossible, even in the hands of the most practised vivisector.

Neither anatomy, pathological observation, nor experiment, lend sufficient countenance to the doctrine of the identity of the function of the posterior roots and posterior columns to justify us in concluding that these columns are the ordinary channels for the transmission of the sensitive impressions made upon the trunk and extremities.

I have long been strongly impressed with the opinion that the office of the posterior columns of the spinal cord is very different from any yet assigned to them. They may be in part commissural between the several segments of the cord, serving to unite them and harmonize them in their various actions, and in part subservient to the function of the cerebellum in regulating and co-ordinating the movements necessary for perfect locomotion.

This view is suggested by a comparison of the spinal cord with the brain, and by the anatomical connections of the posterior columns.

The brain is an organ composed of various segments, which are connected with each other by longitudinal commissures. The cord is obviously divisible into a number of ganglia, each forming a centre of innervation to its proper segment of the body. These portions must be connected by similar longitudinal commissures to those which confessedly exist in the brain. If we admit such fibres to be necessary to ensure harmony of action between the several segments of the encephalon, there are as good grounds for supposing their existence in the cord as special connecting fibres between its various ganglia to secure contemporaneousness of action between them.

The attribute of locomotive power rests upon the connection of the posterior columns with the cerebellum, and the probable influence of that organ over the function of locomotion and

the maintenance of the various attitudes and postures. If the cerebellum be the regulator of these locomotive actions, it seems reasonable to suppose that these columns, which are so largely connected with it, each forming a large proportion of the fibrous matter of each crus cerebelli, should enjoy a similar function, and that, as they are the principal medium through which the cerebellum is brought into connection with the cord, it must be through their constituent fibres that the cerebellum exerts its influence on the centre of innervation to the lower extremities and other parts concerned in the locomotive function, and on the nerves distributed to these parts.

The nearly uniform size of the posterior columns in the different regions of the cord, whilst it may be noted as unfavourable to their being viewed as channels of sensation, may be adduced as a good argument in favour of their being concerned in locomotion and acting as commissural fibres. It is a fact worthy of notice that these columns experience no marked diminution in size until the large sacral nerves, which furnish the principal nerves of the lower extremities, begin to come off. The reason of this is probably because the fibres of these columns connect themselves in great part with the lumbar swelling of the cord, and some of them perhaps pass into the sacral nerves.

The following remarks will serve to explain the manner in which the posterior columns may contribute to the exercise of the locomotive function. In examining a transverse section of the cord in the lumbar region, we observe a great predominance of its central grey matter; the posterior columns appear large, and the antero-lateral columns seem inadequate in proportion to the large roots of nerves which emerge from it. Now, an analysis of the locomotive actions shows, with great probability, that they are partly of a voluntary character, and partly dependent on the influence of physical impressions upon that segment of the cord from which the nerves of the lower extremities are derived. There are two objects to be attained in progression, namely, to support the centre of gravity of the body, and to propel it onward. The former object is attained by physical nervous actions, the latter by mental. The support of the centre of gravity of the body requires that the muscles of the lower extremities, the pillars of support to the trunk, should be well contracted in a degree proportioned to the weight they have to sustain. The contraction of these muscles seems well provided for in an arrangement for the development of nervous power by a stimulus propagated to the centre, and then reflected upon the motor nerves of these muscles. The stimulus is afforded by the application of the soles of the feet to the ground; it is therefore proportionate to the weight which presses them downwards. It is well known that reflex actions are more developed in the lower than in the upper extremities, and the surface of the sole of the foot is well adapted for the reception of sensitive impressions. No object can be assigned for this peculiarity, unless it have re-

ference to the locomotive actions, and the great development of the vesicular nervous matter in these regions betokens the frequent and energetic evolution of the nervous force. All the structural arrangements necessary for this purpose are found in the antero-lateral columns. The posterior columns come into exercise in balancing the trunk and in harmonizing its movements with those of the lower extremities.

Some support is obtained for this view of the function of the posterior columns from the phenomena of disease. In many cases, in which the principal symptom has been a gradually increasing difficulty of walking, the posterior columns have been the seat of disease. Two kinds of paralysis of motion may be noticed in the lower extremities, the one consisting simply in the impairment or loss of the voluntary motion, the other distinguished by a diminution or total loss of the power of co-ordinating movements. In the latter form, while considerable voluntary power remains, the patient finds great difficulty in walking, and his gait is so tottering and uncertain that his centre of gravity is easily displaced. These cases are generally of the most chronic kind, and many of them go on from day to day without any increase of the disease or improvement of their condition. In two examples of this variety of paralysis I ventured to predict disease of the posterior columns, the diagnosis being founded upon the views of their functions which I now advocate; and this was found to exist on a post-mortem inspection; and in looking through the accounts of recorded cases in which the posterior columns were the seat of lesion, all seem to have commenced by evincing more or less disturbance of the locomotive powers, sensation being affected only when the morbid change of structure extended to and more or less involved the posterior roots of the spinal nerves.

Bellingeri put forward the opinion that the anterior columns of the spinal cord influenced movements of flexion, and the posterior columns those of extension; to the grey matter he assigned the office of propagating sensitive impressions to the brain; and the lateral columns, according to him, exercised an influence upon the organic functions of nutrition and circulation.

The views already referred to respecting the grey matter show that it cannot be regarded as devoted exclusively to one function of the nervous system; nor can it be viewed as capable of taking its part in nervous actions without the white or fibrous matter.

Valentin adduces some experiments not unfavourable to the supposition that the nerves of extensor muscles pass towards the posterior part of the cord, and those of the flexor muscles to the anterior part. He found that if, in frogs, the posterior surface of the cord on one side of the posterior median fissure in the region of the second or third vertebra were irritated by the point of a needle, the anterior upper extremity of the same side was extended and drawn backwards. When the anterior surface was

irritated, the limb was drawn forwards to the head. Irritation of the posterior column in the region of the sixth vertebra and below it caused extension of the posterior extremities, but they were thrown into flexion by irritation of the anterior columns.

These are remarkable results; they need, however, the confirmation of other observers. If they be correct, the fact of the connection of the nerves of extensor muscles with the posterior columns has an interesting relation with the supposed locomotive function, for there can be no doubt that movements of extension contribute largely to the ordinary attitudes and to the various modes of progression.

Valentin refers to cases in which the anterior columns having been the seat of tumor or of softening, more or less permanent flexion of the lower limbs had ensued. These cases do not favour his view unless he can show that the lesion in all the cases was of the irritant kind, inducing a spasmodic contraction of the flexor muscles; for if the lesion be of a paralyzing kind, the effect would be to paralyse the flexor muscles and allow the extensors full sway. The explanation of the flexed state of limbs in cases of this kind is probably to be derived from a chronic state of contraction induced in the muscles themselves by the lesion of the nervous centre, and the state of flexion is assumed rather than extension in consequence of the predominance of flexor muscles over extension.

Sir Charles Bell's doctrine, which assigned to that portion of the cord which is intermediate between the roots of the nerves, (*his middle column*), a special power over the movements of respiration, has long ceased to gain attention from physiologists. It wanted the support of anatomy. The so-called middle column had no defined limits, nor could it be proved that any respiratory nerves were connected with this region of the cord, excepting a few fibres of the spinal accessory nerve. The distinct anatomy of a respiratory system of nerves existed only in the imagination of the inventor of the doctrine. It could not be shown by experiment that the so-called nerves of respiration had any special respiratory function beyond that which they exercised as the motor nerves of certain muscles. And among the nerves which Sir C. Bell had classed together as nerves of respiration, were some which certainly had no necessary connection with that function. Of these the *portio dura* and the glosso-pharyngeal are examples.

Influence of the spinal cord upon the organic functions.—The influence of the spinal cord upon certain organic functions has engaged a large share of the attention of experimental physiologists. It has been said to have a very direct control over the functions of circulation, calcification, secretion, especially that of the kidneys.

If it can be shown that the organs concerned in these functions receive several nerves from the spinal cord, then we do not stand in need of vivisections to indicate to us that the

functions with which they have to do are, to a certain extent at least, influenced by this organ. Now it is almost certain that the heart and kidneys receive filaments from the cord which pass to them chiefly in the sympathetic nerve; but as it is equally certain that they receive nerves from other sources likewise, as from the vagus nerve, and the proper filaments of the sympathetic, it would be erroneous, so far as anatomy teaches us, to affirm that these organs were wholly dependent on the cord.

As regards the heart, observation and experiment on man and animals tend to confirm the conclusion which anatomy indicates, namely, that while the heart possesses a certain inherent power, and while it has an immediate connection with the medulla oblongata and with the sympathetic, it is also not independent of the spinal cord. A slight injury to the cord or a chronic lesion of it affect the heart but little or not at all, because of its other sources of innervation; but a sudden and extensive injury to the cord, or a rapidly-developed destructive disease of it, materially depresses and weakens the action of the heart, and thereby the general circulation. The experiments of Clift, Wedemeyer, and Nasse may be cited as leading distinctly to this conclusion. Nasse's experiments were on dogs, in which he maintained artificial respiration; he found that as soon as the spinal cord was destroyed, the heart failed so completely that the jet of blood from the femoral artery, which before had gone to a distance of some feet, could not reach as many inches, or the blood did not escape per saltum from the wounded artery. In performing a similar experiment, Longet compared the action of the heart in two dogs, destroying the cord in one, but allowing it to remain intact in the other, and he found that in the animal whose spinal cord was destroyed the cardiac movements became enfeebled in a very striking manner, when compared with those of the animal whose cord was left uninjured.

If, then, we can prove that the spinal cord exercises an influence upon the central organ of the circulation, there can be no doubt that its power extends to the peripheral parts of the circulating system, to the capillary vessels, and, therefore, that injury or disease of it, especially if sudden or extensive, must to a certain extent affect the functions which are performed through the agency of these vessels, namely, nutrition, calorification, and secretion.

It seems most probable that it is only in this secondary manner that the influence of the spinal cord becomes extended to these functions, and that they suffer, when, through lesion of the cord, this influence has been greatly diminished or removed. The indications of its connection with nutrition and calorification are derived from the wasting and the coldness which are manifest in the paralysed parts when there is lesion of the spinal cord of a depressing kind. Sometimes, too, the nutrition of these parts is so feeble that gangrenous sloughs are formed on parts exposed even to slight pressure. This is more apt to be the case where the disease of the cord has been of a destruc-

tive kind, and has involved a considerable portion of the organ and of the roots of its nerves.

The influence of the spinal cord upon secretion has been inferred chiefly from the frequent occurrence of an alkaline state of urine in connection with injuries of that organ, and less frequently in diseased states of it. The urine, when passed, is found to be highly alkaline from the existence in it of a large quantity of carbonate of ammonia. The urine, in cases of this kind, is very apt to contain more or less of what has been very commonly, although erroneously, called *ropy mucus*, which is in truth pus formed from the mucous membrane of the bladder. This membrane is irritated and inflamed by the sojourn in it of the urine which the paralysed bladder is unable to expel. The secretion of a large quantity of phosphate of lime and of mucus, and afterwards of pus, is provoked by inflammation of the vesical mucous membrane. And the addition of these matters to it, especially the former, neutralises all free acid and gives rise to decomposition of the urea, and the production thereby of carbonate of ammonia. The alkalescence of the urine favours the precipitation of the triple phosphate. Hence urine obtained from patients suffering under spinal disease resembles very closely that of patients with diseased bladder without spinal disease. We may see in it mucus or pus globules, triple phosphates, blood particles, and amorphous masses of phosphate of lime mingled with the mucus. But in some instances the period of the sojourn of the urine in the bladder appears too short for these changes to take place; and hence it has been supposed that the urine may be secreted alkaline by the kidneys. Mr. Smith, of St. Mary's Cray, in Kent, made experiments on this subject by washing out the bladder carefully with warm water several times, withdrawing the water each time and testing for ammonia until all indication of its presence ceased. He then injected a small quantity of clear water, and allowed it to remain fifteen or twenty minutes; it was then drawn off, and the odour of ammonia could be distinctly perceived. It is to be regretted that a more accurate test of the presence of ammonia had not been used. Admitting, however, that ammonia did exist in this fluid, the experiment by no means disproves the formation of ammonia in the bladder. So small a quantity of urine as might trickle into the bladder in twenty minutes might readily be neutralised and decomposed by any alkali or mucus present in the bladder which might have eluded the previous washing out of that organ. If the secretion of urine in the alkaline state were common, it might reasonably be expected that such urine would be more frequently met with than it is in spinal complaints. Dr. Golding Bird, indeed, states that in the case of a woman in Guy's Hospital, labouring under complete paraplegia, and passing, with the aid of a catheter, fetid, alkaline, and phosphatic urine, he washed out the bladder with warm water, and after the lapse of half an hour obtained some

urine from the bladder by the catheter; this he found to be acid, a sufficient proof that the urine was not alkaline when secreted, but underwent the change during its stay in the bladder.

In those affections of the spine which are not attended by a paralysed state of the bladder, the urine is not alkaline; let, however, the power of the bladder be impaired, even to a slight degree, and the quality of the urine will soon suffer. And it is well known that in cases where impediment to the flow of urine from the bladder occurs independently of any paralysis of the organ, as from stricture of the urethra, a similar derangement in the quality of the urine is apt to take place.

It must not, however, be forgotten that chronic disease of the brain or spinal cord is frequently accompanied by phosphatic urine, even when the power of the bladder is unimpaired, and that in such urine the addition of a little liquor ammoniæ or potassæ will cause a more or less copious precipitate of triple phosphate. There can, therefore, be no doubt that the cerebral or spinal lesion affects in some way or other the renal secretion so as to favour the development of alkaline phosphates in it, and thus to create a tendency to its becoming alkaline. This, however, may arise not from any special influence upon the kidney, but from an undue waste of nervous matter, which would furnish the material for the formation of the phosphatic salt.

A very striking connection between the spinal cord and the kidneys, whereby a diseased state of the latter organs induces a functional derangement of the former, is shown by the history of those cases to which the attention of medical men was first called by Mr. Stanley. The patients are more or less completely paralytic, and all the symptoms of disease of the spinal cord exist: but at the same time there exists irritation or actual organic lesion of the kidneys, which, however, may be overlooked or attributed to the spinal disease. When the renal disease has been completely removed and the kidneys restored to their normal condition, the paralysis gets well; but more frequently both the renal disease and the paraplegia resist all remedial means, and the patients die. On examination, both the brain and spinal cord are found perfectly free from any organic lesion; but distinct evidence of inflammatory or other irritant disease of the kidneys exists.*

In a case of this kind which came under my own observation, there was, along with complete paralysis of sensation and motion in the lower half of the body, excessive hæmaturia, which had all the characters indicative of renal hemorrhage. From the man's habits and history I suspected that the affection of the kidney had something to do with suppressed gout, and accordingly I used every means to attract gout to the feet. These means were successful, for, no sooner was my patient attacked with an active paroxysm of gout in one great toe than

the renal disease began to subside, and the paralytic affection disappeared simultaneously.

Rayer, in his valuable work on diseases of the kidneys, relates several cases, which, in addition to those put on record by Mr. Stanley, leave no room to doubt that renal irritation may be propagated to the cord, and may occasion such an amount of disturbance of the functions of that organ as to give rise to paralysis of the lower extremities.

There seems no other mode of explaining these cases than by ascribing them to irritation of the cord excited by irritation of the kidneys, the nerves of the latter organ being the medium through which the renal affection excites the spinal. Yet there is no special connection between the nervous system of the kidney and the spinal cord, excepting probably through such tubular fibres as may be found in the renal plexus. These probably run a short course, and their origin in the cord is in close proximity to their distribution in the kidney; and on this account they may be more obnoxious to the influence of irritant disease of the latter organ.

The power which irritation of the cord has to develop erection of the penis may be here noticed as a remarkable instance of the influence of that organ over a local circulation. For it is only by assigning it to a temporary turgescence of the complex vascular system of the penis that we can explain this erect state. Even in ordinary erection, excited by a stimulus applied to the glans, as already pointed out, the influence of the cord is called into action, and the phenomenon is produced by a reflex, or what Dr. M. Hall would call an excito-motor act. Yet, (and here we may notice how ill-chosen has this term "excito-motor" been,) there is in reality no excitation of muscular action, but the influence of the stimulus propagated to the spinal cord is extended by a reflex act to the nerves which are distributed to the vessels of the penis, and they, instead of being excited to any contraction, become rather relaxed, and are thus prepared to receive a larger supply of blood; or by the extension of this excited influence of the cord, the attractive force (*vis a fronte*) of the capillaries is increased, and thus a larger quantity of blood is attracted to the organ, and erection takes place. The influence of the nervous system on this act is shown by the most convincing evidence—by the highly sensitive state of the organ, especially of the glans; by the large size of its nerves; by the effects of injury or disease affecting the cord immediately, or by extension from some part of the encephalon; and lastly, by the experiment of Günther, who divided the nerves on the dorsum of the penis in a stallion, and thereby destroyed the power of erection, although the vessels were uninjured.

On the mechanism of the functions of the cord.—Having shown that the spinal cord is concerned in voluntary motions and in sensation, (mental nervous actions,) and in certain reflex actions, as well as in certain organic functions, (physical nervous actions,) it is im-

* Med. Chir. Trans. vol. xviii.

portant to ascertain what is *the mechanism* by which these various actions take place.

The most convenient way to discuss this point will be to examine into the value of certain hypotheses which have been framed to explain it. We shall find it necessary in this discussion to keep before us two propositions in favour of which sufficient evidence has already been adduced. These are, 1. That the brain or some part of it is essential to the production of mental nervous actions; in other words, that acts of volition and sensation cannot take place without the brain: and, 2. That the vesicular is the truly dynamic nervous matter, that which is essential to and the source of the development of all nervous power.

The first hypothesis which we shall notice is one of so much ingenuity that one is tempted thereby to adopt it, and would gladly do so if it were found sufficient to explain the phenomena, and if it were consistent with that simplicity which characterises the mechanism of the body. It originated with Dr. Marshall Hall, and has been advocated by him with great zeal and ability; it may be distinguished as the hypothesis of an *excito-motory system of nerves, and of a true spinal cord*, the centre of all physical nervous actions.

This hypothesis may be stated as follows.*

The various muscles and sentient surfaces of the body are connected with the brain by nerve fibres which pass from the one to the other. Those fibres destined for or proceeding from the trunk to the brain pass along the spinal cord, so that that organ is in great part no more than a bundle of nerve fibres going to and from the brain. - These fibres are specially for sensation and volition—*sensori-volitional*.

* I am very desirous that this hypothesis should be stated correctly, as I consider that both physiology and practical medicine are greatly indebted to Dr. Marshall Hall for the attention his labours have awakened to the inherent powers of the nervous system. Nevertheless I have shown in the text that great advances in our knowledge of these powers had been made by certain physiologists of the last century, whose views and researches had been completely or almost forgotten.

I have collected the statement of Dr. Hall's hypothesis in the text chiefly from his later writings. The history of Dr. Hall's labours on this part of physiology, as I gather it from his writings, appears to be as follows:—

In 1832 a paper was presented by him to the Zoological Society, of which, so far as I can ascertain, no other record has been kept than that which is to be found in the printed summary of the Proceedings of that Society. I have not had any opportunity of consulting these proceedings, but find an extract from them printed in Dr. Hall's work entitled *Memoirs of the Nervous System*, published in 1837. This paper was entitled, "A brief Account of a particular Function of the Nervous System," and its object was to point out the existence of a source of muscular action distinct from all those hitherto noticed by physiologists. The peculiarity of this motion is stated to consist in its being excited by irritation of the extreme portion of the sentient nerves, whence the impression is conveyed through the corresponding portion of the brain and spinal marrow as a centre, to the extremities of the motor nerves. Experiments upon salamanders, frogs, and turtles were detailed, from which Dr. Hall drew the follow-

ing conclusions: 1. that the nerves of sensibility are impressible in portions of an animal separated from the rest; in the head, in the upper part of the trunk, in the lower part of the trunk; 2. that motions similar to voluntary motions follow these impressions made upon the sentient nerves; and, 3. that the presence of the spinal marrow is essential as the central and cementing link between the sentient and motor nerves.

Other experiments were detailed in this paper upon frogs rendered tetanic by a solution of opium; these showed that in this state the cutaneous nerves became "extremely susceptible, and the motor nerves extremely excitative." Decapitation of a tetanized frog did not destroy the tetanic condition of the trunk and extremities. "The exalted condition of the function of the sentient and motor nerves continued in each part." "All was changed in removing the brain and the respective portions of the spinal marrow."

"These experiments," Dr. Hall continued, "appear to me to establish a property or function of the nervous system, of the sentient and motor nerves, distinct from sensation and voluntary or instinctive motion."

Dr. Hall's next publication appears to have been a paper read before the Royal Society on the 20th of June, 1833. This paper is entitled "*On the reflex function of the medulla oblongata and medulla spinalis*." Having noticed the conclusion arrived at by Le Gallois, and confirmed by the reporters of the Institute, that section of the spinal marrow in the neck arrests only the respiratory movements, leaving sensation and voluntary motion to remain in the whole body, he points out that the causes of muscular motion may be *centric* or *eccentric* in the nervous system. When the cause is *eccentric*, that is, distant from the nervous centres, Dr. Hall states that the phenomena are due to a peculiar function, which he considers had not previously been understood. Its characteristic is that it is "*excited* in its action and *reflex* in its course; in every instance in which it is excited, an impression made upon the extremities of certain nerves is conveyed to the medulla oblongata or medulla spinalis, and is reflected along other nerves to parts adjacent to, or remote from, that which has received the impression."

"It is by this reflex character," he adds, "that the function, to which I have alluded, is to be distinguished from every other." Yet, curious to say, he assigns to it powers which certainly cannot be excited in the reflex manner. He says, "the reflex function exists as a *continuous* muscular action, as a power presiding over organs not actually in a state of motion, preserving in some, as the glottis, an open, in others, as the sphincters, a closed form, and in the limbs a due degree of equilibrium or balanced muscular action, a function not, I think, recognised by physiologists."

Dr. Hall points out the distinctness of this function from sensation and voluntary motion, and relates experiments on decapitated animals, (snakes, turtles, vipers, toads, frogs, and efts,) to show that the motions which occur in them are not spontaneous but only excited, and that these "excited motions in decapitated animals are dependent upon a principle different from sensation and volition." He then shows the difference between the reflex movements and those arising from irritability, by comparing the motion of the heart, when touched, with that of the glottis of an animal when similarly stimulated. Both movements take place equally after the removal of the brain; but if the medulla oblongata be removed, the contractions of the larynx cease, while those of the heart continue. "The difference consists, then, in the presence of the medulla oblongata, which is essential to the

the spinal cord and to its intracranial continuation, which form a connection with the grey

matter of the cord. Of these fibres some are afferent or incident, others efferent or re-

contractions of the larynx, but of which those of the heart are entirely independent. The influence of the stimulus upon the heart is immediate. That of a stimulus applied to the larynx must pass to the medulla oblongata, and be reflected upon the part moved."

The details of further experiments next follow. The author refers to the reflex function the power which the hedgehog has of assuming the form and firmness of a ball. (?) Cases of infants born without brain or cerebellum are referred to in proof of the existence of reflex actions in the young of the human subject. The experiment of dividing the spinal marrow between the nerves of the superior and inferior extremities is described, to show "two modes of animal life; the first being the assemblage of the voluntary and respiratory powers with those of the reflex function and irritability; the second, the two latter powers only;" "if the spinal marrow be now destroyed, the irritability alone remains, all the other phenomena having ceased."

Dr. Hall next shows that the reflex function admits of *exaltation* and *diminution*. Frogs are made tetanic by opium and strychnine, and the tetanus disappears on removing the spinal marrow. On the other hand, a few drops of hydrocyanic acid placed upon the tongue of a frog depress the reflex function; "the contractions which depend on the reflex function are observed to become less and less energetic and excitable, and at length cease altogether."

Some highly interesting references are made to the light thrown upon the nature of certain diseases by our knowledge of this reflex function. The morbid states produced by dentition, epilepsy, asthma, tenesmus and strangury, tetanus and hydrophobia, are the principal diseases mentioned.

The rest of the paper consists of inferences from the preceding parts and a recapitulation.

Dr. Hall had formed, at this time, no distinct hypothesis respecting any special mechanism for the reflex function. He makes the following remarks, which seem to foreshadow his subsequent hypothesis referred to in the text. "It appears probable," he says, "that the facts of this paper may lead to some important additions to our knowledge of anatomy, by inducing an accurate inquiry into the origin, course, connection, and distribution of the subcutaneous, or submucous, and muscular nerves, which constitute the arcs of the reflex function."

In reviewing this interesting and important paper, it is impossible not to feel the greatest regret that its author should have done so much injustice to himself as well as to those who had preceded him, by neglecting to give an exact account of the state of science in reference to this question at the time he wrote. No one who peruses with candour the essay of Prochaska can deny that it contains, with regard to the reflex function, everything that Dr. Hall's paper contains, everything which will bear the test of careful analysis, omitting those views which are, indeed, peculiar to Dr. Hall, and which do not appear in this paper, assigning to the cord powers over ingestion, egestion, muscular tone, and irritability, &c. Throughout the whole paper no allusion whatever has been made to Prochaska's essay. The Report of certain members of the Institute upon the work of Le Gallois, (both of which Dr. Hall quotes,) makes distinct reference to Prochaska's views of the reflection of sensorial impressions. It must not, however, be forgotten that Prochaska's views had fallen into oblivion and neglect, and that Dr. Hall revived them, illustrated them by experiments, and showed their application to the pathology of the nervous system. I may add, that nothing would be more excusable than that a physician, working at these

subjects in 1832, should be ignorant of Prochaska's essay published in 1784, more especially as it was overlooked even by his own countrymen—by such men as Treviranus, Rudolphi, and Müller.

Dr. Hall's next publications, as he himself states, (Preface to *Memoirs on the Nervous System*, 1837,) were a course of lectures, delivered from a printed syllabus in the summer, and repeated in the winter of 1835, of which one was inserted in the *Medical Gazette* for January, 1836, and the whole in his *Lectures on the Nervous System and its Diseases*, published in April, 1836.

It is in this latter work that, so far as I have been able to ascertain, Dr. Hall first put forward the hypothesis detailed in the text. It is stated, however, not as a hypothesis, but as a *discovered fact*. Having described two divisions of the nervous system, the first consisting of the cerebrum and cerebellum with sentient nerves, which pursue their course to them, and of motor nerves, which proceed from them either along the base of the brain or along the spinal marrow, and then along every external part of the animal frame, and the second comprehending the sympathetic, Dr. Hall goes on to say: "To these two subdivisions of the nervous system, I believe a third must be added before our views of that system can be considered as at all complete; it is one which I claim the merit of first pointing out in all its fullness. Suppose the cerebrum and cerebellum, the centre of the first subdivision of the nervous system, and the ganglionic or the second subdivision of this system removed, *this remains*. It consists of the *true* spinal marrow, distinguished from the sentient and motor nerves, which run along its course as an axis of *excite*- and motor nerves. It is the seat of a peculiar series of physiological phenomena, and of a peculiar class of pathological affections." "In the former are included *all* (sic) the functions which relate to the immediate acts of *ingestion* and *egestion*; in the latter, *all* spasmodic diseases." (Loc. cit. p. 11.)

Further on, in the same work, Dr. Hall gives an analysis of his true spinal or excito-motory system, which consists, according to his description, of, 1. the Membranes; 2. the True Medulla; 3. the True Spinal Nerves. The principal divisions of the true medulla, he specifies as follows:

1. The Tubercula Quadrigemina,
2. The Medulla Oblongata,
3. The Medulla Spinalis, and especially its
 1. Cervical,
 2. Dorsal,
 3. Lumbar, and
 4. Sacral portions.*

The reader who has perused with attention the analysis of Prochaska's work given in the text will perceive a striking resemblance between this *true Medulla* and the *Sensorium commune* of Prochaska, p. 721E.

In this work there is no allusion to the important essay of Prochaska, although Sir Charles Bell is corrected for attributing the discovery of the ganglia on the posterior roots of the spinal nerves and on the portio major of the fifth to Monro instead of to Prochaska (p. 17), and two quotations are made from the latter author without specifying the work from which the passages are quoted.

In 1837 Dr. Hall published a quarto volume with the title, "*Memoirs on the Nervous System*." This consists of a reprint of the paper published in the *Philosophical Transactions*, "*On the Reflex Function of the Medulla Oblongata and Medulla Spinalis*;" and also of a paper which was re-

* An anatomical oversight, as the *medulla spinalis* has no sacral portion.

flex, and these two kinds have an immediate but unknown relation to each other, so that

each afferent nerve has its proper efferent one, the former being *excitor*, the latter *motor*.

before the Royal Society on February the 16th and 23d, and March the 2d, 1837, but was not published in the Transactions. This paper is entitled, "On the true Spinal Marrow and the Excitomotory System of Nerves."

The object of this paper the author states to be the development of a great principle in physiology—that of the special function of the true spinal marrow and of a system of excito-motory nerves.

"It is this principle," he continues, "which operates in all those actions which have been designated sympathetic, which regulates the functions of ingestion and expulsion in the animal economy, and which guards the orifices and sphincters of the animal frame."

"The principle to which I allude," he proceeds, "has been confounded with sensation, and voluntary, and what has been designated instinctive, motion, by *all* (sic) physiologists, with one single exception (Sir Gilbert Blane). It has been supposed to be a function of the rational (Stahl) or irrational (Whytt) soul. It has been considered by some (Haller, &c.) as attached to the brain; by others (Whytt, Soemmering, Alison, Muller,) as attached to the brain and spinal marrow; by others (Le Gallois, Flourens, Mayo,) as peculiarly attached to segments of the spinal marrow; it has been viewed by others as the function of the sympathetic (Tiedemann, Lobstein,) or of the pneumogastric nerve (Bell, Shaw); and, lastly, by others as operating through identity of origin or anastomoses of nerves (Mayo)."

How very strange it is that amidst all the research displayed in this paragraph, no mention should have been made of Unzer and Prochaska, the only authors who really had clearly stated the correct doctrine respecting nervous phenomena independent of the mind!!

In this paper Dr. Hall falls into the curious error of affirming that the power which is developed in the nervous system in connection with sensation and volition, is different from that through which the reflex actions are produced. To the latter he limits the term *vis nervosa*, and, having quoted Haller's very correct description of the course which it takes in motor nerves, he affirms that his researches have disclosed a series of phenomena "directly at variance with the conclusions of Haller."

I confess myself quite unable to discover in what respect Dr. Hall's results are at variance with the laws of the *vis nervosa* as laid down by Haller. All that the latter physiologist affirmed was that the nervous force travelled from trunk to branches in motor nerves, and that irritation of the spinal cord caused convulsions of the limbs which derived their nerves from below the point of stimulation. Now these facts are strictly true—by whatever stimulus the nervous force is excited in motor nerves it travels from trunk to branches; and the statement made by Haller respecting the spinal cord is equally true, namely, that the motor force travels downwards, and that irritation of the cord affects only the limbs below the irritated point. All that Dr. Hall has made out which is at variance with this proposition is, that *sometimes* the anterior extremities may be thrown into action by stimulating that segment of the cord from which the posterior extremities derive their nerves, from whence he concludes that "the motor power in the spinal marrow will act in a retrograde direction."

This conclusion, however, does not follow from the experiments adduced in support of it. If the spinal cord of a turtle be irritated in the segment from which the nerves to the hinder extremities spring, and all four extremities are thrown into action by that stimulus, we are not authorized to conclude that the *motor* power will act in the spinal

marrow in a retrograde direction; all that we are justified in affirming is that the same change which would excite the nerves of the irritated part of it may be propagated from its lower to its upper part. How this takes place is uncertain, whether by sensitive fibres or by commissural fibres, or by vesicular matter, most probably by the last.

It may, however, be stated that such phenomena as those described take place chiefly in an excited state of the cord, as when the animal is under the influence of strychnine—or in tetanus—and their occurrence is far from being in accordance with a normal state of action of the spinal cord. I have frequently irritated the cord in healthy animals without producing any movements save in parts below the point stimulated. (Vide supra, p. 721G.)

Dr. Hall in this paper draws the same conclusions as in his work last referred to as to the existence of a "true spinal marrow physiologically distinct from the chord of intra-spinal nerves; of a system of excito-motory nerves, physiologically distinct from that of the sentient and voluntary nerves; and of a nervous influence—the excito-motory power—operating in directions incident, upwards, downwards, and reflex, with regard to the true spinal marrow, the centre of this excito-motory system." When Dr. Hall uses the term *physiologically* distinct, of course he means, likewise, *anatomically* distinct. One part cannot be *physiologically* distinct from another without being *anatomically* so also.

In the second section of this paper Dr. Hall gives "a slight sketch of the opinions of physiologists upon the subject of this memoir." He alludes to the views of Haller, Monro, Whytt, Blane, Le Gallois, and the Reporters of the Institute upon Le Gallois' Essay, Mayo, Flourens, Alison, and Muller, but makes no allusion to either Unzer or Prochaska.

I pass over the third, fourth, fifth, and sixth sections, and proceed to the seventh. Here the laws of the excito-motory system are stated, and those extravagant powers are attributed to it, which I have in the text endeavoured to show it cannot exercise. But, in addition, this system is made to be the nervous agent of the appetites and passions! What strange confusion! that a system, devised as the special centre of nervous actions *independent* of the mind, should be the seat of phenomena preeminently mental, and intimately connected with sensation.

The remainder of this essay consists of further remarks on the anatomy, physiology, pathology, and therapeutics of the excito-motor system, and concludes with some observations on the ganglionic system of nerves.

In 1841 Dr. Hall published his work on the Diseases and Derangements of the Nervous System. In this work I am not aware that any new or additional fact has been stated not mentioned in those already quoted. It includes a reprint of several memoirs read to the Medico-Chirurgical Society.

In 1843 a "New Memoir on the Nervous System" appeared, dedicated to Professor Flourens as to one "who has in his responsible office displayed the most candid, impartial, and generous judgment of the works of others."

I find it necessary to notice an assertion contained in a note to the advertisement of this work Dr. Hall observes:—

"My first memoir was entitled, 'On the Reflex Function of the Medulla Oblongata and Medulla Spinalis.' This important function as the nervous agent in *all* the acts of ingestion and of egestion in the animal economy was previously unknown. It is not mentioned by Whytt, or Prochaska, or any other author; who, however they may cite the term reflex, or detail experiments, or treat of sym-

The aggregate of these fibres, together with the grey matter, constitutes the *true spinal cord*

pathetic actions, have not, I affirm, associated one physiological act with any such reflex function of the spinal marrow. This is, therefore, my discovery."

Upon this passage I must remark, 1st, that if Dr. Hall merely claims the discovery of the reflex function, it cannot be conceded to him, for Prochaska had already distinctly announced the existence of this function in the medulla oblongata and spinalis, using even the term *functio*, as in the following passage:—"Cum itaque precipua functio sensorii communis consistat in reflexione impressionum sensoriarum in motorias, notandum est, quod ista reflexio vcl animâ nesciâ, vel vero animâ consciâ fiat." *Loc. cit.* pp. 118-19.

If, however, Dr. Hall claims the discovery of this function "as the nervous agent in all the acts of ingestion and egestion in the animal economy," then I have only to remark that I know of no physiologist in the present or in former times who would care to dispute such a discovery with him. I have already shown that the idea that these acts of ingestion and egestion are dependent on this function is a fiction of the fancy—an *idolon specus*—which rests upon an imperfect and erroneous analysis of these acts, and on very narrow views of the nature and mode of development of the nervous force. If, finally, Dr. Hall limits his claims, as he says he might do, to the discovery (?) of the anatomy and physiology of the true spinal system, as a combined system of "1, incident nerves; 2, their spinal centre; and 3, reflex nerves, constituting the anatomy of the whole series of the acts of ingestion and egestion," I am quite sure that no anatomist or physiologist of the present day would seek to deprive him of such a discovery, or dispute the opinion of Professor Flourens that it belongs to Dr. M. Hall. That this so-called true spinal system is no more than an hypothesis, and one which has but an infirm basis to rest upon, I have endeavoured to show in the text. That a centre of reflex actions exists—but not distinct from the centres of sensori-volitional acts—every physiologist will admit, and the limits of that centre were most correctly defined more than fifty years ago by Prochaska under the name *sensorium commune*, which extends, according to him, "quam late patet nervorum origo," and which, as I have already remarked, completely foreshadowed Dr. Hall's "true spinal marrow."

In sections 6-11 of this work Dr. Hall states the real objects of his researches as follows.

"First, to separate the reflex actions from any movements resulting from sensation and volition.

Secondly, to trace these actions to an acknowledged source or principle of action in the animal economy—the *vis nervosa* of Haller—acting according to newly discovered laws.

Thirdly, to limit these actions to the *true spinal marrow*, with its appropriate incident and reflex nerves, exclusively of the cerebral and ganglionic systems.

Fourthly, to apply the principle of action involved in those facts to physiology, viz. to the physiology of all the acts of exclusion, of ingestion, of retention, and of expulsion in the animal frame.

Fifthly, to trace this principle of action in its relation to pathology, viz. to the pathology of the entire class of spasmodic diseases; and,

Sixthly, to shew its relation to therapeutics, especially to the action of certain remedial and certain deleterious physical agents.

Finally, it is to these objects, taken together as a whole or as a system, that I prefer my claims; and I do not pretend that an occasional remark may not have been incidentally made by some previous writer, bearing upon some one or other of them."

It is in this work that Dr. Hall has, for the first

of Dr. Hall, which is not limited to the spinal canal, but passes up into the cranium as far as

time, ventured to notice the remarkable views of Prochaska. I wish, for the sake of English physiology, and also for the sake of Dr. Hall's own character as one who professes great admiration for those who "display a candid, impartial, and generous judgment of the works of others," that the extracts which he has made from Prochaska's work, few and imperfect as they are, had been accompanied by some more dignified and more ingenious remarks than those contained in the following paragraph.

"It is impossible to adduce specimens of more complete confusion than these, in which voluntary acts, and the actions of the heart, stomach, and intestines—functions of the cerebral and of the ganglionic systems respectively,—are arranged with certain reflex experimental facts, and very obvious sympathetic actions, which really belong to the true spinal system."

I have carefully examined the passages quoted from Prochaska by Dr. Hall, and I confess myself unable to discover any of that "complete confusion to which he alludes." Prochaska states, that numerous examples (*plurima exempla*) prove the general law of the reflecting power of the sensorium commune, of which, however, he says, it will suffice to adduce only a few. He mentions sneezing produced by irritation of the mucous membrane of the nostrils,* the violent cough produced by irritation of the glottis—*per micam cibi vel guttulam potus illapsam*,—and the winking excited by bringing the finger close to the eye. If these are not fair examples of reflex actions, I know not what are.

Prochaska then proceeds to show that these reflex actions may take place with or without the cognizance of the mind; and here I must refer to a very disingenuous proceeding on the part of Dr. Hall in his quotations. He displaces the passages from their right order and therefore from the context, and thereby introduces an appearance of confusion which does not exist in the original. The passage commencing "*Si amicus digito*," &c. occurs before and in a different paragraph from that commencing "*Cum itaque precipuo*," &c., Dr. Hall quoting them as if the latter stood first. He has similarly transposed the passages commencing "*Sed feri tamen*," &c. and "*Motus cordis, ventriculi*."

In the remaining portion of this work Dr. Hall has systematized his views more completely than in his previous writings—repeating, however, the same experiments, re-asserting the same explanations of certain actions as before, and adding some new remarks in vindication of his views already expressed. Yet in this volume there are indications as if Dr. Hall had no great confidence in his own hypothesis, notwithstanding he had thought it worthy of being designated a discovery. At § 149, referring to Dr. Carpenter's and Mr. Newport's opinions in favour of the existence of excito-motory fibres distinct from sensori-volitional fibres, he remarks, "I doubt not that the investigations of these gentlemen are correct; they have, therefore, confirmed what I had long previously done." But in § 150, having mentioned Mr. Grainger's assertion that in the roots of the spinal nerves one set of fibres passes up to the brain, while the other pursues its course to the grey matter, he says, "It is probable, therefore, that the former are in reality nerves of sense and voluntary motion, whilst the latter are the nervous channels of the excito-

* Prochaska supposes that the olfactory nerves propagate the irritation which excites sneezing to the centre;—the office of the fifth nerve was not made out in his day.

the crura cerebri. (Its extent, indeed, is much the same as that which has been assigned by

Prochaska to his *sensorium commune*.) These fibres are quite independent of those of sensation and volition and of the sensorium commune, using that term as indicating the centre of intellectual actions. Although bound up with sensitive and motor fibres, they are not affected by them, and they maintain their separate course in the nerves, as well as in the centres.*

motor power and action. I say it is probable this is the case." And in § 151 he says, "It has always appeared to me that, observing the difference between the cerebrum and the spinal marrow, the olfactory and the trifacial nerves, in regard to the psychical and the excito-motor properties, it is very improbable that in any part of the nervous system the two functions should co-exist in any one individual fibre." I am, therefore, not premature in refusing to accept as a discovery that which Dr. Hall himself regards only as *probable*—and *not proved*. Lastly, at § 370, he quotes an experiment by Van Deen and Stilling, in which *one-half* of the spinal marrow is divided above the origin of the brachial nerves, and the other half below the same point, with the effect of leaving sensation and voluntary motion undestroyed. On this he remarks, "There is, therefore, no continuous rectilinear course of nervous fibre from the brain to the extremities."!

I shall here contrast the points made out by Prochaska with the statement of Dr. Hall's "real objects" as quoted a few paragraphs back.

1. Prochaska forms a large estimate of the importance of the *vis nervosa*; he attributes to it a high place among the forces which concur in the production of vital phenomena—not limiting the term, as Haller did, to the force by which nerves excite muscles to contract, but viewing it as THE agent in the production of all the phenomena of the nervous system.

2. He investigates the *laws* of this force as it is developed in the pulp of the nerves, leaving the enquiry into its *nature* to those who are engaged with physical experiments.

3. He shows that this nervous force, although in truth an innate property of the medullary pulp, nevertheless needs a stimulus for its development.

4. This stimulus, he further shows, may be either physical or mental.

5. He investigates the causes and effects of the increase and of the diminution of the *vis nervosa*, and how it is influenced by age, sex, and temperament.

6. He shows that the nervous force remains in nerves separated from the centres (within certain limits) even in "*singulis dissectorum nervorum frustis*."

7. Prochaska lays down that nerves act in producing motion and sensation in virtue of their power of propagating impressions made on them, whether at their origin or at their periphery.

8. He shows that external impressions made upon sensitive nerves are quickly propagated to their origin and there are *reflected*, according to a certain law, into corresponding motor nerves, whereby certain definite motions are effected.

9. This takes place whenever motor and sensitive nerves are implanted in the neighbourhood of each other, and all that part of the cerebro-spinal axis in which nerves are so implanted is called by Prochaska *sensorium commune*.

10. This reflexion of sensitive impressions into motor ones is a *physical phenomenon* independent of the mind.

11. The mind, however, may or may not be conscious of its occurrence.

12. Examples of reflex acts of this kind are found in sneezing, in the winking of the eye when the finger is suddenly directed close to it, in the violent cough produced by a particle of food or a drop of water passing into the trachea. In all these instances the effects of the stimulus applied to the sentient nerves of the part irritated are propagated to the centre, and there reflected into the nerves of those muscles by which the respective movements are produced.

13. The motions which may be produced in decapitated animals by excitation of the surface are of this kind, the reflexion taking place in the *resi-*

dual portion of the sensorium commune, which is in the spinal marrow; and those produced in patients labouring under apoplexy are of the same kind.

14. A similar reflexion takes place in ganglia to that which occurs in the sensorium commune.

15. Prochaska has, therefore, shown that the nervous centres may affect nerves implanted in them in three ways: 1, through mental change, as in voluntary actions; 2, through a physical change originating in the centres themselves; 3, through the reflexion of the change wrought in a sensitive nerve by peripheral stimulation, into a motor nerve: and that nerves may affect centres, 1, so as to excite a feeling in the mind (sensation); and, 2, so as to cause the reflexion of a peripheral change in the afferent sensitive nerve into an adjacent motor nerve, independently of the mind.

16. Prochaska concludes his observations by drawing a careful distinction between those motions which are *animal*, being directed by the mind, and those which are *mechanical* or *automatic* (*physical*), of which the mind may or may not take cognizance, but in the production of which it takes no part. In these latter are included the reflex actions.

Such are the conclusions to which Prochaska's observations lead him respecting the nervous system, and in them I confess there appears to me to be a large and an exact view of the phenomena of the nervous system, more comprehensive than the views of Dr. M. Hall respecting an excito-motor power and a special system of excito-motor nerves, and their centre, the true spinal nerves.

In his latest publication, a volume of essays, (1845) Dr. Hall asserts his conviction of the truth of his views, and re-affirms his claims to discovery.

I feel that I owe the reader some apology for this long note. The views of Dr. Hall have been so zealously pressed upon the attention of physiologists and of medical men, that it seemed to me that a work like this ought to contain as full a statement of them as its limits would permit, more especially as I have felt it my duty to express my dissent from them to a very great extent, and to criticize them with much freedom.

Throughout all my remarks it has been my anxious wish to express my opinions regarding Dr. Hall's views as of a pure question of science, omitting all personal considerations. It would have been infinitely more grateful to my feelings to have been able to express my concurrence in these doctrines, (as, indeed, I was at one time much disposed to do,) than to have found myself compelled by regard to truth to refuse assent to his claims to original discovery as well as to his hypothesis, and even to the accuracy of some of his experiments. The cause of science demands that views which are essentially unsound, but which from the urgency with which they continue to be put forward on various occasions and in various shapes, are in danger of being adopted by those who have no time nor opportunity to investigate them closely, should be exhibited in their real shape and purport by means of a careful and searching analysis. Having weighed them in this balance, I must confess that they have been found wanting.

* It would be unjust to a most able physiologist and pleasing writer, Mr. Grainger, not to state that he has contributed much to the distinct enunciation and apt illustration of this hypothesis. See his excellent work on the Spinal Cord. Lond. 1837.

2. A second hypothesis is that which accords with the views of Müller and many other physiologists of the present day, and likewise probably with those of Whytt. It assumes that the fibres of sensation and volition proceed to and from some part or parts of the intracranial nervous mass,—that every nerve-fibre in the body is continued into the brain. Those which are distributed to the trunk and extremities pass along the spinal cord, separating from it with the various roots of the nerves, and in their course within the spine mingling more or less with the vesicular matter of the cord. There are, according to this hypothesis, no other fibres but these, (save the commissural,) and they are sufficient to manifest the physical as well as the mental acts. Nerves of sensation are capable of exciting nerves of motion which are in their vicinity; and they may produce this effect even when the spinal cord has been severed from the brain, for their relation to the grey matter of the cord is such that their state of excitement is readily conveyed to it.

3. According to a third hypothesis, it is assumed that all the spinal and encephalic nerves, of whatever function, are implanted in the grey matter of the segments of the cerebro-spinal centre with which they are severally connected, and *do not pass* beyond them. The several segments of the cerebro-spinal axis are connected with each other through the continuity of the grey matter from one to another, and through the medium of commissural fibres which pass between them. Through these means, motor or sensitive impulses may be propagated from segment to segment; and a stimulus conveyed to any segment from the periphery may either simultaneously affect the brain and cause a sensation, or it may be reflected upon the motor nerves of that segment and stimulate their muscles to contract. Or both these effects may take place at the same moment, as a result of one and the same stimulus. According to this hypothesis, each segment of the cord, so long as it retains its proper commissural connection with the brain (by commissural fibres and continuous grey matter), is part and parcel of the centre of volition as well as of that of sensation, and the mind is as directly associated with each segment of the cord as it is with any portion of the encephalon. Let that commissural connection be dissolved, and the mind will immediately lose its hold upon the cord; but the various segments of that organ may nevertheless still be acted upon by physical impulses, and may still continue to evolve the nervous force in connection with the natural changes which may take place within.

I am not aware that this view of the mechanism of the various actions of the nervous system had been ever distinctly enunciated before it had been stated by Mr. Bowman and myself in our work on the *Physiological Anatomy and Physiology of Man*, in 1845.* There is nothing, however, in this hypothesis at variance or inconsistent with the views of

Prochaska; for this physiologist seems to have held the opinion that the nerves are implanted in the segment of the cerebro-spinal axis into which they sink, and do not pass beyond it.

I shall now examine into the merits of each of these hypotheses, and, first, of the excitomotor hypothesis.

It is unnecessary to repeat the objections already stated (p. 721B) to the use of the term *excito-motory*. I shall only remark that some of these objections are equally opposed to the hypothesis as to its name.

Nevertheless this hypothesis has much to commend it: and not the least argument in its favour is that drawn from the compound nature of spinal nerves, as proved by Bell, in which nerve-fibres of different endowments are bound together in the same sheath. If it be proved (as it has been) that fibres of sensation and of motion may be thus placed in juxtaposition in the same nervous trunk, it seems not an unreasonable conjecture that fibres of other function (*excitators* and their corresponding *motors*) might be enclosed in the same sheath with them.

Both anatomy and experiment, however, unite to prove the existence of sensitive fibres distinct from motor fibres; they are found separate in the roots of the nerves, and combined in the nervous cords: but neither anatomy nor experiment favours the existence of a distinct series of excitator and of corresponding motor nerves. Anatomical research affords not the slightest indication of such a series of nerves. And experiments on the roots of the nerves, where it might reasonably be expected that the excitators would be separated from the motors (following the analogy of the motor and sensitive fibres), are by no means favourable to the existence of such fibres in the roots. The failure of experimenters to excite motion by irritation of the posterior roots of the spinal nerves has been already referred to. A new and extensive series of experiments is much needed to settle this question. I would remark that galvanism should not be used in them, as the results of stimulation by that agent are extremely fallacious, from its liability to extend beyond the parts included between the electrodes.

Other very serious anatomical objections may be urged to this hypothesis. It supposes the existence of two sets of fibres in the spinal cord. Evidence in favour of these is wanting just as much as in favour of those in the roots of the nerves. Many facts favour the conclusion that the fibres which constitute the roots of the nerves of any segment of the cerebro-spinal centre are implanted in the grey matter of that segment, and that none of them are continued beyond that segment up into the brain. They penetrate the spinal cord more or less obliquely, and form their connection with the grey matter a little higher up than the point of penetration; but there is no evidence to show that they assume a completely vertical direction to pass up to the brain.

The form and varying dimensions of the spinal cord in its several regions are opposed to this view. If the sensori-volitional fibres are

* The *Physiological Anatomy and Physiology of Man*, by R. B. Todd and Wm. Bowman, vol. i. p. 323.

all continued up into the brain, and the (so-called) excito-motor fibres are implanted in the cord, that segment of the cord should be the largest in which the greatest number of these fibres is to be found. Now the great extent of excitor surface in the lower extremities, the magnitude of their muscles, the importance of their movements, and, at the same time, the great development of reflex actions in them, would lead most reasonably to the expectation that the lumbar segment of the cord to which these nerves belong should exceed considerably in size the cervical segment which gives nerves to the upper extremities, where the excitor surface is of less extent, where the muscles are less powerful, and the reflex actions considerably less conspicuous. Moreover, the lumbar region of the cord would be, if Dr. Hall's views were correct, the centre of those excito-motor acts connected with defæcation, micturition, parturition, &c., of which he speaks so much, and on this account might fairly claim a greater amount of substance. But the fact is, that the lumbar swelling of the cord is smaller than the cervical; and that while it contains, and owes its bulk mainly to, a large quantity of vesicular matter, but a small proportion of fibrous matter is found in it. Moreover, it is impossible to understand the great superiority of size of the lumbar portion over the dorsal segment of the cord, if we are to admit that this latter segment contains in addition to its own fibres (sensori-volitional and excito-motory) the sensori-volitional fibres of the lumbar swelling also, which ought to be very numerous.

It is very generally admitted that the only channel by which the will can influence the spinal cord is through the fibres of the anterior pyramids of the medulla oblongata, the greater number of which decussate each other along the median line. But it is in the highest degree improbable that these fibres, occupying so small a space as they do, should form the aggregate of the volitional fibres (still less of the sensori-volitional fibres) of the trunk and extremities. The whole of these fibres (of *both* sides) collected together would scarcely equal in bulk the anterior portion of *one* of the antero-lateral columns of the spinal cord.

It has been affirmed that much support is given to the excito-motory hypothesis by Dr. Carpenter's and Mr. Newport's supposed demonstration of the two sets of fibres in the Articulata. But these observations are far from deserving the name of *demonstration*. The inferences from them are derived from the *apparent* direction of certain fibres, and not from any actual tracing of them by dissection or by microscopic inspection. The observations, too, have been made with low powers, which are very insufficient for determining the precise disposition of the fibres and their relation to the vesicular matter of the ganglia.

These writers affirm that the longitudinal fibres of the ganglionic chain of Articulata pass up to the brain and constitute the sensori-volitional fibres, whilst other fibres pass in a transverse direction and are implanted in the ganglia. Were this the case, it might reason-

ably be expected that the brain would be the largest of the ganglia as containing the sum of the sensori-volitional fibres of the whole body. But let any one compare the size of the cerebral ganglia of the scorpion (as figured by Mr. Newport*) with the size of the animal and that of its cord, and it will be evident to him how disproportionately small such a centre is to the number of sensori-volitional fibres which must be distributed over so large a surface and to so many muscles. Anatomy, however, offers no objection to the hypothesis that the roots of the nerves are implanted in the ganglia, and that the longitudinal fibres act as commissures between different segments (adjacent and remote) of the cord.

Neither do Mr. Newport's experiments on the myriapods and other Articulata throw any new light on the question of the existence of two orders of fibres; nor do they add anything to our knowledge beyond the important fact that actions take place in certain Invertebrata after decapitation, which are of the same nature with those which occur in Vertebrata after a similar mutilation. The *mechanism* of these actions has not been at all elucidated by these experiments.

The excito-motory hypothesis is sufficient for the explanation of the movements of decapitated animals, of parts in connection with small segments of the spinal cord, of limbs paralysed to sensation and voluntary motion from diseased brain or spinal cord. But there are two phenomena familiar to those who observe disease with care, which cannot be explained by it; these are the movements which may be excited by mental emotion in limbs paralysed to the influence of the will, and the total paralysis of the sphincter ani, which frequently accompanies diseased brain, whilst at the same time the limbs are only affected to a partial extent or not at all.

Cases occur sometimes in which hemiplegia arises from an apoplectic clot, or other destructive lesion in one hemisphere of the brain. The arm and leg, or either of them, are completely removed from the influence of the will; yet occasionally, as the effect of some sudden emotion, fear, joy, surprise, the paralysed limb is raised involuntarily. Even so slight a cause as yawning (an act of emotional kind) will excite the palsied limb. Every time the patient yawns the arm will be raised involuntarily.

Such phenomena as these receive no adequate explanation from the excito-motory hypothesis. Mental emotions probably affect some part of the brain; if the only communication between the brain and the limbs be by fibres of sensation and volition, it is impossible to understand how the emotional influence could be conveyed to them through a channel which has long been interrupted. If we are to adopt the excito-motory hypothesis, it will be necessary to suppose with Dr. Carpenter the existence of certain emotional fibres to explain the phenomena of this particular case. But it is difficult to admit the existence of three orders

* Phil. Trans. 1844.

of fibres in each muscle, which, to be effective, must have the same relation to the component elements of the muscle. It is impossible to imagine how each order of fibre should comport itself with reference to the other two, so that their actions may not interfere. Nor can any one fail to perceive that the emotional fibres must be infinitely less frequently employed than the others, and in some individuals so seldom called into action as to be greatly exposed to the risk of atrophy for want of use.

Another phenomenon, which this hypothesis fails to explain, is the paralysis of the sphincter ani muscle which accompanies certain lesions of the brain, generally of grave import. Such lesions are almost always accompanied by paralysis, chiefly of the hemiplegic kind, but not necessarily complete. On the contrary, in several such cases distinct reflex actions exist, indicating that, although the brain's influence is withheld from the limbs, that of the cord is not. If, then, the cord be sufficiently free from morbid depression to allow of reflex movements taking place in the inferior limbs, why is the sphincter ani (the actions of which according to Dr. Hall are eminently reflex) so completely paralysed that it offers not the slightest resistance to the introduction of the finger into the anus? So long as the cord is free from lesion and so capable of performing its functions that the lower limbs exhibit reflex movements, the sphincter ani muscle ought not to be paralysed, if the excito-motor hypothesis be true. For, admitting that this muscle has sensori-volitional fibres which are paralysed by the cerebral lesion, it should have excito-motor fibres likewise which ought to enable the muscle to resist the entrance of the finger into the rectum. Such resistance, however, it certainly does not make, for the muscle is completely paralysed in the cases referred to. And it is plain that, according to the excito-motory hypothesis, a cerebral lesion ought not to affect the sphincter ani further than to destroy the control of the will over it, unless the depressing influence of the lesion extend to the whole cord, and in such a case there ought to be complete paralysis of the limbs likewise.

In fine, it cannot be denied that the excito-motor hypothesis takes a narrow and confined view of that power of the nervous centres which it professes to elucidate. As I have before remarked, it limits this power to the excitation of motion, and it confines the exciting agency to nerves which naturally propagate *centrad*, and which only propagate such impressions as may excite movements.

Now it admits of unquestionable proof that impressions on sensitive nerves may, by a process of reflexion, excite other sensitive nerves. Are we to suppose the existence of a special series of fibres for such phenomena? Such a supposition would involve the most palpable contradictions, and is wholly inadmissible.

The second hypothesis, which accords with the views of Müller, is just as competent to explain the phenomena of decapitated animals, and of limbs paralysed to cerebral influence, as that of Dr. Hall. It receives considerable

support from the universal concurrence of sensation or mental perception with those normal actions which Dr. Hall would attribute to excito-motory fibres. If it be supposed that these fibres have a certain relation to the vesicular matter of the cord, there are as good grounds for the further supposition that they may continue to be affected by it after the brain has been separated from the cord. This hypothesis, however, is as inadequate as that of excito-motory fibres to explain the influence of emotion on paralysed limbs; and it likewise fails to explain the paralysis of the sphincter, which, under this hypothesis, ought to occur in every case of cerebral disease. The chief objection, however, to this hypothesis is anatomical; for it is far from being proved that the fibres of the spinal nerves are continued upwards through the cord into the brain. For instance, what evidence have we that the fibres of the lumbar region of the cord pass into the brain? The fibres of the anterior pyramids, no doubt, are true cerebro-spinal fibres, because they communicate equally with brain and cord, and distinctly pass from the one to the other; but it cannot be shown that they have any continuity with the fibres of any of the spinal nerves. Much less can it be shown that they contain the fibres which are continued up from, to say the least, the anterior roots of ALL the spinal nerves, which ought to be the case if this hypothesis be correct. The bulk of the pyramids is very much opposed to this view. It is most probable that the pyramids are *cerebro-spinal commissures*. The apparent longitudinal course of the fibres in the spinal cord affords no indication that they pass into the brain, for it is well known that many of the fibres forming the roots of spinal nerves take a very oblique course from their point of separation from the cord to their emergence from the spinal canal; and it is probable that this obliquity is continued in the cord itself, so that their real origin would be much higher up than their apparent one. This great length of oblique course gives to the fibre the appearance of being strictly longitudinal, whereas it may be implanted in the vesicular matter of the cord.

The third hypothesis is more consonant than either of the others with what appears to be the true anatomy of the spinal cord—namely, that each segment has its proper nerves implanted in it, that it is connected with adjacent segments by commissural fibres, and that the whole cord is connected with the cerebrum and cerebellum by commissural fibres; by the anterior pyramids and olivary columns with the former, and by the restiform bodies with the latter.

This hypothesis, the reader will bear in mind, assumes that mental and physical actions are performed through the same fibres—affected by a mental stimulus in the one case, and a physical stimulus in the other—the change produced by the physical stimulus being, in the case of reflex actions, reflected at the centre. The same *afferent* and *efferent* fibres are excited in the one case as in the other, the former acting as *sensitive* or *excitor*, or both; the latter as

channels for *voluntary, emotional, or strictly physical* impulses to motion.

The mechanism of a voluntary action in parts supplied by spinal nerves would be, according to this hypothesis, as follows:—The impulse of volition, excited primarily in the brain, acts at the same time upon the grey matter of the cord (its anterior horn), and through it upon the anterior roots of the nerves implanted in it. This grey matter, in virtue of its association with the brain by means of the anterior pyramids, becomes part and parcel of the organ of the will, and therefore as distinctly amenable to acts of the mind as that portion which is contained within the cranium. If we destroy the commissural connection with the brain through the pyramidal fibres, the spinal cord ceases to take part in mental nervous actions; or, if that connection be only partially destroyed, that portion of the cord which the injured fibres had associated with the brain is no longer influenced by the mind. Again, if the seat of volition in the brain be diseased, the cord or part of it participates in the effects of the disease as far as regards voluntary actions. That it is not too much to ascribe such power to the pyramidal fibres appears reasonable, if we consider how the fibres of the corpus callosum, and perhaps other transverse commissures, so connect the hemispheres and other parts of the brain that the separate divisions of a double organ act harmoniously so as to excite but a single train of thought, or, conversely, that two impressions from one and the same source on a double sentient organ are perceived as single by the mind.

An objection to this explanation will readily be raised—namely, that the excitation of the anterior horn of the grey matter, in the way stated, does not explain the remarkable power which the will has of *limiting* its action to one or two, or a particular class of muscles. To this, however, it may be replied that there can be no reason for denying to the mind the faculty of concentrating its action upon a particular series of the elementary parts of the vesicular matter, or even upon one or more vesicles, if we admit that it can direct its influence to one or more individual fibres, as the advocates of the first and second hypotheses do. If, indeed, we admit the one, we must admit the other; for whether the primary excitation of a fibre take place in the encephalon or in the spinal cord, the part first affected must probably be one or more vesicles of grey matter.

The series of changes which would develop a sensation admits of the following explanation according to this hypothesis:—A stimulus applied to some part of the trunk or extremities is propagated by the sensitive nerves to the *posterior* horn of the grey matter of the spinal cord, and from the junction of this part with the brain, either through the direct continuity of the vesicular matter of the cord with that of the centre of sensation, by the olivary column, or through longitudinal commissural fibres, analogous to or even forming a part of the anterior pyramids, this is simultaneously affected.

To this, likewise, it will be objected that the limitation of sensation is not sufficiently explained. But the reply is obvious; the *intensity* and *kind* of sensation depend upon the nature of the primary stimulus at the surface, the *extent* upon the number of fibres there stimulated. Wherever these fibres form their proper organic connection with the vesicular matter, that matter will participate in their change to an extent proportionate to the number of fibres stimulated, and with an intensity commensurate with the force of the primary stimulus. It is not necessary to the development of sensation that the fibre stimulated should be implanted directly in the brain; if it be connected with this centre through the medium of vesicular matter or through commissural fibres, all the conditions necessary for the development and propagation of nervous force would appear to be fulfilled. It must not be supposed, however, that in making this statement we mean to assign the spinal cord to be the *seat* of sensation; all we assert is, that the posterior horn of the grey matter, as being the part in which the sensitive roots are implanted, is the seat of physical change excited by the stimulus applied to the sensitive fibres, which change must be *perceived* by the mind before true sensation can be produced. In fine, by the union of the posterior horns of the spinal grey matter with the vesicular matter of the brain, they become a part of the centre of sensation so long as that union is unimpaired.*

This hypothesis offers an explanation of the hitherto unexplained phenomenon of impaired sensation on that side of the body which is opposite to the seat of cerebral lesion. If we regard the anterior pyramids as commissures between the sensitive as well as between the motor portions of the cerebro-spinal centre, it will be obvious that the posterior horns of the spinal grey matter on the right side will be associated with the left centre of sensation, and *vice versa*.

And we gain, moreover, an explanation of the almost universal association of sensation with reflex or physical nervous actions. The excitor nerves of these actions being the same as the sensitive nerves, the impression conveyed by them is calculated at once to excite motion and sensation. The controlling influence of the will prevents many of the sensitive impressions made through the spinal cord from developing corresponding movements. And this controlling influence is best explained by this hypothesis, for as it admits no other motor nerves connected with the cord but those over which the will can exert an influence, it follows that such mental influence, if more powerful than the physical stimulus which the sentient nerves convey, may prevail over it and neutralize its force. On the other hand, under certain conditions of great physical excitation, (exalted polarity,) physical changes overcome

* In all discussions relative to *sensation* it should be kept in view that true sensation involves a mental act, namely, the *perception* of a physical impression, and of the concomitant physical change in the nervous matter.

mental stimuli, and the mind loses all control; this is the case in poisoning by strychnine, in tetanus, in convulsions.

The difference of structure of the anterior and posterior horns of the vesicular matter of the spinal cord may be appropriately referred to as indicating a difference in functions between these horns. The anterior horns contain large caudate vesicles of a remarkable and peculiar kind, containing a considerable quantity of pigmentary matter; the posterior horns resemble very much in structure the vesicular matter of the cerebral convolutions and of other parts of the cerebrum, and do not contain caudate vesicles, except near the base. Here, then, we find associated with the well-attested difference in the *functions* of the anterior and posterior roots, a striking difference in the *structure* of the anterior and posterior horns of the spinal grey matter in which they are respectively implanted.

We gain from this hypothesis that which neither of the others could supply, namely, an explanation of the influence of emotion on limbs paralysed to volition. Mental emotion excites a change in the brain, probably in that part which forms the upper and posterior portion of the mesocephale: this change is readily propagated to the spinal grey matter through the olivary columns, independently of the pyramidal fibres. The spinal grey matter being excited, the nerves implanted in it are stimulated, and motions are produced closely resembling those which the will can develop.

We have noticed that the will can control reflex or other physical nervous actions. When the influence of the will is suspended, reflex actions may be more easily excited. These facts admit of the most obvious explanation by the hypothesis under examination.

Some reflex actions are imperfectly controllable by the will; such as the contraction of the pupil, and the movement of deglutition at the isthmus faucium. This, however, cannot be cited as at all opposed to the view we are advocating; for there is nothing in this hypothesis repugnant to the idea that certain nerves may be connected in the nervous centres with masses of vesicular matter over which the will usually exercises little or no control, and which, perhaps, may have but a slight connection with the centre of volition through commissural fibres. Still, respecting the two actions above-mentioned, it must be remarked that in deglutition the mental influence is not sufficient by itself: we cannot perfectly contract the fauces, if food or some other physical stimulus be not present; the double stimulus—physical, as of the food, and mental, the will—appears necessary for the perfect performance of this act. In the action of the pupil, the mental stimulus can only be brought to bear on the pupil, by directing it to another muscle at the same time, namely, the internal rectus muscle of the eyeball. When the eyeball is directed toward the nose, the pupil is usually simultaneously contracted.

A double stimulus, mental and physical, appears to be necessary to the perfect development of many actions. This hypothesis offers

a ready explanation of the way in which the two stimuli may combine to promote the same action. The mental stimulus acts directly on the vesicular matter, the physical is propagated to it by sensitive nerves; and thus both acting on the same region of vesicular matter excite the same motor nerves. We have already noticed how this takes place in deglutition at the isthmus faucium. In locomotion there can be no doubt that the double stimulus is in operation: the degree of contraction of the muscles of the lower extremities necessary to maintain the superincumbent weight is obtained by the physical stimulus of pressure against the soles of the feet, where the skin is peculiarly fitted for the reception of such a stimulus; but the movements of the limbs, and the harmonizing association of the muscular actions, are effected by mental influence. The pressure against the soles is felt, however, and the skin of the soles is known to be highly sensitive; and the same nerve-fibres which excite the sensation stimulate the vesicular matter in which the motor nerves are implanted. In many actions of familiar occurrence the voluntary effort is greatly enhanced by the simultaneous application of a physical stimulus to a part of the surface which is supplied with nerves from the same region of the cord. The horseman feels more secure when his legs are in close contact with the horse's flank. We gain a much firmer hold of an object which adapts itself well to the palmar surface of the hand, than of one which, although of no greater bulk, is yet so irregular in surface as not to allow of such intimate contact with the palm. Closure of the eyelids in winking is an action of similar kind, resulting from a physical stimulus, which in the perfect state of the cerebro-spinal centre produces sensation, and excites motion which is at once the result of the physical impression, and of the exercise of volition provoked by the sensation. Every one must be conscious that he exercises considerable control over the movements of his eyelids, and that it requires a great effort to prevent winking for a certain period. At length, however, the physical impression, arising from the contact of air with the conjunctiva, and the diminution of temperature from evaporation on the surface of that membrane, which at first caused but a slight sensation, produces *pain*; the physical stimulus overcomes the mental resistance, and causes contraction of the orbicular muscle. And it may be remarked further, that the closure of the lids by voluntary effort is much more powerful if a stimulus be applied at the same time to the conjunctival surface, than if left solely to the exercise of the will.

In the action just referred to, as well as in all other instances of reflex actions which the will can prevent, no satisfactory explanation of this controlling power of the mind can be given by Dr. Hall's hypothesis. Do the volitional fibres exceed in number the excito-motory? If this were admitted, then we could understand that an excito-motory act might be prevented by substituting a voluntary act for it; but, in the cases in question, the mind prevents action

altogether, notwithstanding the exciting influence of the impression. The true explanation seems to be, that the mind can exert upon the vesicular matter a power which can prevent the exercise of that change, or neutralise the change, without which the motor fibres will not be affected by a physical stimulus.

Reflex actions are more manifest in some situations than others: thus, in cases of hemiplegia from diseased brain, they are generally very obvious in the lower extremity, but totally absent in the upper. This, the advocates of the excito-motory theory ascribe to a paucity of excito-motory fibres in the latter limb, and to a larger amount of them in the former. Or, it has been attributed to the greater and more enduring influence of shock upon that segment of the cord from which the nerves of the upper extremities arise, as nearer the seat of lesion, than upon the lumbar segment. But another explanation of this important fact may be offered, which is equally satisfactory, and more accordant with other phenomena. A certain disposition of the nerves upon the tegumentary surface is as necessary for the development of reflex actions as of sensations; and these movements will be more or less easily manifested, according as this organization of the nerves on the surface is more or less perfect.

That disposition of the cutaneous nerves which renders the surface easily excitable by titillation seems most favourable to the development of these actions. Hence, there is no place where they are more readily excited than in the lower extremities by stimulating the soles of the feet or the intervals between the toes, both of which situations are highly susceptible of titillation. At the isthmus faucium the slightest touch on the surface excites a movement of deglutition; and this touch, at the same time, produces a very peculiar sensation of tickling, quite distinct from that which may be excited at other parts of the pharynx, or mouth. When this part of the mucous membrane is in a state of irritation as an effect of coryza, this tickling sensation is present, and repeated acts of swallowing are provoked.

Two facts may be stated here, which illustrate the position above laid down respecting the necessity of a certain disposition of the nerves on the tegumentary surface, for the development of reflex actions. The first is one which has been noticed by Volkmann, and which I have repeatedly observed, namely, that in frogs, and other animals, reflex actions are readily excited by stimulating the feet; but irritating the posterior roots of the spinal nerves, which supply those parts, is not sufficient for this purpose. I have already remarked that in numerous experiments upon the posterior roots of the nerves movements have not been excited whilst they have been subjected to irritation, except when galvanism was employed, which, being diffused, affected the cord itself: the recorded statements of most modern experimenters agree in the main with this statement. The second fact is this: in the male frog the development of a papillary structure on the skin of the thumb seems to have refe-

rence to the excitation of the physical power of the cord, to enable the animal to grasp the female without the necessity of a prolonged exercise of volition. Stimulating the fingers will scarcely produce reflex actions, but the slightest touch to the enlarged thumb will cause the animal to assume the attitude of grasping. If the papillæ be shaved off the thumb, its power of exciting these actions is instantly lost.

When the polarity of the cord is greatly excited by strychnine or other substances, or when tetanus exists, all parts of the surface are equally capable of exciting reflex actions. The least touch will cause them, not only in the limb touched, but in all that side of the trunk, or even throughout the whole body. So general is the excitation, that the least impression made on the peripheral extremity of a sensitive nerve in any part of the body is instantly converted into muscular spasm, more or less general. A slight current of air, in tetanus, is sufficient to excite general spasm. Müller remarks that, in such states of the cord, the reflex actions excited by stimulating the nerves themselves are much less than those produced by excitation of the surface.

The readiness with which a physical change, induced in one part of the centre, is propagated to others, whether above or below it, is due no doubt to the vesicular matter. An experiment made by Van Deen illustrates this statement. If, in an animal poisoned by strychnine, the cord be divided in its entire length along the median line, leaving only a slight bridge of grey matter, stimuli applied to any part of the surface will exhibit as extensive reactions as if the cord were entire. It is evident that the only medium of communication between the opposite halves must be the small portion of vesicular matter left undivided.

Impressions conveyed to the cord by the posterior roots of any of its nerves, may be reflected to the corresponding motor nerves, and cause movement, or may extend irregularly along the posterior horns of grey matter and stimulate the nerves implanted in them, and thus give rise to new sensations, which may be referred to other and even distant parts of the body or to new motions.

The hypothesis under consideration affords us an explanation, more satisfactory than any other, of the paralytic state of the sphincter ani in brain disease, already referred to, as well as in that of the spinal cord. This muscle is certainly chiefly under the influence of the will. In ordinary cases of diseased brain, where the lesion is confined to one side, the centre of volition is not sufficiently impaired to affect its influence upon the sphincter. In graver lesions, however, although the will may still continue to exert its control upon one side of the body, it loses its power over the sphincter, which is not excitable by any stimulus. In disease of the spinal cord, there is paralysis of the sphincters if the lesion involve a sufficient portion of the cord's substance, in whatever region of the cord it may exist. Even when the lesion is situate high up in the neck, or in the dorsal region, leaving

the lumbar portion perfectly whole, the sphincter will nevertheless be paralysed. In the former instances, the centre of volition in the cranium is diseased; in the latter, the defect consists in the destruction of the communication of the brain with that portion of the cord in which the nerves of the sphincter muscle are implanted.

An examination of the action of the sphincter will show, as has been already noticed, that the anus is kept closed ordinarily by the passive contraction of the muscle itself; but that its active contractions are mainly excited by voluntary influence, allowance being made for some slight action which may be produced by the stimulus of sudden distension, as in other circular muscles. Now, as a stimulus to sentient nerves constitutes no necessary part of any of these actions, it is probable that the motor nerves of the sphincter have little or no connection with the sentient ones; and, consequently, that muscle is not usually excitable to contraction by a stimulus applied to a sentient surface. Hence, whenever the influence of the will upon the lumbar portion of the cord is suspended, this muscle ceases to act, whether a mental or a physical stimulus be exerted.

We have remarked before that all that is shown by Dr. Hall's experiments on the horse and on the turtle is that the spinal cord influenced the sphincter only whilst it was in a state of irritation consequent upon its division. There probably was no real reflex action at all, and the closure of the anus on the application of a stimulus was probably only *apparently* due to that cause, frequent contractions taking place in the muscle in effect of the irritated state of the cord.

On the same principle, animals will exhibit movements of voluntary character for some time after decapitation, the continued irritation of the cord acting as a stimulus. A bird thus treated will fly for some distance, and with considerable energy, and will flap its wings if the cut surface of the cord be irritated. A fly decapitated pursues its course for some way immediately after the removal of the head; and Walckenaer observed a singular fact respecting the *Cerceris ornata*, a wasp which attacks a bee that inhabits holes: "at the moment that the insect was forcing its way into the hole of the bee, Walckenaer decapitated it; notwithstanding which, it continued its motions, and, when turned round, endeavoured to resume its position and enter the hole."* The change in the vesicular matter of the ganglia necessary for the movements of the wasp in pursuit of its prey, had already been excited by a powerful stimulus of volition, which continued even after the removal of the centre from which it had emanated. Actions at first voluntary, which by frequent repetition become habitual and involuntary, are, no doubt, to be accounted for by the persistence of that condition of the vesicular matter which the will at first induced, and to which the frequency of repetition gives a character of permanence. Thus Habit is due,

as it were, to the fixation of a certain state of vesicular matter—it is the conversion of a mental into a physical nervous action by frequent repetition.

So similar is the change which a physical stimulus can excite in the grey matter to that produced by the influence of the will, that, as has been often remarked, the actions excited in decapitated animals present a striking resemblance to the ordinary voluntary movements. When a certain portion of the skin is irritated, the animal pushes against the offending substance, as if trying to remove or displace it. If the anus be irritated, both legs are excited to action. It may also be observed, that the same motions follow the same irritations of the skin. If, in a frog, the seat of irritation be on the right side, the corresponding hind-foot will be raised, as if to remove the irritating cause. The exact resemblance of these to voluntary movements seems to admit of being explained only on the supposition that the same fibres are employed in the execution of both.

It must be kept in view, that, while this hypothesis rejects the class of sensori-volitional fibres which are supposed to pass with the spinal nerves along the cord into the brain, it admits the existence of only three orders of fibres implanted in the various segments of the cord, viz. those at once sensitive and excitator; those at once for voluntary and involuntary motion; and commissural fibres; of which the former only contribute to form the nerves. It must not be supposed, however, that it is intended by this hypothesis to assume that the intervention of *sensation* (*i. e.* the perception of an impression by the mind) is *necessary* for the production of those muscular actions which are excited by stimulation of the surface. No more is affirmed than that the same stimulus to the sensitive nerve which can and does excite a sensation, may *simultaneously*, but *independently*, cause a change in the vesicular matter which shall stimulate the motor nerves; and that this change is of the same kind as that which the will may excite, and affects the same motor nerves.

Lastly, this hypothesis involves the enunciation of a highly important proposition with reference to nervous centres. It is this: that all the centres which are connected to the brain by commissural fibres, are thereby submitted to, and brought into connection with, the mind, to an extent proportionate to the number of connecting fibres, so that voluntary impulses act upon them as part and parcel of the centre of volition; and sensitive impressions, in affecting them, affect the mind simultaneously.

In voluntary actions, then, it may be stated that, while the brain is the part primarily affected, the mental impulse is also directed to that portion of the cord upon which the required action depends.

In the development of sensation the stimulus affects the posterior horns of the grey matter of the cord, which, from its commissural connection with the brain, is in reality a part of the sensorium. When the power of mental

* Quoted in Müller's Physiology, by Baly, vol. i. p. 787*, 2nd ed.

interference is removed, or kept under control, physical actions develop themselves; being effected through the same nerves as those which volition influences or which sensitive impressions affect. The latter are, in such instances, the excitors of the former, no doubt through the vesicular matter in which they are implanted. These actions become most manifest when the connection of the brain with the spinal cord has been severed; and they occur in the most marked way in those situations where the cutaneous nerves are so organized as readily to respond to the application of a stimulus applied to the surface, or they become universal when the cord is in a state of general excitement.

The movements in locomotion and the maintenance of the various attitudes are effected through the ordinary channels of the physical and volitional actions; and the posterior columns of the cord, by their influence on the vesicular matter of the segments in which the nerves are implanted, co-ordinate and harmonize the complicated muscular actions of the limbs and the trunk under the controul of that portion of the encephalon which probably is devoted to that purpose. This power of co-ordination is probably mental, and intimately connected with the muscular sense.

FUNCTIONS OF THE ENCEPHALON. — It will be convenient first to examine the functions of those parts of the encephalon which in structure most nearly resemble the spinal cord.

Functions of the medulla oblongata, mesocephale, corpora striata, and optic thalami.— The medulla oblongata most nearly resembles the cord in form and structure, at the same time that it exhibits most marked and important differences from it. Its subdivisions form connections superiorly with other parts of the brain, namely, the mesocephale, corpora striata, and optic thalami. These connections are so intimate, that, however convenient it may be to the descriptive anatomist to describe these parts each by itself, it is impossible, in examining into their functions, to separate them completely. The functions of one part are so readily affected by a change in any or all of the others, that the effects of experiments are not limited only to the part operated upon, but affect or are affected by the rest. Thus, the olivary columns, which form the central and most essential part of the medulla oblongata, extend upwards through the mesocephale to the optic thalami; and the anterior pyramids form an intimate connection not only with the vesicular matter of the mesocephale, but, to a great extent, with that of the corpora striata. All these parts taken together, with the quadrigeminal tubercles, will be found to be the centre of the principal mental nervous actions, and of certain physical actions which are very essential to the integrity of the economy.

The office of the nerves which arise from this segment of the encephalon throws light upon its function. These nerves are partly destined for respiration, partly for deglutition, and partly also for acts of volition and sensation.

Destruction of the medulla oblongata is followed by the immediate cessation of the phenomena of respiration; and this takes place whether it be simply divided, or completely removed. When an animal is pithed, he falls down apparently senseless, and exhibiting only such convulsive movements as may be due to the irritation of the medulla by the section, or such reflex actions as may be excited by the application of a stimulus to some part of the trunk.

If, in an animal which breathes without a diaphragm, as in a bird or reptile, the spinal cord be gradually removed in successive portions, proceeding from below, up to within a short distance of the medulla oblongata, loss of motor and sensitive power takes place successively in the segments of the body with which the removed portions of the cord were connected. But the animal still retains its power of perceiving impressions made on those parts of the body which preserve their nervous connection with the medulla oblongata, and continues to exercise voluntary control over the movements of those parts. The movements of respiration go on, and deglutition is performed. The higher senses are unimpaired.*

These phenomena are sometimes observed in man—in such cases as that alluded to in a former page; where, from injury to the spinal cord in the neck, below the origin of the phrenic nerve, the patient appears as a living head with a dead trunk. The sensibility and motor power of the head are perfect; respiration goes on partially, and deglutition can be readily performed. The senses and the intellectual faculties remain for a time unimpaired.

Irritation of any part of the medulla oblongata excites convulsive movements in muscular parts which receive nerves from it, and, through the spinal cord, in the muscles of the trunk. Spasm of the glottis, difficulty of deglutition, irregular acts of breathing, result from irritation of the medulla oblongata; and, if the excitement be propagated to the cord, convulsions will become more or less general.

If a lesion affect one half of the medulla oblongata, does it produce convulsions or paralysis on the opposite side of the body? This question may be certainly answered in the affirmative, when the seat of the lesion is in the continuations of the columns of the medulla oblongata above the posterior margin of the pons. It is not so easily solved, however, when the disease is situate below the pons. The results of experiment on this subject are contradictory, owing probably to the extreme difficulty of limiting the injury inflicted to a portion of the medulla on one side; and those of Flourens are of no value for the decision of this question, as it appears that he injured chiefly the restiform bodies. Anatomy suggests that a lesion limited to either anterior pyramid would affect the *opposite* side of the trunk, for it is known that such an effect follows disease of the continuation of it in the mesocephale or *crus cerebri*; and that lesion limited to the posterior half of

* Flourens, p. 179.

the medulla on either side would affect the *same* side of the body, no decussation existing between the fibres of opposite restiform or posterior pyramidal bodies. The irritating or depressing influence of the lesion would probably be extended to the spinal grey matter of the same side.

That the medulla oblongata is the channel through which the operations of the brain are associated in voluntary actions with the spinal cord, is shewn by the fact that paralysis of all the muscles of the trunk follows the separation of the latter organ from the former. It seems not improbable that the centre of volition is connected with one of the gangliform bodies in which the columns of the medulla oblongata terminate above (the corpora striata), so that the column connected with each corpus striatum (the anterior pyramid) is well placed for conveying voluntary impulses downwards. When the cerebral hemispheres have been removed, as in Flourens' and in Magendie's experiments, the bird is thrown into a deep sleep, a state of stupefaction, and insensibility to surrounding objects. But as he can maintain his attitude, stand, walk when first propelled, fly if thrown into the air, it may be inferred that some degree at least of mental or volitional effort remains. Some of the animal's movements have the appearance of the exercise of will, although, doubtless, many of them are in a great degree excited by physical stimuli. In my instance, in particular, what I have noticed in my own repetition of Flourens' experiments, a peculiar movement of the head, as if the bird were trying to shake off some object which irritated the head, and a frequent opening and shutting the bill, with movements of deglutition. Hence there seems reason to believe that the will may be exercised independently of the cerebral convolutions and their fibres, and that, under all circumstances, it exerts a primary influence upon either or both of these gangliform bodies, more vigorous when aided and guided by the power of the cerebral hemispheres. The frequent paralysis of motion apart from sensation, when the upward continuations of the pyramidal fibres in the corpora striata are diseased, renders it extremely probable that these fibres are the media of connection between the brain and cord in voluntary actions.

The medulla oblongata is also the medium for the transmission of sensitive impressions from all the regions of the head, trunk, and extremities; and from its olivary columns at their upper and posterior part in the mesocephale being, as it were, the concourse of all the nerves of pure sense, it seems fair to assign these parts as the prime seat of those central impressions which are necessary for sensation. The reception of these impressions by the cerebral hemispheres is the stage immediately associated with mental perception. Perfect sensation, therefore, cannot take place without cerebral hemispheres. In a sensation excited in parts supplied by spinal nerves, the first central change is probably in the posterior horn of the vesicular matter of the

cord; and the olivary column of the medulla oblongata is simultaneously affected, from its connection with the cord. The change in this latter part is then propagated to the cerebral hemispheres.

Thus much is suggested by anatomy, as regards the share which the medulla oblongata takes in the mechanism of sensitive impressions. Experiment affords us no aid in this intricate and difficult subject; neither does pathological anatomy: for the parts are so closely associated with each other, that any morbid state of one readily involves the others, so that it is almost impossible to find a morbid state of the parts devoted to sensation, apart from an affection of those more immediately concerned in motion.

The function of the restiform bodies is probably associated with that of the hemispheres of the cerebellum, and of the posterior columns of the spinal cord.

The experiments of Le Gallois and Flourens make it certain that the medulla oblongata is the centre of respiratory movements. The latter physiologist assigns as the "primum movens" of these acts all that portion of the medulla which extends from the filaments of origin of the vagus nerve to the tubercula quadrigena, the former only inclusive. Destruction of this portion, in whole or in part, invariably impairs or destroys the respiratory actions, and a morbid state of it gives rise to irregular or excited movements of respiration. Sighing, yawning, coughing, are probably connected with excitation of this centre, either direct, or propagated to it from some sentient surface. It seems not improbable that a portion of the spinal cord as low down as the spinal accessory nerve goes, is associated with this centre in the respiratory movements.

This portion of the encephalon is also the centre of action in the movements of deglutition, through fibres of the glosso-pharyngeal and vagi nerves. A morbid state of it occasions difficulty, or even paralysis, of deglutition. Animals deprived of the cerebral hemispheres and cerebellum will preserve the power of swallowing food introduced within the grasp of the fauces, so long as the medulla oblongata continues uninjured. In fœtuses born without cerebral hemispheres, those actions are present which depend on the spinal cord and medulla oblongata; all the movements of respiration and deglutition are performed as well as in the perfect fœtus. Mr. Grainger's experiments shew that puppies deprived of the hemispheres of the brain can perform the movements of suction with considerable vigour, when the finger is introduced into the mouth;* and the remarkable fact of the adhesion of the fœtus of the kangaroo to the nipple within the pouch, no less than its respiratory movements, must, as this author remarks, be regarded as a most interesting display of the physical power of the medulla oblongata, while the rest of the brain is as yet undeveloped.

The actions of respiration and pharyngeal

* Loc. cit. pp. 80-1.

deglutition are, to a great extent, of the physical kind, being excited by impressions propagated from the periphery. In those of respiration, the ordinary exciting cause is probably, as Dr. Hall suggested, due to the chemical changes in the respired air which are effected in the lungs. These movements may be, to a certain extent, controlled by the will; but every one is conscious, from his own sensations, that after a time the physical stimulus is capable of conquering the restraining influence of the mind; a striking example of a mental stimulus giving way to a physical one, and illustrative of the doctrine that the same fibres are affected by both stimuli. The excitation of the medulla oblongata in respiration does not, however, depend solely upon the pulmonary nerves. Those of the skin are capable of exciting it, either directly as the fifth pair, or through the spinal cord, as is proved by the inspirations which are instantly excited by suddenly dashing cold water on the face or trunk.

In deglutition, the exciting cause is the stimulus of contact applied to the mucous membrane of the fauces. So highly sensitive is the mucous membrane in this situation, that the slightest touch of it with a feather is sufficient to produce contraction of the muscles of deglutition, which the will is scarcely able to control. Without this stimulus, it is doubtful whether these muscles would obey the will alone, and it seems probable that this part of the act of deglutition must be regarded as one of those actions referred to at a former page, which require a double stimulus, both mental and physical, for their full performance.

The medulla oblongata and its continuations in the mesocephale appear to be the centre of those actions which are influenced by emotion. The common excitement of movements of deglutition or respiration, or of sensations referred to the throat, under the influence of emotion, evidently points to this part of the cerebrospinal centre as being very prone to obey such impulses; and as the nerves of pure sense, especially the optic and auditory, are very commonly the channels of sensitive impressions well calculated to arouse the feelings, it seems highly probable that the centre of such actions should be contiguous to the origin of these nerves. This office may be assigned to that region of the mesocephale which is in the vicinity of the quadrigeminal tubercles. It is not a little remarkable that the nerves which arise from this and the neighbouring parts are very readily influenced by emotions. Thus, the third and fourth pairs of nerves regulate the principal movements of the eyeballs, those especially which most quickly betray emotional excitement; and the portio dura of the seventh pair, the motor nerve of the face, is the medium through which changes of the countenance are effected. It may be added, that the centre of emotional actions ought to be so situated that it might readily communicate with the centres of all the voluntary actions of the body, and with the immediate seat of the intellectual operations, as well as with the

nerves of pure sense; and no part possesses these relations so completely as that now under examination.

In those diseases which mental emotion is apt to give rise to, many of the symptoms are referable to affection of the medulla oblongata. In hysteria, the globus, or peculiar sense of suffocation or constriction about the fauces; in chorea, the difficulty of deglutition, the peculiar movement of the tongue, the excited state of the countenance, the difficulty of articulation, may be attributed to the exalted polarity of the centre of emotional actions. In hydrophobia this part is probably always affected, and frequently so in tetanus.

Certain gangliform bodies are connected with the upward continuations of the medulla oblongata, both in the brain and in the mesocephale, which doubtless have proper functions. These are the corpora striata, optic thalami, and quadrigeminal bodies.

Corpora striata.—The anatomy of the corpora striata and optic thalami, while it denotes a very intimate union between them, also shows so manifest a difference in their structural characters, that it cannot be doubted that they perform essentially different functions. In the corpora striata the fibrous matter is arranged in distinct fascicles of various sizes, many, if not all of which, form a special connection with its vesicular matter. In the optic thalami, on the other hand, the fibrous matter forms a very intricate interlacement, which is equally complicated at every part. Innumerable fibres pass from one to the other, and both are connected to the hemispheres by extensive radiations of fibrous matter. The corpora striata, however, are connected chiefly, if not solely, with the inferior fibrous layer of each crus cerebri; whilst the optic thalami are continuous with the superior part of each crus, which is situate above the locus niger.

It will be observed, then, that while these bodies possess, as a principal character in common, an extensive connection with the convoluted surface of the brain, they are, in the most marked way, connected inferiorly with separate and distinct portions of the medulla oblongata; the corpora striata with the inferior fibrous planes of the crura cerebri and their continuations, the anterior pyramids; and the optic thalami with the olivary columns, the central and probably fundamental portions of the medulla oblongata. This anatomical fact must be taken as an additional indication that these gangliform bodies perform separate functions.

Now, it may be inferred, from their connections with nerves chiefly of a sensitive kind, that the olivary columns, and the optic thalami, which are continuous with them, are chiefly concerned in the reception of sensitive impressions, which may principally have reference merely to informing the mind (so to speak), or partly to the excitation of motion, as in deglutition, respiration, &c. The posterior horns of the grey matter of the cord, either by their direct continuity with the olivary columns, or their union with these columns through commissural fibres, become part and parcel of a

great centre of sensation, whether for mental or physical actions.

The pyramidal bodies evidently connect the grey matter of the cord (its anterior horns?) with the corpora striata; and not only these, but also the intervening masses of vesicular matter, such as the locus niger, and the vesicular matter of the pons, and of the olivary columns; and, supposing the corpora striata to be centres of volition in intimate connection with the convoluted surface of the brain by their numerous radiations, all these several parts are linked together for the common purposes of volition, and constitute a great centre of voluntary actions, amenable to the influence of the will at every point.

It has been pretty generally admitted by anatomists, that both the corpora striata and the anterior pyramids are concerned in voluntary movements. The motor tracts of Bell were regarded by that physiologist as passing upwards from the anterior columns of the cord to the corpora striata, and, after traversing those bodies, as diverging into the fibrous matter of the hemispheres; and the fact of the origin of certain motor nerves, in connection with those fibres, was considered to be very favourable to this view. The decussation of the pyramids, likewise, so illustrative of the cross influence of the brain in lesions sufficient to produce paralysis, has been looked upon as an additional indication of the motor influence of these parts.

The invariable occurrence of paralysis as the result of lesion, even of slight amount, in the corpora striata, must be regarded as a fact of strong import in reference to the motor functions of these bodies.

Nor is this fact at all incompatible with the statements made by all experimenters, that simple section of the corpus striatum does not occasion either marked paralysis or convulsion; and that in cutting away the different segments of the brain, beginning with the hemispheres, convulsions are not excited until the region of the mesocephale is involved. The influence of the corpora striata is not upon the nerves *directly*, but upon the segments of the medulla oblongata or of the spinal cord, and, through them, upon the nerves which arise from them. Were the nerve-fibres continued up into the corpora striata, according to an opinion which has been long prevalent, there would be no good reason for supposing that they should lose in the brain that excitability to physical stimuli which they are known to possess in the spinal cord, and at their peripheral distribution.

The latest experiments of this kind, which are those of Longet and Lafargue, agree in the following result, which is not at variance with that obtained by Flourens. The animals remain immovable after the removal of the corpora striata, whether those bodies have been removed alone or in conjunction with the hemispheres; nor do they show any disposition to move, unless strongly excited by some external stimulus. None of these observers had noticed the irresistible tendency to rapid propulsion, which was described by Magendie. Removal of the

corpus striatum of one side caused weakness of the opposite side.

In order to form a due estimate of these experiments, it must be borne in mind, that the effects of simple excision of either corpus striatum would be very different from those of disease of it. The depressing effects of the latter would be absent, at least, until some alteration in the process of nutrition had been set up in the mutilated parts. Simple excision of the centre of volition, and inflammatory disease of its substance, or an apoplectic clot, must produce essentially different effects;—the one simply cuts off the influence of the will, the other affects the vital action, and, consequently, the vital power of the centre, and of the commissural fibres connected with it.

Judging from structure only, it might be conjectured that the *locus niger*, that remarkable mass of vesicular matter which separates the anterior and posterior planes of each crus cerebri, exerts a motor influence. It resembles in structure the anterior horns of the grey matter of the cord, and contains numerous large caudate vesicles with very abundant pigment, and is the immediate centre of implantation of a very important motor nerve, the third pair, which regulates the movements of nearly all the muscles of the eyeball.

Optic thalami.—The same line of argument which leads us to view the corpora striata as the more essential parts of the nervous apparatus which controul direct voluntary movements, suggests that the optic thalami may be viewed as the principal foci of sensibility, without which the mind could not perceive the physical change resulting from a sensitive impression.

The principal anatomical fact which favours this conclusion is the connection of all the nerves of pure sense, more or less directly, with the optic thalami or with the olivary columns. The olfactory processes, which apparently have no connection with them, form, no doubt, through the fornix, such an union with them, as readily to bring them within the influence of the olfactory nerves.

According to this sense of its office we must regard the optic thalami as the upper and chief portions of an extended centre, of which the lower part is formed by the olivary columns, which we have already referred to as taking part in the mechanism of sensation. The continuity of the olivary columns with the optic thalami justifies this view: nor is it invalidated by the fact, that some of the nerves which arise from the medulla oblongata are motor in function; for Stilling's researches render it probable that these fibres have their origin in special accumulations of vesicular matter, which contain caudate vesicles of the same kind as those found in the anterior horns of the grey matter of the cord.

The results which experiments have yielded add little that is positive to our knowledge of the functions of these bodies. Flourens found that neither pricking nor cutting away the optic thalami by successive slices occasioned any muscular agitation, nor did it even induce con-

traction of the pupils. Longet found that removal of one optic thalamus in the rabbit was followed by paralysis on the opposite side of the body. It appears, however, that this was done after the removal of the hemisphere and corpus striatum, whereby the experiment was so complicated as to invalidate any conclusion that might be drawn from it respecting the function of the thalamus. Indeed, vivisections upon so complex an organ as the brain are ill-calculated to lead to useful or satisfactory results; but one does not hesitate to refer to such as have been made, because they afford a certain amount of negative information, imperfect though it be.

Nothing definitive respecting the proper office of the thalami can be obtained from pathological anatomy. Extensive disease of these bodies is attended with the same phenomena during life, as lesion of similar kind in the corpora striata. Hemiplegic paralysis accompanies both; nor does it appear that sensation is more impaired when the thalamus is diseased, than when the corpus striatum is affected.

There is nothing in the phenomena attendant on morbid states of the thalami which can be fairly regarded as opposed to the conclusion which their anatomical relations indicate, namely, that they form a principal part of the centre of sensation. The intimate connection between the striated bodies and the thalami sufficiently explains the paralysis of motion which follows disease of the latter; whilst, as the thalami do not constitute the *whole centre* of sensation, but only a part thereof, it cannot be expected that lesion of this *part* would destroy sensation, so long as the remainder of the centre on the same side, as well as that of the opposite side, retain their integrity. Complete paralysis of sensation on one side is very rare in diseased brain: a slight impairment of it frequently exists in the early periods of cerebral lesion, apparently as an effect of shock; for it quickly subsides, although the motor power may never return.

According to the views above expressed, the corpora striata and optic thalami bear to each other a relation analogous to that of the anterior to the posterior horn of the spinal grey matter. The corpora striata and anterior horns are centres of motion; the optic thalami and posterior horns, centres of sensation. The anterior pyramids connect the former; the olivary columns, and perhaps some fibres of the anterior pyramids, the latter. The olivary columns, however, are in great part continuations of the thalami on the one hand, and of the grey matter of the cord on the other; and contain abundance of vesicular matter, in which nerves are implanted.

And it must be admitted that the intimate connection of sensation and motion, whereby sensation becomes a frequent excitor of motion,—and voluntary motion is always, in a state of health, attended with sensation,—would *a priori* lead us to look for the respective centres of these two great faculties, not only in juxta-position, but in union at least as intimate as that which exists between the corpus

striatum and optic thalamus, or between the anterior and the posterior horns of the spinal grey matter.

Saucerotte, Foville, Pinel Grandchamps, and others, advanced the opinion that the corpora striata and the fibrous substance of the anterior lobes of the brain had a special influence upon the motions of the lower extremities, and that the optic thalami and the fibrous substance of the middle and posterior part of the brain presided over the movements of the upper extremities. We find, however, but little to favour this theory either in the results of experiments, in pathological observation, or the anatomy of the parts. Longet states, that, in his experiments upon the optic thalami, the paralysis affected equally the anterior and the posterior extremities. Andral analysed seventy-five cases of cerebral lesion limited to the corpus striatum or optic thalamus. In twenty-three of these cases, the paralysis was confined to the upper extremity: of these, *eleven* were affected with lesion of the corpus striatum or of the anterior lobe; *ten* with lesion of the posterior lobe, or of the optic thalamus; and *two* with lesion of the middle lobe.* Hence it is plain that a diseased state of the corpus striatum is as apt to induce paralysis of the upper extremity as lesion of the thalamus; and we are forced to conclude, that pathological anatomy is not competent to decide the question. Lastly, the anatomy of these two bodies renders it highly improbable that they perform a function so similar, as that of directing the movements of particular limbs. The great size of the optic thalamus, its multitude of fibrous radiations, its extensive connections both in the medulla oblongata and in the hemispheres by means of commissural fibres, the marked difference of its structure from that of the corpus striatum, its connection more with the posterior horns of the spinal grey matter than with the anterior ones, and its intimate relation to nerves of sensation, are sufficient anatomical facts to warrant the opinion that the thalami must perform a function which, although it may be subservient to, or associated with, that of the striated bodies, is yet entirely dissimilar in kind.

It has been supposed that the corpora striata are special centres or ganglia to the olfactory nerves, and to the sense of smell. But such a supposition is altogether superfluous, inasmuch as a very distinct and obvious centre to these nerves exists in the olfactory process or lobe, miscalled *nerve* by descriptive anatomists. The small olfactory nerves are implanted in the anterior extremity or bulb of this process, which is provided with all the structural characters of a nervous centre, and contains a ventricle. This lobe, moreover, is always developed in the direct ratio of the size and number of the olfactory nerves, and of the development of the sense of smell; and in the Cetacea, a class in which the olfactory nerves and process either do not exist at all, or are so imperfectly developed as to have

* Clin. Med. t. v.

escaped the notice of some of the ablest anatomists, the corpora striata are of good size proportionally to that of the entire brain.

Corpora quadrigemina.—The marked connection of these gangliform bodies with the optic nerves plainly indicates that they bear some special relation to those nerves, and to the sense of vision; and this indication becomes more certain when we learn, from comparative anatomy, that in all vertebrate tribes in which the encephalon is developed, special lobes exist, bearing a similar relation to the optic nerves. When the optic nerves are large, these lobes are large; and in the Pleuronecta, in which the eyes are of unequal size, Gottsche states that the optic lobes are unequal, and are related in size to each other, as the eyeballs are. Still, as Serres has remarked, the quadrigeminal tubercles probably perform some other office besides that which refers to vision; inasmuch as the absence, or extremely diminutive size, of the optic nerves in some animals (the mole for instance) does not materially affect that of these bodies.*

Flourens found that destruction of either of these tubercles on one side was followed by loss of sight of the opposite side, and consequently that the removal of both deprived the animal altogether of the power of vision, but did not affect its locomotive or intellectual powers, nor its sensibility, except to light. In these experiments the action of the iris was not impaired if the tubercles were only partially removed; as long as any portion of the roots of the optic nerves remained uninjured, the iris continued to respond to the stimulus of light, but the total removal of the tubercles paralysed the irides. If the lobes of the brain and cerebellum were removed, leaving the tubercles untouched, the irides would continue to contract. These experiments leave no room to doubt that the optic tubercles are the encephalic recipients of the impressions necessary to vision, which doubtless are simultaneously felt by means of the optic thalami; and that they are the centres of those movements of the iris which contribute largely not only to protect the retina, but likewise to increase the perfection of vision. The optic nerve is at once the nerve of vision, and the excitator of motor impulses which are conveyed to the iris by the third nerve, which takes its origin very near to the optic tubercles. It is interesting to add, that irritation of an optic tubercle on one side causes contraction of both irides:—this is quite in accordance with the well-established fact, that, if light be admitted to one eye so as to cause contraction of its pupil, the other pupil will contract at the same time. So simultaneous is the action of the two centres; so rapid must be the transmission of the stimulus from one side to the other.

When the injuries inflicted on these tubercles were deep, more or less general convulsive movements were produced; if one tubercle were injured, the opposite side only was so affected. These convulsions were due to the

lesion of the central parts of the medulla oblongata, with which the optic tubercles are intimately connected. A remarkable vertiginous movement was likewise caused, the animal turning to the side from which the tubercle had been removed. It does not appear that this rotation could be attributed to any special influence of the medulla oblongata, but rather to a state of vertigo induced by the partial destruction of vision; for Flourens found that the same effects could be produced in pigeons by blindfolding one eye. The movements, however, were not so rapid, nor did they continue so long. And Longet saw the same movements in pigeons in which he had evacuated the humours of one eye.*

It may be remarked, that deep injuries to the quadrigeminal tubercles are very likely to affect the only commissural connection between the cerebrum and cerebellum (*processus cerebelli ad testes*), the integrity of which must doubtless be essentially necessary to ensure harmony of action between these two great nervous centres.

There are many instances on record in which blindness was coincident with pathological alteration of structure in one or both quadrigeminal tubercles. In some of the cases where the lesion extended to parts seated beneath the tubercles, disturbed movements were observed, as in the experiments above related.

We are ignorant of the object of the extensive connections of the optic tracts with the tuber cinereum, the crura cerebri, and the corpora geniculata; but these points are highly worthy of future inquiry, especially with reference to the office of these last-named bodies, which is at present involved in much obscurity. Many of the fibres of the optic tracts are undoubtedly commissural between the corresponding points of opposite sides, and exist when those which form the optic nerves are deficient.

We see, then, in the quadrigeminal tubercles, centres, which, whatever other functions they may perform, have a sufficiently obvious relation to the optic nerves, the eye, and the sense of vision. This is clearly indicated by anatomical facts, especially by those of comparative anatomy, by the results of experiment, and by the phenomena of disease. These bodies may, therefore, be justly reckoned as special ganglia of vision; and we are led to seek for similar centres in connection with the other senses. The olfactory processes seem very probably to perform a similar office in reference to the sense of smell. Their structure, their relation to the olfactory nerves, and their direct proportion of bulk to that of these nerves, and to the development of the olfactory apparatus, place this question beyond all doubt. It is not so easy to determine the special ganglia of hearing; but the olivary bodies, or the small lobules connected with the crura cerebelli called by Reil *the flocks*, may be referred to as bearing a sufficient close anatomical relation to the

* Vid. OPTIC NERVES.

* Flourens' experiments have been amply confirmed by those of Hertwig and Longet.

auditory nerve to justify our regarding either of them as well calculated to perform this function. And, with respect to touch, the ganglia on the posterior roots of the spinal and the fifth nerves may perhaps be considered in the same light; for this sense being diffused so universally, in various degrees, over the whole surface of the body, and being seated in a great number of different nerves, would need ganglia in connection with all those nerves which are adapted to the reception of tactile impressions. The analogous sense of taste has its ganglia in those of the glosso-pharyngeal and the fifth.*

The upper and posterior part of the mesocephale has already been referred to, as being most probably that part of the brain which is most directly influenced by emotional excitement. Dr. Carpenter appears to localize the seat of emotional influence more specially in the corpora quadrigemina, and refers to certain fibres, which he considers terminate in those bodies, as channels of emotional impulses. Although I am compelled to differ from this able writer in this limitation of the centre of emotion (so to speak), and am far from admitting the existence of a distinct series of fibres for emotional acts, I nevertheless think that the arguments he advances are most applicable to that view which refers the influence of emotion to the grey matter of this entire region, which is brought into connection with the spinal cord by the fibres of the anterior pyramids, as well as probably through the continuity of the olivary columns and the posterior horns of the spinal grey matter.

Every one has experienced in his own person how the emotions of the mind, whether excited by a passing thought, or through the external senses, may occasion not only involuntary movements, but subjective sensations. The thrill which is felt throughout the entire frame when a feeling of horror or of joy is excited, or the involuntary shudder which the idea of imminent danger or of some serious hazard gives rise to, are phenomena of sensation and motion excited by emotion. The nerves which take their origin from the medulla oblongata, mesocephale, or crura cerebri, are especially apt to be affected by emotions. The choking sensation which accompanies grief is entirely referable to the pharyngeal branches of the glosso-pharyngeal and vagi nerves, which come from the olivary columns. The flow of tears which the sudden occurrence of joy or sorrow is apt to induce may be attributed to the influence of the fifth nerve, which is also implanted in the olivary columns, upon the lachrymal gland; or the fourth nerve, which anastomoses with the lachrymal branch of the fifth. The more

* It may be urged against this conjecture respecting the functions of the ganglia of the spinal nerves and the fifth, that the analogy between these bodies and the quadrigeminal tubercles is incomplete, inasmuch as the optic nerves are probably implanted in the latter, but the nerves of touch merely pass through the former. But, in truth, we know so little of the positive relation of the nerves in question to the ganglia, that no argument, either for or against the above view, can rest upon such imperfect information.

violent expressions of grief, sobbing, crying, denote an excited state of the whole centre of emotion, involving all the nerves which have connection with it, the portio dura, the fifth, the vagus, and glosso-pharyngeal; and even the respiratory nerves, which take their origin from the spinal cord, as the phrenic, spinal accessory, &c. And laughter, "holding both his sides," causes an analogous excitation of the same parts of the central organ and of the same nerves. The very different effect produced by the excitement of the same parts must be attributed to the different nature of the mental stimulus.

As the passing thought—the change wrought during the exercise of the intellect—may excite the centre of emotion, so this latter may exert its influence upon the general tenor of the mind, and give to all our thoughts the tinge of mirth or sadness, of hope or despondency, as one or the other may prevail. We say of one man, that he is constitutionally morose; of a second, that he is naturally gay and mirthful; and of a third, that he is a nervous man, and that he is never likely to be otherwise. One man allows his feelings to hurry him on to actions which his intellect condemns; whilst another has no difficulty in keeping all his feelings in entire subjection to his judgment. "Of two individuals with differently constituted minds," remarks Dr. Carpenter, "one shall judge of everything through the medium of a gloomy morose temper, which, like a darkened glass, represents to his judgment the whole world in league to injure him; and all his determinations, being based upon this erroneous view, exhibit the indications of it in his actions, which are themselves, nevertheless, of an entirely voluntary character. On the other hand, a person of a cheerful, benevolent disposition, looks at the world around as through a Claude-Lorraine glass, seeing everything in its brightest and sunniest aspect, and, with intellectual faculties precisely similar to those of the former individual, he will come to opposite conclusions: because the materials which form the basis of his judgment are submitted to it in a very different form."* Such examples abundantly illustrate the important share which the emotions take in the formation and development of character, and how all things presented to the mind through the senses may take their hue from the prevailing state of the feelings. If a certain part of the brain be associated with emotion, it is plain that that part must be in intimate connection with the seat of change in the operations of the intellect, in order that each may affect the other; that the former may prompt the latter, or the latter excite or hold in check the former. And this association of the emotions with a certain portion of the brain explains the influence of natural temperament, and of varying states of the physical health, upon the moral and intellectual condition of individuals. We may gather from it how necessary it is to a well-regulated mind that we should attend not to mental culture only,

* Carpenter's Physiology.

but to the vigour and health of the body also; that to ensure the full development of the *mens sana* we must secure the possession of the *corpus sanum*.

Certain diseases are evidently associated with disturbed or excited states of emotion. In such cases, the nerves most affected are those connected with the mesocephale and medulla oblongata, denoting an excited state of these portions of the encephalon. Of these diseases the most remarkable are *hysteria* and *chorea*; both of which may be induced either by a cause acting primarily upon the mind, or by functional disturbance of the body, as deranged assimilation, in persons of a certain character of constitution. In hysteria, the globus, the tendency to cry or laugh, the disturbed breathing, the variously deranged state of the respiratory acts, all denote affection of most, if not all, the nerves coming from these segments. In chorea the frequent movements of the face and eyes, the peculiar and very characteristic mode of protruding the tongue, the impaired power of articulation, are dependent on an altered state of that part in which the portio dura of the seventh pair, the third, fourth, and sixth, and the ninth nerves are implanted. In both diseases the principal central disturbance is in the mesocephale; and this may be caused either by the direct influence of the mind upon it, or by the propagation of a state of irritation to it from some part of the periphery. Choreia, even of the most violent and general kind, is very commonly produced by sudden fright; and it is well known how frequently mental anxiety or excitement develops the paroxysm of hysteria.

There is no part of the cerebro-spinal centre which appears to exercise such extensive sway over the movements and sensations of the body as this portion, the *mesocephale*, which may be regarded as the centre of emotional actions. Its influence extends upwards to the cerebral convolutions—backwards to the cerebellum—downwards to all the nerves of sensation and motion. Through its connection with the posterior horns of the spinal grey matter, it can excite the sensitive as well as the motor nerves of the trunk. Hence it is not to be wondered at that a highly disturbed state of this centre is capable of deranging all the sensitive as well as motor phenomena of the body and even the intellect. Hence we may explain the extraordinary movements in hydrophobia and general chorea, in both of which diseases this part of the nervous centre is doubtless affected. It has often been remarked how much more powerful are the voluntary actions when prompted by some strong emotion, than when excited only by an effort of the will. Rage, or despair, is able to magnify the power of the muscles to an incalculable degree. This may be due to the increased stimulus derived from the influence of the centre of emotion being conjoined with that of the centre of volition.

The intimate connection of the olivary columns with the grey matter of the cord, and through that with all the roots of the spinal nerves, illustrates the power of emotional

changes upon the organic processes. How often does the state of the feelings influence the quantity and quality of the secretions, no doubt through the power of the nerves over the capillary circulation! Blushing is produced through an affection of the mind, acting primarily on the centre of emotion, and through it on the nerves, which are distributed to the capillary vessels of the skin of the face.

The sexual passion must be ranked among the mental emotions. Like them, it may be excited and ministered to by a certain line of thought, or by particular physical states of the sexual organs. It seems, therefore, more correct to refer this emotion to the common centre of all, than to a special organ—according to Gall's theory; and it may be remarked, that great development of this part of the brain is just as likely to produce great width of cranium in the occipital region as a large cerebellum.

Of the functions of the cerebellum.—All anatomists are agreed in admitting, in the whole vertebrate series, (the amphioxus, perhaps, excepted,*) the existence of a portion of the encephalon which is analogous to the cerebellum. This extensive existence of such an organ indicates its great physiological importance, as a special element of the encephalon. The cerebellum exhibits much difference both as regards size and complexity of structure in the different classes; and although, upon the whole, it increases in its development in the same ratio as the hemispheric lobes, it exhibits no constant relation of size to those parts.

The large size and complicated structure of this organ in the higher vertebrate animals, and its distinctness from the cerebrum,—for its commissural connection with that segment of the encephalon is not extensive,—have excited the interest and curiosity of speculative physiologists; and, accordingly, we find no part respecting which a greater variety of hypotheses have been suggested, most of them being entirely devoid of foundation. The experiments of Flourens have, however, thrown more light on this subject than any previous observations; and his hypothesis appears nearer the truth than any which has been proposed.

The facility with which the cerebellum may be removed or injured, especially in birds, without involving the other segments of the brain, renders it a much more favourable object for direct experiment than them. A skilful operator may remove the greater part or the whole of the cerebellum without inflicting any injury on the hemispheres or other parts.

Flourens removed the cerebellum from pigeons by successive slices. During the removal of the superficial layers there appeared only a slight feebleness and want of harmony in the movements, without any expression of pain. On reaching the middle layers an almost universal agitation was manifested, without any sign of convulsion: the animal performed rapid and ill-regulated movements; it could hear and

* The observations of Quatrefages render it doubtful that even the amphioxus can be regarded as forming an exception. *Ann. des Sc. Nat.*, 1846.

sec. After the removal of the deepest layers, the animal lost completely the power of standing, walking, leaping, or flying. The power had been injured by the previous mutilations, but now it was completely gone. When placed upon his back, he was unable to rise. He did not, however, remain quiet and motionless, as pigeons deprived of the cerebral hemispheres do; but evinced an incessant restlessness, and an inability to accomplish any regular or definite movement. He could see the instrument raised to threaten him with a blow, and would make a thousand contortions to avoid it, but did not escape. Volition and sensation remained; the power of executing movements remained; but that of coordinating those movements into regular and combined actions was lost.

Animals deprived of the cerebellum are in a condition very similar to that of a drunken man, so far as relates to their power of locomotion. They are unable to produce that combination of action in different sets of muscles which is necessary to enable them to assume or maintain any attitudes. They cannot stand still for a moment; and, in attempting to walk, their gait is unsteady, they totter from side to side, and their progress is interrupted by frequent falls. The fruitless attempts which they make to stand or walk are sufficient proof that a certain degree of intelligence remains, and that voluntary power continues to be enjoyed.

Rolando had, previously to Flourens, observed effects of a similar nature consequent upon mutilation of the cerebellum. In none of his experiments was sensibility affected. The animal could see, but was unable to execute any of the movements necessary for locomotion.

Flourens' experiments have been confirmed by those of Hertwig in every particular, and they have been lately repeated with similar results by Budge and by Longet. The removal of part of the cerebellum appears capable of producing the same vertiginous affection which has been already noticed in the case of deep injuries to the mesocephale. After the well-known experiments of Magendie, of dividing either crus cerebelli, the animal was seen to roll over on its long axis towards the side on which the injury was inflicted.

The effects of injuries to the cerebellum, according to the reports of the experimenters above referred to, contrast in a very striking manner with those of the much more severe operation of removing the cerebral hemispheres. "Take two pigeons," says M. Longet; "from one remove completely the cerebral lobes, and from the other only half the cerebellum; the next day, the first will be firm upon his feet, the second will exhibit the unsteady and uncertain gait of drunkenness."

Experiment, then, appears strikingly to favour the conclusion which Flourens has drawn, namely, that the cerebellum possesses the power of coordinating the voluntary movements which originate in other parts of the cerebro-spinal centre, whether these movements have reference to locomotion or to other objects.

That this power is mental, *i. e.* dependent on a mental operation for its excitation and ex-

ercise, is rendered probable from the experience of our own sensations, and from the fact that the perfection of it requires practice. The voluntary movements of a new-born infant, although perfectly controllable by the will, are far from being coordinate: they are, on the contrary, remarkable for their vagueness and want of definition. Yet all the parts of the cerebro-spinal centre are well developed, except the cerebellum and the convolutions of the cerebrum. Now, the power of coordination improves earlier and more rapidly than the intellectual faculties; and we find, in accordance with Flourens' theory, that the cerebellum reaches its perfect development of form and structure at a much earlier period than the hemispheres of the cerebrum.

It may be stated as favourable to this view of the mental nature of the power by which voluntary movements are coordinated, that, in the first moments of life, provision is made for the perfect performance of all those acts which are of the physical kind. Thus, respiration and deglutition are as perfect in the new-born infant as in the full-grown man; and the excitability of the nervous centres to physical impressions is much greater at the early age, partly perhaps in consequence of the little interference which is received at that period from the will.

That the cerebellum is an organ favourably disposed for regulating and coordinating all the voluntary movements of the frame is very apparent from anatomical facts. No other part of the encephalon has such extensive connections with the cerebro-spinal axis. It is connected slightly indeed with the hemispheres of the brain, by the *processus cerebelli ad testes*, but most extensively with the mesocephale, the medulla oblongata, and the spinal cord. Now it is not unworthy of notice that its connection with the brain proper is more immediately with that part, which may be regarded as the centre of sensation; namely, with the optic thalami. This connection of the cerebellum with the centre of sensation may probably have for its object to bring the muscular sense to bear upon the coordination of movements, in which the individual experience of every one shows that that sense must materially assist.

The cerebellum is brought into union with each segment of the great nervous centre upon which all the movements and sensations of the body depend; through the *restiform bodies* it is connected with the medulla oblongata and the spinal cord; by the fibres of the pons with the mesocephale, and thus with the anterior pyramids and *corpora striata*; and through the *processus e cerebello ad testes* with the optic thalami. What can be the object of these extensive connections? It would be difficult to conceive any function for which so elaborate a provision would be more necessary, than that of regulating and coordinating the infinitely complex movements which the muscular system is capable of effecting; more especially when it seems highly probable that the antero-lateral columns of the cord, and the anterior pyramids and olivary columns supply

all the anatomical conditions necessary for the development of acts of sensation and volition.

It thus appears that Flourens' views respecting the office of the cerebellum derive considerable support both from experiment and from anatomy. When we come to collect the evidence on this subject which has been furnished by the effects of disease, we obtain very little information of a satisfactory kind. A superficial lesion of either cerebellar hemisphere or of the median lobe does not cause paralysis, but may produce delirium or convulsions, as a superficial lesion of either cerebral hemisphere may; but a deep-seated lesion of the cerebellum involving the central white substance which is continued from the crus cerebelli causes hemiplegia on the opposite side. This similarity between the effects of cerebellar and of cerebral disease is a remarkable and highly interesting fact, but one which considerably increases the difficulty of obtaining from pathological phenomena any contribution to the solution of physiological questions. It may be explained thus:—the transverse fibres of the pons passing through the mesocephale would propagate to this segment the morbid influence of any deep-seated lesion of the cerebellum, and thus affect the adjacent pyramid, which again would affect the opposite half of the body just as if the morbid influence originated in the cerebral hemisphere. It is, then, this secondary affection of either pyramidal body which obscures the proper signs referable to cerebellar lesion.

A few cases, however, have been put on record, in which a tottering gait, like that of a drunken man, and a defective power of coordination existed in connection with a diseased state of cerebellum. A striking instance of this occurred under my own observation: a young surgeon, who had recently received an appointment in the medical service of the army, was in attendance in the military hospitals at Chatham, preparatory to his nomination to a regiment. It was observed that as he walked he staggered to so great a degree that he was suspected of drinking to excess, and was put under arrest on this account. It was soon, however, found that he was suffering under symptoms of diseased brain, and he was sent up to town and placed under my care. I found that his principal symptom was extreme difficulty in the coordination of his movements, accompanied by a sense of giddiness in the head. He could neither stand nor walk, yet there was no distinct paralysis, for while he was in the recumbent posture he could move about his limbs freely. After a time he became amaurotic and comatose. The post-mortem examination revealed softening of the left crus cerebri and a patch of yellow softening on the corresponding restiform body: there was in addition a recent deposit of lymph at the base of the brain around the optic commissure.

I must now notice two other hypotheses as to the office of the cerebellum; the first is that of Foville; the second that of Gall. Foville

supposed that the cerebellum is the centre of sensation, "the focus of sensibility." The objections which appear fatal to this hypothesis are derived from anatomy and from pathological observation. The cerebellum wants that general connection with *sentient nerves*, (direct as well as indirect,) which might be expected if it performed the office in question. Not one of the nerves of pure sense has any connection with it. Moreover the diseased states of cerebellum do not give rise to any privation of sensibility such as might be expected where the centre of sensation was the part involved.

The most celebrated view of the office of the cerebellum is that put forward by the distinguished Gall. He supposed that the instinct of propagation has its seat in this organ, and therefore referred to it as the source of all sexual and generative impulses.

Gall's view rests on two assumptions; first, that the instinct of generation or of reproduction is "the most indispensable and most powerful of all the instincts;" and, secondly, that great width of the occipital region of the skull and thickness of the back of the neck indicate great development of the cerebellum.

It is by reason of the assumed transcendent importance of the generative instinct that so large a portion of the encephalic mass (an eighth or ninth part of the whole) has been assigned by Gall to exercise an exclusive influence over it.

This first position taken by Gall seems to me untenable. Can we separate the sexual instinct from the emotions, from those especially which are clearly instinctive in their nature? I apprehend not. The same part of the brain would probably exercise its influence upon all the emotional actions. But even if the sexual instinct were separable from the other instincts, it seems very questionable whether it is of that paramount importance as to need a separate organ of great magnitude, of complex structure, and of extensive connections with the rest of the cerebro-spinal centre. If we compare it with the instinct of self-preservation, as manifested in providing either for the wants of the body or for defence against assault, it certainly cannot be admitted to have a superior influence to this the most pressing of all. Yet, even to this instinct, a separate seat has not been assigned in the brain.*

The second position which Gall assumes,

* This argument was used, nearly *totidem verbis*, in Mr. Bowman's and my *Physiology* in discussing this subject. It and other objections to Gall's doctrine, which we made, have been criticised by Mr. Noble, of Manchester, a most zealous phrenologist, who, like many of that school, is impatient of the slowness of belief of those who do not completely embrace the opinions which he advocates. Mr. Noble seems to think that the existence of a surmise of Spurzheim's, of a single recorded observation of Dr. A. Combe, which led him to suggest that a certain large convolution, seen by him in the brain of a lady who had great fear of death, who evinced "perpetual anxiety about her own death," should be assigned as the seat of a faculty to be called "love of life," and some observations of Dr. Vimont, which Mr. Noble does not value so much as the single observation

and which is certainly necessary to the validity of some of the premises upon which his doctrine rests, is, I think, likewise open to strong objection. I cannot understand that great width of the occipital region and thickness of the back of the neck should necessarily indicate a great development of the cerebellum. I do not mean to assert that a large cerebellum would not give rise to a large occipital region, but I do assert that great development of the mesocephale may give rise to the very same external indications. This latter segment of the encephalon is of considerable size, and, as I have shown in a former part of this article, of complex anatomical structure, and contains all the elements of a distinct centre, while it possesses extensive connections with the cerebral hemispheres, the cerebellum, and the medulla oblongata. The largest portion of it, however, is independent of the cerebellum, and it is this portion which contains the greatest abundance of vesicular matter, and which has most distinctly the characters of a separate centre of nervous influence. Now the position of the mesocephale, in front of and between the hemispheres of the cerebellum, is such that a great development of it would push the hemispheres to each side, and thus, notwithstanding a small size of the hemispheres themselves, the occipital region would become expanded.

The great and pre-eminent size of the cerebellum in the human subject would warrant the belief that the sexual instinct in man far exceeded that of other animals, if Gall's doctrine were correct. Yet this seems by no means to be the case; for, although in man this instinct is more frequently in operation, it cannot be said to influence the whole system to the same extent as in many of the inferior animals. Surely this instinct is not more powerful in man than in the feline class, both male and female;—the common cat, for instance, in which the lateral lobes of the cerebellum are very imperfectly developed! There are other animals, likewise, peculiarly distinguished by the strength of this instinct and the remarkable extent to which it influences their entire functions. I have already referred to the extraordinary state of polar tension to which the spinal cord of the male frog, or a portion of it, is liable during the state of sexual excitement. Yet in this animal the cerebellum is very small; nor does it at this period acquire

any increase of size; and, moreover, there is no appreciable difference between the cerebellum of the male frog and that of the female, which exhibits no indication of increased excitement at this period. In fishes the instinct is in all probability strong; and the generative impulse, unaided as it is by sexual commerce, would seem to be dependent, more than in cases where copulation occurs, on the change which may take place in the nervous centre in accordance with the manifestation of that instinct; yet the cerebellum is by no means large in these animals. Dr. Carpenter refers to the kangaroo as affording a good instance of disproportionate development of the cerebellum to the generative instinct. He says, "a friend who kept some kangaroos in his garden, informed the author that they were the most salacious animals he ever saw, yet their cerebellum is one of the smallest to be found in the class (Mammalia). Every one knows, again, the salacity of monkeys; there are many which are excited to violent demonstrations, by the sight even of a human female; and there are few which do not practise masturbation when kept in solitary confinement; yet in them the cerebellum is much smaller than in man, in whom the sexual impulse is much less violent."

According to Gall and most of his followers mutilation of the genital organs or their decay in the advance of age is attended by marked effects on the cerebellum. If one testicle be destroyed, a distinct diminution, according to Gall, takes place subsequently in the cerebellar hemisphere of the opposite side. The kind of evidence upon which phrenologists rest their views of this matter will appear from the following specimens: 1. Dr. Gall relates that at Vienna he was consulted by two officers who had become impotent in consequence of blows from fire-arms, which had grazed the napes of their necks. 2. "Baron Larrey," says Gall, "sent to me a soldier who, in undergoing an operation for hernia, had lost the right testicle. Several years afterwards his right eye became weak. He began to squint with the diseased eye, and could scarcely any longer distinguish objects with this eye. I examined the nape of his neck, in presence of the two physicians who had brought him, and I found the *occipital swelling of the left side much less prominent than that of the right side*. The difference was so perceptible that the two physicians were struck with it at first sight."

3. Baron Larrey's cases:—*a.* An artilleryman received a wound from a musket-ball, which traversed from side to side the insertions of the extensor muscles of the head, grazing and dividing the two inferior occipital swellings which correspond to the hemispheres of the cerebellum. This individual experienced a *diminution in the size of his testicles, which fell into a state of atrophy*. *b.* A light horseman, of very amorous disposition, received a sword-cut, which divided the skin and all the convex portion of the occipital bone through to the dura mater. The right lobe of the cerebellum was seen through the opening of the dura mater, and the slightest pressure upon this organ

of Dr. Combe, justify him in charging us with ignorance in making this assertion. Mr. Noble likewise dignifies our argument with the title of "nonsense." I am content to repeat the argument and to leave it to persons of calmer judgment to decide whether it is of sufficient weight. Mr. Noble has been so courteous and so complimentary in his remarks generally, that I cannot allow myself to believe that he *intended* offence by the use of this term. I hope, however, that he will excuse me for observing that it is much to be regretted that the advocates of particular views should allow their zeal so far to outrun their judgment as to lead them, in the sober seriousness of print, to make use of terms which they would hardly venture upon in the less premeditated colloquial argument.—See Noble on the Brain, p. 142.

caused giddiness, fainting, and convulsive movements. The patient loses sight and hearing of the right side, experiences acute pain in the course of the dorsal spine, and *tingling in the testes, which in fifteen days were reduced to the size of a bean*. The patient dies of tetanus, with loss of the functions of sight, hearing, and generation.* On dissection there was great loss of substance at the occiput, *the medulla oblongata and upper part of the spinal cord were of dull white, of firmer consistence, and reduced in size one-fourth*. The nerves arising from these parts were likewise wasted.

c. A chasseur received a sabre cut, which divided the skin and *external protuberance of the occipital bone, and the extensor muscles of the head as low down as the sixth vertebra*. This man gets well, but Larrey states that he declares "that he has been deprived of his generative powers ever since that wound." 4. Gall caused rabbits to be castrated, some on the right side and others on the left. Having had them killed six or eight months afterwards, he finds diminution of the cerebellar lobe opposite the removed testicle, and flattening of the corresponding occipital swelling. Vimont, however, found no diminution of the opposite lobe of the cerebellum in four rabbits on which castration had been effected on one side, and which had been kept *eight months*; but in four other rabbits, similarly treated, but kept *eighteen months*, a very perceptible diminution in the opposite lobe of the cerebellum was found.†

The results of mutilation of the generative organs, as obtained by the researches of M. Leuret, are far from being favourable to Gall's theory. M. Leuret took the weight of the cerebellum both absolutely, and, as compared with that of the cerebrum, in ten stallions, twelve mares, and twenty-one geldings. The following table shows the results of the absolute weights.

	Average.	Highest.	Lowest.
Stallions..	61 ..	65 ..	56
Mares. . .	61 ..	66 ..	58
Geldings..	70 ..	76 ..	64

Thus the remarkable result is obtained, that castration tends to augment the weight of the cerebellum, and not to reduce it, as Gall and his followers affirm.

What is further very remarkable in these researches is that the *cerebrum* in geldings is on the average less in weight than that in stallions; and the fact gives great confirmation to the results of weighing the cerebella, rendering it in the highest degree improbable that the excess of weight in the cerebellum was accidental.

The general expression of the facts obtained by Leuret is this, that in horses, mutilated as regards the principal generative organs, the cerebellum is heavier than in horses and mares not mutilated in the generative organ; and he compared twenty-one of the former with twenty-two of the latter.

Compare these observations with those above quoted from Gall by Mr. Noble, a most ardent phrenologist, and I think most unprejudiced persons will admit that in the number of observations, in the exactness with which those observations were conducted, and in their freedom from sources of fallacy, the researches of M. Leuret have greatly the advantage over those upon which Gall rests his conclusion.

Yet Mr. Noble, while he unhesitatingly accepts the few and very feeble instances quoted and adopted by Gall, is at great pains to depreciate these observations of Leuret; first, because they are not sufficiently numerous; secondly, because Mr. Parchappe found that, in comparing the cerebra and cerebella of a certain number of mad men and women with those of sane men and women, a very slight advantage existed in favour of the former; and, thirdly, because the author of the observations is an opponent of phrenology.

I must say, however, upon this point, that, while I do not reckon myself among the opponents to phrenology, but rather among those who are anxiously looking for and desirous of promoting a truly scientific phrenology,* I cannot but regard the facts brought forward by M. Leuret as of the greatest interest and importance, and not to be affected by any such arguments as those of Mr. Noble; nor are they to be met at all, save by similar weighings, in the same, or still better, in double the number of animals.

The last point to be noticed with regard to Gall's theory of the office of the cerebellum is that it certainly derives no support from pathological observations. The few cases quoted by Gall, in which the injury in the neighbourhood of the cerebellum seemed to affect sexual instinct are far from being conclusive, for they might apply equally, if it were assumed that the seat of the instinct were in the posterior lobes of the cerebrum, in the medulla oblongata, or in the spinal cord. Indeed Baron Larrey's second case is much more favourable to the localization of the generative impulse in the centre of emotions, than in the cerebellum. For the latter organ was free from disease, whilst the medulla oblongata was indurated. And, further, the assumed connection between

* The following passage from Dr. Holland's valuable "Medical Notes and Reflections" expresses so well the true position of phrenology, that I am glad to quote it as an excellent expression of my own creed relative to this point. "In the present state of our knowledge of the brain," says Dr. Holland, "and of its relation to the mental functions, an impartial view of phrenology requires, not that the doctrine should be put aside altogether, but that great abatement should be made of its pretensions as a system. To say the least, it is chargeable with what Lord Bacon has called 'an over-early and peremptory reduction into acts and methods,' and with the adoption of various conclusions not warranted by any sufficient evidence. But on a subject thus obscure in all its parts, and where our actual knowledge is still limited to detached facts or presumptions, there is enough to justify the opinion being kept before us, as one of the outlines to which future observations may apply; not fettered, as they now are, by the trammels of a premature arrangement." P. 517.

* I apprehend the loss of the generative function is not uncommon in tetanus!

† Quoted from Mr. Noble on the brain.

the generative instinct and the cerebellum, from the occasional existence of an abnormal erection of the penis, is not justified by the facts. This symptom is far from being constant in cerebellar disease—indeed it occurs in but a very small number of cases—and, as a symptom pointing to lesion of a particular portion of the cerebro-spinal axis, it is much more indicative of disease of the medulla oblongata or of the cervical portion of the spinal cord.

Office of the cerebral convolutions.—The great sheet of vesicular matter which forms the cortex of the human brain, is of such vast extent that it is forced to assume the convoluted form in order to its being packed within the ordinary compass of the cranium. A little consideration will shew that the *convoluted form* can be regarded no otherwise than as a convenient mode of packing, and that the *number and depth* of the convolutions are the best indications of the superficial extent of this expanse of vesicular matter. In certain cases a slow and gradual accumulation of water within the ventricles of the brain, causing a corresponding enlargement of the cranium, expands the matter of the cerebral hemispheres, by which the ventricles are enclosed, and the convolutions become unfolded. We thus obtain a distinct demonstration of the true arrangement of this part of the hemisphere, which must be regarded as a nervous centre, consisting of a vast mass of the potential vesicular matter freely supplied with bloodvessels from a vascular surface on its exterior (the pia mater), and giving rise to an infinite multitude of nerve-fibres, which pass from its internal surface to the corpora striata and optic thalami, the centres of volition and sensation. The name which Mr. Solly has given to this expanse of nervous matter, *hemispherical ganglion*, is very expressive, not only of its true character as a centre of nervous power, but likewise of the *unity* of the organ on each side, consisting as it does of an uninterrupted layer of vesicular matter with its emerging or im-merging fibres, and not of a great number of different organs, as the term convolutions would imply.

This vesicular surface with the fibrous matter which connects it with the optic thalami and corpora striata forms by far the largest portion of the encephalon in the higher classes of animals. This fact alone ought to stamp it with great physiological importance. But, further, it is a well-proved fact, that the *complexity of the convolutions in the animal scale is in the direct ratio with the advance of intelligence*. At the same time it must be remembered that the complexity of the convolutions is in part determined by the size of the head and the capacity of the cranium. If, for example, the habits and mode of life of the animal require a small head and at the same time a certain degree of intelligence, the brain would exhibit a greater number and complication of convolutions than would be found in an animal of corresponding intelligence, but which required and possessed a larger head. Hence neither the *size* nor the *weight* of the

brain, whether absolute or in relation to the body, affords any certain criterion of the extent of the convoluted surface. Highly complicated convolutions may exist along with a brain both absolutely and relatively small. Thus, the ferret, as shown by Leuret, whose habits require a small head, has several well-marked convolutions on each hemisphere, and a brain no larger than that of the squirrel, which has no convolutions at all, and which wants even the few fissures which mark their first development in the rabbit, the beaver, the agouti, &c. And the last-named animals have the brain both absolutely and relatively larger than that of the cat, the pole-cat, the roussette, the unan, the sloth, and the pangolin, all of which possess convolutions.

At the early periods of human life, in infancy and childhood, the convolutions of the brain are very imperfectly developed, but their increase of size goes on simultaneously with the advance of mental power. If the former be arrested, or if some congenital fault prevent the further growth of the convolutions, the mental powers are of the lowest and feeblest kind, but little or not at all above those of the brute with imperfect convolutions. In all idiots the brain is not only small, but its convoluted surface is extremely limited.

Anatomy points to the conclusion that the office of the convolutions is connected with the functions of the mind. Perception, memory, the power of abstraction, judgment, imagination, all possess, as instruments of corporeal action, these folds of vesicular matter. And it seems not improbable that the phrenological view which assigns to certain convolutions a special office connected with some particular faculty or faculties is true. This is strongly supported by the fact of a regular disposition of certain primary convolutions in the various classes of animals, so that each form of brain has its proper convolutions, and that in tracing the convolutions from the most simple to the most complex, indications are found of the persistence of the primary and fundamental convolutions in the midst of many secondary and superadded ones.

It may be here mentioned that Gall was by no means the first to assign this function to the convolutions. Our countryman, Willis, in the seventeenth century, distinctly advanced this opinion, and conjectured that the various gyrations were intended for retaining the animal spirits "for the various acts of imagination and memory" within certain limits.

It is important to ascertain the endowments of the fibres which connect the vesicular surface of the convolutions to the corpora striata and optic thalami. They might be supposed to possess similar endowments to those of sensitive and motor nerves, if we adopted the views of those who hold that all the nerves are continued up into the brain. This point, however, has been settled in the most decisive manner by experiments, dating as far back as the time of Lorry.* Mechanical injury to them excites

* Mém. de l'Acad. des Sciences, 1760.

neither pain nor disturbance of motion. Even the electric current passed through them produces no sensible effect (Matteucci). We are led, therefore, to the conclusion that these fibres have endowments quite distinct from those of sensitive and motor nerves, (a fact, by the way, quite irreconcilable with the doctrine which makes the brain the concourse of these fibres,) and that they are interminal between parts which are beyond the *immediate* influence of the ordinary physical agents, and which have no direct connection with muscular organs. The proper stimulant of these fibres is the mind on the one hand, or the nutrient changes in the brain on the other. But, under the influence of a continued morbid irritation, they may excite either pain or convulsion, or both, as is frequently the case in disease of the cerebral meninges; this, however, is effected through a change produced in the corpora striata and optic thalami, and propagated thence to the origins of motor and sensitive nerves, or through irritation of the nerves of the meninges, which affect the centres of motion and sensation, just as the nerves of other parts do.

The experiments of Flourens and of Hertwig show that removal of the cerebral hemispheres produces a state of stupor, and, to use Flourens' expression, as it were condemns the animal to perpetual sleep, but deprives it even of the faculty of dreaming. There is, however, no paralytic state produced by these mutilations. It is evident, then, that the effect of these experiments is *psychical*, and it may be adduced as confirmatory of the view which associates the functions of the cerebral convolutions with the operations of the mind.

Pathological anatomy affords interesting confirmation to this view. Inflammation of the membranes of the brain, more especially of the pia mater, is invariably attended by disturbance of the mental faculties, as manifested by more or less delirium. It appears that any material alteration of the circulation in the grey matter of the convolutions is capable of giving rise to delirium; in the instance above quoted, the circulation in this part is affected in consequence of the inflammation of the pia mater, the bloodvessels of the one being distinctly continuous with those of the other; but in other instances of violent delirium, such, for example, as delirium tremens, the vesicular matter of the convolutions is found after death to be bloodless, as if its wonted supply of blood had been cut off or abstracted from it. We find this state in the delirium after great operations, after puerperal floodings, in the delirium of rheumatic fever, and in that of gout, and likewise in that which occurs in the more advanced stages of fever.

We learn from the most trustworthy reports of the dissections of the brains of lunatics that there is invariably found more or less disease of the vesicular surface and of the pia mater and arachnoid in connection with it, denoted by opacity and thickening of the latter with altered colour or consistency of the former.

From these premises it may be laid down as a just conclusion that the convolutions of the

brain, in other words, that vast sheet of vesicular matter which crowns the convoluted surface of the hemispheres, constitute the *centre of intellectual action*, as distinguished from the *centre of volition* and the *centre of sensation* (corpora striata and optic thalami). It is essential to the perfection of cerebral action that these centres should be connected, and that the *centre of intellectual action* should be capable of exciting or of being excited by the centres of volition and sensation. This connection and mutual influence is effected through the innumerable fibres which pass from the one to the other.

To determine the precise connection which exists between the mind and the brain is beyond the reach of our means of observation and experiment. All we are justified in affirming is that the mental acts are associated with this portion of the brain, which I would call the *centre of intellectual actions*; and that the integrity of this part is necessary to the perfect exercise of the mind; that, in the language of Cuvier, this centre is the sole receptacle in which the various sensations may be as it were consummated, and where all sensations take a distinct form and leave lasting traces of their impression, serving as a seat to memory, a property by means of which the animal is furnished with materials for his judgment.

The actions of the convoluted surface of the brain, and of the fibres connected with it, belong altogether to the class of *mental nervous actions*; that is, they either excite or are excited by mental change. The physical changes in these parts give rise to a corresponding manifestation of ideas, and every thought is accompanied by a change in this centre. Modifications in its nutrition, or interruptions to it, produce corresponding effects on the mind. An increased activity of nutrient change causes a rapid development of ideas, which, being generally uncontrollable by the will, and therefore undirected, assumes the form of raving or delirium. The shock of concussion so far checks the organic changes of the vesicular surface, and perhaps also of the fibrous matter, as to interrupt for a time those conjoint actions of the mind and the brain which are necessary for perfect consciousness. The condensation of the substance of the hemispheres, which is produced by an apoplectic clot, or by the effusion of some other foreign matter, prevents a similar consent of action, and thus gives rise to the phenomena of *coma*, a state in which all mental nervous actions are destroyed or suspended, and which, if continued long enough, will annihilate the physical nervous actions likewise.

It will be observed that, in this description, the workings of the mind are not viewed as mere functions of the brain. The term *Mind* expresses the mode of action of the *Soul*, an entity which both reason and revelation assure us is essentially different from the *Body*,* being incorruptible and indestructible, in the sense in which we suppose that both corruption and destruction may affect material things. To

* *Ens incorporea prosopæa*, Prochaska.

will, to feel, to perceive, to think, are so many states of Soul or acts of Mind.

Mind is, then, the mode of action of the Soul, as Life is the mode of action of the Body. The latter we distinguish as *material*, and the phenomena of life as specially belonging to organized matter; the former we denominate *immaterial*, to mark its essential difference from the body, admitting, however, that it exists in a mysterious union with the nervous system of the body in a manner so intimate that in a state of health the smallest change in either readily affects the other.

Such is the doctrine which seems most consonant with reason and experience, and, above all, with revelation. But there are those who maintain that not only are certain states of mind preceded by certain states of body, but that all our ideas, our sensations, our volitions, are the result of, and as it were generated by, certain organic changes.

This view, which is that of materialism, while it necessarily tends to destroy our hopes of a future life, by denying even the very existence of a Soul, and not its immortality only, is opposed by the consciousness which we possess of a power inherent in the mind to direct and control the actions of the brain, and by the knowledge that the mind will rise superior to the fatigue and exhaustion of the body, and will survive, unimpaired, even its wreck.

There are, moreover, some excellent persons, who, while they admit the existence of an immortal soul distinct from the mind, nevertheless regard the phenomena of the mind as functions of the brain, resulting from the changes which are continually taking place in that organ. The mind, they say, is "the aggregate of the functions of the brain," and is entirely dependent on its integrity. But the adoption of these views involves the advocate of them in as great a difficulty as that from which he flatters himself he has escaped. If there be a soul, what is its relation to the mind? What is its office? Is it simply associated with the body without being affected by it or affecting it in turn? Surely it must have some office, and if it be admitted to be capable of exercising any influence, either on the mind or on the body, then the whole matter in dispute vanishes. If the soul can affect the mind, it must do so according to these views through the body; and, if this be admitted, why make a difficulty about admitting that the will, as a faculty of the soul, can influence some portion of the brain?

On the other hand, if it be denied that the soul can affect either mind or body, then must we come to the conclusion that the soul is inert, or else an entity totally distinct from the body, a looker-on as it were, which watches the corporeal functions and the mental phenomena, but takes no part in them, and has no true sympathy with them.*

An acute and ingenious writer, Dr. Wigan, who has advocated with great zeal and ability the doctrine of the duality of the mind, seems to think that the progress of mental philosophy and of cerebral physiology is much hindered by the views of those who advocate the spiritual

different from each other; each of which has its own peculiar laws, and its own peculiar enjoyments and sufferings. When any of our senses are affected or appetites gratified with the objects of them, we may be said to exist or live in a state of sensation. When none of our senses are affected or appetites gratified, and yet we perceive and reason and act, we may be said to exist or live in a state of reflexion. Now, it is by no means certain that any thing which is dissolved by death is in any way necessary to the living being in this state of reflexion, after ideas are gained. For though, from our present constitution and condition of being, our external organs of sense are necessary for conveying in ideas to our reflecting powers, as carriages, and levers, and scaffolds are in architecture, yet when these ideas are brought in, we are capable of reflecting in the most intense degree, and of enjoying the greatest pleasure and feeling the greatest pain by means of that reflexion without any assistance from our senses; and without any at all, which we know of, from that body which shall be dissolved by death. It does not appear then, that the relation of this gross body to the reflecting being is, in any degree, necessary to thinking—to our intellectual enjoyments or sufferings; nor, consequently, that the dissolution or alienation of the former by death will be the destruction of those present powers which render us capable of this state of reflexion. Further, there are instances of mortal diseases which do not at all affect our present intellectual powers; and this affords a presumption that those diseases will not destroy these present powers. Indeed, from the observations made above, it appears that there is no presumption that the dissolution of the body is the destruction of the living agent from their mutually affecting each other. And, by the same reasoning, it must appear too that there is no presumption that the dissolution of the body is the destruction of our present reflecting powers from their mutually affecting each other; but instances of their not affecting each other afford a presumption of the contrary. Instances of mortal diseases not impairing our present reflecting powers evidently turn our thoughts even from imagining such diseases to be the destruction of them. Several things, indeed, greatly affect all our living powers, and at length suspend the exercise of them; as for instance drowsiness increasing till it ends in sound sleep; and from hence we might have imagined it would destroy them, till we found by experience the weakness of this way of judging. But, in the diseases now mentioned, there is not so much as this shadow of probability to lead us to any such conclusion as to the reflecting powers which we have at present. For, in those diseases, persons, the moment before death, appear to be in the highest vigour of life. They discover apprehension, memory, reason, all entire; with the utmost force of affection; sense of character, of shame and honour; and the highest mental enjoyments and sufferings, even to the last gasp; and these surely prove even greater vigour of life than bodily strength does. Now what pretence is there for thinking that a progressive disease when arrived to such a degree, I mean that degree which is mortal, will destroy those powers which were not impaired, which were not affected by it during its whole progress quite up to that degree? And if death by diseases of this kind is not the destruction of our present reflecting powers, 't will scarce be thought that death by any other means is." See the admirable chapter, "*Of a future Life*," in Butler's Analogy of Religion, natural and revealed.

* I beg the reader to peruse with attention the following passage from Bishop Butler:—"Human creatures," says this profound thinker, "exist at present in two states of life and perception, greatly

nature of the mind.* But no doubt his fears are unfounded; for if we hold that a connection subsists between soul and brain so intimate that every change in either affects the other more or less, surely the strongest inducement is held out for the minutest investigation of the organ which can exercise so wonderful an influence on the immortal part of our nature.

I would, then, lay it down that the proper function of the brain is to generate the nervous force, and that that force affects the soul and excites its action for the development of mental phenomena. On the other hand, the action of the soul affects the brain, exciting it to the development of nervous force, and directing that force for the production or regulation of other corporeal phenomena.

Taking this view of the nature of the mind, and of the relation of mind and body, we may, with advantage, arrange the principal mental states into two classes, according as they are preceded by certain states of body, or as they precede and are capable of exciting certain states of body.

In the first class I would place *sensation*, and such mental states as are immediately associated with or produced by sensation, as the emotions and the passions. To this class I would likewise refer that peculiar power which is, with the highest probability, exercised by the cerebellum, and to which we must give the name of balancing or coordinating power. It is a power which, like the emotions and passions, is exercised without any previous train of thought or intellectual process, and seems simply to be evolved as an immediate consequence of certain sensations, which are developed under the influence of impressions made upon the organs which are to be submitted to its regulation. Thus, in locomotion, the exercise of the muscles produces the sensation upon which the evolution of this mental power depends, which reacts upon the same muscles with an intensity proportionate to the exciting impulse. In the exercise of this power there is much analogy with the ordinary reflex acts; but while the latter are purely physical in their nature, the former may be clearly shown to be mental. The proofs of this are derived, 1, from its being never accomplished without consciousness; 2, from its being always associated with volition; 3, from the curious differences in the mode of its exercise in different individuals, according to differences of mental and physical constitution, one man being expert and precise in all his movements, another awkward and clumsy; 4, from the marked improvement which may be effected in it by instruction and duly regulated practice.

In the second class I would place *volition* and *attention*. In these the mind has clearly the initiative, and is capable of inducing certain states of body, either to move certain organs (voluntary motion), or to concentrate one or more of the inlets of sensation upon some external objects (attention). The power

of abstraction, imagination, and all purely intellectual processes, are obviously associated with these.

The symmetrical disposition of the parts of the encephalon on each side of the median plane has been recognised by all anatomists. This symmetry is so complete that we may, with perfect correctness, speak of two brains, a right and a left brain, which are united to each other by transverse commissures. The right brain corresponds exactly with the left, just as much as the right eye corresponds with the left. This doubleness of the brain, no doubt, accords curiously with the doubleness of all the organs of sense, and very probably is rendered necessary by the existence of the double set of inlets to sensation. It is remarkable, however, that a perfect symmetry of the convolutions is not found in the higher races of mankind, and in individuals of high intellectual powers; and that the greater the mental power, the less symmetrical are the convolutions. In the inferior races, on the other hand, as Tiedemann has well shown, the symmetry of the convolutions is exact.

Upon the proved existence of two brains, as thus explained, Dr. Wigan, adopting the materialist view of mental phenomena, rests the theory that the mind is dual; that we have two minds; that each brain performs its own mental functions, which are in perfect harmony, if the two brains harmonise in quality, structure, and action.

It cannot be doubted that two brains, thus symmetrical in structure, must have a tantamount symmetry of function, if I may be allowed the expression; and that, therefore, in order to insure harmony of action between them, and to prevent the actions of one from interfering with or neutralising those of the other, some such organic connection between them is necessary as that which exists between the two retinae, and which converts the separate and in some degree dissimilar physical impressions made on each of them into one sensation.

And as any interference with the organic conditions necessary to secure single vision with two eyes produces double vision, so it is not unreasonable to expect that an analogous imperfection in the organic union between the two brains may occasion doubleness of mental impression and action. Such a conclusion, as Dr. Wigan has ingeniously suggested, gives the clue to the explanation of such phenomena as states of double consciousness, delusions, irregular volitions, and some forms of insanity; and, if fairly worked out by physiological psychologists, may solve other obscurities connected with the phenomena of the mind. While, therefore, I admit that great practical interest and value attach to Dr. Wigan's views respecting the action of two brains, I am not prepared to infer the existence of two minds from that of two brains; no more than I can assume a duality of our visual sense from the existence of two eyes. The two cases, indeed, are strictly analogous. The organic change in each retina develops a

* Wigan on the Duality of the Mind. Lond., 1844.

corresponding sensorial impression; and from the connections which subsist between the retina, and still more from that between the centres of sensation, these impressions become fused into one. In like manner the organic changes in the two brains developing nervous force in similar modes and proportions, each being capable of affecting the mind similarly, although perhaps not identically, are yet so united in their action that the double organic affection acts on the mind as one. But if, through default of the connecting media of the two brains, or through lesion of one, the organic changes in each do not harmonise with those in its fellow, then it is plain that two separate and distinct mental affections will result, and more or less of confusion must ensue. I can see no ground for inferring the existence of two minds from such a supposition. The confusion results from the want of simultaneous affection of the same mind by two distinct and separate brains. If, in vision, each centre of sensation affected only its own mind, or, in other words, developed only its own mental phenomena, as Dr. Wigan's theory would compel us to assume, then each mind would perceive a different perspective projection of the object presented to the eyes, and an elaborate and complex mental process would be required to combine the two sensorial impressions. How much simpler is the view of this process which assigns the combination of the double impression to a physical union in the brain of each physical change in the retina; so that, in truth, but one impression, different from each of its excitant ones, reaches the mind. So also, in the normal intellectual action, the organic changes of the two brains are united by the various transverse commissures, so that but one physical stimulus affects the mind and excites but one train of thought. Not so, however, when from any defect in the brains themselves, or in the commissures, the physical conditions necessary for the organic states of the two brains cannot be fulfilled.

Dr. Wigan's theory is inconsistent with the acknowledged fact of the existence of an imperfect symmetry of the convolutions in persons possessing the highest order of mind. If the two brains always act in harmony, there ought to be perfect symmetry. But if we admit that the mind may have the initiative, then it is easy to understand how one brain may be used more than another.

That a power exists of using one brain more than another, seems probable from the more frequent and more perfect use of one hand; and the existence of such a power implies also a capability of keeping one brain in suspense while the other is acting, under particular circumstances, just as we can suspend the use of one arm or one finger or one eye, although the exercise of its fellow prompts greatly to its simultaneous action.

Sleep is an affection of the centre of intellectual action, a condition rendered necessary by the incessant working of the mind. It is indicated by the cessation of all mental nervous actions. In deep sleep the body is given up

to the physical nervous actions only, without which the functions of breathing, circulation, &c., could not be carried on. *Dreaming* occurs only in imperfect sleep,—often, if not always, just before waking,—and serves to show how the organic changes of the centre of intellectual action, when uncontrolled, may produce the most rapid trains of thought, recalling events or impressions that have passed away, and which we may have thought had been forgotten.

Coma is sleep of the profoundest kind, a paralysis, indeed, of the centre of intellectual action, as well as of sensation and volition. It occurs under states of disease, which induce *compression* of the brain, or under states of shock, which suspend or greatly diminish its natural changes, as in *concussion*. Or it may be induced by the influence of certain poisons of the sedative or narcotic kind, as opium and belladonna, which, if given in too large a dose, paralyse first the centres of mental nervous actions, and ultimately those of physical nervous actions.

Somnambulism must be regarded as a state of intense dreaming, in which the person is prompted to the performance of certain acts. Talking in one's sleep, the curious changes of position which are made under the influence of nightmare, and even the most complex actions, as walking, or taking things from one place to another, or holding a long conversation, are all induced by the same state, a morbid condition of the centre of intellectual action, generally produced by deranged assimilation or great previous disturbance of mind. The somnambulist, in short, is one who dreams and acts in his dream as if he were awake, and as if all the phenomena of which he takes cognizance were real.

Delirium is a condition very analogous to dreaming. The organic changes in the centre of intellectual action are too rapid to be controlled by the will, or the influence of the centre of volition is impaired. The ravings of a delirious patient generally take place unconsciously, as if the centre of sensation were impaired likewise. In most instances, however, the patient may be roused; a strong stimulus, as in addressing him with a loud voice, will affect his centre of sensation, and he either controls his thoughts for a brief space, and directs his attention to what is going on, or the effect of the stimulus is to direct his ravings into some new channel. The incoherent and unconnected manner in which thought follows thought in the delirious state is sufficient proof that the centre of intellectual action requires the controlling power of a will for perfect trains of thought, as much as any particular set of muscles requires the same influence for the accomplishment of definite action.

Delirium, indeed, may be viewed as a *subjective* phenomenon of the centre of intellectual action, just as *tinnitus aurium* or *ocular spectra* are subjective phenomena of the centre of sensation.

In analysing the fibres of the *centrum ovale* we find that a large number of them is commissural, but that the greatest proportion of

them serves to establish a communication between the centre of intellectual action, and the centres of volition and sensation. It is through this connection that the intellect and the will are capable of mutually affecting each other, the intellect prompting or exciting the will; and the will, on the other hand, controlling or applying the powers of the intellect. The faculty of attention, and, therefore, in a certain degree, that of memory, are dependent on the influence of the centre of volition upon the centre of intellectual action. Every one is sensible of a power which he possesses of fixing his attention on any given subject, as distinct as that by which he can contract any particular muscle. The association of the intellectual centre with that of sensation is necessary to ensure the full perception of sensitive impressions. The experience of each individual can supply him with numberless instances in which, while the mind was employed upon some other object of interest, an impression was made upon some one of the organs of sense, and indistinctly felt, but not fully perceived. When the mind has become disengaged, the fact that an impression had been made is recalled, without any ability to recollect its precise nature. And in many lunatics the centre of intellectual action is so impaired as to destroy or greatly reduce the power of perception, whilst there is abundant evidence to shew that the affections of the organs of sense make a sufficient impression on the centre of sensation, although in such cases this centre may likewise participate in the general hebetude.

Perfect power of speech, that is, of expressing our thoughts in suitable language, depends upon the due relation between the centre of volition and that of intellectual action. The latter centre may have full power to frame the thought; but, unless it can prompt the will to a certain mode of sustained action, the organs of speech cannot be brought into play. A loss of the power of speech is frequently a precursor of more extensive derangement of sensation and motion. In some cases the intellect seems clear, but the patient is utterly unable to express his thoughts; and in others there is more or less of mental confusion. The want of consent between the centre of intellectual action and of volition is equally apparent in cases of this description, from the inability of the patients to commit their thoughts to writing.

The hemispheres of the brain, as has been already stated, are insensible to pain from mechanical division or irritation; in wounds of the cranium in the human subject, pieces of the brain which had protruded have been removed without the knowledge of the patient. Nevertheless, pain is felt in certain lesions of the brain, even when seated in the substance of the hemispheres, or in the optic thalami or corpora striata. This results from the morbid irritation extending to other parts with which nerves are connected, as the medulla oblongata; or in which nerves are distributed, as the membranes. The nearer a cerebral lesion is to the membranes or to the medulla oblongata, the more likely is it to excite pain. Headaches, of whatever na-

ture, must be referred to irritation, either at their centres or at their periphery, of those nerves which are developed in the dura mater or in the scalp. The branches of the fifth pair, of the occipital nerve, and the auricular branch of the cervical plexus, are those most frequently affected.

Certain sensations are referred to the head which may occur from a morbid state, or may be produced by changes of position in the body. Such are vertigo, a sense of fullness, or of a weight in the head, a feeling of a tight cord round the head. These are, no doubt, truly subjective, arising from altered states in the distribution or in the quality of the blood sent to the brain. A sensation of a rushing of blood to the head is often consequent upon excessive hemorrhage, or accompanies a state of extreme debility from any cause. This is, doubtless, owing in great part to the feeble tone of the arteries, resisting imperfectly the flow of blood to the head, and allowing it to impress the nervous matter too much. It is well known, that, by turning round quickly on one's own axis, the sense of vertigo may be produced; a confused feeling in the head, and an inability to maintain the balance of the body, accompanied by an appearance as if external objects were revolving. If the eyes be kept shut, the uneasy feeling of the head will take place, but no true vertigo. To obtain this feeling perfectly, the eyes must be open, and objects presented to them. And Purkinje has shewn that the direction in which external objects appear to revolve is influenced by the position of the body and of the head while turning round, and by the position of it afterwards, when the experimenter has ceased to move round. If the experimenter have kept his head in the vertical position while moving round, and afterwards when standing still, the objects appear to revolve in the horizontal direction. If the head be held with the occiput upwards while turning round, and then erect when standing still, the objects seem to rotate in a vertical plane, like a wheel placed vertically revolving round its axis.* It is highly probable that these sensations, as well as those which arise spontaneously, are due to some irregular distribution of blood to various parts of the brain. A sense of giddiness frequently precedes fainting, and is attributable to the temporary deficiency in the supply of blood to the head. If the horizontal position be immediately adopted, or the body be laid with the head inclined downwards, the faint may be prevented. The sense of giddiness which is experienced upon rising from the horizontal position after illness, is doubtless of the same kind. Anæmic patients experience this feeling of giddiness even in the horizontal position; and both it and the headache and delirium, which accompany this state of bloodlessness, may be relieved by placing the patient on an inclined plane with the head downwards.

The mind possesses a remarkable power of exciting and of exalting painful sensations in various parts of the body. If the attention be

* Müller's Physiology, by Baly, vol. i. p. 843.

directed very strongly, and for some time, to any part, it may become the seat of pain, for which the most effective remedy is to engage the thoughts as much as possible on some other object. In many instances, where pain has been excited by a physical cause, there can be no doubt it has been continued long after the cessation of its exciting cause, by the attention of the patient having been directed to it. It is probable, that in such cases the *perceiving* parts of the brain (so to speak) become habituated to a certain condition of the centre of sensation, produced by the original exciting cause of the pain. And, on the other hand, pain, at first excited by the mind, may be rendered permanent by habit; a certain physical alteration in some part of the centre of sensation being induced by the frequent repetition of the mental act in reference to a particular part of the body.

Those parts of the brain which are capable only of mental nervous actions, that is, of actions by which the mind is immediately affected, or which the mind can develop, have no nerves implanted in them. Such are the convolutions, the corpora striata, the optic thalami, and the cerebellum. The only apparent exceptions to this statement are the olfactory and optic nerves: these nerves, however, have in truth no immediate connection with any of the parts above mentioned. The former are implanted in the olfactory lobe; the latter in the chiasma, which is formed by the junction of the optic tracts, and these ought no more to be regarded as portions of the optic nerves, than the olfactory lobes should be considered as nerves.

Functions of the commissures.—The anatomy of the parts which we call commissures indicates that the name by which they have long been known is not misapplied, inasmuch as they seem to unite particular portions of the nervous centres with each other. The most obvious object of such an union would be to ensure the harmonious cooperation of the parts thus united. And this view of their function is strengthened by the fact that the principal commissures bear a direct ratio in point of development to that of the parts they unite, and that, when these parts are absent or defective, the commissures are deficient or wholly wanting. Thus the corpus callosum and the hemispheres are developed together; the fornix and the hippocampi, the pons Varolii and the cerebellar hemispheres.

In Stilling's experiments on the spinal cord it was found that when division of that organ was made along the median plane, a stimulus applied to one leg caused only reflex actions of that leg, and not at all of the other side of the body. The power of transmitting organic change from one side of the cord to the other was destroyed by the section of the commissure.

The anatomy of the corpus callosum is favourable to the hypothesis that it is the bond of union to the convoluted surface of the hemispheres, and that it is in all probability the medium by which the double organic change is made to correspond with the working of a

single mind.* There is nothing in the recorded observations of morbid change or congenital defect of this part to militate against this idea; but as all these cases are accompanied with lesion or defect of some other parts, and of the convolutions themselves, it is impossible to gather from them what is the precise consequence of the defect of the corpus callosum. This commissure is defective in the marsupiate class, as was shown by Professor Owen, and likewise in birds; but we have yet to learn whether there is any psychological character in either of these groups of animals, which would give us material assistance in our search into the nature of its function.†

Direct experiments upon the corpus callosum yield only negative results. Longet and others found that mechanical irritation of it did not cause convulsions; and Longet states that injury to the corpus callosum in young rabbits and dogs did not appear to disturb voluntary movements; and that when he incised this body in its whole length in rabbits standing, they continued to maintain that position, or, when urged on, ran; and that no convulsive movement whatever, nor any sign of pain, was manifested. Such effects are not unfavourable to the view above taken, as the connection of the centres of intellectual action is probably in no degree necessary to locomotion, which function would no doubt be as well performed without a corpus callosum as with one.

The fibres of the fornix manifest the same insensibility to mechanical irritants, and their obvious anatomical connection with particular convolutions warrants but one conclusion, that they associate the actions of those parts. The connection of this commissure with the optic thalami and the corpora mamillaria indicates that it also associates these gangliform bodies with the convolutions at the posterior part of the brain, and with the hippocampi. A marked relation exists between these latter convolutions and the fornix; they bear, indeed, especially

* Mr. Solly and Mr. Grainger think that they can trace the fibres of the corpus callosum distinctly to the convoluted surface of the hemispheres. With the greatest respect for these able anatomists, I must express my doubts that all the fibres which they have represented can be regarded as fibres of the corpus callosum. See fig. 99 in Mr. Solly's work on the Brain, p. 251, ed. 1847. Although the anatomical views of these writers correspond with and confirm the physiology of the organ advocated in the text, I feel that great caution should be used in drawing conclusions from tracing the fibres of brains *hardened* in alcohol. By these means any speculative anatomist may make preparations to illustrate his views, as is, indeed, abundantly shown by what I must call the fanciful anatomy of the brain put forward by Foville.

† An excellent account is given by Mr. Paget of a case in which the corpus callosum and fornix were imperfect, in the xxixth vol. of the Med. Chir. Trans., accompanied by some very judicious remarks upon the office of those commissures, and an analysis of other similar cases. Mr. Paget refers to some oblique fibres as existing in the corpus callosum, and serving to connect the anterior convolutions of one hemisphere with the posterior ones of the other.

as regards the posterior pillars of the fornix, a direct ratio to each other.

Lallemand relates a case in which the symptoms were altogether limited to mental disturbance, without any affection of the sensitive or motor powers, and the fornix and corpus callosum were found in a state of complete softening without discolouration.

The fibres of the pons Varolii bring the cerebellar hemispheres into connection with each other, and with the vesicular matter of the mesocephale. Direct experiments on these fibres can yield no satisfactory result, because they are so intimately associated with the deeper seated parts of the mesocephale, and with the nerves of the fifth pair and others, that it is impossible to irritate them in the living animal without affecting these parts likewise. The anatomy of the fibres, however, sufficiently indicates that they belong properly to a double cerebellum; for when the cerebellum becomes single, as in birds, reptiles, and fishes, no such fibres are found in the encephalon. Morbid lesion of the pons is productive of very serious results from the number and importance of the parts in its neighbourhood, the pyramids, the medulla oblongata, the quadrigeminal tubercles; so that the symptoms it produces cannot be referred solely to the injury to the commissural fibres. It is very probable, however, that the crossed effect of deep-seated disease of either hemisphere of the cerebellum may be accounted for by the influence of these commissural fibres upon the adjacent anterior pyramids, which again would influence the opposite side of the spinal cord.

Having thus brought to a termination our review of the physiology of the encephalon, I may now sum up the principal conclusions which our examination of this difficult and important subject leads to; and these are embraced in the following propositions.

1. That the encephalon consists of a series of centres, each of which has its proper influence in the exercise of the mental and bodily functions. These are the centre of intellectual actions, the centre of volition, the centre of sensation, the centre of the coordination of muscular movements, the centre of emotion, and the centre of respiration and of deglutition.

2. That the cerebral convolutions, with the fibres which connect them to the corpora striata and optic thalami, constitute the centre of *intellectual action*.

3. That the centre of *volition* consists primarily of the corpora striata; the inferior layers of the crura cerebri, which are continuous with the anterior pyramids, connect these gangliform bodies with the vesicular matter of the crura (locus niger), with the vesicular matter of the mesocephale, medulla oblongata, and with that of the spinal cord (the anterior horns), all of which with the corpora striata probably form the dynamic nervous matter in the impulses of volition for nerves implanted in them respectively.

4. The optic thalami, which by the extension of the olivary columns through the mesocephale

and medulla oblongata to the posterior horns of the vesicular matter of the spinal cord, become continuous with those parts, constitute the centre of *sensation*, having implanted in it or connected with it less directly all the sentient nerves of the body.

The nerves of the higher senses probably have each special ganglia or centres, which, however, are connected with the general centre; as the olfactory lobes for smell; the retina, corpora geniculata, or corpora quadrigemina for vision; the vesicular matter in which the auditory nerves are implanted or the flocks of Reil for hearing; the ganglia of the fifth, glosso-pharyngeal, and posterior roots of spinal nerves for taste and touch.

5. The cerebellum constitutes the centre of the coordination of muscular movements, both in locomotion and in all the complicated movements of the frame.

6. The upper and posterior part of the mesocephale, including probably the greatest portion of the corpora quadrigemina, constitutes a special centre of actions referable to the emotions, among which may be reckoned sexual impulses. This centre connects itself with the medulla oblongata by the olivary columns, and through the same channel with the posterior horns of the spinal vesicular matter.

7. The medulla oblongata constitutes the centre of respiration and deglutition, but it cannot be considered as wholly devoted to these functions, inasmuch as it consists likewise of continuations of the centres of volition, of sensation, and of emotion.*

Of the functions of the ganglions.—That ganglions are small nervous centres we are bound to believe, from the existence in them of a considerable quantity of vesicular matter mingled with fibrous matter. And the views which we have already expressed respecting the dynamic character of the vesicular matter warrant the assumption that wherever a special accumulation of that form of nervous matter is found, there must be a special source of nervous power.

* I have great pleasure in referring the reader to a very able essay on the physiology of the brain, (which I did not see until this article was at press,) in which very similar views to those expressed in the text are advocated, based on comparative anatomy. The author, who in justice to himself ought not to withhold his name, is evidently hampered by his adhesion to the excitatory doctrines. I allude to the Review of Noble on the Brain in Dr. Forbes's Journal for October, 1846. I had already put forward similar opinions respecting the subdivision of the brain and the uses of its parts, in the section headed "*An hypothesis of the action of the brain*," in the article NERVOUS CENTRES, published in 1845, and subsequently republished in a volume entitled "*The physiological and descriptive Anatomy of the Brain, &c.*" chap. xii., and the same views were expressed in Mr. Bowman's and my "*Physiological Anatomy and Physiology of Man*," part ii. 1845, p. 291 and p. 374. I may add that the review to which I refer contains a very complete and masterly exposition of the weakness of the present system of phrenology.

There are certain facts connected with the larger nervous centres which strongly indicate the correctness of this assumption. Thus, the existence of special accumulations of vesicular matter connected with them, where any particular development of the nervous force is needed, is much in favour of this view. As instances, we may cite the special electrical lobes in the electrical fishes, the ganglionic enlargements on the medulla oblongata of the gurnard, the median lobe, occupying a similar position to the electrical lobe above referred to, which is found in the remora or sucking-fish, and from which nerves are supplied to the suctorial disc on the head of that animal. Allied to these is the remarkable fact pointed out by Professor Sharpey, that the arms of the cuttle-fish contain ganglia which furnish nerves to the suckers which exist upon them in great number. Furthermore, the anatomy of the nervous system in some of the Mollusca, the Conchifera for example, in which a separate *ganglion* appears to exist for each function, for respiration, for locomotion, for deglutition, &c., is beautifully illustrative of the office of ganglia.

When, however, we come to inquire into the office of the particular ganglia which exist in Man and the Vertebrata, it is, in some instances, difficult to determine what object can be gained by a special evolution of nervous force by some of them. It may be inquired what is the function performed by the ganglia on the posterior roots of spinal nerves, on the large root of the fifth, on the glosso-pharyngeal, on the vagus nerves? Can it have reference, as already suggested in a former part of the article, to the part which these nerves perform in connection with tactile sensibility or with the sense of taste, as in the fifth and glosso-pharyngeal, in analogy with the ganglia attached to the olfactory and optic nerves, and probably with the auditory? Or have these ganglia anything to do with the nutrition of the parts among which their nerves are distributed, as Dr. M. Hall suggests, in which case they would present an obvious analogy, and might be classed with the sympathetic ganglia?

The data which would assist in coming to a right conclusion upon this subject are so few, that, with our present knowledge, it is impossible to form anything like a distinct hypothesis regarding it. I would remark with reference to the last-mentioned conjecture that it would receive great support if gelatinous nerve-fibres were found to take their rise from the ganglia and to follow the course of bloodvessels.

With regard to the use of the ganglia of the sympathetic, the proved existence of gelatinous fibres, peculiar to these ganglia and taking their rise from them, distinctly indicates that they are the seat of a special development of nervous power, whether spontaneously arising in the nutrient changes of ganglia, or by the reflexion of a change propagated to them by afferent nerves implanted in them. The various facts which show that the sympathetic system enjoys an existence and power independent of the cerebro-spinal axis also confirm this view.

But we must enquire further what is gained

by the passage of certain nerve-fibres through these ganglia, as is the case with most if not all the tubular fibres connected with them? It may be that in their passage through the ganglia the tubular fibres acquire an arrangement in new sets or fascicles in a manner analogous to that which occurs in the plexuses. But this can scarcely be the only object of this connection. Do these fibres associate the cerebro-spinal centres with the ganglionic system? or do they themselves in passing again through vesicular matter experience some modification in their vital endowments? These questions cannot be satisfactorily solved in the present state of our knowledge.

BIBLIOGRAPHY OF THE ANATOMY AND PHYSIOLOGY OF THE NERVOUS SYSTEM.

I. *Of the Nervous System in general.*

Aristotle, *Historia Animalium*. *Galen*, *De administrat. anatom.* *Vesalius*, *De corp. humani fabrica*, Basil, 1555. *Willis*, *Opera omnia*, 1682. *Viessens*, *Neurographia universalis*, 1684. *Haller*, *Elementa Physiologiæ*, t. iv. 1762. *Whytt*, *On the vital and other involuntary motions*, 1752, and on *Nervous diseases*, 1762. *Unzer*, *Gundriss eines Lehrgebäude von der Sinnlichkeit der thierischen Körper*, 1768; also *Erste Gründe einer Physiologie der eigentlichen thierischen Natur thierischen Körper*, 1771. *Monro secundus*, *On the nervous system*, Ed. 1783. *Prochaska*, *Geo.*, *De functionibus systematis nervosi*, fascic. tertius, Annotat. *Academ.* Prag. 1784, (vid. also his other works, enumerated p. 721F.) *Gall* et *Spurzheim*, *Sur le Systeme Nerveux*, 1809. *Bell's Idea* of a new Anatomy of the Brain, 1811. *The systems of Physiology of Treviranus*, *Richerand*, (in English, by Dr. Copland), *Bostock*, *Adelon*, *Blumenbach*, *Elliotson*, *Magendie*, *Mayo*, *Alison*, *Müller*, *Wagner*, *Carpenter*, *Todd* and *Bowman*; *Bell*, in *Phil. Tran.*, Lond. and Ed., and collected in an 8vo vol., Lond. 1844. *Georget*, *De la Physiologie du Syst. Nerv. et specialement du cerveau*, 1821. *Magendie* et *Desmoulins*, *Anat. des Systemes Nerveux des Animaux Vertébrés appl. à la physiologie*, 1825. *Magendie*, *Leçons sur les fonctions et les maladies du Syst. Nerv.* 1841. *Longet*, *Anat. et Phys. du Syst. Nerv.* 1842. *M. Hall's works*, 1832-1843; vid. ant. p. 721U. *Mayo*, *The Nervous System*, 1842; *Flourens*, *Recherches exp. du Syst. Nerv.*, ed. 2de, *Par.* 1842. *Carpenter's Lectures on the Nervous System*, Lond. *Med. Gazette*, 1841. *Valentin*, *De functionibus Nerv. Cerebr. et Nerv. Sympath.*, 1839. *Volkmann*, *art. Nervenphysiologie*, in *Wagner's Handwörterbuch*.

II. *Of parts of the Nervous System.*

THE BRAIN. *Malpighi*, *De cerebro*; et *de cerebri cortice*, opera, Lond. 1686. *Ridley H.*, *The Anat. of the Brain*; and in Latin, *Lugd. Bat.* 1725. *Morgagni*, *Adversaria Anatom.* 1741. *Albinus*, *De cortice et medulla cerebri* in *Acad. Annot.*, 1725-29. *Tarin*, *Adversaria Anatom.* 1750. *Lorry*, *Mém. de l'Acad. des Sc.* 1760. *Zinn*, *Dissert. sistens experimenta circa corpus callosum*, &c. in *vivis animalibus instituta*, *Gotting.* 1749, and in *Haller's Dissert. Anat.* t. vii. *Ludwig*, *Scriptores Neurologici minores*, containing papers on the brain by *Meckel*, *Murray*, *Sömmering*, &c. *Malacarne*, *Encefalotomia nova universale*, 1780, et *Nervo-encephalotomia*, 1791. *Sömmering*, *De basi encephali et orig. nerv. cranio eredientium*, in *Ludwig*, *Script. Neurol. min.* t. ii. 1792; *De lapillis intra gland. pineal. sitis*, sive *de acervulo cerebri*, in *Ludwig*, t. iii.; *Vom Hirn und Rückenmark*, 1788; *Über das Organ der Seele*, 1796; *Tabula baseos encephali*, 1799; *Quatuor hominis adulti encephalum describentes tabulas comment. illust.* E. d'Alton, *Berlin*, 1830. *Vicq d'Azyr*, *Various papers* in *Mém. de l'Acad. des Sc.* 1781-1783; *Traité d'Anat. et de Phys.*

avec des planches; prem. partie, organes contenu dans la boîte assésée du crane, 1786-90; Œuvres complètes, edit. Moreau, t. vi. *Rudolphi*, Comment. de ventriculis cerebri, 1796, et in Anat. Phys. Abhandlung: 1802. *Chaussier*, Exposition sommaire du Cerveau, 1807. *Wenzel*, Ch. et Jos. Prodromus einer Werke über das Hirn der Menschen und Thieren, 1806; *Eorundem*, De penitiori structura cerebri hominis et brutorum, 1812. *Cuvier*, Rapport à l'Institut, sur un Mém. de Gall et Spurzheim, 1808. *Gall* et *Spurzheim*, Sur les fonctions du cerveau et sur celles de chacune de ses parties, 1822-25; *Spurzheim*, The Anatomy of the Brain, &c. by R. Willis, 1826. *Gall*, *Vimont*, *Broussais*, On the functions of the cerebellum, by Geo. Combe, with answers to the objections against phrenology urged by Roget, Rudolphi, Pritchard, and Tiedemann, 1838. *Reil's* Memoirs on the brain, in Reil's Archiv. für die Physiologie, and translated in Mayo's Anat. and Phys. Comm. 1822-23. *Ribes*, Exposition sommaire des recherches faites sur quelques parties du cerveau, Gaz. Méd. 1839. *Carus*, Versuch einer Darstellung des Nervensystems, 1814. *Burdach*, Vom Bau und Leben des Gehirns, 1819-26. *Rosenthal*, ein Beitrag zur Encephalotomie, 1815. *Gordon*, System of Human Anatomy, vol. i. 1815, and Observations on the structure of the Brain, comprising an estimate of the claims of Drs. Gall and Spurzheim to discovery in the anatomy of that organ, 1817. *Doellinger*, Beiträge zur Entwicklungsgeschichte des Menschlichen Gehirns, 1814. *Tiedemann*, Anat. und Bildungsgeschichte des Gehirns in fetus des Menschen, 1816; and in English, by Bennett, Anat. of the Fœtal Brain, 1826. *Ejusdem*, Icones cerebri simiarum et quorundam mammalium rariorum, 1821. *Ejusdem*, On the brain of the Negro compared with that of the European. Phil. Trans. 1836. *Lauth*, Recherches sur la structure du cerveau et de ses annexes, in Journ. Compl. du Dict. des Sc. Méd., 1819. *Rolando*, Saggio sopra la vera struttura del cervello e sopra le funzioni del Sistema Nervoso, 1828. *Serres*, Anat. Comp. du Cerveau, 1824. *Laurentet*, Anat. Comp. du Cerveau, 1826. *Hertwig*, Experimenta quædam de effectibus læsionum in partibus encephali, 1826. *Mayo*, a series of engravings intended to illustrate the Structure of the Brain, 1827 (the best plates of the brain extant). *Langenbeck*, Icones Anat. Neurologica, 1830. *Arnold*, Tabule Anat. Fascic. 1, Icones Cerebri et Medullæ Spinalis, 1838. *Bourgety*, Traité Compl. de l'Anat. de l'Homme (now in course of publication). *Leuret*, Anat. du Systeme Nerveux considéré dans ses Rapports avec l'Intelligence, 1839. *Wilbrand*, Anat. und Phys. der Centralgebilde des Nervensystems, 1840. *Stilling*, Disquisitiones de aetura et funct. Cerebri, 1846. *Ejusd.*, Über die textur. und funct. der Medulla Oblong., 1843. *Par-chappe*, Gaz. Méd., 1842. *Foville*, Traité Complet de l'Anat. Phys. et Pathol. du Syst. Nerveux Cerebro-spinal, 1844, P. 1. *H. Jones*, On the structure of the Cerebellum. Lond. Med. Gaz., 1844. *Baillarger*, Recherches sur la Structure de la Couche Corticale du Cerveau, Mém. de l'Acad. de Méd., 1840. *Reid*, J., M.D., On some points in the Anatomy of the Medulla Oblongata, Ed. Med. and Surg. Journ., Jan. 1844. *Swan*, The principal officæ of the Brain and other Centres, 1844. *Todd*, The Descriptive and Physiological Anat. of the Brain, Spinal Cord, and Ganglions, 1845. *Solly*, The Human Brain, its Structure, Physiology, and Diseases, 2nd ed., 1847. The various systems of anatomy, especially *Hildebrandt* by *Weber*; *Cruveilhier*; *Soemmering*, by *Valentin*; *Meckel*; *Bell*; *Quain* and *Sharpey*.

THE SPINAL CORD AND ITS NERVES: *Huber*, De Medulla Spinali, 1741. *Frotscher*, Descript. Medul. Spinalis, ejusq. Nervorum, 1788, and in *Ludwig*, Script. Neurol. Min., t. iv. *Keuffel*, Dissert. de Medul. Spinal., 1810, and in *Reil's* Archiv, t. x. *Nicolai*, Dissert. de Medulla Spinali avium,

1811. *Rachetti*, Della Struttura, delle Funzioni, et delle Malattie della Medull. Spinal., 1816. *Magendie*, Examen de l'Action de quelques Vegetaux sur la Moëlle Epiniere, 1809. *Ejusd.*, Sur le Siege du Mouvement et du Sentiment dans la Moëlle, Journal de Physiol. Experim., t. iii. *Bellingeri*, De Medulla Spinali et Nervis ex ea procedunt. 1823. *Rolando*, Ricerche Anatom. sulla Struttura dell. Midoll. Spinale, 1824, and in Journ. Comp. de Dict. des Sc. Méd. *Fodera*, Rich. Experiment. sur le Syst. Nerv., Journ. de Phys. Exp., t. iii, 1823. *Calmeil*, Rech. sur la Structure, les Funct., et le Rammolissement de la Moëlle Epiniere, in Journ. des Progr., 1828. *Backer*, Commentatio ad Quæst. Physiolo. a Facult. Medic. Acad. Rheno Trajectanæ, anno 1828, proposit. 1830. *Seubert*, Commentat. de Functionib. Radic. Anterior et Post. Nerv. Spinal., 1833. *Olivier*, Traité de la Moëlle Epiniere et de ses Maladies, 1837. *Grainger*, Observations on the Structure and Functions of the Spinal Cord, 1837. *Volkman*, Über Reflexbewegungen, Müller's Archiv, 1838. *Longet*, Recherches Exp. et Pathol. sur les Fonctions des Faisceaux de la Moëlle Epiniere, Arch. Gén. de Méd., 1841. *Stilling* and *Wallach*, Untersuch. über die Textur. des Rückenmarks, 1842. *Van Deen*, Traité et Decouvertes sur la Physiologie de la Moëlle Epiniere, 1841. The Treatises on Anatomy and on Physiology already referred to.

THE INTIMATE STRUCTURE OF NERVES, GANGLIA, AND OTHER NERVOUS CENTRES. *Leuwen-hoeck*, Opera Omnia, t. i. and liv., 1722. *Della Torre*, Nuovi Osservazioni Microscopici, 1776. *Prochaska*, De Structura Nervorum, 1779. *Monro*, Microscopical Enquiries into the Nerves and Brain, 1780. *Fontana*, Traité du Venin de la Vipere, t. ii. 1781. *Scarpa*, Annot. Acad. de Nervor. gang. et plexib., 1792. *Pfeffinger*, De Structura Nervorum, in Ludwig Script. Neurol. Minora, t. i. *Home*, Phil. Trans., 1821, 1824, 1825. *Mascagni*, Prodromo della Grande Anatomia, 1819. *Treviranus*, Beiträge zur Aufklärung des Organ. Lebens, 1836. *Ehrenberg*, Beobachtung einer bisher unibekanntem Auffallenden Struktur des Sielenorgans bei Menschen und Thieren, Mém. de l'Acad. de Berlin, 1836, translated in the Ed. Med. and Surg. Journal. *Remak*, Müller's Archiv., 1836. *Ejusdem*, Observat. Anat. et Microscop. de Systematis Nervosi Structura, 1838. *Schwann*, Müller's Archiv., 1836, et Mikroskop untersuch. *Burdach*, Beiträge zur Microscop. Anat. der Nerven, 1837. *Emmert*, Endigungsweise der Nerven in den Muskeln, 1836. *Valentin*, Über den Verlauf und die letzten Enden der Nerven, 1836. *Purkinje*, Bericht über die Versamml. d. Aerzte und Naturf. in Prag, 1833. *Rosenthal*, De formatione granulosa in Nervis aliisq. partibus organismi animalis, 1839. *Hannover*, Recherches microsc. sur le Systeme Nerveux, 1844. *Johnston*, On the use of Ganglions of the Nerves, 1771. *Haase*, De Gangliis Nervorum, 1772, and in *Ludwig*, Script. Neurol. Min.; *Volkman* und *Bilder*, Die Selbstständigkeit des Sympath. Nervensystem, 1842. *Kölliker*, Die Selbstständigkeit und Abhängigkeit des Sympathischen Nervensystems, 1844. *Henle*, Algem. Anat., 1841. *Brunn*, Alg. Anat., 1841. *Gerber*, Handbuch der Allgemein Anat. des Menschen und der Haussaugethiere, 1840, and in English by Gulliver, 1842. *Budge*, Müller's Archiv., 1844. *Wagner*, Neue untersuchung. über den Bau und die Endigung der Nerven, und die Struktur der Ganglien, 1847. (This work contains a confirmation and extension of Savi's statement respecting the subdivision of the primitive fibres of the nerves in the electrical organ of the torpedo. Wagner shows that the subdivision takes place by the breaking up of one primitive fibre into numerous filaments, from each of which a network is formed among the elements of the electrical organ. He describes a somewhat similar arrangement of the nerves in muscles.)

(R. B. Todd.)

NINTH PAIR OF NERVES (*Nervi hypoglossi, vel gustatorii*, Winslow; *Lingualis*, Vic d'Azyr; *Ninth nerve* of Willis; *Twelfth of Sæmmering*.) The ninth pair of nerves take their origin from the side of the medulla oblongata, commencing by a variable number of small radicles in the fissure which separates the corpus olivare from the pyramidale.

The superior of these radicles are attached about the centre of this fissure, and the inferior a little below its termination; they are placed on a line one below the other, which line describes a slight curve looking upwards and backwards, following the curved form of the olivary body.

The origin of this nerve is superior to that of the first cervical, to which also it lies on a plane a little anterior; it is separated from the origins of the par vagum by the olivary body, and has lying immediately in front the corpus pyramidale and the vertebral artery.

The radicles which form the origin of this nerve vary in number from five to ten or twelve; and if any of these radicles be examined closely, they will be found to consist of two or more minor filaments, so that it is very difficult to say exactly by how many roots or origins the ninth nerve is attached to the medulla spinalis.*

These filaments in general unite into two fasciculi, which pass in a direction downwards, forwards, and outwards to the anterior condyloid foramen, through which the nerve escapes from the cavity of the cranium.

It rarely happens that these fasciculi unite in the cavity of the cranium; in general, they pass on separately until they reach the foramen, where in passing through the dura mater they become united into one trunk, which is here invested with a strong neurilemma, derived from the dura mater.

The ninth pair of nerves, on emerging from the anterior condyloid foramen, is in close relation to the eighth pair of nerves, the internal carotid artery, internal jugular vein, and with the superior cervical ganglion of the sympathetic.

Here the nerve lies external to the vagus. Connected to it by a dense cellular tissue, for a space about the eighth of an inch, it passes behind the internal carotid artery immediately before that vessel enters the carotid canal, and lies in front of the jugular vein; here also the nerve is connected to the anterior and superior part of the superior cervical ganglion, in a manner to be presently described.

In this situation the ninth nerve lies deep in the neck, being covered by the origins of the styloid muscles, the posterior belly of the digastric, the sterno-mastoid, the skin, platysma, and fascia.

The trunk of the nerve then passes downwards, outwards, and slightly forwards, escapes from beneath the posterior belly of the digas-

tric and anterior edge of the sterno-mastoid, becomes more superficial, is crossed in this part of its course by the occipital artery, and at a point in the neck corresponding to the level of the third cervical vertebra,* and opposite the angle of the jaw,† the nerve turns forwards and upwards, forming an arch, the convexity of which looks downwards and backwards; here the nerve is covered only by the skin, platysma, and fascia, crosses and lies in front of the origin of the occipital artery, the internal jugular vein, external carotid artery, and vagus nerve; passing still inwards and upwards towards the posterior edge of the hyoglossus muscle, the nerve is crossed by the tendon of the digastric, lying here superior to the lingual artery.

It then passes between the mylo-hyoid and the hyo-glossus, and having reached the anterior edge of the last-named muscle, it enters and passes through the fibres of the genio-hyoglossus, in the substance of which muscle it divides into its terminating branches, the connections and distribution of which shall be examined after we have considered the connections of this nerve and the branches which it gives off and receives in its course through the neck.

The ninth nerve, on escaping from the anterior condyloid foramen, is connected to the par vagum, as was before noticed, by dense cellular tissue, but also by a nervous filament; further on, as the ninth nerve approaches the transverse process of the atlas, it receives a twig from the first cervical nerve, or from the nervous loop formed round the transverse process of the atlas by the communicating branches of the first and second cervical nerves.‡

In this situation, also, the ninth is connected by a small nerve with the superior cervical ganglion.

Ramus cervicalis descendens, seu descendens noni.—The next regular branch given off by this nerve is immediately before it turns in front of the jugular vein and carotid artery, when it gives off a large and regular branch called cervicalis descendens, or descendens noni.

The point at which the ninth nerve gives off this branch is immediately below the angle of the jaw, and where it escapes from under the edge of the sterno-mastoid muscle. The descendens noni from this passes downwards and forwards to the inferior part of the neck; at its origin this nerve frequently receives a twig from the par vagum; it passes down the neck in front of the jugular vein and carotid artery, crossing these vessels obliquely, being in this course superficial to the cellular investment derived from the cervical fascia which constitutes the sheath of these vessels.

Omo-hyoid branch.—About the centre of the neck, the cervicalis descendens gives off a considerable branch, which, passing in a direction upwards and inwards, enters the interior belly

* Quorum incertus numerus causa est, cura a variis varie descriptæ et delineatæ existit. Alii enim quatuor, alii octo componi fasciculis dixerunt.—Sæmmering de Basi encephali et originibus nervorum, page 168.

* See Meckel, Manuel d'Anatomie, vol. iii. page 53.

† See Boyer, Traité d'Anatomie, vol. iii. p. 359.

‡ See Traité d'Anatomie, Boyer, vol. iii. p. 359.

of the omo-hyoid muscle, in the substance of which it ramifies.

Plexus.—Immediately below the tendon of the omo-hyoid, the descendens noni, uniting with branches given off by the second and third cervical nerves, forms a nervous arch, the convexity of which looks downwards and forwards. This plexus lies under cover of the sterno-mastoid, and in front of the jugular vein.

Sterno-hyoid and thyroid branches.—From the convexity of the arch formed by this plexus two or sometimes more nerves proceed downwards and inwards, and ramifying on the superficial surface of the sterno-hyoid and thyroid muscles, are distributed to them.

Cardiac branch.—Meckel states, that on the left side particularly he has been able to trace a branch from this plexus into the thorax along the pericardium as far as the heart. The cervical descendens is observed sometimes to vary from the above description, in its course down the neck, and in its relation to the great vessels; for, instead of lying anterior and external to the sheath, it is occasionally found to pass down within the sheath, and sometimes even behind it. I have also seen it pass for a short distance within the sheath in the upper part of its course, becoming superficial about the centre of the neck, and then running down in front of the sheath in the usual manner.

These varieties in the course and relations of this nerve are not, however, very commonly met with.

Thyro-hyoid branch.—The next branch given off by the ninth pair is where the nerve is passing under the tendon of the digastric, a little above the cornu of the os hyoidei. Here it gives off a considerable branch named thyro-hyoid, from its distribution. This nerve passes from its origin downwards and inwards, crossing the lingual artery, to which it lies superficial, and is distributed to the thyro-hyoid muscle.

From the origin of the thyro-hyoid branch the ninth nerve passes inwards between the hyoglossus and mylo-hyoid muscles, and at the anterior edge of the hyoglossus it plunges into the genio-hyoglossus, in the substance of which its terminating branches ramify. In this course the ninth nerve supplies filaments to the mylo-hyoid, the hyoglossus, the genio-hyoid, genio-hyoglossus, and lingualis.

In the substance of the genio-hyoglossus the branches of the ninth nerve form distinct anastomoses with branches of the fifth (the gustatory); with this nerve the branches of the ninth form nervous loops or arches, the convexities of which look forwards, and from which branches pass off which may be traced to the mucous membrane of the tongue. There can be little doubt that these nerves are to be considered as compound, containing filaments derived both from the ninth and fifth pair. Most anatomists state, that the ultimate branches of the ninth can be traced no further than the structure of the muscles which enter into the formation of the tongue, and this appears to be true with respect to the branches which do not

anastomose with the fifth pair; but it is more than probable, although difficult to demonstrate, that from the anastomosis spoken of above, a nerve, composed of filaments both of the ninth and fifth, proceeds, and is distributed to the mucous membrane of the tongue.

Comparative anatomy.—It has been asserted by Professor Mayer, that in the ox and some other Mammalia he has discovered a small posterior root to the ninth nerve, having on it a ganglion; to the investigation of this I have paid particular attention. I have repeatedly and with care sought for this posterior root and ganglion in the ox, and have never been able to satisfy myself as to the existence of a true posterior root to this nerve.

The anatomy, however, of this part in the ox is extremely interesting, and when examined may, perhaps, explain Mayer's opinion.

In the dissections which I have made of the ninth pair in the ox, the nerve was found to arise in the depression between the corpus olivare and pyramidale by several delicate roots, in a manner very similar to what is observed in the human subject; these roots uniformly formed two bundles, which perforated the dura mater separately, before doing which, however, the most inferior of these two bundles received a twig, which at first sight appeared to be given off by the spinal accessory; but, upon further and careful dissection, this twig was found not to come from the spinal accessory, but to arise by a number of distinct roots from the side of the medulla spinalis, anterior to the roots of the spinal accessory, in front of and distinct from which it passed up into the cranium, and joined the inferior of the two bundles, which formed the origins of the ninth, and uniting with this passed out through the anterior condyloid foramen.

When this nerve was cleansed, the pia mater and coagulated blood removed, which always loads these parts in the slaughtered ox, no enlargement or any thing resembling a ganglion could be discovered on its course. This nerve cannot be considered a posterior root to the ninth pair, for its origin from the medulla is anterior to that of the spinal accessory; and I am inclined to think that this nerve in the ox holds the same relation to the ninth that the spinal accessory does to the eighth. Can this be what Mayer supposes to be a posterior root to the ninth?

Winslow speaks of a communication between the spinal accessory and ninth nerve within the cranium, the existence of which in the human subject is described by Scarpa and Meckel;* I have never been able to trace any such communication in man.

On tracing the ninth nerve in the ox through the anterior condyloid canal, it was found to be united into one trunk, and enveloped with a strong neurilemma; nor could any ganglion be detected on the nerve in this part of its course.

In Birds, the ninth nerve is found to commu-

* See Manuel d'Anatomic, Meckel, vol. iii. p. 59.

nicate with the par vagum, to divide into two branches, one of which is distributed to the tongue and the other to the œsophagus. Müller states, that in the rattlesnake he has found this nerve escaping from the cranium by a special opening behind that for the eighth pair, with which it communicates, as also with the first cervical.*

In Fishes, the last cerebral nerve is described by Weber as arising by three roots, the posterior having a ganglion, and passing out of the cranium by a special foramen in the occipital bone, and being distributed to the pectoral fin.

From these circumstances Müller conceived that an analogy exists between the hypoglossal, or ninth nerve, and the spinal nerves, and says, "If we now take into consideration that the first spinal nerve in the human subject has sometimes only an anterior root, and that the hypoglossal in man has only an anterior root, but that in some mammalia (according to the hypothesis of Mayer) it has a posterior root also, it will be evident that the hypoglossal nerve belongs to the class of spinal nerves, and is as it were the first spinal nerve, which, however, generally passes out through a foramen in the cranium; this consideration renders the analogy between the last cerebral nerve in fishes and the hypoglossal nerve still greater."†

Physiology.—That the ninth pair is the nerve which influences the motions of the tongue is generally admitted, and that it deserves the name given to it of *motor lingua* has been proved by the experiments of Mayo, Majendie, and Müller.

When in the living animal this nerve is exposed and excited by pinching or galvanism, violent spasms of the entire tongue are produced, and its division is followed by paralysis of that organ.

On this subject Mayo performed the following experiment. "I divided the ninth nerve on one side of the tongue in a dog; the animal did not seem much incommoded, but lapped up milk readily. I then divided the nerve on the opposite side; the animal appeared distressed, and did not again lap up the milk offered to it, though it smelt to it; and finally, when mustard was smeared on its nostrils, it made no use of its tongue to remove it, though evidently suffering from it."‡ Further, Mayo found that when the nerve was divided on both sides in a rabbit, and the tongue drawn out of the mouth, the animal had not the power of again retracting it.

A very interesting case is related by Montault and quoted by Müller, where a tumour pressing on the ninth nerve of the left side at its exit from the cranium produced an atrophy of this nerve; the symptoms were paralysis of the left side of the tongue with gradual wasting of the organ on that side; but the sense of taste was not in the least affected, being as perfect on the paralysed side as on the other.

We are warranted from these facts in consi-

dering the ninth nerve as that which influences the motions of the tongue in articulation and deglutition; but, besides directing the motions of the tongue, the ninth nerve influences the motions produced upon the os hyoides by the sterno-hyoid, sterno-thyroid, and thyro-hyoid muscles, which muscles receive branches, as before described, from the ninth and cervical plexus. The importance of this connection in action of these muscles with the tongue, in the performance of the functions of articulation and deglutition, is obvious; and in the turkey Müller has found a long branch going from this nerve to supply the muscles which in that bird shorten the trachea.

It is asserted that the ninth nerve, in addition to its motor influence, is also endowed with a certain degree of sensibility, and that, if the nerve be stretched or pinched in a living animal, there is evidence of the animal suffering pain; this has been tried on dogs and cats. Now if in these animals this nerve has a double origin, this would be easy to understand; but Mayer himself could not detach a posterior root in the cat; so that if this nerve, either in man or other animals, has any of the properties of a nerve of sensation, it is owing to the filaments which it receives from the cervical plexus. But the degree of sensibility communicated to the tongue through the influence of this nerve in this way must be very trifling; and it is now as well proved that the tactile sensibility of the tongue is owing principally to the influence of the gustatory branch of the fifth, as that the motions of that organ are directed by the influence of the ninth pair.

(G. Stokes.)

NOSE. (Human Anatomy).—(Gr. $\acute{\nu}\rho$; Lat. *Nasus*; German, *Nase*; French, *Nez*; Italian, *Naso*; Dutch, *Neus*.) The nose is the organ of the sense of smell, and a part of the apparatus of respiration and voice, and in accordance with the variety of its offices is complex both in form and in structure, many different tissues entering into its composition. The most simple method of describing its anatomy in man is the synthetical; I shall therefore give an account, first, of its skeleton, composed of bones and cartilages; and then, in succession, of each of the parts placed on the skeleton, and subservient to its several functions.

The *bones of the nose* are chiefly concerned in the formation of the internal deeply-seated part of the organ, that part which is called the nasal fossæ, (*cavæ nares*, or *nares internæ*,) or the cavities of the nose. These cavities are open widely anteriorly to the atmosphere, and posteriorly to the pharynx. The anterior aperture is, in the osseous skeleton, heartshaped, broader below than above, bounded below and on each side by the palatine and ascending processes of the superior maxillary bones, and above by the nasal bones. Its borders are, in the lower half, smoothly rounded; in the upper half, sharp and uneven. Below and in the middle line the anterior nasal spine projects forwards and upwards; and above it is the osseous septum, which divides the fossæ into two equal cr

* Elements of Physiology.

† See Elements of Physiology.

‡ See Mayo, Commentaries, part ii. p. 11.

nearly equal portions, but of which the lower part alone reaches to the anterior aperture.

The posterior aperture of the nasal cavities is quadrilateral. It is bounded below by the palatine plates of the palate bones, with the posterior nasal spine formed at their junction; on each side by the internal pterygoid plate of the sphenoid bone; and above by the alæ of the vomer and the body of the sphenoid bone. The posterior edge of the vomer divides it into two equal lateral parts.

The space of which these are the apertures is altogether irregular in its form, but each of the halves into which it is divided by the septum may be described as having four walls or boundaries, a superior, inferior, and two lateral. The superior wall or vault of each cavity of the nose is formed in front by the posterior surface of the nasal bone; above and in the middle by the inferior surfaces of the nasal spine of the frontal, and of the cribriform plate of the ethmoid bone; behind by the anterior and inferior surfaces of the body of the sphenoid bone, and its turbinated bone, and by the ala of the vomer. The anterior part of this wall looks downwards and backwards, and presents shallow branched grooves in which branches of the internal nasal nerve lie, and one or more apertures through which one of those branches and an artery or two pass. The middle part of the wall is nearly horizontal, and is perforated by many apertures for the branches of the olfactory nerve, and for the internal nasal nerve; the posterior part looks downwards and forwards, and presents an aperture leading into the sphenoidal sinuses.

The lower wall or floor of the nasal cavity is nearly horizontal: it is concave transversely, a little raised at each end, and narrower before

than behind. It is formed by the upper surfaces of the palatine plates of the superior maxillary and palate bones, and its inner border is a little prolonged both behind and before upon their nasal spines. Near its anterior border it is perforated by the superior orifice of the anterior palatine canal.

The outer wall is the most complicated. (Fig. 399.) If a vertical line be drawn downwards from the base of the nasal spine of the frontal bone (*a*), it will have in front of it the plain part of this wall, a slightly concave triangular surface, formed by the ascending process of the superior maxillary bone (*b*), and presenting nothing but some shallow grooves for bloodvessels and nerves. And, if a similar line be drawn downwards from the front of the body of the sphenoid bone (*c*), it will have behind it another plane surface formed by the internal pterygoid plate (*d*). Between these vertical lines there is a large quadrilateral surface divided into three parts by the three turbinated bones, whose edges project in nearly parallel and horizontal lines, at about equal distances one above the other. At the upper part of this surface and anteriorly is a thin quadrilateral plate (*e*) belonging to the cellular portion of the ethmoid bone, made very rough by grooves and apertures which lodge branches of the olfactory nerve. The anterior part of this plate forms the inner wall of the anterior ethmoidal cells; the posterior part (*f*) is a little curved outwards, and leaves a space between its surface and the body of the sphenoid bone into which the sphenoidal sinus opens. The lower border of this plate is continuous anteriorly with the inner surface of the middle turbinated bone, and posteriorly has a free margin which is slightly curled outwards. From the form of this margin the plate is called the superior turbinated bone, (*cornet superior*; *oberste Muschel*;) and the space which it here covers, and which is a kind of horizontal channel between its outer surface and the wall of the adjacent ethmoidal cells, is the *superior meatus* of the nose. Into this meatus the posterior ethmoidal cells open, usually by two or more orifices concealed by the turbinated bone; behind and a little below it is the spheno-palatine foramen (*h*), at which the nasal branches from the spheno-palatine ganglion and the spheno-palatine vessels enter the nose; and yet further backward, and nearly opposite the end of the superior turbinated bone, is the opening into the sphenoidal sinuses.

Below this upper plate, and continuous with it anteriorly, is the inner surface of the *middle turbinated bone* (*g*), another portion of the ethmoid bone, (*cornet moyen*; *mittlere Muschel*.) It is larger than the superior, more convex on its inner surface, and presents a free margin through the whole extent of its lower border which is thick, and abruptly curled outwards, and sometimes has cavities within it (*sinusæ of Santorini*), communicating with the ethmoidal cells. The inner surface of the bone is deeply grooved and perforated by bloodvessels and branches of the olfactory and nasopalatine nerves. Of the grooves, those which lodge

Fig. 399.

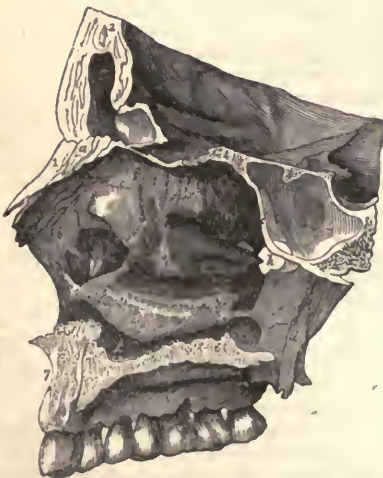

View of the outer wall of the nasal cavity on the right side.

1, nasal bone; 2, frontal bone; 3, frontal sinus; 4, sphenoidal sinus; 5, palatine surface of the hard palate; 6, edge of the palate bone; 7, anterior edge of the superior maxillary bone.

the olfactory nerves run from above downwards, and those in which the naso-palatine nerves lie are directed forwards; at its lower margin also is a particular groove in which a large blood-vessel runs. The outer surface is concave and smoother than the inner, and forms the inner boundary of the *middle meatus* of the nose. On the outer wall of this meatus, which is a much larger channel than the superior one, extending through nearly the whole length of the outer wall of the nasal fossæ, there are presented from before backwards, after removing the turbinated bone,—1. a part of the ascending process of the upper jaw-bone; 2. part of the inner surface of the lachrymal bone; 3. the walls of some of the anterior ethmoidal cells; 4. the *infundibulum*, a long, narrow, and slightly curved passage, leading obliquely upwards and forwards into the anterior ethmoidal cells, and through them into the frontal sinuses; 5. the entrance into the antrum, a large aperture of uncertain size and form; and, lastly, a flat surface of the vertical plate of the palate bone.

Below the middle meatus is the *inferior turbinated bone*, the largest of the three, and usually described as a separate bone, because it is not so soon united to the adjacent bones. It is very uncertain in form and size; its depth especially varies; so that its lower border sometimes nearly touches the floor of the nasal cavity, and sometimes is half an inch above it; sometimes, also, it is so much curled outwards that it nearly forms a canal between its outer border and the outer wall. On the whole, however, this turbinated bone presents the same general characters as the others. Its upper margin is fixed to a prominent ridge along nearly the whole length of the outer wall of the nasal fossæ; its lower margin is free, and its outer surface forms the inner boundary of the *inferior meatus* of the nose, of which the outer boundary is formed by the ascending plates of the superior maxillary (*k*) and palate bones. At the anterior part of this meatus is the inferior orifice of the nasal canal, a passage flattened at its sides, larger at its extremities than in the middle, and passing, with a slight anterior curve, upwards, forwards, and a little outwards to the inner angle of the orbit. It lodges the nasal duct. At the level of this meatus also, behind the edge of the internal pterygoid plate, and about midway between the floor of the nose and the end of the inferior turbinated bone, is the opening of the Eustachian tube; but nothing of this is seen in the skeleton.

The inner wall of each cavity of the nose is formed by the *septum*, a median partition composed of the perpendicular plate of the ethmoid bone, and the vomer, whose edges correspond to ridges formed at the median sutures of the nasal, superior maxillary, and palate bones, and on the inferior surfaces of the frontal and sphenoid bones. The septum is not commonly quite vertical: it may lean to either side, or may be curved slightly in both directions, or may be convex on both sides and have a cavity in its interior. Each of its sides exhibits at the upper and back part the grooves of some of

the olfactory nerves, becoming more shallow as they descend; and in various parts it is slightly marked by the passage of bloodvessels and other nerves.

Thus, the bones which form the proper cavities of the nose are fourteen; viz.—the two nasal, two superior maxillary, two palatine, the two inferior, and two sphenoidal turbinated, bones, the frontal, ethmoid, sphenoid, and vomer. And, with the space which these enclose, many adjacent cavities communicate; viz.—1. The frontal sinuses, which open through the anterior ethmoid cells and infundibulum into the middle meatus. 2. The anterior ethmoid cells, which open by the same canal or by separate apertures, into the same meatus. 3. The posterior ethmoidal cells, which open into the superior meatus. 4. The sphenoidal sinuses, which open through the posterior part of the roof of the nose behind the same meatus: and 5. The antrum, which opens into the middle meatus.

The osseous parts hitherto described form the skeleton of the interior of the nose, but contribute little to the formation of its external prominent part. Of this part the osseous skeleton is composed of the two nasal bones, and the nasal or ascending processes of the superior maxillary bones, which together form the *bridge* of the nose and a small portion of its lateral walls. Each nasal bone is elongated, quadrilateral, and narrower above than below. Its anterior surface is convex from side to side, and either presents a double curve from above downwards, or is slightly concave in its whole length. The two together form a prominent arch above and in front of the anterior aperture of the nose: their surface is continued outwards and downwards over the ascending processes of the superior maxillary bones, is smooth, and is marked only by small apertures giving passage to bloodvessels and nerves.

The internal edges of the nasal bones are united in the median line by a straight suture, the continuation of the sagittal suture. In front their union is smooth; but behind and above, where the bones are much thicker than they are below, a deep ridge or crest is formed which is received into that part of the septum of the nose which is formed by the nasal spine of the frontal bone, and the vertical plate of the ethmoid. Sometimes, however, these margins, instead of forming a ridge, are separate, and enclose a groove in which the edge of the septum is received. The superior thick borders of the nasal bones articulate by a serrated suture with the notch and the nasal spine of the frontal bone; and this suture, which forms part of the great transverse suture, is continued into that uniting the nasal processes of the superior maxillary bones with the internal angular processes of the frontal. The outer and largest margin of the nasal bone articulates with the nasal process of the superior maxillary, and is slightly overlapped by its sharp edge. The lower free margin is sharp and uneven.

The median suture of the nasal bones, and the short portion of the sagittal suture immediately above it, are the parts of the median

suture of the skull which remain longest unossified: in ordinary cases, indeed, they do not close even in the latest periods of life. This, in some measure, distinguishes man from the other quadrumana: in the Chimpanseé, the nasal bone is single; in the Orang, also, it usually is so; and in the adult Siamang (whose skull approaches nearest in form to that of man) and other Gibbons, the nasal bones are always united.* But a more distinctive character is the breadth and shortness of these bones in man, and the elevation of their inner borders, on which the projection of the upper part of the bridge of the nose depends; a projection in which the nose of the lowest negro surpasses that of either the Chimpanseé or the Siamang.

The structure of the bones of the nose presents little that is peculiar. The thin lamellæ of the ethmoidal cells, the turbinated bones, and others of similar structure, receive their materials of nutrition entirely from the bloodvessels of the Schneiderian membrane. They contain no vascular canals within their own substance. Their corpuscles and minute canals which proceed from them are larger than those of average size: the former are very numerous and closely set, and the latter ramify in all directions; arrangements which seem to be adapted to the combination of the least possible weight with the necessary firmness of support.

Cartilages of the nose.—Of these, one completes the septum, and the rest form the skeleton of the lower and lateral portion of the external nose.

The cartilage of the septum (*septum mobile nasi*) (fig. 400) is the only one immediately connected with the bones. It occupies, in general, nearly the middle vertical plane of the nose; but, like the osseous septum, it often deviates to one or the other side, and has surfaces more or less curved. Its outline varies with the general shape of the nose, but is usually bounded by three unequally curved lines, of which the inferior is the longest, and the anterior and superior are of about equal length. Its superior border (*a*, fig. 400) is fixed in the whole length of the groove which usually exists in the lower margin of the perpendicular plate of the ethmoid bone: it is directed very obliquely backwards and downwards, and at its posterior extremity is conti-

Fig. 400.

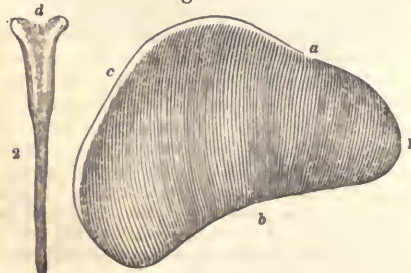

Cartilage of the septum nasi.

1, lateral; 2, anterior view.

* G. Vrolik, *Recherches d'Anatomie Comparée sur le Chimpanseé*, p. 4.

Fig. 401.



The cartilages of the ala of the nose in situ.

nued with a curve into the lower border (*b*), of which a part fits in the same manner in the anterior margin of the vomer, while the remainder projects straightforwards in front of the anterior nasal spine, and forms the base and middle part of the *columna* (*sous-cloison*,) or partition between the apertures of the nostrils. Anteriorly, this lower border of the cartilaginous septum is continued with a curve which lies at the apex of the nose, into the anterior border (*c*). This last lies immediately beneath the skin, and, becoming gradually thicker, is continued upwards to the junction of the nasal bones, where the cartilage (at *d*) is thicker than at any other part.

Of the lateral cartilages, two on each side are regularly found. The upper pair, (*a*, fig. 401,) which are named *superior*, *lateral*, or *triangular* cartilages, have each in general the form of a triangle with its angles rounded off. In front they are continuous, or very closely connected with the upper half of the anterior edge of the cartilage of the septum;* but each of them projects a little beyond it, so that it lies in a kind of groove between them; and, sometimes, each is prolonged downwards in a free sharp process by its side. Behind, they are closely attached by fibro-cellular tissue to the rough part of the free margins of the nasal and superior maxillary bones. Below, their margins are connected with the cartilages beneath them (*b*, fig. 401) by a tough but thin and pliant fibrous membrane, in which several small oval portions of cartilage are sometimes arranged in a row.

The *inferior cartilages* (fig. 402, and *b*, fig. 401) are also called *pinnal cartilages*, or *cartilages of the ala*, because they form the basis of the more freely moveable lateral parts of the

* Hence Winslow, Bichat, and some others have described these as forming one *nasal cartilage* with the septum, and have divided the inferior cartilages into anterior and posterior portions.

Fig. 402.



Lateral view of the pinnal cartilages.

nose, and the *cartilages of the nostrils*, because they surround and in great measure determine the form of those apertures. The chief portion of each of them is nearly elliptical, and occupies the anterior part of the ala of the nose. Posteriorly, this portion either becomes suddenly narrower, and is continued in a long, undulating, and curved process through the middle part of the ala to the posterior and outer boundary of the nostril; or else it abruptly ceases, and, in place of the process, there is a row of three or more small oval portions of cartilage, (*sesamoid cartilages*,) imbedded in the fibrous membrane which forms the rest of the basis of the ala, and connects all the moveable cartilages to one another. Anteriorly, this chief elliptical portion is also continued into a narrow process, which, after proceeding for a very short distance forwards, turns round abruptly, and is directed backwards and a little downwards by the side of the lower margin of the cartilaginous septum, to which, as well as to its fellow on the opposite side, it is pretty closely connected by fibro-cellular tissue. In this course, the cartilage reaches a little beyond the anterior edge of the septum, so that, at the tip of most noses, there is in the middle line a small fossa bounded on each side by the lateral cartilages, and at the bottom of which is the anterior edge of the septum. The inner portion of this cartilage extends along about two-thirds of the inner boundary of the nostril, and terminates in an evenly rounded border; its lower margin is always rather lower than that of the cartilaginous septum, and assists in giving width and support to the columna. Sometimes, but more rarely, this inner process of the inferior cartilage is, like the posterior and outer process, separate from the chief elliptical portion.

The *structure of the cartilages of the nose* is essentially similar to that of the articular and other true cartilages, (*cartilagine figurata*, Meckauer.) Their cells are numerous, very close set and large; and next to each of their surfaces there are two or three layers of thin flattened cells, which give the borders of a section through the thickness of the cartilage a somewhat fibrous aspect. But the basis-substance is, in reality, entirely destitute of fibres.

The greater rigidity and firmness of the septum-cartilage is due to its greater thickness; its minute structure is similar to that of the cartilages of the alæ. The latter are easily flexible, but the pliancy of the sides of the nose does not depend on them alone, but in as great a degree on the tough fibro-cellular membrane in which they are imbedded. The combination of the two tissues is indeed admirably adapted to the purposes which are to be served. The

cartilages are sufficiently rigid to give the alæ a definite form during rest; and they are so elastic that, when the nostrils have been either compressed or expanded, they are restored to their natural position by the recoil of the cartilages, without any muscular effort. If the whole side of the nose had been formed of cartilage, much stronger muscles would have been needed for the several movements of the nostrils; but, by the intervention of small portions of fibro-cellular membrane, these movements, whether rapid or long-sustained, are effected by some of the weakest muscles of the body, and with a scarcely perceptible effort of the will. The arrangement is somewhat analogous to that in which strength and flexibility are combined by strong scales or plates being set on the pliant substance of the skin of various animals.

The *muscles of the nose*, like those of the rest of the face, are but ill-defined, and anatomists have differed much in both the description and the enumeration of them. The following account is drawn from the results of several dissections purposely made, and compared with the descriptions of Santorini,* Arnold,† Theile,‡ and others, who have examined the matter for themselves.

Fig. 403.



Muscles of the nose.

a, nasal bone; *b*, nasal process of superior maxillary bone; *c*, pyramidalis nasi; *d, d*, levator labii superioris alæque nasi; *e, e*, triangularis; *f*, depressor alæ nasi; *g*, compressor narium minor; *h*, dilatator narium anterior; *i*, orbicularis oris; *k*, depressor septi narium.

* *Observationes Anatomicæ*, cap. i.

† *Icones Anatomicæ*, Fasc. II. tab. viii.

‡ *Schemmerring, Vom Baue des Menschlichen Körpers*, Bd. iii.

1. *Pyramidalis*, (Casseri; *proccrus*, Santorini; *fronto-nasal*, Chaussier.) This (*c*, fig. 403) cannot be strictly called a separate muscle of the nose, and it is described with the *frontalis* by Haller, Theile, and many others. It consists of those fibres of the median portion of the frontalis muscle which descend in a fasciculus over the upper part of the nose. They terminate in the cellular tissue covering the superior cartilage, and, through its medium, they are attached to the cartilage itself, and to the adjacent border of the nasal bone; many of them also are continued onwards and mingled with the upper fibres of the *triangularis nasi* (*e*), with whose aponeurosis, moreover, theirs is always continuous. At their inner margin these fasciculi are in contact above, but they diverge below as they pass over the surface of the nasal bones, and they thus assume that appearance of two distinct slender triangular slips of muscle which led Santorini to give them a distinct name, though they have not that distinct origin which he assigns to them.

The pyramidales do not appear to have the power of acting alone. When the rest of the frontalis contracts, and, by drawing down the scalp, wrinkles the skin of the forehead, they also act, raising and tightening the skin over the upper part of the bridge of the nose. They produce the same effect when the brows are drawn up, as in surprise.

2. *Levator labii superioris alæque nasi*, (Albinus, Weber, &c.; *pyramidalis*, Santorini; *oblique, ou lateral*, Winslow; *elevator commun*, Bichat, Bourguery, &c.) This, (*d, d*, fig. 403,) which is the largest and strongest of the muscles of the nose, arises, internally, by a narrow slip of fibres from the upper and outer part of the ascending process of the superior maxillary bone, and, externally, by a broader origin from below the inner part of the lower border of the orbit. Its origins are covered by the orbicularis palpebrarum, and from them its fibres proceed downwards and diverge. About two-thirds of them pass to the outer part of the upper lip, mingling with the fibres of the orbicularis oris (*i*) and levator labii proprius, and inserted for the most part in the skin; the remainder go downwards and a little forwards over the posterior third of the ala of the nose. Of these last, some are attached more or less intimately to the posterior parts of the inferior cartilage and the membrane in which it is imbedded; many more terminate in the skin over the lower part of the ala, and are there mingled with fibres which run in various directions, but usually form a complete layer of muscular fasciculi beneath the skin of the outer border of the nostril.

In contracting, the nasal portion of this muscle draws up the ala of the nose, especially its posterior and lower half; and as the cartilage and other dense tissues of this part do not admit of wrinkling, the muscle, in its full action, turns the nostril outwards, and expands its aperture at the same time that it wrinkles the skin above it.

3. *Triangularis*, (Cloquet, Bourguery, &c.; *transversus*, Santorini, Winslow, Theile; *com-*

pressor nasi, Albinus, Haller; *c, e*, fig. 403) is a thin pale muscle whose origin is covered by the preceding. It arises by a narrow aponeurosis from the upper and outer part of the canine fossa, behind and external to the base of the ala of the nose. Its fibres thence diverge, the lower ones passing almost horizontally, the upper ones forwards and inwards, and they form a thin triangular muscle which covers the upper part of the ala of the nose and reaches to the dorsum. Sometimes many of its fibres pass over the dorsum of the nose and mingle with those of the muscle of the opposite side; but more often there intervenes between the two muscles a pliant fibro-cellular expansion, into the borders of which many of their fibres are inserted, and which thus forms a kind of median aponeurosis extending over the front of the nose and enabling both the muscles to act at once and equally upon it and the ala. In general, also, the upper or outer fibres of this muscle are continuous with those of the pyramidalis or are fixed in its aponeurosis; and the lower fibres are mingled with fibres of the depressor alæ nasi, and pass into the irregular assemblage of fibres beneath the skin of the lower border of the ala. Many of the fibres are connected through their whole course more or less intimately with the other tissues of the ala and the skin; and probably it was from this last circumstance that Santorini was induced to describe this muscle as having the whole of its origin among the fibres of the levator labii superioris alæque nasi, or rather as a muscle peculiar for having its middle portion fixed (on the dorsum of the nose) and its two extremities moveable in the substance of each side of the upper lip.

These muscles have been described by some as compressors, by others as dilators of the nose, and in different circumstances they probably do act very differently. When the outer or maxillary insertion of each is fixed, they assist in compressing the nostrils, and in combination with the true depressors (presently to be described) their lower fibres draw the alæ backwards. When, on the other hand, they take their fixed point in the median aponeurosis on the dorsum of the nose, and contract towards it, those of their fibres which are connected with the skin will wrinkle it, as in the act of sneering, and those which are attached to the deeper tissues of the ala will draw it upwards and in some degree expand the nostril. When they compress the nostrils they commonly also draw backwards the apex of the nose in the manner usually seen in the act of smelling carefully.

4. *Depressor alæ nasi*, (Haller, Albinus, Theile; *Myrtiformis, seu pinnæ dilatator*, Santorini; *Petit dilatateur de l'aile du nez*, Bourguery; *incisif mitoyen*, Winslow; *dilatator narium*, Arnold; *f*, fig. 403) arises by short aponeurotic fibres from the alveolar margin above the second incisor and canine teeth of the upper jaw, below and on the inner side of the origin of the triangularis. Its fibres proceed upwards, forwards, and inwards, some going to the posterior part of the skin under the sides of the

septum, and many more to that of the alæ; many of them, also, first rising and then descending, form arches which are continued over the outer and posterior margin of the nostril, and are mingled with the fibres of the two preceding muscles, where they meet in the skin covering that part.

These muscles draw back and flatten the nostrils. Some of their fibres are mingled with those of the depressor labii superioris, or superior incisive muscle, and, whenever they act, the upper lip is fixed and somewhat elongated.

5. *Depressor septi narium, or nasalis labii superioris*, (Haller, Albinus; *naso-labial*, Bourger; *k*, fig. 403;) may be regarded as a part of the upper portion of the circumference of the orbicularis oris, from which several fibres proceed forwards and inwards, converging from each side towards the septum of the nose. They are attached to the fibro-cellular tissue at the posterior borders of the nostrils, and the middle fibres pass forwards under the septum between it and the skin of the columna, many of them extending nearly to the tip of the nose.

When the rest of the orbicularis is fixed, this portion will draw the columna and the apex of the nose backwards and downwards; and when the rest of the orbicularis is relaxed, it will draw the middle of the upper lip upwards.

6. I have mentioned a layer of pale muscular fibres arranged in various directions under the skin of the lower part of the alæ nasi, among which fibres of the compressor, depressor, and levator alæ nasi appear to mingle. It is by these fibres that the dilatation of the nostril is commonly effected; for, as any one may feel and see in his own person, this act is not usually performed by any of the muscles yet described, but by fibres which are situated below the triangularis and entirely within the moveable part of the alæ. In most instances, no definite arrangement of these fibres can be perceived; yet they certainly sometimes form distinct fasciculi, which may be described as separate muscles. Arnold makes from them two muscles: 1. *Compressor narium minor*, (*g*, fig. 403), a small triangular muscle passing from the skin of the tip of the nose backwards and a little upwards, with its fibres diverging, to the anterior part of the inferior cartilage. Theile has never seen this muscle; in one very muscular subject I found a distinct trace of it; and it nearly corresponds to that which Santorini has drawn, (tab. i. *e*, *e*) and which he says he once saw in action during dyspnoea in a woman. He regarded it as a dilator of the anterior part of the pinna; Arnold considers it a compressor; the former opinion is the more probable. 2. Arnold has figured a larger quadrilateral muscle, *levator alæ nasi proprius* (*h*, fig. 403), which is nearly the same as Theile's *dilatator narium anterior*. Theile describes it as arising from the upper edge and outer surface of the inferior cartilage, its origin extending from within two lines of the dorsum of the nose to the sesamoid cartilages. Hence its fibres proceed downwards and are lost in the skin on the anterior part of the edge of the nostril. Its

action is to draw the anterior part of the alæ outwards, and thus to dilate the nostril. Theile also describes a *dilatator narium posterior*, which may be found by removing all the fibres of the common levator, the depressor alæ nasi and the triangularis. A mass of cellular tissue is thus exposed on the inferior and posterior part of the alæ, in which muscular fibres may always be seen with the microscope, if not with the naked eye. They arise tendinous from the edge of the ascending process of the superior maxillary bone and from the sesamoid cartilages, and thence descending are lost in the skin of the posterior half of the edge of the nostril. Their action is to draw the posterior part of the alæ outwards, and thus to dilate the nostril.

7. One more muscle may be mentioned, though it is only indirectly connected with the nose. It is that named *rhomboideus* by Santorini (tab. i. *f*), and *anomalous* by Albinus, from its being fixed at both its ends to immovable points. Its origin is confounded with that of the triangularis at the upper and outer part of the canine fossa; whence its fibres proceed in a broad fasciculus upwards and inwards in the fossa by the side of the nose to be attached to the surface of the superior maxillary bone close to the outer origin of the levator communis. The strength of the fibres of this singular muscle indicates that they must act frequently; but the only effect which their contraction can be supposed to have is that of tightening and drawing in the tissues over them with which they are pretty closely connected.

The purposes served by the muscles of the nose are but few. Their action contributes little to the various expressions of the condition of the mind. The sneer of contempt is perhaps the only expression in which they take a chief part. In extreme fear they appear also to be all contracted; but in this they are affected in common with the other muscles of the face, which all seem to be seized by a temporary spasm. Their other acts have reference to respiration, and are observed in their extreme degrees, in the dilatation of the nostrils to permit the freer ingress of the air in dyspnoea, and in their contraction in the endeavour to perceive a slight odour, by drawing the air quickly upwards towards the seat of the most numerous filaments of the olfactory nerve.

Integuments of the nose.—In their general characters these resemble the skin and mucous membrane of other parts: their peculiarities alone therefore need be here described.

The *skin* of the nose is smooth and fine, its papillæ being small and its cuticle very thin. It is soft, also, and pliant, and usually abundantly furnished with the sebaceous secretion. The hairs growing in it are numerous and exceedingly fine, so that many have denied their existence; the largest and most closely set are at the lower part of the alæ. The follicles enclosing them are deep and narrow; the conical pulps long and slender. The sebaceous glands are narrow and elongated; they lie near the sides of the follicles, have very short ducts, and are placed at but a little distance below

the surface of the skin. Their secretion is copious, so that after death a mass of sebaceous matter may be squeezed from the orifice of each hair-follicle; and their ducts as well as the follicles themselves are said to be especially liable to be infested by the *acarus folliculorum* lately discovered by Dr. Simon.* I find none of the simple utricular follicles described by Cloquet and others in the skin of the nose; probably they were empty hair follicles.

On the upper three-fourths of the nose, the skin moves freely on the subjacent bones and cartilages, a thin layer of pliant cellular and adipose tissue being placed between them. In the lower fourth, and especially about the base of the nose, the skin is thicker and more compact than it is above; there is very little fat beneath it, and what there is arranged in small and discrete granules; and the cutis, muscle, and fibrous membrane are so closely connected that they are moved together as one mass.

At the nostrils the skin of the nose turns inwards and is continuous with the mucous membrane, which, after lining the nasal fossæ and the cavities opening into them, is continued into the pharynx through the posterior nares, and into the nasal duct and Eustachian tube. The boundary between the skin and mucous membrane cannot be strictly drawn. It may be fixed, however, at the part just below which those hairs are implanted which converge from the inner circumference towards the centre of the nostril, so as to entangle any light body floating in the inspired air. These hairs are of the kind named *vibrissæ*. Like the eye-lashes they are short, stiff, slightly curved, and pointed at their free extremities; and they are peculiarly well adapted for examining the minute structure of hair. In them also, as well as in the eye-lashes, one may best see the mode in which hairs are shed. In all which fall off spontaneously, or which, being about to fall, may be pulled away without pain, the conical cavity at the lower end, into which the vascular pulp fitted, is closed, having gradually contracted and shifted itself off the pulp as the hair ceased to be nourished and died.

The follicles of these hairs are similar to those of the hairs of the external integument, and each of them is associated with sebaceous glands, which, like those accompanying the hairs about the orifice of the vagina, are more numerous than in parts less exposed to the contact of fluids. A whorl of four or more small glands is often associated with a single hair-follicle; and when the hairs fall off, and their follicles partially close, the glands open, as if directly, by a common duct upon the surface.

The *mucous membrane* (Schneiderian or pituitary membrane) of the nose is far from uniform in its different parts. It is everywhere, and in some parts inseparably, connected with the periosteum or perichondrium which immediately covers the bones and cartilages, and which is often spoken of as the internal or deep

layer of the *fibro-mucous* membrane; but, while the latter is in all parts nearly similar, differing only in thickness and degree of vascularity, the mucous membrane itself presents considerable diversities.

In the antrum and other supplemental cavities of the nose the mucous membrane is thin, but little vascular, and of the simplest kind, having neither papillæ nor glands embedded in it. On the turbinated bones, the septum, and the floor of the nostrils, it is thick, spongy, red, and turgid with blood collected in the plexus of large vessels in its areolar tissue. These vessels seem to form in some parts a distinct layer between the periosteum and the proper mucous membrane, but they are exactly analogous to those of the areolar or sub-mucous tissue of other compound mucous membranes, in all of which there is a plane of large vessels from which those of smaller size ascend to the apparatus disposed upon the surface. In the Schneiderian membrane the veins of this plexus far exceed the arteries in size, and their close connection with the veins within the skull may be a provision for relieving the latter when subjected to an undue pressure of blood. The epistaxis of plethoric persons and of those who read hard probably has its origin in this connection; for the pressure of the blood in the congested cerebral vessels being communicated to the walls of these of the mucous membrane, these will burst more readily than those which are on every side supported by scarcely yielding tissues. The size of these veins, too, and the facility with which they permit distension, (almost resembling in this the veins of an erectile tissue,) account for the rapidity with which the membrane sometimes swells up, so as in a minute or two to obstruct the passage of the nose.

The free surface of that portion of the mucous membrane which lines the proper cavities of the nose is smooth. It presents the orifices of many simple follicles or crypts. They are most numerous about the lower and anterior parts of the walls of the fossæ, are of various sizes, and in many places lie in groups or rows. The follicles themselves are hemispherical, or deep and more or less elongated. At the lower and anterior part of the septum, there is often a single long duct running horizontally and leading to a collection of gland-cells which all appear to open into it; and, generally, some others of the larger orifices are connected with composite glands.

The *epithelium* of the nose is, in part, of the laminated, in part of the ciliary, kind. Henle* says that if an imaginary plane section of the nose be made from the anterior free border of the nasal bones to the anterior nasal spine of the superior maxillary bones, all the mucous membrane below and in front of this plane is covered by laminated epithelium, and all above and behind it by ciliary epithelium. The latter covers not only all the walls of the nasal fossæ, but is continued from them to the surface of

* Müller's Archiv. 1842, p. 218.

* Allgemeine Anatomie, p. 246.

the mucous membrane lining all the supplemental cavities, the nasal duct and lacrymal sac, and the upper part of the pharynx.

The *course* (as it is called) of the mucous membrane next merits consideration. Ascending from the floor of the nasal fossa up the outer side of the inferior meatus, it becomes gradually thicker and more spongy. From this meatus it is continued anteriorly into the nasal duct, around whose lower orifice it forms an annular fold or reduplication. The orifice in the bones is elliptical and rather obliquely placed, its anterior edge being somewhat lower than the posterior. The fold of mucous membrane around it is especially deep on the inner side and posteriorly, and not only contracts the size of the orifice, but acts as a valve to guard it, and, when pressed upwards and forwards, to close it. Hence, though some persons can inflate their lacrymal sacs, in most men, when the nostrils are closed, and air is pressed forcibly into the nose from behind, none ever escapes from its cavities.

As the lining membrane descends again upon the outer surface of the inferior turbinated bone, it becomes thicker, more spongy, and more vascular. At the lower edge of the bone it forms a deep fold, which, in its congested state, touches the floor of the cavity. The fold is peculiarly thick at the two ends of the bone, and in disease in scrofulous children it sometimes forms a loose and very vascular spongy mass, which has been mistaken, it is said, for a polypus. Immediately behind the deep posterior fold the membrane becomes again thin and adheres closely to the pterygoid plate of the sphenoid bone, behind which, and on a level with the extremity of the inferior turbinated bone, it is continued into the orifice of the Eustachian tube.

As it passes from the inferior turbinated bone to the outer wall of the middle meatus, the Schneiderian membrane becomes again thinner and more compact. About the middle of this meatus it enters the deep channel of the infundibulum, whose form it scarcely alters, and along which it passes to the anterior ethmoidal cells, and through them to the frontal sinuses. Above the commencement of the infundibulum it enters into the antrum by a narrow orifice directed obliquely from before backwards. Of the great opening into the antrum when the superior maxillary bone is separated, a large portion is covered by the palatine and turbinated bones; and of what remains, all but a narrow circular orifice at the upper and anterior part is closed by a thick annular fold of the mucous membrane; and even permanent closure is no rare consequence of the swelling to which the membrane is subject. Cloquet* says that this fold contains in man a gland with numerous orifices analogous to one of large size which surrounds the orifice of the antrum in many animals. I have not been able to find such a structure, and even E. H. Weber† has not been more successful.

The membrane covering the middle turbinated bone and the anterior portion of the cellular part of the ethmoid is thick and spongy, but less so than that on the inferior turbinated bone. In the superior meatus it is thin; and it becomes still thinner as it passes into the one or more orifices of the posterior ethmoidal cells, on the borders of which it is tightly applied, and whose size, as it forms no loose projecting fold, it diminishes but little. It closes, at this part, the sphenopalatine foramen, and in the vault of the nasal fossæ all the foramina of the cribriform plate, through which nerves and vessels are admitted to the outer surface of the mucous membrane, and the inner surface of the periosteum. At the lower borders of the superior and middle turbinated bones it forms thick folds, which make the meatus appear far smaller than they do in the dry bones. These folds are not so deep as that on the inferior turbinated bone; but, as they probably receive many filaments of the olfactory nerve, both they, and perhaps the inferior fold also, may be regarded as means for the multiplication of the sensitive surface, and as analogous, in some measure, to the folds of mucous membrane by which alone in Fish and the Proteus anguinus the same object is attained.

In all the rest of its extent over the septum, the nasal bones, and the lateral cartilages, the Schneiderian membrane has a uniform surface and is of about middle thickness: its layers are intimately united, and it adheres with moderate firmness to the bone and cartilage.

Nerves of the nose.—The *olfactory nerve*, or, as it may be more properly called, the *olfactory lobe of the brain*, arises from the posterior, inner, and inferior part of the anterior lobe of the cerebrum. It lies in the groove between the two most internal of the convolutions of this part of the brain, and may be divided into three parts;—the posterior, or *pyramid*, the anterior, or *bulb*, and the middle, or proper *trunk* of the nerve or lobe. At its origin it may be traced backwards into three roots. Of these, the *outer* or *long root* appears first in the fissura Sylvii at the junction of the anterior and middle lobes of the cerebrum, just above the trunk of the middle cerebral artery. Hence, its chief portion proceeds inwards, forwards, and a little downwards on the under surface of the anterior lobe and in front of the *substantia perforata antica*; and on coming near the other roots it turns more directly forwards and unites with them at the beginning of the groove between the two convolutions. In this course it receives on its outer border one or more separate fasciculi, which come from the deeper part of the lobe and are sometimes completely concealed by grey matter covering them.

The *inner* or *short root* is first visible at the inner and posterior part of the anterior lobe of the cerebrum, in front of the beginning of the fissura Sylvii, and just outside the great median division of the cerebrum. It consists of one or more fasciculi, and passes outwards and forwards to the commencement of the groove, where, curving round like the preceding, but

* Oshresiology, p. 247.

† Hildebrandt's *Anatomic*, Bd. iv.

in the opposite direction, it joins the other roots to form part of the pyramid.

The *middle root** arises between the two preceding roots, and first appears in two or three bands of fibres just in front of the *substantia perforata antica*, whence they proceed forwards to join the other roots.

Each of these roots is connected with grey matter prolonged from the surface of the anterior lobe and the *fissura Sylvii*, and especially from two slight elevations, one of which lies in the concavity of the internal, the other in that of the external, root, as they severally turn forwards where they join the middle root. The grey matter connected with the external root covers part of its origin, is continued along both its sides, and conceals more or less the filaments which join its outer border. Then connecting itself with the grey matter around the fibres of the middle root, they pass forwards together, and are lost near the apex of the pyramid; part of them entering its substance, but a greater portion forming a thin layer (*propago cinerea externa*) which covers its surfaces, especially the upper one. The grey matter connected with the inner root conceals many of the fasciculi of its origin, and two streaks proceed from it, of which one passes into the interior of the pyramid, separating the internal and middle roots, and the other, of much larger size, is continued over its surface. This latter is the middle or grey root of Cloquet, &c. (the *propago cinerea interna*.) It has a somewhat pyramidal form, and covers a part of both surfaces of the pyramid, but chiefly the upper surface. Its deepest edge penetrates to the middle root, and its outer edge sometimes joins the superficial layer covering the other roots. As it proceeds forwards it becomes more and more slender; and it is prolonged further on the upper than on the lower surface of the pyramid, near the apex of which it ceases.

Thus, the pyramid of the olfactory nerve is formed by three fasciculi of white filaments, separated by streaks of grey matter, by which also it is covered on both its borders and on a great part of its upper surface. It is between two and a half and three lines long; its base lies in the angle where the two internal convolutions of the anterior lobe diverge; and at its anterior extremity, becoming gradually smaller and flatter, it is continued into that which may be called the trunk of the nerve, the *tractus olfactorius*. This is nearly flat: it is grooved along the middle of its under surface, which rests on the upper part of the body of the sphenoid bone, and has a ridge,

or is altogether convex upon its upper surface, which lies in the groove between the convolutions. It is striated in its whole length, and nearly white; though some grey matter is collected within the meshes of the plexuses, which its fibres form as they proceed forwards and a little inwards towards the bulb in which they expand. After long immersion in spirit, the groove on the under surface of the trunk, which, in the recent state, varies much in depth in different persons, always becomes deeper and more distinct. Valentin* suggests that it indicates the course of the canal which in the human embryo passed from the lateral ventricle to the end of the olfactory bulb. The analogue of this canal is persistent in the olfactory nerves of lower Mammalia; but there is no sufficient evidence of its having been ever seen in the human adult; at least in this part of the nerve.†

The bulb of the olfactory nerve is a nearly elliptical flat body, about half an inch long, slightly furrowed above, convex on its lower surface, and evenly rounded in front. It rests upon the dura mater covering the cribriform plate; its inner margin is in contact with that covering the *crista galli*, and with the anterior part of the *falx cerebri*; by which alone it is separated from the bulb of the opposite side. It is of a greyish-red colour from the quantity of grey nervous matter which is placed upon its surface and among the plexuses formed by the nervous filaments within it. In its interior a small cavity or ventricle may be generally detected by a vertical antero-posterior section: it is the remains of the embryonic condition just alluded to.

From the lower surface of the bulb proceed the numerous branches of the olfactory nerve. They vary much in number and size both in different persons, and on the two sides of the same individual; a want of symmetry which may often be seen in the perforations of the cribriform plate. The ordinary number of branches is from fifteen to twenty on each side. Each of them, invested by a very delicate neurilemma, passes through an aperture in the cribriform plate, through which also a tubular prolongation of the dura mater passes and becomes continuous with the periosteum of the nasal fossæ. The nerves, which become rather firmer when they have passed through the cribriform plate, ramify between the periosteum and the mucous membrane, and are divisible into two chief sets, some being placed upon the septum, others upon the outer wall of the nose.

The internal or *septual* branches are about twelve in number. After passing through the cribriform plate, they diverge a little as they descend; the anterior going somewhat forwards, the posterior backwards. The trunks soon, and often while within the foramina of the cribriform plate, break up into tufts of filaments, which unite into plexuses with long and narrow quadrilateral meshes; and from these, smaller

* Confusion has arisen in the use of this name. The root here meant is that called *middle root* by Soemmering, Sir C. Bell, Mr. Swan, and Valentin. Weber and Hildebrandt, and Cloquet call that *middle* or *grey root* which lies above the others, and forms a thin grey band on the upper surface of the nerve: and under the *internal root* they include, as Haller and others did, who described only two roots, both the internal and middle ones. The names here adopted are preferable, because the white fasciculi alone could properly be regarded as roots of a nerve, they alone being continued to the branches, and because their arrangement is more constant than that of the grey matter.

* Soemmering, *Vom Bane des Menschl. Köpers*. Bd. iv. p. 299.

† See on this question Cloquet's *Ophthalmologie*, and Metzger's *Historia*.

Fig. 404.

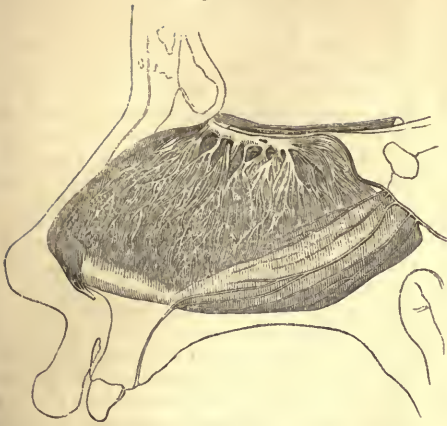

Branches of the olfactory and naso-palatine nerves on the septum of the nose.

branches proceed which again form finer plexuses. They may be traced nearly to the lower fourth of the septum.

The external or *labyrinthic* branches are rather more numerous and smaller. They diverge and ramify like the preceding, lying in the channels and grooves upon the upper two turbinated bones. They have been traced to the lower border of the middle turbinated bone, but not to its outer concave surface, nor to any part below it; yet the similarity of the structure and arrangement of the inferior turbinated bone and the mucous membrane over it makes it very probable that they ramify on it also. The middle branches are the longest; the posterior ones form curves directed backwards towards the sphenoidal sinuses, but not entering them. At the posterior angle of the middle turbinated bone some of them are described by Mr. Swan* and by Soemmering as anastomosing with a branch from the sphenopalatine ganglion; but Valentin† could not find any such communication. A few branches in addition to these are said to be distributed in the membrane covering the cribriform plate itself (Cloquet).

How the primitive filaments of the olfactory nerve terminate has not yet been ascertained; their softness and the density of the tissue in which they lie have hitherto prevented an accurate observation of them in this part of their course.

Compared with the other nerves the olfactory present many peculiarities of structure and arrangement, especially in the part which is within the skull. 1. They are the softest of the nerves within the skull, possessing only the most delicate neurilema; and a rather less degree of this softness is characteristic of their branches, so that their dissection is more difficult than that of any others of equal size. 2. They have grey nervous matter both upon and between their fasciculi, and their bulbs are not

like the ganglions of other nerves, but like portions of the brain. 3. They are not, as other nerves, cylindrical, but triangular in one and flat in another part of their course. 4. Their trunks converge, while those of all others diverge from their origins. 5. They lie in deep furrows on the surface of the brain, and they leave the skull by several distinct orifices. In many of these characters they are more like portions of brain than nerves; and, as Valentin observes, there is no other nerve in the adult human body which shows its origin as an immediate prolongation of the central nervous mass so plainly as these do. It was on account of these characters that the olfactory nerves were regarded by the ancient anatomists as processes of the brain (mamillary or papillary processes), through the central canals in which they supposed that the pituitary humour was carried from the lateral ventricles to the nose, and air was drawn into them by the nostrils. And although this notion was derived from dissecting the nerves of animals in which the trunks remain hollow, yet their true nature was doubted on the same grounds by many, even after Willis had demonstrated their structure in man.*

In accordance with its numerous offices, the nose receives, in addition to these,—the nerves of its peculiar sense,—others for common sensation, for the movements of its muscles, and for the government, in some degree at least, of the organic processes which are carried on in it. Its sensitive and organic nerves are derived from the internal nasal or ethmoidal branch of the first or ophthalmic division of the fifth, from the naso-palatine and numerous other branches, from the sphenopalatine ganglion, the nasal branches of the Vidian, palatine, anterior dental, and infra-orbital nerves; all of which are described under the title **FIFTH PAIR OF NERVES**. Its motor nerves are supplied by the facial or seventh pair [**SEVENTH PAIR OF NERVES**].

Vessels of the nose.—Its arteries are derived from the ophthalmic, the internal maxillary, and the facial. The ophthalmic artery gives it the anterior ethmoidal, which enters with the ethmoidal nerve, the posterior ethmoidal, and the nasal, which anastomoses near the angle of the eye with the angular branch of the facial artery. From the internal maxillary trunk the nose and the adjacent cavities are supplied through many branches, namely, the alveolar, which sends branches into the antrum, the infra-orbital, of which the terminal branches partly supply the skin, the Vidian, anterior palatine, pterygo-palatine, and sphenopalatine, each of which, as it passes towards or through the canal after which it is named, sends branches to the mucous membrane of the adjacent part of the nose or of the cavities opening into it. From the facial artery branches are derived both through the superior labial and from the trunk itself. Indeed, the dorsal arteries of the nose may generally be regarded as the termination

* Demonstrations of the Nerves, folio, p. 14, pl. xi. f. 3.

† Loc. c. p. 303.

* See Cloquet, and Metzger, l. c., and Sprengel, Histoire de la Médecine, iv. p. 69.

of the facial artery, for they are usually larger than the angular artery, which is given off as a branch from one of them. They chiefly supply the skin and muscles; they form a complete network over the nose, and those of one side anastomose freely in the middle line with those of the other. Many of their branches also pass between the cartilages or turn in at the nostrils and supply the anterior part of the mucous membrane.

The veins of the nose, so far as they are known, are associated with its arteries. Their communication with the veins within the skull has been already mentioned. The anastomosis is chiefly effected by means of the branches of the ethmoidal and sphenopalatine veins, which communicate with branches opening into the longitudinal and coronary sinuses.

The lymphatic vessels of the nose have not been particularly examined. Cloquet says their principal trunks accompany the blood-vessels and go to the jugular ganglia.

Development of the nose.—The development of the nasal cavities lays, as it were, the foundation for the construction of the face.* They are first formed as a kind of canal, whose lateral walls are chiefly composed by the anterior and lateral frontal processes of Reichert—those processes which grow out from the sides of the covering of the first cerebral vesicle (*Stirnkappe*), in front of the first visceral arch. This canal has on its outer side and behind it the rudimental substance for the upper jaws, (the superior maxillary processes of Reichert,) and above it the base of the skull and the origins of the first pair of visceral arches thence arising. As the upper jaws grow with a rapidity far exceeding that of the growth of the frontal processes, they come at last to form alone the lateral walls of this canal, while the frontal processes form its inner walls; and, together with those changes, the canal becomes deeper, and its external apertures, which at first lay at the sides of the head between the two frontal processes of each side, approach the median line, and assume a lower position. After this, as the upper jaw of each side, continuing to grow inwards, approaches that of the opposite side, they at length unite to form the palate, and thus separate the common cavity, which at first existed, into an oral and a nasal cavity.

Of the parts just mentioned, the anterior frontal process is regarded by Reichert as the basis in which the nasal bone is developed; and the lateral frontal, or naso-frontal process as the basis for the lachrymal bone. The superior maxillary bone appears to be developed in the part named after it; the intermaxillary bone in a portion of the anterior frontal process, or its junction with the superior maxillary process; the palate bone and the pterygoid processes in the upper part of the first visceral arch.

The formation of the parts within the nasal cavities is, he says, thus effected: within the

formative substance enclosed between the walls of the one rudimental cavity two cartilages form; one of these is the prolonged cartilaginous body of the first cephalic vertebra which forms the septum of the nasal cavities, and may be traced without any breach of continuity to their outer orifice, where it ends membranous in the adjacent formative mass. The other cartilage is double, and appears somewhat later than the preceding, on each side of which it lies close to the lower part of the first cephalic vertebra, with an arched surface directed outwards to the eye. Each of these second, or lateral cartilages becomes the cellular portion of the ethmoid bone, the *lamina papyracea*, and may be easily separated from the vertebra and its visceral arch, from which its formation is entirely distinct. Even for some time after they are ossified this separation may be effected without injury to the surrounding parts; but at a later period they completely coalesce. The ossification of the septum takes place later than that of the other bones of the face. In all Mammalia it makes progress from the base of the skull downwards and forwards, and in all a part of the septum in front and below is left unossified; so that divisions are produced which had originally no existence. The vomer, Reichert thinks, is formed separately when the palatine portions of the superior maxillary bones meet together.

The olfactory nerve is originally, like the optic and auditory nerves, a kind of vesicular or tubular prolongation from the medullary tube which constitutes the cerebro-spinal axis of the embryo. According to Valentin,* it proceeds from the most anterior part of this tube, that is, from the foremost of the three embryonic cerebral vesicles; but, according to Reichert, from the lower and front part of the side of the second of them. Von Baer† found the olfactory nerves presenting this vesicular form in the chick during the third day of incubation; they projected from the lower surface of each hemisphere into the formative tissue of the skull, and exhibited a small round pellucid surface bordered by a dark circle. Rathke observed similar appearances in the sheep and adder. The interior of the vesicle is lined, according to Valentin, by a delicate ciliary epithelium. Anteriorly it appears to terminate at the end of the olfactory bulb; posteriorly it is continuous with the anterior part of the lateral ventricles of the cerebrum.

The early development of the human nose has not been particularly studied, but is probably very similar to that just described from observations in the lower animals. In a well-formed embryo an inch in length, I have found the nasal cavities of proportionally large size. On their lateral walls they present distinct traces of the rudiments of the two lower turbinated bones in prominent horizontal folds of the lining membrane. The palate is at this time formed only anteriorly and at its sides; its middle portion is widely open, exposing to the view from

* Reichert, Ueber die Visceral-bogen, Müller's Archiv. 1837, pp. 144 and 159. This account is drawn from the development of the Pig.

* Soemmering, l. c. p. 404.

† Quoted in Bischoff, Entwicklungsgeschichte (Soemmering, Vom Baue, &c. B. viii.)

below the free inferior border of the septum. The upper edge of the septum is firmly fixed to the base of the skull, and its posterior edge gradually slopes back to the upper and back part of the wide cavity of the pharynx. There is no appearance of a vomer; and the nose does not project upon the face. Its position is marked externally by the nostrils, which are elongated vertically, oval and narrow, situated about three-fourths of a line from the margin of the upper lip and at the like distance from each other. They are not at this time closed, but lead straight backwards into the common nasal and oral cavity.

In the following periods the chief changes are effected by the gradual closure of the palate, the fixing of the lower margin of the septum, the development of the vomer, and the growth of the anterior part of the septum and of the rudiments of the nasal and superior maxillary bones. With these changes the nose gradually becomes more prominent, and the nostrils, which at first look straight forwards, are gradually turned obliquely downwards, and at last are directed as in the adult nearly straight downwards. During the third and fourth months, according to Burdach, the nostrils are closed by a fine membrane, which in the fifth month is again removed. Together with the change in their direction already spoken of, the septum becomes narrower and the distance between them is diminished. Changes perfecting these are continued even long after birth in the gradual elevation and elongation of the bridge of the nose, and in the narrowing of its base; and it is in these changes subsequent to birth that noses, which present little variety in infants, acquire the almost infinite diversities of form by which they characterize the faces of adults.

Physiology of the nose.—Most of the purposes to which the nose is subservient in the economy are described in other articles. [SMELL, LARYNX, MUCUS, FACE.] Here, however, it may be considered as the first portion of the respiratory passage, and as a feature characteristic of the human race and of its several varieties.

The nose is the proper channel through which the air is drawn into and expelled from the lungs. It alone is habitually used in respiration by most animals, and though in man the mouth is as often used in breathing as the nose, (and, indeed, oftener in our own climate, in which, from various causes, few persons have at all times both the nasal passages free,) yet it is not adapted to this office so well as to be used long without inconvenience. Most persons must have suffered the discomfort of breathing through the mouth during a few hours' sleep: all its lining membrane, as well as that of the fauces and of the upper part of the larynx, becomes dry, and an excretion of saliva must be artificially produced before the annoyance and the danger of choking can be removed. No such inconvenience attends the breathing through the nose for any length of time. Its more extended mucous membrane supplies a fluid sufficient to keep its own epithelium moist, and to saturate with vapour the air which passes

over it, so that this air does not abstract so much moisture from the surface of the epiglottis and the glottis as the drier air which has passed through the mouth alone.

Again, the nose is far better adapted than the mouth is for the arrest of the particles of foreign solid bodies which float in the air. If such particles have passed through the hairs which lie at the orifices of the nostrils, and which are sufficiently close-set to stop even very minute bodies, they are in their further course liable to be caught in the irregular surfaces of the walls of the nasal fossæ and entangled in the moisture of their lining membrane. Hence, most persons can breathe through the nose for some time without inconvenience even in a cloud of dust: and the nasal cavities of the horse and other Mammalia are, in this respect, still better adapted for the protection of the lungs. Some experiments were performed in France to determine whether great injury of the respiratory passages of horses were produced by their exposure to the dust of roads. Horses were made to trot for a considerable distance in the clouds of dust thrown up by the wheels of carriages driven before them; they were killed directly afterwards, and not a particle of dust appeared, on the closest scrutiny, to have passed beyond their nasal fossæ.

The nose is further adapted to be the first portion of the respiratory passage by the acute and peculiar sensibility of its mucous membrane, and by the connection of its nerves in the nervous centres with the nerves of all the set of respiratory muscles. Through the olfactory nerve the nose detects the impurity of the air from those gases whose deleterious properties are indicated by odour; and its acute common sensibility affords a warning of the presence of any mechanical or other common irritant. The act of sneezing, which in this last case is excited through the already-mentioned connection of these nerves, is an example of that class of half-involuntary acts* which are consequent on acute sensations; and, in this respect, it is widely distinguished from the other reflex acts with which it is commonly classed, but which are never, or at least not necessarily, connected with sensation. Every one must have felt that a certain acute sensation is necessary in order that a sneeze should occur; and if the sensation does not arise to that certain degree of acuteness, the disposition to the sudden forcible expiration gradually passes off, though the act had been desired and had seemed on the point of being accomplished. In this respect sneezing is exactly analogous to coughing,—an act which is never thoroughly effected except in consequence of a certain acuteness of sensation at the glottis. And the analogy is maintained in this also,—that the cause of irritation which produces sneezing may be seated either in the nose itself, where it is always felt, or in another part. In cough-

* They may be thus called, because, though the sudden and simultaneous exertion of all the muscles concerned is involuntary, and almost inimitable, yet the putting them in a position for that exertion is always voluntary.

ing, the sensation which immediately precedes the act may be the consequence of direct irritation of the glottis, or of irritation of another part, such as the distant bronchial tubes, from which the impression is conveyed to the brain, and there, as it is supposed, is radiated to the central extremities of the nerves of the glottis, and is felt as if it were applied to their peripheral extremities. In either case the peculiar sensation at the glottis is the necessary precedent of the act of coughing; and it is the same in sneezing. A sudden vivid impression of light upon the retina, or, sometimes, the irritation of a tender point on the skin of the face, produces a sensation of pain or irritation in the mucous membrane of the nose, and sneezing follows. The sequence of events may be supposed to be,—an impression on the peripheral filaments of the retina,—its conveyance to their central extremities in the brain,—its radiation to the central extremities of the sensitive nerves of the nose, producing the same sensation as if their peripheral extremities had been irritated,—and, through that sensation, whether it be objective or subjective, the half involuntary act.

The great prominence of the external nose, and the comparative smallness of its internal cavities, form one of the most distinguishing characters of the human face. Cuvier has pointed out how the relative proportion in size between the cranium and the cavities of the nose and mouth affords an indication of the approach towards perfection of the internal and intellectual faculties in comparison with the external or sentient. For the senses of smell and taste “are those which act on animals with the most force, which most powerfully master them, through the energy which two of the most pressing desires, hunger and lust, communicate to their impressions.”* But in man the sense of smell is, in both these regards, subordinate to that of sight; and the development of his internal olfactory apparatus is, in comparison with that of lower animals, extremely small. In the varieties of the human race the perfection of the sense and the development of its organ are the less the more civilized their several habits of life are. Among ourselves, the blind alone maintain the sense in the energy of which it is capable, and in which it is said to be habitually exerted in some less civilized tribes. In the latter a greater development of the organ of smell, and even of its osseous part, corresponds with its greater acuteness and the degree in which it is exerted. The greater distance between the orbits, which is especially remarkable in the Kalmucks and other Mongolian tribes, may be an indication of this greater development; but a more important one is the size and complexity of the turbinated bones. The nasal fossæ of the skulls of Negroes are larger in all their dimensions than those of Europeans; and Soemmering,† in numerous examinations, found the sinuses within the middle turbinated bones

constant in the Negro, though rare in others. Blumenbach* confirms both these observations, and mentions particularly the skull of a North-American Indian in his collection, in which these sinuses were of extraordinary size. However, these differences of size are probably not a full measure of the differences of acuteness of the sense: it is most likely that in the nose as in the other organs of sense, acuteness of perception is connected with fineness of division, rather than with extent of distribution, of the recipient nerve.

The prominence of the nose is even more characteristic of man than the smallness of its cavities. In other Mammalia it stands out, indeed, much further from the skull, but it is in company with the upper jaw, beyond which it does not, as in man, project. For the same reason, the nostrils, which in man are horizontal and directed downwards, in adaptation to his erect posture, and to his hand ever ready to carry objects to them, are, in the lower animals, vertical. The nasal processes of their superior maxillary bones, also, lying flat and being very broad, and the small size of their nasal bones, prevent the peculiarly human elevation of the bridge of the nose.

The forms of the external nose are among the characteristics of the varieties of our species. In all its almost infinite varieties of form the Caucasian nose is on the whole narrow, elongated downwards, and elevated at the bridge; the Mongolian is flat and very broad at its base; the American less flat than the Mongolian, but less prominent than the Caucasian; the Ethiopian flat, broad, and very thick at its base; the Malay full and broad, and, in general, thicker at its apex than the other varieties are. As for the varieties of form in the individuals of the same race or nation, they have little, if any, physiological interest: they are not known to have any connection with differences of function, and the importance they have acquired is founded on the unsupported notion that they are characteristic of corresponding varieties of temper and of intellect.

MORBID ANATOMY OF THE NOSE.

Congenital defects.—The extreme of these is found when the normal state of the very early fetus continues and the nose is nearly absent. Such a case is described by Soemmering. The child was born at the full term: the brain was malformed, and there were no olfactory nerves. In place of nasal bones there was but one small lens-shaped bone, and the ethmoid bone was little developed: the eyes were close together, but the orbits had not coalesced. A similar example is mentioned by Roederer, in which a child with malformed ears had in place of nose a scarcely perceptible elevation, no nostrils, and for nasal fossæ a blind pouch formed by mucous membrane. Vrolik,† by whom these cases are quoted, describes another in a pig

* *Leçons d'Anatomic Comparée*, ii. 160.
† *Ueber die Verschiedenheit des Negro's*.

* *Institutiones Physiologicae*.
† *Handboek der Ziektekundige Ontleedkunde*, D. ii. p. 70.

which is in Sandifort's museum, and in which the olfactory nerves and the nasal, lachrymal, and ethmoid bones are all absent.

Next to these are cases in which the nose exists, but has not its naturally complex form. Otto* describes two such in mature female anencephalous children. The nose was in both flat and broad; it had but one nostril, and the septum was absent. The inferior turbinated bones were approximated posteriorly, so as in one case to close the nasal cavity, and in the other to reduce it to a very narrow aperture opening into the pharynx. In one of these children, also, the olfactory nerves were absent. Sometimes a state like this exists on one side only. Vrolik † mentions a child still living in which the right half of the nose was fully developed, but on the left side there was a kind of snout hanging from the root of the half nose, perforated and giving passage to mucus and air. Professor Broers cut off this appendage and the aperture closed.

The floor of the nasal fossæ remaining in the state which it naturally presents up to the third month, constitutes cleft palate, a slight degree of which, since it produces no inconvenience, is more common than is generally supposed. When the membrane described as closing the nostrils after about the ninth week is not removed, the *atresia narium* results. Several cases fairly referable to this arrest of development have been recorded. ‡

Defects of development at a later period are seen in the cases of absence of one or more sinuses, of which also several cases have been recorded. And with these, as errors of development produced perhaps by some accidental pressure, may be enumerated the examples of extreme obliquity or curvature of the septum, in which the apex of the nose is turned completely to one side or even backwards towards the cheek. Such are the cases for the remedy of which Dieffenbach has lately applied with success the subcutaneous division of the cartilages and the adjacent contracted tissues. § Another slight defect is that in which part of the septum is deficient, or in which the bone is perforated but is closed by membrane. Haller || describes a case in which the vomer was completely and widely perforated; but much more commonly the defect is in the vertical plate of the ethmoid bone. Very rarely there is an aperture in the cartilaginous part of the septum. The excellent anatomist Hildebrandt had a defect of this kind. ¶

A class of cases, which, though congenital, cannot be certainly referred to arrest of development, are those of *fissure of the nose*. Sometimes the nose alone is said to be divided deeply in the median plane,** and this may

represent the fetal state in which the frontal processes have not united, or in which the septum is not yet formed. But the cases are more numerous in which the fissure exists on one or both sides of the face. In some it extends from the angle of the mouth, through one or both alæ of the nose, to the internal or external angle of the eye, laying into one the cavities of the mouth, nose, and one or both orbits. Four such cases, differing but little from each other, are recorded by Vrolik. He possesses also an example in which, in a much less degree of the same defect, there is only a fissure of the skin from the mouth to the eye by the side of the right ala nasi; and another, in which a deeper fissure extends in the same direction on both sides. These cases, however, like those of hare-lip, cannot be regarded as mere arrests of development: there is no period in which the fœtus is known to present these as normal conditions.

A very remarkable congenital defect in which the nose is concerned, is that of which the subjects have been called Cyclopians or Cyclocephalian monsters. It has been admirably illustrated in a special memoir by Dr. Vrolik,* who points out five varieties of it. In the first, the eyes are absent or not externally visible, and the nose is either absent altogether or replaced by a kind of proboscis or snout-shaped member, consisting of little more than skin, and attached above the orbit. In the second there is a single orbit in the middle of the forehead which contains a single eye-ball, and above which there is sometimes a proboscis representing the nose. In the third, the eye appears externally to be single, but is internally double; and with this again the nose may exist in the form of a proboscis. In the fourth, the two eye-balls are separated, but they lie in one orbit in contact, or with only a narrow partition between them, and above them there is a proboscis which, as in the other cases, may be curved either upwards or downwards. In the fifth, the proboscis, approaching more nearly to the form of a natural nose, has an osseous nucleus, and is directed downwards; and the eye, above which it is placed, is either double or single. In this series, therefore, there is a regular gradation from the natural to the most unnatural condition, in regard to both the nose and the eyes. For the eyes, there is in some no eye at all; in some a single eye-ball placed in the middle line; in some again an eye-ball, which appears single, contains parts of two; and in some two eye-balls lie close together in a single median orbit. For the nose, it is in some altogether absent; in some it exists in the form of a snout which is little more than a prolongation of skin; in others it has a more or less well-formed osseous nucleus; in some it is curled upwards and backwards, in others directed obliquely downwards: and among all these there are numerous gradations of deformity. Now, any of these conditions of the nose may co-exist with any of those of the eye: there is no regular

* Over den aard en oorsprong der Cyclopie, in the Transactions of the Netherlands Institute, Amsterdam, 1836, and in his Handboek, D. ii. p. 14.

* Monstrorum sex centorum descr. anat. N. vii. viii.

† L. c. p. 260.

‡ See Vrolik, l. c. and Meckel, Handb. der pathologischen Anatomie, Bd. i. p. 107.

§ Casper's Wochenschrift, Sept. 18, 1841.

|| Elementa Physiologie, v. 137.

¶ Hildebrandt's Anatomie, by E. H. Weber, iv.

107.

** Isidore St. Hilaire, Traité des Anomalies, t. i. p. 603.

correspondence between their respective degrees of development. This is confirmed by the cases of the monsters in which the eyes are completely absent, but the orbits are naturally placed and the nose is well formed; and by those others already mentioned, in which the nose is absent, but the eyes and orbits are natural and almost naturally placed. From all these, and from the constancy of the deformity of the nose when the orbits are united, it may be deduced that the eye and the nose are developed independently, except in regard to their position, and that the displacement of the nose, which constitutes one of the chief features of the Cyclopians, is generally the consequence of the orbits having taken up the place of the nasal cavities. It cannot be said that the displacement of the orbits is the only cause of that of the nose, because there are a few cases in which the nose occupied the Cyclops position, though the orbits had their natural place; and one case in which the orbits and eyes were absent, and yet the nose was elongated like a proboscis and set high upon the forehead. But these do not invalidate the truth of the general deduction already drawn.

The displacement of the nose is thus explained with much probability by the precedent displacement of the orbits, and the latter is probably due to an arrest in the development of the eyes. But the cause of the peculiar deformity of the nose is very obscure. There is generally some degree of relation between the approach to completeness of the nose and that of the brain and its nerves, and especially of the anterior lobes and the olfactory nerves: yet these nerves are sometimes present when the nose is most deformed, and when it has neither ethmoid bone nor cavity, nor even any osseous nucleus; and in other cases they are absent when there is a distinct though misshapen external nose. Tiedemann's supposition, therefore, that these, like other malformations of organs, depend on a precedent defect in the corresponding nerves or parts of the nervous centres, cannot be maintained.

Diseases of the nose.—These are so far generally similar to those of the similar tissues in other parts that some of their peculiarities only need be mentioned here.

The *skin* of the nose is perhaps more than any other part of the face subject to the eruptions of acne, &c. And these acquire a somewhat peculiar character from the small vessels of the nose being so liable to distension. In the common *red nose*, all the small veins are usually dilated and in a measure varicose; and even in healthy persons the circulation through the skin of the nose is carried on with comparatively little force, if we may judge by the frequency with which it is partially arrested by cold. This dilatation of the vessels and consequent slowness of circulation not only render the diseases of the nose peculiarly obstinate, but permit them to produce changes of structure which are very rarely found among their defects in other parts. Such is the tuberculated induration and thickening with deep red or livid congestion of the skin after long-continued

acne, in which all the deeper textures appear to be confused in one hard brawny substance. When this state continues very long and the congestion somewhat abates, the thickened tissues remain, and sometimes grow into a kind of pendulous tumour from the end of the nose. Such tumours, (which, however, may form with little precedent acne,) are usually three-lobed, one portion seeming to correspond to the end, and one to the fore part of each of the alæ, of the nose. One which I dissected was composed throughout of a compact, white, fibro-cellular tissue, like that of which the pendulous tumours consist which grow from other parts of the skin, and especially from the female labia. It seemed very little vascular,* and the hair-follicles and sebaceous glands were enormously enlarged. Some of the latter measured not less than a line in width, and their ducts, which opened at the bottoms of deep fossæ, admitted full-sized bristles. The same enlargement of these organs takes place in certain large growths of the skin of the scrotum.

The position of the *cavities of the nose* has been an effectual hindrance to the examination of the changes of structure produced by their ordinary diseases. Nothing is known of the state brought on by repeated *colds*. While they continue, the mucous membrane is gorged with blood, swollen, and red, so as to close, with the assistance of the increased secretion of mucus, the passage to the pharynx. Probably the mucous membrane is in time condensed and thickened; and from this it may result that in looking over a number of sections of heads, the Schneiderian membrane is found by no means uniform in its thickness, consistence, or vascularity even on corresponding parts.

M. Mareschal† has lately stated that, in the examination of eight persons who had had epistaxis shortly before their deaths, he found in all a circumscribed portion of the membrane which was very congested, and dark red or livid. In two of them this congested part was situated anteriorly, near the junction of the septum and the floor of the nostrils; in the others posteriorly on the fold of mucous membrane at the lower border of the inferior turbinated bone.

Simple abscesses sometimes occur beneath the mucous membrane of the nose, especially after injuries; and after passing through an ordinary course leave their usual effects in thickening, induration, and unnatural adhesion of the cicatrized tissues.

A thickening of the mucous membrane simulating polypus has been already mentioned. It occurs especially in scrofulous children and young persons, and presents the same characters, as to its duration and progress, which are observed in the other chronic inflammations to which they are subject, and with one or more of which it is commonly associated. This spongy thickening

* Sir W. Blizard lost a patient through hemorrhage after the removal of a tumour of this kind from the nose; but it is possible that this might have been owing to something wrong in the general state of the patient, for usually little blood is lost in such operations.

† Annales de Chirurgie, Janvier, 1843.

usually affects at once the whole or a large portion of the membrane, though, of course, it is most obvious at the folds on the borders of the turbinated bones. It is sometimes attended by superficial ulceration or excoriation of the membrane; but even without either of these the discharge has usually a purulent character. If it continue long, this chronic inflammation produces not a mere swelling, but a more solid thickening and induration of the membrane sufficient nearly to close the passage through the nose; or if there have been ulceration of the membrane, a part of the passage may be closed by adhesion of the opposite surfaces of the thickened and approximated membranes. Such obstructions are usually situated near the entrance of the nasal ducts, and when the swelling of the membrane which preceded their formation has decreased, they are drawn out, and look like transverse thin membranes passing across the cavity, just within the nostrils. Such obstructions are particularly apt to occur when, by obliquity of the septum, one of the nasal cavities is unnaturally narrow.

Sometimes, from chronic inflammation of the mucous membrane of the nose, substances are produced altogether unlike the discharges commonly seen. Mr. Cæsar Hawkins, who has paid much attention to these diseases, speaks of "several portions of substance like chalk in consistence, exceedingly fetid, and in shape exactly like the spongy bones: they were probably composed of phosphate, or perhaps carbonate, of lime, with fetid mucus secreted from the upper spongy bones." A similar case, probably, in which a hard concretion was found in a nose, is recorded by Dr. Grandoni.* In another case, Mr. Hawkins saw small bodies, like half-formed cartilage, which had the shape of the superior spongy bone, and which had been occasionally separated during many years; and in another, a very tough and tenacious mucus which was constantly secreted from a soft and relaxed membrane covering a diseased vomer. The exact condition of the membrane in these cases has not been determined; in one it seemed connected with diseased bone. The secretion of earthy matter from it is perhaps analogous to that which produces the phosphatic incrustations of the diseased mucous membrane of the urinary bladder.

The ulceration of the mucous membrane of the nose which attends this state of chronic inflammation is usually superficial. Deep and destructive ulcerations (such as give rise to the symptoms of *Ozena*) occur, however, under many circumstances; for example, from neglected injuries, scrofula, syphilis, &c. Their effects are often not confined to the membrane, but are propagated either to the skin, through all the intermediate tissues, or to the subjacent cartilage or bone, which then are ulcerated or suffer necrosis secondarily, as, more rarely, they do primarily. The appearances of the ulcers from various causes do not materially differ. They may commence in any part of the nasal cavities; but they are said to be most frequent

near the exterior in common or scrofulous ulceration, and in the more interior parts of the membrane in syphilis. Their first appearance is in the form of a small pustule or collection of matter beneath the membrane; and the ulceration by which this opens externally makes progress more or less rapidly, spreading in both extent and depth without any signs of resistance to its course in the adjacent textures. When such ulcers have exposed the cartilages, these are gradually perforated by the ulcerative process; they do not suffer necrosis, but in this, and probably in all their morbid changes, they follow the course of the articular cartilages, which they resemble in their structure and in their exemption from being ossified. The septum is the part in which the effects of such ulcers are most commonly seen. Sometimes it is perforated through its centre, and, in these cases, though the aperture be large, the shape of the nose may be unaltered, for the remaining borders are sufficient for its support. But when a part of these borders is destroyed, deformity is the certain result; the point of the nose is drawn backwards and downwards when the lower part of the septum is destroyed; or the middle of the bridge falls in, and the point projects and is turned upwards when the upper part is lost; or, when the destruction is more general, the nose falls nearly flat below the nasal bones. When the ulceration reaches the bones it may continue to spread through them, destroying them gradually without necrosis; or, if its progress be rapid, or matter collect beneath the periosteum, so as to expose a large surface of bone, this being deprived of its supply of blood, perishes and gradually exfoliates. Thus, the nasal bones, or large portions of the septum, or the turbinated bones, and parts of the palate may be destroyed, and the most hideous deformities be produced. Sometimes, no doubt, the syphilitic affections of the nose may commence in the bones or cartilages themselves; but, most commonly, they are affected secondarily after being exposed by the destruction of the mucous membrane. In the worst cases, the ulceration spreads with a ragged sloughing to the membranes of the palate, pharynx, and other adjacent parts, and through them to the bones and other tissues which they cover. The disease has its centre of severity in the nose, but the pain around the nasal cavities indicates a simultaneous slighter affection of the adjacent sinuses; sometimes, also, it extends to the membranes and substance of the brain; and sometimes it passes up the nasal duct and produces all the signs of fistula lacrymalis.

Polypi.—The mucous membrane of the nose is more subject than any other part to the growth of polypi, which may occur in either one or both of the nasal fossæ, or in the cavities adjacent to the nose. Those which grow in the fossæ, and which alone will be considered here, are of several kinds, and, though the lines of distinction cannot be clearly drawn between them, are commonly arranged as vesicular, gelatinous, fibrous, and malignant polypi.

* *Annali Universali di Medicina*, Ottobre, 1840.

The *vesicular polypi*, or, as they have been called, *hydatid polypi*, are composed of masses of large, pellucid vesicles, filled by a transparent and slightly viscid fluid, or consist of a substance somewhat like the vitreous humour. They can be broken by a very slight force, and after they have discharged their fluid nothing remains but shreds of fine membrane, like films of washed fibrine. They commonly grow from the upper and side walls of the nasal fossæ, and their growth is very rapid. They frequently also burst spontaneously, discharge their contents, and are reproduced; and their reproduction is almost always very rapid when they are artificially destroyed, and the patient is not in other respects effectually treated. The thin membrane investing them is easily permeable, and their size varies according to the rapidity with which evaporation can take place from them, so that they may serve as a sort of hygrometer, indicating by their size the relative quantity of moisture in the atmosphere. Their nature is as yet unknown; they are probably entirely new productions, and not, as some think, distended mucous follicles.

Gelatinous polypi are more common than those of any other kind, and are those which are commonly called *mucous polypi*, though, under this term, Boyer and some others include both these and the preceding variety. They are much firmer than the vesicular polypi, and grow in one or more distinct and circumscribed masses. They are of a dull white or yellowish colour, soft and easily torn, composed of a fine tissue with fluid infiltrated in it, like anasarous cellular membrane. Generally they appear to have a few opaque white filaments running through their substance, and their surface and interior are traversed by long meandering bloodvessels. When small, they are nearly round and elongated; but as they increase they adapt themselves, as the other kinds also do, to the form of the nasal cavities, spreading towards their apertures, but rarely having sufficient force of growth to expand the firmer parts of the nose. They almost always grow nearer the anterior than the posterior nares, from about the middle of the outer wall of the nose, or from the middle turbinated bone, to which they are fixed by a narrow base more or less deeply rooted in the tissue of the Schneiderian membrane, and sometimes tightly adherent to the bone. It is only very rarely that this or either of the other innocent forms of polypus grows from the septum; but Mr. Hawkins has seen one example. Sometimes one only grows at a time, but more often there are several crammed together. They are covered by a fine membrane, like a thin continuation of the mucous membrane of the nose, like which, also, it is said to be covered by ciliary epithelium and appears to produce mucus. A polypus of this kind, which I recently examined, was composed throughout of a tough interlacement of fine, crooked, pale filaments like those composing a fibrinous coat of blood, in which there were thickly embedded a vast number of flat, circular, granulated cells, or cells with granulated nuclei.

Each cell was about $\frac{1}{3000}$ th of an inch in diameter, and in each, three or four of the granules appeared much darker than the rest. The whole presented on dissection a tough fibrous *grain*, and appeared to the naked eye much more highly organized than the microscope proved it to be. From its minute structure, which resembled in its general characters that of many other kinds of tumours, it is evident that these polypi, as well as the last, are not mere changes or out-growths of the mucous membrane, but are altogether new productions and belong to the class of tumours rather than to that of degenerated tissues.

Fibrous, sarcomatous, or fleshy polypi are masses of firm, well organized, and vascular tissue, growing like the others from a comparatively small base. Their substance is of a pale reddish or brownish colour, and they are invested by a thin smooth membrane. In different examples their degrees of firmness differ, so that, on the one hand, it is not easy to draw a line between this and the preceding variety, and, on the other, some specimens of this are found nearly as hard as the denser fibrous tissues. The base, or pedicle, of these growths is usually firmer and more fibrous than the rest of their substance, and parts of them are composed sometimes of tissues like cartilage or bone. Like the preceding they grow from the outer wall of the fossæ, but from the posterior, more often than from the anterior, part. Sometimes one only is produced, sometimes several; and their force and rapidity of growth are sufficient to stretch, if unchecked, all the parts around them, to expand and destroy the bones, and protrude through the skin of the face, where ulcerating they may present nearly all the characters of malignant diseases. And this resemblance to malignant growths becomes the greater from the polypus itself softening and growing more vascular on its surface or even throughout its substance.

The apparent transition from the preceding to this variety of polypus makes it probable that these also are new formations; and though they are sometimes firm and apparently fibrous even when they are very small, yet perhaps they are often produced by the further development of the gelatinous variety. Mr. Hawkins says that, in general, when the polypus grows from the surface only of the mucous membrane it is soft and gelatinous; but if the whole thickness of the membrane, including also the periosteum, be its seat, or if it grow from a part where there is much fibrous tissue, as for example, near the posterior nares, it is fibrous; and this, no doubt, is generally true; yet the frequency with which portions of the turbinated bones are pulled away in extracting gelatinous polypi proves that these also have often deep attachments.

What are called *malignant polypi* of the nose do not truly deserve the generic name. They are cancerous diseases of the mucous membrane or of the parts situated on its exterior, from which they gradually make their way into the nasal cavities. In general characters they do not differ from the similar dis-

eases of other parts. One form in which they appear is, that of common cancer of the mucous membrane analogous to the hard or warty cancer of the skin, and pursuing the same course of apparently unresisted ulceration as that disease does. It occurs in old persons, and usually makes its progress very slowly, destroying all the adjacent parts till the patient is exhausted, or till it affects by its contiguity the brain, as in a case mentioned by Mr. Hawkins. The other chief form in which the nose is affected by malignant disease is that of the soft or medullary cancer; but it is not certain whether this has yet been seen as a primary disease of the mucous membrane, or whether it be not always seated at first in some deeper tissue, from which as it makes its way it acquires a covering from the mucous membrane, and appears to be truly a disease of the nose. Whichever it be, there is nothing peculiar in its characters or course to need a special description of it here.

the nerves which supply the organ of smelling. Works by Palmer, vol. iv., p. 187. *J. G. Haase*, Pr. de nervis narium internis, in *Ludwig*, Script. Neurolog., t. iv., Lips. 1791. *F. Magendie*, Le nerf olfactif est-il l'organe de l'odorat? Journ. de physiologie, 1825, iv. 169.

Morbid anatomy of the nose.—*S. Peyerus*, De morbis narium, Basil, 1756. *J. G. Haase*, De morbis narium expositis, Lips. 1794. *J. F. L. Deschamps*, Traité des maladies des fosses nasales et de leur sinus, Paris, 1804. *J. E. Vort*, De ozena, diss. inaug. Lugd. Bat. 1725. *F. A. Meyer*, Comm. de ozena, in Frank. Del. Opusc. Med. Germ. v. x., p. 249. *Chr. le Cerf*, De polygono narium, Jenæ, 1715. *G. A. Langguth*, and *S. G. Eichler*, De polygono infantis, in Haller, Disp. ad Morb. v. vi., p. 301. *And. Levet*, Observ. sur la cure radicale de plusieurs polypes, Paris, 1749. *J. C. Hesse*, De polygono narium, Argent, 1777. *J. J. Waser*, Diss. inaug. recessum ossium nasi exhibens, Argent. 1767. *G. F. Gruner*, De polyponis in cavis narium obviis, Lips. 1825. *C. H. Dzondi*, Ergo polyponi narium nequaquam extrahendi, Halæ, 1830. *Cæsar Hawkins*, Clinical observations on some diseases of the nose. London Medical Gazette, August 23, 1834, and Clinical Lecture on Polypus of the Nose, July 24, 31, 1840.

(James Paget.)

BIBLIOGRAPHY.—1. *Of the nose in general.*—*Galen*, De instrumento odoratus. *Tintorius*, Diss. de fabrica et usu nasi humani, Regiom. 1640. *C. V. Schneider*, De ossis cribriformi et sensu ac organo odoratus, et morbis. Witteb. 1655. *C. V. Schneider*, De catarrhis libri quatuor. Viteberg, 1660-64. *J. A. Sebiz*, Diss. de instrumento olfactus. Argentor. 1662. *Casp. Bartholin*, De olfactus organo, disq. anat. Havn. 1679. *G. Frank*, Diss. de naso, Heidelberg, 1679. *J. M. Hoffmann*, Diss. de faciei promontorio, odoratus organo. Altorf. 1682. *G. J. Duverney*, Obs. Anat. sur l'organe de la vue et de l'odorat. Mém. de l'Acad. de Paris. t. i. *C. F. Paulini*, De naso mobili. Misc. Ac Nat. cur. 1695-96. *J. D. Santorini*, De naso, Venet. 1724. *H. van de Poll*, De partibus quæ in homine olfactui inserviunt. Lugd. Bat. 1735. *Fr. Boerner*, Comm. de... mirabilis narium structura. Brunsv. 1747. *J. A. J. Scrinus*, Diss. de organo, sensu, atque objecto olfactus, Pragæ, 1749. *S. T. Quelmalz*, Pr. de narium eorumque septi incurvatione, Lips. 1750. *F. J. du Toy*, De tunica pituitaria, Pragæ, 1753. *L. Aurivillius*, Diss. de naribus internis. Upsal. 1760. *J. G. Tenner*, De organi olfactus differentia, Lips. 1777. *J. C. Loder*, Anat. obs. tumoris.... brevis disq. de vero olfactus organo, Jenæ, 1789. *Ant. Scarpa*, Anat. Disq. de auditu et olfactu. Ticini et Mediol. 1789-92, and, Annot. anat. lib. ii. De organo olfactus deque nervis nasalibus., Ticin. 1785. *P. H. T. Simon*, Diss. de conchis narium infer. Erlang. 1802. *S. T. Soemmering*, Icones organorum hum. olfactus, Francof. ad Mœn. 1810. *J. F. Schröter*, Die menschliche Nase. Leipz. 1812. *Lawrence and Watt*, Anatomico-chirurgical views of the nose, mouth, &c. Lond. 1809. *Riefsteck*, Diss. de structura org. olfactus mammalium nonnull. Tubing. 1823. *Hippolyte Cloquet*, Oosphre-siologie, ou Traité des Odeurs, &c. Paris, 1821. *F. Picht*, De gustus et olfactus nexu. Berol. 1829.

2. *Of the olfactory nerves and other parts of the nose.*—*J. H. Stevogt*, Diss. qua processus cerebri mammillares ex nervorum olfactoriorum numero exemptos disq. submittit. Jenæ, 1715. *D. W. Andrea*, De processibus mammillaribus, Lugd. Bat. 1715. *J. E. Neubauer*, De processuum cerebri mammillarum cum naribus connexionem. Nov. act. acad. nat. cur. vi. 293. *J. Weibrecht*, De vera significatione processuum mammillarum: Comm. Petrop. xiv. 1751. *G. J. Duverney*, Comp. des nerfs olfactifs dans l'homme et dans les animaux. Mem. de Paris, t. i. *A. Matthieu*, Tent. phys.-anat. de nervis in genere, &c. Lugd. Bat. 1758. *J. D. Metzger*, Primi paris nervorum historia, Argent. 1766, and in Sandifort's Thesaurus, t. iii., and *Ludwig*, Script. Neur., t. iv. *J. Hunter*, A description of

NUTRITION.—The function thus designated may be regarded as including, in the most extended acceptation of the term, the whole series of operations, by which the alimentary materials are converted into living organised tissue: but as many of these changes are separately treated of in other parts of this work, we shall here confine ourselves to a more limited range; and shall consider the nutritive process as commencing with the absorption of the materials, which have been prepared by the digestive process; and as including all the changes, which are involved in the conversion of the fluids so introduced within the system, into solid organised tissue, forming an integral part of the fabric.

The object of the process of nutrition is the continual production of new tissue, either for the augmentation of the original structure, or for the reparation of that part of it, which is continually undergoing decay or disintegration. And by this continual renewal of the tissues, we gain, as will hereafter appear, a constant reinvigoration of those vital powers or forces, the exercise of which has been one of the chief causes of the previous waste. It is a principle now generally acknowledged by physiologists, that the processes of disintegration and decay, in any organ or tissue, are more rapid, in proportion to the functional activity which it has been called on to manifest;* and we find that the tendency to decomposition in the different tissues after death, which doubtless bears a general relation to their respective needs of renewal during life, is the greatest in those, whose vital powers are most remarkable—the nervous and muscular tissues for instance; whilst it is the least in those, whose properties are most purely physical—such as bone, cartilage, yellow elastic tissue, &c. Hence it is in the former that the greatest activity of nutri-

* This doctrine, strongly put forth in regard to the muscular system by *Liebig*, and restricted to it by him, had been taught long before the publication of his treatise.

tion is required, for the maintenance of their normal texture and properties; but its amount will vary, according to the demand created by previous activity, and the consequent decay.

The materials required for the nutrition of the tissues of the animal body seem to be supplied, for the most part at least, in forms possessing a similar chemical composition, by the vegetable kingdom. It will be presently shown that albumen may be regarded as the *pabulum*, at the expense of which all the organised textures (properly so called) of the animal fabric may be constructed. The really-organised part of this fabric, indeed, appears seldom to depart widely from the *protein* type of composition. Thus in fat, the non-azotized matter is contained within cells, whose walls are composed of a protein principle; and in the nervous tissue, it is probable that the walls of the cells and tubes are composed of an albuminous compound, though their interior is occupied by a substance of a character much more nearly approaching that of fat. Even with respect to the *gelatinous* tissues, as they are termed, there is much doubt to what extent they contain gelatin in their normal state; for where this can only be extracted from them by long boiling, it is not improbable that an actual conversion takes place; since we know that pure fibrin may be converted, by long boiling, (which occasions the liberation of ammonia,) into a compound resembling gelatin in many respects. And in those which are most purely gelatinous, it is doubtful how far the gelatin is itself organized. The writer has lately examined the *sound* of a cod with great care, both before and after the action of hot water upon it, and is satisfied that the gelatinous portion of it exhibits nothing that can be properly called organization—the only distinct appearances of fibres, cells, &c., being presented by portions which were left undissolved by the hot water, and which were, therefore, to be regarded as more allied to albumen than to gelatin in their composition. Similar remarks may be made in regard to the horny substance deposited in certain tissues; and it may probably be stated as a general theorem, that whilst in the plant, the materials which it derives from the elements around are combined and elaborated into non-azotized compounds for the production of organized tissue, and into azotized products for deposition in its cavities, these last alone form the materials of the animal organism, any non-azotized substances contained in it being inorganic in their condition.

In considering the various stages of the nutritive process in animals, we shall do well to bear constantly in mind the leading facts in regard to the same process in the simplest cellular plant: for we shall find that the elementary parts of the most complex animal organism go through a series of changes essentially the same; so that the *type* of the function is everywhere uniform, notwithstanding the vast apparent differences in the mode in which it is performed. The cell of the red snow or yeast plant, for instance, is developed from an almost imper-

ceptible germ, by its own power of attracting to itself certain nutritive materials in its neighbourhood, which it combines into the new forms required both for its own growth and increase, for the elaboration of certain peculiar matters contained in its cavity, and for the production of the germs of new cells; and these, being liberated in time by the death of their parent, go through, in their turn, the same series of changes. We shall now trace these changes in the highest and most complex form in which they are presented to us;—that is, as they occur in man, or any vertebrated animal.

Elaboration of organized materials.—The alimentary substances taken in by the absorbent vessels require to undergo very important changes within the body, before they can be applied to the nutrition of its structure. The chief constituents of the chyle, as at first absorbed, are *albumen* and *fat*; the former is destined to be converted into the material of the solid tissues; the latter is chiefly designed for the maintenance of the animal temperature, by the combination it is made to undergo with the oxygen introduced through the lungs. It is questionable, as already explained, whether fatty matter, or any other non-azotized compound, can ever be applied to the *nutrition* of the animal body. Even if it should be ever proved to be subservient to the re-construction of the azotized tissues, there can be no doubt that it must have been first converted into an *albuminous* compound—that is, into some modification of protein; and as the evidence that such a transformation ever takes place is far from being satisfactory, we have as yet no data for examining the mode in which it is effected. We shall, therefore, consider *albumen* as the starting-point of the animal tissues, and shall endeavour to trace, so far as the present state of our knowledge admits, the processes by which this is converted into the organized fabric.

In this assumption we seem justified by two very obvious considerations. First, in the egg of a bird, (or any other oviparous animal,) we find that, putting aside the fatty matter of the yolk, albumen is the sole organic compound, at the expense of which *all* its tissues are to be formed; so that, by the wonderful processes of chemical and vital transformation, which take place during the period of incubation, the albumen which it contained at first is metamorphosed into bone, cartilage, nerve, muscle, tendon, ligament, membrane, areolar tissue, gelatinous matter, horny substance, feathers, &c., &c. Secondly, a similar metamorphosis appears to be continually taking place in the body of the adult animal; for every *protein compound* employed as food appears to be reduced to the form of albumen in the digestive process; so that this becomes the *essential* constituent of whatever fluid is absorbed for the nutrition of the tissues. It is true that gelatin, taken in as food, may be absorbed and carried into the current of the circulation; but there is no doubt that it is altogether incapable of being applied to the re-construction of any but the gelatinous tissues; and, as already stated, it seems questionable whether, even in these, it

exists in a condition that can rightly be termed organised. Moreover, as it is clear that the gelatinous tissues *may* be formed at the expense of albumen, we are justified in regarding this substance as the common *pabulum* for all.

In order to form a definite conception of the nature of the transformations, which this principle is destined subsequently to undergo, it is important to bear in mind, *in limine*, that albumen cannot be regarded as possessed of any properties that characterize it as a *vital* compound—or, in other words, that essentially distinguish it from compounds of an ordinary *chemical* nature. In its coagulability by heat or by acids—in its combination with alkalis as an acid, or with acids as a base—and in the absence of any power of spontaneously passing into forms more decidedly organic than the granules which are seen when it is made to coagulate slowly—it is closely analogous to many substances which belong to the domain of inorganic chemistry. It appears, then, to be totally unpossessed of the property of *plasticity*; by which we mean the power of being at once converted into organised tissue: so that any deposit, whether fluid or solid, which mainly consists of albuminous matter, must be regarded as *aplastic*. This is a principle of great importance, as we shall see further on.

Before albumen is ready to be appropriated by the tissues as the material for their nutrition, it must undergo a very important change—not so much, however, in its chemical composition, as in the re-arrangement of its particles in a new mode, by which its properties are essentially changed. There seems reason to believe that, in the proportions of its ultimate elements, it is identical with the substance termed *fibrin*, into which it is changed during its passage through the chyliferous and sanguiferous vessels. [See ALBUMEN and FIBRIN.] But there are such decided and well-marked differences between these two compounds, as indicate that they fulfil entirely different purposes in the animal economy; and that whilst, chemically speaking, they are *isomeric*, the fibrin is endowed with properties of a distinctly *vital* character—that is, altogether different from any with which mere chemistry brings us acquainted. One of the most obvious manifestations of this difference is the property which is universally regarded as distinctive of fibrin—its tendency to coagulate spontaneously when withdrawn from the living vessels, and to pass into the form of a *tissue* more or less definitely organised. As will presently be shown, the completeness of this transformation depends upon two circumstances in particular;—the perfect elaboration of the fibrin itself, and the vitality of the surface upon which the concretion takes place. When the fibrin is highly elaborated, it will coagulate in the form of a definite network of minute fibrillæ, even upon a dead surface, as a slip of glass; this is the case, for instance, with the fibrin of the buffy coat of the blood, or with that of the liquor sanguinis (coagulated lymph,) poured out for the reparation of an injured part. But

in the ordinary fibrin of the blood, the fibrillation is less distinct, when the concretion takes place upon a dead surface. When it occurs in contact with a living surface, however, the coagulation takes place more gradually; and it seems as if the particles, having more time to arrange themselves, become aggregated into more definite forms, so that a more regular *tissue* is produced—just as crystals are most perfectly formed, when the crystalline action takes place slowly. It was formerly imagined, that the muscular tissue is the only one produced at the expense of the *fibrin* of the blood; the other tissues being formed from its *albumen*. This, however, is unquestionably erroneous. There is no proof whatever, that albumen, as long as it remains in that condition, ever becomes organised; whilst, on the other hand, there is abundant evidence that the *plasticity* of any fluid deposit—that is, its capability of being metamorphosed into organised tissue—is in direct relation with the quantity of fibrin which it contains. Thus the liquor sanguinis or coagulated lymph, thrown out for the reparation of injuries, contains a large amount of fibrin; and this substance is converted, not at first into muscular fibre, but (whatever may be the tissue to be ultimately produced in its place) into a fibrous network, which fills up the breach, and holds together the surrounding structure. This may be regarded as a simple form of *areolar* tissue, which gradually becomes more perfectly organised by the extension of vessels and nerves into its substance, and in which other forms of tissue may subsequently make their appearance. This process will be more particularly described hereafter; it is at present noticed here, as an illustration of the general fact, that *fibrin* is to be regarded as the *plastic* element of the nutritive fluids.

The change from albumen to fibrin is, therefore, the first important step in the process of assimilation. It commences in the absorbent system; for the chyle is usually found to contain fibrin, even *before* it enters the mesenteric glands (as is indicated by its tendency, however feeble, to spontaneous coagulation); and *after* it has passed through them, the quantity of fibrin is considerably increased, so that chyle drawn from the thoracic duct usually coagulates with tolerable firmness. This process of elaboration continues in the blood: for the quantity of fibrin it contains is always kept up, in health, to a certain standard, although there must be a continual withdrawal of it for the nutritive processes, without a corresponding regular supply from the chyle; and we find it, moreover, undergoing a sudden and remarkable increase, under the influence of local agencies. The question naturally suggests itself, therefore—what is the cause of this change? It has been usually attributed to some influence effected upon the albuminous fluid, by the living surfaces over which it is passing; and the increase in the amount of fibrin in the chyle, which is specially noticed after its passage through the mesenteric glands, has been thought due to some peculiar action of the blood that may come into relation with it, through the thin walls

of that capillary plexus, which forms, with the convoluted lacteal tubuli, nearly the whole bulk of those bodies. The writer is inclined to attribute it, however, to another agency—the vitalizing influence of certain floating cells, which the chyle and the blood contain; and the chief points of the evidence of this doctrine will now be set forth.

A comprehensive survey of the vital processes, performed both by plants and animals, enables us to bring together a number of examples in which *cells* are developed in a temporary manner, growing, arriving at maturity, and then disappearing; apparently without having performed any particular function. In the albumen of the seed, for instance, this often takes place to a remarkable extent. In the yolk of the egg there is a similar transitory development of cells, of which several generations succeed each other, without any permanent structure being the result. In the germinal vesicle, again (according to Dr. Barry*), several annuli of cells are seen to occupy its cavity, when it is prepared for fecundation; and the oldest and largest of these contain another generation: yet all these disappear by liquefaction, as soon as the two *permanent* cells begin to be developed in the centre. Further, in the subsequent development of all the cells which are descended from these, and form the "mulberry mass," the same process is repeated; a great number of temporary cells being produced, only to liquefy again as soon as the two permanent central cells make their appearance. It can scarcely be imagined by the well-judging physiologist, that all this *cell-life* comes into existence without some decided purpose; and if we can assign to it an object, the fulfilment of which is consistent with the facts supplied by analogy elsewhere, this may be reasonably considered as having a fair claim to be received as a physiological induction.

In all these instances, and in many more which might be quoted, the crude alimentary materials are being prepared to undergo conversion into permanent and regularly organised structures. The very first union of the inorganic elements into the simplest proximate principles is effected by the *cell-life* of plants. The change of these principles into the peculiar compounds which form the characteristic secretions of plants, is another result of their cell-life. And there seems equal ground for the belief, that the change of the proximate principles, sugar and gum (of which the latter appears to hold the same place in the vegetable economy that albumen does in the animal), into the peculiar glutinous sap, which is found wherever a formation of new tissue is taking place, is equally dependent upon the agency of cells. The process is probably commenced in the leaves; but as the ordinary descending sap, which is the product of their elaboration, is not so remarkable for its *plasticity* as the fluid drawn from certain rapidly growing parts, it seems probable that a local agency takes place in these, analogous to that which we shall be able

to trace in certain conditions of the animal economy. Thus, the starchy fluid which is contained in the ovule, previously to its fecundation, is probably not in the state in which it can be immediately rendered subservient to the nutrition of the embryo; and the development of successive generations of cells, which exert upon it their vitalizing influence, may be reasonably regarded as the means by which the requisite change is effected. Exactly the same may be said of the albuminous matter contained in the yolk of the egg, which is certainly not in a condition in which it can be immediately applied to the purposes of nutrition; and its conversion may be regarded as commencing with the development of transitory cells within its own substance, and as being completed by means of the cells forming the inner layer of the germinal membrane, by which it is subsequently taken up and introduced into the current of blood flowing through the vascular area. A similar purpose is probably answered by the transitory cells developed within the germinal vesicle; and by those which appear at a similar period in the evolution of the descendants of the "twin cells" produced in it.

Many other examples of a similar process might be adduced, but they would all lead to the same general conclusion, which harmonizes well with the important principle of general physiology,—that the higher the grade of structure ultimately to be attained by any part, and the more permanent its character is destined to be, the longer and more elaborate are the preliminary stages of its evolution. As an instance of this law, which bears a remarkable *analogy* with the facts just recorded, we may advert to the production of a *temporary* respiratory apparatus in the higher plants and animals, corresponding with that which is permanent in the lower parts of the scale. There are probably cases, however, in which cells are very rapidly called into existence, without that preparatory elaboration of their nutrient materials, which we regard as due to the vital operations of a preceding generation. Thus the *Bovista giganteum*, a large fungus of the Puff-ball tribe, has been known to increase, in a *single night*, from a mere point to the size of a huge gourd, estimated to contain 47,000,000,000 cellules. In such a case it is difficult to suppose that any but the most rapid mode of generating cells can have been in operation; and the idea that these could not have been developed by any such elaborate process as that just alluded to, is borne out by the fact of their extremely transitory character, the decay of such a structure being almost as rapid as its production. The same may be remarked of those *fungous* growths in the animal body which sprout forth most rapidly. Hence the apparent exception assists in proving the rule.

We have thus a class of facts which indicates that the conversion of the chemical compound into the organizable principle—the *aplastic* into the *plastic* material—is effected in the particular situations where it is most wanted by the vital agency of transitory cell-life; that is, by

* Embryological Researches, third series.

the production of cells which are not themselves destined to form an integral part of any permanent structure, but which, after attaining a certain maturity, reproduce themselves and disappear, successive generations thus following one another until the object is accomplished, after which they altogether vanish. We shall now consider another class of facts which seem to indicate that a change of this kind is being continually effected in the nutritious fluids of animals during their circulation through the body, by cells which are either carried about with them, or which are developed for the purpose in particular situations, as in plants. The former is the more common occurrence; since the conditions of animal life, usually involving a general movement of the body, require also a constant *general* reparation of its parts, and an adaptation of the circulating fluid therefore to the wants of the whole fabric.

In the chyle drawn from the lacteals near the intestinal tube, there is but little fibrin; and very few of the peculiar chyle-corpuscles are seen in the fluid. In the chyle of the mesenteric glands, on the other hand, the corpuscles are extremely numerous; and they are always readily seen in the chyle of the central lacteals, receptaculum chyli, and thoracic duct,—though their number is considerably less than in chyle drawn by pricking the lacteals of the mesenteric glands. The average size of these corpuscles is about $\frac{1}{4000}$ th of an inch; but they vary from about $\frac{1}{7000}$ th to $\frac{1}{3000}$ th. The smallest are usually found in the peripheral lacteals; the largest in the thoracic duct. They are evidently *cells* in process of development; and from the appearances presented by those which are seen in the chyle of the thoracic duct, there can be little doubt that they have the power of reproducing themselves in the ordinary mode. The first appearance of these cells in large number is exactly coincident with the first appearance of fibrin in the chyle,—at least to an amount sufficient to produce spontaneous coagulation; and the delay of the chyle in the mesenteric glands appears to aid in their development, and to assist their operation. In the lower Vertebrata the absorbent system has none of these (so called) glands; and hence we see that they are not *essential* to the performance of its functions. But in such animals the vessels are immensely extended in length; and whilst in the warm-blooded Vertebrata, in whose conformation the principle of concentration operates to the greatest possible extent, we see no such prolongation; the end being answered by the excessive convolution of the absorbents in the mesenteric glands, where it seems probable that the chyle is delayed during the development of its characteristic cells. Similar statements apply to the *lymph*, and to the lymphatic vessels and glands. This fluid is probably to be regarded, not as a product of the decomposition of the tissues, which is destined to be thrown out of the system, but as the product of that secondary digestion, by which a portion of the materials that have formed a component part of the tissues, and have been set free by their disintegration, is again rendered subser-

vient to nutrition, and reconveyed into the current of the circulation. Into the arguments in favour of this view (which differs from the ordinary doctrine regarding the function of the lymphatic system) we cannot here enter; but it may be remarked that the animal matter of the lymph is mainly of an albuminous character, and that it gradually undergoes a transformation into fibrin during its passage through the absorbent vessels and glands.

The continuation of this process in the blood is believed by the writer to be effected by means of the *white*, or *colourless*, corpuscles, to which increased attention has lately been directed. That these are *identical with*, or are the immediate *offspring of*, the corpuscles of the chyle and lymph, there seems much reason to believe from their similarity in size and appearance. Whilst the *red* corpuscles vary in dimension from less than $\frac{1}{72000}$ th of an inch (Musk Deer) to $\frac{1}{337}$ th (Proteus), the colourless corpuscles have not been observed to depart widely from the diameter of $\frac{1}{3000}$ th of an inch in any vertebrated animal; consequently, while they are but little larger than the average of red corpuscles in man, and are scarcely distinguishable from them, except by the practised microscopist, they are far more minute than the oval blood-discs of reptiles and fishes, and are at once recognised, even by a cursory observer. Now it is a fact of great physiological interest and importance, that whilst the *colourless* corpuscles are to be met with in the nutritious fluids of *all* animals, which possess a distinct circulation, the *red* corpuscles are restricted to the blood of Vertebrata. This observation, which was first put forth by Wagner,* has been confirmed by the writer of this article, who had been previously struck with the very close analogy between the floating cells carried along in the current of the circulation in some of the very transparent aquatic larvæ, (especially those of the Culicidæ,) and the lymph-corpuscles of the Frog. Now it is evident from this fact, that, as the *blood* of Vertebrata is distinguished from their *chyle* solely by the presence of red corpuscles in the former, and by their absence in the latter, the nutritious fluid of invertebrated animals is rather analogous (as Wagner has remarked) to the chyle and lymph, than to the blood of Vertebrata. Or, to put the same idea in another form, the presence of the colourless corpuscles in the nutritious fluids appears to be the most general fact in regard to its character throughout the whole animal scale; whilst the presence of red corpuscles in that fluid is limited to the vertebrated classes. Hence it would not be wrong to infer that the *function* of the colourless corpuscles must be of a *general* character, and intimately connected with the nutritious properties of the circulating fluid; whilst the function of the red corpuscles must be of a *limited* character, being only required in one division of the animal kingdom. Further, it has been noticed by Mr. Gulliver that in the very young embryo of the Mammalia, the white globules are nearly as nume-

* Physiology, by Willis, Part II.

rous as the red particles: this, Mr. Gulliver has frequently noticed in fetal deer of about an inch and a half long. In a still smaller fetus the blood was pale from the preponderance of the white corpuscles. It is, therefore, a fact of much interest that, even in the mammiferous embryo, at the period when growth is most rapid, the circulating fluid has a strong analogy to that of the Invertebrata. It then, too, bears in other respects the most striking analogy to chyle; since it consists of the fluid elaborated from the organizable matter supplied by the parent, and *directly* introduced into the current of the circulation. The function of the placental vessels may be regarded as double; for they are at the same time the channel, through which the alimentary materials supplied by the parent are introduced into the circulating system of the fetus, and the medium of aerating the fluid which has traversed the fetal system. Hence the placenta may be regarded as at once the *digestive* and the *respiratory* apparatus of the fetus, and the fluid circulating through the cord as at once chyle and blood. It is not until the pulmonary and lacteal vessels of the embryo have commenced their independent operation, that the distinction between the *blood* and the *chyle* of the fetus becomes evident; and we should expect, therefore, to find that the circulating fluid, up to the time of birth, contains a large proportion of white corpuscles, which is actually the case. There is a gradual decrease, however, in their proportional number, from the earlier to the later stages of embryonic life, in accordance with the diminishing energy of the formative processes. It has been also observed by Wagner* that the number of colourless corpuscles is always remarkably great in the blood of well-fed frogs just caught in the summer season; and that it is very small in those, which had been kept long without food, and in those examined during the winter.

The most remarkable evidence, however, of the connection between the generation of white corpuscles in the blood, and the production of fibrin, is derived from the phenomena of inflammation. A decided increase in the normal proportion of fibrin in the blood (from $2\frac{1}{2}$ to $3\frac{1}{2}$ parts in 1000) may probably be looked upon as the essential indication of the existence of the inflammatory condition. For it appears from the observations of Andral and Gavarret (which have been confirmed by many other pathologists) that such an increase *uniformly* manifests itself, when a local inflammation commences,—even when the proportion of fibrin has previously been abnormally low, as in febrile diseases; that it bears a constant relation with the extent and intensity of the diseased action; and that it diminishes with the abatement of the morbid condition of the part affected. In some instances, the proportion of fibrin was seen to rise as high as 9 or even 10 parts in 1000; but an increase to the amount of 6, 7, 8 parts, was more common. That this production of fibrin is due to a *local* change can

scarcely be doubted; since it is frequently observed to commence before any *constitutional* symptoms manifest themselves; and it may be regarded, in fact, as one cause of these symptoms. Now the recent microscopic observations of Mr. Addison* and Dr. Williams,† which were made independently of each other, have established the important fact, that a great accumulation of white corpuscles takes place in the vessels of an inflamed part; and this seems to be caused at first by a determination of those already existing in the circulating fluid, towards the affected spot; but partly by an actual increase or generation of these bodies, which appear to have the power of very rapidly multiplying themselves. The accumulation of white corpuscles may be easily seen, by applying irritants to the web of a frog's foot. Mr. Addison has noticed it, in the human subject, in blood drawn by the prick of a needle, from an inflamed pimple, the base of a boil, the skin in scarlatina, &c. And the writer, without any knowledge of these observations, had remarked a very obvious difference between the proportions of white corpuscles, in blood drawn from a wound in the skin of a frog immediately upon the incision being made, and in that drawn a few minutes after; and had been led, like the observers just quoted, to refer this difference to a determination of white corpuscles to a part irritated. The absolute increase, sometimes to a very considerable amount, in the quantity of white corpuscles in the blood of an inflamed subject, has been verified by Mr. Gulliver and several other observers. These facts, therefore, afford strong ground for the belief, that the production of fibrin in the blood is closely connected with the development of the white corpuscles; and when we consider them in connection with the facts previously urged, there scarcely appears to be a reasonable doubt, that the elaboration of fibrin is a consequence of this form of cell-life, and is, in fact, its express object.

A recent observation of Mr. Addison's, moreover, would seem to indicate, that no inconsiderable proportion of the fibrin of the circulating blood is contained within the white corpuscles. "Provide six or eight slips of glass, such as are usually employed for mounting microscopical objects; and as many smaller pieces. Having drawn blood from a person with rheumatic fever, or any other inflammatory disease, place a drop of the colourless liquor sanguinis, before it fibrillates, on each of the large slips of glass; cover one *immediately* with one of the smaller slips, and the others one after another *at intervals of thirty or forty seconds*: then, on examining them by the microscope, the *first* will exhibit colourless blood corpuscles in various conditions, and numerous white molecules distributed through a more or less copious fibrous network; and the *last* will be a tough, coherent, and very elastic membrane, which cannot be broken to pieces nor resolved into

* Medical Gazette, Dec. 1840; Jan. and March, 1841.

† Medical Gazette, July, 1841; and Principles of Medicine, pp. 209, 210.

* Op. cit. p. 245.

smaller fragments, however roughly or strongly the two pieces of glass be made to rub against each other. This is a 'glaring instance' of a compact, tough, elastic, colourless, and fibrous tissue, forming from the colourless elements of the blood; and the several stages of its formation may be actually seen and determined. Numerous corpuscles may be observed, in all these preparations, to have resolved themselves, or to have fallen down into a number of minute molecules, which are spread out over a somewhat larger area than that occupied by the entire corpuscles; and although still retaining a more or less perfectly circular outline, yet refracting the light at their edges, in a manner very different from that in which the corpuscles themselves are seen to do. It is from these and various other larger and more irregular masses of molecules on disintegrated corpuscles, that the fibrinous filaments shoot out on all sides, as from so many centres; or frequently the filaments are more copious in two opposite directions."*

A different view of the cause of the production of fibrin, however, has been entertained by some eminent physiologists; and it does not seem right to allow the opinions of Wagner, Henle, and Wharton Jones to pass without notice, even though they appear to the writer to be easily set aside. By these observers, the elaboration of fibrin has been attributed to the red corpuscles, and has been regarded as one, at least, of their special functions. Nearly all the arguments, however, which have led us to assign this duty to the white corpuscles, tell equally against the doctrine now under consideration. The presence of fibrin in the circulating fluid may be regarded as a universal fact; but the red corpuscles are restricted to vertebrated animals: how, then, is the plastic element elaborated in the invertebrata? The number of red corpuscles in the blood of different classes bears an obvious relation to their amount of respiratory power, and to the functional activity of the several organs, which is closely connected with the amount of oxygen introduced into the system; but it does not bear the same relation with the activity of the formative processes, which may be taking place energetically (as in the development of the embryo, or in the reparation of parts in the adult) in a state of functional quiescence. That the proportion of red corpuscles in the blood had a special relation to the nervous and muscular energy of an animal, and to the amount of oxygen consumed by it, has long ranked as a physiological truth; and the opinion has been gradually gaining ground, that although the liquor sanguinis is undoubtedly affected in a considerable degree by exposure to oxygen in the respiratory capillaries, the red corpuscles are the special agents by which oxygen is conveyed into the systemic capillaries, that it may furnish the conditions required for muscular contraction and other functional operations, which depend upon a due supply of arterial blood. In the inverte-

brated animals in general, the amount of respiration is so low, that this special provision is not required. There is an apparent exception, however, in the case of Insects, which have no red corpuscles, and which yet can display a greater amount of animal energy, and which consume (when in a state of activity) a larger quantity of oxygen in proportion to their size, than beings of any other class whatever. But here the exception proves the rule; for the conveyance of oxygen through the tissues is not accomplished in Insects by the circulating fluid, which has a comparatively sluggish movement, but is effected more directly by the ramifying tracheæ, which introduce air into the minutest portions of the structure.

The pathological evidence that the red corpuscles are not the elaborators of the fibrin, appears to the writer to be quite conclusive. Whilst the quantity of fibrin is so remarkably increased in inflammation, the number of red corpuscles undergoes no decided change. Again, the augmentation of the fibrin is not incompatible with a chlorotic state of the blood; the peculiar characteristic of which is a great diminution in the proportion of red corpuscles. By such alterations, the normal proportion between the fibrin and the red corpuscles, which may be stated as $A : B$, may be so much altered, as to become, in inflammation, $3A : B$, in chlorosis $A : \frac{1}{2} B$. Again, in fever, the characteristic alteration in the condition of the blood appears to be an increase in the amount of red corpuscles, with a diminution in the quantity of fibrin; yet if a local inflammation should establish itself during the course of a fever, the proportion of fibrin will rise; and this without any change in the amount of corpuscles. Lastly, the effect of loss of blood has been shown by Andral's investigations to be a marked diminution in the number of red corpuscles, with no decided reduction in the quantity of fibrin, even when this is much above its normal standard; and in this condition of the blood it has been observed by Remak that the colourless corpuscles are very numerous.

Formation of tissue.—With the elaboration of the alimentary materials into fibrin, the preparatory processes of nutrition may be regarded as terminating; since the next step is the transformation of this substance into organised tissue. Upon the mode in which this is effected, much light has been thrown by recent enquiries; but several points still remain obscure. We shall endeavour, in the following account, to distinguish what has been satisfactorily ascertained from what is merely hypothetical.

That the particles of perfectly-elaborated fibrin are capable, in solidifying, of spontaneously assuming a definite arrangement, cannot now be questioned. In the ordinary crassamentum of healthy blood, this arrangement can be seen, by examining thin slices under the microscope; especially after the clot has been hardened by boiling. A number of fibres, more or less distinct, may be seen to cross one another; forming by their interlacement a tolerably regular network, in the meshes of which the red corpuscles are entangled. This fact was known to

* Transactions of the Provincial Medical Association, 1843.

Haller; but it has been generally overlooked by subsequent physiologists, until attention was drawn to it by the enquiries of Messrs. Addison, Gulliver, and others. It is in the buffy coat, however, that the fibrous arrangement is best seen; on account, as it would appear, of the stronger attraction which the particles of fibrin have for one another, when its vitality has been raised by the increased elaboration to which it has been subjected. That there are varieties of *plasticity* in the substance, which, on account of its power of spontaneously coagulating, we must still call *fibrin*, appears from this fact among others,—that, in tuberculous subjects, the *quantity* of fibrin in the blood is higher than usual (Andral and Gavarret), although its plasticity is certainly below par. It is easy to understand, that its plasticity may be increased as that it may be diminished; and this either in the general mass of the blood, or in a local deposit. In fact, the *adhesions* which are formed by the consolidation of coagulable lymph,—or in other words, of liquor sanguinis, whose plasticity has been heightened by the vital actions of the white corpuscles in the capillaries of the part on which it has been effused,—often acquire very considerable firmness, before any vessels have penetrated them; and this firmness must depend upon that mutual attraction of the particles for one another, which in *aplastic* deposits is altogether wanting, and which in *caco-plastic* deposits is deficient. A very interesting example of a structure entirely composed of matted fibres, and evidently originating in the simple consolidation of fibrin, has lately been discovered by the writer. This is found in the membrane adherent to the interior of the egg-shell (*membrana putaminis*); and also in that which forms the basis of the egg-shell itself. Between the two, there is no essential difference; as may be seen by examining “an egg without shell,” as it is commonly termed, (or rather one in which the shell-membrane has been unconsolidated by the deposition of calcareous matter); or by treating the egg-shell with dilute acid, so as to remove the particles of carbonate of lime, which are deposited in the interstices of the network. The place of the shell is then found to be occupied by a membrane of considerable firmness, closely resembling that which surrounds the albumen of the egg, but thicker and more spongy. After maceration for a few days, either of these membranes may be separated into a number of laminae, each of which (if sufficiently thin) will show the beautiful arrangement of reticulated fibres, which is delineated in the accompanying figure (*fig. 405*). It is impossible to refuse to such a structure the designation of an *organised tissue*, although it contains no vessels, and must be formed by the simple consolidation of fibrin, poured out from the lining membrane of the oviduct of the bird. It is probably in the same manner, that the chorion of the mammiferous animal originates; since this is a new envelope, formed around the ovum, during its passage along the Fallopian tube. In the latter, for an ulterior purpose, vessels are afterwards developed, by extension from the contained ovum; and by the nutrition they

Fig. 405.

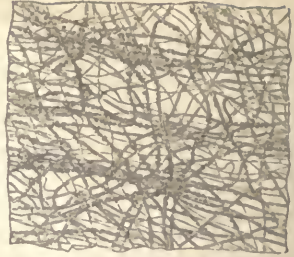

Membrane of egg-shell.

supply, its size is increased, and changes take place in its texture. But in the egg-membrane of the bird, there is no need of vessels; because no subsequent change in its texture is required, and its duration is sufficient for the purpose it has to answer.

In all these instances, the fibrillated structure contains a certain amount of corpuscles, which lie in the meshes of its network. These have been termed “*exudation-globules*” by some authors,—by others “*organic germs*,”—and by others (especially Mr. Addison) are regarded as identical with the white corpuscles of the blood. They may present considerable varieties in size and appearance; having in some instances the characters of fully-formed cells, whilst in others they rather resemble nuclei or aggregations of granules. It seems difficult to believe, that they can be *identical* with the white corpuscles of the blood; since if the exudation has been poured forth by open orifices, sufficiently large to admit these to pass, there would be no obstacle to the escape of the red corpuscles,—at least where the latter are of smaller size, as in mammalia. They are probably to be regarded as originating in the fibrinous deposit, from germs which it contained, when effused from the vessels; of which germs the white corpuscles may have not improbably been the parents. The degree of their development into cells would appear to depend upon the degree of plasticity of the deposit. Not unfrequently they seem arrested in their progress; especially in cases where the exudation verges towards a *caco-plastic* character. In the egg-membrane, very few of these corpuscles are seen; and as it is thus almost entirely composed of consolidated fibrin, it possesses considerable toughness. The same is the case with highly plastic exudations from inflamed serous surfaces. But in deposits which are less plastic, we see a larger number of these corpuscles, and a diminution and decreased tenacity of the fibres; the membrane then becomes quite friable, and approaches the character of a purulent exudation. The *caco-plastic* deposits will be presently noticed, under the head of *Abnormal States of Nutrition*. At present we shall proceed to consider the application of these facts to the ordinary conditions of that process.

The question naturally suggests itself, *in limine*, whether any of the tissues of the animal body are formed by the simple effusion of fibrin

from the bloodvessels, and its subsequent consolidation in the manner already described. No such idea seems to have occurred to the continental physiologists, who, following in the path which had been marked out by Schwann, have sought to trace, for *all* the tissues, an immediate origin in cells. But the writer does not find that any of them are sufficiently aware of the facts already detailed, in regard to the definite structure which fibrin will assume, when it has undergone a high degree of elaboration, and has coagulated under the most favourable circumstances; and with the greatest respect to their authority, he ventures to attach sufficient weight to the observations of Messrs. Gulliver and Addison, confirmed as they are by his own, to induce him to adopt a different explanation, which he offers with diffidence, to be confirmed or set aside by future enquiries.

The fibrous tissue existing in false membranes, and still more that which has been discovered by the writer in the egg-shell, may be regarded in his opinion as a type of those *simple fibrous* tissues, which form a large porportion of the bulk of the body in the higher animals, and of which the function is purely mechanical. When we contrast the fabric of an animal with that of a plant, we are struck with this important difference in their conformation,—that whilst the latter is made up solely of elements which are to perform their several parts in the performance of the nutritive and reproductive operations, (the only exception being in the case of those more solid portions of the fabric which are destined to give mechanical support to the remainder),—the former is composed of a much greater variety of parts, which are adapted to *move upon* each other. Now this purpose requires, not only the addition of certain new tissues, to which nothing analogous is to be found in plants, for creating and exercising the motor power, but also an adaptation of the whole structure to this new condition. The tissues of plants entirely consist of *cells*, or simple modifications of them. Some of these cells being strengthened by internal deposits, form the solid woody framework of the stem and branches, which gives support to their wide-spreading foliage and numberless blossoms. Others coalesce, by the disappearance of their intervening partitions, into tubes, which serve for the conveyance of fluid between the most distant parts. But the great bulk of the fabric still consists of cells, closely adherent to each other, and actively participating in the various operations of organic life. In like manner in the animal body, a certain part of the cells have contributed to form the solid osseous and cartilaginous framework, which not only gives support and protection to the body, but contributes to its power of movement, by affording fixed points for the attachment of its muscles. Others again have coalesced into vessels, as in plants, for the rapid conveyance of fluids. Others, too, after a similar coalescence, have developed new and remarkable products in the interior of the tubes thus formed, and become transformed into those nervous and muscular tissues, to which nothing

analogous is found in plants, and which are the peculiar instruments of animal life. Yet still there remains a large number of unchanged cells scattered through the body, which perform, as in plants, the essential part in the functions of nutrition, reproduction, &c. These, however, could not be held together in their constantly-varying relative positions without some intervening substance altogether different from *true cellular* tissue. It must be capable of resisting tension with considerable firmness and elasticity; it must admit free movement of the several parts upon one another; and it must still hold them sufficiently close together to resist any injurious strain upon the delicate vessels, nerves, &c., which pass from one to another, as well as to prevent any permanent displacement. Now all these offices are performed in a remarkably complete degree, by the *areolar* tissue,* the reason of whose restriction to the animal kingdom is thus evident. It is chiefly composed of interlacing fibres and shreds of membrane, which do not seem possessed of any other than simply *physical* properties; the small degree of vital contractility which it possesses in some spots (as in the *dartos*), being attributable to the intermixture of fibres analogous to those of the unstriated muscular tissue. One of its most remarkable peculiarities is the rapidity of its regeneration; and this is obviously due, in part, to the large amount of bloodvessels by which it is traversed. The accounts given of its developement by Schwann and Henle do not by any means correspond; and it appears to the writer, that the evidence of the participation of cells in the process, in any other way than as elaborating the fibrin, is very insufficient. The observation already quoted from Mr. Addison (p. 746) seems to explain some appearances occasionally met with, which induced those observers to assign a more direct cell-origin to this tissue; for he notices that the remains of the white corpuscles, and little aggregations of the granules they had emitted, seemed to be the centres, as it were, of the fibrillation.†

If we once admit this doctrine in regard to areolar tissue, it is not difficult to extend it to those fibrous structures in general, which resemble it in the *physical* nature of their functions; and we shall then leave to the tissues of cell-origin, in animals as in plants, the performance of those operations which must be regarded as *vital* in their character. As an additional argument in support of this view, the appearances presented by the *semi-fibrous* cartilages may be adduced. In the cartilages of

* This was formerly termed CELLULAR tissue, under which designation it is described in the present work; but the appellation here given is the one under which it is now generally spoken of, for the sake of distinguishing it from tissues really composed of cells.

† Since writing the above, the author has become aware that a view of the developement of areolar tissue, essentially corresponding with that advanced above, has been recently put forth by Mandl, (Manuel d'Anatomie Générale, p. 552,) although he too seems quite unaware of the degree in which the fibrinous part of the blood *fibrillates* in coagulating.

the ribs, for instance, a more or less distinct fibrous appearance may be frequently seen in the intercellular substance; this is sometimes so faint, that it might be considered as an illusion, occasioned by the manipulation to which the section has been subjected; but it is often so well-defined, as almost to present the appearance of the true fibrous structure. No indication of the direct operation of cells in the development of these fibres has ever been witnessed; and we can scarcely do otherwise than regard them as produced by the regular arrangement and consolidation of the particles of the *blastema* or plastic element, in virtue of its own inherent powers.

The production of the simple structureless membranes which exist in various parts of the body must be attributed, we think, to the consolidation of a thin layer of *blastema*, rather than to any metamorphosis of cells. The *basement* or *primary* membrane which lies beneath the epithelium of the mucous and serous membranes, and of the glandular prolongations of the former, as well as the membrane lining the bloodvessels, and bearing epithelium upon its inner surface, must probably be regarded in this light. It may be questioned, however, whether this is not to be regarded, in most cases at least, as a *transitional* form, rather than as a permanent structure. We have reason to believe that in many situations (as the lining of the alimentary canal and of its glandular prolongations,) the nuclei contained in this membrane must be continually developing themselves into epithelium-cells; and in some other instances it would seem, that a fibrous structure develops itself from it by a metamorphosis of a different kind. It is not difficult to imagine, that these variations may have their origin in the degree of plasticity of the element, of which the membrane was originally composed, and in the number of cell-germs which it includes. Considerable differences in the appearance of this primary membrane may be seen, in examining the residua left after dissolving away the calcareous matter of shells by dilute acid. Putting aside the *cellular* tissue which certain shells exhibit,* the most general animal basis of each layer is a very delicate membrane, which sometimes appears completely homogeneous, even when viewed with the highest powers of the microscope; but which in other instances presents a distinctly granular aspect, as if it consisted of a layer of molecules consolidated together by a structureless cement. These membranous films are included between strata of calcareous matter, poured out from the surface of the mantle, and thus undergo no change subsequent to their first production.

We have next to consider the mode in which the tissues, whose form is distinctly *cellular*, or which can be clearly proved to *originate* in cells, derive their nutriment from the blood. In the early stage of embryonic development,

as already stated, the whole fabric is composed of cells which present no recognizable differences amongst themselves, and which yet, by a process of histological transformation, become the elements of the different organs,—some of them still retaining the form of cells,—whilst others undergo changes which remove them altogether from that category. To the former class belong adipose tissue, pigment-cells, the various kinds of epithelium and epidermis, cartilage-cells, &c. Of the latter, the capillary bloodvessels, and the muscular and nervous tissues, are characteristic examples. Now there would seem much reason to believe, that in the regular process of nutrition, each of these tissues draws from the blood the materials necessary for its reparation and growth, as it does in the earlier stages for its first development; and that the function of the blood is confined to the supply of these materials,—the germs of the new tissue being supplied by that previously existing. At any rate it may be safely affirmed that no evidence has been adduced which renders any other view probable. The self-nutrient power of the tissues is evinced by this fact among others,—that in no instance are their ultimate elements penetrated by the capillary bloodvessels. Thus although adipose tissue is traversed by a minute capillary network, the fat-cells lie in the meshes of this network, and are as independent of it, except as regards the supply of nutrient materials which they derive from it, as if they adhered closely to each other. The muscular fibres and nerve tubes, again, are not penetrated by capillary vessels, but are only surrounded by them. The connection of the cartilage-cells with the vessels is still more remote; for the true cellular cartilages are not penetrated by bloodvessels at all (in the healthy state at least), but are nourished by the imbibition of fluids from a plexus of dilated vessels that comes into relation with their external surface. We may infer, therefore, that the bloodvessels are subservient to the act of nutrition only by conveying the nutrient fluid into the neighbourhood where it is required,—just as, in the irrigation of a meadow, the water is carried in channels over the general surface, but has to find its way by percolation into the spaces between these;—and that it is by the materials which they derive from it that the several tissues are enabled to maintain their integrity, by reproducing their structure as fast as it is disintegrated. And it may not be unreasonable to infer that, in the very act of the death and disintegration of the parent structure, the germs of the new structures destined to replace it are set free, as happens in the reproduction* of the simple cellular plants.

It may be doubted, however, whether the same holds good in regard to newly-forming parts, or with respect to the epithelium cells, which are formed on the free surface of the basement membrane, and which are cast off without reproducing themselves. These last seem to originate in germs contained in the subjacent membrane, and a continual supply of such germs must therefore be required. It can

* See a paper by the author on the Microscopic Structure of Shell, in *Annals of Natural History*, December, 1843.

scarcely be doubted, therefore, that these are supplied directly from the blood. Dr. Barry and Mr. Addison have spoken with much confidence of the *metamorphosis* of the white corpuscles of the blood into epithelium-cells; but that this idea is totally inadmissible is proved by the existence of a continuous stratum of basement-membrane, between the capillary network and the epidermic or epithelial layer. It is not impossible, however, and perhaps may be considered probable, that the cell-germs contained in this basement-membrane, from which the cells on its external surface appear to take their origin, may be the offspring of the white corpuscles of the blood, which thus supplies both the plastic materials and the germs of the constantly-forming new crops of epithelial cells. There is no other tissue in the body, after all its organs had attained their full development, which can be regarded as taking its origin from the blood in the same degree; but it may be questioned whether in the formation of new parts, either during the development of the embryo, or in the reparation of injuries, the office of the blood is not of a similar duplex character. Thus when plastic lymph is thrown out, between the two surfaces of a wound, the first process, as already mentioned, is its fibrillation; but at the same time a development of cells takes place in it, which cells may possibly undergo a subsequent metamorphosis into the various forms of tissue which the newly-formed part afterwards contains, precisely as in the first development of the embryonic structure. Such a view, at least, would seem probable in regard to the capillary vessels, which seem to be formed at least as much by the inherent powers of the coagulum, as by the extension of the vessels from the subjacent surface.

These views are thrown out as hints, rather than as settled ideas. It would be premature, in the present state of our knowledge, to attempt to decide questions of such importance without much further examination; and we can only attain a balance of probabilities by interpreting the insufficient results of observation by the aid of the best analogies we can find. The whole subject has made immense progress during the few years which have elapsed since the commencement of the present work; but here, as elsewhere, retardations have occurred through hasty generalization and dogmatic assumptions; and much patient, well-directed, sagacious observation will be needed to unravel the many intricate questions that yet remain to be solved.

Varying activity of the nutritive processes.

—Without any change in the *character* of the nutritive processes which we have been describing, there may be considerable variations in their *degree of activity*; and this, either as regards the entire organism or individual parts, though most commonly the latter. These variations may be so considerable as to constitute disease; though there are some which take place as part of the regular series of physiological phenomena. Thus the nutritive processes should have a degree of activity more than suffi-

cient to supply the waste of the body during the whole period of infancy, childhood, and adolescence, until, in fact, its full dimensions are attained; whilst, on the other hand, they are usually less rapid than the disintegrating processes in old age, so that the bulk of the body diminishes. Now as the waste of the body, so far from being *more* rapid in old age than in childhood, is much *less* so, it follows that the difference in the activity of the nutritive processes in these two states must be very considerable; and this is manifested, not only in the greater demand for food which exists in the child (relatively to the bulk of its body), but also in the greater quickness and facility with which injuries are repaired. Local variations may also occur as part of the regular train of vital actions in the adult; thus we perceive an enormous increase in the amount of tissue contained in the uterus and mammary glands during pregnancy, and a decrease in the bulk of the thymus gland after the first year of infancy. Now in these cases we see that increased nutrition is invariably connected with increased functional activity, and diminished nutrition with diminished functional activity: and this we shall find to be the constant rule in regard also to those variations which must be considered as abnormal.

Increased nutrition, or *hypertrophy*, is never known to affect the *whole* body to a degree sufficient to constitute disease. It cannot be produced as a consequence of the ingestion of an undue supply of food, for this does not increase the formative activity of the tissues, but merely renders the blood richer in nutritive materials, a part of which the excreting organs are called on to be continually removing, without its being rendered subservient to the wants of the body; whilst another part may be employed in the nutrition of one particular tissue, the adipose, which has a tendency to increase with the superfluity of non-azotized food, provided that the requisite amount of cellular tissue be generated to hold the fatty matter. But examples of hypertrophy of particular tissues or organs are very common. Thus any particular set of muscles which is subjected to frequent and energetic use acquires a great increase in bulk, as we see in the arms of a blacksmith or waterman, the legs of an opera-dancer, &c. The hypertrophy of *these* muscles is a consequence of their increased functional activity, which being produced by an exertion of the will, and unaccompanied with any injurious effects on the system, can scarcely be regarded as morbid. But there are many instances in which the involuntary muscles acquire a greatly-increased strength, in consequence of an obstruction to their action which results from disease. Thus we see the right ventricle of the heart become hypertrophied (and dilated at the same time) where chronic pulmonary disease produces a difficulty in the propulsion of the blood through the vessels of the lungs; the muscular fibres of the bladder become enormously hypertrophied, when stricture, diseased prostate, or other causes produce a demand for increased expulsive force

on the part of the bladder; and those of the stomach also become so in cases of stricture of the pylorus. As an instance of hypertrophy of a secreting organ in consequence of an undue excitement of its function, we may notice the enlargement which usually takes place in the kidney, when its fellow is incapacitated by disease. And the nervous system presents us with a very remarkable case of hypertrophy of a part resulting from over-excitement of its function; for if young persons who naturally show precocity of intellect are encouraged rather than checked in the use of their brain, the increased nutrition of the organ (which grows faster than its bony case) occasions pressure upon its vessels, it becomes indurated and inactive, and fatuity and coma are the result. Local hypertrophy may be induced also by local congestions; but in such cases it will usually be found that the form of tissue produced is of the lowest kind, unless the functional activity of the part be increased by the congestion. Thus when disease of the heart produces long-continued congestion of the lungs, liver, spleen, &c., the bulk of these organs increases; but chiefly by the production of an additional amount of interstitial areolar tissue, which may result (as we have seen) from the simple consolidation of fibrin; and partly also (in the case of the spleen especially) by the gorging of their distensible veins with blood.—One of the least explicable cases of hypertrophy is that which takes place in the thyroid gland, causing bronchocele. So little is known of the normal office of this organ, that it cannot be determined whether its increased size be due to an increased activity of its functional operations, or to an unusual formative activity in its tissue, depending on some hidden cause. The connection of this disorder with causes which affect the whole constitution, rather than individual parts, would seem to indicate the former.

When the waste of the tissues is more rapid than their replacement by nutrition, *atrophy* is said to take place; and this may affect either the whole body, or individual parts. General atrophy, marasmus, or emaciation, may result from an insufficient supply of plastic matter, from want of formative power in the tissues themselves, or from their too rapid disintegration. The insufficiency of the supply of nutritive matter may depend either on deficiency in the azotized substances ingested as food, or on imperfect performance of those processes by which they are converted into the plastic element,—fibrin. Hence, even when there is an ample supply of food, atrophy may take place to a very severe extent, in consequence of disordered digestion, or of want of vital power in the fibrin-elaborating cells. Again, we have reason to believe that the formative power in the tissues themselves may be diminished, so as to check the process of nutrition, even when the plastic material is supplied; thus there seems to be a complete stoppage of this action in fever, and a diminution of it in that irritable state of the system, which results from excessive and prolonged bodily exertion or anxiety of

mind, especially when accompanied by want of sleep. It is difficult to separate this cause, however, from mal-assimilation on the one hand, or too rapid decay of the tissues on the other: for we know that, in such states, there is a tendency to imperfect elaboration of the fibrinous element, and at the same time an unusually rapid disintegration, as manifested by the increased amount of urea in the urine. The influence of excessive waste in causing atrophy of the body is well shown in the cases of diabetes mellitus and colliquative diarrhœa; for in both these, the increase and deprivation of the secretions are undoubtedly to be regarded as the effects, and not the causes, of the textural changes with which they are associated. Colliquative diarrhœa is a constant occurrence on the last day or two of life in animals reduced by starvation, and is accompanied by that fetid odour of the body, which indicates that decomposition is already going on throughout the system. The same thing occurs as the ordinary termination to many diseases of exhaustion; in which inanition is unquestionably the immediate cause of death. Partial atrophy may occur in consequence of disuse of the organ affected, occasioning inactivity in its formative processes; or as a result of a deficiency of nutriment, occasioned by an obstruction to the circulation. Of the operation of the former cause we have many examples in the ordinary processes of the economy. Thus the uterus is atrophied, relatively to its previous condition, as soon as parturition has taken place; and the mammary glands, when lactation has been discontinued. It is probably in part to this cause, and in part to the diversion of the blood into other channels, that we are to attribute the atrophy of many parts, as the development of the system advances, which at an earlier period were of large comparative size,—such as the corpora Wolffiana, the suprarenal capsules, and the thymus gland. Many instances might be adverted to, of the influence of suspension of functional activity, as a result of disease or injury, in producing local atrophy. One of the most common cases is the atrophy of muscles which is consequent upon their disuse. This disuse will produce the same effect, whether it be occasioned by paralysis, which prevents the nervous centres from exciting the muscles to contraction; or by ankylosis, which interposes a mechanical impediment to their use; or by fractures or other accidents, the reparation of which requires the limb to be kept at rest. Or even if, without having suffered from any injury, a limb be fixed during some time in one posture, its muscles will become atrophied, as is seen in the case of the Indian fakirs. It has been shown by Dr. J. Reid, that the atrophy of the muscles, and their consequent loss of contractility, is not to be imputed to the withdrawal of nervous influence, in any other way than as producing cessation of their activity; for he found that, when the muscles of one leg of a frog, both whose crural nerves had been divided, were daily exercised by galvanism, they retained much more of their usual size and firmness than those of the leg which was

left at rest. A case has fallen under the writer's observation, in which *both* limbs were affected with almost complete (hysteric) paraplegia; but one was also frequently seized with violent cramps, from which the other was free; the difference in the muscularity of the two limbs was very striking, and was evinced by the greater circumference of the one affected with cramps (which was an inch and a half larger round than the other), as well as by its greater firmness of flesh. Similar facts may be adduced, in regard to atrophy of nerves, from interruption of their normal function. Thus when the cornea has been rendered so opaque by accident or disease, that no light can penetrate to the interior of the eye, the retina and the optic nerve lose, after a time, their characteristic structure; so that scarcely a trace of the peculiar globules of the former, or of the nerve-tubes of the latter, can be found in them. These and similar facts are readily understood, when connected by the general principle formerly laid down,—that every proper *vital* operation involves an act of nutrition; in such a manner that, whilst the vital properties of any part are dependent upon its due nutrition, the amount of its nutrition will in return depend upon the degree in which these properties are exercised.

Partial atrophy may depend, however, upon causes of a purely mechanical nature; such, for example, as produce an interruption of the current of blood through the part. This may result from changes in the arteries supplying it, such as ossification, or other forms of obstruction. Or it may be consequent upon disease in the part itself; as when the deposits produced by inflammation tend to contract, and thus to press upon the vascular structure, which frequently happens in the lungs, liver, and kidneys; or when the inflammation occurs in the vessels themselves, causing adhesion of their walls, and obliteration of their tubes; or when a new growth absorbs into itself all the nutritive materials which the blood supplies.

Abnormal forms of the nutritive process.—Under the preceding head we have considered the chief variations in the degree of activity that are witnessed in the ordinary or normal conditions of the nutritive process,—that is, those conditions in which the products are adapted by their similarity of character to replace those which have been removed by disintegration. But we have now to consider those forms of this process, in which the products are abnormal,—being different from the tissues they ought to replace. We shall confine ourselves to a brief examination of the two most important of these states;—that which is termed inflammation, and that which gives rise to tubercular deposit. The former results from an *excess* of the plastic element in the blood: the latter from a *depraved* condition of it, whereby its plasticity is impaired or destroyed.

Notwithstanding all the attention which has been given to the state of the *vessels* in inflammation, a careful consideration of its phenomena, with the light which recent investigations have

thrown upon these, leads us to attach comparatively little importance to this, and to seek for the essential character of the process elsewhere. The researches of Addison, Williams, Barry, Gulliver, Andral, and others, all seem to point to the following conclusions.—1. That there is a peculiar afflux or determination of the white corpuscles of the blood towards the inflamed part. 2. That the total amount of these corpuscles in the circulating blood undergoes a great increase. 3. That the quantity of fibrin in the blood augments in proportion to the extent and intensity of the inflammation; and this even when it was previously, from the influence of some other morbid condition, below the usual standard. With its quantity, its plasticity or tendency to organization also increases in a healthy subject. Now when these facts are compared together, and are connected with those formerly adduced, in regard to the probable function of the white corpuscles of the blood, they lead almost irresistibly to the conclusion, that the process of inflammation essentially consists in an undue stagnation of the white corpuscles of the blood in the vessels of the part, an excessive multiplication of these by the ordinary process of generation, and a consequent over-production of fibrin. By these changes, and by the results which follow them, inflammation may be distinguished from the various forms of hyperæmia and congestion. To the results, then, we shall next direct our attention.

It may be inferred, we think, from various phenomena, that whilst the formative power of the *blood* is increased in inflammation, that of the *tissues* is diminished. Certainly this is the case in regard to the system at large, when febrile irritation has been established; for, notwithstanding the increased plasticity of the blood, we see the body wasting, instead of increasing in vigour. And it may be inferred, also, in regard to the tissues of the part affected, from the tendency to atrophy and disintegration which they exhibit; and which is greater (leading even to the death of whole parts) in proportion as the inflammation is more intense, and as the tendency to the deposit of new products is the more decided. That a stagnation of blood takes place in the vessels of the inflamed part is another general fact, which throws some light upon the nature of the process; for this stagnation is obviously favourable to the transudation of the fluid plasma of the blood, through the walls of the vessels, into the surrounding tissue, or upon a neighbouring surface. This deposition of the fibrinous element, possessing a high degree of plasticity, and capable of spontaneously passing into simple forms of tissue (which may be gradually replaced by higher forms, when penetrated by vessels from the surrounding parts), may be regarded as the first characteristic result of inflammation. That this deposition of the fibrin, which has accumulated to an unusual extent in the blood, should take place *only* in the inflamed part, cannot perhaps be very readily accounted for; but we see that, when the inflammatory diathesis is once established,—or, in other

words, when the quantity of fibrin in the circulating part is much increased,—local inflammations will be excited by very trifling causes (at other times quite inoperative), which are followed by the same results as the original one.

But it frequently happens that the fibrinous element of the blood, though increased in quantity, does not possess its normal plasticity; and the deposits which are the consequence of its effusion are far from being as organizable as in the preceding case, and are either imperfectly organizable, or *caco-plastic*, or altogether unorganizable or *aplastic*. The tendency to such deposits may arise from various causes. Thus, when the inflammation is from the first of a low or asthenic character, or when the blood is previously in an unhealthy condition (as, for instance, when there is a deficiency in the number of red particles, the presence of the normal amount of which seems important to the complete elaboration of the fibrin), no other kind of deposit takes place from the first; and even when organizable plasma has been copiously thrown out in the first instance, it is not unfrequently succeeded by *caco-plastic*, or *aplastic* products,—either from a change in the character of the inflammatory process itself,—or because the late products are thrown out in such a position as to be cut off from that influence of living surfaces around, which is necessary to their complete organization. Between the organizable or *euplastic*, and the *caco-plastic*, and *aplastic* deposits, the gradations are almost insensible. The cells and fibres which are characteristic of the first diminish in number and are less perfectly formed; and they are replaced by a granular amorphous matter, which possesses but little cohesion, and which, being totally incapable of entering into any form of tissue, acts as a foreign body, and becomes a source of irritation. The limited space allotted to this subject prevents any more particular description of these products from being here given; but there is one which must not be overlooked, since its occurrence is very frequent, its effects upon the system most important, and its character very peculiar. The product alluded to is *pus*. This is characterized by the presence of a number of cells of a peculiar aspect, having a very tuberculated or mulberry surface, which are seen floating in a fluid, termed *liquor puris*, which is of an albuminous or low fibrinous character, being entirely destitute of organizability. Now the production of pus in an inflamed part, or in other words, the act of suppuration, may be due to one of three causes, viz.,—the intensity of the inflammation; the presence of air, which becomes a source of irritation; and a previously vitiated state of the blood. Various attempts have been made to show that the pus-globule is a degenerated red or white corpuscle of the blood; but it seems more probable, however, that it does not escape from the vessels as a complete cell, but as a cell-germ, which may have had its origin in a white corpuscle of the blood; and which, under favourable circumstances, might have produced an exudation-corpuscle. At any rate, it must be regarded as

a *degenerated* form of cell; and the *liquor puris* must be considered as analogous to the plasma of the blood in a degenerated state.*

In what manner the inflammatory process determines the formation of the pus cell, and the consequent degradation of the product, we are at present unable to state; but that the degree of irritation in the part has an influence upon it is evident from the effects of the contact of air upon inflamed surfaces, causing those elements to take the form of pus, which would otherwise have been thrown out as a plastic deposit. This circumstance would seem to indicate, beyond all doubt, that the exudation and pus-corpuscles, the plastic lymph, and the *aplastic liquor puris* have the same origin, but that their character is determined by local circumstances. There is great reason to believe, that when pus is introduced into the blood, it may induce such a change in the character of the fluid, as speedily to impair its vital properties; so that the pus-corpuscles will rapidly propagate themselves in the blood, and the plasticity of the liquor sanguinis will be diminished. In this manner the whole system will be seriously affected, and there will be a tendency to deposits of pus in various organs—especially those which, like the lungs and liver, serve as emunctories to the system—without any previous inflammatory changes in these parts.

The last form of disordered nutrition which we shall consider is that which takes place in the *tuberculous* diathesis, and which is marked by the deposition of tubercular matter, in place of the normal elements of tissue, both in the ordinary process of nutrition, and still more when inflammation is set up. From an examination of the blood of tuberculous subjects it appears that the fibrinous element is not deficient in amount, but that it is not duly elaborated, so that the coagulum is loose, and the red corpuscles are found to bear an abnormally low proportion to it. We can understand, therefore, that such a constant deficiency in plasticity must affect the ordinary nutritive process; and that there will be a liability to the deposit of *caco-plastic* products, without inflammation, instead of the normal elements of tissue. Such appears to be the history of the formation of tubercles in the lungs and other organs, when it occurs as a kind of metamorphosis of the ordinary nutritive process; and in this manner it may proceed insidiously for a long period, so that a large part of the tissue of the lungs shall be replaced by an amorphous deposit, without any other ostensible sign than an increasing

* It would not seem improbable that the *liquor puris* is the product of the action of the pus-corpuscle, in the same manner as we have endeavoured to show that the *liquor sanguinis* is the result of the elaborating action of the colourless corpuscles of the blood. This idea seems confirmed by the observation of Mr. Gulliver, that the *pyogenic* membrane which lines the cavity of an abscess, and from which the fluid appears to be secreted, is chiefly composed of cells that bear a strong resemblance, on the one hand to the pus-corpuscles, and on the other to the colourless corpuscles of the blood; these cells are held together by fibrinous fibrils.

difficulty of respiration. It is in the different forms of tubercular deposit that we see the gradation most strikingly displayed between the euplastic and the aplastic formations. In the semi-transparent, miliary, grey, and tough yellow forms of tubercle, we find traces of organization in the form of cells and fibres, more or less obvious; these being sometimes almost as perfectly formed as those of plastic lymph, at least on the superficial part of the deposit, which is in immediate relation with the living structures around, and sometimes so degenerated as scarcely to be distinguishable. In no instances do such deposits ever undergo further organization, and therefore they must be regarded as *caco-plastic*. But in the opaque, crude, or yellow tubercle, we do not find even these traces of definite structure; for the matter of which it consists is altogether granular, more resembling that which we find in an albuminous coagulum. The larger the proportion of this kind of matter in a tubercular deposit, the more is it prone to soften, whilst the semi-organized tubercle has more tendency to contraction.

Fig. 406.*



Microscopic appearances of tubercular matter in the lungs, after Gulliver.

To the left, magnified 190 diameters, is shown a central portion of tubercle, from the lungs of a man aged 22, who died of pulmonary consumption; the tubercle is contained in the air-cells, and surrounded by the fibres of their walls. To the right is depicted some of the same tubercle, separated and magnified about 820 diameters.

Now although tubercular matter may be slowly and insidiously deposited, by a kind of degradation of the ordinary nutritive process, yet it cannot be doubted that inflammation has a great tendency to favour it; so that a larger quantity may be produced in the lungs, after a pneumonia has existed for a day or two, than it would have required years to generate in the previous mode. But the character of the deposit still remains the same; and its relation to the plastic element of the blood is shown by the interesting fact, of no unfrequent occurrence,—that, in a pneumonia affecting a tuberculous subject, plastic lymph is thrown out in one part, whilst tubercular matter is deposited in another. Now inflammation, producing a rapid deposition of tubercular matter, is peculiarly liable to arise in organs which have been previously

affected with chronic tubercular deposits, by an impairment of the process of textural nutrition; for these deposits, acting like foreign bodies, may of themselves become sources of irritation; and the perversion of the structure and functions of the part renders it peculiarly susceptible of the influence of external morbid causes. These views, at which several recent physiologists and pathologists have arrived on independent grounds, seem to reconcile or supersede all the discordant opinions which have been upheld at different times regarding the nature of tubercle, and lead to the soundest views with respect to the treatment of the diathesis.

Parasitic growths.—Besides the products of disordered nutrition, which have been just considered, there is another class of morbid structures, differing from the preceding in well-marked and important characters. Their existence and mode of growth cannot generally be traced to simple variations in the local circulation and in the formative powers of the parts affected; and they enjoy an *independent* vitality, which causes their maintenance and increase to be influenced but little by the state of the textures around, except so far as this may affect the supply of blood which they receive. They bear a certain resemblance to other tissues, in an early stage of the development of the latter; being for the most part composed of cells and fibres, combined in different modes: and they also correspond with them in chemical constitution. It is by this last character, indeed, that they are to be distinguished from the vegetable organisms, which are unquestionably developed occasionally in the living animal body, and which often closely resemble them in aspect. The best practical division of parasitic growths is into the *non-malignant* and the *malignant*;—the former being of local origin, not tending to reappear in distant parts of the body, and having no injurious effect upon the surrounding tissues, except by the pressure they may exercise upon them, or the nourishment they may withdraw;—whilst the latter, having once made their appearance in the body, tend to reappear at distant parts (even after the original growth has been removed), induce a complete change of structure and of actions in the organs in which they are developed, and exert a very depressing influence upon the bodily system at large.

The *non-malignant* growths may present various characters, intermediate between those of the tissues they replace, and those of malignant structures. In regard to their pathological cause, “we cannot at present go beyond the supposition, that they arise from altered vital properties in some of the molecules of the textures in which they are developed; so that, instead of being assimilated to these textures, and conforming to the laws of their growth and decay, these molecules grow of themselves in modes more or less peculiar, and more or less independently of the influences of the adjoining living parts. Where these modes are less peculiar, and more dependent upon the nutrition of the adjacent structures, the growths

* From Wagner's Physiology, p. 360.

are less abnormal, vary less from these structures, and more resemble either hypertrophy or euplastic deposits; and they do mischief rather from their size and situation than from their intrinsic nature. Where the mode of growth is more peculiar, and more independent of that of the textures in which they arise, the resulting tumours are more abnormal in their nature and mode of development; they approach in character to malignant diseases, acting injuriously, not only by their bulk and position, but also by abstracting the nourishment of the body, and tending to supersede the natural structures.*

Among the *malignant* growths, too, there are various shades or degrees of malignancy; one or more of the characters just now assigned to them being either absent or imperfectly developed. Thus there are certain growths which have a tendency to spread through the system, and even to propagate themselves from one individual to another, and which agree with true malignant growths in being composed, like them, of cells having a tendency to rapid multiplication, but which yet exert no serious influence upon the general constitutional state, and which cannot, therefore, be properly termed malignant: such are *molluscum* and *porrigo favosa*. And in other instances we meet with large tumours, producing a very injurious effect upon the surrounding textures, and exerting a very serious influence upon the system at large; the malignancy of which, however, is doubtful, because they show no tendency to reappear in other parts of the body. The origin of all these growths is involved in great obscurity; but there does not appear to the writer to be anything so *specific* in their character as to require the supposition that their germs are introduced into the body from without. It is true that when they have once established themselves they may be propagated by inoculation, which transplants some of the cells or cell-germs into a new locality; and the appearance of the disease in parts of the same body distant from those which were first affected, is probably due to the diffusion of the germs by the current of the circulation. But this power of reproduction is by no means limited to malignant growths, since it belongs to all cells at a certain stage of their development. And, as Dr. W. Budd † has remarked, the causes which have been supposed to induce cancer are not such as can, in any intelligible way, favour the introduction of germs from without the body. Thus in chimney-sweeps and others the continued application of soot has been observed to be followed by the occurrence of cancer in the scrotum in such a number of cases, as to justify the inference that it has been the exciting cause; and the often-repeated contact of a tobacco-pipe with the lip has also been considered a cause of cancer of that part. But neither of these causes can in any conceivable way promote the development of cancer from extrinsic germs. We are quite in the dark, however, as to the

mode in which any perversion of the ordinary nutritive processes arising from external irritation of whatever kind, can give rise to structures so peculiar in their nature and history as are the various forms of cancerous growths. For a detailed account of their characters as unveiled by recent microscopic researches, the reader must seek elsewhere; since all that we can here attempt is to give a general idea of their peculiar nature. (See PRODUCTS, MORBID.) The greater part of every true malignant growth is made up of cells, which, instead of undergoing transformation into other kinds of tissue, continue in their original state, and enjoy the power of rapid multiplication. In the harder forms of cancer the masses of cells are traversed by bands of solid fibrous texture, and such are of slow growth, and may remain with but little change for many years, apparently because the pressure to which they are subjected prevents their rapid increase. But the softer forms are composed almost entirely of cells, and these of the most rapidly multiplying character; so that, in the rapidity with which they shoot up, they remind us of the vegetable fungi. Now the influence of either of these forms of morbid growth upon the constitution is very decided, and distinguishes them from non-malignant structures; but this is more evident, the more time is afforded for the manifestation of their effects. It is evident even from the appearance of the subject of them that the blood must be in a very depraved state, for there is a peculiar dirty sallowness about the complexion which is seen in no other disease; the emaciation reaches a point unequalled under any other circumstances; and accidental injuries which may occur during the progress of the malady are but very imperfectly repaired. In their deleterious effects upon the character of the circulating fluid, therefore, we can not improperly compare cancer-cells with pus-globules.

General summary.—From what has been stated it appears evident, that the process of nutrition essentially consists in the growth of the individual cells composing the fabric; and that these derive their support from the organic compounds with which they are supplied by the blood, just as the cells composing the simplest plants derive theirs from the inorganic elements which surround them. And as different species of the latter select and combine these in such modes and proportions as to give rise to organisms of very diversified forms and properties, so is it easily intelligible that the different parts of the fabric of the highest animals, whether normal or abnormal, should exercise a similar selective power, in regard to the materials with which the blood supplies them. The structure composing every separate portion of the body has what may be termed a *special* or *elective* affinity for some particular constituents of the blood; causing it to abstract from that fluid and to convert into its own substance certain of its elements; and this is exercised not only in regard to the normal constituents of the blood, but also towards morbid matters which may be circulating with it. (O) the causes which enable the cells of animal or

* Williams's Principles of Medicine, § 574.

† Lancet, May 28, 1842.

vegetable structure to exercise these varied attractions, our knowledge is at present very limited. It will probably long remain an ultimate fact in physiology that cells have the power of growing from germs, of undergoing certain transformations, and of producing germs that will develop other cells similar to themselves, just as it is an ultimate fact in physics that masses of matter attract each other; or in chemistry, that the molecules of different substances have a tendency to unite, so as to form a compound different from either of the elements. It is of such ultimate facts that the science of vitality essentially consists. The conditions under which the assimilating power operates are, however, like the laws of chemical affinity, freely open to our investigation; and it is a great step in the progress of the inquiry to become aware that these are so closely conformable throughout the organized world, as we have endeavoured to show them to be.

It may be stated as a general fact, that in assimilating or converting into its own substance matter which was previously unable to exhibit any of the manifestations of life, every cell thereby participates in the process of organization and vitalization; for by the new circumstances in which the matter is placed its sensible properties are altered,—some which were previously dormant being now caused to manifest themselves, whilst others, which were previously evident, become latent. No matter that is not in a state of organization can exhibit these properties, which, from their being peculiar to living bodies, and altogether different from those of which physics and chemistry take cognizance, are termed *vital*; and it may also be asserted that no matter which exhibits perfect organization is destitute of the peculiar vital properties belonging to its kind of structure. (See LIFE.) Hence every act of nutrition is, in fact, the creation of a new amount of vital force; and when that vital force has been expended, no more can be developed except by the nutritive process.

From the foregoing details it further results that we must regard each part of the organism as having an *individual* life of its own, whilst contributing to uphold the *general* life of the entire being. This life, or state of vital action, depends upon the due performance of the functions of all the subordinate parts which are closely connected together. The lowest classes of organized beings, and even the highest at an early stage of their embryonic development, are made up of repetitions of the same elements; and each part, therefore, can perform its functions in great degree independently of the rest. But in ascending the scale or in tracing the advancing development of the embryo, we find that the individual lives of the cells become gradually merged (so to speak) in the general life of the structure; for they become more and more different from each other in function, and therefore more and more dependent on each other for their means of support; so that the activity of all is necessary for the maintenance of any one. Hence the interruption of the function of any important organ

is followed by the death of the entire structure; because it interferes with the elaboration, circulation, and continual purification of that nutritious fluid which supplies the pabulum for the growth and reproduction of the individual cells. But *their* lives may be prolonged for a greater or less duration after the suspension of the regular series of their combined actions; hence it is that *molecular* death is not always an immediate consequence of *somatic* death. (See DEATH.) But if the function of the part have no immediate relation to the indispensable actions just referred to, it may cease without affecting them; so that molecular death may take place to a considerable extent without somatic death necessarily resulting.

The foregoing considerations have a very important bearing on the question of the degree to which the process of nutrition is under the influence of the nervous system, a question on which, as it appears to the writer, very erroneous ideas have been commonly entertained. For it has been customary to speak of this process (as well as of secretion) as *dependent* upon nervous agency; or, in other words, to assert that the nervous system is not only the instrument of the functions of animal life, but is also the *primum mobile* of the organic operations. Now the independent properties of the cells in which all organized tissues originate, might be of itself a satisfactory proof that in animals, as in plants, the actions of nutrition are the results of the powers with which they are individually endowed; and that whatever influence the nervous system may have upon them, they are not in any way essentially dependent upon it. Moreover there is an evident improbability in the idea "that any one of the solid textures of the living body should have for its office to give to any other the power of taking on any vital actions;" and the improbability becomes an impossibility, when the fact is known, that no formation of nervous matter takes place in the embryonic structure, until the processes of organic life have been for some time in active operation. The influence which the nervous system is known to have on the function of nutrition may operate in several ways. Thus, if the nerves proceeding to any set of muscles be divided, those muscles will be atrophied in consequence of the cessation of their activity, as already explained. In other instances we may not improbably regard the influence of the nervous system to be exercised through the medium of its controlling power over the diameter of the bloodvessels, by which it may govern the afflux of blood. And there can be little doubt that, in some manner yet unexplained, the nervous system exerts an influence over those preliminary processes, by which the plastic element of the blood is elaborated; so that long-continued anxiety or depression of mind may produce general atrophy, or a tendency to tuberculous deposit. It appears to be invariably through *emotional* states of the mind that the nutritive process is affected; the *will* not possessing any direct power of influencing them. But there can be no doubt that the continual voluntary direction of the atten-

tion to the sensations of any part, giving rise to emotions on which the mind frequently dwells, may so far modify the nutrition of the part as to become a cause of diseased action in it. All these facts, however, point rather to the *influence* which the nervous system possesses over the organic functions, than to the dependence of these upon its agency; and it may be safely asserted that no such proof of its more direct influence, as is required to counterbalance the manifest improbability which has been shown to attend it, has yet been given. Some additional considerations upon this important subject will be offered under the head of **SECRETION**.

(W. B. Carpenter.)

ŒSOPHAGUS. (ὄσω, I carry, and φαγω, I eat).—Gr. οἰσοφάγος; Fr. *œsophage*; Ital. *gola*; Germ. *Speiseröhre*. The œsophagus is that portion of the alimentary canal which intervenes between the inferior extremity of the pharynx and the cardiac orifice of the stomach. It occupies the lower part of the cervical region, traverses the thorax, and enters the abdomen.

Direction.—The direction of the œsophagus is nearly vertical; in the cervical region it deviates slightly to the left; in the upper part of the thorax it inclines somewhat to the right, and in the lower part of the same region it is again directed to the left, so as to occupy the median line during its passage through the diaphragm.

Dimensions.—The œsophagus is not of uniform diameter throughout its entire length. In the neck it is narrower than in any other region; it consequently happens that a morsel of food too large to pass readily along the œsophagus, is usually arrested immediately after it has been transmitted from the pharynx. In its upper part the œsophagus is somewhat flattened and compressed in the antero-posterior direction, but its inferior portion is more or less cylindrical, and presents the appearance of a rounded cord.

Relations.—The œsophagus has many important relations, which may be considered successively in the cervical, thoracic, and abdominal regions. In the cervical region it corresponds anteriorly to the membranous part of the trachea, with which it is connected by some intervening cellular tissue: in the lower part of the neck where it deviates to the left it comes in contact anteriorly with the left sterno-thyroid muscle, the thyroid gland, the inferior thyroid artery, and the left recurrent nerve. Posteriorly it has the cervical vertebræ and the longus colli muscle, with which it is connected by means of loose cellular tissue, so that free movement of the œsophagus upon the spine is allowed during the process of deglutition. Laterally it is in relation with the thyroid body, with the common carotid arteries, and more externally with the vagi nerves and the internal jugular veins: In consequence of the œsophagus deviating slightly to the left in the lower part of the neck, its relations are somewhat different on the two sides. Thus the left common carotid is in closer relation with

the œsophagus than the right. The left recurrent nerve is anterior to the œsophagus, while the right is somewhat posterior.

The *thoracic portion* of the œsophagus is placed in the posterior mediastinum. It corresponds anteriorly to the trachea, and immediately below the bifurcation of the trachea to the left bronchus, which crosses it obliquely, to the arch of the aorta, to the left subclavian and carotid arteries, and to the base of the heart, from which it is separated by the pericardium. Posteriorly it has the spine, with which in the upper part of the chest it is in close contact; but as it descends it becomes separated from the spine by cellular membrane, by the right intercostal arteries, by the vena azygos, and by the thoracic duct, which in the lower part of the chest is on the right of the œsophagus, but ascending it passes behind and above is placed on its left side. At the inferior part of the thorax, immediately before passing through the diaphragm, the œsophagus has behind it the thoracic aorta. Laterally it has on its left the aorta, and on the right side the pleura forming the right layer of the posterior mediastinum. It is accompanied by the two vagi nerves, one on each side, which send numerous filaments from one to the other, and thus form the plexus gulæ; at the lower part of the chest the left vagus nerve becomes somewhat anterior, and the right posterior. This portion of the œsophagus is surrounded by a considerable quantity of loose cellular tissue and by several lymphatic glands.

The abdominal portion of the œsophagus is very short, and has no relations of importance. After passing through the diaphragm it is covered both anteriorly and posteriorly by the peritoneum. It also comes into contact anteriorly with the left lobe of the liver. Without depressing the stomach and elevating the diaphragm this portion of the œsophagus cannot be seen, and, in fact, can scarcely be said to exist.

Structure.—The œsophagus is composed of a muscular and a mucous coat, with some connecting cellular tissue. The muscular coat of the œsophagus, which is considerably thicker than that of any other portion of the alimentary canal, consists of two distinct layers. The external layer is composed of fibres arranged in a longitudinal direction, and is twice the thickness of the internal layer, the fibres of which surround the canal in a circular manner. The longitudinal fibres are regularly disposed around the œsophagus; superiorly they arise in the median line from the posterior surface of the cricoid cartilage, and laterally on each side from the lower border of the inferior constrictor muscle of the pharynx; at the inferior extremity of the œsophagus they spread out and are continuous with the longitudinal fibres of the stomach. The circular fibres are a continuation of the posterior part of the inferior constrictor muscle, but they are much more delicate than the fibres of this muscle. These fibres pass for the most part transversely; the spiral arrangement which some anatomists have described does not ge-

nerally exist in the human subject. The colour of the muscular fibres is pale red, less pale than those of the succeeding portions of the alimentary canal, and less deeply coloured than those of the pharynx. A microscopic examination shews them to be composed of both striped and unstriped fibres, mingled to an uncertain extent. "In some specimens from the human subject we have failed in detecting any striped fibres in the lower half of the œsophagus, either in the circular or longitudinal layer; but in other examples we have found them to within an inch of the stomach."*

Mucous membrane.—The mucous membrane of the œsophagus is of a pale colour; it presents a number of longitudinal furrows, which are produced by a slight folding of the membrane during the partial contraction or ordinary tonicity of the circular muscular fibres: the apparent laxity of the mucous membrane is no more than sufficient to allow of the dilatation of the canal which occurs during the process of deglutition. In addition to the longitudinal furrows there are some finer lines or wrinklins passing in various and indefinite directions, which are analogous to the fine grooved lines observed in the skin of various parts of the body. The mucous membrane is remarkable for its thickness; the epithelium is so abundant as to be distinctly visible to the naked eye; it forms a thick layer similar to a cuticle, and terminates at the cardiac orifice of the stomach in a well-defined irregular fringed border. It is composed of the lamelliform or scaly variety of epithelium.† The mucous membrane is connected with the subjacent muscular layer by the intervention of an abundant lax areolar tissue, which allows of a movement of these membranes upon each other during the repeated variations to which the diameter of the œsophagus is subject in the process of deglutition.

Œsophageal glands.—In the submucous areolar tissue of the œsophagus are found a number of small glands. They may be felt through the mucous membrane, which they elevate here and there, as little circular or oval flattened granular bodies; they are most numerous at the lower extremity of the tube. Their structure is the same as that of the buccal and duodenal glands. From the duct, which opens on the free surface of the mucous membrane, a few ramifications proceed and become embedded in the submucous areolar tissue. The branches are short and sacculated, having the appearance of small vesicles collected on a common stalk. The epithelium lining these glands is of the spheroidal variety.‡

Vessels and nerves.—The arteries distributed to the œsophagus are derived from several sources. In the neck they come from the inferior thyroid artery; in the chest some come directly from the aorta, others from the intercostals, and occasionally some from the internal

mammary arteries; in the abdomen, branches are derived from the coronaria ventriculi and from the phrenic arteries. The veins corresponding to these arteries empty themselves into the inferior thyroid, the superior cava, the azygos, internal mammary, coronaria ventriculi, and phrenic veins. The *lymphatics* open into the glands which surround the œsophagus in considerable numbers. The *nerves* are derived chiefly from the pneumo-gastric. The recurrent branch of the pneumo-gastric in its course upwards sends numerous filaments to the œsophagus. In the chest, as the trunks of the pneumo-gastric nerves lie on the œsophagus, each one sends off filaments which pass backwards, encircling the tube, and meeting with branches from the opposite nerve. The plexus thus formed is called the plexus gulæ; it is joined by some filaments from the thoracic ganglia of the sympathetic.

Function.—The office of the œsophagus is to receive the aliment from the pharynx and to convey it into the stomach. This, the third and last stage of the process of deglutition, is unattended by sensation and uninfluenced by volition. The following is the mode in which the food is transmitted along the œsophagus. After being duly masticated and moistened in the mouth, it is received into the pharynx, and is thence propelled into the upper orifice of the œsophagus. The muscular fibres, both circular and longitudinal, of that part of the tube into which the food is propelled are at once stimulated to contract; the mass is consequently pushed onwards into the relaxed portion of the tube immediately succeeding; the stimulus of contact with this part produces the same effect upon it as has already been produced upon that part of the tube which the food has just quitted, and the contraction of the first portion continuing at the time when that of the second portion is taking place, the substance is necessarily propelled onwards: it thus comes into contact with successive portions of the tube, and in each successive portion the same effect is produced, the contact of the substance exciting contraction, and the remaining contraction of the part which it has just quitted preventing regurgitation. These phenomena occur in a much less space of time than is occupied in their description, and the food is rapidly transmitted along the entire length of the canal. A notion may be formed of the rapidity with which these contractions are transmitted along the œsophagus by observing the rapid vibrating movements in the neck of a horse while drinking. The secretion constantly poured out by the œsophageal glands has the effect of moistening and lubricating the interior of the tube, and thereby of facilitating the transmission of solid portions of food. The contractions of the œsophagus, which ordinarily commence at its pharyngeal and terminate at its cardiac extremity, sometimes take place in a reverse order, the direction of the movement depending on the part to which the stimulus is first applied. Dyspeptic persons are not uncommonly troubled with eructations of a liquid from the stomach, giving rise to what is fami-

* Physiological Anatomy and Physiology of Man, by Todd and Bowman.

† See the article MUCOUS MEMBRANE.

‡ *Ibid.*

liarily called heartburn; and in pyrosis, or water-brash, the amount of liquid which suddenly enters the mouth is often very considerable. This inverted action of the œsophagus admits of a ready explanation. By the contraction of the muscular fibres of the stomach a portion of liquid is expelled into the lower extremity of the œsophagus; here it immediately excites contraction of the muscular fibres which surround it, and being prevented from again entering the stomach by the momentary continuance of the same effort which has expelled it into the œsophagus, it must necessarily pass into the relaxed portion of the tube immediately above; and thus, by the contraction of successive portions of the tube, the liquid soon reaches the pharynx. In ruminants, the greater portion of the food is returned from the stomach to the mouth by this inverted action of the œsophagus. During the action of vomiting there is an inverted action of the œsophagus in addition to the propulsive effort arising from the contraction of the stomach and abdominal muscles.

We have now to point out the precise mode in which these contractions are induced, to explain the intermediate links between the application of a stimulus to the mucous membrane and the occurrence of the muscular contraction. In the first place, unless we swallow a very large or a very hot morsel of food, no sensation attends its passage along the œsophagus. After the food has passed that portion of the pharynx upon which the glosso-pharyngeal nerve is distributed, we cease to be conscious of its presence; and again, when a bitter liquid is eructated from the stomach, it produces no sensation of taste until it reaches the same point. As the passage of food along the œsophagus is unattended by sensation, so is it uninfluenced by volition. We cannot by any effort of the will perform the action of deglutition unless we bring a portion of food, or a liquid (as the saliva), into contact with the pharynx, by means of which the action of the parts may be excited. Again, no effort of the will can arrest the process of deglutition after the food has entered the œsophagus, and if a liquid be made to pass into the pharynx of a person in whom the exercise of volition is suspended by a fit of apoplexy, deglutition is performed in a manner almost as perfect as by a person in health. An apparent exception to the general rule that the movements of the œsophagus are beyond the control of the will is afforded by the very rare examples of persons possessing the power of rumination. A voluntary power over the œsophagus, however, appears by no means necessary to account for this. It probably depends on the possession of an unusual degree of voluntary power over the movements of the stomach, and especially of its cardiac orifice, by means of which the contents of the stomach can be expelled at will into the inferior extremity of the œsophagus, and thus are brought within the influence of its involuntary movements. Any one may satisfy himself that he possesses some degree of voluntary power over the cardiac orifice of the stomach, if after

swallowing a bottle of soda water he will direct attention to the power which he possesses of preventing the sudden escape of gas from the stomach, and, on the contrary, of increasing the propulsive effort probably by contracting the abdominal muscles. It is probable that many persons might by practice acquire the power of rumination. Since the contractions of the œsophagus cannot be excited by volition, are they dependent on the direct stimulus of the muscular fibres by contact of the food, independently of the nerves and of the nervous centres? That this is not the case is proved by an experiment performed by Dr. J. Reid.* He divided in a rabbit the vagus nerve on each side above the œsophageal plexus, but below the pharyngeal branches. The animal received the food which was offered to it, and by a propulsive effort of the tongue and pharynx transmitted it to the œsophagus, which, having lost all power of contraction, remained passive, and became at length completely distended and choked up by the materials thrust into it from above. It is evident then that the œsophagus loses its power of contraction if we cut off its communication with the nervous centres. As we have before seen that the will is not the agent which determines the contractions of the œsophagus, there remains but one explanation of these movements, which is, that they belong to the class of reflex actions. An impression made upon the mucous membrane of the œsophagus is communicated by the afferent nerves to the medulla oblongata, and thence an influence, the precise nature of which we are ignorant of, is reflected along the efferent nerves to the muscular fibres of the part to which the stimulus was applied. The only parts of this circle of actions which we recognise by our senses are the application of the stimulus and the occurrence of the muscular contraction; but these are doubtless connected in the manner above mentioned. The œsophagus receives both its excitator and its motor nerves from the pneumo-gastric; it thus derives its nervous influence from that portion of the nervous centre, namely, the medulla oblongata, which is the centre of the respiratory movements. Hence it will be seen that when in any case of disease of the nervous centres deglutition becomes seriously impaired, there is much reason to fear that the more important function of respiration will soon become involved.

Abnormal anatomy.—The œsophagus may deviate from the normal state in form or in structure. In some cases malformation may exist without obvious change of structure, but it is more common to find them combined. Malformation of the œsophagus may be either congenital or acquired.

Congenital malformation.—It sometimes happens that the œsophagus is congenitally deficient, terminating above in a cul-de-sac, the inferior extremity of the pharynx also terminating in the same manner. This is usually associated with an imperfect development of the oral cavity and of the lower jaw, the latter

* See the Edin. Med. and Surg. Journal.

being in great part or altogether deficient. In some cases the pharynx does not terminate in a cul-de-sac, but opens by a small orifice at the side of the neck. Another congenital malformation more rare than the last consists in the division of a portion of the œsophagus into two canals placed side by side.

Acquired malformation.—One of the most common kinds of acquired malformation is dilatation either general or partial. In the Museum of King's College there is a remarkable specimen of a dilated œsophagus. At each extremity it is healthy and of the natural size; the intermediate part is enlarged to an extraordinary degree of dilatation; the lining membrane is thickened and opaque, and has the appearance of having partially yielded from dilatation. The muscular fibres were of the natural colour and thickness. The dysphagia in this case was as great as in a case of stricture.* Dilatation is a common consequence of stricture. In such cases the dilatation usually occupies the whole circumference of the canal. In some rare cases dilatation occurs in the form of a pouch projecting on one side of the canal. Occasionally the mucous membrane alone becomes pouched, protruding as a hernia between the muscular fibres, but more commonly the muscular coat also dilates and expands over the pouch. Bleuland mentions a case in which a large pouch containing alimentary matters compressed the canal below so as completely to close it, and to prevent the passage of food into the stomach. These pouches are most common at the upper extremity of the œsophagus, probably in consequence of the sudden constriction which the canal undergoes at this point, and partly too in consequence of the muscular coat being thinner here than in any other part.†

Structural changes.—Among the most common are those which result from inflammation, which however is seldom idiopathic, but generally the consequence of swallowing irritating substances, hot liquids, the strong acids or alkalies. The effects in such cases vary in degree from slight redness and softening of the mucous membrane, to ulceration and sloughing of the whole circumference of the tube. The Museum at King's College contains a preparation of an œsophagus and of a slough discharged from it, which was taken from a young woman who had swallowed oil of vitriol. A week afterwards she brought up a slough having a tubular form, and consisting of the whole lining membrane of the gullet. Some of the muscular fibres were plainly visible on the outside of the slough, in its recent state.‡ Dr. Baillie gives a drawing of a *false membrane* lining the pharynx and œsophagus, taken from a patient who had thrush.

The œsophagus is very frequently the seat of *stricture*, the causes of which are various. Not unfrequently it depends on the contraction of a cicatrix after sloughing produced by the con-

tact of some irritating agent. The constriction in these cases appears to go on continually increasing. Sir C. Bell mentions a case in which starvation was the consequence of stricture of the œsophagus, *twenty years* after swallowing a quantity of soap lees. Another common cause of stricture is cancerous disease. This is generally confined to the lower extremity, but occasionally it pervades every part of the œsophagus.* A more rare case of stricture is described by Sir E. Home.† In this case a *membranous partition* extended across the canal; in the centre of the partition was a narrow passage; the coats of the œsophagus surrounding the stricture were but slightly changed. In cases of simple inflammatory stricture all the coats of the œsophagus are thickened and indurated at the seat of stricture, lymph is effused between them, and the bloodvessels are enlarged and distended. In consequence of stricture the œsophagus above becomes much dilated; sometimes ulceration and abscess occur. Dr. Monro mentions a case in which death occurred suddenly in consequence of purulent matter escaping into the trachea.

Morbid growths are occasionally found in the œsophagus. Dr. Monro‡ describes the dissection of a man aged 68, in whom the œsophagus was dilated by a large fleshy excrescence or polypus. It was attached three inches below the epiglottis and reached down to the upper orifice of the stomach. Haller§ gives an account of the dissection of a man, in whom was found a polypus about seven fingers' breadth long, and of the thickness of a worm, which in its general appearance it very much resembled; it had a carneo-fibrous appearance, a soft consistence, and a deep red colour. Fatty and steatomatous tumours have occasionally been found in the gullet. In other cases a portion of the canal has been found converted into bone, or cartilaginous tumours have grown from it.

An aneurism springing from the posterior part of the arch of the aorta may compress the œsophagus against the spine. The immediate consequence is difficulty of swallowing and other symptoms of stricture, and at length in many cases ulceration and sloughing of the œsophagus with escape of blood from the aneurism either into the mouth or the stomach.

BIBLIOGRAPHY.—*Meckel*, Manuel d'Anatomie. *Cruveilhier*, Anatomie Descriptive. *Bleuland*, De sanâ et morbosâ œsophagi structurâ. *Todd and Bowman*, Physiological Anatomy and Physiology of Man. *Müller*, Physiology, by Dr. Baly. *Monro*, Morbid Anatomy of the human gullet, stomach, and intestines. *Sir E. Home*, Practical observations on strictures. *Haller*, Disputationes ad morbos.

(Geo. Johnson.)

OLFACTORY NERVES. See NOSE and SMELL.

* *Monro's Morbid Anatomy of the Human Gullet, Stomach, and Intestines.*

† *Practical Observations on Strictures*, vol. ii. p. 407, 3d ed.

‡ *Op. cit.*

§ *Disputationes ad Morb. tom. iii. p. 596.*

* This case has been fully described by Mr. Mayo in the third volume of the Medical Gazette.

† *Meckel*, Manuel d'Anatomie.

‡ *Dr. Watson's lectures*, vol. ii. p. 332.

OPTIC NERVES. Under this heading it is proposed to describe the special nerves of vision in *man*, for although other names are also employed by anatomists to denote the nerves in question, the above is preferred as being expressive of their functions. It should be borne in mind that the optic nerves are likewise frequently called "the second pair;" a term derived from their numerical position on the base of the brain, as they are the second from before backwards on the under surface of the encephalon.

The anatomy and physiology of the optic nerves in *man* constitute the more immediate subjects of the present article, but as these would be imperfectly treated without the aid of comparative anatomy, the reader will find in the following pages frequent references to the condition of the nerves of vision in other animals also.

DESCRIPTIVE ANATOMY.

Apparent origin.—The optic nerves commence by two broad medullary tracts (the tractus optici), each of which becomes first apparent at the under surface of the corresponding optic thalamus.

Tractus opticus.—This appears to derive its principal origin from the corpus geniculatum externum: from that tubercle a narrow band arises which is soon reinforced by another (not in general equally large or distinct,) from the corpus geniculatum internum, and by the junction of the two the tractus opticus is formed: thus constituted, the tractus opticus takes a course forward and inward around the outer and inferior surface of the crus cerebri: it is at first deeply concealed from view in the great cerebral fissure, being overlapped from without by the middle lobe of the cerebrum, so as to be invisible until a portion of the brain, together with the arachnoid membrane and pia mater, have been displaced. Emerging from under cover of the middle lobe, the tractus next gains the front of the crus, runs along the margin of the tuber cinereum, and at length unites with the other tractus opticus to form the chiasma.

At the crus cerebri the tractus opticus increases in breadth, and of its two edges the anterior or external is here the thicker, while in the vicinity of the chiasma the tractus loses its flattened appearance, and becomes nearly cylindrical.

The tractus opticus is soft in texture *throughout*, being devoid of the tough neurilemma from which the *proper* optic nerve derives its uncommon firmness.

The tractus opticus receives a very extensive investment from the pia mater, which covers and adheres to all its free surface: *anteriorly*, where the tractus is approaching the chiasma, nearly two-thirds of its circumference are clothed by pia mater; and further back, that membrane even insinuates itself a short distance between the posterior or inner margin of the tractus, and the adjacent surface of the crus cerebri. The arachnoid has a far *less* extensive relation to the tractus opticus: in the early part of its course the tractus has no serous covering,

but in the interval between the middle lobe of the brain and the chiasma, the arachnoid passes beneath the tractus opticus, and so affords it a partial investment.

The anterior or external margin of the tractus opticus is so closely connected to the crus cerebri that in attempts to separate them the medullary substance is torn, and consequently some anatomists are of opinion that the crus furnishes filaments of origin to the tractus; but the posterior or inner edge of the tractus is not identified with the crus, for there the two structures can be separated without any violence to either.

The third and fourth nerves, before reaching the cavernous sinus, cross underneath the tractus opticus, but not *immediately*, for the serous and vascular membranes of the brain, and in general the edge of the middle cerebral lobe are interposed; the posterior communicating artery passes also across the tractus inferiorly, and the artery of the choroid plexus, in its course to the great cerebral fissure, runs beneath it, the pia mater alone intervening between these bloodvessels and the tractus opticus.

The *chiasma* is somewhat quadrilateral, and receives by each posterior angle the corresponding tractus opticus, while its anterior angles are prolonged respectively into either optic nerve; when "in situ," it is supported by a transverse groove of the sphenoid bone in front of the sella Turcica. *Posteriorly*, it is identified with the tuber cinereum, and to its upper surface the peculiar greyish membrane which closes up the third ventricle is adherent. The chiasma has complex relations to bloodvessels; behind and below this body the anterior portion of the coronary sinus is situated; external to the chiasma the termination of the internal carotid artery is placed, and in front of it are the anterior communicating, and a part of the anterior arteries of the cerebrum.

Optic nerve proper.—This proceeds from the chiasma, and after passing through the foramen opticum into the orbit, and arriving at the eye-ball, it perforates the sclerotic and choroid coats, and terminates in the retina.

First stage.—In the short interval between the chiasma and the optic foramen, the optic nerve is directed forward and outward; its size is perceptibly greater than that of the tractus opticus: it is not perfectly cylindrical in shape, being slightly flattened above and below; it is covered immediately by a dense tough neurilemma, and provided besides with a distinct sheath of arachnoid membrane, which, after accompanying the nerve fairly into the hole in the sphenoid bone, becomes reflected on the process of dura mater lining that aperture. Shortly after its commencement the optic nerve is separated from the olfactory by the anterior artery of the cerebrum. The ophthalmic artery leaves the cranium by the foramen opticum also, and lies beneath the optic nerve and to its outer side, being there enveloped in a special sheath of fibrous membrane.

Second stage.—Having entered the orbit, the optic nerve inclines more directly forwards; in consequence of this change of direction it

appears slightly bent at the optic foramen, the convexity of the curvature being turned outwards, and it traverses the fibrous and vascular coats of the eye at a point not exactly corresponding to the axis of the organ, but a little inferior and internal to that imaginary line.

Whilst in the orbit the optic nerve is completely cylindrical, but a circular constriction indents it just before piercing the sclerotic.

In this, its second stage, the optic nerve has still its neurilemmatous investment, and in addition, a perfect sheath of fibrous membrane, derived from and clearly traceable to the dura mater; this latter covering of the nerve possesses great strength and density; it is white and tough, and admits of ready separation from the proper neurilemma; moreover, it becomes continuous with the sclerotic, as the nerve is perforating that tunic.

In its course through the orbit the optic nerve is related to many of the important parts in that cavity; on leaving the foramen opticum it is surrounded by the posterior attachments of the muscles of the eye, and afterwards proceeds forwards to its destination through the centre of the space which has the recti for its limits. The nerve is here imbedded in a quantity of soft fat, from which it derives protection, and wherein other nerves and bloodvessels are immersed.

The nasal branch of the ophthalmic division of the fifth nerve (immediately after entering the orbit), the lenticular ganglion with its roots, and some of the ciliary nerves at their origin, the sixth nerve, and the ophthalmic vessels in their first stage, intervene between the *outer* surface of the optic nerve and the *external* rectus muscle.

Between the *upper* surface of the optic nerve and the *superior* rectus muscle, the superior division of the third nerve, the nasal branch of the ophthalmic division of the fifth nerve, and the ophthalmic artery and vein (in the second stage,) take their course; the vein being generally placed farther forwards than the artery.

Beneath the optic nerve, the inferior division of the third nerve is placed, and those twigs of the latter which are destined for the inferior and internal recti muscles separate the optic from the inferior rectus.

To the *inside* of the optic nerve and upon a higher plane, the ophthalmic vessels in their third stage, and the nasal branch of the ophthalmic division of the fifth nerve are situated; their position is rather above the upper edge of the internal rectus, but the branch of the third nerve which supplies that muscle separates it in part from the optic nerve.

The ciliary nerves run from behind forwards. Closely approximated to the optic nerve, they appear *mostly* above the nerve and on its lower and external aspects, but nevertheless one or two of the ciliary branches of the nasal nerve, as well as one or more from the lenticular ganglion, before piercing the sclerotic coat, gain, in general, the inner side of the optic nerve.

The long and short ciliary arteries in their course to the globe of the eye are intimately related to the optic nerve, some of the latter

vessels appearing actually to twine around it in a spiral manner: and many of the muscular branches of the ophthalmic artery lie immersed in the surrounding adipose tissue, at no very great distance from the nerve in question.

Communication with other nerves.—The optic nerves have no direct communication with the other *cerebral* nerves, but certain anatomists have traced filaments from the *ganglionic* system to them. Arnold (*Icones nervorum Capitis, Tabula Sexta*) has described and delineated two slender threads which run from the sphenopalatine or Meckel's ganglion to the optic nerve, and Hirzel observed in several instances the same arrangement. Tiedemann has seen an excessively delicate filament from the lenticular ganglion accompanying the arteria centralis retinae through the optic nerve: he has also discovered branches of the ciliary nerves taking the same course, and has even succeeded in following them as far as the retina; and M. Ribes (*Mémoires de la Société Médicale d'Emulation*) has asserted, that a minute subdivision of the cavernous plexus extends along the arteria centralis retinae, being derived from that division of the plexus which accompanies the ophthalmic artery.

Organization.—The organization of the optic nerve is in many respects peculiar. *Firstly.* From the chiasma to its distal extremity it is enveloped by a strong coating of neurilemma, and from the inner surface of this tunic a number of processes are detached which divide the interior of the envelope into longitudinal canals wherein the medullary substance is lodged; the optic nerve is not therefore a mere bundle of nervous cords (the structure prevalent in other nerves), but it is "a cylinder of collected tubes." *Secondly.* From the optic foramen to the sclerotic a sheath of dura mater is superadded to the optic nerve, and since none of the other cerebral nerves possess a similar covering, it must be considered a special provision for the security of the second pair. *Thirdly.* The arteria centralis retinae runs through the centre of the optic nerve (an anatomical arrangement of exceedingly rare occurrence): and the primitive fibres of the optic nerve evince a marked tendency to appear "varicose," a condition discovered by Ehrenberg, and considered by him and others peculiar to certain parts of the nervous system.

Real origin.—Anatomists have entertained very conflicting views upon this interesting question, so that from time to time different parts of the human encephalon have been considered the true origin of the optic nerves.

The older writers very generally believed that these nerves originate in the optic thalami, as the names "*thalami nervorum opticorum*" still applied to the bodies in question sufficiently attest, and Eustachius, Varolius, Lieutaud, Haller, &c. supported this opinion.

Others conceived that the nates (or anterior pair of the tubercula quadrigemina) are the principal source of the optic nerves; this was maintained by Ridley, Winslow, Zinn, Morgagni, Sanctorini, Girardi, Hildebrandt, Boyer, Bichat, and Sæmmerring; and the same

views were still more powerfully advocated by Gall and Spurzheim, although they admitted that the nerves derive a reinforcement from the corpora geniculata externa and the tuber cinereum.

Tiedemann (although fully aware that some filaments of the optic nerves are traceable to the surface of the optic thalamus both in the fœtus and adult) yet believed the *nates* and *corpora geniculata* externa to be the true origins of the nerves under consideration, and in this opinion he was strengthened by the Report on the Memoir of Gall and Spurzheim, made to the Institute by Cuvier, Portal, Sabatier, and Pinel.

According to Serres the tubercula quadrigemina are the proper sources of the optic nerves, and by Leuret the second pair are traced to a triple cerebral attachment, viz. the nates, testes, and optic thalamus.

It is proposed to examine in this place some of the grounds on which the foregoing opinions have been founded, and to this inquiry the aid of comparative anatomy is indispensably requisite.

FISH.—In these animals the optic nerves are distinctly traceable to two of the ganglia which compose the diminutive brain. The ganglia in question are called "optic lobes," from being the principal sources of the nerves of vision; they are hollow, and their position in the brain is between the cerebral hemispheres and the cerebellum (fig. 407.) The optic lobes

Fig. 407.



Brain of a Hake. (From nature.) Side view seen from below.

aa, optic nerves; *b*, oblique crossing of ditto; *c*, optic lobe of left side, being the chief source of the right optic nerve; *d d*, two inferior lobes from which the nerves of vision in fishes generally derive roots.

in fish very generally bear proportion to the size of the optic nerves (a proof of their physiological relations); and this proportion becomes particularly apparent in fish which possess either unusually small organs of vision, as the Eel; or eyes of different dimensions, as the Pleuronectes.

Fig. 408.

Brain of an Eel. (After Solly.) Seen from above.

a, optic nerve; *bb*, optic lobes, which are small, being proportional to the size of the optic nerves.



In many kinds of fish the optic nerves derive some of their filaments from a pair of

Fig. 409.

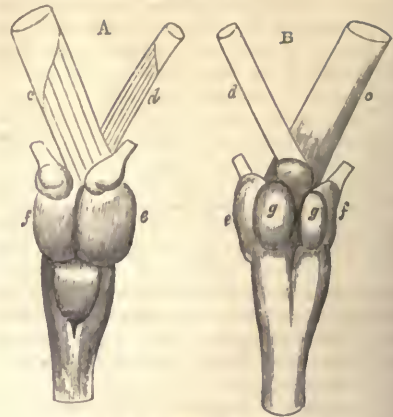

Brain of a Halibut. (From nature.)

A, seen from above. *B*, seen from below. *c*, large optic nerve in both; *d*, small optic nerve in both; *e*, large optic lobe in both; *f*, small optic lobe in both; *g g*, inferior lobes bearing the same proportion to each other in size that the optic lobes exhibit.

N. B. The large optic nerves derive their roots from the large lobes, and the small optic nerves have their origin in the small lobes.

tubercles placed on the under surface of the encephalon beneath the optic lobes (fig. 410).

Fig. 410.



Brain of a Ray. (From nature.) Seen from below.

a a, optic nerves; *b*, chiasma; *c c*, inferior lobes from which the optic nerves derive some of their roots; *dd*, optic lobes are derived from the principal sources of lobes very similar to the optic nerves.

REPTILES.—In this class the optic nerves those in fish; they are two in number and interposed between the cerebral hemispheres and the cerebellum: their size is proportional to the development of the optic nerves, and they are best seen at the upper or dorsal surface of the brain (fig. 411, c).

BIRDS.—In birds the optic nerves originate chiefly in two lobes situated at the inferior and lateral aspect of the brain, and called in this class also "optic lobes." The size of these lobes is in proportion to that of the optic nerves and organs of vision, and they are therefore

Fig. 411.



Brain of a Turtle. (From nature.) Lateral view.

a a, optic nerves; *b*, chiasma; *c*, optic lobes; *d*, tractus opticus, connecting the right optic lobe to the chiasma.

immense in birds of prey, and much smaller in other birds not equally remarkable for perfection of sight (fig. 412).

Fig. 412.

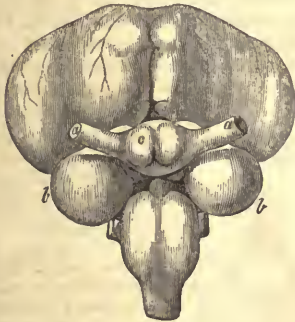

Brain of an Eagle. (From nature.) Seen from below.

a, a, optic nerves; *c*, chiasma, of immense size; *b, b*, optic lobes of large dimensions, placed at the inferior and lateral aspect of the encephalon.

The situation of these bodies in the brain of the bird, so different from their position in reptiles and fish, created at one period some doubts as to their true analogies; but Serres has shown that during the early stages of development the optic lobes occupy precisely the same position in the encephalon of the chick which they hold permanently in the brain of the reptile and fish, and he has thereby divested this subject of much of its obscurity. Thus before the tenth day of incubation the optic lobes of the chick are placed between the cerebellum and the cerebral hemispheres, and are then best seen at the dorsal aspect of the brain: but after this epoch the hemispheres and cerebellum approach each other at the expense of the optic lobes—the hemispheres extending backwards, and the cerebellum inclining forwards. By this double movement the optic lobes are soon overlapped behind, separated from each other, and at length pushed downwards and outwards to their permanent situation (fig. 413).

In Man the optic nerves derive some roots from the tubercula quadrigemina.

In birds, reptiles, and fish, the optic lobes constitute the principal sources of the optic nerves, and therefore in any attempt to ascertain the true origin of the second pair in man, a necessary preliminary will be to determine

what parts of the mammal's brain are analogous to the optic lobes of the lower classes.

The tubercula quadrigemina in man and the mammalia are identical with the optic lobes of the lower vertebrata; they occur as four small tubercles arranged in pairs, of which the anterior are called the nates, and the posterior the testes. In some of the class, as for example, Ruminantia, Solipeda, and Rodentia, the nates are of larger dimensions than the testes; in

others, as for instance, Carnivora, the testes predominate in size over the nates, and in Man and Quadrumana the two pairs are nearly equal.

Fig. 413.

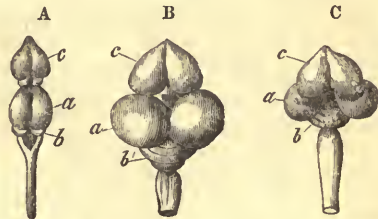

Brain of a chick. (After Serres.) At three different stages of incubation.

A, at sixth day; B, at tenth day; C, at fourteenth day.

A, *a, a*, optic lobes; *b*, rudimental cerebellum; *c, c*, cerebral hemispheres.

B, *a, a*, optic lobes separated from each other in front, and here slightly depressed; *b*, cerebellum inclining upwards and forwards between optic lobes; *c, c*, cerebral hemispheres growing backwards so as to overlap the optic lobes.

C, *a, a*, optic lobes still farther separated from each other and depressed towards base of brain; *b*, cerebellum growing upwards between the optic lobes; *c, c*, cerebral hemispheres carried backwards so as to come nearly into contact with the cerebellum. Reference to fig. 412 will shew the brain of the bird in its full-grown condition.

The tubercles in question have but little apparent similarity to the optic lobes of the lower Vertebrata: they occur as four eminences, while the optic lobes of birds, reptiles, and fish, are but two in number: they are of diminutive size; the optic lobes of birds, reptiles, and fish are of large dimensions in proportion to the brain: they are solid; the optic lobes of birds, reptiles, and fish are hollow: and in Man and most Mammalia they are covered upon the upper surface by the cerebral hemispheres, while the optic lobes in reptiles and fish are not so covered. Such obvious dissimilarity tended materially to obscure the real nature of the tubercula quadrigemina, but a careful study of the development of these bodies in the fetal brain led anatomists at length to discover their true analogies; and the researches of Tiedemann and Serres have chiefly contributed to establish the following particulars.

"In the earlier stages of uterine life the tubercula quadrigemina of Man and Mammalia

occur in the form of *two* masses; they persist as such during two-thirds of fetal existence; they are hollow at first and *not* covered by the cerebral hemispheres, and their size is immense in proportion to the bulk of the encephalon. As development advances, a transverse groove appears on the surface of the future tubercula quadrigemina; this divides them into *four* eminences, which are now for the first time really entitled to be called "quadrigemina:" nervous matter is gradually deposited from within on their walls, in consequence of which they henceforth become solid; their growth in size is arrested, and the cerebral hemispheres having grown backwards, overlap and conceal them from view. This overlapping occurs in all except a few of the lowest families of the mammalia, in which the tubercula quadrigemina remain permanently uncovered.

From the foregoing exposition it appears that during their development the tubercula quadrigemina in man and mammalia assume *for a time* all the characters which the optic lobes of birds, reptiles, and fish exhibit in the *permanent* condition; and hence it can scarcely be questioned that the nates and testes of the former class are identical with the optic lobes of the latter animals; but since the optic nerves in the oviparous Vertebrata are traceable to the optic lobes and manifestly derive from them the greater proportion of their roots, there is so far *primâ facie* evidence that the optic nerves in *man* have their origin in part from the tubercula quadrigemina. In further confirmation of the same view it may be remarked that some of the roots of the optic nerves in certain orders of the mammalia are seen to spring from these bodies; for example, in the horse a large proportion of the nerves can be traced distinctly to the nates. In Rodentia and Carnivora numbers of the fibres of the nerves emanate obviously from the same pair of tubercles, and in the Ruminants a similar anatomical arrangement prevails.

As an additional proof Tiedemann asserts that although much difficulty is encountered in attempts to follow the optic nerves to the tubercula quadrigemina in the *adult* human subject, he has succeeded in tracing them to the nates in fetuses of the third month, and at the fourth and fifth months he has frequently repeated the same observation.

Hunan pathology would seem to furnish some corroborative facts: thus in every case of long-continued atrophy of the optic nerve, where the wasting had involved the tractus opticus, Gall and Spurzheim found the nates of the side corresponding to the diseased tract diminished in size; and the experiments instituted upon living animals with a view to determine the functions of the several constituents of the brain by the successive removal of the different parts of the organ and careful observation of the disturbance thereby produced, lead also to the belief that the optic nerves have an origin in the tubercula quadrigemina. Of course great allowance must be made for inaccuracy in the result of such mutilations, but

Flourens, Magendie, Desmoulins, and Hertwig, all agree that destruction or mutilation of the nates and testes of one side invariably produces blindness of the opposite eye.

The writer agrees fully with Cruveilhier in the belief that the optic nerves in the human subject can be rarely traced to the tubercula quadrigemina satisfactorily; but nevertheless with the above facts before them, anatomists can scarcely refuse to allow that the optic nerves in man derive a share of their roots from these eminences.

The tubercula quadrigemina probably fulfil other purposes besides that of affording origin to the optic nerves.

This may be inferred from the fact that the optic nerves are not invariably developed in direct proportion to the tubercles; thus in certain mammals which are either devoid of optic nerves altogether, or in which they are so excessively diminutive as to be with difficulty discovered, the tubercula quadrigemina are as large and perfect as in other allied species possessed of well-marked organs of vision.

Fig. 414.



Brain of a mole. (From nature.) Seen from above. The upper part of each cerebral hemisphere has been removed by a horizontal section.

a, a, olfactory lobes; b, b, cut surface of cerebral hemispheres; c, c, nates; d, d, testes; e, cerebellum. The nates and testes, or tubercula quadrigemina, are of immense size; the cerebral hemispheres are small.

The common mole, for example, has eyes so diminutive and imperfect in structure, and its subterranean habits bespeak so little necessity for organs of vision, that many excellent anatomists believe it to have no optic nerves; nevertheless the tubercula quadrigemina in this animal are of immense size. (Fig. 414.) Serres never could satisfy himself that the mole possesses optic nerves, although he examined thirty or forty specimens for the express purpose, and if they do exist (as has been maintained by Carus and Treviranus) their minuteness must be almost microscopic. (See INSECTIVORA, vol. ii. fig. 453.)

Other examples confirmatory of the same views are afforded by the mammalia; it is stated on the authority of Serres that in the rat-mole of the Cape, and the Zanni, or blind rat-mole, there is no appearance whatever of proper optic nerves, (the rudimental eyes being supplied by the fifth pair,) and yet in these animals the tubercula quadrigemina exist in great perfection.

The human optic nerve probably derives roots from the optic thalamus.

The writer is of opinion that modern anatomists have fallen into error in supposing that none of the roots of the second pair are derived from the optic thalamus, although the arguments by which that supposition has been sustained are sufficiently imposing, viz. :—

"The size of the optic thalami is not in general in direct proportion either to that of the optic nerves or the acuteness of vision in animals.

"In most fishes the optic nerves are of great size, and the perfection of vision is extreme, yet in this class the optic thalami are absent.

"In birds, some of which enjoy exquisite powers of sight, the optic thalami are small.

"In mammalia the optic nerves bear no fixed proportion to the optic thalami; for instance, the horse, the ox, and the stag have larger optic nerves than the human subject, and yet the optic thalami in these animals are infinitely smaller than in man."

The foregoing arguments are not conclusive, for if the want of *direct* proportion between the optic thalami and optic nerves were a proof that the optic nerves draw *none* of their roots from the optic thalami, the very same principle would deprive the tubercula quadrigemina likewise of all claim to be considered a source of the second pair; since in the Mole and some other mammalia, already specified, the nerves in question and the tubercula quadrigemina actually occur in *inverse* proportion to each other.

In considering this question it should be recollected that in the mammalia *large* optic thalami are always found associated with *small* tubercula quadrigemina, and vice versa; and the same remark applies to the optic thalami and optic lobes of the other vertebrata; thus in birds, the optic thalami are small, but the optic lobes are of large dimensions: in reptiles the same proportions are apparent: in fish the optic thalami disappear, but the optic lobes are immense, and two inferior lobes (an additional source of the optic nerves) are superadded. These facts favour the presumption that the optic nerves derive roots from the optic thalami; for if (as is most probable) the optic thalami and the tubercula quadrigemina *both* afford origin to the optic nerves, they may be mutually supplemental to each other; and in that case the *reciprocal* proportions of these eminences will be a matter of no consequence, provided only that their *sum* be proportional to the nerves.

In farther support of the opinion here advo-

Fig. 415.

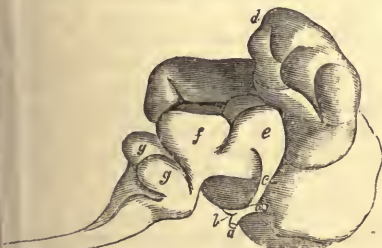

human fetal brain. (From nature.) Lateral view. About fourth month.

a, a, optic nerves; b, chiasma; c, right tractus opticus; e, right optic thalamus; f, mass of the tubercula quadrigemina; g, g, cerebellum; d, anterior extremity of right cerebral hemisphere, placed to exhibit the origin of the optic nerve.

cated, it should be borne in mind, that the tractus opticus is clearly traceable to the surface of the optic thalamus in the human *adult* subject, and the writer's experience has convinced him that the same anatomical disposition is very apparent in early fetal life (fig. 415). It may be well to add that in all the orders of the mammalia which he has had an opportunity of examining, the tractus opticus derives filaments from the optic thalamus: in the *horse*, although a large proportion of the tractus can be traced to the nates, its anterior fibres spring most distinctly from the optic thalamus (fig. 416);

Fig. 416.

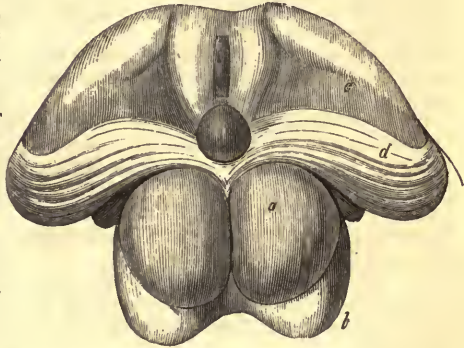

Tubercula quadrigemina, together with portions of the optic thalami and tractus optici of a horse. (From nature.)

a, a, nates; b, b, testes; c, c, optic thalami; d, d, tractus optici, springing partly from the nates, but deriving a great portion of their roots from the optic thalami, c, c.

in the *sheep* precisely the same arrangement exists: in the *hare* many filaments of the tractus opticus originate in the optic thalamus: and in carnivora and quadrumana a similar disposition prevails.

Recent microscopic discoveries in oology (if it be fair to argue from the development of the chick to the evolution of the human fetus) tend to confirm the views here put forward. Baer states that on the fourth day of incubation the encephalon of the chick consists of several cells, one of which corresponds to the third ventricle, and another to the optic lobes, and that these two cells are distinct from each other. The first rudiment of the eye observable in the chick occurs in the form of a vesicle which shoots out from the parietes of the cell of the third ventricle, and which becomes gradually elongated and drawn out into a canal. On the fourth day the eye represents a spherical cavity communicating with the third ventricle by a canal; this canal is the rudimental optic nerve, which becomes gradually solid, its cavity disappearing after the sixth day. During the earlier periods of growth there is no connection whatever between the optic nerves and the cell of the optic lobes, but the nerves just specified are from the very commencement in free communication with the cell of the third ventricle, and in the walls of that cell the optic thalami are developed.

The evidence which pathology has afforded upon this question must be considered unsatisfactory in the extreme; for, on the one hand, well authenticated cases are recorded in which vision remained perfect although the optic thalamus was extensively diseased, and Gall and Spurzheim have observed atrophy of the optic nerves to reach the nates without affecting the optic thalamus: while, on the other, Cruveilhier has seen the corpus geniculatum externum involved in the wasting of the optic nerve, and Magendie and Desmoulins, from their own researches and experiments as well as from those of Næthig and Sæmmerring, infer that after long-continued blindness the atrophy of the optic nerve in man sometimes affects the optic thalamus.

The following is a summary of facts favourable to the supposition that the optic nerves in man derive roots from the optic thalami.

1. The human tractus opticus admits of being distinctly traced to the optic thalamus, both in the fœtal condition and subsequently to birth.

2. In many, if not all, of the mammalia, the optic nerves in the clearest manner derive roots from the optic thalami.

3. The optic nerve of the chick first appears as an offset from the third ventricle, and the optic thalami are developed in the walls of that ventricle.

4. The inverse proportion known to subsist between the tubercula quadrigemina and the optic thalami in mammalia, and also between the optic lobes and the optic thalami in birds, reptiles, and fish, may probably be considered corroborative facts.

Corpora geniculata: their relation to the optic nerves.

That there is an intimate physiological relation between the optic nerves and the corpora geniculata can scarcely admit of doubt, for the principal band of the human tractus opticus is, in every instance, traceable to the corpus geniculatum externum, and may be seen actually incorporated with that tubercle; and a similar connection between the lesser band of the tractus and the corpus geniculatum internum is also, for the most part, discoverable: moreover, in various orders of the mammalia a portion of the tractus opticus emanates most distinctly from the corpus geniculatum internum; and in quadrumana, carnivora, rodentia, &c., this has been frequently verified by the writer.

From the statements of Tiedemann, it appears that the corpus geniculatum externum is much more tardy of development in the fœtus than the optic nerve itself, for the eminence in question becomes only for the first time apparent about the sixth month of fœtal life: again Serres affirms that both corpora geniculata appear so late as the sixth month of uterine existence; and according to the joint testimony of these two authorities, the corpora geniculata are developed in the course of the tractus opticus, and superadded to the rudimental optic nerve.

The late appearance of the corpora geniculata in the embryo, and the manner of their develop-

ment, would seem to assimilate these tubercles to the ganglions found in the course of certain nerves of special sense in many animals, and which are perhaps destined to exalt the sensibility of the nerves in which they occur. The optic ganglions of the loligo (*fig. 424, c*), and the olfactory ganglions of many fishes, afford good examples of the nervous masses to which allusion is here made.

Tuber cinereum: its relation to the optic nerves.

The same difficulties uniformly encountered in all attempts to determine the particular functions of individual parts of the brain prevail in the case of the tuber cinereum: some physiologists maintained that the optic nerves derive a great number of filaments from that body, and that the nerves are considerably increased in dimensions by this addition: Gall, for instance, was of this opinion, and gave a rather exaggerated representation of the enlargement supposed to arise out of this reinforcement to the nerves.

The optic nerves in man may doubtless draw some of their roots from the tuber cinereum, but there is an absolute certainty that the body in question has other and probably more important functions than any connected with the origin of the nerves of vision. Pathological and experimental observations upon the subject are still a desideratum, but in the absence of more direct evidence the anatomy of the mole's brain is calculated to throw some light upon the enquiry. In the mole the optic nerve is either wholly absent, or if present, it is merely rudimental; nevertheless, the tuber cinereum is of enormous dimensions; it extends forwards to the olfactory lobes, and so far backwards as nearly to reach the pons. In this animal, therefore, there is an *inverse* proportion apparent between the optic nerve and tuber cinereum, a fact little favourable to the hypothesis advocated by Gall.

Of the chiasma of the optic nerves.—The word chiasma (from the Greek *χιασμος*, *decussatio*,) means in strictness a decussation, or crossing at acute angles, like the legs of the letter X;* and, for convenience-sake, the same expression (with a like latitude of application) will be here employed to designate the corresponding structure in the lower animals.

The organization of the human chiasma has abundantly exercised the ingenuity of anatomists, who seem to have encountered great difficulty in their attempts to trace the nervous filaments through it; and consequently, notwithstanding all the attention bestowed upon the subject, opinions the most conflicting have prevailed upon the true nature of the structure in question. In no other instance is a similar junction between two corresponding nerves of opposite sides known to occur. Such an anomaly affords strong presumptive evidence of the existence of some unusual properties in the

* In Human Anatomy the term is used (without perhaps sufficient regard to its etymology) to express the nervous mass in which the two optic nerves are conjoined.

nerves thus united; and for these reasons the physiology of the chiasma is invested with uncommon interest.

The existence of a chiasma is not *general* throughout the animal series, and even when present it exhibits much diversity of appearance and structure in different classes. A brief exposition of some of its more striking varieties, in animals, will probably constitute the best introduction to the study of the chiasma in man.

Invertebrata.—In the invertebrate classes nothing like a chiasma has been demonstrated, nor has any mutual crossing of the special optic nerves been proved to exist. The nerves which are furnished to the compound eyes of insects and crustaceans pass in a *direct* course to their destination; the same remark applies to the nerves from which the lens-eyes of insects, arachnida, crustacea, and mollusca, derive their sensibility; and it may be presumed that the nerves which supply the simple eye-dots of annelida and other inferior animals are similarly circumstanced.

Osseous fish.—In osseous fish the optic nerves generally cross each other at an acute angle, in such manner that the nerve which comes from the *right* side of the brain goes distinctly to the *left eye*, and vice versa: at the point of decussation the nerves lie one over the other; they are usually flattened at this spot, and closely joined together, but this junction is effected by means of cellular or fibrous adhesions only, as no intermingling of the nervous filaments takes place, and the nerves themselves can be isolated without injury to their proper structure (fig. 407).

Cartilaginous fish.—In cartilaginous fish a well-marked chiasma occurs. In this class the junction of the two optic nerves is no longer effected by means of mere cellular adhesions, as in the osseous fish, but a perfect union of the proper substance of the nerves constitutes a true chiasma. The optic nerves arise each from the corresponding optic lobe chiefly; they quickly converge, and soon become confounded with each other in the chiasma; and so intimate is their connection, that anatomists possess little information as to the exact arrangement of the nervous filaments in this structure (fig. 410).

Birds.—In birds the chiasma is large, being proportional to the size of the optic nerves; by a little management its organization can be accurately demonstrated. Maceration for a few days in spirits hardens this structure sufficiently to enable the operator to strip off the neurilemma, and then, even without the aid of a lens, the chiasma may be seen to consist chiefly of laminae. Forcible extension of the optic nerves, in such a manner as to tear through the superficial stratum of the chiasma on its lateral aspect, greatly facilitates the examination.

The laminae originate in the tractus opticus, and appear to spring from the inner part alone of that mass; they gain the chiasma, and here those derived from opposite sides of the brain form a reciprocal interlacement. A perfect and regular decussation of the inner filaments of the two tractus optici thus takes place in the

chiasma, in such manner that a large proportion of the tractus of one side is evidently traceable to the opposite optic nerve, and vice versa: but the outer part of each tractus opticus continues on to form the outer part of the optic nerve of its *own* side, and has no concern in the formation of the decussating laminae.

The number of laminae in the chiasma of different birds is subject to some variety, but in the entire class, without exception, the laminated structure prevails (fig. 417).

Fig. 417.

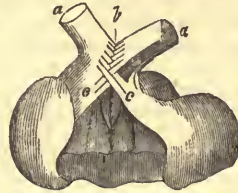

Chiasma of the common fowl. (After Müller.)

a, a, optic nerves; b, chiasma, dissected so as to show its decussating laminae; c, c, tractus optici.

Amphibia and reptiles.—In amphibia and reptiles a laminated chiasma, somewhat similar to that just described in birds, occurs; but the decussating laminae are very variable in number, and in general much fewer than in birds.

Thus, in *Amphisbœna*, according to Müller, there are only five laminae in all, two from one side, and three from the other; and in *lacerta ocellata*, according to the same authority, as many as eight have been counted, four on either side (fig. 418). In some reptiles the posterior part of the chiasma is strictly commissural, the inner part of each tractus opticus being appropriated to the formation of a band-like commissure: in *Amphisbœna* a triangular space separates this band from the remainder of the chiasma (fig. 418).

Fig. 418.

A. B.

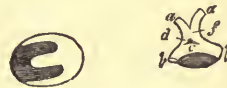
Chiasma in *Amphisbœna*. (After Müller.)

A, section of chiasma to exhibit the decussating laminae, of which there are three from one side and two from the other.

B, chiasma seen from below.

a, a, optic nerves; b, b, tractus optici; c, commissural band; d, triangular space; f, true chiasma.

Mammalia and man.—In mammalia and man the chiasma is no longer laminated, and great difficulty occurs in attempts to display its real structure.

The older anatomists were evidently unable to trace the filaments of the human optic nerves satisfactorily through the chiasma, and in consequence they relied either on pathological facts, or the results of experiments, or the data furnished by comparative anatomy, to determine the mutual relations of the second pair in this

part of their course. The conclusions arrived at by such modes of investigation were unsatisfactory, and remarkable for much discrepancy.

1. Some maintained that the nerves are merely placed in exceedingly close juxtaposition in the chiasma, without any intercrossing of their respective filaments, and that each tractus opticus in reality passes on to form the optic nerve of *its own side*.

These views were supported by Vesalius,* who detailed the particulars of a case in which after death the two optic nerves were found perfectly distinct from each other throughout their whole course, and consequently no chiasma existed, although, during life, vision had been unimpaired; and the same hypothesis was strengthened by Santorini and others, who, in certain instances where one eye had been destroyed many years before death, observed on the post mortem examination the *corresponding* optic nerve atrophied as far back as the chiasma, and the tractus opticus of the *same side* wasted, while the nerve and tractus of the opposite side were perfectly healthy.

2. Others were persuaded that a perfect decussation exists in the chiasma, and that all the filaments of the tractus opticus of *one side* pass fairly across to form the optic nerve of the *other*, and vice versâ. In favour of this opinion it was urged that in the majority of cases of long-continued blindness of a single eye the *opposite* tractus opticus, and not the tractus on the *same side* with the affected eye, becomes atrophied. Sæmmering observed several such cases in the human subject, and traced the same appearances in the horse, dog, squirrel, rabbit, hog, cat, and chamois: and Cuvier preserved in spirits the brain of a horse in which the wasting of *one* optic nerve continued backwards into the *opposite* tractus. The evident manner in which the optic nerves in osseous fish cross each other (see fig. 407) was also considered favourable to this view, and the results of experiments on living animals were confidently appealed to in farther confirmation of the same. Thus the experiments of Rolando, Pourfour Petit, Saucerotte, Hertwig, Flourens, and others led to the conclusion, that if in the Mammalia one hemisphere of the cerebrum be injured deeply or removed, vision becomes impaired or destroyed in the *opposite* eye; if the *two* cerebral hemispheres be successively subjected to the same treatment, vision becomes successively impaired or destroyed in *both eyes*; if *one* of the nates be removed, the animal sees no longer on the *opposite* side; and if *both* be removed, blindness affects *both eyes* in succession and occurs constantly in the eye *opposite* to the injured tubercle; if in birds *one* of the cerebral hemispheres be removed, vision becomes extinguished in the *opposite* eye; if the *two* hemispheres be removed in succession, a cross paralysis affects the *two* retinae: if *one* of the optic tubercles be removed, the sight of the *opposite* eye fails, and if *both* be removed, perfect blindness ensues.

3. Another class of physiologists believed

that a partial decussation occurs in the human chiasma, and that some of the filaments of each tractus opticus continue on into the nerve of their own side, while others cross obliquely into the optic nerve of the opposite side. Certain facts in pathology seemed difficult of explanation on any other supposition; thus cases of long-continued blindness of a *single eye*, the result of accident, have been met with, in which after death the *corresponding* optic nerve was found atrophied as far back as the chiasma (the optic nerve belonging to the healthy eye being of fully its ordinary dimensions, or even larger than natural) while *both tractus optici* were wasted.

That a partial decussation *does* occur in the human chiasma can now no longer admit of doubt, for of late years the existence of this organization has been proved by actual dissection, and it can be rendered apparent to the naked eye by the precaution of hardening the nervous substance before the dissection is commenced. According to the writer's experience immersion in spirit hardens the preparation in the most satisfactory manner. In performing the dissection the neurilemma must be first carefully removed from the chiasma, and also from the adjoining portions of the optic nerves and tractus optici; after this preliminary, each optic nerve should be divided transversely a little in front of the chiasma; a transverse incision carried horizontally into the cut surface of the cerebral extremity of each nerve will then enable the operator to split it in a direction backwards towards the chiasma, and by proceeding cautiously a horizontal division of the chiasma, and of a part of the optic nerves and the tractus optici, will be effected. (Fig. 419)

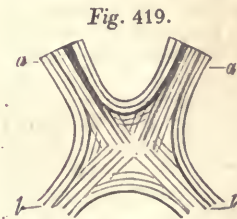

Human Chiasma. (From a dissection made by the writer.)

a a, optic nerves; b b, tractus optici.

admits of not the slightest question; the outer fasciculi of each tractus opticus continue onwards without interruption to form the outer part of the optic nerve of the *same side*: the middle fasciculi cross the chiasma obliquely and after decussating the corresponding fasciculi of the other tractus, contribute to the formation of the optic nerve of the *opposite* side; and the internal fasciculi cross the posterior part of the chiasma transversely and uniting directly with the corresponding fasciculi of the other tractus seem to be strictly commissural; across the front of the chiasma some fasciculi take an arched course, and being prolonged forwards are likewise apparently commissural.

* Vesalius de Corp. Hum. Fab., l. iv. c. iv.

Some difficulty no doubt arises when the physiologist attempts to reconcile with this anatomical arrangement certain facts already detailed: it may be remarked, however, that arguments derived from the pathology of the optic nerve can be but of little value, since they have been relied on in turn by the framers of each hypothesis as affording proof of their own peculiar views; and in the Museum of the Richmond Surgical Hospital, Dublin, the writer has seen specimens of atrophied optic nerves in man which furnish the most contradictory evidence upon the subject under discussion. The preparations alluded to were cases in which *one* eye had been destroyed either by local disease or accident, many years previous to death, and where in consequence the *corresponding* optic nerve became wasted from disuse, while the *other* optic nerve continued healthy. In the majority of these specimens the wasting has been propagated backwards to the *opposite* tractus opticus and has implicated that structure, while the *corresponding* tractus has been spared (see fig. 420, A); in some examples *both* tractus optici have suffered a diminution of size and in general to an unequal amount; and in one

very remarkable instance the tractus opticus of the *same* side with the shrunken nerve has dwindled into a narrow band, while the *other* retains fully its normal dimensions (fig. 420, B).

It may be fair to add, that the case quoted from Vesalius is considered by many, and amongst others by Gall and Spurzheim, as of doubtful authenticity, and the results of experiments on living animals should be received with caution, for to argue from experiments on birds to the human subject is plainly fallacious, since the structure of the chiasma is not identical in the two cases, and the great obstacles encountered in the performance of such experiments on the *mammalia* renders them of trifling value.

Use of the chiasma.—In the direct junction between two corresponding nerves of opposite sides displayed in the chiasma, the second pair form an exception to a general law; for in no other known instance does a similar union occur; it therefore becomes a subject of great interest to determine how far this anomaly admits of explanation by any unusual properties in the nerves so circumstanced.

The optic nerves possess the remarkable power of conveying to the individual the sensation of a *single* impression *only*, while a separate impression affects each nerve simultaneously, so that although a perfect picture of the object be depicted on each retina severally, nevertheless to the spectator it appears to be single (as is really the case); or to speak still more intelligibly, a spectator sees an object *single*, although he looks at it with *two* eyes.

This property would seem to belong in an especial manner to the optic nerves, and inasmuch as the second pair differ from all the others in possessing a chiasma, there is so far a presumption, that the unity of sensation manifested by the optic nerves depends on the chiasma.

The idea that single vision may be explained by a partial decussation in the chiasma originated (upon theoretical grounds) with Newton; it has since been adopted by Wollaston, Solly, and others, and many facts have been from time to time brought forward in its favour. The hypothesis may be thus enunciated. "Each tractus opticus sends some filaments across the chiasma to form the inner part of the *opposite* optic nerve, while its outer filaments continue on to form the outer part of the optic nerve of its own side; the same arrangement of the filaments prevails to the retina, so that the right side of each retina comes from the right tractus opticus, and the left side of each retina from the left tractus opticus; if then in vision the pictures of an object be depicted simultaneously either on the right sides of the two retinae, or on the left sides of the two retinae, the impressions in either case will be communicated to one and the same tractus opticus; such impressions will of course be referred to one and the same side of the brain, and they will *therefore* produce the sensation of a single impression *only*, although in reality two several impressions affect the retinae; the unity of sensation depending on the fact that the two

Fig. 420.

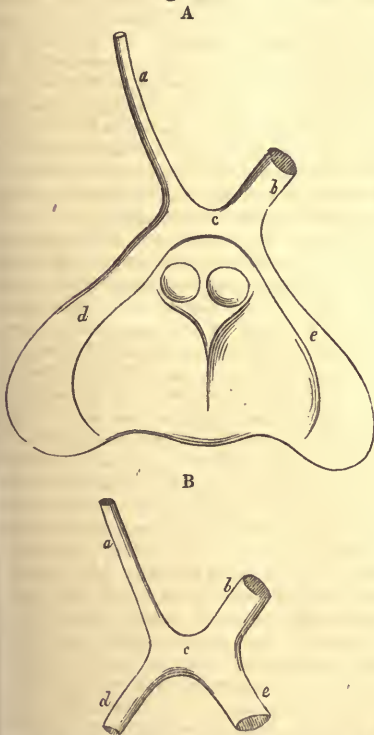

Atrophy of one optic nerve, the consequence of long-continued disuse. (From preparations in the Museum of the Richmond Hospital, Dublin.)

A. *a*, right optic nerve in a state of atrophy; *b*, left optic nerve healthy; *c*, chiasma; *d*, right tractus opticus healthy; *e*, left tractus opticus wasted.

B. *a*, right optic nerve atrophied; *b*, left optic nerve healthy; *c*, chiasma; *d*, right tractus opticus wasted; *e*, left tractus opticus healthy.

impressions are referred to *the same side* of the brain, and not to opposite sides of the brain as occurs in other cases."

Wollaston adopted this hypothesis in consequence of the ready explanation it affords of certain cases of *visus dimidiatus*: he on several occasions in his own person experienced a temporary defect of vision, in consequence of which one and the same lateral half of every object became invisible, whilst he still continued to see the other half distinctly; and the same amount of blindness subsisted whether he employed one or both eyes in looking at the object.

Examples of the same form of amaurosis are of no very unfrequent occurrence, and according to the theoretical notions just propounded this partial loss of vision originates in some functional affection of *one* tractus opticus whilst the other remains healthy; those parts of the two retinae which derive their origin from the *faulty* tractus being supposed to labour under a temporary amaurosis, while all other parts retain their ordinary sensibility.

In further support of this hypothesis, Muller's researches have convinced him that in man single vision by the two eyes occurs only when *certain* parts of the two retinae are affected simultaneously, and that under other circumstances double vision ensues. This conclusion has been arrived at, chiefly from the results of experiments upon the eye-ball. Thus, when the eye-lids are closed in a dark room, if pressure be applied deeply to the eye so as to affect the retina, luminous spectra are produced. When *certain parts* of the two eye-balls are subjected to pressure at the same time, a single spectrum occurs, and when *other parts* of the two eye-balls are pressed upon simultaneously two spectra appear. Those parts of the two retinae which in the above experiment furnish a single spectrum are styled "identical," in consequence of their identity of sensation; and those parts which produce two spectra are denominated "non-identical," for obvious reasons. Some of the conditions under which single and double vision respectively take place, seem to be confirmatory of this doctrine of "identical" and "non-identical" parts in the two retinae; thus double vision is a common consequence of any cause having a tendency to disturb the relative directions of the optic axes: for example, diplopia frequently occurs in cases of strabismus, and double vision may (according to Muller) be produced in perfectly healthy eyes by a simple experiment: if a spectator fix his eyes upon an object and then press on one of them in such manner as to alter the direction of its axis, the object which at first seemed single will assume a double appearance. These phenomena admit of explanation on the supposition that in consequence of the distortion of the axes of the eyes, the visual impressions take effect on "non-identical" parts of the two retinae, which therefore propagate *two* impressions instead of one to the sensorium.

These views apparently strengthen Newton's hypothesis, for it may be presumed that the "identical" parts of the two retinae are those

which derive their origin from *the same* tractus opticus, and the "non-identical" on the contrary those which come from different tractus optici.

The comparative anatomy of the nerves in question furnishes some facts favourable to Newton's hypothesis; thus many animals in which the eyes are directed *laterally*, in such manner that each embraces a totally different field of vision, have no chiasma, and their optic nerves cross each other, so that the right retina is in connection solely with the left side of the brain, and vice versa. This arrangement prevails in the majority of osseous fish, and, for so far, affords *negative* proof of the hypothesis under consideration. The following theoretical explanation may be offered. "In these animals, owing to the position of their eyes, the same object can never be depicted on the two retinae simultaneously; consequently, in them no provision to ensure single vision of the same object by both eyes is required, and therefore no parts of the two retinae have a common connection with one and the same side of the brain, the two optic nerves being derived respectively from *opposite* sides of the organ."

Again, Mr. Solly has shown that in many fish, such as the skate, (in which the eyes are so set that the respective fields of vision may comprise in a great measure the same objects,) a chiasma exists: and the anatomy of the chiasma in birds is likewise on the whole favourable to the hypothesis; for in these animals the optic axes are in general very divergent, and consequently the respective fields of vision can have but little identity; a fact which agrees theoretically with the almost perfect decussation observable in their laminated chiasma.

Although this explanation of single vision has been sanctioned by the authority of Newton and Wollaston, and supported by strong anatomical facts and analogies, it will scarcely stand the test of critical examination; its validity has therefore been much questioned and apparently with justice, for the following reasons:

1. "Identity of sensation" is not *exclusively* a special attribute of the second pair; although it exists in them in great perfection, *other* nerves must also be admitted to possess the same property; thus notwithstanding that both ears are commonly employed simultaneously for the ordinary purposes of hearing, the sensation of a *single impression* of sound is in general propagated to the sensorium; and although both nares are used in the appreciation of odours, the sensation of *single impressions* of scents is most usually produced: now since neither the olfactory nor the auditory nerves are provided with a chiasma, and nevertheless these nerves undeniably evince a unity of sensation, there is good reason for scepticism when the very same property in the optic nerves is attributed to the presence of a chiasma.

2. Many facts in pathology are obviously at variance with Newton's theory; if it were the true explanation of single vision, morbid affections of one side of the brain (whenever productive of amaurosis) ought to implicate more or less of one half of *each* retina, whereas exper-

rience proves that in the majority of such cases one or other retina is *wholly* paralysed, and not unfrequently vision continues *perfect* in one eye although extinguished in the other. Moreover, although the theory in question affords an *ingenious* explanation of the defect in vision noticed by Wollaston, such explanation can scarcely be the true one, for Mayo has known "this visus dimidiatus to alternate in the same individual with temporary insensibility of the centre and circumference of the retina," and, as he observes, "the three phenomena being alternative no doubt proceed from the same organic source, but as the hypothesis will not explain *two* of them, it is probably not the right explanation of the third."

3. The structure of the human chiasma does not afford satisfactory explanation of the so called "identical" and "non-identical" parts of the two retinae as laid down by Müller, and this has been so clearly shown by himself that his own words are quoted :—

"With reference to their identity of sensation, the two retinae must be considered as included one within the other, so that all points of the two retinae which lie within the same degrees of latitude and longitude (the eyes being regarded as globes) are identical in their sensations; all other points in the two retinae are opposed to each other or different, just as any two points in the retina of the same eye.

"If the image fall on identical points in both eyes it will be seen single, and if the image does not fall on such identical points it will appear double.

"The two globes of the eyes are most minutely divided into degrees, minutes, and seconds of latitude and longitude; at all corresponding points they are identical, at all different points *non-identical*. The *outer* lateral portion of one eye is identical with the *inner* portion of the other eye; the upper part of one retina is identical with the upper part of the other, and the lower parts of the two eyes are identical with each other.

"The left half of the retina A, from 1 to 5, however, (*fig. 421.*) is not, as a whole, identical with the left half of the retina B, from 1 to 5, but certain points only of the left halves of both retinae are identical, viz. those which in the two

Fig. 421.

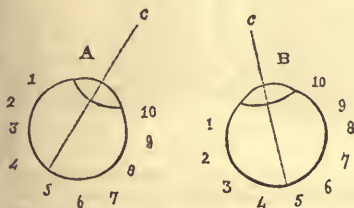

Diagram to represent the supposed identical parts of the two retinae. (After Muller.)

1, 2, 3, &c., the identical parts of the two retinae; c, c, the optic axes.

retinae occupy the same degrees of latitude and longitude: 1 is identical with 1, 2 with 2, and so on; but 1 in the one eye is not identical with 5 in the other eye.

"To explain the single vision, therefore, it is necessary that not merely each root of the optic nerve, but each primitive fibre of each root should in the chiasma divide into two branches for the two optic nerves, so that the identical fibres of the two nerves might communicate with the brain at one point only, viz. by one radical fibre, as in the annexed wood-cut (*fig. 422.*) But such a division of the fibres in the chiasma does not exist: Treviranus and Volkmann were unable to detect any division of fibres in the chiasma, and I also was unsuccessful in my search for such dividing fibres. (*Fig. 422.*)

Fig. 422.

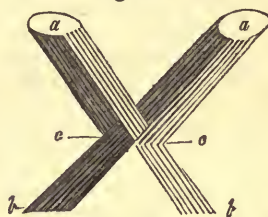

Diagram to represent an ideal division of the fibres in the chiasma suitable to this theory. (After Müller.) a, a, optic nerves; b, b, tractus optici; c, c, supposed division of each radical fibre in the chiasma into two branches, one for each optic nerve.

4. If single vision in *man* be explained on the assumption that certain parts of the two retinae are reciprocally identical, and that such identity depends upon a partial decussation in the chiasma, single vision in *animals* should of course admit of explanation upon the same principles; and if this be granted, the relative directions of the optic axes in the vertebrate classes ought to afford a good criterion of the extent to which the retinae are reciprocally identical; for when the optic axes have a strictly lateral direction (as in many osseous fish), the same object can never be depicted on both retinae simultaneously, and consequently it may be inferred that, in such cases, no parts of the two retinae are reciprocally identical. Again, when the optic axes are very divergent, as in many quadrupeds, the respective fields of vision must comprise in great measure *different objects*, and under such circumstances it may be presumed that the two retinae have but little identity. And when the eyes are so set that the optic axes are parallel, or capable of becoming parallel, or convergent (as in *man*), the same objects, or nearly the same, will almost constantly occupy the two fields of vision; and in such case the greatest amount of reciprocal identity may be assumed to occur in the two retinae.

Now, if the relative directions of the optic axes in animals bear relation to the amount of reciprocal identity in their retinae, and if this reciprocal identity depend upon the decussation in the chiasma, as has been assumed, the structure of the chiasma in animals generally should vary as the relative directions of their optic axes.

Such variation in the structure of the chiasma has not, however, been proved to occur gene-

rally throughout the animal series; on the contrary, the chiasma usually conforms to the type prevalent in the class to which the animal belongs, without evincing in its conformation much regard to the relative directions of the optic axes; and examples are not unfrequent in which the anatomy of the optic nerves is at variance with what the relative directions of the optic axes would require theoretically.

Thus in the pleuronectes fish, (fig. 409,) the optic axes are so directed that the two retinæ may be inferred to have a certain amount of identity, and nevertheless, in such of them as have been examined by the writer, the optic nerves are severally derived from *opposite* sides of the brain, and cross each other without forming a chiasma; or in other words, retinæ evincing mutual identity are supplied by optic nerves which have *no* identity of origin; the type prevalent in osseous fish being preserved, without respect to the directions of the optic axes. In many of the cetacea, the direction of the optic axes is such that the retinæ can have no identity, and nevertheless a perfect chiasma, such as occurs in other mammalia, exists in these animals. And in the owl the eyes look more directly forwards than those of most other birds, from which it may be presumed that the amount of mutual identity in the two retinæ is much greater in them than in those birds whose eyes have a lateral aspect; but nevertheless the structure of the chiasma in the owl appears in nothing different from that which prevails in birds whose optic axes have a strictly lateral direction.

But further, when the optic axes are very divergent, as in some quadrupeds, any object which can be depicted upon both retinæ simultaneously, will throw its images on the *outer* parts of the two retinæ, and in order to explain

Fig. 423.

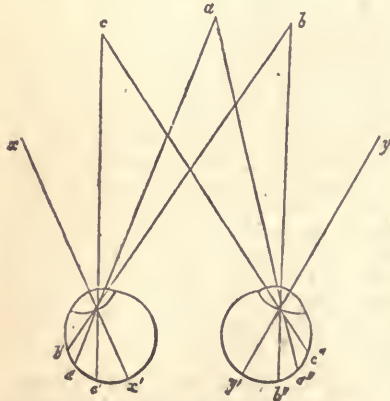

Diagram to show how in eyes with divergent axes, the images of every object placed so as to be seen by both eyes simultaneously fall on the outer parts of the two retinæ. (After Müller.)

$x, x', y, y,$ axes of the eyes diverging; $a, b, c,$ objects seen by both eyes; $a', a'',$ parts of the two retinæ on which the object a is depicted; $b', b'',$ parts of the two retinæ on which the object b is depicted; $c', c'',$ parts of the two retinæ on which the object c is depicted.

single vision under such circumstances, the outer parts of the two retinæ should therefore be reciprocally identical; but these parts are formed by the outer filaments of the optic nerves, which come respectively from the *corresponding* sides of the brain, so that here, reciprocally identical parts of the two retinæ, instead of having a common origin at one and the same side of the brain (as they ought in order to suit theoretical views), are derived severally from *opposite* sides of the organ, and consequently have no identity of origin (fig. 423). These considerations are sufficient to falsify the explanation of single vision put forward above, and the writer is of opinion that hitherto the exact use of the chiasma has not been discovered. (See VISION.)

Some remarkable varieties of optic nerves.

Optic nerves in certain cephalopods.—The loligo or calamary exhibits in its optic nerves a singularly beautiful arrangement, which the physiologist cannot but contemplate with the greatest interest, as it presents the most perfect decussation of nervous filaments hitherto discovered. The loligo, in common with some of the allied families of the cephalopoda, possesses an extremely perfect organ of vision; so elaborate is the mechanism of the eye that it has attracted a considerable share of attention from comparative anatomists; and the development of the optic nerve bears proportion to the perfection of the other parts of the visual apparatus.

The nervous system of the loligo conforms to the cycloganglionic type, and from each lateral surface of the supra-oesophageal ganglion, (fig. 424,) one of the optic nerves comes off. After pursuing a short course outwards the nerve swells into a large ganglion (the optic); this body is oval in shape, and of enormous dimensions; it exceeds considerably the volume of the supra-oesophageal ganglion. One surface of the optic ganglion is directed towards the eye, and emits an immense number of filaments, which spring chiefly from its edges, and which,

Fig. 424.

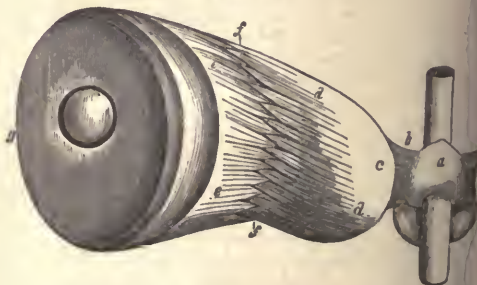

Organ of vision, together with the optic nerve and supra-oesophageal ganglion in the loligo, much magnified. (From a dissection by the writer.)

$a,$ supra-oesophageal ganglion; $b,$ optic nerve; $c,$ optic ganglion; $d, d',$ one series of filaments springing from the edge of the ganglion; $e, e',$ second series of filaments derived from the opposite edge of the ganglion, and in this view visible near their termination only; $f, f,$ points at which the filaments of the two series decussate; $g,$ ball of the eye.

after making their way to the eye-ball, and perforating the sclerotic, terminate in the retina. These filaments are arranged at their origin in a double linear series, each series streaming forth from one of the opposite margins of the ganglion. After becoming free of the ganglion the filaments of each series approach those of the other series, and a most perfect and regular interlacement of the two sets ensues; so completely do they decussate that either half of the retina is formed by filaments which spring from the *opposite* edge of the ganglion; those filaments which shoot out from the *anterior* margin of that body terminating in, and actually forming, the *posterior* moiety of the retina, and vice versa.

The reciprocal interlacement of these nervous filaments reminds one of the manner in which the two series of threads in a weaver's loom (technically called the woof and the warp), cross each other; this illustration is exact, for the interlacement of the threads in the one case is not more perfect or regular than that of the nervous filaments in the other.

The writer is indebted to his colleague, Dr. Power, for a knowledge of this curious arrangement, which was discovered by that gentleman while inspecting a preparation of the nervous system in the loligo made by the writer, and which still exists in the Museum of the Richmond Hospital School, Dublin.

Subsequent dissections have proved satisfactorily that the decussation in question occurs invariably in the loligo, and that in the octopus, which exhibits close affinity to the loligo, the same arrangement prevails. In the *sepia officinalis* the optic ganglion is reniform, and its filaments come off in a double series, as in the loligo; the majority of the filaments decussate after the same manner as that above described in the other two species, but some of the extreme filaments of each series pass in a direct course to the retina, without exhibiting any decussation.

The peculiar disposition of the optic filaments in these cephalopods was unnoticed until the publication of Dr. Power's paper on the subject in the "Dublin Journal of Medical Science,"—an omission the more surprising, as accurate descriptions of the eye in this class of animals have appeared from some of the ablest anatomists.

Swammerdam long ago described and delineated the optic ganglion of the *sepia officinalis*, but without making any mention of the intercrossing of the filaments which emanate from that body. Cuvier, in his memoir on the Mollusca, describes the eye of the poulpe (octopus) with great accuracy, but makes no allusion to the decussation in question; and in the most recent descriptions of the cephalopods the same omission occurs.

The above discovery seemed at first likely to afford an explanation of the problem so difficult of solution, namely, the well-known fact, that objects appear *erect* to a spectator although their images on the retina are inverted; and for some highly ingenious observations tending to elucidate this obscure question, the

reader is referred to the paper by Dr. Power, already quoted; it may be stated, however, that many difficulties remain to be removed before such an explanation can be received, for

1. The filaments of the optic nerve of the loligo have not as yet been traced back to the central masses of the nervous system, and there can therefore be no certainty that they preserve in the first part of their course the same relative positions which they are known to maintain in the interval between the optic ganglion and point of decussation.

2. In vision the object is known to be *wholly* reversed in the image on the retina; for example, that which is *above* in the object is *below* in the image, and vice versa; and that which is to the *right* in the object is to the *left* in the image, and vice versa; now, although the decussation in question might possibly explain the correct appreciation of an object whose image is reversed in *one* particular direction (say from above downwards), it never can fully explain the correct impression made by an object of which the image is reversed in *all* directions simultaneously.

3. In order that this explanation may apply to human vision, the same interlacement of filaments must first be demonstrated in the optic nerve of man, a task which has not as yet been accomplished.

Optic nerves of the compound eyes of Insects.

These nerves are excessively large and appear proportional to the size of the organs of vision in the Insect.

Each nerve on arriving at the eye swells out into a bulb, which is convex and varies considerably in dimensions in different species; this bulb in general represents a segment of a sphere, and from its surface nervous filaments in immense numbers arise and diverge like the radii of a circle. Several thousand of these filaments have been counted in a single nerve; each of them is connected by its distal extremity to the apex of a small conical transparent body interposed between the filament and the corresponding facet of the cornea, but the most striking peculiarity of the nerve is found in the perfect isolation of each of these filaments by the interposition of pigment.

The pigment is variable in colour, being sometimes light, at others dark; it may be nearly black, dark violet, dark blue, purple, brown, brownish yellow, light yellow, or green, and sometimes several layers of different colours lie one over the other; the pigment extends from the bulb of the nerve to the cornea; it surrounds each filament and separates it completely from adjacent filaments.

The effect of this disposition is to isolate the rays of light incident on each filament, and to prevent the transmission of all rays except such as fall in the direction of the axis of the filaments; since all oblique rays must of necessity impinge upon the colouring matter and be in consequence absorbed.

The reader is referred to the article *INSECTA* for further details concerning the optic nerve in these animals.

Plaited optic nerve.

The optic nerve in some animals exhibits a peculiar plaited appearance; this condition occurs in greatest perfection in certain fishes, and in many birds a somewhat similar organization may be detected, though not at all so perfectly as in the fish tribes.

When the plaiting prevails in perfection, the nerve consists essentially of a thin membrane folded on itself exactly like a closed fan or a plaited frill; but the arrangement referred to is not at first sight apparent, particularly if the nerve be inspected in that part of its course only which is external to the cranial cavity, for there the neurilema is so thick, dense, and tough, that a correct estimate of the disposition of the nervous structure cannot be formed until this investment has been removed.

Deprived of its neurilema, the nerve seems to consist of a number of parallel laminae placed in juxtaposition; on closer examination these laminae turn out to be continuous with each other at their edges, and by a little care the nerve can be unfolded into a membrane of which the breadth is proportional to the number and depth of the original laminae.

When the plaited condition is perfect, it prevails along the entire length of the optic nerve, becoming manifest at its cerebral attachment, and continuing to the eye-ball; even the retina seems to participate in the same disposition, as folds or plaits are observable on the surface of that nervous expansion; and in certain fish the optic lobes themselves present a similar organization, for the walls of the cavities which these tubercles contain are in some instances covered with laminae.

The plaiting must be considered an essential attribute of the nervous substance and totally independent of the neurilematous investment, for this disposition of the nervous material occurs occasionally in the optic lobes and retina, structures which are devoid of neurilema. (Fig. 425.)



Fig. 425.

Plaited optic nerve of a Mullet. (From nature.)

a, optic nerve deprived of neurilema, exhibiting the plaited disposition; *b*, sclerotic coat of the eye through which the nerve is passing; *c*, retina, in which the nerve terminates.

Laminated optic nerve.

In certain birds the optic nerve is laminated and bears a close resemblance to the plaited condition just described.

In these birds a careful examination of the nerve is required for the discovery of its true texture, for the neurilema (endowed with uncommon strength) adheres so firmly to the nervous structure that without a careful dissection its laminae elude observation.

When viewed on one side the nerve seems perfectly smooth, but on the opposite side numerous laminae may be distinctly observed; these are parallel to each other, and run along

the nerve in the longitudinal direction: they are of considerable depth and variable thickness; they are applied closely to each other, being separated by thin processes of neurilema only, and altogether (their straight course excepted) this arrangement bears a striking similarity to the disposition of the laminae on the human cerebellum. A short section of the nerve divested of its neurilema is not unlike a closed book, the laminae representing the leaves, and the opposite smooth surface of the nerve bearing a resemblance to the back and cover of the book. The laminated optic nerve of the bird does not admit of being unfolded into a flat membrane, a proceeding which can be accomplished with care in the plaited optic nerve of the fish: and in birds the laminated structure occurs in that part of the nerve only which is in front of the chiasma; in its cerebral extremity no such organization prevails. (Fig. 426.)



Fig. 426.

Laminated optic nerve of an Eagle. (From nature.)

a, chiasma; *b*, optic nerve divested of neurilema and exhibiting laminae on one surface; *c*, sclerotic coat.

Desmoulins, who has paid the greatest attention to these varieties, inferred as the result of his extensive researches, that the plaited arrangement of the optic nerve in fish, and its laminated condition in birds bears proportion to the perfection of vision in the animals under consideration; for those birds which are endowed with the most powerful piercing sight possess the laminated structure at a maximum of development. For example, birds of prey, such as the eagle, the falcon, and the kite, evince an acuteness of this faculty truly surprising; from heights in the atmosphere, at which they are themselves almost invisible, they discover their prey on the ground and pounce on it with the most unerring certainty, whilst at the trifling distance of a few yards other animals recognise such objects with difficulty: now birds of this class afford the most perfect specimens of the laminated optic nerve. It is further stated on the same authority that birds which at short distances possess remarkably quick and accurate powers of vision (more especially when in such cases this faculty is exercised in media of different degrees of density) are also provided with laminated optic nerves, and that most fish in which the plaited optic nerves occur are of precacious habits, and consequently require powerful organs of vision just as the birds of like propensities.

The writer has examined the optic nerves in the stork, kingfisher, eagle, &c., and in them, as well as in all the fishes which have fallen within his reach, his dissections have amply verified the anatomical descriptions given by Desmoulins.

It is difficult to explain the superior sensibility supposed to be thus conferred on the

optic nerve; but the more obvious effect of this organization is to increase the surface of the nervous material. A similar contrivance is at times resorted to in the nervous centres, as is exemplified in the cerebral hemispheres; these masses in the higher and more intelligent animals being covered with large convolutions and deep sulci, while in the lower classes they are smooth and consequently possess a superficies of limited extent.

Optic nerve in that form of monstrosity known by the varied appellations of "Cyclops," "Fœtus à trompe," "Monops," "Rinencephale," &c. &c.

The abnormal anatomy of the optic nerve is not in strictness comprised within the scope of the present article, but nevertheless a brief description of the above malformation will probably not be considered out of place.

A single eye placed in the middle line of the forehead, and in general a trunk or proboscis growing immediately above this solitary organ of vision, constitute the most striking apparent anomalies in monsters of this class. The writer is indebted to Dr. Johnson, Master of the Dublin Lying-in Hospital, for permission to dissect a specimen of this species of monstrosity in the human subject, and he has obtained through the kindness of Dr. William Wilson Campbell, (formerly assistant in the same establishment,) the particulars of

Fig. 427.

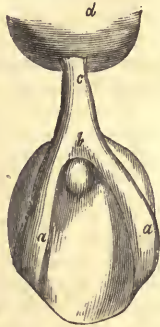

Optic nerve in a human Cyclops. (From a dissection by the writer.)

a, a, tractus opticus of either side; *b*, chiasma; *c*, single optic nerve; *d*, sclerotic coat of the eye perforated by the optic nerve.

Fig. 428 represents the encephalon, optic nerve, and organ of vision in a kitten at the full period of gestation, (the subject of the same form of monstrosity,) which lately came into the writer's possession: the preparation is preserved in the Museum of the Richmond Hospital School, Dublin. In all essential particulars this specimen bears the closest resemblance to the human monsters of which the dissection has just been described.

The fundamental defect in these monstrous

Fig. 428.

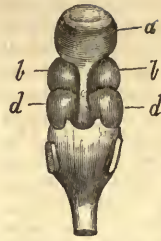

Brain and organ of vision of a Cyclops kitten, at the full period of gestation. Seen from below. (Natural size.)

a, organ of vision, single, and of great dimensions; *b, b*, cerebral hemispheres seen from below; *d, d*, tubercula quadrigemina; *c*, optic nerve, single, and of great size.

fetuses consists in the total absence of the organ of smell, in consequence of which deficiency the symmetrical organs at either side become united in the middle line and actually engrafted upon each other: the two eyes are conjoined so as to form but a single organ of vision, and the very same metamorphosis occurs in the two orbits, the two optic foramina, the two optic nerves, &c.

That this is the rationale can scarcely admit of doubt, since in some parts of the organs the fusion remains incomplete; thus two crystalline lenses still exist in the interior of the solitary eye-ball: a double set of muscles with their corresponding nerves are provided for the globe of the eye; and four eye-lids protect the organ in front, causing the aperture of the lids to assume a quadrangular form.

General development of the optic nerves in the higher classes of animals.

Fish.—In fish as a general rule these nerves are highly developed, and exhibit a marked preponderance in size when contrasted with the corresponding nerves in many animals holding a more exalted position upon the scale. This may be explained by the nature of the medium which the fish inhabits; for some of the light incident on the surface of the water is reflected, and another part, after penetrating the water, becomes absorbed, in consequence of the continual disturbance to which the transparency of this fluid is subject; so that fishes necessarily require a greater development of visual apparatus than would suffice land animals for an equal amount of vision.

Birds.—In birds the sense of sight exists in great perfection, and the optic nerves exhibit corresponding development.

Mammalia.—In Mammalia the faculty of vision ceases to preponderate, and accordingly the proportions of the optic nerves in this class are no longer excessive.

Many facts in comparative anatomy warrant the conclusion that the senses of smell and vision are at times supplemental to each other; for example, the mole either possesses no optic nerve, or if any such exist it is so diminutive as to be most difficult of recognition, but the olfactory lobes of the brain and the whole olfactory apparatus of the animal exist in great perfection, and its subterranean habits enable it to turn this latter function to account, whilst a highly finished organ of vision would have been an useless appendage. In certain fish which frequent the mud or slimy waters (as for instance the eels), the visual apparatus is poorly developed, and the optic

nerves are particularly small; but the olfactory nerves preponderate, and there can be little doubt that the superiority of the sense of smell in them serves in great measure to supersede the necessity for highly-wrought organs of vision, and in probably the majority of the Mammalia the olfactory nerves preponderate in size over the optic, but the corresponding faculty by its acuteness makes amends for any inferiority in vision. Thus the keen scent of many Carnivora renders the eye of secondary importance in the pursuit of their prey, and the vegetable feeders are much indebted to the perfection of their sense of smell for the discrimination they evince in their choice of nutriment.

FUNCTIONS OF THE OPTIC NERVE.

The optic nerves when present are essential to vision.

In all animals which possess optic nerves they must be considered essential to vision, for diseases which destroy the organization of the "second pair" invariably deprive the organs of sight of their sensibility to luminous impressions; and were other proof wanting, the experiments instituted of late years by Magendie, Mayo, and others, would afford sufficient evidence of the special function of the nerves in question. Magendie found that division of either optic nerve in front of the chiasma was instantaneously followed by complete loss of vision in the corresponding eye of the animal submitted to the experiment; and when both optic nerves were thus divided total blindness ensued, and no means which could subsequently be devised for concentrating light upon the eye appeared to excite in the retina the slightest sensibility to its accustomed stimulus.

Although the foregoing facts would warrant the conclusion that the only nerves capable of endowing the eyes with their special sensibility are the optic, nevertheless many considerations favour the presumption that the fifth pair exert direct influence on the sense of sight, so much so that some have considered these nerves essential to vision, whilst others have even supposed that the faculty in question may be maintained through the agency of the fifth nerves alone.

In those animals which possess special optic nerves, the fifth pair are totally inadequate to support vision.

There are no facts on record to prove the possibility of such animals continuing to see after destruction of the second pair. The experiments already cited may be looked on as conclusive, and those performed by Magendie to show that division of the fifth nerves within the cranium in living animals produces blindness, can never justify physiologists in the belief that the "trifacial" may endow the eyes with their special sensibility.

Certain facts furnished by the comparative anatomy of the second and fifth pairs have been from time to time adduced to shew that the fifth in the human subject possesses this power. Thus it is stated on good authority, that the common Mole, the Proteus anguinus, the Mus Capensis, the Chrysochlore, the Mus typhlus, and

the Sorex araneus, in which organs of vision occur, are not provided with special optic nerves, and that in them the fifth pair furnishes the only nerve which the rudimental eye receives. It is argued from these data (and Serres would seem to be one of the ablest advocates for this view) that a branch of the fifth nerve assumes in such cases the functions of the optic, becoming endowed with special sensibility to light, and that therefore from analogy the ophthalmic division of the fifth in man may be presumed to possess similar properties.

Conclusions arrived at by such reasoning should be received with caution in the absence of more direct proofs; the weight to which they are entitled has been already fully discussed under the article FIFTH PAIR OF NERVES, and reference is made to that article for further particulars touching this interesting topic. The writer fully concurs in the views therein advocated, and feels disposed to attribute little value to arguments founded, as they appear to be, on imperfect analogies. The cases of the human subject and the animals specified are essentially dissimilar; the presence of a special optic in the one case, and its absence in the others, destroys their parallelism, and may create important differences in the functions of accessory nerves; and, moreover, the little knowledge we possess of the nature and amount of vision enjoyed by animals in which special optic nerves are wanting, should make us hesitate to argue from them to the human subject.

That the fifth pair exercise some influence over vision can scarcely be denied, but the nature and amount of this influence are not so easily determined, and have probably been much exaggerated.

In the present state of their knowledge physiologists have not sufficient proof that in the higher animals the influence of the fifth pair is absolutely essential to sight.

Magendie discovered that the section of the fifth nerve on both sides within the cranium of a living animal greatly impairs, if it does not actually annihilate vision, and such a result seems, no doubt, to argue that the faculty of sight has a necessary dependence on the integrity of the "trifacial nerves," but the experiment when critically examined will appear not to warrant such an inference; it demonstrates that so rude an injury inflicted on the nervous centres deprives an animal of one of its faculties, and this might have been anticipated on general principles; but it does not prove that the loss of the faculty depends on the injury to the fifth nerves alone. In such a destructive proceeding there can be no assurance that the fifth pair have been the only parts of importance mutilated; the contrary is by much the more probable presumption, and, therefore, the conclusion "that the fifth nerves are essentially necessary to vision" is not fairly deducible from the experiment. But farther, the facts (detailed even as they are by Magendie) suffice to show, that the eye may continue sensible to luminous impressions after complete division of the fifth pair, for according

to his own account, "the eye of the rabbit on sudden exposure to the sun's rays, after the fifth pair had been divided, was still sensible to strong solar light; and the effect was more marked when a lens was used to test its sensibility."

Mayo's experiments on pigeons afford still more convincing proof of the ability of the optic nerve, *unaided by the fifth*, to maintain the special sensibility of the eye; this physiologist succeeded in dividing the fifth nerve within the cranium of a living pigeon (leaving the optic uninjured,) *without rendering the retina insensible to light.*

The results of pathological observations on man furnish also abundant evidence that vision *may continue* after disease has destroyed the fifth nerve. Opportunities do not often occur of bringing this to the test of dissection, for in most of these cases changes of structure involve other parts of the nervous centres simultaneously with the fifth nerve, and so deprive them of their greatest value; and the destructive inflammation of the eye-ball, which so constantly accompanies morbid alterations of the fifth pair, is another fruitful source of embarrassment in attempts to investigate their history, but even a few well-attested observations are amply sufficient to establish a negative proof. Müller cites a case of disease involving the whole trunk of the fifth nerve of the left side, in which insensibility of the entire left side of the head and the corresponding side of the tongue and eye, occurred, *while vision remained perfect*; and in the article FIFTH PAIR OF NERVES, other similar examples are related.

The conjecture that the fifth pair is essential to vision receives probably its strongest support from the occasional results of injuries to certain branches of that nerve, for numerous cases are on record in which wounds or contusions of its frontal twigs have been followed by blindness, and the same unfortunate event has resulted (though rarely) from irritations affecting some of its other branches. Thus, Mr. Travers has known amaurosis to originate from irritation of the dental nerves. He says, "I have seen an incipient amaurosis arrested by the extraction of a diseased tooth, when the delay of a similar operation had occasioned gutta serena on the opposite side two years before." And Professor Galenzowski of Wilna "observed severe neuralgia and blindness produced by a splinter of wood becoming entangled in a diseased tooth, and these symptoms were cured by the extraction of the tooth together with the offending material."

The value of such facts as these in assisting physiologists to determine the influence exerted by the fifth nerve over vision, appears to have been much overrated; for in a large proportion of these cases it may be inferred with great probability that the same injury which affected the supra-orbital nerves exerted also pernicious influence on the deeper seated contents of the orbit, and that the optic nerve, or retina, or even the brain itself participated in the effects of the violence, although from the more superficial position and greater exposure to danger of the frontal

branches of the fifth, they alone were believed to have suffered. This explanation will undoubtedly not apply to cases in which blindness has been produced by very trivial injuries, such as simple incised wounds or punctures of the nerves in question; but nevertheless the weight of evidence which these latter cases would seem to afford is much diminished by the consideration that loss of sight has likewise ensued from injuries and affections of other nerves, to which, while healthy, no participation in the support of vision can be conceded. For example, Dr. Jacob recites the case of an officer in whom amaurosis occurred in consequence of injury inflicted by a ball on some branches of the portio dura,* and irritations in the digestive organs (dyspeptic disturbance of the stomach more especially) are well known to produce at times amaurotic symptoms. Now, although these facts unquestionably establish the existence of curious *pathological* affinities between the nerves of the part thus irritated and those which are subservient to vision, no physiologist would be hardy enough to infer from such premises that the facial nerve, the par vagum, or those which supply the intestinal tract, exercise in the *normal* state any control over the faculty of sight.

If, in addition to these considerations, it be recollected that blindness occurs only as an *occasional* consequence of injuries to the frontal nerves, and that loss of vision is found to ensue *very rarely* from the irritations to which other branches of the fifth are so peculiarly liable, the importance of such cases in determining the question must be still further lessened. The observations of Dr. Jacob on this subject appear to the writer so apposite that he is induced to insert them. This gentleman writes, "Blindness does not seem to have followed any of the operations formerly so much practised of dividing the branches of this nerve, and in some of the worst cases of that form of neuralgia called tic douloureux, vision is not impaired. Moreover, thousands of children suffer from dentition and thousands of adults from tooth-ache, yet none of these become blind in consequence."†

The coincidence of loss of sight with injuries or irritations affecting branches of the fifth nerve, admits of explanation on other principles without assuming the fifth to be *essential* to vision; the hypothesis that in such cases reflex irritation becomes propagated from the parts primarily affected through the nervous centres to the optic nerve, seems in the present state of physiological science sufficiently plausible; for while it applies to cases of amaurosis resulting from abnormal conditions of *other* peripheral branches of the nerve as well as its ophthalmic division, it also affords a solution of the still more obscure dependence of the same disease on irritations in remote organs.

The experiments of Magendie, confirmed as they have been by pathological observations,

* Cyclopædia of Practical Medicine, art. AMAUROSIS.

† On Paralytic Neuralgia and other Nervous Diseases of the Eye, by Arthur Jacob, M.D.

justify the inference that the fifth nerve endows the eye with its *general* sensibility, and also exerts some influence over the nutrition of that organ.

This distinguished physiologist divided the fifth nerve within the cranium of an animal and found the tactile sensibility of the surface of the eye completely abolished by the experiment; opacity, ulceration, and sloughing of the cornea, followed by expulsion of the humours, and total destruction of the eye subsequently ensued; and nearly the same results have been observed to occur in the human subject from disease affecting the fifth nerve within the cranium. It must be perfectly obvious, however, that these facts have no bearing upon the question more immediately under discussion.

An impartial review of this highly interesting question leads to the conviction that notwithstanding the great plausibility of the arguments by which the *contrary* view has been sustained, there is as yet no evidence that in man any other nerve than the optic enjoys special sensibility to light.

Ordinary tactile sensibility.—Although the optic nerves are endowed with such acute sensibility to the influence of light, they would seem to possess little *ordinary tactile* sensibility,—a circumstance the more surprising, as it is difficult to imagine any impressions more delicate than those of light; and where nerves evince such exquisite susceptibility of excitement from the stimulus of that imponderable agent, an equal obedience to those rougher stimulants which produce such marked effects on the common sentient nerves might at least be expected.

Magendie infers from his experiments on living rabbits that the retina in them is not susceptible of pain from mechanical irritation; so much so, that puncturing or tearing that nervous expansion appeared to him to cause these animals no sort of suffering.* Precisely the same results followed from injuries inflicted by him on the retina in fish and reptiles, although in birds, cats, and dogs similar experiments seemed to create some uneasiness. This physiologist asserts that the human retina *also* is devoid of ordinary tactile sensibility, for in operating for cataract he has proved that the membrane in question exhibits little if any susceptibility of pain.

His experiments were likewise extended to the optic nerves; and in the course of his investigations frequent opportunities were afforded for testing the comparative sensibility of the second and fifth pairs. In all the mammalia, whether the injury was inflicted in front of or behind the chiasma, the second pair seemed quite insensible to mechanical irritation; and whenever the slightest disturbance affected the fifth nerve, the animal, by its cries and struggles, immediately manifested the most acute sufferings.

The phenomena noticed in extirpation of the human eye are favourable to the same views,

for division of the optic nerve in this operation is not attended with the agonizing torture which an equal amount of injury to a nerve of the same dimensions endowed with common sensibility would unavoidably produce. This fact should have some weight with physiologists in their attempts to form a just estimate of the properties of the nerve under consideration, although the results of such observations are inconclusive; for in many cases of extirpation of the organ the optic nerve is itself diseased, and under such circumstances it would be unfair to argue from the *known* effects of injuries on a *diseased* structure, to the *probable* effects of injuries on the same structure *when healthy*.

The optic nerve is not singular in its insensibility to pain from mechanical irritation, for experiments on other nerves of special sense countenance the belief that some of them labour under the same disability. Magendie laid bare the olfactory of a dog, and the animal did not manifest the slightest pain when the nerve was compressed, pinched, or even torn; and when the auditory of a rabbit was subjected to similar rough treatment at his hands, the animal afforded no indication of suffering.*

The specific stimulants of the organs of sense act however at times so intensely as to produce *painfully* disagreeable impressions on their respective organs, and it therefore becomes difficult to reconcile, with the foregoing statements, facts such as the following, which apparently favour the opinion that the optic as well as other nerves of special sense possess *common* sensibility. "An intense light dazzles the eye so as to become actually insupportable. A harsh or discordant sound produces a most distressing impression on the organ of hearing; and certain odours are disgusting and intolerable to the pituitary membrane."

In estimating the weight to which these latter facts are entitled, it should be recollected that the above sensations still preserve their specific characters, no matter how intensely disagreeable they become: thus light, although sufficiently brilliant to dazzle the retina, still continues to be a luminous impression, and in like manner sonorous vibrations and odours, though actually offensive to their respective organs, are still nothing more than sounds and scents. So that on the whole, however questionable may be the propriety of such experimental zeal as would induce a French physiologist to test the sensibility of the human retina in operations for cataract, the general proposition that the optic nerve in man and the higher animals enjoys little, if any, tactile sensibility, seems pretty well established.

Effects of stimulants.—Although the optic nerve betrays little indication of pain in consequence of injuries, nevertheless mechanical and other stimulants produce upon it peculiar effects: mechanical injuries and irritants arouse its *special sensibility* instead of exciting painful sensations—their ordinary effects on common sentient nerves.

* Journal de Physiologie, t. iv.

* Journal de Physiologie, t. iv.

For example: firm pressure applied to the globe of the eye when the lids are closed and light excluded, gives rise to the sensation of luminous spectra which present different colours. Concussion of the eye-ball is often followed by the same results: division of the optic nerve in extirpation of the organ of vision generally causes the patient to perceive a great light; and an electric current transmitted through the optic nerve, or its immediate vicinity, seems to produce a flash of light. The second pair, in having their *special* sensibility excited by such varied stimulants, merely conform to the laws by which other nerves of special sense are governed; for electricity applied to these nerves *severally* may be made in each case to elicit the peculiar sensibility of the nerve which happens to be the subject of the experiment: in the optic nerve it produces the sensation of a flash of light; in the auditory it excites a loud sound; in the gustatory it gives rise to a peculiar taste; in the olfactory it develops a particular smell; and in the common sentient nerves it causes painful sensations. In like manner a blow may occasion the optic nerve to flash fire, the auditory nerve to hear sounds, the common sensitive nerves to feel pain; and more examples might be added to this catalogue.

The nerves of special sense seem in general to be endowed with but one determinate sort of sensibility; and though this is commonly excited by a specific stimulus *only*, it may be elicited occasionally *by other means*.

Excito-motory properties.—The optic nerve is one of those paths through which incident impressions are propagated so as to excite reflex motions. The impression of light on the retina is instantaneously followed by contraction of the pupil, a phenomenon indicative of reflex motion developed in the iris; and the sudden closure of the eye-lids under the influence of a strong light or a threatened blow is also a familiar example of reflex motion produced by impressions upon the terminal expansion of the optic nerve.

Lambert, Fontana, and Caldani, have demonstrated that the optic nerve is the channel through which the incident impression travels in order to excite reflex motion in the iris. In their experiments, rays of light transmitted through a hole in a sheet of paper, and by this contrivance conveyed through the pupil *directly* to the retina, produced immediate motion of the iris; but when the light was allowed to impinge upon the iris *alone* without reaching the retina, *no* contraction of the pupil ensued.

Mayo's experiments on pigeons taken in connection with the foregoing facts appear particularly instructive, proving as they do that in the bird, irritation propagated along the optic nerve in a centripetal direction may excite reflex motion in the iris. When the optic nerves were divided within the cranial cavity of a living pigeon by Mayo, the pupils became fully dilated and were no longer obedient to luminous impressions even when dazzling light was admitted into the eyes. When a pigeon was decapitated by the same experimentalist, and its optic nerves

subsequently divided within the cranial cavity, irritation of that portion of the divided nerves which continued in connection with the *eye* produced no effect on the iris; but contraction of the pupil immediately ensued when the *other* extremity of the nerves, viz. that which retained its connection with the *brain*, was irritated.

In general the reflex motion is developed in the iris of the *same eye* on which the impression is incident, or in other words light falling on the *right* retina produces in general contraction of the *right* pupil and not of the left, and vice versa; but it sometimes happens that an impression propagated along one optic nerve (for instance the *right*) may cause the reflex phenomena to appear in the iris of the other eye (viz. the *left*).

Certain forms of amaurosis in which the disease affects *but one* eye while the other continues healthy will serve for illustration.

In such cases it occasionally happens that little or no difference in the size of the two pupils can be detected so long as both eyes remain exposed to the light, the iris of the diseased organ contracting and dilating simultaneously with that of its healthy neighbour; but as soon as the lids of the sound eye are closed, the pupil of the amaurotic eye becomes dilated, and the most intense light admitted into this diseased organ takes no effect on the iris, now become perfectly motionless.

The explanation of these phenomena is found in the preceding proposition; so long as the *healthy* eye continues exposed to light, the impression falling on a *sound* retina excites reflex motion in the pupils of both eyes, as well the amaurotic as the sound; but when the light is excluded from the healthy retina, the influence of that agent upon the *diseased retina* of the other eye has no longer the power to excite reflex motions.

The exercise of these excito-motory properties of the optic nerve is generally accompanied with excitement of its *special* sensibility; thus a person is *in general* conscious of the luminous impression, or, in other words, he sees the light which causes contraction of his pupil; but the reflex phenomena *may* be manifested by the iris, although the incident impression pass unnoticed by the individual.

In certain cases of general insensibility (as, for example, concussion occasionally) the pupil contracts upon the admission of light while the patient remains perfectly unconscious, and something similar seems to occur at times even in health; for the iris varies its dimensions with each successive change in the volume and intensity of the light, although from inattention we do not perceive these trifling changes. Some degree of attention appears requisite in order that weak or transitory impressions should arouse the special sensibility of the optic nerves, whereas attention is not a condition essential to the production of reflex phenomena.

Mayo's experiments here again admit of application; he found that in decapitated pigeons in which the optic nerves were subsequently divided, irritation of the cerebral ex-

trinity of the cut nerve produced contraction of the pupil, although under the circumstances the animal could not have been conscious of such irritation.

Radiated or sympathetic sensations.

The optic nerve participates in a class of obscure sensations to which a brief allusion may be here permitted; these are called radiated or sympathetic sensations; they occur occasionally in health, though they are more frequently symptomatic of disease or irritation elsewhere situated, and as they are likewise manifested by other nerves it would be erroneous to consider them *peculiar* to the optic. The phenomena to which allusion is made are for the most part transitory affections of sensitive nerves which do not seem to depend on any *direct* impression made upon the nerve affected, but rather to be produced by causes which act on other (generally distant) parts of the system.

The following will serve as examples of the affections under consideration.

A discordant sound, such as that produced by setting a saw or scratching glass, gives rise to shuddering, or a sensation as if water were dropping over the surface. Tickling the soles of the feet occasions general sensations of the most disagreeable nature; and the impression of a strong light on the eye is often followed by a sense of irritation in the nose, with violent sneezing.

Similar affections of the optic nerve will readily occur to the reader's recollection; thus various forms and degrees of temporary insensibility or excitement of the retina, which are known to depend on gastric disturbance, belong to this category, and many other such instances might be adduced.

Facts, such as the foregoing, have long been familiar to physiologists; but to account for them seems still to be a matter of difficulty. The supposition that the connections of the sympathetic with the nerves affected explain the problem is far from satisfactory; the most plausible theory is that which supposes the primary irritation to be propagated in a centripetal direction along the nerves of the part to the cerebro-spinal centres, and thence reflected upon the roots of those nerves in which the sensations are developed, in somewhat the same way that excito-motory impressions on nerves come to produce reflex motions; the difference in the two cases amounting to this, that in the one the primary impression reacts upon *motor* nerves, giving rise to reflex motions, in the other on *sensitive* nerves causing thereby reflex sensations.

Though this may be the true explanation, it is nevertheless not perfectly satisfactory, for it does not shew *why* the reflex irritation should be prone to fall on one sensitive nerve in preference to another, yet the optic is known in such cases to suffer more frequently than the auditory or olfactory.

BIBLIOGRAPHY.—The following books may be referred to in addition to the several systematic treatises on Physiology and Descriptive Anatomy. *Sir J. Newton*, His optics, query 15, London, 1718.

John Swammerdam, Book of nature, translated by Thomas Flooy, 1758. *Sam. Thom. Swammering*, De basi encephali et originibus nervorum, 1778. *Alexander Monro*, The structure and physiology of fishes, Edinb. 1785. *F. J. Gall et G. Spurzheim*, Anatomie et physiologie du système nerveux, Paris, 1810. *Cuvier*, Mémoires pour servir à l'histoire et à l'anatomie des mollusques, Paris, 1817. *Geoffroy St. Hilaire*, Philosophie anatomique des monstruosités humaines, Paris, 1822. *Flourens*, Recherches expérimentales sur les propriétés et les fonctions du système nerveux, Paris, 1822. *Herbert Mayo*, Anatomical and physiological commentaries, second part, July 1823. *Wm. Hyde Wollaston*, On semidecussation of the optic nerves, Philosophical Transactions, 1824. *E. R. A. Serres*, Anatomie comparée du cerveau, Paris, 1824. *Magendie*, Journal de physiologie expérimentale et pathologique, Paris, 1824. *Desmoulins et Magendie*, Anatomie des systèmes nerveux des animaux et vertébrés, Paris, 1825. *Frederick Tiedemann*, The anatomy of the fetal brain, translated from the French by Wm. Bennett, 1826. *Müller*, Physiologie des Gesichtssinnes, Leipz. 1826. *Joseph Swan*, A demonstration of the nerves of the human body, London, 1830. *Frederici Arnoldi*, Icones nervorum capitis, 1834. Catalogue of the physiological series of comparative anatomy in the Museum of the Royal College of Surgeons, London, 1833 to 1838. *Samuel Solly*, The human brain, its configuration, structure, &c. London, 1836. Catalogue of the Museum of the Royal College of Surgeons in Ireland, by John Houston, M.D. Dublin, 1834. *Marshall Hall*, Lectures on the nervous system and its diseases, London, 1836: also "Memoirs on the nervous system," by same. *Fr. Leuret*, Anatomie comparée du système nerveux, Paris, 1839. *Herbert Mayo*, On the chiasma of the optic nerves, London Medical Gazette, November 1841. *Arthur Jacob*, On paralytic, neuralgic, and other nervous diseases of the eye, Dublin, 1841. *John H. Power*, Observations on the arrangement of the optic nerve of the loligo, &c. Dublin Journal of Medical Science, 1843.

(Robert Mayne.)

ORBIT. (*Orbis*, any thing round: Fr. *l'orbite*; Germ. *Augenhöhle*.)—In the present article it is intended to describe, first, the bony framework of the orbit; secondly, the contents* of the orbit in the order in which they are exposed by a dissection from the roof to the floor of the cavity; and, lastly, to give some account of the action of the muscles contained in the orbit and inserted into the upper lid and globe of the eye.

The orbits are two in number, situated at the anterior and upper part of the face. They have the form of quadrangular pyramids, the bases of which are directed forwards and outwards, the apices backwards and inwards. Each orbit presents for examination four walls, four angles, formed by the meeting of the walls, a base, and an apex.

The *superior wall* or roof is concave and directed downwards and slightly forwards. It is chiefly formed by the orbital plate of the frontal bone; at the posterior part to a slight extent by the lesser wing of the sphenoid. It presents the suture between the orbital plate of the frontal and the lesser wing of the sphenoid, and anteriorly on the outer side, the lachrymal fossa, which receives a gland of the same name.

* The relative anatomy only of these parts will be given in this article, a special description of the EYE and LACHRYMAL ORGANS having already been given.

on the inner side a depression for the insertion of a pulley, through which runs the tendon of the superior oblique muscle.

The *inferior wall* or *floor* is less extensive than the roof, and is directed upwards, outwards, and forwards. It is formed chiefly by the orbital plate of the superior maxillary bone, in front of this by the orbital process of the malar, and at the posterior part to a slight extent by the orbital process of the palate bone. It presents a suture marking the union of the malar with the maxillary, and of the maxillary with the palate bone; about the middle of the floor is the infra-orbital groove, which passes forwards and becomes the infra-orbital canal.

The *external wall* is directed inwards, forwards, and slightly upwards; it is formed in front by the orbital process of the malar, and posteriorly by the orbital surface of the greater wing of the sphenoid. It presents a vertical suture at the junction of the malar with the sphenoid bone, and the orifices of some small canals which open externally in the temporal fossa, and on the facial surface of the malar bone; some of these canals transmit filaments of nerves from the lachrymal branch of the ophthalmic, and from the superior maxillary nerve.

The *internal wall* is directed outwards, and slightly forwards and upwards: it is formed chiefly by the os planum of the ethmoid, in front of this by the lachrymal, and behind by the side of the body of the sphenoid. It presents a vertical suture between the lachrymal bone and the ethmoid, and another between the latter bone and the sphenoid; and anteriorly a vertical groove which lodges the lachrymal sac.

ANGLES.—The *superior* and *external* angle formed by the junction of the superior with the external wall presents posteriorly the sphenoidal fissure, sometimes called foramen lacrum anterius; in front of this a horizontal suture at the junction of the orbital plate of the sphenoid with the orbital plate of the frontal bone, and anterior to this the junction of the malar with the frontal bone.

The *superior* and *internal* angle formed by the meeting of the superior and internal walls presents a suture between the os planum of the ethmoid and the orbital plate of the frontal; in this suture are two small holes, the anterior and posterior internal orbital holes; the anterior transmits the nasal branch of the ophthalmic nerve, and the anterior ethmoidal artery; the posterior gives passage to the posterior ethmoidal artery; in front of the last-mentioned suture is another between the lachrymal and frontal bones.

The *inferior* and *external* angle, formed by the meeting of the inferior and external walls, presents posteriorly the sphenomaxillary fissure, which is bounded externally by the orbital plate of the sphenoid, internally by the orbital plates of the superior maxillary and palate bones, and in front usually by the orbital process of the malar bone, but occasionally by the junction of the orbital plates of the superior maxillary and sphenoid bones at this point.

The *inferior* and *internal* angle formed by

the meeting of the inferior and internal walls presents a continuous horizontal suture, which in front connects the maxillary bone with the lachrymal, behind this the maxillary with the ethmoid, and still more posteriorly the palate bone with the ethmoid.

The *base* or *circumference* is of an irregular quadrilateral form with curved sides and rounded angles; it inclines obliquely from within outwards. It is formed above by the supra-orbital arch of the frontal bone, on the outer side by the external angular process of the frontal and by part of the orbital border of the malar; *below* by the continuation of the orbital border of the malar, and by the corresponding orbital border of the superior maxillary bone; on the inner side it is completed by the nasal process of the superior maxillary, and the internal angular process of the frontal bone. At the junction of the middle with the inner third of the supra-orbital arch is the supra-orbital notch or foramen, which transmits the frontal nerve and vessels. There are three sutures in the margin of the orbit, one between the frontal and malar, a second between the frontal and superior maxillary, and a third between the malar and superior maxillary bones. At the junction of the lower with the inner border of the orbit is a small tubercle, the *lachrymal tubercle*, which is sometimes pointed out as a guide in the operation for fistula lachrymalis, but it is seldom very prominent even in the bare bone, and it could scarcely be detected through the tumefaction consequent on obstruction of the lachrymal duct. The lachrymal groove is immediately behind the internal margin of the orbit.

In the *apex* of the orbit is the optic foramen situated between the two roots of the lesser wing of the sphenoid bone; the direction of the optic hole is backwards and inwards towards the centre of the sella Turcica. The inferior root of the lesser wing of the sphenoid, which separates the optic hole from the sphenoidal fissure, presents anteriorly a small tubercle which gives origin to the common tendon of the internal, external, and inferior recti muscles.

Dissection of the orbit.—Having removed the skull-cap and brain, the roof of the orbit may be taken away by two vertical cuts with a saw, the inner cut extending from a point just external to the internal angular process, backwards along the roof to the optic foramen, the outer cut extending from a point just internal to the external angular process, also backwards to the optic foramen. In making these cuts care must be taken to avoid injuring in front on the inner side the pulley and tendon of the superior oblique muscle, on the outer side the lachrymal gland with its vessels and nerves, and posteriorly the optic nerve and ophthalmic artery passing through the optic hole. Having removed the bony part of the roof the periosteum is exposed, and must be examined before proceeding farther.

The *periosteum* of the orbit appears to be a continuation of the dura mater; it passes in through the optic hole, and through the sphenoid

noidal fissure. Entering the optic hole it divides into two portions, one forming a tubular sheath for the optic nerve, and becoming continuous with the sclerotic, the other forming the proper periosteum. Where it enters the sphenoidal fissure it also forms a sheath for the vessels and nerves which pass through that opening. At the anterior margin of the orbit this fibrous membrane divides into two portions, one becoming continuous with the palpebral ligament or fascia, the other with the periosteum of the forehead.

The periosteum may now be removed, and the following parts are seen immediately beneath it: in the middle line the frontal branch of the ophthalmic division of the fifth nerve, on the outer side the lachrymal branch of the same nerve, and on the inner side is the fourth nerve. Immediately under the fourth nerve is the superior oblique muscle; beneath the frontal nerve are the levator palpebræ and superior rectus, and below the lachrymal nerve is the external rectus muscle; beneath the external angular process is the lachrymal gland. Some branches of the ophthalmic artery are seen in this part of the orbit. A considerable quantity of soft fat exists in the orbit, filling up the intervals between the muscles and other parts; some of this must be removed before a clear view can be obtained of the parts which we have enumerated as being visible in this stage of the dissection.

The *lachrymal gland* is contained in a depression on the roof of the orbit, beneath the external angular process of the frontal bone. It is generally about as large as a filbert, of an irregular ovoid form, with its long diameter placed transversely. Its upper surface is convex, and connected by means of fibrous processes to the periosteum; its under surface is concave, and is in relation with the external rectus muscle and the eye-ball. The excretory ducts of this gland, from ten to twelve in number, run parallel to each other, and open by as many orifices beneath the upper lid, about a line from the tarsal cartilage.

The *fourth nerve* enters the orbit by passing through the inner part of the sphenoidal fissure. At this point it is above the other nerves, which pass through the same opening. It then passes forwards and inwards immediately under the periosteum, crossing over the origin of the levator palpebræ and superior rectus muscles, and it is distributed to the orbital surface of the superior oblique muscle.

The *frontal nerve*, a branch of the ophthalmic division of the fifth, enters the orbit with the fourth nerve, but a little below it and on its outer side. It passes forwards between the periosteum and the levator palpebræ, and soon divides into two branches, *internal* and *external frontal*, or *supra-trochlear*, and *supra-orbital*. The supra-orbital is the larger branch; it passes out through the supra-orbital notch or foramen, and divides into ascending *frontal* branches, usually two in number, which are distributed to the skin of the forehead, and descending *palpebral* filaments, which are very numerous and are distributed in the substance of the upper eyelid.

The supra-trochlear nerve passes out of the orbit between the supra-orbital notch and the pulley of the superior oblique; it gives off ascending frontal filaments to the skin of the forehead, and descending palpebral and nasal filaments to the upper eyelid and dorsum of the nose.

The *lachrymal nerve* is the smallest of the three divisions of the ophthalmic; it enters the orbit through the sphenoidal fissure external and inferior to the frontal nerve; in its passage through the sphenoidal fissure it is invested in a sheath of dura mater. It runs along the superior border of the external rectus muscle, immediately under the periosteum; it passes through the lachrymal gland, sending numerous filaments to it, and terminates by sending palpebral filaments to the upper lid, one of which passes on and is distributed to the skin of the anterior temporal region. In its course it gives off a *malar* branch, which passes through a canal in the malar bone and is distributed to the skin on the cheek; it also sends down one or two filaments which anastomose with the superior maxillary branch of the fifth nerve.*

We may now examine the three muscles which are placed most superficially in the upper part of the orbit, and which are visible in this stage of the dissection, viz. the levator palpebræ, the superior rectus, and the superior oblique.

The *levator palpebræ superioris* arises tendinous from the inferior surface of the lesser wing of the sphenoid bone above the optic foramen, also from the fibrous sheath of the optic nerve; it passes forwards, and upwards, becoming broader and thinner towards the anterior part of the orbit, where it suddenly curves downwards and ends in a broad thin aponeurosis, which is inserted into the upper border of the tarsal cartilage, behind the palpebral ligament. This muscle is of a triangular form, the apex being posterior; it is crossed by the fourth and frontal nerves, the latter passing forward above and parallel to it, and separating it from the periosteum; it covers the superior rectus and eyeball.

In order to expose the superior rectus, cut through and turn aside the levator palpebræ; in doing so a small branch of the third nerve is seen to enter its inferior surface.

The *rectus superior* arises from the upper part of the fibrous sheath of the optic nerve, and from the outer and upper part of the margin of the optic foramen; the fleshy fibres from this point of origin pass forwards and outwards in the direction of the axis of the orbit; the muscle becomes broader and thinner anteriorly, and ends in a broad aponeurotic expansion, which is inserted into the upper aspect of the sclerotic, a little behind the margin of the cornea. A small synovial bursa is said to exist between the sclerotic and the tendon at its insertion. This muscle is covered above by the levator palpebræ, and by the nerves which cross the levator palpebræ; below it is in relation with the nasal

* For a more minute account of the distribution of these branches of the fifth nerve, see article FIFTH NERVE.

the third, and the optic nerves, with the ophthalmic artery and the eye-ball.

The *obliquus superior* is a long and slender muscle, which is sometimes called the *trochlearis* muscle from the fact of it being reflected through a trochlea or pulley. It arises from the fibrous sheath of the optic nerve, and from the inner part of the optic foramen between the superior and internal recti muscles; it passes forwards along the internal superior angle of the orbit, in the form of a rounded fleshy belly, to which succeeds a rounded tendon, which after passing through the pulley beneath the internal angular process is directed backwards, outwards, and downwards, passing beneath the superior rectus muscle to be inserted by a thin aponeurosis into the sclerotic coat between the superior and external rectus, rather behind the anterior half of the globe. This pulley or trochlea, through which passes the tendon of the superior oblique, is a small cartiliginous ring, inserted by means of fibrous tissue into a depression beneath the internal angular process; it is lined by a synovial membrane. The orbital surface of the superior oblique is in contact with the perosteum; the fourth nerve passes into this surface about its centre; the relations of its ocular surface are the same as those of the superior rectus.

The superior rectus and superior oblique muscles may now be cut through and turned aside, and after removing carefully some fat and cellular tissue the following parts are brought into view:—the internal and external recti muscles, the optic, the third, and the nasal branch of the ophthalmic nerves, the lenticular ganglion between the optic nerve and external rectus muscle, and the ophthalmic artery and vein.

The *third nerve* before entering the orbit divides into two portions; a superior smaller, and an inferior larger; it enters the orbit through the sphenoidal fissure between the two heads of the external rectus muscle; the inferior division then passes beneath the globe of the eye and must be examined in a subsequent stage of the dissection. The superior division is now visible; it passes to the under surface of the superior rectus muscle, to which it sends numerous filaments; some filaments also pass on the inner side of the superior rectus and enter the deep surface of the levator palpebræ superioris; these are the only muscles supplied by this division of the third nerve.

The *nasal nerve* is in size the second branch of the first division of the fifth. It enters the orbit through the sphenoidal fissure, passing between the two heads of the external rectus muscle, in company with the third and sixth nerves, being external to the former, and between its two divisions, and internal and somewhat superior to the latter. Having entered the orbit, it passes forwards and inwards towards the internal wall, crossing over the optic nerve between it and the superior rectus muscle; it has also above it the levator palpebræ and superior oblique muscles, and the superior division of the third nerve; it passes out of the orbit through the anterior internal orbital hole in

company with the anterior ethmoidal artery. Within the orbit it sends off *lenticular*, *ciliary*, and *infra-trochlear* branches. The lenticular branch is given off on the outer side of the optic nerve; it anastomoses with the superior division of the third nerve, and joins the posterior superior angle of the lenticular ganglion. The ciliary branches are two or three in number; given off above the optic nerve, they pass forwards and pierce the posterior part of the sclerotic. The *infra-trochlear* branch is given off near the inner wall of the orbit; it passes out beneath the pulley of the superior oblique muscle, and sends branches to the superior eyelid, the lachrymal sac, and integuments of the nose; within the orbit there is an anastomosis between this and the supra-trochlear or frontal nerve.

The *lenticular* or *ciliary ganglion* is situated in the posterior and outer part of the orbit between the optic nerve and the external rectus muscle; it is very small, and of a somewhat square form. Its superior posterior angle is joined by the lenticular branch of the nasal nerve, which constitutes the long root of the ganglion; its inferior posterior angle receives a branch from the inferior division of the third nerve; this forms the short root of the ganglion. To its posterior part is also connected one filament from the cavernous plexus, and occasionally one from the sphenopalatine ganglion. From the anterior part of the ganglion a number of delicate ciliary nerves pass off; they are divided into two sets, one set coming from the superior anterior, and the other from the inferior anterior angle of the ganglion; the former are the more numerous; in all they are from twelve to sixteen in number; they pass forwards and pierce the sclerotic near the optic nerve.

The *optic nerve* passes forwards from the optic hole to the inner and back part of the eyeball, which it enters to terminate in the retina. It is invested by a sheath of fibrous membrane, which is continuous behind with the dura mater, and in front with the sclerotic; the outer surface of this sheath posteriorly gives attachment to the recti muscles, which surround the optic nerve as it emerges from the optic hole. The optic nerve is crossed above by the nasal nerve and the ophthalmic artery, below by the branch of the inferior division of the third nerve, which supplies the internal rectus muscle; it is surrounded by numerous delicate ciliary nerves and arteries.

The *ophthalmic artery* passes through the optic hole in company with the optic nerve, and inclosed in a sheath derived from the dura mater. It is very tortuous and twines round the optic nerve, being at first inferior to the nerve, then passing to its outer side, and soon crossing over it to reach its inner side; it then passes across to the inner wall of the orbit, where it breaks up into its terminal branches. The branches of the ophthalmic artery are very numerous; they may be arranged in three sets; the first set arises from the artery as it lies external to the optic nerve; it consists of the lachrymal and the centralis retinæ; the second set comes off from the artery, when it is above the optic nerve; this consists of the supra-

orbital, ciliary and muscular; the third is given off when the artery has passed over to the nasal side of the orbit, and consists of the ethmoidal, palpebral, nasal, and frontal arteries.

The *lacrimal artery* is one of the largest branches of the ophthalmic; it arises from the ophthalmic either within the optic hole or immediately after that artery has entered the orbit. It sometimes arises from the middle meningeal artery, and enters the orbit through the sphenoidal foramen. It passes forwards along the outer wall of the orbit between the periosteum and the external rectus muscle; it enters the lacrimal gland, sending numerous branches to it; it then emerges from the gland and supplies the conjunctiva and the upper eyelid. It gives a *malar* branch which passes through the malar bone and anastomoses in the substance of the temporal muscle with the anterior deep temporal artery. The lacrimal artery generally anastomoses with the middle meningeal by a branch sent in through the sphenoidal fissure.

The *central artery of the retina* is a small branch which enters obliquely the optic nerve; it passes forwards in the centre of the nerve, enters the globe of the eye, and expands out into a vascular membrane on the inner surface of the retina. One small branch passes through the vitreous humour and reaches the posterior surface of the capsule of the lens.

The *supra-orbital artery* arises from the ophthalmic while it is above the optic nerve; it is one of the largest branches of the artery: it passes forwards close under the periosteum of the roof, and above the levator palpebræ, in company with the frontal nerve. It escapes from the orbit at the supra-orbital notch, and sends branches on the forehead, some between the skin and muscles, and others between the occipito-frontalis and the periosteum. In the orbit it supplies the levator palpebræ and superior rectus muscles, and sends some branches to the upper lid.

The *ciliary arteries* are very numerous, and are divided into three sets—anterior, middle, and posterior. The anterior ciliary arteries are irregular in number and origin; they usually come off from the muscular branches at the anterior part of the orbit; they perforate the sclerotic about one or two lines behind the cornea: some branches go to the iris and anastomose with the long ciliary arteries; others go to the choroid and anastomose with the short ciliary. The middle or long ciliary arteries are two in number; they accompany the nerves of the same name. They pierce the sclerotic at some distance from the optic nerve, and pass horizontally one on each side between the sclerotic and the choroid. They pass through the ciliary ligament and supply the iris. The posterior or short ciliary arteries are remarkably delicate and tortuous; they are accompanied by the ciliary nerves from the lenticular ganglion. Their origin is somewhat irregular; most of them arise from the ophthalmic artery, but occasionally some from the supra-orbital or from some muscular branches. There are as many as fifteen or twenty of these arteries, which surround the optic nerve in a spiral and tortuous

manner; they pierce the sclerotic about two lines anterior to the entrance of the optic nerve, and supply the choroid and ciliary processes. (For the mode of arrangement of these ciliary vessels in the choroid and iris see the article *EYE*.)

The *muscular branches* are uncertain in number and origin; they usually consist of two sets, a superior and an inferior. The superior set often come from the frontal artery, and supply the levator palpebræ, the superior oblique and the superior rectus muscles. The inferior muscular artery is a regular branch from the ophthalmic; it descends on the inner side of the optic nerve; it first sends a branch to the external rectus and then supplies the inferior and internal recti, and the inferior oblique; some branches pass on to the lower eyelid and the lacrimal sac. These arteries are usually distributed to the ocular surface of the muscles.

The *ethmoidal arteries*, two in number, are given off from the ophthalmic near the inner wall of the orbit. The posterior is usually the larger; it passes through the posterior orbital foramen and enters the skull, where it sends off some anterior meningeal branches, then passes down through the cribriform plate of the ethmoid bone, and is distributed on the mucous membrane of the nose. The anterior ethmoidal passes through the anterior internal orbital foramen with the nasal nerve; it has the same distribution as the posterior branch.

The *palpebral arteries*, two in number, arise near the inner angle of the orbit. The superior arises above the tendon of the orbicularis palpebrarum; it passes outwards and supplies the upper lid, one branch running near the tarsal margin of the lid, while the others are distributed to the muscles and integuments of the middle and upper part of the lid, where they anastomose with the supra-orbital artery. The inferior palpebral artery passes down behind the tendon of the orbicularis, then runs outwards along the lower lid, forming an arch near the free margin of the lid, and is gradually lost near the external canthus. It anastomoses with the angular branch of the facial, with the infra-orbital branch of the internal maxillary, with the transverse facial and temporal arteries. Beneath the internal angular process the ophthalmic artery terminates by dividing into the *nasal* and the *frontal* branches.

The *nasal artery* emerges from the orbit above the tendon of the orbicularis; it anastomoses freely with the angular artery, sends branches to the lacrimal sac, and terminates in a branch which passes down the dorsum of the nose, and communicates at the extremity of the nose with the corresponding artery of the opposite side.

The *frontal artery* passes out of the orbit with the nasal, then turns upwards, and is distributed to the muscles and integuments of the forehead, anastomosing with the supra-orbital and with the arteries of the opposite side.

The *ophthalmic vein* commences at the inner angle of the orbit, where it communicates freely with the angular and frontal veins; it passes

backwards in the same direction as the artery, but it is much less tortuous. It receives branches corresponding to those which the artery gives off, and passing between the two heads of the external rectus muscle below the nerves, it terminates in the anterior extremity of the cavernous sinus.

The ophthalmic artery and vein may now be removed; cut through the optic and ciliary nerves and remove some fat and cellular tissue which obscures the remaining muscles and nerves; we now obtain a more clear view of the internal and external recti muscles, and at the same time we expose the sixth nerve and the inferior division of the third, as well as the inferior rectus and the inferior oblique muscles.

The *sixth nerve* passes between the two heads of the external rectus muscle below the third nerve, and above the ophthalmic vein, from which it is separated by a process of dura mater. Having entered the orbit it passes along the inner surface of the external rectus muscle, to which it is distributed by numerous delicate filaments.

The *inferior division of the third nerve* enters the orbit, as we have seen, between the two heads of the rectus muscle, where it lies a little above the sixth nerve; having entered the orbit it passes down towards the floor between the optic and the sixth nerves, and below the level of the latter. It almost immediately divides into three branches: an *internal*, which passes inwards beneath the optic nerve towards the internal rectus muscle, to the ocular surface of which it is distributed; a *middle* branch, which is distributed in the same manner to the ocular surface of the inferior rectus; and an *external*, which passes forwards along the external border of the inferior rectus, and enters the posterior border of the inferior oblique, almost at right angles. The short filament which joins the posterior inferior angle of the lenticular ganglion, forming the short root of the ganglion, is usually given off from the branch which goes to the inferior oblique muscle.

The *external rectus muscle* has two origins, one from a tendon, the tendon or ligament of Zinn, which is common to this muscle with the inferior and internal recti, and which is attached to a little tubercle behind the optic foramen; the other origin of the external rectus is above, from the inner margin of the sphenoidal fissure; this origin is united with the origin of the superior rectus. Between these two origins pass the third, the sixth, and the nasal branch of the fifth nerves, with the ophthalmic vein. From its origin the external rectus passes forwards along the external wall of the orbit; it turns over the globe of the eye, and is inserted by a thin tendinous expansion just behind the margin of the cornea. A small bursa intervenes between the tendon and the sclerotic, as is the case with the tendons of all the recti muscles.

The *internal rectus* arises from the common tendon or ligament of Zinn, and from the fibrous sheath of the optic nerve; it passes forwards along the internal wall of the orbit,

turns over the globe of the eye, and is inserted immediately opposite the external rectus, in the same manner as the other recti muscles.

The *inferior rectus muscle* arises from the common tendon, between the internal and external recti; it passes forwards under the globe of the eye and is inserted into the sclerotic in the same manner as the preceding muscles, and immediately opposite the superior rectus. The recti muscles have all the same form, viz. that of a long isosceles triangle, having the base directed forwards, and the apex backwards. They differ in length and thickness; the internal rectus being the shortest and thickest, the external rectus the longest, and the superior rectus the smallest.*

The *inferior oblique muscle* is the only one which does not arise from the apex of the orbit. It arises from the orbital plate of the superior maxillary bone, just within the margin of the orbit, and near the groove for the lachrymal sac. From its origin it passes obliquely outwards, upwards, and backwards beneath the globe of the eye and the inferior rectus, then between the former and the external rectus; it ends in an aponeurotic expansion which is inserted into the sclerotic between the superior and external recti, opposite the insertion of the superior oblique, and rather nearer the optic nerve than the insertion of that muscle. The superior surface of this muscle is in contact with the inferior rectus and the globe of the eye; the inferior touches the floor of the orbit and the external rectus muscle; its borders are anterior and posterior; a branch of the third nerve enters the posterior border.

The *orbital portion of the superior maxillary nerve* may now be exposed by cutting through the external rectus muscle, and drawing the eye with its muscles towards the inner part of the orbit. The nerve having crossed the sphenomaxillary fossa enters the orbit through the sphenomaxillary fissure; in company with a branch of the internal maxillary artery it passes along the infra-orbital groove, covered by a layer of periosteum,† it then passes through the canal and emerges from the infra-orbital foramen. The trunk of the nerve is but little visible on the floor of the orbit. While the superior maxillary nerve is in the foramen rotundum, or during its passage across the fossa, it sends off a *temporo-malar* branch which passes through the sphenomaxillary fissure superior and external to the trunk of the nerve; it passes along the floor of the orbit, beneath the inferior rectus muscle, and about the middle divides into two branches, a *temporal* and a *malar*.

The *temporal branch* goes towards the outer wall of the orbit, passes up between the bone and the external rectus muscle, and joins with a temporal branch from the lachrymal; it then pierces the orbital process of the malar bone and enters the temporal fossa, where it communicates with the anterior deep temporal nerve, sends branches to the temporal muscle, and piercing the fascia is distributed to the skin over the temporal region.

* Cruveilhier. Descriptive Anatomy.

The *malar branch* passes on to the inferior external angle of the orbit, where it sometimes communicates with the lachrymal nerve; it enters one or more canals in the malar bone, and appears on the facial surface, supplying the orbicularis and the integuments, and communicating with the portio dura.

In addition to the structures ordinarily described as existing within the orbit, Mr. O'Ferrall has described* a fibrous structure, to which he gives the name of "tunica vaginalis," and which invests the globe of the eye, separating it from the muscles and fat of the orbit. In order to expose the outer surface of this structure, a vertical incision must be made through the integument of the upper lid; after removing carefully the orbicularis and a fascia, between the two layers of which the tendon of the levator palpebræ is inserted, the part next in order is the tarsal cartilage. Tracing this upwards and backwards its thin margin is found to be continuous with a fibrous lamina, which passes back into the orbit and separates the globe of the eye from the superior rectus muscle, but presenting a well-defined opening, through which the tendon of the muscle passes as over a pulley, to be inserted into the sclerotic coat. In order to examine the ocular surface of this membrane, Mr. O'Ferrall advises a vertical division of both palpebræ, then an incision through the conjunctiva at the angle of reflection from the eyelid to the ball of the eye.

The incision being made and the edges of the divided membrane separated, we expose the ocular surface of "a distinct tunic of a yellowish white colour and fibrous consistence, continuous in front with the posterior margin of the tarsal cartilage, and extending backwards to the bottom or apex of the orbit, where its consistence becomes less strongly marked." This ocular surface is smooth where the eye glides over it in its movements, and is connected to the surface of the globe by fine cellular tissue. The muscular substance of the recti muscles is on the outside of this tunic and invisible through it; but about half an inch posterior to its anterior margin are six well-defined openings through which the tendons of the muscles emerge in passing to their insertion in the sclerotic coat. Mr. O'Ferrall was induced to look for this structure in consequence of meeting with cases in which the globe of the eye and the conjunctiva were protruded in a manner not satisfactorily explained by reference to any previously described structure. He believes these to have been cases of inflammation of this tunic, with effusion between its deep surface and the globe of the eye.

Mr. O'Ferrall believes that "the uses of this tunic are to present a smooth surface, facilitating the movements of the eye; and by its density and tension, to protect it from the pressure incidental to the swelling of its muscles during their action. That the openings in this

tunic perform the office of pulleys, giving a proper direction to the force exerted by the muscles,—securing the motions of rotation, and opposing those of retraction, which would otherwise predominate."

Action of the muscles.—The action of the *levator palpebræ* muscle is to raise the upper lid, and thus to expose the anterior part of the eye-ball. In this action it is an associate of the frontal portion of the occipito-frontalis, and an antagonist of the orbicularis palpebrarum. Sir C. Bell* affirmed that the action of the levator palpebræ is not simply that of raising the upper lid, but that the swelling and tension of the muscle during its action have the effect of pushing forwards the eye-ball, thus causing the lower lid to slide off the convex surface of the eye, and to be depressed whilst the upper lid is elevated. There is no proof of any such action of the levator palpebræ, and it seems improbable that it should exert any such influence, separated as it is from the eye-ball by the superior rectus, by a considerable quantity of fat and by the "tunica vaginalis." The result of paralysis of this muscle is a drooping of the upper lid, to which the term *ptosis* is applied.

It is evident from an examination of the origin, course, and insertion of the *recti* muscles, that each of them acting singly is capable of making the eye-ball revolve in its own direction; the superior rectus directs the cornea upwards; the inferior rectus antagonises the superior and directs the cornea downwards; the external rectus directs it outwards and is antagonised by the internal, which draws the cornea inwards towards the nose. It is also evident that the action of any two contiguous recti muscles will give the cornea a direction intermediate between that which it would assume from the action of each of them singly; the superior and internal recti acting together will direct the cornea upwards and inwards, while the inferior and external will direct it downwards and outwards; so that the cornea may be made to assume any intermediate position by the action of the recti muscles alone.

The successive action of all the recti muscles would produce a movement of the eye-ball analogous to *circumduction* of a limb; and as the circumduction of a limb is a movement altogether distinct from rotation, so is this circumduction of the eye-ball entirely distinct from any rotation upon its antero-posterior axis. In circumduction the centre of the cornea describes a circle, whereas in rotation this point remains fixed, forming the anterior extremity of an imaginary axis, round which the circumference of the cornea revolves. It is of much importance to have a definite notion of each of these movements, as we shall thus avoid one source of confusion in considering the action of the straight and oblique muscles of the eye. Having thus defined rotation, no argument is necessary to prove that the recti muscles are incapable of producing such a movement; a glance at their direction

* Dublin Journal of Medical Science, July, 1841.

* The Nervous System of the Human Body, by Sir C. Bell.

and their position with regard to the eye-ball will at once determine this point. If then any such movement occurs, other muscles must be provided in order to effect it.

We now proceed to consider the action of the *oblique* muscles.

It may be well to remind the reader that, in all the vertebrate animals, these muscles have essentially the same direction and relations; the only difference being that in fishes, reptiles, and birds, the superior oblique arises from the anterior part of the orbit, whence it passes backwards and outwards to its insertion; whereas, in Mammalia, it comes from the posterior part of the orbit and passes through a tendinous pulley before taking its course backwards and outwards; the action of the muscle will obviously be the same in both cases. One function which has been assigned to the oblique muscles, is that of antagonising the recti so as to prevent the retraction of the eye-ball within the orbit during the action of the latter muscles. To this conclusion Sir C. Bell asserts there are many objections: two of these objections we subjoin in his own words. "1. In creatures where the eye is socketed in a cup of cartilage and cannot retract, the oblique muscles are nevertheless present. 2. Where a powerful retractor muscle is bestowed in addition to the recti muscles to pull the eye-ball back, the oblique muscles have no additional magnitude given to them to pull the eye-ball forwards." Now we must not suppose that the antagonism exerted by the oblique muscles is such as to oppose the conjoint forcible action, or active contraction, of all the recti muscles, and of a retractor when such a muscle exists. If such were the case, we should certainly find the development of the oblique muscles in some degree proportioned to that of the muscles they were intended to antagonise, and a cup of cartilage at the back of the eye-ball would apparently supersede the necessity for any antagonism on the part of the oblique muscles; but the kind of antagonism which the oblique muscles probably exert upon the recti is equally necessary whether the eye-ball be encased in cartilage or supplied with a retractor muscle. It is simply the same kind of antagonism which the muscles on the opposite sides of the face exert upon each other. Paralysis of the *portio dura* on one side is attended with a traction of the features to the opposite side; this results from the ordinary tonicity or passive contraction of the muscles on the one side, unopposed by the corresponding force on the other; the distortion is generally conspicuous enough when the muscles are at rest, but when they are thrown into active contraction it becomes still more marked, and the movements of the sound side are unsteady and oscillating. During the healthy state then the symmetry of the features is maintained by this antagonism of the muscles on opposite sides of the face. In like manner when the muscles are at rest, the eye-ball is kept delicately balanced between its six muscles; the superior rectus opposes the inferior, and the external opposes the internal, while

the *obliqui* are opposed to each other, and the recti conjointly are antagonised in their retracting tendency by the opposite force of the *obliqui*. This is the condition during a state of rest, when the contraction of all the muscles is merely that of their ordinary tonicity or passive contraction. Now, suppose one straight muscle to be thrown into a state of voluntary active contraction; immediately the cornea is directed towards that muscle, the antagonism of the other five muscles serving the important purpose of preventing any irregular oscillatory movement of the eye-ball; when the contraction of that muscle ceases, the eye is at once restored to its original position. One of the uses of the oblique muscles then is by their antagonism of the recti to assist in preventing any unsteady motion of the eye-ball. This, however, is by no means the only or the chief use of the oblique muscles, and the question arises, what movements of the eye-ball are effected by the contraction of these muscles? Upon this subject the most contradictory statements have been made; on the one hand Semmerring, Cloquet, and Harrison assert, that the superior oblique directs the pupil downwards and inwards, the inferior oblique moves it upwards and outwards; on the other hand, according to Müller, Monro, and Sir C. Bell, the superior oblique directs the pupil downwards and outwards, the inferior oblique upwards and inwards. All these anatomists agree in supposing that the oblique muscles effect what we have called circumduction of the eye-ball, but their disagreement as to the direction in which circumduction occurs under the influence of these muscles, is of itself an argument against the probability of any such movement being produced by them. We have before stated that the recti muscles are of themselves capable of circumducting the eye in all directions; this was admitted and proved experimentally by Sir C. Bell. He "cut across the tendon of the superior oblique muscle of the right eye of a monkey. He was very little disturbed by this experiment, and turned round his eyes with his characteristic inquiring looks, as if nothing had happened to affect the eye." In another experiment he "divided the lower oblique muscle of the eye of a monkey. The eye was not, in any sensible manner, affected; the voluntary motions were perfect after the operation." The result of these experiments appeared to Sir C. Bell to confirm the opinion which he entertained that the oblique muscles perform certain involuntary movements, such as the forcible elevation of the cornea under the upper lid when the eye is irritated, and the rolling of the cornea under the lid when the eye is closed. He appears anxious to prove that the fourth nerve presides over the upward movement of the eye-ball which he says occurs during sneezing and certain other respiratory movements; but as he has previously stated that the superior oblique to which the fourth nerve is distributed turns the eye downwards and outwards, in order to reconcile the two views he says, "if we suppose that the influence of the fourth nerve is,

on certain occasions, to cause a relaxation of the muscle to which it goes, the eye-ball must be then rolled upwards.*

Sir C. Bell adduces no proof that the involuntary movements which he mentions are performed by the oblique muscles; on the contrary they may all be effected by the straight muscles. The fact that these movements are involuntary is no argument against their being produced by muscles, which under ordinary circumstances are strictly voluntary. Thus, Sir C. Bell says, when the eye is exposed and irritated, the cornea is directed upwards to a greater extent than can be done by a voluntary effort. This probably is the case, but we need not have recourse to the oblique muscles in order to explain it. Under the influence of the irritation applied to the eye the superior rectus contracts violently in order to elevate the cornea beneath the upper lid, and thus to remove it from danger; precisely in the same manner under the irritating influence of strumous ophthalmia the orbicularis muscle contracts with a spasmodic force much exceeding that of any voluntary contraction of that muscle. Both oblique muscles have the striated structure of voluntary muscles, and the inferior oblique receives a branch from the third nerve, all the other muscles supplied by which are known to be voluntary in their action. We may, therefore, dismiss the idea that the oblique muscles are specially concerned in producing the involuntary movements of the eye.

Further, it is our firm conviction that the oblique muscles are in no way concerned in circumduction of the eye-ball; that they neither abduct nor adduct, neither raise nor depress the cornea, nor do they produce any of the intermediate movements. The following are the circumstances which appear to us to favour this conviction. 1st. Both oblique muscles pass outwards almost at right angles with the recti muscles, and are inserted close upon a line intermediate between the anterior and posterior half of the eye-ball: this direction and insertion are evidently most unfavourable for the production of any of the above-mentioned movements. 2d. Those who assert that the oblique muscles have the power of circumducting the eye make the most contradictory statements as to the direction which the eye assumes under their influence. These opposite statements are sufficiently accounted for when we consider that they are founded on the results of traction on the oblique muscles after death, when the fat and other parts in the orbit have become firm and unyielding, and the steadying influence arising from the antagonism of the other muscles has ceased. 3d. The recti muscles are of themselves capable of circumducting the cornea in all directions; this is evident from their direction and insertion, and was proved by Sir C. Bell's experiments

above-mentioned. 4th. There is an important movement of the eye-ball which can be effected by no other than the oblique muscles, and for the production of which in all probability these muscles are provided: the movement to which we refer is rotation of the eye upon its antero-posterior axis.

The true use of these muscles we believe to have been pointed out by John Hunter in a paper on the use of the oblique muscles, in his "*Observations on certain Parts of the Animal Economy.*" He first explains that for perfect vision it is essential that when we are examining an object, any motion of the object or of our own bodies should be so counteracted by the movements of the eye-ball that the image of the object may be kept on the same point of the retina, and not be allowed to move over its surface. We have a familiar illustration of this when we keep our eyes motionless and fixed on the ground, while moving rapidly in a carriage; the surface of the road appears confused and the stones arranged in lines, as their images pass rapidly over the retina: it is only when we allow the eye to follow these objects that we have a distinct perception of any of them. Hunter then goes on to explain the use of the oblique muscles. "To prevent any progressive motion of the object over the retina of the eye, either from the motion of the object itself, or of the head in some motions of that part, the straight muscles are provided, as has been explained; but the effects which would arise from some other motion of the head, as from shoulder to shoulder,* cannot be corrected by the action of the straight muscles, therefore the oblique muscles are provided. Thus, when we look at an object and at the same time move our head to either shoulder, it is moving in the arch of a circle whose centre is the neck, and, of course, the eyes would have the same quantity of motion on this axis if the oblique muscles did not fix them upon the object. When the head is moved towards the right shoulder the superior oblique muscle of the right side acts, and keeps the right eye fixed on the object, and a similar effect is produced upon the left eye by the action of its inferior oblique muscle. When the head moves in a contrary direction, the other oblique muscles produce the same effect."

If we again consider the direction and insertion of the oblique muscles, it is evident that they are intended for the office which Hunter has assigned them. Passing outwards, one above, the other below, in a direction almost at right angles with the antero-posterior axis of the eye-ball to their insertion near its middle, their action must obviously be to rotate the eye upon that axis. The reason of their obliquity probably is that their direction backwards as well as outwards, by enabling them to antagonise the straight muscles, more certainly se-

* See Sir C. Bell on the Nervous System, p. 177. This supposition appears to us as unphilosophical as the old theory of Phlogiston, which, in order to explain the fact of a body becoming heavier when deprived of this imaginary agent, attributed to phlogiston a property of lightness.

* The motion here meant is that which is effected by flexion of the neck laterally, so as to approximate the ear to the shoulder, not that movement which takes place between the first and second cervical vertebrae.

cures the delicate suspension of the eye-ball when the muscles are at rest, and a steady movement of it when any of them are thrown into action. We have the following experimental evidence to offer in support of the statement which Hunter has made. A dog was killed by the injection of air into a vein, and immediately the inferior oblique muscle was exposed by dissecting off the conjunctiva, without in any way interfering with the surrounding parts; by means of two fine wires a slight electric current was then directed through the muscle. The effect was a rapid rotation of the eye upon its antero-posterior axis, so that a piece of paper placed at the outer margin of the cornea passed downwards and then inwards towards the nose. The superior oblique was then exposed at the back of the orbit, and was treated in the same manner. The rotatory movement produced was precisely the reverse of the former; the paper at the outer margin of the cornea passed upwards, and then inwards towards the nose. In the case of the superior oblique the movement was less extensive, the irritability of the muscle being less, perhaps from the delay in exposing it, and from some slight injury inflicted on it in so doing. There could be no doubt as to the direction of the movement in both cases; there was not the slightest appearance of elevation, depression, abduction, or adduction of the cornea. This experiment was witnessed by Dr. Todd and Mr. Bowman. The experiment was subsequently repeated on another dog with precisely the same result. The superior oblique in the second experiment did not contract so vigorously as the inferior, but the movement it produced was the same as in the first experiment; and when gentle traction was made in the posterior part of the muscle, the rotation of the eye was very decided, and in a direction the reverse of that in which it rotated under the influence of the inferior oblique; again there was not the slightest movement of circumduction. There can be no doubt that the function of these muscles is the same in all animals in which they exist; and any experiments to determine their use must be more satisfactory when performed on animals immediately after death than in the human subject at a considerable period after death, when the fat and muscles have become equally firm and unyielding. Under such circumstances it is evident that the results of traction upon the muscles cannot be relied upon as accurate. It is remarkable that this rotation of the eye should have excited so little attention; since, if we only recognise the existence of such a movement, the use and necessity of the oblique muscles must be acknowledged, it being evident, as we have previously stated, that the straight muscles are incapable of effecting it.

Consensual movements of the two eyes.—

Upon this subject we subjoin the following extract from Müller: *—“There is an innate tendency and irresistible impulse in the corresponding branches of the third nerve to asso-

ciate action; while in the sixth nerve, not only is this tendency absent, but the strong action of one of these nerves is incompatible with the action of the other. These innate tendencies in the third and sixth nerves are extremely important for the function of vision, for if, in place of the sixth nerves, the external recti muscles had received each a branch of the third nerve, it would have been impossible to make one of these muscles act without the other; one eye, for example, could not have been directed inwards while the other was directed outwards, so as to preserve the parallelism or convergence of their axes, but they would necessarily have diverged when one rectus externus had been made to act voluntarily. To render possible the motion of one eye inwards while the other is directed outwards, the external straight muscles have received nerves which have no tendency to consensual action. In consequence, however, of the tendency in the two internal straight muscles to associate action, it is necessary, when one eye is directed inwards and the other outwards, that the contraction of the rectus externus of the latter should be so strong as to overcome the associate action of the rectus internus of the same eye; and in the effort to direct one eye completely outwards we actually feel this stronger contraction of the external rectus.”

It is certainly contrary to our general notions of the skill and economy of nature to suppose that she would so clumsily construct and endow the muscles and nerves of the eye, that in order to direct one eye outwards the external rectus muscle must struggle with and overcome the internal rectus of the same eye in consequence of this “irresistible impulse in the corresponding branches of the third nerve to associate action.” Doubtless the generality of those who have no theory to support will acknowledge that in directing the eye outwards they are unconscious of any such struggle between opposing muscles as is here supposed, and that abduction of the eye is attended with as little effort as either its elevation or depression. There is then no such irresistible tendency to associate action between the branches of the third nerve supplied to the internal recti muscles. Both internal recti muscles may be made to act at the same time, and thus to produce a convergence of the optic axes; and this being an unnatural position of the eyes is attended with a considerable and a painful effort, each internal rectus having to overcome the external rectus of the same eye, which has a tendency to consensual action with the external rectus of the other eye. That the external rectus must have the advantage in any struggle between it and the internal rectus is evident from the greater thickness and consequent strength of the former muscle. The only muscles supplied by the third nerve in which this tendency to consensual action is irresistible, are the superior and inferior recti of both eyes; we cannot possibly raise one eye without at the same time raising the other, nor can we depress one eye without a corresponding movement of the other. Then, as we have seen, there is no tendency to

* Physiology, by Dr. Baly, p. 99. ;

consentaneous action between the branches of the third nerve supplied to the internal recti muscles, and it is only by a considerable effort that they can be made to act together; whilst the branches of the same nerve supplied to the levatores palpebrarum, which for the most part act consentaneously, may by a very slight effort of the will be made to act separately; but few persons experience any difficulty in opening one eye while the other is closed. Again, the tendency to consentaneous action between the internal rectus supplied by the third nerve and the external rectus supplied by the sixth nerve, as well as between the inferior oblique supplied by the third nerve and the superior oblique by the fourth, is as irresistible as that between the superior and inferior recti of the two eyes. We see then that all the muscles supplied by corresponding branches of the third nerve have not this tendency to consensual action, and two muscles supplied by the third nerve act consentaneously with two other muscles supplied by the fourth and the sixth nerves respectively.

For the maintenance of the parallelism between the axes of the two eyes, it is evidently necessary there should be a consentaneous action of the superior recti as well as of the inferior recti; it is also necessary that the internal rectus and the inferior oblique of one eye should act with the external rectus and the superior oblique of the other; but it is by no means evident why it is necessary, in order to effect this, that the external rectus and the superior oblique should each have a nerve specially provided for them. We must not suppose we are explaining the necessity for this arrangement by asserting that "if in place of the sixth nerves, the external recti muscles had received each a branch of the third nerve, it would have been impossible to make one of these muscles act without the other," because, as we have seen, there is no such irresistible innate tendency in *all* the corresponding branches of the third nerve to consentaneous action. Assuming that the use of the oblique muscles is such as we have mentioned, it is certainly curious to observe that when corresponding muscles of the two eyes are intended to act together, as the superior rectus of one eye with the superior rectus of the other, and the same with the inferior recti, both muscles are supplied by the third nerve, but the external rectus which acts consentaneously with the internal rectus of the opposite eye has a separate nerve, the sixth, and the superior oblique, which acts with the inferior of the opposite eye, has the fourth nerve entirely devoted to it.

There is one other phenomenon to which we may briefly allude, namely, the *adaptation of the eye to distances*. This will be found fully discussed under the article *VISION*; but it deserves a passing notice in this place, since one hypothesis by which an attempt has been made to explain it is that a change is effected in the form of the eye by the action of its external muscles, some writers attributing the influence in question to the recti muscles, and others to the obliqui. It seems by no means improbable that the action of both sets of muscles at the

same time might have the effect of increasing the antero-posterior diameter of the eye-ball, and thereby of adapting it for vision at small distances. The following experiment seems to favour the notion that there is some muscular action in the adaptation of the eye to vision at very small distances.

Place a printed page closer to the eyes than the natural focal distance, and merely look upon the letters without making any effort to read them; they appear confused and indistinct; then by a considerable voluntary effort which cannot be long sustained, and which is attended with some pain, we may so adjust the eyes that the letters appear perfectly distinct and legible. This subject is attended with great difficulties, indeed it is scarcely possible to determine the precise mode in which adaptation is effected; the hypothesis we have now mentioned appears at least as probable as any other; it is, however, open to objections. The state of adaptation of the eye is often entirely changed in a very short time by the local action of narcotics, which at the same time dilate the pupil, and this change is effected without any apparent influence over the voluntary contractions of the muscles. Most observers state that the eye is rendered long-sighted (presbyopic), while others have experienced an opposite result. Müller has recorded the results of the application of belladonna to his own eye; the general effect was to render the eye presbyopic, but the capability of adaptation was not destroyed by it. When the solution of belladonna was applied to one eye both eyes were affected, but in different degrees, so that both eyes could not be adapted to distinct vision of the same object at the same moment. These effects were attended with great dilatation of the pupil, and inasmuch as they were probably in some way dependent on this, they are opposed to the hypothesis that adaptation is effected by any action of the external muscles.

(G. Johnson.)

ORGANIC ANALYSIS.—Under the term organic analysis are included the various methods of discovering the constituent parts of substances, formed either directly by the vital actions of organized beings, or indirectly by subjecting the products of such actions to the further operation of re-agents. To treat the subject in its full extent would, however, be foreign to the purpose of the present article, in which I shall confine myself to the analysis of the products of animal life, and particularly of those combinations liable to be met with in the human frame.

In this analysis two distinct objects present themselves: the first consists in the determination of the proximate principles which enter into the constitution of the substance to be analyzed, and the second in the discovery of the elementary composition of the different proximate principles.

I shall therefore in the first place describe the various means by which we recognize the occurrence of the more important proximate animal principles, and determine as far as we

are able the quantities in which they may be present: this portion of the subject I shall conclude with a brief sketch of the general method of analysing the principal secretions in the healthy and more ordinary morbid conditions,—for more ample details I must refer to the articles specially devoted to the history of each secretion. I shall then, in the second place, proceed with an outline of the processes best adapted to the ultimate analysis of organic bodies in general.

To the pathologist the first of these objects is the most important, and it is he alone who possesses the extensive facilities requisite for investigating the different varieties exhibited by the secretions in disease, whether these varieties present themselves in the undue prevalence of one or more of the proximate principles, the undue deficiency of any of them, or the unusual occurrence of any of them among the secretions, or in the tissue of particular organs. The value of such information to the enlightened practitioner is sufficiently evident, for an accurate and ready mode of appreciating these changes not only affords him some of the most unerring indications of the nature and progress of disease, but enables him likewise to appreciate the effects and influence of the remedial measures that he may think it needful to adopt. To the chemist, on the other hand, belongs more appropriately the task of determining what ought to be considered as really proximate principles, of insulating them in a pure state, and finally of ascertaining their elementary composition by ultimate analysis.

In every case, before proceeding to analysis, it is desirable, nay, in the present state of science almost necessary, to subject the material to a careful microscopic examination; for although this does not of itself suffice to determine the chemical nature of the substances with which we have to deal, it yet furnishes us with the most important preliminary information we can acquire, and is frequently, owing to their close chemical relationship, the only means of ascertaining what is the form of the azotised constituents of the body with which we have to do. In truth, unless a chemist be likewise in some degree acquainted with the resources placed at his disposal by the microscope, he is but half fitted for the task of organic analysis.

For the necessary information respecting the minute structure of the different products of animal organization, I must again refer to the various articles on the subject in different parts of this work. (See BLOOD, CHYLE, MILK, MUCUS, PUS, SALIVA, URINE, &c.)

I.—PROXIMATE ANALYSIS.

As the limits of this article preclude the possibility of my entering into detail upon the ordinary operations of analysis, a task happily rendered unnecessary by the excellent manuals we possess on the subject, I shall limit myself to a few remarks on processes connected more immediately with organic analysis.

It is needless here to insist upon the importance of scrupulous attention to the purity of the re-agents employed, as it is a precaution sufficiently obvious. These re-agents are few in number: sulphuric, nitric, hydrochloric (or

muriatic), and acetic acids, solutions of potash, ammonia, and carbonate of ammonia, alcohol, and ether, constitute the most important; if to these we add solutions of

Chloride barium,	Acetate lead,
Nitrate silver,	Subacetate lead,
Oxalate ammonia,	Sulphate copper,
Phosphate soda,	Sesquichloride iron,
Ferrocyanide potassium,	Bichloride platinum,
Alum,	Tincture galls,
Lime water,	Hydrosulphuret ammonia,

with a blowpipe, platinum foil, spirit-lamp, forceps, test-tubes and a stand for them, a few watch-glasses, evaporating dishes and Florence flasks, a retort stand, funnels of different sizes, filtering paper and some lipped glasses, with pieces of glass rod and strips of window glass, we shall be tolerably well prepared for the operations of proximate analysis. Of course distilled water must always be employed in analytical enquiries.

For proximate analysis scales weighing 2000 grains and turning with $\frac{1}{10}$ th of a grain, when fully loaded, will be sufficient; but for ultimate analysis they should be sensible to $\frac{1}{100}$ th of a grain when each pan carries 1000 grains.

When the weight of a dry residue is to be ascertained, the object is attained with most accuracy by first counterpoising the vessel when empty, and then determining the increase of weight after the desiccation is completed.

The desiccation of all organic substances is best performed, where practicable, in the exhausted receiver of an air-pump, over sulphuric acid, by Leslie's process: a flat dish of oil of vitriol is placed on the plate of the pump, and the substance to be dried supported above it in a basin by a triangular framework of wire; the air is exhausted, and care taken to maintain a good vacuum; the residue thus procured is always much purer and whiter than that furnished by any other means, but it is a tedious and circuitous process, and requires ten days or a fortnight for its completion. Upon this account, and for other reasons, this method cannot generally be adopted. The plan which, next to it, presents the fewest objections, consists in evaporating by a steam or water heat, so that the temperature can never exceed 212° Fahr. Various methods may be resorted to for effecting this object; by placing one basin within another containing water, an extemporaneous bath is procured; but the end is more conveniently attained by the employment of a shallow box of copper, zinc, or tin plate, in the top of which are half-a-dozen circular apertures of different sizes with projecting vertical rims, upon which lids may be fitted when not in use; any vessel to be heated is placed over one of these apertures, and the temperature maintained by oil, gas, or sand heat.

Perfect desiccation is essential to accuracy, and from the destructible nature of some organic compounds, especially under the combined influences of atmospheric oxygen and an elevated temperature, it is dangerous to effect it by heat and difficult by any other means. In some delicate experiments the following plan,

which combines the application of moderate heat with Leslie's method, already described, may be advantageously employed, though the manipulation is rather complicated and troublesome. In a counterpoised retort which will sustain exhaustion, a given weight of the substance to be dried is placed and connected with a tubulated receiver containing oil of vitriol, by a sound cork secured on the exterior with several folds of bladder, well soaked before applying it. Through the tubulure of the receiver passes a small glass tube. This junction likewise is rendered air-tight, with a cork and bladder. The tube, about an inch from the tubulure, is, previous to its insertion, drawn out and narrowed to a capillary bore, so that at pleasure it may be easily drawn off and sealed by a jet of flame from the blowpipe. Matters being thus arranged, the tube from the receiver is united by a connector of caoutchouc with another tube, and this again with the air-pump, and exhaustion is performed. When a sufficient vacuum has been produced, the whole is allowed to stand for an hour. If, at the end of that time, the mercury in the gauge retain its level, the apparatus is air-tight and may be detached from the pump by sealing the tube proceeding from the receiver in its capillary portion. We may now apply a gentle heat to the bulb of the retort by means of a water bath, or otherwise, and can cool the receiver. Great caution is of course requisite in handling the exhausted vessels, as the slightest abrasion of the surface might cause fracture.

In some cases, as in drying blood, a temperature of 230° may be safely used by employing a boiling solution of Rochelle salt as the exterior bath; and in the analysis of the bile a heat of even 260° is recommended by Berzelius. Where sugar or urea is present, even a heat of 200° is injurious, and must therefore be avoided. The operation we are now considering appears one of the simplest that the chemist can have to perform, but I have been induced to dwell the longer upon it as it is one from which, without great care, more mistakes arise than from any other, owing to the pertinacity with which water adheres to most organic substances. The temperature attainable in an open basin over the water bath is much lower than we should, *à priori*, have been led to imagine. I found, for example, that the temperature of some wheat flour thus drying in an open basin was only 144° F., whilst the water in the bath continued steadily at 196° F. When the basin was covered with a piece of paper, a temperature of 161° F. was the highest attained, while a thermometer placed in the water of the bath stood at 194° F. With liquids evaporating it rises somewhat higher; when plain water was evaporated it stood at 164°, the water in the bath being 208°; and in the case of a viscid fluid like yeast, it varied between 176° and 180°, while the bath raised a thermometer inserted in it to 210°.

It is therefore desirable to have an apparatus in which we can ensure any given temperature from 212° upwards. For this purpose Liebig has contrived a kind of hot-water oven,

consisting of a double box of copper; in the interval between the outer and inner walls, water, saline solutions, or oil, may be poured and heated in the usual way. In one side of this box is a door which may be closed when necessary. The interior chamber and its contents can thus be maintained with certainty at the same temperature as that of the fluid around them. The best plan of proceeding consists in evaporating liquids to apparent dryness upon the open water bath; and afterwards subjecting the solid residue, when a temperature of 212° is not injurious, to complete desiccation in Liebig's oven. So long as the material under examination loses weight, the application of heat must be continued.

Capsules of Wedgewood ware or Berlin porcelain are indispensable, and one or two small platinum dishes will be found most valuable, especially in the evaporation of albuminous fluids, as the dry residue adheres so strongly to the glaze of earthen vessels that a portion of the basin is invariably removed along with the animal matter, which thus acquires an undue increase of weight, and the surface of the vessel becomes rough and unfit for use from the difficulty of cleaning it. The Berlin porcelain crucibles are excellent vessels for evaporation, as, being fitted with covers, the dry residue may be preserved from absorbing moisture during the operation of weighing, by exposure to air. It may be worthy of notice that adhering organic substances may be removed from the surface of vessels in which they have been kept, by digestion in concentrated nitric or sulphuric acid, or else by strong solution of potash.

Incineration of the dry residue is accomplished by taking a counterpoised porcelain or platinum capsule with a determinate quantity, say 10 or 12 grains, of the material to be burned, and heating it over a circular wicked spirit-lamp until the ash completely loses its black colour. The capsule should at first be covered to prevent loss by dispersion on the first application of heat; when visible fumes cease to arise, the cover may be removed to allow freer access of air; as, however, the temperature rises higher when the vessel is covered, it will often be found advantageous to leave it loosely covered and maintain a steady heat; sufficient air finds access to consume the carbonaceous matter. Sometimes the ash may be stirred carefully with a platinum wire in order to expose it more fully to the air. When the ash contains alkaline phosphates, the last traces of carbon are burned off with difficulty, as the phosphates fuse and protect the unburned particles from the further action of the air. This inconvenience may be overcome by moistening the residue (after the capsule has been allowed to cool) with a few drops of nitric acid, and again igniting, repeating this manœuvre as often as may be necessary. A new difficulty, however, arises when chlorides are present, as is almost always the case; for at a high temperature these salts are decomposed by nitric acid, and the residue therefore appears to contain less chlorine than is really combined with it.

As the alkaline chlorides are, moreover, not completely fixed at a red heat, some loss is not unfrequently sustained by a long continued ignition. We may dispense with the employment of nitric acid and avoid loss from volatilization by shortening the period during which a high temperature is kept up, and simply charring the mass at a low red heat so as to destroy all organic matter; the black residuum is then digested in water, by which the alkaline salts dissolve, and after well washing, a little weak nitric acid is employed to remove the earthy compounds; charcoal alone remains undissolved. By evaporation of the solutions the amount of saline matter is ascertained.

Filtration may be performed on good white unsized blotting paper cut of a size to drop completely within the funnel; before pouring in the fluid to be cleared, the filter should be moistened, if the solution be aqueous, with water; if alcoholic or ethereal, with a few drops of alcohol or ether, as the case may be. In order to ascertain the quantity of dry residue, the preferable plan is to employ two filters previously counterpoised one against the other, and to insert one into the other; the excess of weight the inner filter shews when the filtration is complete, after both have been carefully dried on the water-bath, will furnish the quantity of solid matter. To render the filtration more rapid, the apex of the outer filter may be cut off so as to leave only one thickness of paper at the point. Occasionally we may weigh the filter itself and mark its weight in pencil upon it; the objection to this plan consists in the difficulty of obtaining the paper always at the same point of dryness. It should be first dried at 212°F., placed in a light covered capsule over sulphuric acid, and allowed to cool, then weighed whilst covered from the air. The same care must be observed on again weighing it with the precipitate. Of course in washing an organic precipitate, the same precautions will be required as when proceeding with the analysis of a mineral. The stream of washing liquid should be specially directed to the edges of the filter, which may be known to be sufficiently washed, when by the evaporation of a drop of the liquid which passes through on a slip of glass, no perceptible stain is produced.

Whenever *decantation*, or pouring off from the sediment, can be substituted (as it very frequently may in alcoholic and ethereal digestions) for filtration, it is to be preferred, as some loss is unavoidably occasioned by every filtration; whereas by decantation the precipitate may be dried in the vessel, and if this have been previously counterpoised we can ascertain the weight of adhering matter with great exactness. By this method the precipitate may be as perfectly washed as when filtration is adopted; the fluid may be poured off very close to the solid matter, which may again be diffused through a fresh portion of washing fluid, again allowed to subside, and the washing repeated as often as may be necessary. In pouring a fluid from one vessel to another, loss is avoided by moistening a glass rod in the

liquid, bringing it into contact with the lip of the glass or basin, and pouring the liquid down this rod, which is not removed until the side of the vessel is nearly restored to the vertical position; by observing this precaution we escape the risk of losing any portion from its running down the outside of the vessel. The drops adhering to the rod are washed into the rest of the solution.

The animal substances that we have to examine naturally arrange themselves into fluids and solids, and as this division is convenient in a practical point of view, I shall here adopt it, beginning with those presented to us in a fluid state.

In order to fix some definite limit to our enquiries, those principles only will here be noticed, which, from the frequency of their occurrence or their importance as constituents or products of the living frame, are most likely to be the special objects of attention to the physician and pathologist. In this number among the fluid products I shall enumerate fibrin, albumen, casein, fatty matters, urea, sugar, the uric, urobenzoic, lactic, and oxalic acids, mentioning a few other compounds, as ptyalin, sulphocyanic acid, &c. &c., when describing the general plan of analysing the secretions in which they most commonly occur.

A. ANALYSIS OF ANIMAL FLUIDS.

When an animal fluid is presented for analysis, it is necessary in the first place to acquire a knowledge of the ingredients which enter into its composition in order to be able to decide upon the best method of ascertaining their proportions. The means of determining the nature and quantity of the organic constituents will be first described, leaving the saline matters for a subsequent section.

1. For the organic constituents.

It is possible that all the principles just enumerated may occur together; this, however, will very rarely happen unless we have to examine the contents of the stomach, when a still more heterogeneous mass may be presented to us.

Having, where practicable, taken the specific gravity of the liquid in order to acquire an idea of its degree of concentration, we place a portion under the microscope, and are thus enabled at once to decide upon the presence of blood globules, pus globules, fatty or oily matters in suspension, the debris of tissues, crystals of various substances, as uric acid, cholesterin, &c., and may then pass to tests purely chemical for its

Qualitative analysis.

a. By allowing the liquid to stand at rest for a few hours, we at once determine the presence of *fibrin*, which coagulates and separates spontaneously, at the same time enveloping the red globules and suspended particles in its meshes.

b. The clear liquid is heated to boiling; if *albumen* be present it coagulates, unless the solution be alkaline, when the addition of a few drops of nitric acid causes an immediate curdling. A drop or two of acetic acid added to

the original liquid, if it produce coagulation, shews the presence of *casein*. We need not seek for casein if the fluid shews an acid reaction, as it is coagulated by free acids in general. If *mucus* be present, some ambiguity may arise from the action of acetic acid, as this re-agent causes the coagulation of the mucus furnished by the alimentary canal and its appendages. When present, however, in appreciable quantity, mucus always communicates to the fluid a certain degree of ropiness which leads us to suspect its presence. A confirmatory test for casein under such circumstances consists in adding a few grains of milk sugar and a little washed rennet; if the mixture be heated for an hour or two to about 120°, the casein coagulates completely.

c. Fatty matters and cholesterin are revealed by the microscope, and may be separated by evaporating the fluid to dryness, digesting the residue with ether and filtering; by spontaneous evaporation of the ethereal solution, they are left behind with their usual physical characters.

d. The presence of sugar is best discovered by mixing the suspected fluid with yeast and placing it in an inverted tube over mercury for twenty-four hours, at a temperature of from 70° to 80° F., making at the same time a comparative experiment with an equal bulk of the same yeast diluted to the same extent with pure water. We cannot by yeast determine with certainty the presence of sugar in a proportion less than $\frac{1}{300}$ th of the liquid employed. A much more delicate test, and one which furnishes more immediate results, has lately been proposed by Trommer, founded upon the fact that organic bodies, to which free alkali has been added in excess, and especially solutions of grape and milk sugar, dissolve freshly precipitated oxide of copper; when the saccharine solutions are boiled they are decomposed, and sub-oxide of copper is deposited of a characteristic reddish brown colour. To apply this test, add to the suspected liquid a few drops of solution of caustic potash, so as to render it distinctly alkaline, then a small quantity of a dilute solution of sulphate of copper, agitating to dissolve the precipitate; a liquid of a blue colour varying in intensity with the quantity of copper held in solution is obtained. Apply heat, and if sugar is present an ochre yellow or red precipitate of sub-oxide takes place, as soon as ebullition begins. I have already mentioned that the presence of milk sugar has the same effect as grape or diabetic sugar; other animal matters produce a similar change. It is, however, very delicate in its indications; a negative result therefore may be considered as decisive of the absence of sugar. If a precipitate occur, the presumption that we are examining a saccharine liquid ought always to be confirmed by recourse to the unequivocal expedient of fermentation. It is easy to concentrate the fluid if the sugar is very small in quantity; the only case in which any ambiguity can arise. *Sugar of milk* has never been found but in the secretion from which it derives its name.

e. Urea can only be discovered satisfactorily by evaporating the suspected fluid to dryness and treating the residue with alcohol, again evaporating this alcoholic solution to dryness, redissolving in water, and adding nitric or oxalic acid with the precautions to be mentioned hereafter when treating specially of the determination of urea. When common salt is allowed to crystallize from a moderately dilute solution of urea, the form of the crystals is modified, and instead of obtaining cubes or octohedra the crystals developed assume a more or less penniform appearance, often shewing the figure of a Maltese cross with serrated edges. These modifications have been proposed as a test of the presence of urea: they are not, however, certain indications, though useful as affording a presumption of its presence. When a fluid which contains urea is concentrated by evaporation, and nitric acid is then added, by spontaneous evaporation on a glass plate we obtain lamellar crystals of nitrate of urea in irregular rhomboidal plates with the acute angles often truncated.

f. To detect the existence of uric acid and the urates, if albuminous principles are present, the liquid is evaporated to dryness, and the residue digested for some hours with solution of caustic potash, till every thing soluble has been taken up. It is diluted, filtered, and supersaturated with hydrochloric acid; a flocculent precipitate forms, which is redissolved by excess of acid; and the uric acid separates; this is collected on a filter. We are enabled by this process, where considerable quantities of uric acid are present, as in the excrements of birds of prey, to obtain results of considerable accuracy; but where the proportion of the acid is very minute, it cannot be relied upon for quantitative experiments; the residue in these cases must be subjected to microscopic examination. If no azotised matters are present, the mere addition of free hydrochloric acid after a lapse of some hours usually causes a separation of rhombic crystals of the acid; or by evaporating to dryness and treating the residue with water acidulated with hydrochloric acid, the uric acid remains undissolved; the residue is proved to contain this compound, either by the appearance of its crystals under the microscope, or by evaporating a small portion to dryness with nitric acid on a slip of glass, when a red stain is left; a drop of ammonia added produces a fine crimson; if this be evaporated to dryness, a drop of solution of caustic potash converts it into a beautiful purple, which is destroyed by the application of heat.

The methods for testing the other acids will be described when treating of their quantitative determination.

Having now obtained an idea of the nature of the fluid we have to examine, we are ready to proceed with its

Quantitative analysis.

A thin porcelain or platinum capsule is carefully counterpoised, and filled with a given weight of the fluid, usually 500 or 1000 grains.

This is evaporated to dryness in a water-bath. It is carefully weighed and the total solid contents determined; the loss indicates volatile matters consisting almost entirely of water. The residue is carefully incinerated with the usual precautions until all traces of carbon are removed: on weighing again we obtain the fixed saline constituents.

By these means we have determined

Water and volatile matters.

Organic matters and ammoniacal salts.

Fixed saline matters.

The quantity of each organic substance has now to be estimated. We have at present no absolutely exact method of determining all the ingredients from one portion only of a fluid; the following offers the nearest approximation.

a. Fibrin separates by spontaneous coagulation; it is washed and determined in the manner to be described hereafter.

b. If casein and albumen be both present, a given portion of the clear liquid is acidulated with a few drops of acetic acid, and evaporated to dryness in vacuo over sulphuric acid. The residue is digested with successive portions of water at 120°, as long as any thing dissolves; this residue is then dried upon a water-bath, pulverised, and treated with ether, by which all fatty matters are removed; casein alone remains behind. It is completely dried, weighed, incinerated, and the ashes deducted. This method of separating the casein is imperfect, as a portion of this substance generally redissolves on the addition of water. If uric acid be present, it will be found with the casein, which must be dissolved in solution of potash, diluted, filtered, supersaturated with acetic acid, by which the azotised matter at first precipitated is redissolved. Uric acid alone remains; it is collected on a weighed filter, and the quantity determined. It should always be tested by the microscope or by nitric acid.

c. The aqueous solution filtered from the casein, or the liquid for examination, if this principle be absent, is evaporated to dryness by a water-bath. If much fat is present, the residue is washed with ether to remove the greater part of the oily matter, then dried thoroughly, and powdered; an operation which, after the preliminary treatment with ether, may be effected without much difficulty. The pulverized mass is digested with ether, and the ethereal solutions, including that in which the casein was digested, are mingled and evaporated to dryness. Cholesterin, fatty matters, lactates, and a trace of urea are obtained; by digesting with water the cholesterin and fats alone remain and may be collected on a filter and weighed.

d. The residue, after digestion with ether, is treated with boiling water; the solution thus obtained may contain urea, sugar, sugar of milk, extractive and saline matters,—in short, every thing except the albumen, which is completely dried and then weighed. When no casein is present, the uric acid, if any, will accompany the albumen, and may be separated from it in the manner directed for its separation from casein.

e. The filtered liquid is evaporated to dryness and treated with a mixture of one part of anhydrous ether with two of absolute alcohol, by which urea, muriate of ammonia, lactates, the alcoholic extractive matters so called, and a small part of the sugar, are dissolved. The remainder of the sugar, sugar of milk, aqueous extractive matters, urates, sulphates, chlorides, and phosphates remain behind, forming residue (1).

f. The alcoholic solution is evaporated to dryness and weighed: the solid matter divided into two portions; one is dissolved in water acidulated with nitric acid, and treated with nitrate of silver, by which the chlorine is separated as chloride of silver, and hence the muriate of ammonia is determined; from the other portion we determine the quantity of urea by oxalic acid with the usual precautions. Having thus determined the weight of the muriate of ammonia and of the urea, we infer the deficiency to consist of a little sugar, lactates, and alcoholic extract.

g. The residue (1), which contains sugar, sugar of milk, watery extract, and salts, is boiled with proof-spirit as long as any thing is dissolved; the solution is evaporated to dryness, and if grape sugar be present, half the residue must be dissolved in water and fermented with yeast to determine the proportion of this substance, and its weight is deducted from the weight of the residue left on evaporating the spirituous solution; the other half residue is incinerated, and the quantity of saline matter ascertained; by deducting the weight of the sugar and salts we then obtain that of the sugar of milk, together with the alcoholic extract, from which we possess no exact means of separating it. It, however, very rarely happens that in the same fluid we meet with grape sugar and sugar of milk; the absence of sugar will obviously much simplify the method of proceeding.

h. The portion undissolved by proof-spirit is dried and weighed; it is incinerated and again weighed; the difference between the two weighings gives the quantity of watery extract.

This will be the general plan of operations if it be required to determine the quantity of each individual ingredient. From the number of operations required, and the destructible nature of the ingredients, the result, as already mentioned, is not rigidly accurate. Frequently, however, it is merely necessary to ascertain the proportion in which one substance only is found; the presence or absence of others being all that it is desired to know concerning them.

We proceed now to the special consideration of the different animal principles.

Fibrin.—Although the identity, in chemical composition, of fibrin, albumen, and casein has lately been strongly insisted on by Liebig and his pupils; yet, as in their physical properties at least, and in the offices they perform in the body, they differ considerably, it is frequently of great importance to determine the relative proportion of each in the fluids and secretions. These three principles occur both in the coagu-

lated and uncoagulated state. When coagulated, the separation of fibrin and albumen cannot be effected by any means with which we are acquainted, and, indeed, the first authorities differ when they attempt to decide which of the two they have to deal with, if they occur in the coagulated state. When uncoagulated, their separation and quantitative determination may be effected with considerable accuracy. Pure fibrin, when moist, is white and somewhat elastic, is insoluble in water, alcohol, or ether. It is readily taken up by strong acetic acid, and from this solution it is precipitated by ferrocyanide of potassium (prussiate of potash); fibrin also dissolves in solution of potash; if, when thus dissolved, it be heated gently and the liquid neutralized by an acid, a white flocculent precipitate occurs, which redissolves in excess of acid, and the solution emits an odour of sulphuretted hydrogen. Strong nitric acid turns fibrin yellow, forming a yellow solution with gradual evolution of gas; in concentrated hydrochloric acid it slowly dissolves with a rich violet colour. These are properties it possesses in common with albumen and casein; but it is distinguished from them and from all other animal matters by its spontaneous coagulation when removed from the living body. This furnishes us with a certain test of its presence when in the liquid form, and enables us to separate it in good degree from other bodies; within its pores, however, is obstinately retained a quantity of the fluid from which it has just separated itself, together with most of the globules and particles suspended in the secretion. It becomes necessary, therefore, to wash out these ingredients, an operation rendered possible by the insolubility of the fibrin in cold water. The coagulum from a known quantity of fluid is cut into very thin shreds by a sharp knife, tied in a piece of linen, and a gentle stream of water allowed to fall upon it; from time to time the clot is gently kneaded and the washing continued; in the case of blood, till all traces of colouring matter are removed, or, where no colour is present, so long as may be deemed necessary; the residue is then removed from the linen, dried, digested in ether to remove adhering fatty matters, again dried and weighed. A portion is then incinerated, the weight of the fixed matters determined and deducted from the gross weight of the dried fibrin, by which we obtain that of the organic matter.*

Fatty matters.—Several peculiar oily substances occur in the fluids and solids of the animal body. Among the saponifiable fats chemists have distinctly ascertained the presence of margarin, elain, and butyryn; besides these we have cholesterin and serolin, which are not saponifiable by boiling in alkaline solutions, and there are others containing phosphorus and sulphur, but their composition and properties are yet involved in uncertainty. Our

analytical processes for separating these bodies are very imperfect; the fats are all soluble in boiling alcohol, and still more freely in ether. Cholesterin and serolin may be isolated from the other fats by boiling the residue, after evaporation of the ether, with solution of caustic potash, as they remain undissolved by this menstruum, whilst the margarin, elain, and butyryn form soaps which are dissolved by the water.

Serolin is an azotised fat, which has hitherto only been found in the blood; it is readily distinguished from cholesterin by its fusing point being much lower, 97° F., whereas cholesterin does not melt below 278° , and is found in the blood only in minute quantity. By pressing them between folds of filtering paper we might therefore, if careful to maintain a temperature near that of boiling water, effect a tolerably complete separation of these bodies.

Butyryn rapidly absorbs oxygen from the air, setting free a volatile acid, the butyric; it possesses the peculiar odour of rancid butter, by which its presence is always easily recognized.

In analytical inquiries it is best to separate fatty matters by ether as the first step after the liquid has been evaporated to dryness; we may then safely proceed to determine the

Albumen.—In chemical properties it differs little from fibrin, excepting in the fact of its requiring heat or some chemical agent to produce coagulation; towards reagents it comport itself in the same way. When liquid, its separation from fibrin and fats is effected as just described. The residue, after the fats have been removed by ether, is digested in boiling water, and the residue well washed; the albumen remains upon the filter, and must be dried and weighed. A given quantity is incinerated to determine the proportion of saline matters, which must be deducted from the weight previously found. If uric acid existed in the solution, it would be mixed with the albumen. In case the colouring matter of the blood were contained in the fluid, a small part would remain mixed with the albumen, and might be removed by digestion in alcohol acidulated with sulphuric acid, by which the hæmotosin is dissolved; the greater part, however, subsides by allowing the liquid to stand undisturbed in a tall vessel for forty-eight hours. If the solution contain free alkali, a part of the albumen is redissolved on the addition of water; when, therefore, the filtered liquid presents an alkaline reaction, it should be very carefully and exactly neutralized by acetic acid, evaporated to dryness, and again treated with hot water; the weight of this second portion of albumen must be added to that first obtained. Casein hardly ever occurs in the same solution with albumen; if present, it would be separated by the acetic acid in the manner already described.

Casein is distinguished from albumen by its non-coagulability by heat; when its solutions are evaporated at a high temperature, an insoluble skin or film forms upon the surface, which is almost characteristic, the only thing

* It has been objected that the insoluble nuclei of the red particles are retained in this process. It is, however, superior, both in the accuracy of its results and the facility of its performance, to any other method hitherto proposed as its substitute.

with which it can be confounded being an alkaline solution of albumen, which resembles it in this and in some other particulars. Acetic acid in small excess causes its immediate coagulation; a great excess of the acid redissolves the coagulum. The fibrin, fats, and albumen having been separated in the manner already described, we may proceed to determine the casein by adding a few drops of acetic acid and evaporating to dryness. Boiling water removes from the residue every thing except saline matters and casein; this residue is dried, weighed, incinerated, and the salts deducted; a portion of casein is apt to redissolve in the water, so that this process is not perfectly accurate.*

Urea.—It is best, when practicable, to make a separate analysis for this principle; if this be impossible, we may proceed with the fluid from which albumen, casein, and fats have been separated, as already mentioned. In either case the liquid is evaporated to dryness, and the residuum digested with alcohol; we thus obtain a solution of urea freed from every thing except chlorides, sugar, some "extractive" matters, besides fats and lactates, unless previously removed by ether. The alcohol having been driven off, the residue is dissolved in sufficient water to produce a liquid of syrupy consistence. Colourless nitric acid is diluted till of a specific gravity of 1.25, which is a convenient strength for precipitating the nitrate of urea. The evaporating basin with the impure solution of urea is next placed in a vessel containing a frigorific mixture composed of 1 oz. of nitre, 1 of sal ammoniac, each finely powdered, and 4 oz. of water; when the basin and its contents have been thus cooled, colourless nitric acid, sp. gr. 1.25, rather more than equal in bulk to the solution of urea, is added drop by drop, stirring carefully; if added too quickly, the temperature rises, a little effervescence ensues, and part of the urea is decomposed. A flaky precipitate shows nitrate of urea; the whole is allowed to remain in the freezing mixture for three or four hours, or even longer; the nitrate of urea is then collected on linen, the linen is folded up, placed between several layers of filtering paper, and then subjected to strong pressure. The mother-liquor and excess of acid are thus almost entirely expelled; a slightly discoloured firm dry mass of nitrate of urea is procured, which may be exposed for some time to a temperature of 212°, and then weighed; 100 parts contain 48.78 of urea. The amount of impurity which this nitrate contains is usually very small, as is easily proved by ultimate analysis.

The nitrate of urea crystallizes in flat rhomboidal tables, is sparingly soluble in water, freely in alcohol even when cold, very slightly in pure ether. It is wholly volatilized by heat; when digested with carbonate of baryta suspended in water, effervescence ensues; on evaporating to dryness, exhausting

with hot alcohol and evaporating slowly, long prisms of urea are obtained.

Other methods have been proposed for estimating the urea, and when the proportion is small the substitution of oxalic for nitric acid furnishes results of greater accuracy; but the urea must then be separated by *absolute* alcohol instead of rectified spirit from its other accompaniments; the oxalic acid is rubbed to a thin cream with water, and a portion of this, equal in bulk to the syrupy solution of urea, is added to the liquid, which is gently warmed; it is then allowed to cool, and the whole immersed in the frigorific mixture. The crystals are drained on calico and subjected as before to strong pressure; the firm dry cake of oxalate of urea and oxalic acid is allowed to digest at a temperature of 100° F. for about eight hours, with rather more than its own weight of chalk and six or eight times its weight of water. Effervescence ensues, an insoluble oxalate of lime forms, and urea is dissolved; the solution is filtered and evaporated to dryness; long crystals of nearly pure urea form, from the weight of which the quantity is ascertained; they ought to dissolve completely in absolute alcohol; anything undissolved is oxalate of ammonia.

If the amount of urea be very small, as is sometimes the case with diabetic urine or the serum of the blood, Dr. Rees recommends the employment of ether instead of alcohol to the dry residue. Urea is very sparingly soluble in this menstruum and will be obtained with the fats; the ethereal liquid evaporated and the residue treated with water, filtered and again evaporated, furnishes long delicate prisms of urea; this process, however, must be regarded more as a test of the presence of urea rather than as a means of estimating its quantity. Sometimes urobenzoic (hippuric) acid occurs in diabetic urine, and it would then be extracted by ether along with the urea and crystallize with it; but it is easily separated and distinguished by the sparing solubility of its crystals in cold water.

Sugar.—It is best to take a separate portion of the fluid to determine the quantity of sugar. A jar, with its aperture ground smooth, graduated to tenths of a cubic inch, and capable of containing from 12 to 20 cubic inches, is turned with its mouth upwards and filled to within an inch or two of the top with mercury; from 100 to 200 grs. of the liquid for analysis is accurately weighed and transferred to the jar with the usual precautions; 8 or 10 grs. of yeast are introduced, and the jar accurately filled with water; the mouth is closed by a glass valve, which is retained in its place by a piece of linen or any other convenient means; the jar is inverted in a basin of mercury and the valve removed. The apparatus is set aside for two or three days in a temperature of about 70°, till the fermentation is complete. The quantity of gas is now accurately read off; the temperature of the room and height of the barometer carefully noted, as well as the difference between the level of the mercury within and without the jar. As the liquid will be saturated with

* Proof-spirit may be substituted for water as a solvent, but it leaves more animal extractive matter, though it dissolves less of the casein.

its own bulk of carbonic acid at the observed temperature and pressure, we must in our calculations add the bulk of the liquid to that of the gas actually observed. Having reduced the bulk of gas to the standard pressure of 30 inches and the temperature of 60° F., according to the rules given in all works on physics, we deduce the quantity of sugar, since 100 cubic inches of carbonic acid are furnished by the decomposition of 106.6 grs. of grape sugar.

If mercury be not at hand, we may, by adapting a tube containing chloride of calcium, and a bulb apparatus charged with strong solution of potash,* the weight of which is accurately known, to a tubulated retort, obtain a result of considerable accuracy. In a half-pint retort, so adjusted, 500 grs. of urine are placed, and 30 or 40 grs. of yeast added; through the tubulure of the retort a straight tube passes, and dips below the surface of the fluid; the upper extremity is closed by a cork. It is set aside to ferment at a temperature of 70°; the chloride of calcium retains the moisture, and the potash ley absorbs the carbonic acid; by the increase of weight we know the quantity of carbonic acid formed. As at the close of the experiment the apparatus will be full of carbonic acid, it must be displaced by removing the cork from the straight tube passing through the tubulure of the retort, and then gently drawing air through the apparatus for some minutes by careful suction at the extremity of the potash apparatus, in the manner to be described presently when treating of the process of ultimate analysis. 100 grs. of carbonic acid indicate 225 grs. of diabetic sugar.

Another method of ascertaining the quantity of sugar consists in adding to a given quantity of the fluid a known weight of yeast—having by experiment determined the quantity of fixed matter contained both in the yeast and in the fluid operated on. After fermentation is complete the solution is evaporated to dryness, and the loss of solid matter sustained indicates the quantity of sugar which has passed off as alcohol and carbonic acid; the urea likewise is destroyed in the process, and its quantity must be deducted from the total loss. It is very desirable when sugar is present in considerable quantity that the evaporation to dryness should be performed in vacuo over sulphuric acid, as it is the only method that ensures our obtaining the sugar always in the same state of hydration. This process, however, is tedious, always requiring many days for its completion: some comparative experiments, showing the value of this precaution, will be detailed hereafter.

Our methods of exactly determining the quantity of sugar of milk are imperfect; I shall describe the plan which answers best when treating of the analysis of milk.

Uric acid.—This is one of the most interesting and important animal products from the

part it frequently performs in some of the most serious and distressing diseases to which we are liable. The method of detecting its presence by evaporation on glass with nitric acid has already been described. When no albuminous principles are present, the solution is evaporated to dryness and the residue treated with water, acidulated with hydrochloric acid; the insoluble portion is dried and weighed, then burned; the weight of the remaining ash (silica), if any, is deducted; the loss indicates the quantity of uric acid.

Urobenzoic, or, as it is often called, *hippuric acid*, has hitherto been found only in the urine, in which it generally exists in minute quantity, according to Liebig. Its quantity may be ascertained by adding hydrochloric acid to the liquid concentrated by evaporation. It is evaporated to dryness by a water heat, and the residue digested with pure anhydrous ether as long as any thing is dissolved. By spontaneous evaporation it is left behind nearly pure, and may be weighed; traces of urea crystallize with it, and a little of the odorous principle, which obstinately adheres to it. If the ether have dissolved any fatty matter, the addition of boiling water will dissolve the acid and leave the fats. Urobenzoic acid may be detected by heating a crystal in a test tube; benzoic acid and benzoate of ammonia, and a few red drops of an oily matter, sublime, accompanied by a smell of bitter almonds and of the Tonka bean. Alcohol dissolves it freely, and the solution by evaporation leaves stellated groups of needle-shaped crystals. With perchloride of iron solutions of the urobenzoates furnish a cinnamon brown precipitate.

Lactic acid cannot be quantitatively determined without difficulty. The best method is as follows:—The solution if acid is neutralized with ammonia, evaporated to dryness, and the residue exhausted with alcohol; to the filtered liquid sulphuric acid is added drop by drop as long as a precipitate ensues; the bases are thus removed as sulphates. The solution is filtered and the precipitate washed with alcohol; the clear liquid is digested with frequent agitation, at a moderate heat, for twenty-four hours, with carbonate of lead: hydrochloric, sulphuric, and phosphoric acids are thus separated as insoluble salts, while lactate of lead dissolves. The solution is a second time filtered, sulphuretted hydrogen gas transmitted through the clear liquid, and the sulphuret of lead separated by another filtration; the filtered fluid is evaporated to dryness to expel the alcohol and excess of gas, the residue redissolved in water and digested with carbonate of zinc; by evaporation of the filtered liquid crystals of lactate of zinc are obtained. If the solution is now mixed with carbonate of potash in excess, evaporated to dryness, exhausted with boiling water and the residue dried and ignited, pure oxide of zinc is obtained: 100 grs. of this oxide indicate 202.5 grs. of lactic acid.

If *oxalic acid* be suspected in any liquid, it must be super-saturated with lime water. On treating the precipitate with acetic acid the phosphates dissolve, and oxalate of lime re-

* These pieces of apparatus will be described in detail in the directions for the performance of ultimate analysis.

mains, as the phosphate of iron is insoluble in acetic acid. The absence of iron must be determined by dissolving the precipitate in nitric acid, nearly neutralizing with ammonia and adding hydrosulphuret of ammonia; the iron, if present, would fall as a black sulphuret, mixed with oxalate of lime. Oxalate of lime dissolves in dilute nitric acid, and, on supersaturating with ammonia, is thrown down unchanged. By converting the oxalate of lime into the carbonate or sulphate, as directed when speaking of the estimation of lime, the quantity of oxalic acid may be inferred—100 grs. of the carbonate indicate of anhydrous oxalic acid 72 grs., and 100 of the sulphate 51.94 of the acid.

2. For the inorganic constituents.

To ascertain the nature and proportion of the saline matters incineration is resorted to in the manner already described. This process, however, only tells us what the *fixed* ingredients are, and their quantity, in the form of oxides, chlorides, sulphates, phosphates, or carbonates. All the ammoniacal salts are necessarily dissipated, frequently carrying off portions of sulphuric acid and chlorine. The organic acids that may have been combined with the bases are entirely decomposed and their place supplied by carbonic acid, which renders it difficult to decide whether any carbonate actually existed as such in the compound; and moreover the metals, as iron, calcium, and magnesium, with other bodies, as sulphur and phosphorus, are for the most part estimated, not (as is sometimes probable, and at others certain, that they existed) in the metallic or unoxidized form, but as oxides or acids. The information we derive from incineration is therefore incomplete, and the mere deduction of the weight of ashes from the entire weight of the body burned by no means furnishes us with a correct estimate of the proportion of volatile ingredients; generally speaking, however, it is the nearest approximation we can obtain.

I shall here describe very briefly the means best adapted to the qualitative and quantitative determination of the saline matters, referring those requiring more ample instruction on this subject to Rose's Manual of Analytical Chemistry, and the various systematic treatises on the science.

Although during incineration portions of saline matter, and especially of chlorine, are carried off, and the sulphates are sometimes reduced to sulphurets, we find it the only method by which any thing like an accurate estimate of the inorganic constituents can be obtained, inasmuch as many of these bodies occur in the form of chemical compounds with organic matter, and are thus prevented from forming precipitates with the ordinary reagents: iron is particularly liable to be thus affected. When practicable, we should usually make an analysis of the solution for the inorganic acids before evaporation, and afterwards a second examination of the fixed residue after ignition.

The inorganic materials for which we shall

have in general to search are comparatively few in number; among the acids, hydrochloric, sulphuric, phosphoric, and carbonic, with traces of silica, will be those of most frequent occurrence. Occasionally we may have to seek for iodine, fluorine, and unoxidized sulphur. Potash, soda, ammonia, lime, magnesia, and oxide of iron, are the bases that will be most frequently the objects of experiment, and now and then we may have to look for copper, lead, and some other metals.

Qualitative examination.

a. The saline residuum, after ignition, is boiled with a little water (solution A) and filtered from the insoluble residue (B).

A. b. The solution, except in special cases, will only contain sulphates of potash, soda, lime, and magnesia, as well as chlorides of the same bases, and phosphates and carbonates of potash and soda. When the alkaline carbonates are present, lime and magnesia need not be looked for; nor need we search for either of these bases if the solution contain phosphates, unless the liquid reddens litmus paper. The liquid is, therefore, in the first place tested with blue and with reddened litmus paper, by which acidity, alkalinity, or neutrality is rendered evident; we then proceed to determine what acids are present. The absence of a precipitate should not be too hastily decided on. As a general rule the tests should be allowed to stand twelve hours before a negative result is recorded.

c. A portion of the liquid is acidulated with nitric acid, and to a small quantity of it a drop or two of solution of *chloride of barium* added; a white cloud indicates *sulphuric acid*.

d. Into another portion of the acidulated fluid *nitrate of silver* is dropped in slight excess; a bluish white flocculent precipitate shews the presence of *chlorides*.

e. The solution (d) is filtered from the chloride of silver, is boiled for a few minutes, then saturated exactly with ammonia. If *phosphoric acid* be present, a yellow precipitate of phosphate of silver, very soluble in excess of ammonia, is produced.

f. A little of the aqueous solution is evaporated to dryness, and a drop of *nitric acid* added to the residue: effervescence indicates *carbonic acid*, due in all probability to the decomposition of some organic acid by ignition.

We have next to test for the bases in solution.

g. The liquid is rendered slightly alkaline by ammonia free from carbonate.* A white precipitate shews *phosphate of lime* or *magnesia*, or both.

h. The filtered liquid is tested by *oxalate of ammonia*; if *lime* be still in solution, a white cloud falls.

i. The oxalate of lime is separated by filtration and *phosphate of soda* or ammonia added; brisk stirring with a glass rod causes a white

* The absence of carbonic acid is easily ascertained by adding some lime-water to the solution of ammonia; it ought to remain perfectly transparent; opalescence indicates the existence of carbonic acid.

crystalline precipitate if any *magnesia* were still contained in the liquid.

k. A portion of the original liquid (*b*) is acidulated with a drop or two of hydrochloric acid; if sulphuric or phosphoric acid have been detected (by *c* and *e*), chloride of barium in slight excess is added, the solution filtered, heated, and precipitated by a mixture of caustic and carbonate of ammonia; it is again filtered, the liquid evaporated to dryness and ignited, the residue dissolved in alcohol, and sufficient alcoholic solution of bichloride of platinum added to produce a yellow liquid: a yellow precipitate indicates *potash*. If no sulphuric or phosphoric acid be present, the use of the chloride of barium and ammonia will become unnecessary.

l. Decant the yellow solution just obtained (*k*) from the precipitate, if there be any, and allow it to evaporate spontaneously or at a very gentle heat. If *soda* be present, long prismatic yellow needles of the double chloride of platinum and sodium form. This is the best test of the presence of *soda*. The yellow tint which its salts communicate to the exterior flame of the blowpipe, when heated on a platinum wire, has been proposed, but this is by no means an unequivocal appearance. Almost all the animal fluids contain *soda* in the form of common salt.

B m. The insoluble fixed residue (*B*) may contain phosphates and carbonates of lime and *magnesia*, as well as phosphate and oxide of iron, and traces of silica. The residue is treated with nitric acid, by which every thing but the *silica* is dissolved. *Carbonic acid*, if present, is manifested by effervescence.

n. The solution is diluted and filtered; to one portion ammonia free from carbonic acid is added; if phosphoric acid be present, a precipitate occurs whilst the liquid still remains acid; under these circumstances ammonia is added as long as the precipitate at first formed re-dissolves in the solution, still acid. If a solution of *acetate of lead*, carefully dropped in, cause a white precipitate, soluble in nitric acid, and which if collected and dried fuses before the blowpipe into a semi-transparent bead, which assumes a crystalline structure on cooling, *phosphoric acid* is indicated by the phosphate of lead thus obtained.

o. Another portion of the acid liquid is neutralized by ammonia, and the precipitate, if any occur, re-dissolved by acetic acid. Oxalate of ammonia shews *lime* by the formation of a white precipitate.

p. To the liquid filtered from the oxalate of lime *carbonate of ammonia* is added in slight excess; if the previous examination have shewn phosphoric acid to exist, a crystalline precipitate indicates the double phosphate of ammonia and *magnesia*. If no precipitate be thus obtained, boil the liquid, and the *magnesia* in solution falls as carbonate.

q. *Oxide of iron* is detected instantly by adding a drop of solution of *ferrrocyanide of potassium* to the acid solution: an immediate Prussian blue precipitate shews iron, if present. The precipitates obtained in the previous experiments for lime and *magnesia* will, instead of being white have a more or less decided rusty

brown tint, especially when dry, if iron form any considerable part of the matter examined.

For the detection of iodine, lead, and the other bodies enumerated in the list of inorganic substances for which we may occasionally have to look, the reader is referred to the following directions for the *quantitative estimation* of the different compounds.

Quantitative estimation.

For the convenience of analysis our saline matter may be divided into two portions, one of which is employed for determining the acids, the other for the bases. The first portion will enable us to ascertain the quantity of carbonic and phosphoric acids, of chlorine, and of sulphuric acid. From the second portion we obtain the *potash*, *soda*, *lime*, *magnesia*, *iron*, and *alumina*, if, as rarely occurs, the latter be present.

Other ingredients will usually be matter of special examination; the details of the methods to be pursued are subjoined.

We begin by treating the salts to be examined with water (solution *A*). Nothing but carbonates and phosphates of the earths will thus remain undissolved (residue *B*).

(*A.*) *Carbonic acid*.—The aqueous solution is treated with lime-water, or with a mixture of ammonia and *nitrate* of lime, as long as any precipitate is produced. If no phosphates be present, this consists of carbonate of lime, the solution is boiled—filtered, the precipitate ignited, and after adding a few drops of strong solution of carbonate of ammonia heated below redness and weighed, 100 grs. of carbonate of lime indicate 44 of carbonic acid. When phosphates are present, we proceed as follows:—

Phosphoric acid.—The precipitate obtained by lime-water, as thus directed, contains all the phosphoric acid that may be present. If therefore phosphates existed in our solution, the precipitate, after its weight has been carefully ascertained, must be dissolved in nitric acid, and caustic ammonia (free from carbonic acid) added in slight excess. The phosphoric acid separates as a gelatinous precipitate of phosphate of lime. It must be ignited and the weight deducted from that of the mixed precipitate previously obtained; the difference indicates the quantity of carbonate of lime. The precipitated phosphate of lime contains 49.1 per 100 of phosphoric acid. Phosphate of lime dissolves in nitric, hydrochloric, or acetic acid without effervescence, and is thrown down by ammonia in a gelatinous form. The phosphates and carbonates being thus separated, the filtered solution is treated for,

Hydrochloric acid.—The quantity of this acid or of the chlorine it contains may easily be determined by precipitating the solution pretty strongly acidulated with nitric acid by means of *nitrate of silver*. The chloride of silver thus obtained is completely soluble in ammonia, but resists the action of strong nitric acid even when boiling. The precipitate must be ignited; it should undergo fusion into a horny mass at a heat a little below redness. It is now weighed; 100 parts indicate 25 of chlorine.

Sulphuric acid may be precipitated from the filtered liquid or from any fluid suspected to contain it by acidulating (if not already acid), not too strongly, with nitric acid, and precipitating with nitrate of baryta. The precipitate should be well washed with boiling water as long as any thing is dissolved, then ignited and weighed. Boiling nitric acid is without effect upon it; 100 grs. contain 34.19 of sulphuric acid.

(B.) The insoluble portion consists of carbonates and phosphates of the earths, and perhaps of iron. We bring them into solution by means of nitric acid, and supersaturate with caustic ammonia to separate the phosphates; filter if necessary, and add oxalate of ammonia; collect and ignite the precipitate, moisten with solution of carbonate of ammonia; it is once more heated to incipient redness, and it then consists of carbonate of lime: the carbonic acid is estimated in the manner already directed. The filtered liquid is boiled with solution of carbonate of ammonia; the magnesia, if any, precipitates and must be strongly ignited; 100 parts indicate 110 of carbonic acid, which must be added to that combined with the lime.

Phosphoric acid.—The quantitative estimation of this body is attended with some difficulty, as it cannot be effected by direct precipitation, but is inferred from the loss. The precipitate by caustic ammonia just obtained consists entirely of earthy phosphates and phosphate of iron. It is ignited and the weight ascertained. It is then brought into solution by means of concentrated hydrochloric acid, and ammonia added until the precipitate from the still acid solution is no longer perfectly redissolved. Acetic acid is now added and then more ammonia, taking care that the liquid is still strongly acid. Phosphate of iron alone precipitates; this is separated by filtration, and after strong ignition consists of 57.44 phosphoric acid and 42.56 sesquioxide of iron. From the filtered liquid the lime and magnesia are separated by oxalate of ammonia and caustic ammonia, as will presently be described; then deducting the united weight of the oxide of iron, lime, and magnesia from that of the ignited mixed phosphates, the remainder is phosphoric acid.

In order to bring the tests for analogous bodies together, I shall here interrupt the course of the analysis to describe the methods of proceeding with those substances for which occasionally, though more rarely, we have to look.

Iodine, in organic fluids, always occurs in the form of an iodide, and is not met with in the human body in its normal condition. We must evaporate to dryness and treat the residue with alcohol. The iodide will be dissolved; we again evaporate to dryness and re-dissolve in water: (if the quantity be not very minute, this preliminary process may be dispensed with, merely concentrating the liquid and allowing it to cool;) iodine may now be detected by adding a little cold solution of starch, and pouring into the mixture a few drops of solution either of chlorine or of chlo-

ride of lime (bleaching liquor), when a blue colour, more or less intense, is produced. The quantitative estimation of iodine in these analyses is seldom required; when it is, a neutral solution of chloride of palladium is added to the solution, accurately neutralized, and the whole set aside in a warm place for twenty-four hours, a black precipitate of iodide of palladium forms: it should be collected on a weighed filter and dried at a very gentle heat, otherwise part of the iodine escapes. 100 grs. of iodide of palladium contain 70 of iodine. By suspending this iodide in water and adding starch and a little chlorine water, the blue colour is produced as usual.

Fluorine, when present, and it appears to be a universal constituent of bones, is always in exceedingly minute quantity. To discover it we incinerate the dried matter, pulverize and make it into a thin cream with oil of vitriol in a shallow platinum crucible; instead of its usual cover the mouth is closed by a piece of flat glass, the under surface of which has been covered with a film of melted bees' wax or some resinous varnish; when firm or dry, a few characters are traced with a sharp point to expose the glass underneath; the glass is pressed upon the crucible so as completely to close it, and the whole heated over a spirit-lamp for a quarter of an hour. The glass is kept cool by a piece of moistened paper. If any fluorine be present, the traces upon the glass from which the wax has been removed will be more or less corroded; the superfluous wax may be removed by oil of turpentine, and the corrosion may be rendered distinct by rubbing a little powdered charcoal over the surface. If any marks are produced, it is an unequivocal proof of the presence of fluorine. This method, however, is not very delicate.

Free *sulphur* is detected by boiling the substance with solution of potash; if this element be present in the unoxidized state, a black precipitate of sulphuret of lead is formed on adding a few drops of acetate of lead.

If we desire to know the quantity of free sulphur, we first satisfy ourselves of the absence of sulphuric acid, or determine its quantity accurately by the method already described; then defflagrate the substance or dry residue with eight parts of pure nitre and two of pure carbonate of potash, throwing the mixture in successive small portions into a platinum crucible heated to redness; the sulphur is thus converted into sulphuric acid at the expense of the oxygen of the nitre, and its quantity may be determined by dissolving the saline residue in water, supersaturating with nitric acid, and precipitating by a salt of baryta as usual: the process is one requiring more than ordinary care to ensure accuracy.

To resume the usual process of analysis, we now proceed to determine the bases. Most of the acids may be determined with considerable exactness before the organic matter has been destroyed by ignition; it is not so with the bases. Incineration should always precede an attempt to estimate them. The second portion of saline matter is dissolved in water as

before, separating it thus into a solution (A), and an insoluble residue (B).

(A.) *Potash*.—The solution rarely contains any but the alkaline salts. If, however, any of the earths are present, they must first be separated in the form of carbonates, by adding a mixture of carbonate and caustic ammonia; the filtered liquid is evaporated to dryness, the residue ignited to expel ammoniacal compounds and re-dissolved in water, which then contains only salts of potash and soda. If sulphuric or phosphoric acids be present, it is necessary for a quantitative determination of each alkali to convert the mixed sulphates or phosphates into chlorides. The method for accomplishing this object is rather circuitous: chloride of barium in slight excess is added to the solution, which is filtered from the sulphate or phosphate of baryta that then precipitates; the filtered liquid is heated with a mixture of caustic and carbonate of ammonia, again filtered, evaporated to dryness, and ignited; the bases are thus obtained in their desired condition of chlorides; they are then carefully weighed, re-dissolved in a small quantity of water; bichloride of platinum in solution is added, and the whole evaporated to dryness on a water-bath. The dry residue is digested with rectified spirit, and the washing continued as long as the liquid passes coloured through the filter; the precipitate, consisting of anhydrous double chloride of platinum and potassium, is dried and weighed; 100 grs. indicate 19.43 of potash.

Soda.—After the potash has been determined, the corresponding quantity of chloride of potassium is deducted from the weight of the mixed chlorides, and the deficiency inferred to be chloride of sodium; 100 grs. of chloride of sodium correspond to 53.33 of the anhydrous alkali. The platino-chloride of sodium, which the alcoholic solution contains, crystallizes in bold, well defined, flattened prisms readily soluble in water.

Ammonia, when present in organic fluids, cannot be quantitatively determined with accuracy. Its presence is easily recognized by the characteristic pungent fumes which are given off when the residue of evaporation is mixed with caustic potash and gently warmed.

(B.) *Iron*.—The precipitate by carbonate and caustic ammonia from A and the insoluble residue B are dissolved in hydrochloric acid. When no phosphates are present, the acid solution is nearly neutralized by caustic ammonia; then an excess of hydro-sulphuret of ammonia added; the iron falls as a black sulphuret. This is collected on a filter, washed, re-dissolved in hot hydrochloric acid, and the iron thrown down as sesquioxide by ammonia in excess. It is thus completely separated from lime and magnesia.*

* In the rare instances in which *alumina* presents itself in the animal fluids, this earth would precipitate along with the sulphuret of iron, and would again be thrown down with the sesquioxide. It is however easily separated by digesting the oxide while still moist in a solution of caustic potash; the oxide of iron alone remains behind. To separate alumina from the alkaline liquid, it is feebly

If the earthy phosphates are present in mixture with iron, the process already described, when speaking of phosphoric acid, must be employed.

Lime.—The acetic solution of the phosphates filtered from the iron, or if no iron be present, the acid solution supersaturated with ammonia and the precipitate re-dissolved in acetic acid, (a precaution indispensable, as oxalate of lime is soluble in nitric or hydrochloric acids,) is treated with solution of oxalate of ammonia in excess. A white precipitate of oxalate of lime falls; it is allowed to stand some hours in a warm place (the liquid would otherwise pass turbid through the filter), separated by filtration, ignited, and then moistened with a saturated solution of carbonate of ammonia, after which it is thoroughly dried at a temperature short of redness. Carbonate of lime is thus obtained; 100 grs. contain 56 of pure lime.

Magnesia.—The filtered liquid is supersaturated with ammonia, well agitated, and allowed to stand for some hours; if any magnesia be present, it separates as a crystalline precipitate, which must be washed with a weak solution of phosphate of ammonia; it is dried and ignited; the residue contains 35.71 of magnesia in every 100 grs.

Our ordinary analysis terminates here.

Lead is sometimes found as a morbid constituent of certain parts, more particularly of the soft solids; the fluid or part to be examined is dried and incinerated, (if bulky, in a clean earthen crucible,) and the charcoal burned off as far as may be; the residue is digested in nitric acid diluted with thrice its bulk of water, filtered, nearly neutralized by ammonia, and a current of sulphuretted hydrogen transmitted through the liquid. The gas is easily generated for this purpose by adapting to a common phial a glass tube bent twice at right angles, one limb being considerably longer than the other; the short limb passes air-tight through the cork of the phial, and the other plunges nearly to the bottom of the liquid to be examined. In the phial 100 or 200 grs. of coarsely bruised proto-sulphuret of iron are placed, and an ounce or two of dilute sulphuric acid (1 of acid and 5 or 6 of water); abundant effervescence arises from the disengagement of the sulphuretted hydrogen. If lead be present in the tested liquid, a brown or black precipitate of sulphuret of lead falls, and the liquid becomes milky from the partial decomposition of the gas; when it smells strongly of the sulphuretted hydrogen, the liquid is filtered, the precipitate is treated with nitric acid, to which a few drops of sulphuric acid have been added, and the whole ignited; a white residue of sulphate of lead is obtained, which contains 68.42 per cent. of metallic lead. Sulphate of lead is insoluble in acetic acid, but is completely dissolved by a strong solution of acetate of ammonia.

supersaturated with hydrochloric acid, and again rendered slightly alkaline by ammonia; the alumina precipitates, is collected on a filter, thoroughly washed, ignited, and weighed.

The presence of *copper* is determined in the same way by incineration, treatment with nitric acid and sulphuretted hydrogen; the resulting sulphuret is dissolved in nitric acid, and the oxide thrown down from the boiling solution by excess of caustic potash: it is ignited and weighed; 100 parts contain 80 of metallic copper. If the nitrate of copper be treated with ammonia instead of potash in excess, a beautiful transparent blue solution is obtained, which, when procured as just mentioned, is characteristic of the presence of copper.

Mercury, arsenic, antimony, and a variety of other substances may occasionally be met with after poisoning with these bodies; but abundant directions for their discovery are given in the works on Toxicology, and to these, and in particular to the excellent treatise of Dr. Christison, the reader is referred.

B. ANALYSIS OF ANIMAL SOLIDS.

Solid matters, as tumours, concretions, and sediments, are best subjected to a preliminary test by the action of heat; the sediments are separated by filtration from the liquids in which they are deposited; by ignition on platinum foil of a few small fragments we observe either,

1. It is wholly or almost wholly dissipated, in which case it consists of,

Cholesterin, which fuses and burns with flame;

Uric acid, or } which are gradually dissi-
Urate ammonia, } pated, producing transient
blackening of the foil around;

Cystic oxide, which is consumed with a peculiar odour;

Albumen, *fibrin*, or *hairs*, which swell up and burn with flame:

2. Or it blackens, leaving a less bulky residue;

In which case it may be

Urate of soda, *potash*, } they leave an alka-
Lime, or *magnesia*, } line ash, which in
the two first fuses at a red heat, or it may arise from a mixture of some of the preceding list with some of those that follow.

3. Or, lastly, it undergoes little or no change in bulk, when it is composed of

Phosphates of the earths;

Carbonate of lime, or *magnesia*;

Oxalate of lime, which generally decrepitate.

Having by these simple trials acquired some knowledge of the nature of the substance we have to deal with, we proceed to a more special examination.

a. Cholesterin is the principal constituent ofiliary calculi in the human subject, mixed with variable proportions of colouring matter. These calculi, when numerous, generally present facettes more or less flattened and polished; when solitary, they often attain considerable bulk, and are usually crystalline and mitransparent on the surface. Before the blowpipe they fuse and burn with a bright smoky flame, leaving but little ash. Boiling alcohol dissolves the cholesterin, and on cooling deposits the greater part in pearly glisten-

ing scales. Caustic potash dissolves the colouring matter and leaves the cholesterin. This last reaction distinguishes it from other fats, and particularly from lithofellic acid, recently discovered as an occasional constituent of bezoars and of gall-stones in the inferior animals; the lithofellic acid fuses at a higher temperature than cholesterin, and separates from its alkaline solution as an insoluble fat on neutralizing by a stronger acid.

b. Uric acid generally assumes the form of a reddish-brown crystalline sand, or of lighter-coloured rounded masses. Before the blowpipe it blackens and burns away, leaving only a minute trace of ash, usually alkaline, owing to the presence of a very small quantity of lime or soda. The manner of applying nitric acid, so as to produce the characteristic colour from the decomposition of uric acid, has been already mentioned. When powdered it dissolves completely in solution of potash by the aid of heat, and if the solution be supersaturated with hydrochloric acid, uric acid again precipitates in minute white crystals.

The urates are much more soluble in hot water than uncombined uric acid: they form amorphous deposits usually of a light brown colour.

Urate of ammonia before the blowpipe presents phenomena resembling uric acid; when rubbed with solution of caustic potash, ammoniacal fumes are emitted. In its other reactions, except that it is more soluble in boiling water, it closely resembles uric acid.

Urate of soda is distinguished by the large proportion of fusible alkaline ash left on ignition after the application of a red heat; the residue dissolves with effervescence in hydrochloric acid and gives no precipitate when this solution is treated with an alcoholic solution of chloride of platinum. If *potash* were present, it would be indicated by the formation of crystals on adding this test.

Urate of lime occasionally accompanies uric acid; the residue by incineration then yields the usual reactions of lime, such as a precipitate with oxalate of ammonia when added to a solution of the ash in acetic acid.

c. Cystic oxide is wholly dissipated by heat, emitting a peculiar odour. It is soluble readily both in acids and alkalies, and is deposited in hexagonal plates by spontaneous evaporation of its ammoniacal solution. The peculiar form of its crystal is at once recognized by the employment of the microscope.

d. Albumen and fibrin are discovered by their solubility in diluted alkalies and in acetic acid. Neutralization causes a flocculent precipitate soluble in excess of acetic acid or of the alkalies; the acetic solution gives a precipitate on adding ferrocyanide of potassium. Before the blowpipe they swell up, leaving a bulky coal which burns with difficulty to a small white or yellowish ash; they always contain saline matter. Albumen and fibrin, in common with all the compounds of protein, are further characterized by dissolving slowly in the concentrated acids; with *sulphuric acid* a

crimson liquid is obtained, with *nitric* a yellow solution attended with effervescence during the action, and with *hydrochloric acid* a characteristic violet-coloured liquid is procured.

e. The *gelatinous tissues* may be shewn to be such by continued boiling in water for twenty-four or forty-eight hours; the liquid, if not too dilute, has then the property of gelatinizing on cooling; with infusion of galls it should produce an abundant flocculent buff-coloured precipitate.

f. Sometimes we meet with concretions formed principally of *hairs*; their texture and appearance generally betray their composition. Before the blowpipe they are dissipated with the well-known smell of burnt feathers. Solution of potash dissolves them slowly, and the liquid then gives the reactions furnished by alkaline solutions of albumen.

g. Earthy phosphates.—Phosphate of lime rarely occurs alone, either as a sediment or calculus; though in combination with others it is one of the most usual constituents of morbid concretions. Before the blowpipe, unless mixed with animal matters, it undergoes little change; usually a transient blackening appears from the charring of a little organic matter always present; by continuing the heat it becomes white. Nitric acid dissolves it readily, and phosphoric acid may be shewn by adding acetate of lead as directed when speaking of the detection of phosphoric acid. Ammonia in excess added to the acid solution causes a bulky gelatinous precipitate of bone earth; on redissolving in acetic acid, and adding oxalate of ammonia, we obtain abundance of oxalate of lime.

Phosphate of ammonia and magnesia, or, as it is frequently termed, *triple phosphate*, is a common constituent of calculi and of white sand; when in the form of a sediment it generally occurs in hemihedral six-sided prisms; heated before the blowpipe it emits ammonia, agglutinates, but is almost infusible; the addition of a fourth or a sixth of its bulk of phosphate of lime, as a shaving of bone or ivory, causes its immediate fusion to a white enamel-like bead. It is soluble in acids, and ammonia causes a crystalline precipitate of unchanged phosphate; phosphoric acid may be discovered by acetate of lead as before; oxalate of ammonia causes no precipitate in the acetic solution unless lime be present.

Not unfrequently these two kinds are mixed, constituting what has been termed the *fusible calculus*, from its property of forming the enamel-like bead before the blowpipe just mentioned. Heated with potash it evolves ammonia. Phosphoric acid and lime may be shown as before. After the separation of lime by oxalate of ammonia, supersaturation with ammonia throws down the crystalline phosphate of ammonia and magnesia.

h. Carbonate of lime.—These calculi before the blowpipe are converted into caustic lime, and then give a brown stain to turmeric paper. In dilute nitric or hydrochloric acid they dissolve with effervescence. Lime may be shown in the solution by appropriate tests.

i. Oxalate of lime is now and then met with, forming a gravel crystallized in pale amber-coloured prisms, but usually in the form of larger concretions, from their tuberculated exterior termed mulberry calculi; for the most part they have a dark brown or mahogany colour. Heated moderately before the blowpipe they yield a white ash, consisting principally of carbonate of lime, and dissolving with effervescence in acids. If the heat be greater, quicklime alone remains. It stains turmeric paper brown when moistened. Lime may be detected in the ash by the usual reagents. Oxalate of lime, when powdered, dissolves in nitric acid readily, more sparingly in hydrochloric acid. Ammonia throws it down unchanged from these solutions, and the precipitate is insoluble in acetic acid.

The whole of the preceding experiments may be made upon portions of matter not exceeding two grains, and most upon a quantity much smaller, especially if our examinations be aided by the microscope. Examinations of these matters are rarely quantitative; the small quantity of material procurable, and an unwillingness to sacrifice morbid products of this description for the purposes of analysis, prevent us from possessing information so full and detailed upon the constituents of concretions in general as the numerous collections in existence would have led us to expect.

Calculi, especially urinary calculi, are far from presenting a uniform and homogeneous structure throughout, being in many if not in most cases composed of laminæ differing materially in composition. It would be of little value to the pathologist to know the components of all the different layers mingled indiscriminately; the information he would derive as to the process by which the stone was formed, and of the means by which tendencies to such formations might be counteracted, would be of the most confused and indefinite description, tending rather to mislead than to aid him in forming correct conclusions. Just so it is when chemical analysis is applied to organized textures in general without due regard to the structure and disposition of the proximate elements within them; and hence the confused medley of substances obtained by subjecting them *as a whole* to the action of chemical agents. The texture, however, once known, and the action of our reagents upon it being watched under the field of the microscope, we can at pleasure separate the different ingredients, and obtain, with comparatively little difficulty, results which are fixed and producible at will; results which strictly belong to the domain of science, to whose enlargement and successful cultivation they then really contribute.

When soft tumours or malignant growths are submitted to our examination, one portion must as usual be carefully desiccated, to determine the proportion of moisture; and another, after being shred finely, macerated for some hours with water at a temperature not exceeding 100° F.; in this way the soluble albumen will be separated from the fibrous and other insoluble

matters. The analysis must afterwards be proceeded with upon the principles already laid down, being first directed to the soluble ingredients and then to the insoluble matters.

C. PROXIMATE ANALYSIS OF INDIVIDUAL SECRECTIONS.

1. *Of the urine.*

The following is a detailed example of the method of analysing healthy urine:—

As there was abundance of the fluid for examination, fresh portions were taken whenever it seemed desirable to do so for determining any particular ingredient.

The secretion had a sp. gr. of 1020.4. It distinctly reddened litmus paper, and exhibited a slight cloud of floating mucus.

(a) 3200 grs. were filtered through a weighed filter, and the mucus collected. It amounted to 0.53 grs.

$3200 : 1000 :: 0.53 : x (= 0.165)$ mucus.

(b) 200 grs. evaporated in a counterpoised capsule left 8.64 grs.

$200 : 1000 :: 8.64 : x (= 43.2)$ solid matters.

$1000 - 43.2 = 956.8$ water.

(c) The residue, 8.64 after evaporation, ignited in the capsule left 2.36 grs. of saline matter.

$200 : 1000 :: 2.36 : x (= 11.8)$ fixed salts.

(d) 1000 grs. of urine (freed from mucus by filtration) was evaporated to dryness in a platinum capsule. It was treated with water, acidulated with hydrochloric acid, and left 0.37 grs. of uric acid; after incineration of the uric acid a trace of silica remained.

(e) During the last three years I have made many careful analyses of the urine with express attempts to obtain from it the lactic acid it is said to contain; but though I employed various methods, and in some instances large quantities of urine, I have never succeeded in eliminating it from fresh urine, and I therefore (as the methods used were capable of detecting small quantities of the lactates when purposely mingled with the urine) concluded that lactic acid is not a normal constituent of human urine. Liebig has lately stated the same fact founded on his own recent examinations of the secretion.

(f) 1000 grs. of urine were evaporated to dryness and exhausted with alcohol. This alcoholic solution was evaporated, the dry mass treated with water, and nitric acid added, with the precautions already mentioned, furnished 29.17 grs. of nitrate of urea.

$100 : 29.17 :: 48.78 : x (= 14.23)$ urea.

(g) The residue after exhaustion with alcohol weighed 6.6 grs. It was ignited, and left saline mass, amounting to 4.46 grs.

$6.6 - 4.46 = 2.14$ organic matter.

From this we deduct the uric acid 0.37 (d), and mucus 0.165 (a), the residue 1.605, is "watery extract."

(h) The portion soluble in alcohol amounts to 43.2—6.6, or 36.6 grs., which we find composed as follows:

The total saline matter of the urine (including the sulphuric acid volatilized by ignition (r))

amounts to . . . 13.388 grs. (= 11.8 + 1.588)	
deduct 4.46	salts insoluble in alcohol (g)
remain 8.928	salts dissolved by alcohol.

fixed salts 8.928	
urea 14.230	by (f)
mur. ammonia 0.915	by (v)

24.073

$36.6 - 24.073 = 12.527$ alcoholic extract.

The composition of the urinary salts has now to be determined.

(i) 1000 grs. of urine were acidulated with nitric acid, and mixed with a solution of nitrate of silver, an abundant precipitate of chloride of silver ensued.

The filter with the precipitate weighed 39.13

The filter alone 15.23

Total wt. of the chloride before fusion 23.90

23.12 of chloride fused in a counterpoised porcelain capsule gave 19.12 grs., weight of chloride after fusion.

$23.12 : 23.90 :: 19.12 : x (= 19.77)$ fused chloride silver.

$100 : 19.77 :: 25 : x (= 4.942)$ chlorine.

(k) The filtered liquid was treated with nitrate of baryta, the precipitate collected, well washed with boiling water, ignited, weighed 4.97 grs.

$100 : 4.97 :: 34.19 : x (= 1.702)$ sulphuric acid.

(l) 1000 grs. of urine were supersaturated with ammonia; a bulky precipitate of the earthy phosphates fell, which after ignition weighed 0.65 grs.

(m) The filtered liquid supersaturated with lime-water gave a precipitate, which weighed after ignition 3.57 grs.

$100 : 3.57 :: 49.1 : x (= 1.753)$ phosphoric acid, which is in combination with alkaline bases.

To determine the bases a considerable portion of urine was evaporated, and the residue burned to whiteness.

(n) 41.5 grs. of the saline residuum left 2.45 grs. insoluble in water.

$41.5 - 2.45 = 39.05$ alkaline salts.

$41.5 : 11.8 (c) : 2.45 : 0.6956$ insoluble salts in 1000 urine; by (l) we found the earthy phosphates 0.65.

$11.8 - 0.7 = 11.1$ alkaline salts per 1000 urine.

(o) The insoluble portion dissolved in a little nitric acid, supersaturated with ammonia and redissolved in acetic acid, gave by oxalate of ammonia a precipitate which yielded on ignition 1.32 grs. carbonate of lime.

$2.45 : 0.6956 :: 1.32 : x (= 0.3753)$ carb. lime.

$100 : 0.3753 :: 56 : x (= 0.2101)$ lime.

(p) The solution filtered from the oxalate of lime and supersaturated by ammonia gave, on agitation followed by repose for some hours, a crystalline precipitate, weighing 1.18 grs. after ignition.

2.45 : 0.6956 :: 1.18 : x (= 0.3345)
 100 : 0.3345 :: 35.71 : x (= 0.1198) *magnesia*.

(q) 0.6956 — (0.2101 + 0.1198) = 0.3659
 phosphoric acid with the earths.

0.3659 + 1.753 (m) = 2.1189 *total phosphoric acid in 1000*.

(r) 15 grs. of the alkaline salts (n) were dissolved in water and converted into chlorides by admixture with chloride of barium in excess; a precipitate of 6.4 grs. of sulphate and phosphate of baryta formed; on treating this precipitate with nitric acid, 0.45 sulphate of baryta remained.

15 : 11.1 (n) : 0.45 : 0.333.

100 : 0.333 :: 34.19 : 0.114 *sulphuric acid in the ash*, from 1000 parts of urine.

But 1000 grs. of urine we found (by k) to contain 1.702 grs. sulphuric acid, therefore 1.702 — 0.114 = 1.588 grs. of sulphuric acid have been expelled by ignition.

(s) The filtered solution was heated with caustic and carbonated ammonia to precipitate the excess of baryta as carbonate. The whole filtered, evaporated to dryness, and ignited to expel the ammoniacal salts. The fixed chlorides weighed 14 grs. They were dissolved in water, treated with bichloride of platinum, evaporated nearly to dryness by a water-bath, then treated with alcohol, the platino-chloride of potassium amounted to 13.40 grs.

15 : 11.1 :: 13.40 : 9.916.

100 : 9.916 : 19.43 :: x (= 1.926) *potash*.

(t) But 247, (1 eqt. platino-chlor. potassium) : 13.40 : : 76, (1 eqt. chlor. potassium) : x (= 4.123) chloride potassium, and 14 — 4.123 = 9.877 chloride sodium.

15 : 11.1 :: 9.877 : x (= 7.3089) chloride sodium,

and 60, (1 eqt. chlor. sodium) : 7.3089 :: 24 (1 eqt. sodium) : x (= 2.9235) *sodium*.

(u) 10 grs. of the alkaline salts were dissolved in water, the solution acidulated with nitric acid, and nitrate of silver added in slight excess: the precipitate of chloride of silver amounted to 15.61 grs.

10 : 11.1 :: 15.61 : x (= 17.3271)

100 : 17.3271 :: 25 : x (= 4.3317) *chlorine in the ashes of 1000 parts of urine*.

We find the equivalent quantity of sodium as follows:—

36 : 4.3317 :: 24 : x (= 2.8878) sodium, equivalent to the chlorine.

The *chloride of sodium* therefore amounts to 7.2195 grs.; deducting the sodium combined with chlorine from the entire quantity in the urine (t), we obtain

2.92356 — 2.8878 = 0.03576, or 0.0536 *soda*.

(v) Now before ignition the chlorine (by i) amounted to 4.942 grs.

deduct. 4.3317 combined with sodium in the ash.

0.6103 chlorine volatilized, probably in the form of muriate of ammonia, the amount of which appears by the following calculation:

36 : 0.6103 :: 54 : x (= 0.9154) *muriate ammonia*.

The results of the analysis are here sub-joined.

Water.....	956.8000	
*Organic matters & ammoniacal salts	} 29.8224	
Urea.....		14.2300
Uric acid...		0.3700
Alcoholic ext.		12.5270
Watery ext..		1.6050
Vesical mucus	0.1650	
Mur. ammonia	0.9154	
Chlor. sodium	7.2195	
Phosphoric acid	2.1189	
Sulphuric acid	1.7020	
Lime.....	0.2101	
Magnesia ...	0.1198	
Potash.....	1.9260	
Soda.....	0.0536	
Fixed saline matters	} 13.1494	
Chlor. sodium		7.2195
Phosphoric acid		2.1189
Sulphuric acid		1.7020
Lime.....		0.2101
Magnesia ...	0.1198	
Potash.....	1.9260	
Soda.....	0.0536	
	999.9623	

In analysing *diabetic urine* the method must be modified, as will be seen by the following example.

It was feebly acid, and had a specific gravity of 1038.

Evaporated in vacuo over sulphuric acid, it furnished a pale amber-coloured soft mass, which weighed,

On the third day....	55.9 grs.
sixth.....	54.1
ninth.....	53.4
fourteenth... ..	53.1
thirtieth.....	52.2

The temperature varied between 60° and 70°, and the vacuum shewed from 1 inch to 1½ inches on the pressure gauge.

The presence of even a very small portion of air materially retards the progress of the evaporation.

From the weight on the thirtieth day we find

500 : 1000 :: 52.2 : x (= 104.4) <i>solid contents</i> , and
1000—104.4 = 895.6 <i>water</i> .

As a contrast to this evaporation in vacuo, the remainder from 500 grs. was evaporated by water-bath, the temperature never rising above 180° F.

In 24 hours the residue weighed 48.4 grs.

48	46.9
72	46.1
96	46.0

By this time it had assumed a deep brown colour, and from being soft and settile had, with the exception of a small portion in the centre, become hard and brittle; by exposure to the air it speedily deliquesced; 30.6 grs. of the dry mass dissolved in water was mixed with 16.7 grs. of yeast, which from the evaporation of another portion was found to contain 3.5 grs. of solid matter. The mixture was set aside for four days at a temperature of 70° to ferment; gas was slowly disengaged; when fresh bubbles ceased to form, the solution was evaporated to dryness, and amounted to 25.8 grs.; deducting 3.5 solid matters of the yeast, we have an unfermentable mass of

* The sulphuric acid has been deducted from the amount of organic matter determined by b and c , and added to that of the saline matters.

22.3 grs. out of 30.6, shewing the quantity of sugar to have amounted to only 8.3 grs., instead of about 24.5 grs. The foregoing experiment shews the impossibility of obtaining an accurate result if the solution be evaporated in air even at temperatures considerably below 200°. Diabetic sugar, in fact, loses by this treatment 5 equivalents of water, and becomes converted into a species of caramel, unsusceptible of fermentation.

To proceed, however, with the analysis:

The salts were found by incineration to amount to 3.09 per 1000 parts of urine.

To determine the quantity of sugar, 250 grs. of the secretion were mixed with yeast and placed in a tall graduated jar capable of containing 25 cubic inches; filled with mercury, and inverted in a basin holding that metal,

The barometer stood at 30.33
The thermometer 72° F.

Air in the jar, which accidentally entered during the act of inversion 1.00 cub. in.

Quantity of fluid..... 1.45 cub.in.
Exterior level of the mercury 12.33 inches below the interior level.

In three days fermentation was complete.
The barometer then stood at... 30.34

The thermometer..... 80°
Exterior level of the mercury 1.14 below that of the interior.

The quantity of gas amounted to 19.3 cub.in. adding the bulk of the fluid ... 1.45

We obtain total gas..... 20.75

Correcting for pressure we obtain
30 : 30.34 — 1.14 : : 20.75 : x (= 20.1828)

Correcting this again for the temperature,
528 : 508 : : 20.1828 : x (= 19.41)

Subjecting the air which was in the jar at the commencement of the experiment to the same corrections, in order to deduct, we obtain

For the temperature
520 : 508 : : 1 : x (= 0.9769)

For the pressure
30 : 30.33 — 12.33 : : 0.9769 : x (= 0.586)

19.41 — 0.58 = 18.83 corrected volume of carbonic acid.

Now 100 : 18.83 : : 106.6 : x (= 20.072)

total number of grs. of sugar in 250 grs. of urine, and

250 : 1000 : : 20.072 : x (= 80.29) sugar.

The urea was found by a separate analysis; 00 grs. were evaporated in vacuo, the residue

eated with hot absolute alcohol (f.3f3). It was allowed to cool in order to deposit part of the sugar, then decanted; this was repeated

ree or four times. The alcoholic solutions were evaporated to dryness, re-dissolved in water, and treated with oxalic acid and sub-

sequently with chalk, observing the precautions ready enumerated: 1.06 grs. of prismatic

sedles of nearly pure urea were obtained.

500 : 1000 : : 1.06 : x (= 2.12) urea.

As a comparative experiment 500 grs. were aporated by the water-bath and nitric acid

bstituted for the oxalic; only traces of crystals nitrate of urea were thus obtained; a con-

clusive proof of the superior delicacy of the first method.

The syrupy residue after exhaustion with absolute alcohol was treated with rectified spirit as long as any thing dissolved: 2.15 grs. of saline matters, uric acid, mucus, and matters soluble in water only were left. Hydrochloric acid left only 0.04 of uric acid and mucus.

500 : 1000 : : 0.04 : x (= 0.08) uric acid, &c.

The acid solution evaporated to dryness and incinerated, gave 0.69 grs.

500 : 1000 : : 0.69 : x (= 1.38) salts insoluble in alcohol.

2.15 — (0.04 + 0.69) = 1.42.

500 : 1000 : : 1.42 : x (= 2.84) watery extract.

By calculation, as in the previous analysis, the alcoholic extract is 15.98 grs.

The composition of the urine is thus determined to be

Water	895.60										
Fixed salts	3.09										
Organic matters & volatile salts } 101.31	<table border="0"> <tr> <td>Sugar</td> <td>80.29</td> </tr> <tr> <td>Urea</td> <td>2.12</td> </tr> <tr> <td>Alcoholic extr.</td> <td>15.98</td> </tr> <tr> <td>Watery extract</td> <td>2.84</td> </tr> <tr> <td>Uric acid & muc.</td> <td>0.08</td> </tr> </table>	Sugar	80.29	Urea	2.12	Alcoholic extr.	15.98	Watery extract	2.84	Uric acid & muc.	0.08
Sugar	80.29										
Urea	2.12										
Alcoholic extr.	15.98										
Watery extract	2.84										
Uric acid & muc.	0.08										
	1000.00										

Where albumen occurs in the urine, we proceed as in the following instance.

The fluid was rather turbid, feebly alkaline, and of sp. gr. 1013.1. It was found to contain 30.2 per 1000 of solid matter, of which 9.17 were salts and 21.03 organic volatile matters.

500 grs. evaporated to dryness, and the residue finely powdered, taking care that none of the particles were lost (by placing the mortar on a large sheet of paper, and covering the mouth of it likewise with paper). It was treated with boiling water and washed as long as any thing dissolved. The insoluble portion collected on a filter, dried and weighed, amounted to 3.1 grs.

500 : 1000 : : 3.1 : x (= 6.2) albumen, with traces of uric acid.

The filtered liquid was evaporated to dryness, and treated with alcohol and nitric acid for urea in the usual manner: the urea per

1000 = 4.72 grs.

The other ingredients were determined as usual and furnished the following results.

Water
 969.80 |

Saline matters
 9.17 |

Organic matters } 21.03
 | | | |----------------------------|------| | Albumen and uric acid .. } | 6.20 | | Urea | 4.72 | | Alcoholic extract | 8.43 | | Watery extract.. | 1.68 | |

1000.00

2. Analysis of the blood.

Unless present when the blood is drawn, we are obliged to proceed as in the following

example, furnished from a patient suffering from a chronic cerebral affection.

(a) The entire blood employed amounted to 6735 grs.; it had been drawn 24 hours, and had formed a tolerably firm but flat coagulum, which weighed 3560 grs. The serum that had separated weighed 3175 grs., and had a sp. gr. of 1029.3.

The proportions of clot and serum were therefore as follows, in 1000 parts.

6735 : 1000 :: 3560 : x (= 528.6) *coagulum*.

6735 : 1000 :: 3175 : x (= 471.4) *serum*.

The analysis divides itself into two portions, that of the serum, and that of the clot.

Analysis of the serum.

(b) 200 grs. of serum were dried at a temperature of 212°. The residue amounted to 18.69 grs.

200 : 1000 :: 18.69 : x (= 93.45) *solids in serum*.

Therefore 1000 — 93.45 = 906.55, *water in the serum*.

(c) The residue was incinerated over the circular wicked spirit lamp, and amounted to 1.46 grs.

200 : 1000 :: 1.46 : x (= 7.3) *saline matters*.

(d) 500 grains of serum were dried in a platinum capsule, the dry mass carefully detached, pulverized, and digested in boiling ether, which was decanted and renewed three or four times. The ethereal solutions evaporated left 0.35 grs. of fatty matter; of this cold alcohol dissolved 0.12 oily fat, leaving 0.23 of crystalline fats.

1000 parts of serum therefore contain 0.24 *oily fat*, and 0.46 *crystalline fats*.

(e) The undissolved residue was heated to expel adhering ether and treated with boiling water. It was thrown on a filter and washed repeatedly, until nitrate of silver produced an insignificant cloud when applied to a few drops of the washings. The filter and its contents were dried; when weighed the albumen amounted to 41.73 grs.

10 grs. when incinerated yielded 0.19 grs. of ash; 10 : 41.73 :: 0.19 : x (= 0.79287).

41.73 — 0.793 = 40.937; 40.937 \times 2 = 81.974 *albumen*.

(f) The filtered liquid evaporated weighed 4.66 grs. It was digested with alcohol, which was renewed as long as any thing was dissolved. The alcoholic solution evaporated amounted to 3.32 grs. (If urea, sugar, or bile be present, they will be contained in this extract and must be sought for in the usual manner.)

4.66 — 3.32 = 1.34 grs. watery extract, 1.34 \times 2 = 2.68. 1 gr. of watery extract incinerated left 0.82 grs. of salts, and 1 : 2.68 : 0.82 : x = 2.197, and 2.68 — 2.197 = 0.483 *watery extract per 1000*.

(g) 1.4 grs. of alcoholic extract, incinerated, left 1.00 grs. of saline matter.

Now 1.4 : 1 :: 6.64 : x (= 4.74) *saline matters*,

And 6.64 — 4.74 = 1.90 *alcoholic extract per 1000*.

The serum therefore consists of

Water	906.550
Fixed salts	7.300
Albumen	81.974
Alcoholic extract	1.900
Watery extract	0.483
Fats, oily	0.240
„ crystalline	0.460

998.907

Analysis of the clot.

(h) 1000 grs. shred finely with a sharp knife were tied in a piece of calico and washed till colourless under a gentle stream of water. The fibrin that remained carefully dried at 212° weighed 5.67 grs.

Ether dissolved from this 0.07 grs. of oily fat.

The pure fibrin therefore amounted to 5.60 grs.

1000 : 528.6 : 5.6 : x (= 2.962) *fibrin*.

1000 : 528.6 by (a) : 0.07 : x (= 0.04) *fat from fibrin*.

(i) 500 grs. of the coagulum completely dried at 212° left a residue of 143.6 grs.

500 : 528.6 :: 143.6 : x (= 151.81) *solids in the clot*.

(k) 528.6 — 151.8 = 376.8 *water in the clot*. Supposing the water entirely due to the serum with which the clot is penetrated, we should find it contain—

Since by (b) 906.55 : 376.8 :: 93.45 : x (= 38.86) *solids of the serum retained by the clot*, and

376.8 + 38.86 = 415.66 *weight of the serum retained*.

But 415.66 + 471.4 by (a) = 887.06 *total serum in 1000 parts of blood*.

(l) 20 grs. of the dried matter of the coagulum ignited left a red ash, weighing 0.52 grs.

20 : 151.81 :: 0.52 : x (= 3.947) *salts in the clot*.

But 1000 : 471.4 :: 7.3 by (c) : x (= 3.441) *salts in the exuded serum*.

3.947 + 3.441 = 7.388 *salts in 1000 parts of blood*.

(m) Since the coagulum contains 2.962 fibrin, And the serum retained 38.860 *solids*.

The sum of the two = 41,822

And by deducting this sum from the total solids contained in the clot we find

151.81 — 41.822 = 109.988 *red particles in 1000 of blood*.

(n) In order therefore to deduce the composition of 1000 parts of blood, we have only to calculate the following proportions from our knowledge of the composition of the serum.

1000 : 887.06 :: 906.55 : x (= 804.164) *water*.

1000 : 887.06 :: 81.974 : x (= 72.716) *albumen*.

1000 : 887.06 :: 1.900 : x (= 1.685) *alcoholic extract*.

1000 : 887.06 :: 0.483 : x (= 0.428) *watery extract*.

1000 : 887.06 :: 0.24 : x (= 0.213) *oily fat*.

To this we must add 0.04 from the fibrin, making the *total oily fat* = 0.253.

1000 : 887.06 :: 0.46 : x ($= 0.408$) *crystalline fat*.

1000 parts of this blood therefore consist of

Water	804.164										
Fixed salts	7.388										
Organic matters, 188.440.	<table border="0"> <tr> <td>{ Red particles ..</td> <td>109.988</td> </tr> <tr> <td>{ Albumen</td> <td>72.716</td> </tr> <tr> <td>{ Fibrin</td> <td>2.962</td> </tr> <tr> <td>{ Alcoholic extract ..</td> <td>1.685</td> </tr> <tr> <td>{ Watery extract ..</td> <td>0.428</td> </tr> </table>	{ Red particles ..	109.988	{ Albumen	72.716	{ Fibrin	2.962	{ Alcoholic extract ..	1.685	{ Watery extract ..	0.428
		{ Red particles ..	109.988								
		{ Albumen	72.716								
		{ Fibrin	2.962								
		{ Alcoholic extract ..	1.685								
{ Watery extract ..	0.428										
{ Oily fat	0.253										
{ Crystalline fat ..	0.408										
	<hr/>										
	999.992										

3. *Analysis of milk.*

Occasionally we may have to perform an analysis of milk: we may proceed as in the following instance.

The milk was rather thin, watery in appearance, and had a sp. gr. of 1031. It was obtained from a woman aged 25, three weeks after the birth of her fourth child.

(a) 100 grs. evaporated to dryness left 11.49 grs. of solid matter.

100 : 1000 : 11.49 : x ($= 114.9$) *solids per 1000.*

1000 — 114.9 = 885.1 *water per 1000.*

(b) On incinerating the residue, an alkaline ash was left amounting to 0.24 grs. = *salts 2.4 per 1000.*

(c) 158 grs. of the milk were mixed with a few drops of acetic acid and evaporated to dryness, and digested repeatedly in ether (the ether was first allowed to macerate upon the residue unpowdered. It was decanted and the greater part of the fat thus removed; the residue was completely dried, powdered, and again subjected to three or four digestions with ether. All the ethereal solutions were then evaporated.) The fatty matter amounted to 4.61 grs.

158 : 1000 :: 4.61 : x ($= 29.13$) *butter per 1000.*

(d) The portion insoluble in ether was digested in dilute alcohol (sp. gr. 920) as long as anything dissolved. The solution on evaporation yielded a yellowish granular mass, consisting of milk sugar, and a little extractive matter; it amounted to 9.7 grs. and appeared perfectly free from casein.

158 : 1000 :: 9.7 : x ($= 61.39$) *sugar of milk per 1000.*

(e) The insoluble residue consisted almost entirely of casein, with a small quantity of saline matter. Calculating by the deficiency, (as, owing to an accident, it was not weighed,) it amounted to 3.85 grs.

158 : 1000 :: 3.85 : x ($= 24.37$) *casein per 1000.*

The results of the analysis may be summed up as follows:—

Water	885.1
Organic matter, { Fatty matter	29.13
112.5, { Sugar and alco- } ..	61.39
{ holic extract ..	
Saline residue, { Casein and wa- } ..	24.38
2.4, { tery extract ..	
	<hr/>
	1000.00

The proportion of "extractive matter" in milk varies, but I am not aware of any ready method of determining its quantity, apart from that of the sugar and casein. If we attempt to digest casein in water, it swells up and partly dissolves, becomes gelatinous, and does not allow the fluid to pass through the pores of the filter. If a cold saturated solution of sugar of milk in proof spirit, (sp. gr. 920,) be allowed to digest for a few days in a closed flask upon the spirituous extract (*d*), the liquid assumes a yellow colour from dissolved extract, and the sugar is left in white crystalline grains, but this can hardly be used as a process for analysis.

4. *Analysis of bile.*

Our methods for analysing this complicated and important secretion are very inadequate. Still, such as they are, I have endeavoured to illustrate them by the following example:—

The bile analysed was obtained from a man *æt.* 75, who died of gangrena senilis. The gall-bladder was removed entire, and the bile examined 48 hours after death.

It was a brownish, turbid, scarcely ropy fluid, of sp. gr. 1024, and amounted to about 240 grs.

(a) 65.16 grs. evaporated to dryness left 4.83 grs. This residue on incineration left 0.75 grs. of saline matter.

65.16 : 1000 :: 0.75 : x ($= 11.51$) *salts per 1000.*

4.83 — 0.75 = 4.08 and

65.16 : 1000 :: 4.08 : x ($= 62.61$) *organic matter per 1000.*

Therefore 1000 — (11.51 + 62.61) = 925.88 *water per 1000.*

(b) 171.2 grs. mingled with thrice its bulk of alcohol, and filtered, left a yellowish ropy residue of mucus, which, when well washed with alcohol and dried, amounted to 5.1 grs.

171.2 : 1000 :: 5.1 : x ($= 29.78$) *mucus per 1000.**

(c) The filtered liquid was evaporated nearly to dryness and mingled with ether. A bright yellow solution was obtained; it was decanted, and the residue repeatedly digested with ether. The mixed ethereal solutions, on evaporation, left 2.8 grs., of which 0.6 grs. was soluble in water (being biliary matter).

2.8 — 0.6 = 2.2 *etheral extract.*

(d) The ethereal extract was treated with a weak solution of ammonia; a brown liquid was obtained, and a white crystalline residue of cholesterol was left, amounting to 0.31 grs.

171.2 : 1000 :: 0.31 : x ($= 1.81$) *cholesterin per 1000*

2.2 — 0.31 = 1.89.

171.2 : 1000 :: 1.89 : x ($= 11.04$) *uncombined fatty and resinous acids per 1000.*

(e) The residue insoluble in ether was treated repeatedly with hot alcohol. It left undissolved a remainder, which when dry amounted to 2.92 grs.

171.2 : 1000 :: 2.92 : x ($= 17.05$) *watery extract.*

* The proportion of matter insoluble in alcohol in this instance was very great, probably it contained something besides ordinary mucus; but circumstances prevented my examining it more minutely.

(f) An attempt was made to separate the colouring matter from the alcoholic extract by baryta water, and to obtain it free from baryta by solution in carbonate of ammonia, but it did not succeed; indeed I have never been able by this or any other process to separate the colouring matter from the other ingredients of the bile with sufficient accuracy to warrant its adoption for analytical purposes.

(g) The quantity of alcoholic extract was in this case from the experiment with the baryta necessarily inferred from the deficiency.

Since 1000 grs. contain 74.12 of solid matters, 171.2 grs. will contain 12.69; we must, therefore, deduct the ethereal and watery extract, and mucus:—

$$(2.2 + 2.92 + 5.1) = 10.22 \text{ grs.}$$

12.69 — 10.22 = 2.47. Biliary and colouring matter:—

$$171.2 : 1000 :: 2.47 : x (= 14.37) \text{ biliary matter per 1000.}$$

The specimen of bile thus examined, therefore, furnishes the following results:—

Water	925.88
Mucus	29.78
Organic matter, { Biliary and co- } 62.61. { loursing matter } Fixed salts, { Resinous and } 11.51. { fatty acids .. } { Cholesterin	14.37 11.04 1.81
{ Watery extract....	17.05
	999.93

M. Pettenkofer has recently proposed the change of colour produced by the action of sulphuric acid and sugar upon bile as a test of its presence. Having freed the liquid suspected to contain it from albumen by evaporating to dryness and exhausting the residue by boiling water, the solution is concentrated by evaporation, and when cold mingled with about one-third of its bulk of oil of vitriol, so as to raise the temperature of the mixture from 150° to 160° of Fahrenheit, but not higher. A few grains of sugar are now added to the liquid, and the whole suffered to stand for a few minutes. If bile be present a beautiful crimson colour is developed, increasing in intensity for some minutes. The tint is unequivocal provided the solution contain not less than $\frac{1}{100}$ of its weight of dry bile, or $\frac{1}{30}$ of the recent secretion. This reaction is independent of the mucus and colouring matter.

5. Of the saliva.

The saliva is not often the object of analysis; when it is, it may be proceeded with as in the following instance, in which healthy saliva was examined. It was obtained several hours after taking food. It had a sp. gr. of 1001.5, was slightly alkaline, restoring the colour of reddened litmus paper; and was rosy and opalescent.

(a) 111 grs. evaporated to dryness in a platinum capsule and incinerated, left 0.22 grs. of ash.

$$111 : 1000 :: 0.22 : x (= 1.98) \text{ saline matter per 1000.}$$

(b) 500 grs. evaporated by a water-bath left 2.51 grs.

$$500 : 1000 :: 2.51 : x (= 5.02) \text{ total solids.}$$

$$5.02 - 1.98 = 3.04 \text{ organic matter.}$$

$$1000 - 5.02 = 994.98 \text{ total quantity of water.}$$

(c) The dry residue was digested in ether; the ethereal solution decanted and evaporated left 0.03 grs. of an oily matter with a strong peculiar odour. It contained a trace of sulphocyanide of potassium, as was shewn by the red colour struck by a very dilute solution of sesquichloride of iron.

$$500 : 1000 :: 0.03 : x (= 0.06) \text{ fatty odorous matter with traces of sulphocyanide potassium.}$$

(d) The residue undissolved by ether was treated with boiling alcohol; the solution decanted and evaporated left 0.61 of a crystalline yellowish deliquescent salt, in which the presence of sulphocyanide of potassium was proved; 1st, by its striking a blood-red liquid with a very dilute solution of sesquichloride of iron; and 2ndly, this solution, according to Dr. Percy's suggestion, was acidulated with hydrochloric acid, and a fragment of zinc dropped in. Immediate effervescence ensued with a strong odour of sulphuretted hydrogen due to the decomposition of the sulphocyanide. Its acidulated aqueous solution gave no precipitate with nitrate of baryta; but after a small portion of the alcoholic extract had been incinerated and the residue dissolved in water feebly acidulated with nitric acid, abundant precipitation was manifest on adding a solution of chloride of barium; during incineration the sulphocyanide had been decomposed and the sulphur, by absorbing oxygen, converted into sulphuric acid.

$$500 : 1000 :: 0.61 : x (= 1.22) \text{ alcoholic extract.}$$

(e) The residue left undissolved by alcohol was treated with water and thrown upon a weighed filter; the insoluble portion amounted to 0.68; it consisted of mucus, debris of epithelium, &c.

$$500 : 1000 :: 0.68 : x (= 1.36) \text{ mucus.}$$

(f) The filtered solution contained traces of albuminous matter (mucus) held in solution by the soda. This was precipitated by exact neutralization with acetic acid, evaporated to dryness, redissolved, and again filtered. This aqueous liquid contained the ptyalin, or peculiar salivary matter, and a certain proportion of watery extract so called. Ptyalin has never yet been obtained in a state of purity. It always contains chlorides and phosphates mixed with it. The solution was mixed with twice its bulk of alcohol, by which the ptyalin in company with some watery extract was precipitated. Its solution, when redissolved in water, gave precipitates with acetate and triacetate of lead, infusion of galls, and nitrate of silver, but none with corrosive sublimate, sesquichloride of iron, or ferrocyanide of potassium, either alone or after the addition of acetic acid. Each time it is evaporated to dryness a small portion remains behind in an insoluble form. Deducting the ethereal and alcoholic extract, and mucus,

$$5.02 - (1.22 + 0.06 + 1.36 (e)) = 2.38 \text{ represents the ptyalin and watery extract per 1000.}$$

This specimen of healthy saliva therefore contained,

Water	994.98		
Organic matter, 3.04.	Fatty and odorous matter	0.06	
			Alcoholic extract and salts
	Fixed salts, 1.98.	Mucus and epithe- lium	1.36
		Ptyalin, watery ex- tract, salts and traces of mucus }	2.38
—————		1000.00	

If mercury were sought for, the best plan would be to mix a little nitric acid with the saliva, evaporate to dryness, mingle the dry mass with well-dried carbonate of soda, to place the mixture in a fine glass tube sealed at one end, and apply the heat of a spirit lamp. If the metal were there, it would sublime and condense as a dew of metallic globules on the cool part of the tube.

II.—ULTIMATE ANALYSIS.

Organic bodies consist principally of carbon, hydrogen, oxygen, and nitrogen, with occasionally small quantities of sulphur, phosphorus, and various metallic, earthy, and saline matters in minute proportions. In cases where the four first elements only are present, the analysis is comparatively easy; and if, as sometimes occurs, the substance to be analysed is capable of assuming a crystalline form, its purification is a matter of little difficulty. When, however, saline compounds enter essentially into its constitution, as in most animal principles, crystallization is never found to take place.

This general absence of crystalline form in animal principles, and the consequent difficulty of ascertaining that they are free from all moisture, which does not chemically enter into their constitution, have, by rendering us uncertain of the purity of the substances analysed, mainly contributed to the slow and uncertain progress of this department of chemistry, and have given rise to the numerous contradictory statements with which it abounds. By multiplied researches and experiments we are, however, at length arriving at results on the accuracy of which tolerable confidence may be placed.

The determination of the four elements, carbon, hydrogen, oxygen, and nitrogen, as they constitute the bulk of most organic substances, is that part of the process which now claims our attention. It is to Gay Lussac and Thenard that we are indebted for the fundamental principle that regulates our operations. The process proposed by them

has subsequently been modified and improved by many chemists, especially by Berzelius, Prout, and Liebig, and in the hands of the latter eminent philosopher it has acquired a degree of facility and accuracy hitherto unapproached in any other department of analytical research.

Our object being to determine the relative proportion in which each of the ultimate elements exists, it becomes necessary to the success of any analytical process that we should procure them in the form of definite compounds that can easily be collected; and it has been found most convenient, by supplying the substance to be analysed with a sufficient quantity of oxygen, to convert the carbon into carbonic acid, which may be absorbed by potash and weighed, and the hydrogen into water, which may likewise, by passing over a substance that has a powerful attraction for it, such as chloride of calcium or sulphuric acid, be collected and weighed, whilst the nitrogen escapes as gas, which is collected over mercury and measured.

In cases where nitrogen is present, it has recently been proposed to heat the substance to be analysed along with hydrate of soda or potash; all the nitrogen is thus converted into ammonia, in which form, like carbonic acid and water, it admits of being weighed. By calculation it is easy to find the weight of the carbon, hydrogen, and nitrogen respectively contained in the carbonic acid, water, and ammonia collected. Carbonic acid contains three-elevenths of its weight of carbon; water, one-ninth of hydrogen, and ammonia fourteen-seventeenths of nitrogen. When by incineration of a portion of the mass the proportion of saline matter has been determined, the quantity of oxygen the substance contains may be known by deducting the united weight of the carbon, hydrogen, nitrogen, and salts from the total weight of the body analysed; the deficiency (supposing sulphur and phosphorus not to have been present) is oxygen.

Scrupulous attention to the purity of the matter submitted to analysis is of course of primary importance, a very slight admixture

Fig. 429.

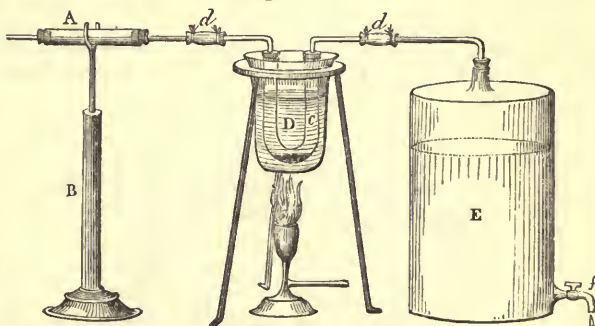

Apparatus for desiccation of organic substances.

A, tube containing chloride of calcium resting on the support B; C, bent tube containing the matter to be dried and plunged in the bath D; d, d, caoutchouc connectors; E, vessel containing water, which flows out gradually by the stop-cock f to maintain a current of air through the apparatus.

with other compounds being sufficient to vitiate the conclusions deducible from our experiments. Having ascertained the purity of our substance, the next care is to ensure its complete desiccation. For this purpose the following plan, recommended by Liebig, will be found the most efficient (*fig.* 429). A small quantity of the material to be dried is placed in an inverted syphon-tube (*c*), the bend of which is plunged into a vessel (*D*), containing water gradually heated to the boiling point. When plain water is used, the temperature of course will not rise above 212° ; but by substituting for it different saline solutions we may at pleasure obtain any degree of heat between 212° and 300° , according to the nature of the compound to be analysed. A current of dry air is made to pass over the substance by connecting one limb of the syphon with a tube containing chloride of calcium (*A*), and the other with a vessel (*E*) closed at top, excepting the aperture by which it is connected with the syphon-tube, and filled with water, which is allowed to run out at the bottom with a speed regulated by a stop-cock (*f*), the place of the liquid being supplied by air, which has passed over the chloride of calcium and then through the syphon-tube. Volatile liquids that are unchanged by distillation should be allowed to stand two or three days upon fragments of fused chloride of calcium; the liquid should then be decanted and distilled in a small retort; in other cases, as in the examination of fats or fixed oils, it may be more convenient to dry the material in a watch-glass placed in an ordinary water-bath or the hot-water oven previously described. The further progress of the analysis will vary according to the form and composition of the substance to be examined.

We shall describe the methods of analysing—

1. A *solid*, which does not contain nitrogen.
2. A *fluid*, which does not contain nitrogen.
3. A substance, which *does contain nitrogen*.

1. *Analysis of a solid not containing nitrogen.*

The combustible which answers best in these experiments is charcoal; it is the least expensive, and very manageable, but dusty. Spirits of wine or pyroxylic spirit, no doubt, are cleaner, but their expense is a great objection. Gas has been tried by myself and others

in a variety of ways, but though some modifications of burner answer tolerably well, it is not on the whole to be recommended.

The best furnace to be used with the charcoal is represented at *A*, *fig.* 430, and is made of stout sheet-iron bent into the form of a trough, open at one end; the plate which closes the other is perforated with an aperture three-quarters of an inch in diameter, to allow the passage of the combustion tube; the furnace is about twenty inches long, five inches at top, two inches and three-quarters at bottom, and three inches high. Transverse slits are made along the floor at intervals of two inches for draught, and between each are rivetted vertical stiff pieces of sheet-iron one inch high, terminating in a concave edge above, for the support of the combustion tube. The apparatus may rest on bricks during the operation, as represented in the wood-cut.

The tube in which the mixture is burned, *the combustion or retort tube*, (*fig.* 430, *a, b, c*.) should be of difficultly fusible glass free from lead, about fifteen inches long and half an inch in diameter: the hard Bohemian glass answers the purpose perfectly. The tube may on certain occasions be drawn out into a fine but strong tail bent upwards at an obtuse angle, and the mouth should be smoothed by making it red hot in the flame of the blowpipe, so that a cork need not be torn in adjusting it.

The apparatus for containing the chloride of calcium which collects the water, *or drying tube*, is conveniently made of the shape depicted (*fig.* 430, *B*): it consists of a tube about half an inch in diameter and four inches long. Upon one end is blown a bulb, to contain a larger portion of the chloride, and from the bulb a strong tube of small diameter extends for an inch and a half. The chloride of calcium with which it is filled must not be fused, but should be prepared merely by evaporating the solution of the chloride to dryness by a strong sand heat. A porous mass is thus obtained, which does not crystallize by absorbing moisture, as the fused variety does, to the destruction of the tube that contains it. In order to charge the apparatus a few fibres of cotton wool are put into the bulb, and by sucking air through the small end adjusted over the aperture of the fine tube to prevent any minute particles from falling out: into the apparatus to

Fig. 430.

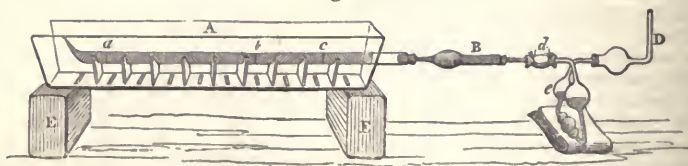

Liebig's apparatus for the combustion of organic bodies.

A, sheet iron trough or furnace containing the retort tube *a, b, c*, and resting on the bricks *E, E*.

B, the drying tube charged with chloride of calcium, or pumice stone moistened with sulphuric acid.

c, the potash bulbs; *d*, caoutchouc connector.

D, the suction tube, shewing the mode of its adjustment when used for drawing air through the apparatus at the termination of the experiment.

within three-quarters of an inch of the large end, the chloride broken into fragments about the size of peas, is put, and a loose piece of cotton-wool, occupying another quarter of an inch, thrust in; the opening is then closed by a cork, through which passes a bit of straight tube, rather larger in the bore than that attached to the bulb, and projecting about an inch outside the whole; the cork is trimmed close to the large tube and covered neatly with melted sealing-wax; and, lastly, air is drawn through the apparatus by the mouth to ascertain that no obstruction exists. It is now ready for use: after two or three experiments the chloride should be renewed, or there will be a danger of the gases being imperfectly dried. The tube when not in use must always be placed in a rack with the bulb end uppermost to prevent the loss of any small pieces of chloride. Concentrated sulphuric acid may be advantageously substituted for chloride of calcium in the drying tube. In this case the tube is filled with fragments of pumice-stone; these are moistened with the oil of vitriol, and the apparatus is fitted up as usual, excepting that the employment of the cotton-wool is dispensed with.

The combustion tube is then prepared by selecting a sound elastic cork, which is made accurately to close the mouth of the tube; it is pierced with a round file, and fitted firmly upon the fine tube proceeding from the bulb of the drying tube; the cork is then well dried on the sand-bath, and forms the medium of connection between the retort and drying tube.

The potash apparatus is one invented by Liebig, represented in *fig. 430, e*. It consists of a fine but stout tube, upon which is a series of bulbs, three in the middle horizontal part of the instrument, and one on each of the ascending limbs; one of the latter bulbs is made considerably larger than the other; the apparatus is filled by adjusting a suction tube to one of the openings, and exhausting by the cheeks until a certain measured quantity of solution of potash has entered; when the liquid fills each of the three lower bulbs rather more than three-quarters of their capacity, sufficient has been introduced.

The solution of potash employed has a sp. gr. of from 1.25 to 1.27, and must be renewed for every experiment; the portions that have been used may be put aside, and afterwards, when sufficient has been collected, may again be rendered caustic in the usual way by quicklime.

The compound commonly used for supplying oxygen to the substance burned is oxide of copper, which readily imparts oxygen to combustible matter in contact with it, but bears a very high temperature *per se* without decomposition. It is best procured by dissolving copper in pure nitric acid, evaporating to dryness and decomposing the nitrate by heating it strongly in an earthen crucible. Ignition is kept up till red fumes cease to appear; if the heat be too great the oxide becomes agglutinated, and requires strong pounding in

an iron mortar to pulverize it; it however, in this dense state, is much less hygroscopic, and therefore better adapted for the purposes of analysis. The powdered oxide is sifted through a fine copper sieve, and secured in stoppered glass bottles.

Immediately before each analytical operation a sufficient quantity of the oxide is ignited, and while still hot transferred to a dry tube, by plunging the mouth of the tube into the oxide in the crucible and then shaking it in piecemeal. The tube with the oxide is immediately closed with a dry cork, and allowed to cool. Meantime the interior of the retort is completely dried by heating each portion of it in succession in the flame of a spirit-lamp, beginning at the closed end, and drawing air through the heated tube, by means of a narrower tube passed down just beyond the heated part and exhausting by the mouth; when every part has thus been dried, the retort is corked and allowed to cool. Five or six grains of the powdered and dried substance are put into a perfectly dry test tube, and the whole is very accurately weighed; its contents are then added to the oxide of copper in the mortar and the empty tube again weighed; the difference gives the weight of the substance employed.

The best kind of mortar is one of Wedgewood ware or Berlin porcelain, capable of containing about half a pint, with a pestle composed of a single piece of the same material; it should be thoroughly dried and well warmed. Much caution is requisite in charging the retort. The warm dry mortar is placed on a sheet of glazed paper and first cleared out with a little of the dried oxide of copper, which is put aside. Oxide to the depth of an inch is poured into the combustion tube; a small quantity of oxide is put into the mortar, then the substance to be analysed, then more oxide; the mixture must be made quickly and carefully, adding so much oxide as shall be sufficient to fill a little more than half the retort; the mortar is then taken in the palm of the left hand and the mixture introduced, carefully picking it up piecemeal by the retort tube itself; fresh portions of oxide are rubbed in the mortar to clear out the last traces, and the retort is then filled up with pure oxide of copper to within two inches of the extremity.

The proportions of the mixture are represented in *fig. 430*: the portion from the tail of the tube to the letter *a* consists of pure oxide of copper, from *a* to *b* of the mixture, from *b* to *c* of the rinsings of the mortar, and from *c* to within an inch of the cork is again pure oxide.

If the process of mixing has occupied much time, it may be advisable to subject the tube and its contents to a further operation to remove any traces of moisture that may have been absorbed. The tube is struck smartly in a horizontal position on the table, to clear the tail-like prolongation, and to make an air-wave above the oxide from end to end; an exhausting syringe made fast to the table by a screw-vice or other convenient means, is attached to a

long tube filled with chloride of calcium; and this drying apparatus is fitted by a sound cork to the retort tube. This latter is laid in a shallow trough open at one end, which is slightly elevated; the trough is then filled with sand heated to about 212° F., and cautious exhaustion is performed by the syringe, taking care that none of the charge is carried out of the tube by the current of air; on gradually opening the stop-cock air is slowly re-admitted, being dried in its passage over the chloride of calcium; it is allowed to remain in the apparatus a few seconds, and the exhaustion repeated; these operations are performed in succession ten or twelve times. It is, however, rarely necessary to resort to this process of desiccation, and it is objectionable from the ease with which many compounds rich in hydrogen decompose the oxide of copper at comparatively low temperatures.

The drying tube having been accurately weighed is next fitted to the dried perforated cork, and connected by it air-tight to the retort tube; this is now placed in the furnace, which has been disposed in a convenient place resting on bricks; to the drying tube the potash apparatus, also previously weighed, is attached by a connecting piece of caoutchouc, taking care that the largest bulb is on the arm connected with the drying tube; the potash apparatus should be slightly inclined by placing a cork under the end of the horizontal portion nearest the open extremity. Matters being thus arranged, we proceed to ascertain if the whole be tight, and for this purpose expand the air in the large bulb by heat, so as to expel a few bubbles; if, on cooling, the liquid rise in the limb and maintain its elevation steadily for a few minutes, the combustion may safely be begun. Charcoal broken into pieces about the size of a walnut is ignited in a crucible furnace or by any other convenient means, and when red-hot applied to the portion of the tube nearest the cork where the pure oxide of copper lies; the action of the heat is limited by a double sheet-iron screen which fits into the furnace, and has a central slit which allows it to bestride the tube; this screen can by degrees be moved further and further down the furnace until the whole tube is heated. An additional screen of single iron plate is hung over the closed end of the furnace to protect the cork, which usually should reach to within an inch of the fire, care being taken that the heat never rises so high as to scorch it, or falls so low as to allow of the condensation of moisture in the portion of the retort which projects from the furnace.

When the first part of the retort is red-hot and the escape of air from expansion has ceased, about an inch more of it may be heated, and so the fire gradually carried down; about three bubbles of air may pass in two seconds, it is better not to attempt a more rapid disengagement. At first but a small portion of the gas is absorbed, but when the substance is fairly undergoing decomposition, and the atmospheric air in the apparatus has been expelled, it is almost entirely taken up by

the potash-ley. When the whole tube is ignited the heat must be continued till bubbles are no longer disengaged; the potash-ley will now gradually recede into the large bulb; when this is observed to commence, the charcoal must be removed from the tail of the tube; and as soon as the potash has risen to fill half the large bulb, the tip of the tail must be nipped off, and over the opened extremity a tube about eighteen inches long, and one quarter in diameter, should be supported; gentle suction is then effected by a sucking tube (*fig. 430, D*) fitted to the free extremity of the potash apparatus, drawing air through the combustion tube to displace the carbonic acid and aqueous vapour it contains. The use of the long tube over the end of the retort is to supply pure air, and to prevent that from the furnace charged with carbonic acid from passing freely into the apparatus: the actual process of combustion performed in the manner above described usually occupies from an hour to an hour and a half.

The plan of drawing air through the tube is that practised by Liebig, and it admits of considerable accuracy. Dumas, however, connects the extremity of the retort with a drying tube, and this again with a receiver containing oxygen, which gas is carefully driven over the contents of the tube. This renders the operation somewhat more complicated, but it is unquestionably more exact, especially in compounds where the proportion of carbon is great. The tube for supplying oxygen is easily adjusted to the retort by drawing out the tail horizontally instead of obliquely, and fitting it on by a caoutchouc connector, care being taken to screen the junction from the influence of heat.

The apparatus is now dismantled, and the whole allowed to cool; in about an hour the drying tube may be weighed, and the increase of weight carefully noted; one-ninth of the gain indicates the quantity of hydrogen the substance contained; the potash apparatus is also weighed, and three-elevenths of what it has gained shews the quantity of carbon. The deficiency is oxygen.

The oxide of copper used in these experiments may again be rendered serviceable by moistening it with nitric acid, and igniting as before.

2. Analysis of a liquid not containing nitrogen.

If the fluid be *volatile*, we take a piece of tube rather less than a quarter of an inch diameter, heat it in the blowpipe flame, and draw on it a capillary portion about four inches long; about a quarter of an inch below this the tube is sealed; the little piece of tube thus left connected with the capillary part is heated and blown into a small bulb about as big as a good-sized pea; this is cut off, leaving a capillary neck of about two inches long. Having made a sufficient number of these little bulbs, we take two of them, which we have ascertained will freely enter the combustion-tube, and weigh them accurately; a little of the liquid to be analysed is put into a small tube, and the

capillary neck of the bulbs inverted into the liquid; the bulbs are then warmed by the flame of a spirit-lamp, so that on cooling they shall be about three-fourths filled with the liquid. The necks are now sealed by the blowpipe-flame, and the bulbs again weighed; the increase of weight gives the quantity of the liquid which has entered, and which is to be analysed. The oxide of copper having been heated, and allowed to cool with the usual precautions, about an inch and a half of the retort is filled with pure oxide; we then take one of the bulbs, draw a file across the capillary neck, put the bulb into the tube, break off the neck by pressure against the glass, and drop the broken portion in with the bulb; we then pour in a couple of inches of oxide of copper, introduce the second bulb in the same manner as the first, and fill up the tube with oxide, cork it and strike it smartly on the table as before to secure free air-way. The combustion-tube is now connected with the exhausting syringe, but no heat applied; on gently working the syringe, the air and vapour in the bulbs will expand and drive out the liquid, which will be quickly absorbed by the oxide of copper around; we adjust the apparatus in the furnace as before, and gradually heat the upper half of the tube; when this is red, we volatilize the fluid by cautiously approximating a piece of ignited charcoal, taking especial care not to heat the tube too much; by degrees all the liquid in the first bulb is expelled, and we proceed in like manner with the other; the whole tube is finally heated carefully, and the after part of the process conducted in the manner already described.

If the liquid be *not volatile*, an oily acid for example, a small vessel is made by taking a piece of glass tube about a quarter of an inch in diameter, sealing one end, and while hot pressing it on a flat surface, so as to make a firm basis on which it may stand upright; it should be cut off the tube so that the little vessel be about an inch high. It is weighed at first empty, and a second time with the liquid for analysis; an inch or two of oxide of copper is put into the combustion-tube, then the vessel with the liquid. On inclining the tube sufficiently, the liquid runs out and is made to diffuse itself over the inner surface of the lower half of the tube, which is to be filled with oxide of copper, and the analysis to be cautiously proceeded with in the usual way.

Substances which contain a great excess of carbon sometimes escape complete combustion by this process; when this is feared, all danger may be averted either by adopting the plan of Dumas, already mentioned, or by pulverizing some chlorate of potash finely, which is carefully dried, mixed with about four times its weight of oxide of copper, and the first portion of the retort is filled with it for about an inch; the tail-like prolongation may in this case be dispensed with at the close of the operation; instead of sucking air through the apparatus, we very cautiously apply heat to the chlorate, oxygen is evolved, which burns the last traces of carbon and displaces the gas and aqueous vapour

which the tubes contain. When the chlorate has been used, the last inch of oxide of copper must be kept separate from the rest, as it will be mingled with chloride of potassium, and must not be employed again until it has been washed from the salt, for as chloride of copper is slightly volatile it would be deposited in the drying tube and unduly increase its weight. If the heat is too suddenly applied, a portion of the chlorate is apt to be carried forward mechanically, and this constitutes the chief objection to its use.

Sometimes *chromate of lead* is advantageously substituted for oxide of copper with substances difficult of combustion, as by a bright red heat alone it gives off a portion of its oxygen. It is easily prepared by precipitating the chromate or bichromate of potash with solution of acetate of lead. It should be well washed and heated to incipient fusion before it is used for analysis. It has the advantage of being much less hygroscopic than the oxide of copper. To ensure accuracy, when much gas (as in this case, and in instances where nitrogen is present,) passes through the potash apparatus during the whole experiment, it is best to connect the open extremity with an additional drying tube, charged with solid hydrate of potash instead of chloride of calcium, the weight of which has been carefully noted, as a portion, very small but still susceptible, of aqueous vapour is carried off from the solution of potash by the gas, and would otherwise be lost, making the quantity of carbon appear somewhat too little.

3. *Analysis of a body containing nitrogen.*

Two separate analyses are in this case required; the first, to discover the proportion of carbon and hydrogen; and the second expressly for the nitrogen. When bodies containing nitrogen are burned with oxide of copper, a variable proportion of the lower oxides of nitrogen is formed, which being retained by the chloride of calcium or potash would render the analyses incorrect. A precaution is therefore employed which renders it necessary to make use of a retort-tube somewhat longer than common; it is charged as usual to within four inches of the opening, and then filled up with clean copper turnings; the apparatus is arranged as before directed, the copper turnings are brought to full redness, and the analysis proceeded with cautiously in the ordinary manner. As the oxides of nitrogen pass slowly over the ignited copper they are decomposed, the oxygen combining with the copper while pure nitrogen escapes; the quantity of carbon and hydrogen is determined exactly as heretofore.

To ascertain the proportion of *nitrogen*, the most accurate method is that recently devised by Varrentrapp and Will, and suggested about the same time by Berzelius; the fundamental fact consists in the observation of Gay Lussac, that when azotised matters are heated with a large excess of hydrate of potash (soda answers equally well), the whole of the nitrogen is expelled in the form of ammonia. In order to render it available for the purposes of analysis the subjoined precautions are requisite.

A mixture of two parts of quicklime and one of hydrate of soda is prepared by slaking some well-burned lime with the necessary quantity of a solution of soda; the whole is evaporated to dryness, ignited, the dry mass pulverized as quickly as possible, and then transferred to well-stopped bottles, in order to exclude carbonic acid and moisture. When an analysis is to be made we proceed as usual, making the mixture in a warm mortar, only substituting the alkalized lime for oxide of copper; the accidental presence of a little moisture, after the weight of material for analysis is accurately known, is of no consequence in this case.

Having introduced the mixture, it is better loosely to plug the aperture of the retort with a few fibres of asbestos (which has been ignited just before) to prevent any mechanical transport of the mixture into the apparatus through which the gases are passed; on applying heat to the combustion-tube in the ordinary way, and with the usual precautions, the substance is decomposed, and the whole of the nitrogen escapes as ammonia. The drying tube and potash apparatus are dispensed with, and the

figures indicate. Pure hydrochloric acid is easily procured for this purpose by diluting the ordinary acid of the shops till it has a sp. gr. of 1.1, and distilling in glass vessels—the first eighth may be rejected. Distillation may be proceeded with until three-quarters of the acid employed have passed over. It is better for the operator always to rectify his own acid, in order to be quite sure of the absence of any trace of ammonia. The tube connecting the bulbs should be somewhat larger in diameter than that of the ordinary potash apparatus, in order to allow the liquid to be poured out readily. When the operation is complete, absorption will take place and the fluid rise in the bulb nearest the fire; at this moment we nip off the top of the combustion-tube and draw air carefully through the apparatus in the usual way. When the combustion is terminated, the contents of the bulb-tube are emptied into a small evaporating dish, and the apparatus washed out first with a little alcohol and ether, and afterwards several times with water; some solution of bichloride of platinum is added, and the whole evaporated to dryness by a water-bath or chloride of calcium bath; when dry, it is digested with a mixture of two parts of alcohol, sp. gr. 833, and one of ether, which dissolves the excess of bichloride of platinum, and leaves the double chloride of platinum and ammonium in a crystalline form.

This must now be brought upon a weighed filter, (or better, upon two filters, one of which has been counterpoised against the other,) and washed repeatedly with the mixture of two parts of alcohol and one of ether until nothing further is taken up; the precipitate and filters must be dried by a water heat and the weight accurately observed. According to Varentrapp and Will, 220.52 grs. of the ammonia-chloride are equivalent to 14 grs. of nitrogen; the estimate of these writers is too high, and 225 grs. are more nearly equal to one equivalent or 14 grs. of nitrogen. Practically, however, their calculation is very near the truth, as during the operation a minute quantity of hydrochlorate of ammonia escapes uncondensed, and the two errors compensate each other.

This method of determining nitrogen answers for all cases excepting those in which it occurs in the form of nitric acid, when it must be determined by volume and its weight thence deduced. For this purpose the process of Dumas is the most trustworthy. A retort tube of about twenty inches long is employed; not drawn out into a tail, but sealed with a rounded extremity; about two inches of the tube are filled with carbonate of copper or of lead, and then the mixture with oxide of copper added and covered as usual with a layer of pure oxide; beyond this the last two or three inches of the tube are filled with clean copper turnings, as already directed, to decompose any of the oxides of nitrogen which may be formed. The retort tube is then connected with a three-legged apparatus of brass or copper (*fig. 431, A, b*), one limb of which is furnished with a stop-cock (*c*). The connection with the retort

Fig. 431.

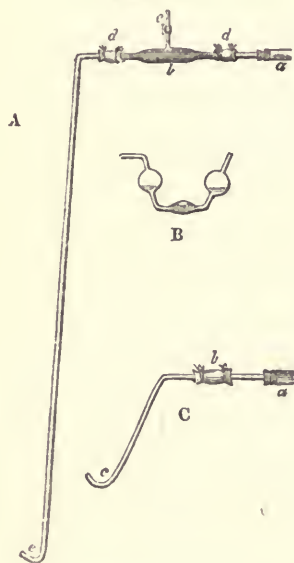

A.—*a*, mouth of the combustion-tube; *b*, three-legged brass tube furnished with the stop-cock (*c*); *d*, *d*, caoutchouc connectors; *e*, glass tube, upwards of 30 inches long, recurved at the lower extremity for delivering gas in the mercurial trough.

B.—Bulb-tube for containing hydrochloric acid in the determination of nitrogen by the method of Varentrapp and Will.

C.—*a*, mouth of the combustion-tube; *b*, caoutchouc connector; *c*, gas delivering tube.

ammonia is collected by attaching a bulb-tube of the form represented (*fig. 431, B*), air-tight with a good cork, to the retort-tube, the apparatus having been previously charged with hydrochloric acid sp. gr. 1.1, as high as the lines in

best made by passing a piece of glass tube through a cork fitting accurately into the mouth of the combustion tube and connecting the brass apparatus to this small glass tube by a caoutchouc connector; the limb (*b*) is fastened by a similar joint to a glass tube (*e*) bent at right angles near one end, with a straight portion upwards of thirty inches long, the other extremity of which is turned up at an acute angle for the convenience of safely delivering the gas; the tube is placed in a vertical direction with its lower upturned extremity dipping into a small mercurial trough; the stop-cock tube (*c*) is connected with an exhausting syringe and a vacuum produced; the apparatus is left for half an hour to ascertain that all the joints are tight: if the mercury after this lapse of time still stands at the same level, the experiment is proceeded with; a moderate heat is applied by a spirit lamp to the end of the retort containing the carbonate; by this means carbonic acid is set free and displaces the last portions of air; the exhaustion and disengagement of gas are repeated alternately three or four times, taking care to leave sufficient carbonate undecomposed to renew this expulsive process at the termination of the experiment. The stop-cock (*c*) is now closed, the air-pump is removed, and a graduated jar containing some solution of potash is inverted in the mercury over the recurved extremity of the long glass tube. The copper turnings are then brought to redness in the usual way by charcoal, and the experiment conducted with the customary precautions, the decomposition being caused to take place less rapidly than usual; when the part of the retort containing the matter for analysis is red-hot through its entire extent, heat is gradually applied to the carbonate at the end, and the last portions of gas from the combustion in the apparatus are driven into the receiver by the disengaged carbonic acid.

As the products of combustion are only water, carbonic acid, and nitrogen, the two former are retained by the solution of potash, whilst the latter alone presents itself for measurement. I need hardly say that the height of the barometer and thermometer must be carefully noticed, when the apparatus by standing for an hour or two has reached the temperature of the atmosphere; as the gas will be saturated with moisture, its volume must be corrected by the known methods for the three points of temperature, pressure, and moisture; then, since 100 cubic inches of nitrogen at standard temperature and pressure weigh 30.15 grs., the weight of the nitrogen that a given quantity of the matter analysed contains is easily determined. In this process, as in every case where the proportion of nitrogen alone forms the object of our experiment, after the weight of the material for analysis has been once accurately determined, it is evident there is nothing to fear from the absorption of moisture.

Occasionally the quantity of nitrogen, where large, is advantageously determined by making the combustion just as though we were going to ascertain the proportion of carbon and hydrogen; but, instead of condensing the car-

bonic acid and weighing it, the whole of the gases produced are collected over mercury. A bent gas-delivering tube is substituted for the usual drying apparatus. (*Fig. 431.*) In this case it is best to begin at the closed extremity of the tube, and having expelled the atmospheric air by a portion of gas generated from the substance, to collect the rest of the gaseous products in a graduated jar; by agitating the gas with solution of potash the proportion of nitrogen to carbon is at once determined, as equal volumes of carbonic acid and nitrogen represent single equivalents of carbon and nitrogen. It is not necessary in this case to determine accurately the quantity of material acted upon.

Experience has shewn that in the preceding process for organic analysis the quantity of hydrogen deduced from it is always slightly in excess, usually about 0.2 parts in 100, whilst, unless chromate of lead or chlorate of potash is employed, the carbon is sometimes as much deficient. A deficiency of carbon also occurs if the ash contain carbonates in any form. Occasionally sulphur and chlorine are among the constituents of organic bodies; the methods of analysis must then be modified. For details upon these subjects the reader is referred to the treatise of Berzelius.

We will suppose the labour of analysis thus brought to a successful issue. It is, however, evident that the information derived from this source alone is but scanty, as we can thereby form no idea either of the number of equivalents of each element entering into the composition of an organic body, or of its relations to the substances concerned in its production or obtainable from it by its decomposition. Whenever it is possible, the equivalent or combining proportion of the compound must be determined. This is effected by preparing a compound of the body with some substance, whose equivalent is well known, and proceeding to analyse the new product. If our organic substance be soluble in water, and capable of entering into combination with oxide of silver, this oxide is for many reasons preferred. Oxide of silver combines with very many organic bodies, and forms with them compounds insoluble or sparingly soluble in water. They may generally be formed by double decomposition, and washed from all adhering impurities; fifteen or twenty grains of the silver compound is accurately weighed in a counterpoised porcelain crucible. It is then carefully incinerated till pure silver alone remains. On again weighing, the loss will give that of the body combined with the silver, and in addition that of one equivalent of oxygen expelled from the oxide of that metal at a red heat. The residual silver should dissolve without remainder in nitric acid. Now, since the equivalent number of silver on the hydrogen scale is 108, it is evident that by simple calculation we may determine the equivalent, number of the organic body that had combined with it.

An example will perhaps elucidate my meaning more distinctly.

expect, in the construction of this skeleton, varieties correspondingly great both in the materials employed and their mechanical arrangement, inasmuch as the machinery employed for effecting progression under circumstances so dissimilar must be changed in every race, and adapted to the peculiarities of habit conferred upon any given creature.

The substance of which the internal skeleton of a vertebrate animal is composed differs moreover very remarkably from that employed to build up the organs of support in any of the other divisions of the animal kingdom. In all the great group of Radiata (Cuv.), wherever a hard material is employed, it is built up by the slow external accretion of earthy particles deposited in successive layers from the living substance of the body, arranged not unfrequently with admirable precision; but, when once formed, such a skeleton is entirely devoid of vascularity, and almost placed beyond the reach of vital influences. Throughout all the Articulata the skeleton is an external crust exuded from the surface of the skin, which is so entirely destitute of all capability of growth or expansion, that it must be cast off frequently during the life of the animal, to be renewed again and again as the bulk of its body is enlarged. In all the Mollusca, too, with the exception of the Cephalopods, in which a true bony structure begins for the first time to be developed, all the hard parts of the body are cuticular and composed of shell. In the Vertebrata alone is found a real osseous skeleton nourished by bloodvessels, consisting essentially of a living tissue that is capable of constant growth and renovation, having its texture hardened in proportion to the necessities of the case by an interstitial deposit of various earths, especially of phosphate of lime, which is continually removed and renovated as age advances, and, in short, is subject, during the whole existence of the creature, to vital influences, its hardness and composition being subject to great variations. In making use of the terms *bone* and *osseous tissue*, we must therefore be understood by no means to employ these words as indicating portions of the animal fabric endowed with any particular degree of density or firmness, that being entirely an adventitious circumstance depending upon the greater or less abundance of the earthy matters deposited in the living tissues, and even in the same animal, in this respect, offering at different periods of its life the most opposite conditions.

In the lowest and most feeble Fishes, which, in consequence of their sluggish movements through an element that buoys them up on all sides, no firmness is required in any part of their construction, and few of the locomotive levers met with in more highly-gifted forms are present, the whole osseous system consists permanently of the softest cartilage undivided as yet into distinct pieces; and it is only as we ascend from this point through successive groups of Cartilaginous Fishes as they are called, the *Sharks*, *Rays*, *Sturgeons*, &c., that, owing to an increased deposit of the hardening earths within the cartilaginous web, firm-

ness and solidity are slowly given. Even in the most perfect Fishes the bones remain soft in comparison with their condition in terrestrial Vertebrata, whilst it is only in Carnivorous Mammalia, and more especially in Birds, that the maximum of hardness is conferred upon the osseous system, a density and a strength commensurate with the powerful muscular exertions required by the conditions under which those races live. Equally remarkable are the differences observable in the texture of the osseous skeleton at different ages in the same creature. The Tadpole of the Batrachian Reptile, for example, at the time when it commences its earliest struggles in the element wherein it passes the first portion of its existence, is, as relates to the condition of this part of its economy, inferior even to the *Myrine* and the *Lamprey* amongst Fishes, consisting of the most delicate cellulosity or of the softest gristle. As growth proceeds, osseous particles accumulate, and the condition approximates that of the more perfect Fishes. Lastly, as the anterior and posterior extremities sprout, the bones acquire progressively the density essential to the construction of a terrestrial animal, and the whole internal framework becomes consolidated to an extent proportioned to the vigorous movements of the perfect Frog. In the higher Mammalia the succession of the phases of development is still further prolonged. At its first appearance, the osseous system is represented by a mere web of cellular tissue, which slowly attains to a cartilaginous texture; this cartilage, during foetal growth, is converted into bone by the deposition of earth in its substance; but it is not till long after birth, when adult age has need to exert all the energies of life, that the bones are fully formed, hardened, and lightened to the utmost required extent by consolidating their substance to the *maximum*, and excavating the caverns and cancelli that characterize the most perfectly matured conditions of the osseous framework.

But passing from these general views, for a more complete consideration of which the reader is referred to another article, (OSSEOUS TISSUE,) we proceed to examine more closely the composition and development of the skeleton, and here we find difficulties to be encountered of no common kind. Did the skeleton invariably consist of the same number of bones, only modified in their shape or position according to the necessities of the different races of Vertebrata, the task of the comparative anatomist would be easy when he came to investigate their analogies and relations with each other; but this is far from being the case: the skeleton of the adult animal does not present the same number of pieces as that of the same creature in a less advanced condition, numerous parts, originally distinct, having become fused and consolidated into one; and, on the other hand, the juvenile being differs from the embryo from circumstances precisely the reverse, seeing that the full complement of bones or centres of ossification has not as yet been developed. Now, as in ascending the scale of living beings belonging to the Vertebrate division of the animal creation, we find that nature can arrest the

further advance of ossification at any assignable point of development, leaving some parts permanently atrophied, while others are allowed to attain their full growth, we find great varieties in the composition of the osseous framework. The *Tadpole*, were its growth arrested before its limbs began to sprout, would be a *Fish*. The *Frog*, if it ceased to grow when its limbs were but partially formed, would be a *Siren* or a *Proteus*, having little or nothing in common with the adult creature as regards the configuration or even the number of the bones in its skeleton. Which of the three conditions must the comparative anatomist refer to in order to estimate the condition of the bones composing the framework of this Batrachian? The importance of this inquiry will be at once obvious, as, either in the first instance there must have been a much greater number of bones developed than are met with in what is usually considered a complete skeleton, or in the adult animal the bones have become too much confused with each other to allow us at all to estimate their real condition. It is sufficient indeed for any person who is only acquainted with the osteology of man, to cast his eyes over the bones entering into the composition of the skeleton of a fish to perceive at once that the nomenclature employed by the human anatomist is by no means sufficiently ample to afford names to one-half of them, which indeed have no representatives in the human body; or even the bare comparison of the adult human cranium with that of the infant of tender age would convince us that in the former there are many more distinct bones than in the latter. The only mode of solving these difficulties is obviously to study the composition of every part of the skeleton in the most complicated form under which it is met with, and having ascertained the number and disposition of the pieces of which it then consists, and settled the names and analogies of each, it becomes comparatively easy to point out what parts are deficient in less complex forms of the skeleton.

The number of pieces which can normally enter into the construction of any portion of the osseous apparatus having been thus determined, these are regarded as the primary elements of the skeleton, by the development, suppression, enlargement, or modified form of which every required variety of the bony framework may be explained, and the construction of this portion of the animal economy proved to be in accordance with certain immutable laws that may be traced throughout the immense series both of the existing and of extinct races of Vertebrata.

It will readily be perceived after the above remarks that a perfect skeleton, that is, a skeleton presenting all the parts of which it might normally be composed in a complete state of development, does not exist in nature.

A spinal column may exist alone without either cranium, face, or limbs, as is the case in that strange and rare fish the *Amphioxus*.* Or

the spine, cranium, face, and extremities may coexist without ribs or thorax, as in the *Frog*. The spine and cranium form almost the entire skeleton of many apodal Fishes, while in Serpents the ribs become the chief instruments employed in locomotion, not even vestiges of legs or arms being visible.

Imagining, however, that a fully formed skeleton, having every apparatus belonging to it, could be pointed out, let us now proceed briefly to glance at the parts of which it would consist, and these we should find to be the following.

Fig. 432.

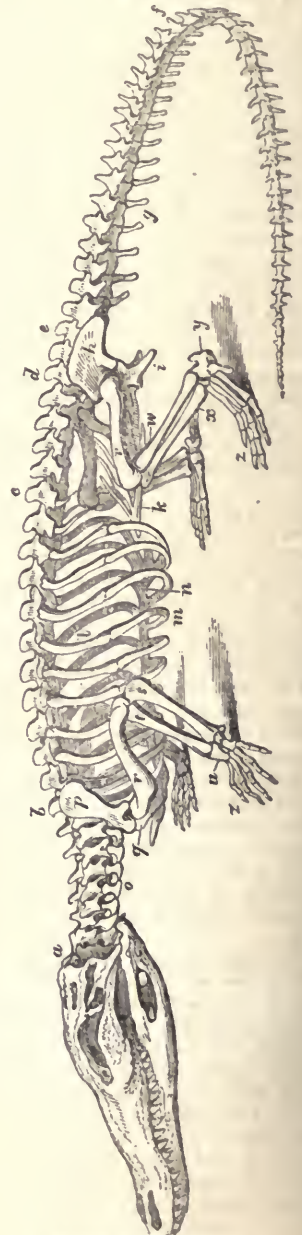

Skeleton of the Crocodile.

* Vide a Memoir on the structure of this extraordinary production of nature, by John Goodsir, Esq.

1. The *spinal column*, the centre of the whole fabric enclosing in a canal formed by arches surmounting its dorsal aspect the medulla spinalis or the axis of the spinal portion of the nervous system.

2. The *cranium*, essentially composed of vertebræ; but here, in consequence of the enlarged size of that part of the cerebro-spinal axis of the nervous apparatus placed within them, exaggerated in size and modified in form.

3. Of a frame of bones appended to the anterior part of the cranium for the lodgement of the organs of those senses that are immediately in connection with the encephalon, forming what, taken collectively, is called the *face*.

4. Of a *hyo-branchial* apparatus forming the framework of the throat, and supporting the organs connected with aquatic respiration. These last of course are only present in animals breathing by gills, and can only be expected to exist in a state of complete development in the class of Fishes.

5. Of the *thoracic apparatus*, composed of two sets of ribs—a dorsal and a sternal series—and of the sternum, which itself, when fully developed, is made up of numerous bones.

6. Of a pair of *anterior extremities*, divisible into shoulder, arm, forearm, carpus, metacarpus, and digits.

7. Of a pair of *posterior extremities*, constructed after the same model as the last, and presenting corresponding parts, to which the names pelvis, thigh, leg, tarsus, metatarsus, and toes are respectively appropriated.

The most complete skeleton with which we are acquainted among existing Vertebrata is that of the *Crocodyles*, the study of which cannot be too strongly recommended to the comparative osteologist, as in these creatures all its parts remain permanently in a medium condition, so that the arbitrary divisions of the skeleton adopted by the human anatomist are at once recognisable, although we find others which in Man have no existence. The spine is divisible into a cervical region (*fig. 432, a, b*) interposed between the cranium and the thorax, although ribs (*o*) are appended even to the cervical vertebræ. The dorsal region (*b, c*) supporting the thoracic ribs, the lumbar (*c, d*), the sacrum (*e*), and the caudal (*f*) are distinguishable for the same reasons as in the human subject, notwithstanding that the caudal portion resembles anything rather than the human *os coccygis*; for here, so far from its being formed merely of the rudiments of the bodies of almost obliterated vertebræ, the processes form very powerful levers, and of these there are some developed inferiorly (*g*) of which no vestiges exist in the human skeleton. The bones of the cranium and face are far more numerous than in the skull of our own species, as we shall explain more minutely hereafter: see *fig. 441*, where they are delineated on an enlarged scale. The thorax consists of dorsal ribs (*l*) and of sternal ribs (*m*), which are equally important elements of the skeleton and of the sternum, here situated much as in the human subject. Behind the sternum, moreover, and extending from it quite to the pubic bones, there is in the Crocodile a set of ventral ribs (*k*) to which in Man there is nothing analogous,

except, perhaps, the tendinous intersections still lingering in the recti muscles of the abdomen. The shoulder (*p, q*) consists, like the pelvis (*h, i*), of three distinct and important bones, while all the pieces entering into the formation of the extremities very nearly resemble what is met with in the human subject.

Having premised thus much, we may now, without further preface, plunge more deeply into our subject, and, taking in detail all the elements that are recognised by modern anatomists as belonging to the osseous system, examine them separately in the various aspects under which they present themselves in the different classes composing the Vertebrate portion of animated nature.

Spinal column.—Commencing our analysis of the skeleton by an examination of the spine as being the most essential portion of the osseous system, the primary or central part to which all others that are met with in the different classes of Vertebrata may or may not be superadded in accordance with the conditions under which they are appointed to exist, we shall soon perceive that both in texture and composition it offers very important varieties. In the Myxine and Lampreys it is a simple stem of extremely soft cartilage, almost gelatinous in its consistence, which traverses the axis of the body, presenting, when superficially examined, no appearance of division into separate vertebræ; and it is not uninteresting to observe how, advancing from this simplest form of spine through various tribes of Fishes, its separation into distinct pieces is gradually effected. But even in the Lamprey, on strict examination, there are perceptible in the arches that embrace the spinal canal and on the surface of the soft cord that represents the bodies of the vertebræ, slight indications of an incipient division into vertebral pieces, which are represented by slender rings of ossific matter that encircle at intervals the soft cartilage upon which they sensibly encroach. In a more advanced form of the spine, these ossified rings are considerably increased in their relative proportions, and encroach further and further upon the cartilaginous stem until they penetrate even to its centre, and are then no longer dubiously the representatives of the bodies of so many vertebræ. In the generality of Fishes, indeed, the central part remains unossified, so that a cartilaginous axis traverses the vertebral column from end to end. At last even this is obliterated, and the vertebral centres are completely formed.

But even before the bodies of the vertebræ are thus perfected, the laminae destined to enclose and protect the spinal cord are fully formed by the deposition of osseous matter, as may be readily seen in the Sharks and Rays and many other cartilaginous Fishes, in which, although the complete consolidation of the body has not yet been achieved, the spinous and other processes destined to form the fulcra upon which muscular action is to be exerted are so ossified as to afford the needful solidity and strength. In these races of Fishes, indeed, the condition of the spinal column is not a little remarkable, inasmuch as in the *Skates* the anterior vertebræ are so consolidated by an

Fig. 433.

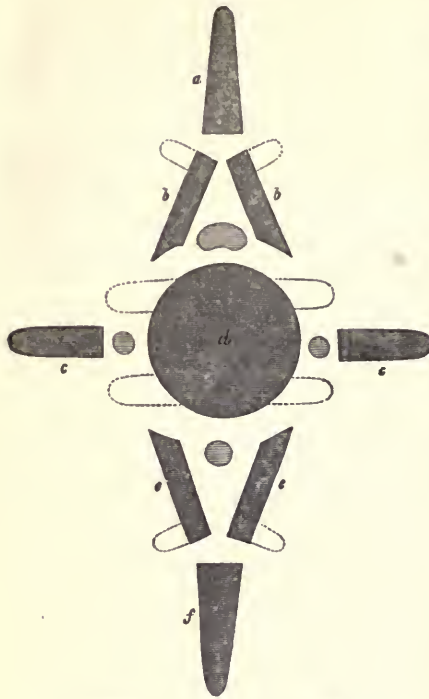

Elements of a vertebra (after Owen).

encrustment of bone as to resemble a single mass; and in both the Rays and Sharks there are many more laminae enclosing the spinal canal than there are bodies of vertebrae, bony plates being developed over the junctions of vertebral centres with each other as well as in the usual situation,—a circumstance which might at first sight seem to militate against the views adopted by modern physiologists concerning the elemental constitution of this part of the body, but from which, in reality, no legitimate inference is deducible, seeing the extremely confused and incomplete progress of ossification in all the cartilaginous Fishes.

Advancing to the osseous Fishes, such confusion no longer exists, and every vertebra assumes a precise form corresponding with the particular uses assigned to it in the region which it occupies. Before, however, proceeding further, it behoves us to resolve an isolated vertebra into the primary elements of which it may itself be made up, and then we shall understand how all the varieties of shape presented by these bones are easily obtainable by the simple exaggeration, diminution, or suppression of some of the elements composing it.

Geoffroy St. Hilaire was the first anatomist who pointed out the importance of thus analysing the different portions of the osseous system, and the views which were promulgated by that learned writer were generally adopted until Professor Owen, in the course of his researches concerning the composition of the skeletons of extinct British Reptiles, was led, as we think very justly, to modify considerably the views which had been previously entertained upon this

subject; we cannot therefore do better than lay before the reader the conclusions deduced by Professor Owen from a very elaborate and extensive survey of the various forms of the skeleton.

“A vertebra,” says Professor Owen, “may be traced through its various degrees of complication, either during the progressive stages of its development, or by taking permanently-formed vertebrae of different grades of complexity in different animals; or in many instances by comparing the vertebrae in different parts of the spine in the same animal.”

The terminal vertebrae of the tail in most species exhibit the simplest condition of these bones. The most complicated vertebrae are those of the lower part of the neck of certain birds, as the Pelican, or at the beginning of the tail of a Python or other large Serpent.

The parts or processes of such a vertebra may be divided into *autogenous*, or those which are independently developed in separate cartilages, and *exogenous*, or those which shoot out as continuations from these independent constituents. The autogenous or true elements are—

1. The *centrum* or body of the vertebra (fig. 433, *d*), which in Mammalia, as Cuvier has observed, is complicated by two *epiphyses*.

2. Two superior laminae (*b, b*) developed to protect the great nervous cord which rests on the upper surface of the centrum, and which Professor Owen therefore proposes to call *Neurapophyses*.

3. Two inferior laminae (*e, e*) developed generally to protect the great bloodvessels on the under surface of the centrum, and which may be called *Hamapophyses*.

4. The superior spinous process (*a*) which is connected and generally ankylosed with the distal extremities of the *neurapophyses*, and forms, in conjunction with those processes, the superior arch of the vertebra.

5th. An inferior spinous process which is connected and commonly ankylosed with the distal extremities of the *Hamapophyses*, forming in conjunction with these a chevron or V-shaped bone.

To the category of autogenous vertebral pieces likewise belong the ribs (*c, c*), which are generally ankylosed to the other vertebral elements in the cervical, sacral, and caudal vertebrae of the warm-blooded Vertebrate classes.

The propriety of regarding the ribs as vertebral elements is well illustrated in the *Plesiosaurus*, in the cervical, sacral, and caudal vertebrae of which they have been generally described as transverse processes, although they are separate bones.

True transverse processes are always *exogenous*, or mere projections from the centrum or the *neurapophyses*, and are of secondary importance. They are of two kinds, superior and inferior; both are present in the cervical vertebrae in most classes of the vertebrated animals; the inferior transverse processes alone are developed in Fishes.

The oblique or articulating processes are also exogenous, and may be developed either from the *neurapophyses* or the base of the superior spines of the vertebrae.

As in other complicated bones resulting from

Fig. 434.

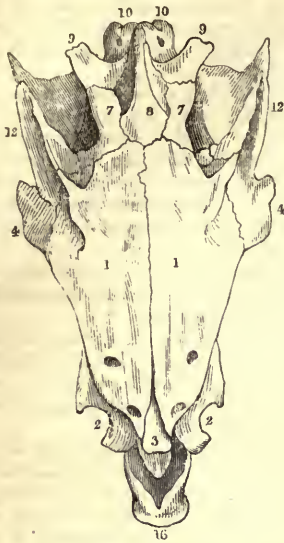
*Skull of the Perch (Perca fluviatilis), after Cuvier.*

an association of several osseous pieces, certain elements of a vertebra may be modified in position and proportions so as to perform the ordinary functions of others which may be atrophied or absent: thus in Fishes the inferior transverse processes are gradually bent downwards until in the dorsal region their extremities meet and perform the functions of the hæmapophyses.

From the vertebral elements named above every possible variety is presented by these bones throughout all the races of animals possessing them. The body alone (fig. 433, d) may be developed without the addition of any of the other parts, as in the terminal bones of a Mammal's

tail or of the human *os coccygis*, or the neurapophyses may exist without an ossified body, as in some cartilaginous Fishes. The vertebrae of the human skeleton present body, neurapophyses, neural spine, and transverse processes, as do the rib-bearing vertebrae of the Fish. The caudal vertebrae of the Fish, in order to give the great vertical expansion required in this region of their skeleton, have the centre, the neurapophyses, and neural spine as well as the hæmapophyses and hæmal spine to the exclusion of the transverse, while in the earlier caudal vertebrae of the tail of the Crocodile (fig. 433, g) all the elements enumerated exist in a medium state of development.

From these data, therefore, the osteologist is enabled to explain the composition of any vertebra that may be offered to his inspection; nevertheless there are numerous apparent exceptions which are well calculated to puzzle the student, met with, especially in the vertebrae of *Serpents* or of the neck of some *Birds*, where the processes are so complicated by the bifurcation of their extremities, or by foramina passing through their roots, or the great size of the articulating processes, or lastly, by the exuberant deposition of osseous matter in particular parts of the bone, that the greatest possible distortion may easily be produced without at all violating the prescribed laws in accordance with which the osseous system is organized. Not unfrequently indeed stunted ribs, or even derivations from the exoskeleton, may become consolidated with the proper vertebral elements in such a manner as not to be readily distinguishable from them, producing additional complications which are sometimes very embarrassing.

Skull.—The osseous framework of the head appended to the anterior termination of the spinal column is by far the most complex part of the skeleton, being composed of very numerous bones connected together by suture or otherwise, but differing marvellously in their

Fig. 435.

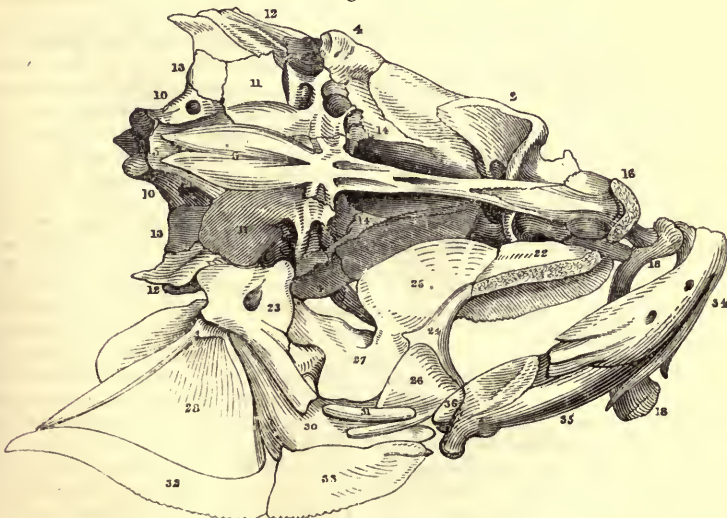
*Base of skull and opercular bones of Perch.*

character and entering into the formation of very numerous and diversified sets of organs, which have in reality no alliance with each other except that of mere juxtaposition.

One compartment in Man, exceeding in size all the rest put together, but in the lower Vertebrata forming but a very small part of the whole, is obviously merely a continuation of the vertebral canal lodging the most anterior ganglia of the cerebro-spinal axis, which it arches over and defends, at the same time affording passage to the nerves that emanate therefrom, being essentially itself composed of vertebrae, although, in consequence of the preponderating size of the brain over the spinal ganglia behind, considerable distortion is required, a distortion which in human beings is necessarily carried to such an extent that the normal construction of this part of the skeleton is in man almost wholly indistinguishable. As the vertebral column forms the centre and support of the trunk and limbs, so does the cranial portion of the skull sustain various additional apparatus, which may be enumerated as follows.

1. The auditory apparatus most frequently enclosed in a special bone, the *petrosus*, and intercalated among the proper bones of the cranium.

2. The *temporal* apparatus, which in man is confused into a single irregular mass that forms part of what the human osteologist calls the *temporal bone*, but which in the lower Vertebrata, such as the Reptilia, consists of several important pieces, which being withdrawn from the composition of the cranial box are employed for the articulation of the lower jaw, and moreover in the osseous Fishes sustain the bones of the gill-covers. (Nos. 12, 13, 23, 26, 27.*)

* The following table, showing the numbers by which the corresponding bones appertaining to the cephalic portion of the skeleton are indicated in all the figures, is given to facilitate comparison between them.

3. The *pterygo-palatine* apparatus represented in the human skeleton by the internal *pterygoid processes* of the (so-called) sphenoid and the *ossa palati*. These form the framework of the fauces. (Nos. 25, 22.)

4. The *olfactory apparatus*, into the composition of which enter the *athmoid*, over which the nerve of smell is more particularly distributed, together with the *nasal*, the *superior maxillary*, the *vomer*, the *inferior turbinated bones*, and others more remotely connected with the formation of the cavity of the nose. (Nos. 3, 20, 16, 18, d.)

5. The *orbito-lachrymal apparatus*, or the bones which assist in forming the orbital cavity and lachrymal passages.

6. The *superior maxilla* formed of the *maxillary* and *intermaxillary bones*. (Nos. 18, 17.)

7. The *inferior maxilla*, which in the lower animals consists of several pieces, to be more fully noticed hereafter.

Before proceeding to describe the individual bones that enter into the composition of the cranial portion of the skull, in order to lay before the reader the comparative structure of that important portion of the skeleton, it will be

- | | |
|---|------------------------|
| 1 Frontal. | 18 Maxillary. |
| 2 Anterior frontal. | 20 Prænasal. |
| 3 Nasal (<i>athmoid</i> , Cuv.) | 22 Palatine. |
| 4 Posterior frontal. | 23 Masto-temporal. |
| 5 Inferior occipital. | 24 Transverse. |
| 6 Sphenoid. | 25 Internal pterygoid. |
| 7 Parietal. | 26 Zygomatic. |
| 8 Supra-occipital. | 27 Squamo-temporal. |
| 9 External occipital. | 28 Opercular. |
| 10 Lateral occipital. | 29 Styloid. |
| 11 Alar. | 30 Præopercular. |
| 12 Mastoid. | 31 Symplectic. |
| 13 Petro-temporal. | 32 Subopercular. |
| 14 Ingrassial. | 33 Interopercular. |
| 15 Ethmoid (<i>anterior sphenoid</i> , Cuv.) | 34 Dental. |
| 16 Vomer. | 35 Supra-angular. |
| 17 Intermaxillary. | 36 Angular. |
| | g Suborbital plates. |

Fig 436.

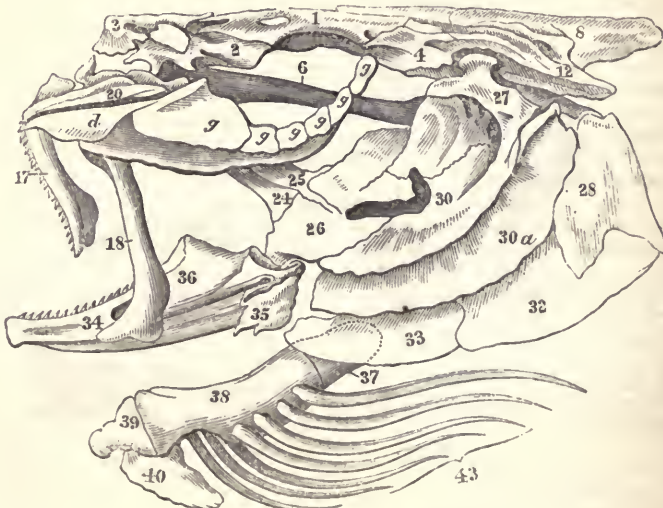

Skull of the Cod (*Gadus Morhua*).

Fig. 437.

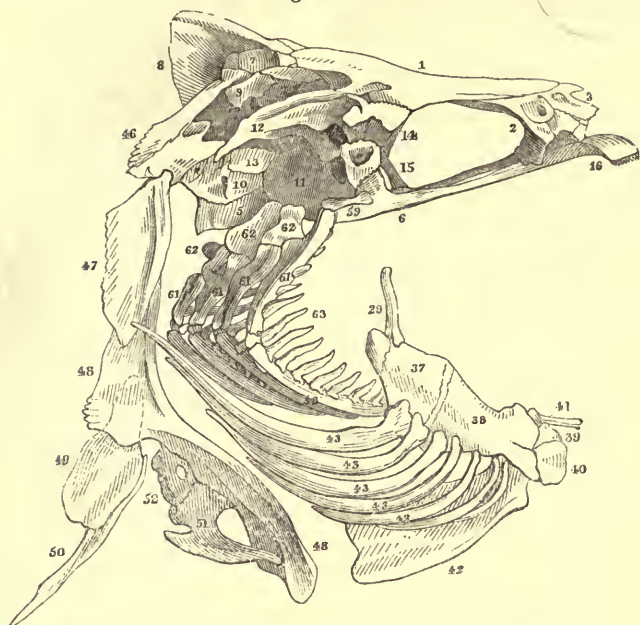
*Hyoid apparatus and branchiostegous rays of Perch (after Cuvier).*

proper to examine how far it is entitled to be looked upon as we have already stated it to be, as forming a continuation of the spinal column, and if so, to define the vertebræ of which it consists. In the human cranium indeed this would be no easy task, partly in consequence of the extreme exaggeration of every element composing it, and partly from the manner in which some bones, distinct in the lower animals, are here consolidated into single masses; moreover in consequence of the prodigious development of the cerebral hemispheres every part is distorted and pushed aside as it were out of its proper situation relative to the neighbouring bones.

In the cranium of the Reptile, however, and even of the less intelligent Mammalia, these difficulties are to a great extent done away with, and the vertebral form is preserved, while, in addition, the elements composing them frequently remain permanently disunited.

The first cranial vertebra (commencing from behind) is the *occipital*, and this can present no difficulty. In Fishes, indeed, and in many Reptiles, the *occipital bone*, of which this vertebra is entirely made up, has not only the exact shape of one of the spinal bones, but the elements composing it remaining often permanently disunited, they are most easily and satisfactorily identified. Inferiorly there is the body (or basilar bone, 5) connected with the body of the first spinal vertebra in the same manner as the corresponding portion of the other vertebræ are connected with each other. On each side the neuropophyses (or *extra-occipital bones*, 10) arching over the commencement of the spinal cord, and lastly, the neurospine (or *supra-occipital bone*, 8) occupying its normal situation, and in many of the lower

Vertebrata forming a real spinous process, although in the human subject, owing to the prodigious size of the hinder part of the encephalon, it is enormously spread out in proportion to the dimensions of the parts it protects.

The second or *parietal vertebra* of the cranium is slightly more distorted, and its real nature masked, particularly in the higher Vertebrata, by the interposition of the petro-temporal bone, which does not normally belong to the cranium, between it and the preceding. Its body is the *sphenoid bone*, represented in the human subject by the posterior part of the *sella Turcica*, but which in Reptiles is a distinct element of the skull; its arches are formed by the *alæ majores* of the *sphenoid*, (likewise separate pieces of the cranium in the lower animals, although in man they are consolidated with the former,) while the spine is converted into the expanded parietal bone or bones spread out over the central regions of the brain.

The anterior cranial vertebra is called the *frontal*, receding still more from the normal appearance of a vertebra than the parietal, the preponderance of magnitude in the different elements that form it being completely inverted; the body being quite rudimentary, while the enormously developed spinous elements are now converted into frontal bones. In man its body and its arches are represented by the *alæ minores* of the sphenoid or *ingrassial* bones, and the *os frontis* constitutes its disproportionately expanded spine. These three vertebræ, therefore, are the essential constituents of the skull; and, although in the human cranium the most aberrant of any met with in creation, their nature is not at once

obvious; it is only necessary for the student to recur to less distorted forms of the head at once to recognise the reality of the resemblance.

Should other proof indeed be wanting, the manner in which all the cerebral nerves make their exit from the cranium would in itself offer a convincing argument. In every other part of the cerebro-spinal axis the nerves invariably are given off through passages situated between contiguous vertebræ, which are called, from this circumstance, *par excellence*, *inter-vertebral foramina*; nay, so sure is this guide, that in those instances where the vertebral pieces are confused, so as to be otherwise undistinguishable from each other, the position and number of these foramina is sufficient to indicate the number of vertebræ of which the part of the skeleton in question originally consisted, before the pieces composing it became permanently ankylosed. Precisely in the same manner the nerves derived from the encephalon pass out through the interspaces between the occipital and parietal vertebræ, or between the latter and the frontal; and, although from the great bulk of the encephalic masses and the number of nerves derived therefrom, the passages through which they principally escape have been named *foramina lucera*, indicating their size and irregularity;

Fig. 438.

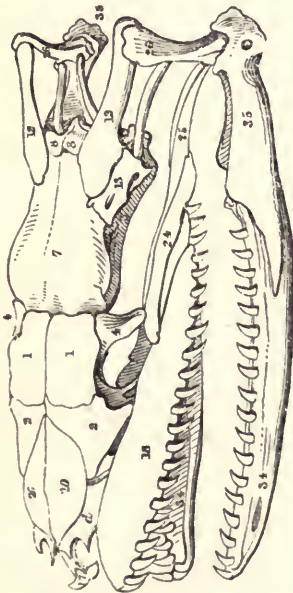
Skull of *Boa Constrictor*.

they are not on that account less the representatives of the intervertebral foramina properly so called. The mere circumstance of the channels of some of these nerves being, in the human subject and in other Mammifera, circumscribed by rings of bone and thus converted into distinct foramina, to which special names have been given by the human osteo-

Fig. 439.

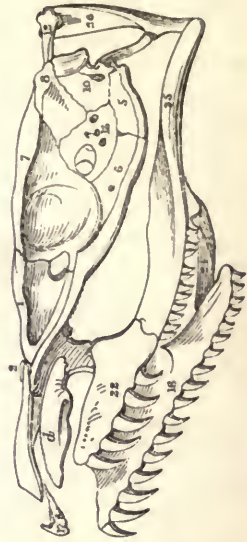
Section of skull of *Boa*.

logist, militates in no degree against the grand fact that it is between the cranial vertebræ they all make their exit.

Having given the above general view of the composition of the osseous skeleton, a more difficult task now remains to be accomplished, viz. to identify and compare with each other the individual bones entering into the composition of the osseous system throughout the different vertebral classes, and thus to analyse the entire fabric. Various and conflicting indeed are the opinions of different writers on this important subject, of whose names and works an ample list will be given in the Bibliography affixed to the end of this article; but to enter into the argumentation of disputed points would of course be impossible in our prescribed limits. Suffice it to say, that the views of the acute and sound-judging Cuvier have been principally adhered to, and where occasion has been found to dissent from his opinion we have expressed our reasons for so doing.*

Bones of the cranium.—*Frontals* (1). These bones in fishes form the roof of the orbit and the anterior portion of the cranial box, having in front and behind them other pairs of bones forming the anterior and posterior boundaries of the orbit which correspond with the anterior and posterior frontals in Reptiles. In the *Frog* the whole of the anterior portion of the cranium is made up of a single bone, which entirely surrounds it like a ring or girdle, and represents the two frontal bones of Serpents

* We must here especially acknowledge our obligation to Professor Owen, who has most kindly placed at our disposal the result of his researches concerning the homology of the cranial bones of Fishes: his opinions have been introduced in their proper places.

(fig. 438, 1) united together. In the *Siren* and *Proteus*, however, the principal frontals are divided as in other Reptiles. In all Birds and Mammalia these bones become at an early period confused with the anterior and posterior frontals and ultimately with each other, so as to form but one piece, the *os frontis* of man; nevertheless, even in the human fœtus, they are separated by a suture which, in the lower Mammalia and also in the human subject, is not unfrequently persistent to a late period of life.

The *anterior frontals* (2) in the osseous Fishes bound the orbit anteriorly. Between these bones pass out the olfactory nerves, but they are not always distinctly recognisable, being occasionally permanently cartilaginous. In Reptiles these bones are generally distinct, but in Birds and Mammalia they coalesce with the preceding.

The *posterior frontals* (4) form the posterior margin of the orbit, and are present in Fishes and the Reptilia, but in Birds and Mammifers they are no longer recognisable as distinct bones.

The *parietal bones* (7) are placed behind the frontals; but these bones do not always touch each other, being separated, especially in Fishes, by the interposition of an azygos bone from which projects the occipital spine, which is frequently, more especially in Fishes, of very good size: this impair bone, the *interparietal* of some authors, is in reality the representative of the *superior occipitals* of Cuvier (*supra-occipitals*, Owen;) (8) and in some Fishes, especially in the *Siluri*, where the parietals are totally wanting, their place is supplied by the enormous development of this element of the skeleton.

The *external occipitals* (9) contribute to form

the lateral portions of the occipital region of the skull, in conjunction with two other pieces called

The *lateral occipitals* (10), which partially bound the foramen magnum.

The *inferior occipital* or *basilar bone* (5) is that which invariably is articulated to the body of the first cervical vertebra, but occasionally in Fishes there are two additional articulations connecting the cranium to the spinal column formed by the lower portions of the lateral occipitals. All these elements of the so-called occipital bone of the human cranium remain permanently distinct in Fishes and Reptiles, and even in the fetal condition of Birds and Mammals are more or less recognisable; but they soon coalesce into one large piece that enters largely into the formation of the cranial box, and constitute the first or occipital cranial vertebra, as has been already seen.

The *sphenoid* (6) invariably occupies the central portion of the base of the cranium, and in Fishes and Birds is prolonged anteriorly into a lengthy process which passes beneath the interorbital septum, which, in these classes of Vertebrata, remains most frequently membranous.

The *alar bones* (11; *als-sphenoid*, Owen,) represented in the human subject by the greater alæ of the sphenoid, are in reality distinct elements of the cranium, and are recognizable by several important characters, especially by their position being joined by suture to the posterior frontal, and, conjointly with the latter bone, to the temporal. Moreover, through these bones the two posterior divisions of the fifth pair of nerves always pass out from the skull. In Fishes and Reptiles they are important pieces and quite detached from the sphenoid.

The squamo-temporal bones, Owen (*mastoid bones*, Cuv.: 12) in Fishes are manifestly the representatives of the bones so named in Reptiles. They contribute in conjunction with the posterior frontal, and occasionally with the alar, to furnish the articular surface that sustains the first bone of the palatine and tympanic apparatus, or, in other words, of the masto-temporal (23).

The *petro-temporal bones*, Owen, (13) are in Fishes placed between the mastoid, the lateral, occipital, and the alar bones. They are generally of small size, but occasionally, as in the *Gadidæ*, very largely developed, descending to reach the inferior occipital and the sphenoid. On the other hand, they are frequently entirely wanting, as, for instance, in the Pike, the Carp, and the Eel.

In all the Reptilia the petro-temporal bones are recognizable as distinct pieces forming part of the cranial box, and become interesting, inasmuch as it is in them that the auditory apparatus is lodged.

In Birds and Mammalia, however, the petrous bones become at an early period inseparably soldered to the other pieces, forming the so-called "temporal bone."

The *ingrassial bones* (14), as they have been named by Geoffroy, are, in the human subject, regarded as portions of the sphenoid, although

Fig 440.



Section of the skull of Turtle (*Testudo Myas*).

in reality they are distinct elements of the skull. In the higher Vertebrata they are consolidated with the sphenoid, and have received the names of *alæ minores* or *apophyses ingrassii*. Above these pass out the olfactory and beneath them the optic nerves, a circumstance which in itself sufficiently indicates their real nature. Sometimes, as in the Carp, they are united together inferiorly, so as to form a roof over the optic nerves.

The *æthmoid*, Owen (*anterior sphenoid*, Cuv.: 15,) so highly developed in the carnivorous Mammalia, is in the lower Vertebrata reduced to an extremely simple condition. In Fishes (fig. 437) it is generally distinct enough, forming the posterior boundary of the interorbital septum, but sometimes it is quite wanting or represented by membrane. When present, it is generally placed upon the sphenoid, sending off processes to join sometimes the ingrassial bones, sometimes the alar bones, or occasionally to remain suspended in the interorbital membrane that unites all these parts. The *æthmoid* appears to be deficient throughout all tribes of Reptiles. In Birds it is recognizable as a bone of considerable size, separating the posterior parts of the orbits, which it assists in forming the two lateral facets that enter into the composition of those cavities corresponding with the *ossa plana*, as they are called, of the human subject; but these are obviously only portions of the *æthmoid* itself. In the Mammalia, owing to the prodigious development of the olfactory apparatus, the *æthmoid* becomes extremely increased in size and importance, closing the anterior extremity of the cranial box, where it is perforated so as to present a central *crest* and *cribriform plate*, while inferiorly it has superadded to its body the *superior turbinated osseous lamelle* that enter so largely into the construction of the olfactory organ.

The *vomer* (16) is in Fishes a large and important bone, joined posteriorly to the sphenoid and above to the *æthmoid*, forming a vertical portion, on each side of which are situated the organs of smell. Inferiorly it forms part of the roof of the mouth, and is often armed with teeth. Throughout all the Vertebrata this portion of the skeleton holds an analogous position and is recognized with facility. In Frogs and Lizards the bone is double, but in Tortoises and the higher animals generally there is but a single *vomer*, which enters more or less into the composition of the nasal septum.

The *nasal bones*, Owen; (*æthmoid*, Cuv.: 3) in Fishes are represented by a single bone impacted between the mid-frontals and the pre-frontals, and inferiorly joined to the vomer, forming a kind of septum between the nasal organs, and thus in position resemble somewhat the vertical lamella of the *æthmoid* of Mammalia. Sometimes, as in the Eel and the Conger, the bones in question are inseparably united into one piece. In the higher animals the nasal bones are two in number, covering the nasal cavity like an arch. They are present in all Reptiles except the Chelonians, and in Birds and Mammals are easily recognizable from their position.

The *inferior turbinated bones*, although in consequence of the construction of their nose quite wanting in Fishes, must not be omitted in enumerating the elements composing the skull in higher animals. In the humbler Reptiles, indeed, no traces of it are distinguishable; but when the olfactory apparatus becomes fully developed, as in the Mammalia, they form an important part of the nasal character, and are found of large size, connected inseparably with the bones that surround the nose.

The bones of the face have been already considered as constituting a very complex framework, destined to lodge the organs of the principal senses or to constitute the instruments appropriated for the prehension or mastication of food. Seeing, however, that the same bone not unfrequently enters into the composition of several distinct cavities, we are unable to classify them further, and must therefore content ourselves with enumerating them *seriatim* as they occur to our notice.

The *maxillary* (18) perform only a secondary office in forming the upper jaw of a Fish, being in the finny tribes generally destitute of teeth, which in them are principally implanted upon the intermaxillary (17) that form the greater portion of the upper jaw. The *maxillary* in Fishes is moveably articulated with the intermaxillary, the vomer (16), and the palatine (22). Sometimes, as in the Herring and Lepisosteus, this bone is divided into several pieces. In Skates and Rays the whole upper jaw is made up of a single ossified mass, which bears the numerous rows of teeth attached to its under surface.

But in all Reptiles, in Birds, and in Mammalia the maxillary bones form the principal portion of the upper jaw, more particularly in the Mammalia, where the intermaxillary bones are comparatively of small size. In this portion of the upper jaw are fixed the grinding teeth, where such are present, a circumstance which in itself demands great strength in this part of the face; and, consequently, wherever power of jaw is required to be conferred, it is principally obtained by the increased development of this element of the skeleton, which thus becomes the largest and, as it were, the central bone of the whole fabric.

The *intermaxillary bones* (17) form the principal part of the upper jaw in Fishes, and upon their shape depends that of the snout. Sometimes these bones are flattened horizontally, or compressed laterally, or prolonged into a beak, their form being modified by circumstances in almost every genus. In the Chondropterygii, nevertheless, they are mere rudiments imbedded in the substance of the upper lip. They are persistent throughout all orders of Reptiles, Birds, and Mammals, until we arrive at the Quadrumana, where they become ankylosed with the maxillary, and in Man they are quite obliterated at an early period.

The bones of the face in osseous Fishes are exceedingly numerous and irregular, neither is it easy to identify many of them as being at all analogous to those which normally make up the face, even of those Reptiles which present

Fig. 441.

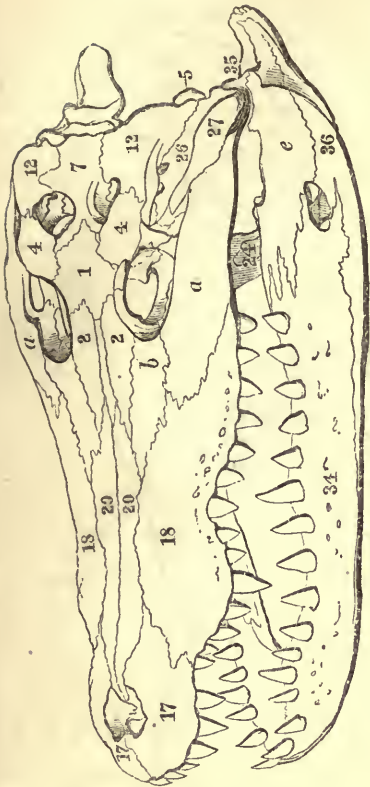

Skull of the Crocodile of the Nile.

the most complicated condition of this portion of the skeleton. The higher cartilaginous Fishes, however, (*Chondropterygii*,) form a very remarkable exception; for in the *Rays* and *Sharks* the face is reduced to a very simple condition, in consequence of the want of separation between the different pieces of the skeleton, consequent on the permanently cartilaginous state of the osseous system in these tribes.

The *suborbital bones* in Fishes (fig. 437, *g, g, g, g*) form a kind of chain composed of a very variable number of pieces which surround the inferior and external margin of the orbit, covering the muscles of the face instead of giving attachment to them, a circumstance which induced Cuvier to believe that they did not normally belong to the series of facial bones. They are doubtless referable to the *exo-skeleton* or *cuticular bones* so largely developed in some fishes, and in this light they will be considered in another place.

The *prænasal bones*, Owen; (*nasal bones*, Cuv.) of a Fish (fig. 436, 20) are found in a situation very analogous to that which they occupy in the higher Vertebrata. They form the internal boundaries of the nasal chamber, and articulate superiorly with the frontal (1). These bones are regarded by Professor Owen as being the representatives of the

moveable cartilages of the nose of other Vertebrata ossified and entering into the composition of the facial skeleton.

Besides the suborbital chain of bones (*g, g, g, g*) above mentioned as partially surrounding the orbit, and which in the *Gurnards* and other hard-cheeked Fishes cover the cheeks as with a bony case, entitling them to the name applied to them by Cuvier of "*joues cuirassés*," another chain of bones called the *supra-temporal* is not unfrequently met with, placed on each side, over the interval that separates the external from the middle prominent ridge, developed from the exterior of the cranium so as, together with these projections, to cover the articulation of the supra-scapular bone (46). These bones are evidently peculiar to Fishes, and, like the suborbital, must be referred to the *exo-skeleton* and not deemed to belong properly to the *o-sseous system*. In this light they will be considered in another place.

Fig. 442.

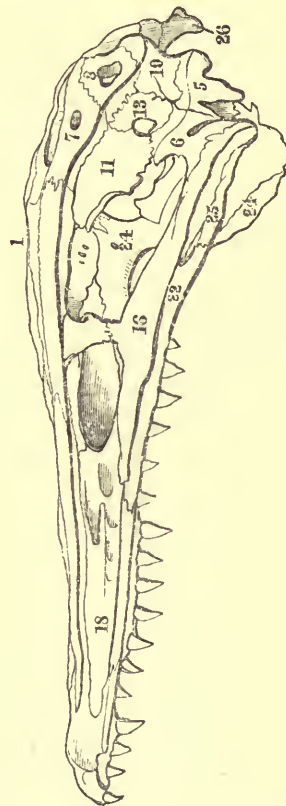

Section of Crocodile's skull.

The palatine arch or osseous roof of the mouth is composed of analogous bones in all the different races of Vertebrata; but in the lower Vertebrata there are found in connection with this region of the skeleton several pieces that have no representatives in the higher classes.

The *palatine bones* (22) are easily recognisable in Fishes, occupying the same place as in Serpents (*fig. 439*), and, moreover, further distinguished by being frequently armed with teeth which project into the roof of the mouth. In Reptiles, also, teeth are often attached to them where they assist in forming the cavity of the mouth. These bones are found in all the vertebrate classes.

The *transverse bones* (24) occupy nearly the same situation in Fishes as in Reptiles, but in the latter they are most distinctly seen. In the Crocodile each is a bone of considerable size, composed of three branches and extending between the pterygoid bone and the junction of the jugal, the maxillary, and the posterior frontal. This bone is not met with, either in Birds or Mammalia, not even in the fœtal period of their existence.

The *internal pterygoid bones* (25) are likewise distinct in fishes, stretching between the

Fig. 443.

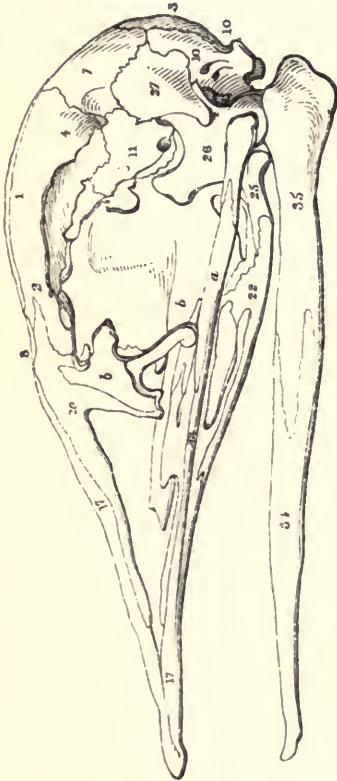
Skull of a young Ostrich (*Struthio Camelus*).

palatine bone and that which supports the lower jaw (26). In Reptiles they are large and important detached bones, occupying the position of the pterygoid processes of the sphenoid; but in Birds and Mammals they become completely ankylosed with the sphenoid, so that, by the human osteologist, they are erroneously regarded as apophyses of that bone.

Fig. 444.



Section of skull of young Ostrich.

The *zygomatic*, Owen, (*jugal*, Cuvier,) are in Fishes broad pieces, generally of a triangular shape, placed behind the transverse, which by their inferior angle support the articulation of the lower jaw. In Reptiles, too, it may always be distinguished by the latter circumstance, and in Serpents it is particularly remarkable (*figs. 438, 439, 26*), standing out from the squamo-temporal (*mastoid*, Cuv.) like a branch, and thus giving that extraordinary mobility to the articulation of the inferior maxilla which enables those Reptiles to swallow prey so disproportioned to the size of their mouths. In other Reptiles this mobility is in a great degree lost. But in Birds the zygomatic bones again assume very important functions. They are here known by the name *ossa quadrata*, and standing out to a considerable distance from the skull allow of great mobility to the zygomato-maxillary articulation, and also to the bones supporting the superior maxilla. In Mammalia this zygomatic bone is so firmly and undistinguishably united to the temporal that the human osteologist merely calls it the zygomatic process of that bone.

The *masto-temporal*, Owen, (*temporal*, Cuv 23), are in Fishes and Reptiles distinct elements of the skull, which in the human cranium are consolidated with the other elements composing the "*os temporis*."

The *styloid bones* (29), mererudiments in the human skeleton, anchylosed with the rest of the temporal bone, of which they are called the "styloid process," in the water-breathing Vertebrata are distinct pieces interposed between the os hyoides and the base of the skull, serving to unite the former to the latter.

The *symplectic bones* (31) seem to be peculiar to Fishes; they accompany the transverse, and assist in connecting the articulation of the lower jaw with the pterygo-palatine apparatus.

The *lower jaw*, although in the adult human subject formed of a single piece, in the *fetus* consists of two lateral halves united by a symphysis, as it is permanently in many of the lower Quadrupeds. In Reptiles and Fishes, however, each half consists of numerous pieces, to which distinct names have been given by the comparative anatomist. In the Crocodile and most reptiles there are six in number, viz. the *dental portion* (34), in which are situated all the alveoli of the teeth, uniting with its fellow to form the symphysis of the jaw.

The *opercular*, covering almost all the inner aspect of the jaw except in front.

The *angular* (36) and the *supra-angular* (35), placed one above the other, reaching quite to the posterior extremity of the jaw. In the Crocodile they leave between them a considerable space occupied anteriorly by the end of the dental portion, and then by a large oval aperture.

The *articular* (e), bearing the articular process, whereby the jaw is connected with the skull. Likewise another small and unimportant plate of bone sometimes seen on the inner aspect of the inferior maxilla.

In the Chondropterygious Fishes the lower jaw is made up of only one bone, the *articular*, upon which the teeth are affixed: rudi-

Fig. 445.



Human Skull.

ments of the others are, however, met with imbedded in the flesh beneath the skin.

The *hyo-branchial apparatus*.—The osseous framework to which in the human subject the name of *os hyoides* has been appropriated, from the trivial circumstance that in the simple condition under which it presents itself in man it resembles the Greek letter ν , is found in the lower Vertebrata to be permanently composed of very numerous pieces, which are made subservient to respiration, and from their size and number render the whole apparatus, which they assist in forming, really worthy of the name of an anterior thorax. The hyoid system of bones may indeed be regarded as being in some respects vicarious in function with the true thorax, the former belonging especially to the aquatic, the other to the aerial mode of respiration; whilst, therefore, as in Fishes, the gills form the only means of breathing, and the branchial arches exist in their full state of development, the hyo-branchial apparatus is complete and preponderates in importance over the thorax; but, in proportion as pulmonary respiration is established, as we ascend the scale of animal existence, the thoracic system of bones assumes the principal duties connected with the inspiration and expiration of air, and the os hyoides dwindles into a very rudimentary condition. The above circumstances however, interesting as they are when a mere comparison is instituted between the hyoid bones of various animals as to their composition when in the adult state, assume additional importance when we reflect that all the higher Vertebrata possess in the earlier stages

Fig. 446.



Human Skull.

of their life a true branchial apparatus, which subsequently becomes absorbed to give place to thoracic or pulmonary respiration, and consequently they are furnished in the first portion of their existence with the hyoid system of a fish, which, passing through different phases of gradually diminishing complexity, is slowly converted into the simple form it presents in their mature or adult condition. So diversified, in fact, is this portion of the osseous skeleton in the different classes of Vertebrata, that the anatomist only acquainted with human osteology would never be able to recognise the analogy between what he sees in man and the condition in which it exists in its more complicated states, or at all understand the metamorphosis which it undergoes in the embryo of Mammalia, without tracing it through all its forms, as we shall now proceed to do with as much brevity as is compatible with our subject.

In the Fish the os hyoides is situated as in all the other Vertebrata, and is composed of twelve bones. It consists of two branches, each made up of five distinct elements, namely, the styloid bone (29), which suspends it to the temporal; two broad lateral pieces (fig. 436, 37 and 38) placed one behind the other, and two small bones (39 and 40) placed one above the other at the anterior extremity of each branch, and forming with their fellows of the opposite side a kind of symphysis uniting the two halves of the bone. In front of this symphysis is a single bone, the *lingual* (41) situated as in Birds and Reptiles, and behind in the angle formed by the union of the two branches another azygos piece representing the *tail of the os hyoides* so distinct in Lizards and in Birds. This latter piece becoming joined to the symphysis of the humeral bones forms the isthmus that inferiorly separates the two branchial apertures of the fish.

Appended to the inferior and external margin of each branch of the os hyoides of a fish, are the *branchiostegous rays* (fig. 437, 43), destined to support the branchiostegous membrane that completes the gill-covers. These are very various both in number and form in different fishes; they are fixed to the os hyoides by distinct articulations, sometimes by simple ligaments. Autenrieth and Geoffroy suppose these branchiostegous rays to be the representatives of sternal ribs, but doubtless they belong rather to the exo-skeleton.

To facilitate, however, a comparison between the above complicated series of bones and the corresponding pieces met with in other classes, it will be advisable to lay before the reader the result of the elaborate analysis of this part of the skeleton made by Geoffroy St. Hilaire, whose names applied to the various elements composing it are not only classically elegant, but from their simplicity will save much useless circumlocution. When complete, the distinguished anatomist alluded to considers the os hyoides to consist of the following parts: The body or *basihyal* piece, forming the central portion of the fabric; the *urohyal* or *tail* of the os hyoides (fig. 437, 42); the *ento-hyal*,

a piece sometimes interposed between the two former; two *glossohyals* or posterior cornua; two *apophyals* (39) forming the first pieces of the anterior or styloid cornua; two *ceratohyals* (40) forming the second pieces of these branches; and lastly, two *stylohyals* (29), which are represented in the human subject by the styloid processes of the temporal bone.

Appended to this hyoid apparatus are a series of lateral arches emulating in their importance the ribs in the water-breathing Vertebrata, and indeed somewhat resembling them in structure and arrangement, along which run the branchial vessels to the gills, and subsequently from the gills to form the aorta. These arches have in fact, by some continental anatomists, been actually looked upon as representing the thorax of Vertebrata that respire the air, but with little reason, as must be evident on considering how, as the real thorax is called into play, these are gradually absorbed and disappear.

The *branchial arches* of a fish, from which are suspended the branchial fringes, consist on each side of four chains of bones adherent by their inferior extremities to an intermediate series of ossicles, which is connected anteriorly with the symphysis of the os hyoides between the four anterior elements of that bone and above its *tail*. Superiorly the branchial arches are fixed by a ligamentous attachment beneath the cranium.

The series of intermediate bones with which the pairs of branchial arches are connected inferiorly, are placed behind the lingual and are three in number, forming a kind of little sternum to the hyoid apparatus. Each of the branchial arches consists of a superior and inferior portion that are moveable upon each other. The inferior portion (fig. 437, 58) is that connected with the intermediate chain of bones, and in the anterior three pairs of arches this is formed of two pieces. The posterior pair has this part composed of only one piece. The upper portions of the branchial arches are made up of a single bone. The three posterior (fig. 437, 61) support the *pharyngeal bones* (fig. 437, 62), while the anterior is attached to the skull by the intervention of a little style (59), which might be regarded as the pharyngeal bone belonging to this pair.

Internally all the branchial arches are provided with osseous plates or ridges which are generally covered with teeth. These perform in some degree the function of the epiglottis of Mammalia, inasmuch as they prevent anything taken into the mouth from getting into the gills along with the water as it passes to the respiratory organs.

The *pharyngeal bones* are peculiar to Fishes, and are situated in the throat, where they powerfully assist in masticating the food. There are usually two inferior and six superior. The inferior (fig. 437, 56) are attached behind the branchiæ in the angle formed by the last pair of branchial arches; they are generally of a triangular shape, and form a kind of floor to the pharynx. The upper pieces (fig. 437, 62) are three in number on each side, each

attached to the extremity of the upper portion of one of the three last branchial arches.

Condition of the os hyoides

in Reptiles.—The condition of the os hyoides in a perfect Reptile is very simple when compared with that of the Fish, or even, as is most strikingly apparent in the amphibious Reptilia, with that which it exhibits previous to the accomplishment of the metamorphosis which changes the mode of respiration from that of a fish into that of the Frog. In the adult Reptile, indeed, the composition of this bone gives no indication of its previous complexity of structure, consisting only of the remains of the anterior cornua (26, *a*) and a broad hatchet-shaped disc forming the body of the bone. In Lizards its structure remains more complicated, resembling that of Birds. The body is generally simple, with two and sometimes three sets of cornua-like appendages connected with it. From the fore part of the body projects a long and slender process, more or less cartilaginous, which penetrates the substance of the tongue. The anterior pair of cornua are variously folded, and the posterior placed differently in different genera; while the third pair, which is but seldom met with, seem rather to be prolongations of the body of the bone than separate elements appended to it. In the Chelonian Reptiles the hyoid apparatus varies remarkably in form in different species. It generally consists of a central part, which is frequently itself divisible into several pieces, and of two or sometimes three pairs of cornua. Moreover, beneath the anterior part of the body, there is suspended a bone or cartilage, which is sometimes double and represents the special bone of the tongue, which in Birds is articulated to the fore part of the body of the os hyoides.

The *os hyoides* of the Crocodiles is the simplest met with in the class of Reptiles, its central portion being a mere broad cartilaginous plate, convex below, concave above; its anterior part having a semicircular form, while its posterior margin is hollowed out into a concave edge; there are no remnants of cornua visible, and the os hyoides here seems to perform the duties of epiglottis, hyoid, and thyroid cartilage.

Metamorphosis of the os hyoides.—Professor Bell having already described the most remarkable changes which the branchial apparatus of the Frog undergoes during its metamorphosis, it would have been needless to recur to the subject again in this place, were it not for the purpose of collating the facts there recorded with the series of changes we are now discussing, and indicating the nature of the respective bones delineated in a preceding

Fig. 447.



volume (vide Article AMPHIBIA, vol. i. figs. 21, 22, 23, 24, 25, 26). We shall, however, embrace the opportunity afforded of adding a few circumstances to those there recorded, extracted from the observations of M. Martin St. Ange, connected with this most remarkable and interesting process.

Some days before the birth of the Tadpole the os hyoides consists of a single median piece, of a pair of broad cartilaginous plates situated on each side of the former, anteriorly, and of two other similar plates occupying a like position behind, to each of which last are appended four separate styloform pieces representing the branchial arches, making thirteen pieces in all.

Examined a little after birth, the whole cartilaginous frame-work is found to have increased considerably in breadth, more especially the eight last-mentioned cartilaginous styles upon which the branchial vessels run, sufficiently indicating their nature—moreover, they become united together by their distal extremities so as to form a series of arches, as represented in fig. 21, vol. i. p. 98, at *c*. At this point of its development the hyoid system of the Frog is at its maximum of complexity, and we will therefore pause to examine the elements that enter into its composition. The median piece (fig. 21, *b*, vol. i. p. 98) represents, according to Geoffroy, the *glossohyal*, *basihyal*, and *urohyal* elements of the Fish. The elements marked *a* will be the *stylhyal* bone, suspending the whole from the tympanic bone of the skull (*e*), while the broad pieces *c, c*, regarded by the same author as being dismembersments of the larynx, immediately sustain the branchial arches.

At that period, when in consequence of the changes that take place in the circulation of the Tadpole the branchial vessels are to be obliterated, the condition of the os hyoides too becomes rapidly changed. The cartilaginous arches become diminished, especially in length, and at last become completely absorbed excepting two remnants, which are found appended to

the posterior margin of the os hyoides even in the adult Frog, although they remain for a very long while in a cartilaginous condition. The two pieces *a*, *a*, then speedily become diminished in breadth, and the whole shape of the os hyoides approximates that of the adult Frog, the condition of the pieces marked *a*, *a*, forming the chief difference between them. This at length becomes gradually more slender and elongated, assuming at last the shape delineated in *fig.* 26, vol. i. (*a*), where the permanent and complete condition of the os hyoides of this Reptile is fully established.

The different pieces composing the os hyoides of a Bird having been already described and figured (*vide* Article AVES, *fig.* 151), it only remains for us in this place to complete our review of the hyoid apparatus by examining its condition in the Mammiferous races, in which it is found gradually to become stripped of many parts that before entered so conspicuously into the construction of this portion of the osseous frame-work of the throat, and assume a simplicity of structure that progressively assimulates to the shape it presents in the human subject, in which alone indeed the name of *hyoides* is at all applicable. In Man, observes Geoffroy, the os hyoides is generally said to consist of a body and four symmetric pairs of branches or cornua. The anterior cornua (superior when man stands in the erect posture) are reduced to mere rudiments, but in those Mammalia that have the head elongated these anterior cornua are very largely developed, appended from the sides of a special pair of bones, the *styloids*, which, although in mankind they are reduced to simple and almost useless apophyses, consolidated with the temporal bones in the generality of Mammifers, are very large and important pieces, so connected with the anterior cornua that they are frequently regarded as being additional parts of the os hyoides. But although in the human body these apophyses are comparatively small, and are respectively removed, as it were, to their proper places, the *styloids* to the cranial bones, and the anterior cornua to the os hyoides, they perform the same office of connecting the hyoid apparatus to the cranium in Man by the interposition of a cartilage, and in quadrupeds still more effectually by an uninterrupted chain of bones connected with each other.

The *posterior cornua*, each consisting of a single piece, resemble each other in office at least, in all the Mammalia, forming with the *body* of the os hyoides a horse-shoe figure, to which the larynx is appended. The body itself, or central portion of the bone, although in the human subject only represented by a slight tuberosity, will be found in the Rodentia, Ruminants, and more especially Solipeds, to become very conspicuous, and in the last case obviously distinct elements of the skeleton. In these Mammalia indeed, the os hyoides is found to consist of no fewer than nine pieces, without enumerating the styloid bones; a condition of complexity almost approaching that met with in the Birds and inferior Vertebrata.

Leaving the consideration of the bones of the

face, and those which enter into the composition of the hyo-branchial apparatus, which may be all regarded as forming a succession of arches depending from the sides of the cranial vertebræ, of the transverse processes, of which they are indeed regarded by some writers to be real costal prolongations; the anatomist finds a more or less extensive series of bones derived from the sides of the spinal vertebræ, and frequently arching downwards to enclose and protect the viscera either of the thorax or of the abdomen, or of both. These lateral appendages to the spinal column are invariably in connection with the transverse processes, of which in their simple forms they might seem to be derivations, but when largely developed, as for example in the thorax of Mammiferous animals, they attain to a prodigious size, forming, almost by themselves, the frame-work of the thorax, and constituting the principal agents employed in the performance of the mechanical actions connected with the inspiration and expiration of the air used for the purpose of respiration. The position of the ribs thus employed for the formation of a thorax is extremely variable in different races. In Man and all other Mammalia, in obedience to a law at present unexplained, they commence invariably at the eighth spinal vertebra, counting from the skull; but in Birds the whole thorax is removed much further backwards in order to allow of the greater elongation of the neck.

Besides the dorsal ribs thus derived from the spine, and which exist alone in the human subject and in Mammalia generally, another series of additional elements is met with in Reptiles and in Birds, which must be called *sternal ribs*, and these, conjoined with the last, enter into the composition of the thoracic cavity. In Fishes only dorsal ribs are met with, and these are connected by a simple articulating facet to the sides of the bodies of the vertebræ placed immediately above the abdominal cavity. Frequently, however, the ribs of Fishes have supplementary bones appended to them, which in the living fish are embedded amongst the lateral muscles of the body. Sometimes, indeed, these additional rib-like processes arise immediately from the bodies of the vertebræ themselves, giving an appearance of complexity to this portion of the skeleton that is calculated to puzzle the young osteologist. In the Cyprinidæ and the Herring tribe a small osseous piece is interposed between the vertebra and the rib that is appended to it; this is obviously a detached transverse process. In the Batrachia dorsal ribs only are found, and these, even when most largely developed, are mere rudiments appended to the ends of the transverse processes of the vertebræ.

In Serpents likewise the enormously prolonged thorax is entirely made up of dorsal elements, but these, existing as they do almost along the whole length of the body, and being moved by an elaborate muscular apparatus, perform to a certain extent the office of locomotive organs.

In the Chelonian and Saurian Reptiles the construction of the thorax becomes much more

complicated by the development of additional elements hereafter to be described, and in these tribes the examination of the dorsal ribs exhibits to the osteologist several points of very great interest relative to this portion of the skeleton. In the Crocodile, for example, the elements derived from the vertebræ present every gradation of form between the simplest and most complex condition of the costal pieces. The hinder ones are loose and floating, being mere appendages to the transverse processes, to the ends of which they are fixed as in the Batrachia, by a simple undivided articulation; but as we advance forwards from this point along the true thorax, their connection with the vertebræ becomes progressively changed through a series of most beautiful gradations of form; the head of the rib becomes slowly divided into two distinct articulating surfaces, both of which are at first attached to the transverse process of the corresponding vertebra, but more anteriorly the bifurcation of the head of the rib being completed, one division becomes attached to the body of the vertebra, while the other, the *tubercle*, is fixed to the transverse process, and every gradation intermediate between the two extremes of structure presented in this portion of the skeleton is thus exhibited in the same animal. But dorsal ribs are developed in the Crocodile anterior to the thorax and with a very different office, costal appendages (*fig. 432, o*) being attached to all the transverse processes of the cervical vertebræ. These, instead of being prolonged downwards, spread out anteriorly and posteriorly, assuming the shape of the letter T, and forming a continuous chain of bones, that trammels the lateral movements of the neck, but at the same time affords ample surface for the attachment of the unusually strong muscles of this Reptile's neck. The dorsal ribs of the *Chelonian* Reptiles are equally interesting on account of the strange modification in the manner of their connection with the spine, whereby they are absolutely brought quite to the exterior of the body, and in the Tortoises so completely united by suture to the spinous processes of the vertebræ, and likewise to each other, as to form the greater portion of the dorsal shield or carapax peculiar to these races. In order to effect this total change in the position of the costal elements of the skeleton, the anatomist finds to his astonishment that very simple arrangements are necessary. The neuro-spinal apophyses of the vertebræ are prodigiously developed and spread out into broad flat osseous plates firmly connected with each other and with the tubercles of the ribs by means of their broad serrated margins; this being accomplished, the usual attachments between the head of the rib and the spine become unnecessary; the bodies of the vertebræ remain quite rudimentary, the transverse processes are obliterated, and the head of the rib itself reduced to a ligamentous condition, the carapax being left sufficiently strong without any necessity for the usual abutments of the ribs on the vertebral column.

In Birds, on the contrary, a precisely opposite arrangement is required in order to com-

bine strength and lightness in the construction of the framework of their thorax, which must bear the strain of the strong muscles used in flight. The bifurcation of the commencement of the rib is here exaggerated to the utmost; its strongly developed head is firmly articulated to the vertebral bodies, and by means of its tubercle it is additionally secured to the transverse processes of the dorsal vertebræ, and moreover, besides the strong buttresses thus made to sustain the thorax, additional long splints of bone project backwards from the dorsal ribs much in the same manner as in Fishes, only here the superadded processes are prolonged until they overlap the rib succeeding next behind, binding the whole together; and materially assisting to strengthen the thoracic framework.

But even in Birds, as in the Crocodile, the dorsal ribs are found developed from the vertebræ anterior to as well as behind the proper thorax.

In Mammals, the great portion of the chest consists of dorsal ribs, which are eked out in front by costal cartilages connecting them on each side to the sternum. Yet still the floating ribs behind the proper thorax are persistent, and in one rare instance, namely, the Sloth, they exist in front as well, appended to what else the anatomist would call cervical vertebræ. We therefore see at once that the division of the spine into the different regions pointed out in the human skeleton is quite arbitrary, as the existence of ribs and the possession of a thorax are by no means necessarily linked together.

A very singular illustration of the co-existence of thoracic and non-thoracic ribs is met with in Reptiles belonging to the remarkable genus *Draco*, in which, although the anterior ribs are completely developed so as to form a true chest, the six hinder pairs are converted to a totally different use, being prolonged laterally to a great extent, and covered with a duplication of the integument so as to form an ample parachute, by the assistance of which these agile little lizards are in some degree supported in the air as they leap from branch to branch.

The thoracic portion of the skeleton is only met with in a complete state in Birds and the higher Reptilia, the Saurians and Chelonians, in which races it constitutes a very elaborate framework composed of numerous elements, of which no traces are perceptible in the human subject or in the generality of Mammalia. In the Crocodile it is seen to be made up of the following parts—1st, of a complete apparatus of *dorsal ribs* (*fig. 432, l*), connected to the transverse processes and bodies of the dorsal vertebræ; 2ndly, of an equal number of *sternal ribs* (*m*), interposed between the ends of the former and the sides of the sternum; and, 3dly, of the *sternum* (*n*), forming the pectoral boundary of the chest.

The sternum itself, although usually considered by the human osteologist as being extremely simple in its composition, is, when fully developed, made up of several distinct elements equalizing in importance any that assist in building up the skeleton. It is, how-

ever, only in the Chelonian Reptiles that the sternal bones present themselves in full completeness, forming the broad shield or *plastron* that defends the ventral aspect of the body in those animals, which, being solidly connected on each side with the dorsal plate or carapax, forms a kind of box to shelter the whole body.

The sternum, thus necessarily amplified to the utmost, consists of no fewer than nine distinct elements, to all of which names have been applied expressive of their position relative to each other. First, there is an azygos element occupying the mesial or central portion of the anterior part of the plastron, which from its situation has been named the *entosternal* element. This central piece is bounded anteriorly by the *episternal* bones, and posteriorly by another pair named the *hyposternal*, being as it were set in the centre of these lateral pieces as in a frame. The posterior half of the sternum consists of two pairs of elements, the larger and most anterior being designated as the *hyposternal*, whilst the posterior occupying the position of the xiphoid cartilage in the human skeleton are fitly denominated the *xiphosternal* pieces, which are united to each other and to the last-mentioned pair by strong serrated sutures, as indeed are all the elements above enumerated.

In the aquatic Chelonians, the *Turtles*, the same elements are met with entering into the formation of the enormous sternum, and their positions with respect to each other are precisely similar; but here, in order to lighten the skeleton, large excavations are hollowed out in the centre of the bone, so that the three posterior pairs of sternal elements do not meet in the mesian line; but in all other respects their identity is at once evident. The sternal apparatus, however, although most frequently it enters largely into the formation of the thorax, is still more nearly related to the anterior extremity, with the movements of which it is invariably intimately connected, and frequently gives origin to the most important muscles of locomotion. The sternum can scarcely be said to exist in Fishes, with the exception of a very few (*Clupea*), and in these it is represented by a few azygos bones, on which the ribs abut inferiorly.

In the Anouros Batrachia, as the Frog and Toad, the sternum is remarkable as existing in a very complete state of development quite independently of any other elements of the thorax, seeing that in these animals there are no ribs to be attached to it. It consists here of a chain of bones, in which most of the elements above enumerated are easily recognizable, placed along the mesian line of the breast, and supporting on either side the coracoid and clavicular bones that enter into the composition of the shoulder; the whole apparatus has been already figured in the article AMPHIBIA, (fig. 17.) where the episternal bones forming the most anterior part of the series, the *hyposternal* bones (*c*), the *entosternal* bone (*g*), to the sides of which are attached both the clavicle (*c*) and the coracoid (*d*), the *hyposternal* bones (*f*), and the *xiphosternal* elements

completing the chain posteriorly, are all indicated.

The sternum of Birds is peculiar on account of the prodigious development of the azygos or *entosternal* element of which it is principally composed, a circumstance obviously intended to strengthen this part of the skeleton, and prevent the tearing asunder of the lateral portions of the bone by the enormous strain of the strong and massive muscles of flight, an accident of which there would have been great danger had the mesial sutures that exist in the sternum of the Tortoise been here permitted. The pieces composing it are pointed out in fig. 129, vol. i. p. 282, where the following elements are delineated, viz. the *entosternal* (*a*), the *hyposternals* (*b*), the *hyposternals* (*c*), and the *xiphosternals* (*g*).

The sternum of Mammalia becomes once more reduced to its simplest form, consisting of a chain of osseous pieces situated along the mesian line on the anterior aspect of the thorax, which they partially assist in forming. In some races, however, as, for example, in the Monotremata, so closely allied to Birds in all the details of their economy, and also in Quadrupeds possessing great power of using the anterior extremities either for flight or digging, as, for example, the Bat and the Mole, the importance of this part of the osseous framework becomes considerably increased, and it is developed accordingly.

Frequently connected with the sternum, but by no means to be regarded as derivations from that bone, are the other important elements of this part of the skeleton already noticed, which, though entirely deficient in the human subject and in the Mammalia generally, are found in Birds and many Reptiles to be essential to the structure of the thorax. These are the *sternal or abdominal ribs* (fig. 432, *m*) a series of distinct bones interposed between the spinal ribs and the sides of the sternum, so as to form a complete osseous framework to the chest. In Fishes, as well as in the Batrachian and Ophidian Reptiles, these bones are absolutely wanting, though in the *Frogs* and *Toads* the sternum is so large. But in the Saurians, as, for instance, in the Crocodile, they form essential parts of the thoracic cavity, and aid materially the movements requisite for respiration. In the Crocodile these ventral ribs extend indeed much further backwards than the dorsal ones that form the posterior boundaries of the thorax, being continued along the abdomen almost as far back as the pelvis imbedded in the abdominal muscles, the action of which they doubtless materially strengthen.

In the higher Vertebrata, i.e. the Mammalia, the sternal ribs are entirely represented by the costal cartilages, and the abdominal would seem to be completely wanting; still there seems but little doubt that, even in Man, the lingering rudiments of ventral ribs are traceable in the tendinous intersections of the recti muscles of the abdomen.

In Birds the sternal ribs assume still more importance as regards their effect in strengthening the thorax, and converting the thoracic

portion of the skeleton into an osseous framework able to sustain the stress of those powerful muscles that wield the instruments of flight. At one end each of these pieces is moveably articulated with the distal extremity of the corresponding dorsal rib, whilst at the opposite it is firmly attached to the sides of the expanded sternum by joints that admit of a certain extent of motion.

It is in the Chelonian Reptiles that these accessory portions of the thorax attain their greatest growth, spreading into broad plates that are connected by strong sutures to the extremities of all the spinal ribs and likewise to each other in the Tortoises, completing thus the carapax or dorsal shield; and, moreover, being solidly united at the sides with the enormous apparatus of sternal bones, the whole body of the Tortoise becomes encased in bony armour, derived entirely from the thoracic elements of the skeleton.

The ANTERIOR LIMBS of Vertebrate animals, although essentially composed of similar elements throughout all the classes belonging to this great division of animated nature, are made subservient to very various and opposite uses; the pectoral fin of the Flying Fish, the enormous hand of the Skate, the paddle of the Turtle, the flipper of the Whale, the wings of the Bird and of the Bat, the broad shovels of the Mole, and that masterpiece of organization, the human hand, being respectively but simple modifications of the same structure.

In the osseous Fishes, indeed, it is not always easy to recognise the elements that are correlative with those of the higher Vertebrata; but a little attention is sufficient to prove the construction of the pectoral fins among the finny tribes to be true representatives of the anterior extremities of other races, as will be evident from the following masterly analysis of the parts composing the pectoral fin of the Perch, given in Cuvier's great work on Fishes. Immediately behind the gill-openings there is placed on each side a framework of bones that bound the branchial apertures. This frame is attached superiorly to the back of the head, but inferiorly the two halves are united together, forming a bony zone that surrounds the body at this part; and being connected inferiorly with the body of the os hyoides, forms here a kind of isthmus that separates the gill-openings from each other. The bony zone above described is made up on each side of three pieces, which represent the bones of the shoulder and of the arm, to which is affixed posteriorly a group of two or three other bones that represent the forearm, wherewith is connected the fin itself, the representative of the hand. The names applicable to these pieces of the skeleton when their analogies are strictly investigated are as follow:—The *suprascapular*,* the *scapular*,† the *humerus*,‡ the *radius* and *ulna*,

to which succeed the *carpal bones* and the *phalanges* of the fin. In addition to these must be noticed the two pieces regarded by Cuvier as representing the coracoid bone of Reptiles.

When fully developed, the anterior extremity is made up of a greater number of elements than exist in the human skeleton. The shoulder is a strong framework, composed of three distinct pieces, named respectively the *scapula*, the *clavicle*, and the *coracoid bone*. The other bones of the limb resemble each other in their general arrangement throughout all the Vertebrata, and in the Crocodile, where all parts of the limb present a medium state of development, the analogies between the bones composing it and those of the human arm are at once recognised. The *humerus*, a single bone, supports the first division of the limb. Two bones, the *radius* and the *ulna*, are met with in the forearm, while the bones of the *carpus*, the *metacarpus*, and the phalanges of the fingers present an arrangement similar to what is found in the human body. In order, however, to appreciate the important modifications required in the disposition and conformation of these elements in the different races possessing them, it will be needful to examine them successively in the order in which they have been enumerated.

The *scapula* is the most important piece entering into the composition of the shoulder, and not unfrequently, among the Mammiferous races, is the only bone developed for the support of the anterior limb. In Reptiles and in Birds, where so great freedom of motion as is required in terrestrial Quadrupeds would be inadmissible, the movements of this part of the skeleton are considerably restricted, and a kind of anterior pelvis formed which gives great strength and firmness to this part of the skeleton. The *scapulæ* are generally laid like splints along the exterior of the chest, in which position they are, as it were, suspended by strong muscles; but frequently this arrangement is necessarily departed from for obvious reasons. In the Batrachia, for example, such as the *Frog* and the *Toad*, the ribs are altogether wanting, and the strength of the shoulder must consequently be provided for in a peculiar manner. The *scapulæ* are enormously developed so as to perform, to a certain extent, the office of ribs; and, moreover, each being divided, as in Fishes, into two portions, united by cartilage to each other, the strength and resiliency of a chest is in some measure obtained. It is, however, in the Chelonian Reptiles that the most extraordinary deviation from the usual arrangement is witnessed, where the *scapulæ* are absolutely placed in the interior of the thorax, where they are connected by one extremity to the sides of the bodies of the dorsal vertebræ.

No spine or acromial process exists in the *scapulæ* of the oviparous Vertebrata, and even in the quadrupedal Mammals these parts of the bone are very imperfectly developed when compared with their condition in Man, in whom alone they assume their full importance.

The *clavicle* forms the second element em-

* Synonyms—*Omoplate*, *Omolite*, *Pedicule de l'épauule*.

† Syn.—*Omoplate* (Geoffroy), *Acromion* (Bakker).

‡ Syn.—*Clavicle* (Meckel, Geoff.), *Cænosteon* (Bakker).

ployed in constructing the shoulder-joint, but is by no means constantly present. In Fishes its existence as a distinct bone is not recognisable; but in all the Reptilia it constitutes a highly important piece of the skeleton.

In Birds the *clavicles*, in consequence of the elasticity and strength indispensable in the composition of the bony framework of the shoulder in animals constructed for flight, present a very peculiar arrangement, being generally solidly ankylosed to each other in the mesial line, where they meet, forming a single bone, to which the name of *furculum* is generally given. In Birds, however, that are not organized for flight, such as the Ostrich, this peculiarity is dispensed with, and two distinct clavicles are found articulated with the sternum, as in the generality of Vertebrata.

In the Mammalia again the clavicles are much reduced in importance and frequently are entirely wanting, as in all the pachydermatous races. It is only when extensive movements are required in the anterior limbs, either for the purposes of flight, climbing, digging, or prehension, that clavicles are interposed between the shoulder of a quadruped and the anterior portion of the sternum, so as to form a kind of pivot on which the whole shoulder moves, and in the human subject the freedom of motion obtained for the arms and hands by this arrangement contrasts strongly with the fixed condition of the shoulder, both of Birds and Reptiles.

The *coracoid bone*, forming the third element employed in constructing the shoulder-joint of Vertebrate animals, is only fully developed in the Reptilia and in Birds. In Fishes it is but doubtfully represented by two bony pieces already referred to; but in all the Batrachian and Saurian Reptiles it constitutes the strongest support of the shoulder, abutting on the sternum on the one hand, and on the other firmly connected with the shoulder-joint. In the Chelonian Reptiles, too, the coracoids are very large, and remarkable on account of the extraordinary inversion of the skeleton of these animals, the scapulæ being here actually placed inside the thorax within the ribs, and fixed by ligaments to the sides of the bodies of the vertebræ; while the coracoid bones, equally placed within the thoracic box, are similarly circumstanced as regards the *plastron* or enlarged sternum that covers them inferiorly.

In Birds the *coracoid* bones are of peculiar strength and solidity, serving as buttresses to support the shoulder against the vigorous traction of the enormous pectoral muscles. It stretches from the anterior margin of the sternum, with which it is firmly articulated, to the junction of the *scapula* and *clavicle*, where it assists in forming the glenoid cavity.

Throughout all the Mammalia, with the exception of the Monotremata, the coracoid bones are wanting or only represented by a small apophysis, consolidated with the neck of the scapula, as is the case in the human skeleton, to which the term *coracoid process* has been generally applied.

The *humerus*, the first bone of the anterior extremity, is invariably a single bone interposed

between the glenoid cavity and the forearm. It is invariably present throughout all the Reptilia, excepting of course the apodal Ophidian races, and is at once recognisable by the anatomist. In Birds, likewise, the *humerus* offers nothing remarkable except the mechanical arrangement of its articular extremities.

Neither in the Mammalia is there any aberration from the common type of structure, the only variations being in the length, form, or proportions of this piece of the skeleton, adapting it to the necessities of the different races of Mammifera.

The forearm, or second division of the upper extremity, is normally made up of two bones, called respectively the *ulna* and the *radius*. These are incomparably most complete in the human subject, where their admirable connections with the humerus, with each other, and with the hand, are amongst the most striking instances of perfect mechanism met with in the animal creation.

In Fishes and in the Batrachian Reptiles they are most imperfectly developed, and are invariably ankylosed together. In the Chelonian and Saurian Reptiles they become quite distinct from each other, but the movements of pronation and supination are extremely limited. The *ulna* of Birds is the principal bone of the forearm, while the *radius* is a separate bone easily distinguishable by the relations it bears to the other parts of the wing; here likewise, in consequence of the uses of the anterior extremity as instruments of flight, these bones are almost immovably fixed in a state of pronation.

In the unguiculate Quadrupeds generally, the *ulna* and *radius* are separate bones, with a few exceptions, such as the *Cheiroptera*, where one bone only constitutes the forearm, but amongst the Ungulata they are frequently more or less consolidated and fused together towards their distal extremities, as, for example, in the Ruminants and in the Solidungula.

The *carpus*, forming the third division of the upper extremity, generally consists of several short and thick bones firmly bound together by ligaments, but allowing of sufficient motion between each other to afford a slightly moveable basis to support the parts composing the hand, either to prevent concussion in walking or to permit increased mobility to the fingers. When most completely developed, as they are found in the human subject, they are eight in number, to which names indicative of their shape have been applied, such as *scaphoides*, *lunare*, *cuneiforme*, *pisiforme*, *trapezium*, *trapezoides magnum*, and *unciforme*; but these names cannot be supposed to be applicable to the carpal bones of other Vertebrata, in which they present so many varieties both in their shape and position as frequently to be quite unrecognisable as the analogues of each other, their number too varying most considerably, either on account of the coalescence of elements originally distinct, or from their total suppression.

The bones of the carpus in Fishes are generally represented by four or five small pieces interposed between the bones of the forearm and the pectoral fin. With these bones the

fin rays, however numerous, are connected; with the exception of the first, which articulates immediately with the radius. In some Fishes, as in the *Lophius*, these bones are extraordinarily lengthened, while the radius and ulna are diminished in proportionate size; so that some writers have mistaken the bones of the carpus for those of the forearm.

In the *Batrachia*, and in all four-footed Reptiles, they are small ossicles interposed between the bones of the forearm and metacarpal bones, resembling very much those of the human subject; but in Birds, in consequence of the peculiar condition of the hand, here converted into a wing, they are reduced to two, so disposed as to form with the bones of the forearm a mere hinge-joint moving laterally, so as to allow the wing to be folded up.

In the *Cetacea* the carpal bones exist, it is true, but so separated from each other by an interposed cartilaginous mass that they assist in forming a broad paddle, strengthened by superficial ligaments, and only useful for progression in the water.

In all other *Mammalia* the carpal bones are met with, their form and number varying with the uses for which the limb of which they form a part is adapted.

The *metacarpal bones* form the immediate basis on which the individual fingers are supported, and, accordingly, are as variable in their number and arrangement as are the digital portions of the anterior extremity.

In Fishes, owing to the numerous fingers or rays as they are here called, the metacarpal bones are met with in far greater numbers than in animals where the extremities assume a more concentrated form,—a fact most remarkably exemplified in the *Chondropterygious Fishes*, where the number of digital phalanges is enormous. But in Reptiles, where the hands are not only reduced to what may be called the normal type of structure, but developed in a medium condition, little remarkable is met with in this part of the hand. It is only as we come to animals appointed to extraordinary conditions of life that aberrations from the usual form become conspicuous, as, for example, in the feathered races. The metacarpus of Birds, although in some cases it might at first appear composed of a single bone, in others of two bones ankylosed together at both ends, contains, in reality, the elements of three metacarpal bones consolidated; two of these, which are much elongated, supporting the fingers, while the third, an exceedingly small element confused with the base of the central one, sustains the rudimentary thumb.

In the metacarpal bones of the unguiculate *Quadrupeds* there is nothing worthy of notice in this general survey of the osseous system; but in the *Ungulata* a coalescence almost as remarkable as in Birds is observable, whereby the peculiar structure of the feet of such animals is provided for. In the *Ruminantia* and *Solidungula* the whole metacarpal apparatus would at first sight appear to consist of a single bone, to which the name of canon-bone is gene-

rally appropriated; but this apparently single bone is easily seen to be in reality made up of two, ankylosed together throughout their whole length, so that the line of demarcation between them is only indicated by a deep longitudinal groove, visible on the anterior and posterior aspects of the bone; in most cases, however, there are two more lateral pieces, unattached to the principal or canon-bone except by the soft parts, but evidently real metacarpal elements in an imperfect and rudimentary condition.

The digital phalanges being the most remote from the central portion of the skeleton are likewise the most variable in number and appearance, being moulded into shapes as various as are the uses to which the anterior limbs are convertible, becoming in turn the framework of oars, of paddles, of pillars, of rakes, of wings, or of hands, in accordance with the different natures of the animals possessing them. Neither is it at all an easy task to say how many of these elements might exist in the construction of this part of the skeleton, seeing that the number of fingers that may enter into the composition of a hand seems not at all determinate, nor even the number of phalanges in a given finger. The pectoral fins of osseous Fishes, the representatives of the hands of higher *Vertebrata*, differ exceedingly in this respect, sometimes consisting of a single ray, at others being dilated and extended, as in the *Flying Fishes*, until both rays and phalanges become extremely numerous. The hand or pectoral fin of the *Skates* is perhaps one of the most remarkable structures that can be offered to the contemplation of the osteologist, whether we regard its apparently disproportionate size or the immense number of digital elements that enter into its composition; it forms, in fact, the great bulk of their bodies, and is made up of upwards of a hundred distinct fingers, each composed of numerous phalanges of enormous length. Throughout the *Serpent* tribes all traces of anterior extremities are lost, but in the *Anourous Batrachia* fingers again appear under a new and more elevated form, although feeble when compared to the digital phalanges of the hinder extremities in the same Reptiles.

Throughout the *Saurian* and *Chelonian* races as they now exist, nothing remarkable appears in the construction of this portion of the skeleton, the chief modifications observable being in the number, length, and position of the fingers, although in extinct forms of nearly allied genera, such as the *Ichthyosaurus* and *Plesiosaurus*, the number both of toes and phalanges are so prodigiously increased that we are once more reminded of the fins of Fishes.

The digital phalanges in the wing of a bird are reduced to an exceedingly rudimentary condition, the thumb being represented by a single bone. The central or radial finger is the longest and most complete, consisting, when fully developed, of three distinct joints, though sometimes there are only two. The ulnar or third finger is, like the thumb, represented by a single phalanx appended to the distal extremity of the ulnar metacarpal bone.

In all the mammiferous Quadrupeds possessed of unguiculate feet, the digital phalanges of the anterior extremity present nothing worthy of special notice in this place, minor differences being noticed under the proper heads; but in the unguulate Pachydermata, such as the Ruminants and Solipeds, remarkable exceptions to the usual arrangement are met with. In the Ruminants only the two central fingers are well developed, each consisting of three large phalanges, the distal one of which is enclosed in a strong hoof, so as to give the cloven appearance to the whole foot which is so characteristic of the order; but besides these, two rudimentary toes exist, one on the outer, the other on the inner side of the foot, but so small as not to reach the ground or to be serviceable in the ordinary progression of these creatures.

In the Solipeds even the division between the central large toes that exists in the Ruminant becomes obliterated, and the whole foot appears to be made up of a single toe consisting of three strong phalanges, the distal one being encased in a large semicircular hoof. Even in these animals, however, rudiments of two other toes are distinguishable, but very imperfectly developed.

Ilium.—This is the principal bone entering into the composition of the pelvic arch, and frequently is the only one met with in this part of the skeleton. In the osseous Fishes it is not yet connected with the spine, so that the posterior part of the body is left perfectly free and untrammelled, in order to allow of the extensive movements of the tail required for the propulsion of these aquatic animals through the water. There is consequently here no sacrum, and we are not surprised to see the posterior limbs extremely variable in their arrangement, being placed far back or advanced towards the anterior part of the body as circumstances require. Even in the cartilaginous Fishes the pelvis has no connection with the spine, the whole consisting of a broad transverse osseous band placed beneath the terminal portion of the abdomen.

In the Batrachia, too, the iliac bones retain to some extent the form of ribs, and in the Frog are two bones of considerable length attached to the prolonged transverse processes of the last vertebra, which of course, in this case, represents the sacrum.

In the Toad another step is made towards strengthening the posterior part of the spine, preparing it to support locomotive organs of greater energy by fixing the iliac bones to two of the vertebral transverse processes, forming a sacrum composed of two bones, which is in fact the usual condition of this part of the skeleton in the higher Reptiles.

In the Chelonians, however, the iliac bones are again attached to a single vertebra and pelvis, like the bones of the shoulder placed internal to the ribs which form the carapax or dorsal shield.

The *ilium*, in all the class of Birds, is enormously developed in proportion to the unfavourable circumstances under which they sup-

port themselves upon their posterior extremities. It extends along the sides of the vertebral column, to which it is solidly ankylosed, converting into one immense sacrum from eight to nineteen of the posterior vertebræ, which are so completely fused to each other and to the iliac bones that their number is only distinguishable from the positions of the intervertebral foramina through which the nerves escape from the spinal canal in this region.

In Mammals the iliac bones are likewise greatly developed, except in the Cetacea, where, in consequence of the necessity for fish-like flexibility in the hinder part of the body, no hinder extremities exist. The sacrum is composed of a considerable number of vertebræ here ankylosed together and considerably modified in their form, to which the broad *ossa ilii* are firmly secured by ligaments and an interposed cartilage, giving a firmness to this part of the skeleton second only to what is observable in the feathered races.

The *ossa ischii*, the second elements entering into the composition of the pelvic framework, are not so invariably present as the iliac bones. In Fishes they are not to be found: but in all the Reptilia, where the elements of the skeleton remain permanently disunited to a much greater extent than in warm-blooded animals, they are constantly present, except, of course, where the hinder extremities are deficient, and are separated by a very distinct line of demarcation from the other bones of the pelvis.

As in the shoulder, the articular cavity for the attachment of the anterior limbs when all the elements of that part are fully developed, is formed by the union of three bones, so likewise in the pelvis, which is only a repetition of the same apparatus modified in form, do all the three bones of which it consists enter into the formation of the cotyloid cavity, a circumstance which, in Reptiles, is particularly conspicuous.

In the class Aves, notwithstanding the aberrant condition of the pelvis, the *ischia* are easily distinguishable from their position, bounding as they do the obturator foramen on the one side, and the sacro-ischiatic notch on the other.

In the Cetacean Mammals this element of the skeleton is again obliterated, but in all the other orders it is present, and in the earlier stages of life is readily demonstrable as a distinct bone of the pelvis.

The *ossa pubis* are the third pair of elements entering into the composition of the pelvic cavity, and to these the same remarks are applicable as we have already made concerning the *ischia*. In Fishes they are not present, but throughout the Reptile orders that possess a pelvis they are very distinct and important parts of the skeleton, meeting each other anteriorly in the mesial line, where they are united by a strong symphysis.

The pubic bones in Birds occupy a corresponding position; they are here, however, remarkable from the circumstance that their distal extremities never (except in the Ostrich) meet to form a pubic symphysis, but are always widely separated from each other, an

arrangement which is here convenient to permit of the extrusion of the egg through the pelvic cavity, and may be permitted in this race of animals in consequence of the prodigious consolidation of the dorsal parts of the pelvis.

In the Cetacea only the pubic elements of the pelvis are developed, both ilia and ischia being deficient, so that they are quite detached from the rest of the skeleton. In all other Mammalia they correspond both in position and general arrangement with what is found in the human subject.

The *marsupial bones* are peculiar to the marsupial division of Mammals. They are two triangular pieces articulated to the anterior surface of the pubic bones, and imbedded in the parietes of the abdomen behind the marsupial pouch, which they assist in supporting. It has been asserted that rudiments of these bones may be traced even in the human subject in the shape of minute cornicles sometimes attached to the pubis.

The *femur* represents, in the posterior extremity, the humerus of the anterior, articulating immediately with the pelvic arch, but modified in form according to the difference of its function. In Fishes this element of the skeleton does not exist at all, the digital rays and tarsal bones of the ventral fin, the representative of the posterior extremities of other Vertebrata, being affixed immediately to the pelvic bone, which sustains it. In the Perennibranchiate Amphibia it is but very feebly developed when the hinder extremities are present, which is not always the case. In the Anouros Amphibia, however, as, for example, in the *Frog*, it suddenly assumes a very great importance in accordance with the saltatory habits of those Batrachia. It exists also in all other quadrupedal forms of the Reptilia, only modified in shape according to their different modes of life.

In Birds the femur is short and strong, but presents no peculiarity requiring special notice.

In the Mammalia, likewise, except in the Cetacea, it is invariably present, its size and shape altering in the different tribes as their habits vary.

The *tibia*, the principal bone of the leg in all quadrupedal Vertebrata, does not exist in Fishes, where all the elements of the skeleton, usually interposed between the foot and the pelvis, are found to be deficient.

In the Batrachian, Saurian, and Chelonian Reptiles it is invariably a bone of very considerable importance, whether it be united with the other bone of the leg, the fibula, or remain separate and distinct.

In the feathered races this bone is of great strength, having to support the weight of the body in a very unfavourable position, and in all the Mammalia that are possessed of posterior extremities it is necessarily present.

The *fibula*, which in the hinder extremity represents the ulna of the anterior limb, like that bone, is not unfrequently very imperfectly developed, especially where great strength is required in this part of the limb, and mobility becomes a secondary object. In Fishes it is

not yet developed. In the Batrachian Reptiles it exists, but is generally so completely ankylosed to the tibia throughout its whole extent as only to be distinguished from that bone by very accurate examination. In the Saurian Reptiles it is a distinct and very important bone, as is likewise the case in the Chelonians, although here the two bones of the leg are so firmly connected by ligaments that but little motion is permitted.

The fibula of Birds is a mere rudiment, a slender splint appended to the external aspect of the tibia, distinct above, but inferiorly completely lost, being gradually solidly united to the latter bone, with which it becomes completely confused.

In the Monotremata, notwithstanding the near relations that exist between these singular quadrupeds and the feathered races, the fibulae are very largely developed, as likewise in most of the unguiculate Quadrupeds; but in the unguiculate Mammalia the fibula is reduced to a mere rudiment attached to the outer side of the tibia.

The *tarsal bones* are, in the posterior extremity, the representatives of the carpus of the anterior, but from various circumstances are very considerably altered in form, and not unfrequently differ in number from the latter, even in the same animal, in consequence of the very different offices not unfrequently assigned to the two pairs of limbs. In Fishes they are very imperfectly developed, or confused with the other elements entering into the composition of the ventral fin. In Frogs and Toads, however, they are very distinctly formed, being in these amphibious reptiles six in number; but of these the two proximal ones, corresponding to the *astragalus* and *os calcis*, are remarkably elongated, and by the uninformed might easily be mistaken for the tibia and fibula. In Saurian and Chelonian Reptiles they present what may be called their normal or medium state of development, the *os calcis* being here left prominent for the insertion of the extensor muscles of the foot.

No tarsal bones are distinguishable in the adult bird, the few elements which in the young animal are developed by distinct points of ossification being rapidly confused with the metatarsal portion of the limb, so that both these divisions of the hinder extremity are here represented by a single piece, to which the appropriate name of tarso-metatarsal bone has consequently been applied.

In all unguiculate Mammalia the tarsal bones are well developed and more or less resemble the human; but in the Ungulata, owing to the extreme length of the *metatarsus* or canon bone, they seem to occupy a position corresponding with that of the knee in other animals; and the remarkably prominent *os calcis*, to which the *tendo Achillis* is fixed, is well calculated to remind the anatomist of the olecranon of the ulna.

The metatarsal bones are but a repetition of the metacarpal bones of the atantal extremity, and immediately support the digital phalanges of the foot, varying in number as the

toes are more or less numerous. In their most normal state of development these bones are five in number as in the human skeleton, but from this variations occur in almost every order of Vertebrata.

The metatarsus of Reptiles is, however, well developed, consisting of a series of moderately elongated bones extended between the carpus and the proximal phalanx of the corresponding toe, but offering nothing worthy of special comment.

The tarso-metatarsal bone of Birds, representing both the tarsal and metatarsal portions of the skeleton, seems to consist of three and sometimes four metatarsal bones consolidated into one piece. These are distinguishable inferiorly by the four trochlear surfaces that support the moveable toes; while the presence of an ossified spur in some gallinaceous birds, regarded by many anatomists as the rudiment of a fifth toe, might indicate the existence of a fifth metatarsal element lost in the general consolidation of these pieces.

In all the unguiculate Mammals the metatarsal bones hold the same relations with the other bones of the foot as in the skeleton of Man, and need no special notice; but in the Ungulate families their appearance and arrangement are necessarily much changed. In the Solipeds and Ruminants the metatarsal division of the extremity is so much elongated as to constitute a very considerable portion of the limb. It is principally made up of a single piece generally called the "canon bone," which in reality consists of two enormous metatarsal bones consolidated into one, being fused together in the central line along their whole length, although the real composition of the canon bone is always distinguishable both on account of a deep furrow which indicates the union of the two pieces, and from the condition of the two widely separated trochlear surfaces at its distal extremity. Besides the two largely developed pieces forming the canon bone, two other metatarsal pieces assist in forming the foot of a Ruminating Quadruped; these sustain the supplementary toes developed in a rudimental condition on the outer and inner aspects of the member.

The *digital phalanges* of the posterior extremity are among the most variable elements of the skeleton, being, like those of the anterior, made subservient to a great variety of uses both in terrestrial and aquatic forms of Vertebrata.

In the osseous Fishes they are represented by the fine rays of the ventral fin, and are of course employed in natation; but in the cartilaginous Fishes, as the Sharks and Rays, although the resemblance between this part of the skeleton and the feet of higher animals is more striking than in the osseous races, they are appropriated to a different office, serving the purpose of claspers, whereby the intercourse between the sexes is facilitated.

Throughout all the Reptilia that possess hind feet, the phalanges of the toes offer nothing remarkable; neither in Birds is there anything peculiar in their structure, the only circumstances of interest connected with this

part of the skeleton in the feathered races relating to the number and disposition of the toes, and the presence of more or less numerous joints entering into their composition.

In the Mammalia this part of the foot corresponds in its composition with that of the hand, and therefore need not be further noticed.

In enumerating the elements of the endo-skeleton it would be improper to omit certain supplementary pieces, which, though not strictly belonging to the osseous system, are of important mechanical assistance to the muscles inserted into different portions of the skeleton. These are developed in the substance of various tendons where much friction is encountered, or where it is of importance to remove the line of traction to some distance from the centre of motion in order to gain additional leverage. When developed in the tendons of the fingers or toes, these detached pieces of osseous substance are called "sesamoid bones," but in such situations their existence is by no means constant. Connected with the great joints corresponding with the knee and elbow of the human subject, bones of this kind are very generally developed, and their size and importance renders them worthy of special remark. In the anterior extremity the superadded bones are named "olecranon," and very generally are found solidly cemented to the proximal end of the ulna, forming a prominent process, that gives great mechanical advantage to the extensor muscles of the forearm. The corresponding bone appended to the knee-joint has, from its condition in the human subject, received the name of "patella."

Such being the elements employed by nature in constructing the locomotive extremities of Vertebrate animals, our only wonder is that by simply modifying the figures of the bones, by suppressing some and exaggerating others, or else by fusing several of them together, such infinite diversity of apparatus is provided in the various classes of Vertebrata. Seldom, indeed, does a limb present all the pieces we have enumerated in a complete state of development, and frequently the majority of them, or even the whole series, is entirely dispensed with. In many Fishes, as in the Lamprey and Myxine, all four extremities are absolutely wanting, a circumstance which again becomes remarkable in the case of Ophidian Reptiles. Occasionally the hinder only are called into existence, and that in a very rudimentary state, as for example, in some Serpents, Anguis, Boa, &c. More frequently the anterior limbs are found without the posterior; such is the case in the apodal Fishes, in the Siren and Bimanes among Reptiles, and still more conspicuously in the Cetacea.

EXOSKELETON.—Having thus examined all the elements that belong properly to the osseous system or *endo-skeleton*, we must now turn our attention to another important system of organs equally concerned in building up the framework of the body, and that to an extent which the human osteologist would scarcely imagine possible. We allude to the external or cuticular skeleton, which, although reduced

in Man to a most rudimentary condition, being represented merely by the common cuticular covering of the body and its appendages, the hair and the nails, we shall find among the lower Vertebrata performing a much more important part in the animal economy, and occasionally entering largely into the construction of the organs of locomotion, replacing and not unfrequently actually assuming the appearance and office of the *endo-skeleton* or proper osseous system. Examined in their remotest aspects, few textures indeed appear less allied, the osseous tissue and that of hairs, horns, feathers, and other cutaneous appendages; nevertheless we doubt not that, on taking an enlarged view of the subject, it will not be difficult to prove that the two are absolutely interconvertible, both in use and even composition, the cuticular skeleton being not unfrequently had recourse to by nature to eke out and complete organs for the construction of which the elements of the *endo-skeleton* would have been insufficient.

Let any one who is only conversant with the composition of the skeleton of Man, or of the higher Vertebrata, examine that of a fish, more especially of one of the osseous Fishes, and he will soon perceive how impossible it is to point out anything analogous to a very considerable number of the parts composing it, in the bony framework even of those Reptiles that are most nearly approximated to Fishes in their general economy, or from the elements above enumerated, various as they are, to build up those additional structures that render the osseous support of a fish's body so complicated and so aberrant in its composition from what is seen in any other class of Vertebrate animals. In the first place there are numerous bones forming a chain of osseous plates surrounding the inferior margin of the orbital cavity, which have been named by Cuvier "*suborbital bones*," and by Geoffroy "*jugal bones*," although, having already seen that the jugal are represented elsewhere by an important element easily identified, it is surely anomalous, to say the least of it, to find the same element thus multiplied and divided, more especially when in many of the hard-cheeked fishes, such as the Gurnard, these supplementary pieces become the largest bones of the face.

The *opercular bones*, which form the gill flaps of the fish, are a set of bones which from their very office are evidently peculiar to the skeleton of a fish, and could scarcely have been suspected to have any analogue in animals totally destitute of gill openings, as are all other Vertebrata in their adult condition. These bones are four in number, and have received from writers on ichthyology the following names: 1st, the *preoperculum*,* (fig. 436, 30) which forms the basis supporting the other three; 2nd, the *operculum* † proper, (fig. 436, 28) articulated to the former, on which it moves like a door on its hinge. Beneath the last-mentioned bone is a third, named the *sub-*

operculum,* (fig. 436, 32) and still lower down placed immediately behind the articulation of the lower jaw, a fourth, to which the name of *interoperculum* † (fig. 436, 33) has been applied.

In the Chondropterygii this apparatus is entirely wanting. To explain the analogies of these pieces the most desperate theories have been broached by transcendental osteologists, the boldest and most celebrated of which is that of Geoffroy St. Hilaire, that these opercular bones are the *ossicula auditus* reproduced in an altered form after they were no longer required to form part of the auditory organ; an opinion which has found supporters even in this country notwithstanding the withering criticism of Cuvier, who, remarking upon this theory, very justly observes, that he has seen but little of such sudden reappearances of parts after they had been progressively made to disappear in the scale of animal life. Cuvier was compelled to regard the opercular bones as being superadded elements of the skeleton peculiar to Fishes, and having no representatives in other Vertebrata. De Blainville suggested that the pieces in question might be derived from a dismemberment of the lower jaw, by the detachment of the opercular elements from the ramus; but this hypothesis is refuted by the fact that in some Fishes, as the *Lepidosterus*, all the elements of the inferior maxilla are co-existent with the opercular apparatus. Professor Owen first suggested that they were mere derivations from the dermal skeleton, an opinion that seems every day to receive confirmation.

The *supra-temporal* bones of Fishes, a chain nearly resembling the *sub-orbital*, which in many species arches over the temporal fossa, belong to the same category, and cannot be said to resemble any bones found in other creatures.

But the most anomalous of all the bones found in a fish's skeleton are those large and important ones that support the azygos fins placed along the mesian line of the body, constituting the dorsal, caudal, and anal fins. These bones consist of several distinct pieces, and frequently assume a very complex structure: first, there is the fin ray itself, either simple, as in the dorsal fins of the Acanthopterygii, or many-jointed, as in the fin rays of Malacopterygious fishes. These moreover are individually articulated with other pieces of a more decidedly osseous character, called the interspinous bones, which are imbedded in the flesh of the back, and might be, as indeed they have been, mistaken for appendages to the neuro-spines of the vertebræ.

The hypothesis promulgated by Professor Grant upon this subject is as follows: "The spinous processes in Fishes give rise to other pieces. The spinous processes extending from the vertebræ of the fish when they have become largely developed themselves, give origin to new bones and afford us an illustration of a

* *Tympanal bone* (Geoffroy). *Malleus* (Spix).

† *Stapeal* (Geoffroy). *Incus* (Spix).

* *Malleal* (Geoffroy).

† *Inceal* (Geoffroy). *Stapes* (Spix).

fact which is remarkable for its uniformity in other parts of the skeleton and in other animals. A separate centre of ossification is developed, a new source of nutrition is conveyed directly to the extremity of the part—a new bone is formed from the end of the spinous process." But even this dilatable explanation is by no means sufficient for the required purpose, for having developed in this way the interspinous bones from the spinal elements of the vertebræ, the fin rays themselves are referred to the same source, and thus materials are afforded for complicating the endoskeleton *ad libitum*, upon the simple supposition that when any element becomes inordinately developed, it can develop other elements to eke it out.

Geoffroy adopted another mode of explaining the origin of the supernumerary bones that support the dorsal and anal fins of fishes. Supposing the upper and lower vertebral spines (i. e. the neuro-spines and hæmo spines) to be each composed of two elements conjoined in the mesial line, he asserts that, instead of remaining side by side, one half of the spine is removed and placed above the other to form the interspinous bone. Yet even this would by no means get over half the difficulty, for the fin rays themselves remain to be accounted for, and where are elements to be procured for the construction of these? Moreover, as Cuvier remarks, it by no means unfrequently happens that several interspinous bones belong to a single vertebral spine, a circumstance which is quite incompatible with the supposition that any dismemberment of the spine can account for their presence.

Failing, therefore, to find any materials for the construction of the bones we have enumerated among any known elements of the endoskeleton, we are compelled to look elsewhere, and shall soon find, by tracing the exoskeleton of Fishes through the different aspects under which it offers itself, abundant means of supplying all deficiencies.

The scales that usually invest the bodies of ordinary Fishes would certainly appear at first sight to have no relationship whatever with the osseous system, as neither in texture nor mode of growth do they at all resemble bone, being simply composed of layers of epidermis secreted one after the other until they attain the required thickness. But these epidermic scales, if but very slightly exaggerated, become susceptible of such varieties of form and structure that they often entirely lose their nature, and becoming solidified until they emulate true bone in hardness and compactness of structure, are often converted into weapons of defence or attack of very diversified descriptions; the dense and bone-like armour of the *Ostracious*, the formidable spines of the *Diodon*, and even the crystalline tooth-like points that stud the skins of *Sharks* and *Rays*, forming what is called *shagreen*, being mere modifications of the same cuticular appendages. Having advanced thus far in tracing the changeable character of the scale of a fish, adapting it to various functions, we are quite prepared to admit other important facts of still greater interest. It is only neces-

sary to examine the spines met with upon the back of a common *Skate* or *Thornback* to perceive that they are of very different character in different parts of the surface of the body. The minute scale-like points are at times converted into large hooks fixed upon the surface of the skin, which really become formidable defences. On approaching the mouth they become again so much reduced in size as to represent an exceedingly fine tessellated pavement, which covers the lips and passes even into the interior of the mouth. On reaching the margins of the upper and lower jaw their appearance again becomes changed; they are increased in size and hardness, being in fact converted into teeth which pave the whole surface of the jaw, covering it with osseous plates, or powerful hooks, or cutting teeth, such as the *Shark* possesses; but these teeth are still quite unconnected with the jaw and may be easily stripped off with the cuticle, of which, indeed, they form a part. Even the tongue itself is covered with similar plates of hard substance, smaller in size indeed, but in every thing comparable to the teeth both in character and mode of growth. Finding that the teeth in their simplest form are merely epidermic structures, nothing would be more easy than to point out a long series of almost insensible gradations through which they become more and more decidedly connected with the bones of the endoskeleton, until at length they absolutely become implanted into it, and fixed to the jaw-bones as intimately as if they were really themselves portions of the true osseous skeleton. The ligamentous bonds of union between the teeth and jaw-bones of *Lophius*, the soldering together of the teeth, and the numerous bones which, in Fishes, are made to support dental appendages, and the gradual appearance of alveolar depressions in the jaws of the higher Reptilia, are all so many steps of progressive approximation, the intermediate phases of which the scientific reader will easily supply. These facts therefore satisfactorily prove that, as far as the teeth are concerned at least, the exoskeleton and endoskeleton are so nearly approximated in texture that they actually become appendages one of the other, as the teeth are infixed into the jaw-bones that support them.

Having thus convinced ourselves that in the case of the teeth the cuticular and osseous systems become articulated together, or so consolidated as only to be distinguishable from the microscopic texture that they respectively present, we are prepared with greater confidence to expect similar phenomena in other parts of the body, and to find the exoskeleton and endoskeleton to a certain extent vicarious in function and interchangeable with each other.

No one will deny that the spines of the common *Sticklebacks* (*Gasterosteus*), or the bony-looking weapons affixed to the root of the tail of the *Sting-ray*, are cuticular in their nature and mere derivations from the exoskeleton; yet we have only to advance one step further, and we find spines in every way similar in their nature absolutely articulated by curious and most beautiful moveable joints to different

parts of the osseous system, of which we need only adduce as instances the fishing filaments upon the back of the head of *Lophius*, and the powerful weapons of *Silurus* and *Balistes* elsewhere described (vide Art. *PISCES*), where muscles are implanted into the spear-like arms here formed entirely from the cuticle, although brought into close union with the bones of the real skeleton.

Having arrived thus far and found in the cases alluded to that epidermic spines, when thus far exaggerated in their dimensions, are really converted into fin-rays and moved by appropriate muscles, it is impossible to deny that such organs may have a similar origin in other parts of the skeleton, and that the rays of the azygos, dorsal, caudal, and anal fins, as well as the interspinous bones, which cannot be referred to any known element of the endoskeleton, are in reality derivations from the exoskeleton, although implanted in the flesh and wielded by an appropriate system of cutaneous muscles. Even in their internal texture these pieces become assimilated to real bones, and that to such an extent that it even yet remains for the minute anatomist and the microscopical observer to point out satisfactory differences between the two skeletons when they thus become blended together, notwithstanding the wide interval which separates the scale, the hair, or the feather, all modifications of the epidermic system, from the tooth in its fully developed state, or from perfectly organized bone permeated by vessels and nourished by interstitial deposition.

BIBLIOGRAPHY.—In addition to the authorities quoted in the text the comparative osteologist is referred to the following sources of information. *Cuvier*, *Leçons d'anatomie comparée*, 5 tom. 8vo. ann. VIII—XIV. *Cuvier*, *Recherches sur les ossements fossiles*, 5 tom. 4to. 1821-24. *Cuvier et Valenciennes*, *Hist. nat. des poissons*, tom. 1, 1828. *Jo. Bapt. Spix*, *Cephalogenesis sive capitis osseæ structura, formatio et significatio per omnes animalium classes, familias, genera, ac ætates*, fol. Monach. 1815. *Carl Gustav Carus*, *Von den Urtheilen des Knochen und Schalengerüstes*, fol. Leipzig, 1828.

(*T. Rymer Jones.*)

OSSEOUS TISSUE. BONE. BONE

SUBSTANCE.—The tissue of bone has, within the last few years, undergone close examination by various anatomists of note. These examinations have been followed with much success, and have led to much increase of knowledge of the nature of bone, both as regards its development and its minute structure.

The general character, the varieties of external conformation, and the anatomical relation of bone to the contiguous textures, have been ably related in a previous article. Under the present head it is proposed to treat only of the minute structure and of the development of bone.

For the sake of precision in the description, the elements which conjointly form bone, or which are commonly found connected with osseous formation, will be considered under separate heads.

But before proceeding to this consideration of the separate parts it will be well to give a general description of them collectively in their natural relations.

The canals which are found every where traversing variously the substance of bone, and giving passage to the bloodvessels for the nourishment of the tissue, are known by the name of *Haversian canals*, Clopton Havers having been the first to give a full description of them. The parietes of these canals have a laminate arrangement. The laminae themselves are numerous and placed concentrically, the internal lamina, that which is in immediate contact with the vessel or vessels, being the most distinctly marked, and each succeeding one, as you proceed from the canal, having a less distinct outline.

Besides the concentric laminae there are others which surround the exterior of the bone, and may be known as the superficial laminae. In connection with the latter as well as the former system of laminae are a third set, which cannot be traced to belong to either of the foregoing orders, but which are placed between them, and form the bond of union between each system.

Late writers on this subject have said much of the corpuscles of bone; these are small cells of oval form placed between the laminae, and having numerous distinct tubes running from them in almost every direction. They have not inaptly been compared to a spider with many legs.

The corpuscles, or, as others have called them, the calcigerous cells, have a definite relation to the Haversian canals and to each other. These points, however, will be considered in detail in a subsequent page.

The foregoing are the leading points that are spoken of in treating of the structure of bone, namely, the *Haversian canals*, the *osseous laminae*, and the *corpuscles*. But, upon a closer view, it will be seen that the laminae only are bone; the canals and corpuscles are spaces existing in bone, and are not really necessary to the existence of osseous tissue, though they are necessary to its existence where the amount of substance is appreciable to the unaided senses.

Having given a general sketch of the structure as it appears when placed under a low magnifying power, it will be well to describe particularly each of the points which have been noticed.

The most important and that which will be placed first in the division is the bone substance of which the laminae are composed.

Of the substance of bone, or hyalitic substance.—Writers have, with one or two exceptions, considered the substance of bone as homogeneous and without appreciable structure. If, however, it be examined under advantageous circumstances, with high magnifying powers, there will be no difficulty in detecting a very definite though delicate structure. For the purpose of examination it is best to take a very small portion of a thin plate of bone; such may be found in the ethmoid bone of small animals, as of the rat. If the piece be well se-

Fig. 448.

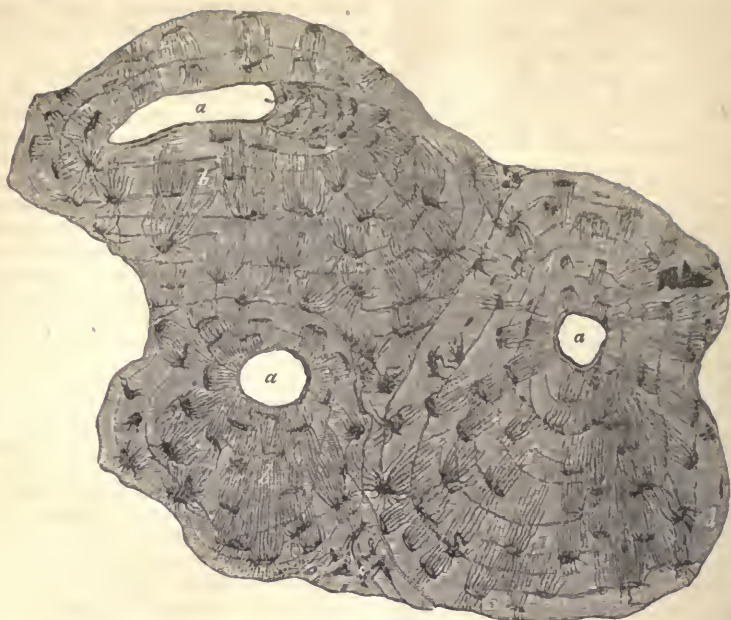

Transverse section from the dense portion of the femur.

a, Haversian canal; *b*, concentric laminae; *c*, laminae of connection; *d*, corpuscles, with their system of tubes.

The parts marked *a*, *b*, and *d* constitute an Haversian system. The figure includes three systems with laminae of connection uniting them.

lected, it will be found to contain no Haversian canals or corpuscles, but to be extremely thin and transparent. Such a portion, when viewed with the one-eighth of an inch object-glass of Mr. Powell's microscope, will present a delicate granular aspect with the surface nodulated. This granular appearance arises from the substance of the bone being composed of minute irregularly spherical granules. It is not difficult to trace this structure in any specimen of bone, though in some it is much more distinct than in others. Specimens put up in Canada balsam do not show the minute structure very well. It is best to place the object between two slips of glass with a little plain water.

A delicate spicula from the point where ossification is going on is usually very good for illustrating the granular tissue.

But the granules may be obtained separated from each other, so that each individual may be examined apart from its fellows. When so exposed to view, they exhibit a tolerably regular character, being mostly spherical, some few having an oval form. In some specimens the oval predominates over the spherical conformations. Often a few will be found which are egg-shaped, with the smaller end elongated, (see *fig. 449*,) though to no great extent. The osseous granules may be gained by subjecting bone to high-pressure steam, or to a red heat, till all the animal matter is removed. In either instance the granules may be obtained by taking

Fig. 449.

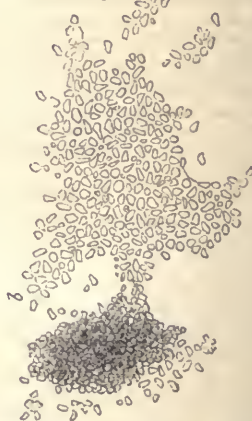

Ultimate osseous granules obtained by depriving the bone of its animal matter.

a small portion of the so treated bone, saturating it with water, and then gently reducing it to a powder between the slips of glass. By this manipulation the granules individually will be rendered evident when the specimen is examined under a high power. But, by the breaking down of the mass, many granules are necessarily broken; to remedy this imperfect and con-

fused state of the specimen, a little dilute muriatic acid should be placed upon the glass in contact with the specimen. Solution of the powdered mass will instantly commence, but the broken granules will have disappeared before the entire ones are appreciably affected. If at this point of the experiment the acid be removed and replaced by pure water, a perfect specimen will be gained. In examining the tissue under consideration it is most satisfactory to watch the action of the acid upon the calcined or steamed bone, and especially its action upon the small masses, for in these, when undergoing the action of dilute acid, the granules composing them become particularly distinct, so that their individual character may be studied; and if the solvent be not removed, their separate disappearance may be watched as the superficial ones are exposed and acted upon by the solvent fluid. If the acid be left with the so treated bone for a sufficient length of time, all the earthy matter will be dissolved and there will remain a transparent indistinctly cellular mass, which may be supposed to be an intergranular substance, the purpose of which was to unite the granules into a compact whole.

Bone which has been treated with dilute acid without the previous removal of the animal matter, soon loses the earthy component, leaving only the animal. This, however, does not tend to develop the granularity; indeed it seems, in most cases, to render it less distinct than in either the unaltered or the calcined bone. The granules themselves are subject to some variety in size, commonly varying from the one-sixth to one-third the size of a human blood globule.

Of the laminae.—The form taken by the bone substance is that of laminae, and these laminae have a definite arrangement, so much so that three distinct systems may be recognised, namely, laminae of the Haversian canals; secondly, the laminae which connect the Haversian systems; and thirdly, the laminae which form the surface of the bone and enclose the two previous orders.

The laminae of the Haversian canals have a concentric arrangement, and present, when divided transversely, a series of more or less distinct and perfect rings: see *figs.* 448 and 450. They are subject to considerable variety in number, but the more common amount is ten or twelve. Of these, the internal lamina, that which forms the parietes of the Haversian canal, is most distinctly marked, while each succeeding one as you proceed outwards becomes less distinct. The concentric laminae with bone cells and central canal have received the name of Haversian system from Dr. Todd and Mr. Bowman in their work on Physiology.

Connecting these Haversian systems is a second series of laminae, without which the former would exist but as a bundle of loose tubes. (See *fig.* 448, c).

In this substance we find the laminated arrangement less distinct, far less regular, and the laminae individually subject to great irregularity of thickness. It is often also more transparent than either the Haversian or exter-

nal system. Bone cells contained in it are also more irregular in shape than those found in other situations. The last division consists of those laminae which surround the exterior of the bone. These have greater individual extent, but are the least numerous. They are continuous with the laminae of the Haversian system whenever the latter arrive at the surface of the bone; the external laminae in this case being continuous with the inner laminae of the Haversian system.

Some authors have doubted the existence of a laminated arrangement in bone. If, however, young bone be examined, all doubt upon the subject will be dispelled, and especially if it be first macerated in weak muriatic acid, when the appearance represented in *fig.* 450 will be seen. In bone so treated the laminae may with

Fig. 450.



The laminae as they appear after the removal of the animal matter by the action of acid.

the assistance of two needles be separated. In the bones of old animals the laminae are much less distinct; in these, however, they may be demonstrated if acid be used. Though the external lamina is very distinct, and therefore the boundary of each Haversian system, yet in bone of advanced age the distinctness is lost in common with the definite outlines of the three orders of laminae. The cancelli of the cancellous portion of bones are but enlarged Haversian canals, which in addition to vessels contain fat; the laminae therefore which form the walls are those of the Haversian system.

In connection with this division of the subject, the effect of madder given to an animal with its food upon the osseous system may be noticed, since the colour is imparted to the laminae. By the taking of madder into the stomach the effect of giving a deep red tinge is very soon observable. In a pigeon the bones were rendered brilliantly red in twenty-four hours. In a young pig a similar effect was produced in three weeks.

On making sections of bone so affected the colour is found to be present in the external laminae of the bone, and in the inner laminae of the Haversian system, thereby proving that the action of colouring takes place upon those surfaces which lie in contact with vessels. This fact, with many others in this article, was mentioned in a paper by the author read before the Royal Society in June of 1838.

Of the Haversian canals.—These canals

have to be considered in relation to their number, their size, and the parts which they contain. The number of canals in a given space is perhaps a little variable, but this variation will be regulated in some degree by the situation of the bone, but more especially by the age of the bone. Thus the transverse section of the femur of a human fetus of seven months will present many more canals than a section of equal measurement from the femur of an adult.

In certain fish of which the Scarus is a specimen, the Haversian canals are extremely numerous, so that bone cells become unnecessary, for here we find very few indeed, and in some sections none. (Fig. 451.)

Fig. 451.

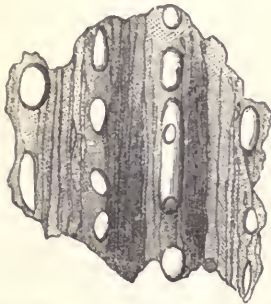

Section of bone from the Scarus; showing that where the Haversian canals are very numerous the bone cells are absent.

The size of the Haversian canals takes a considerable range, varying from the $\frac{1}{300}$ rd to the $\frac{1}{30}$ th of an inch, as stated by Mr. Smee. In the young subject they seem larger than in the old. But by far the most marked difference in size of these canals is to be observed in the antlers of the stag at different periods of their growth. At an early period of the existence of the antler, the vascular canals are large and numerous, while at the time of their completion in size the canals are less numerous in an equal space, and very small: indeed many seem all but obliterated. The density of bone is produced more by the small size of the canals than by their comparative infrequency, though undoubtedly they are less frequent in the compact bone, as that composing the shafts of long bones.

In tracing individual canals, it will be found that the majority maintain the same size as far as we can follow them. This is not, however, observable in all. If a large canal be taken where it first enters the substance of the bone, it may be found giving off branches from time to time in various directions, and then again sending off smaller branches, which anastomose freely with each other, often joining at right angles.

Although it is very easy to trace a large canal pervading a bone, and then dividing from time to time into smaller ones, I have never been able to satisfy myself that these small canals again unite to form a second large canal, and thus to leave the bone. I am therefore led to the opinion that such does not occur, but that the small even-sized canals open and

give exit to their vessels upon the surface of the bone generally, while the large canals give entrance to arteries.

The Haversian canals undoubtedly give passage to bloodvessels, which is their principal, if not their only purpose. Whether they contain one or more vessels seems to admit of a little doubt. Dr. Carpenter, in his work on Physiology, states that they contain an artery and vein. From my own observation I am not able to confirm his view. Indeed I am disposed to the opinion that they give passage to one vessel only; that the larger canals which are found entering the bone convey an artery; that it divides from time to time after the manner of the canals described; and that the vessels emerge again from the surface of the bone as capillaries. This branch of the subject requires some further investigation. The foregoing observations apply only to dense bone. Where bone is cancellated for the reception of fat, the vessels occupy but a small space in the cancelli.

Of the corpuscles or cells of bone; also called *lacunæ* by Dr. Todd and Mr. Bowman.—The so-called corpuscles are nothing more than small cells existing in the substance of the tissue, and might with propriety be called *bone cells*. Some anatomists have designated them

Fig. 452.

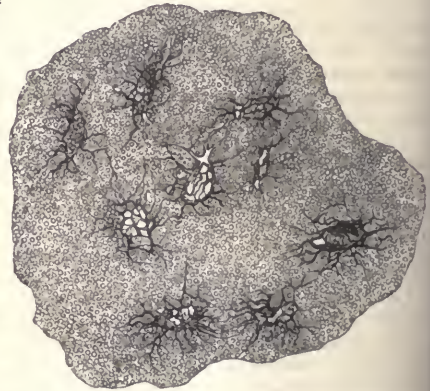

Section of a flat bone, showing the bone cells in the granular tissue.

calcigerous cells, from the supposition that they contain in their interior an amorphous salt of lime. That this view is incorrect will be subsequently shown. The cells cannot be described as having any definite unvarying shape or size. The general form is a compressed oval, though not unfrequently they are circular, but flattened from side to side. Again, they are sometimes almost triangular in their outline, while in other instances they approach a linear shape. These are the most common varieties of outline to which the bone cells are subject; as they occur in the bones of man and the higher animals. But connected with the cells are numerous delicate branching tubes, which are slightly dilated as they enter the cells. The number arising from each cell does not allow

Fig. 453.

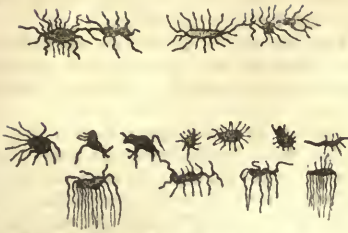

The forms assumed by the bone cells in man.

Fig. 454.



Various forms of bone cells found in the bone of the Boa Constrictor.

Fig. 455.

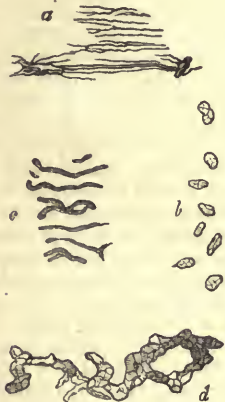

a, form of bone cell in the common frog; b, bone cells from the crania of the common goldfinch; c, form of bone cell in the sheep's-head fish; d, form of bone cells in the green-boned fish.

of any very definite enumeration, since no two cells will be found possessed of a like number of branching tubes. The general arrangement of the tubes is radiate as regards the cells, which forms their common centre. This statement requires some qualification, for not uncommonly a much greater number of tubes arise from one side of the cell than from the other, and these tubes all

take one direction. A tube after passing some little distance from the cell will in many instances divide, and each division pass on distinct from its fellow, equalling in size the parent tube. Frequent anastomoses are effected between different tubes arising from the same cells, but far more frequently between those which arise from neighbouring cells. So frequent are the connections that a free communication is established between the various cells and branching tubes throughout the substance of the bone.

So numerous are the connections between the tubes, and immediately between the cells through the tubes, that a fluid introduced into one cell in a bone may find its way into every other cell of the bone. Indeed this does take place, though not from a single cell, yet from the surface of the bone. If, for instance, you place a bone that is dry, and opaque as a consequence of being dry, in spirits of turpentine, in a very little time this bone, before opaque, will become comparatively transparent, and this through the fluid having passed through the tubes into the cells. For, as will be shown, it is the tubes only that open upon the surface of the bone, either the external surface or the surface of the canals for vessels. Indeed, if a thin section of bone be taken and all moisture removed, and spirit of turpentine be added to it, when under the microscope, the passage of the fluid through the tubes may be seen, an experiment suggested by my friend Mr. Bowman.

Besides this relation between the tubes themselves and their cells, they have a very definite relation to the Haversian canals as well as to the free surface of the bone and also to the laminae.

The position occupied by the cells is between the laminae, or on the surface of the laminae; and where concentric laminae occur, as in the Haversian system, the cells are arranged in circular lines between the laminae, each line of cells having as an exit common to it and the connecting laminae the Haversian canal. The flattened sides of the cells are parallel with the circumference of the Haversian canal, while their greater diameter is in the direction of the circular line of the lamina, or with the length of the canal to which they belong. Bone cells so placed send out numerous tubes, which pierce the laminae at right angles and proceed in great numbers to the vascular canal, into which they enter, there terminating in an open mouth upon the surface; thereby establishing a connection of tube channels between the bone cells of the Haversian system and the canal of the system. (See fig. 448.) Although these cells send out many tubes in the above direction, yet others, though comparatively few, take an opposite course, and then establish by anastomosis a connection with the tubes of the surrounding bone cells. This is more particularly seen when we look upon a transverse section of an Haversian system; but if a section taken in the length of an Haversian system be examined, the tubes will for the most part be seen dividing the cells equally in point of number from every part of the circumference of the cell, and of course proceeding in the length of the laminae between

which the cell is placed. As in the transverse section of the Haversian system these tubes that take the longitudinal direction are not seen, so in this section the tubes proceeding directly towards the Haversian canal are but badly shown. So many of the delicate tubes take the direction of the Haversian canals and enter it, that the parietes of each canal at first sight have a radiate appearance, which has led some writers to describe a system of radiate tubes passing through some of the laminae, but they have failed to trace their connection with the bone cells not far distant. When the cell with its radiating system of tubes is situated near the surface of the bone, the direction of the latter will be mostly towards that surface, unless indeed there is a vascular canal near at hand, in which case many will proceed towards it.

Those cells which are placed in the connecting laminae send out their tubes tolerably equally in each division, anastomosing freely with the tubes coming from the cells belonging to the Haversian or superficial system of laminae, and so establish a communication between the cells of the three systems of laminae. The number of tubes and the size of the bone cells bear to each other no definite proportion; thus a small cell may have many tubes while a much larger one has comparatively few. The number of the cells in a given space is subject to considerable variety, as well as the number of the radiating tubes, though generally the number of tubes will exist in inverse proportion to the number of the cells. Thus in the crania of small birds the cells are of very frequent occurrence, while the tubes connected with each cell are but

few. Again, in dense bones of quadrupeds and of man, the cells are less frequent, but the tubes of each cell far more numerous.

Where the canals for vessels are very numerous the bone cells become more rare, and in some cases they are nearly absent, as shown in *fig. 451*.

From the foregoing description it may be seen that the infinitely numerous tubes everywhere connected amongst the cells, converging at certain points and entering into cells, in fact form these cells; that the cells are nothing more than many tubes coming to a point and losing their individual parietes.

In other cases where the tubes to each cell are not numerous, the cell itself may be compared to a dilatation of those tubes. This view of the subject is borne out by the fact that even in the human subject we find here and there tubes occupying the place of the cells and their radiating tubes, while in certain fish the cells are almost entirely absent and the simple tubes general.

In such instances the tubes hold the same relation to the Haversian canals as do the bone cells where they exist. (See *fig. 456*.)

The cells when seen by transmitted light, especially in a transverse section of bone, appear perfectly opaque; this has given rise to the opinion that they contain some amorphous salt, and the fact that these same cells become transparent when the bone has been subjected to the action of acid, confirmed observers in this opinion, and that this salt was a salt of lime. When first these observations were commenced I was disposed to hold a like opinion, but further investigation has convinced me that as a rule the cells are empty. I have seen, and that too

very frequently, cells which were obviously without contents, and this observation may be repeated in any bone where the cells are tolerably large by making a section in the length of bone, and so parallel with the direction of most of the Haversian canals. By making such a section you expose the cells in their largest diameter, when they may be seen into; whereas if cut through in their narrow diameter they are so deep that they produce complete interference of light, and so seem black, as though filled with some opaque substance.

Again, if turpentine or thin Canada balsam be added to a section quite dry beforehand, the dark cells will become filled with turpentine or balsam, and so become transparent.

The function performed by the bone cells is no doubt that of circulation. Atmospheric pressure would prevent them from remaining empty, and as their openings are always upon a surface where there are bloodvessels, the fluid portion of the blood is probably carried into them. Supposing them once filled with liquor sanguinis, the varying density of the blood itself would produce a slow kind of circu-

Fig. 456.

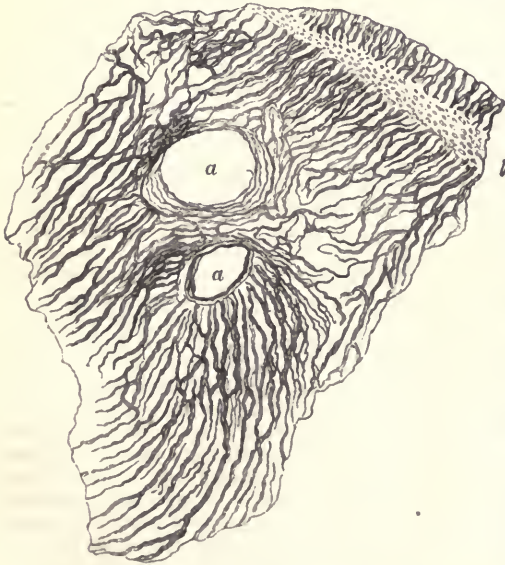

Section of a bone of an osseous fish.

a, transverse section of Haversian canal; *b*, longitudinal section of an Haversian canal with system of tubes opening into it.

lation, even though the contents of the cells remain unaltered, which is not probable.

Cells of smaller form and having branching tubes are to be found in the vegetable world. The shells of various fruits, as the cocoa-nut, peach, common nut, &c. present cells so like those of bone that a section of shell has often been mistaken for one of bone. In this instance they also answer the purposes of circulation.

The growth of bones.—Many experiments have been made to ascertain the mode of growth in bones, but they have given as their results the direction of increase rather than the process of interstitial growth. The experiments alluded to are commonly spoken of as the madder experiments, and were instituted by Du Hamel, Detlif, Hunter, Stanley, Paget, and others.

It was discovered that phosphate of lime acts upon the colouring matter of madder as a mordant. Thus, if phosphate of lime be precipitated from a state of chemical combination in a solution of madder, the colouring matter of the madder is carried down with the phosphate in a state of chemical combination, imparting to the phosphate a red colour, which is not diminished by repeated washing, but gradually fades by exposure to light. But, before this discovery was made, it was found that the bones of some pigs that had been accidentally fed upon madder were rendered red. Attention having been drawn to this curious fact that madder given in the food reddens the bones of the animal, the madder experiments were undertaken, and led to the following results.

If madder be given to a growing animal, and the bones be examined by making a section of a cylindrical bone, a ring of reddened bone will be seen to form the circumference of the bone, and a similar reddened ring to form the parietes of the medullary cavity. If in this experiment the animal had been old, these rings of red would not have been seen, or, if seen, only very faintly. From these two experiments it has been deduced that the bone, or rather the phosphate of lime, which has been deposited during the exhibition of the madder, has alone been reddened.

If, however, after giving madder to a growing animal for a time, its use be discontinued for a while and then be again given, several rings of reddened bone will be observed on making a section of a cylindrical bone, that is, reddened bone will be deposited during the use of the madder, and white bone at the interval of its discontinuance. So that, by the alternate use and disuse of madder, rings of red and of white bone will be formed to a considerable number. From these experiments it has been deduced that bones increase in their diameter by the development of the bone on the surface somewhat in the same manner that a crystal increases in size by additions to its surface.

Mr. Gibson, however, for a while threw some doubts on the value of the madder experiments and the deductions from them, by stating that the serum of the blood had an affinity for the

colouring matter of madder superior to that of the phosphate of lime, and that the bone became stained only after the serum had been thoroughly saturated with madder, and more, that the serum, from the discontinuance of madder in the food, or losing the colouring matter, absorbed that existing in the bones.

Mr. Paget has, however, proved that the affinity is far stronger between phosphate of lime and the colouring matter of madder than between serum and the latter. These experiments seem at first sight far more valuable than a closer investigation will prove them to be, as will be seen on considering the following fact, namely, that not only is the surface of the bone with the walls of the medullary cavity tinged red by the exhibition of madder, but also the circumference of every Haversian canal throughout the bone, in fact every surface that lies in contact with a vessel or vessels. The fact that every Haversian canal has its coloured ring had escaped observation, as these experimenters had been limited to the use of the naked eye, whereas the Haversian canals, with their coloured rings, are only seen by the use of the microscope.

It therefore remains for observation to be made upon the effects of consecutive feeding with and without madder, upon the Haversian canals, before any very accurate deductions can be made.

Other experiments have been tried in investigating the growth of bones.

Rings of metal have been lightly fixed round a long bone, which after a while has been found to contain the rings in its medullary cavity, from which it has been inferred that the bone has grown by additions to its circumference, while the medullary cavity has been enlarged by the absorption of the bone forming its parietes. These experiments, which were made by Du Hamel, have been confirmed by Hunter and Stanley.

Experiments of a similar nature have been made to determine the manner of growth in the length of bones. Thus holes have been bored in the tibia of a dog at definite intervals, which intervals, after the lapse of some days, have been found altered in the relative lengths. The intervals near the ends of the bone have increased considerably, while those situated near the centre of the bone have scarcely changed. Mr. Stanley has shown that in some animals the growth is greatest at the distal end, while in other animals it is greater toward the proximal end of a long bone.

In the two experiments which I have related in a previous part of this article the walls of the medullary cavity were as distinctly reddened as the circumference of the bone, and the circumference of each Haversian canal as either. These would therefore prove too much for the theory which supposes that a long bone increases its diameter by the depositions upon its surface and under its medullary cavity by the absorption of the walls. Supposing the idea that phosphate of lime, which is deposited during the exhibition of madder, is alone red-

dened to be correct, the parietes of medullary cavity should not show colour, as here absorption is supposed to be going on.

From what is already known, I think that the bones are coloured by the madder just in proportion to their powers of imbibition, which will be in inverse proportion to the amount of phosphate of lime which they contain.

As regards the growth of bone, the laws common to the growth of every other tissue and to the whole body will, I think, be found to hold good. And the growth of these organs will be found to be interstitial, pervading the whole substance, though the action will be more energetic at some points than at others, as the neighbouring organs may require greater length or breadth in one direction than in another.

The younger the bone the more rapid will be its growth, but this law is common to all the tissues. The increase of length of a long bone at the epiphysis must not be confounded with growth of the bone, for here, so long as cartilage connects the shaft with the epiphysis, osseous tissue is being developed; whereas, in speaking of the growth of bones, the increase of the tissue already developed is alone meant.

Of the development of osseous tissue.—As the development takes place in cartilage, and as the cartilage undergoes some change previous to its giving place to bone, it will be well to give a slight sketch of the structure of temporary cartilage before going into the formation of the more permanent tissue. The rudimentary condition of cartilage may be best examined in the foetal chicken, a few days after the commencement of incubation. The exact time for making the observation will be found by taking an egg for examination every six hours, commencing after the eggs have been exposed to the due temperature for thirty-six hours. On the first appearance of the vertebral column, which will present a semitransparent line in the length of the developing foetus, the whole must be removed with great care to the field of the microscope. This part of the operation requires some care, but with a little management may be successfully performed. I found but little difficulty in removing the delicate object after adopting the following plan. Having, in the first place, placed the egg in a dish of water of sufficient depth to cover it, let the shell be carefully removed; then, by moving the water with the assistance of a camel's-hair brush, take away the albumen so as to leave the yolk free. The point where development is going on will then be sufficiently conspicuous. At a considerable distance around this the membrane of the yolk should, with a pair of sharp scissors, be cut through, and carefully separated with the aid of a camel's-hair brush and a pair of forceps. This having been effected, the subject for examination will be left on the surface of the yolk, and may, with delicate manipulation with the pencil, be removed to a slip of glass held near it under the surface of the water. Having completed your purpose so far, the glass must be raised

very slowly from the water, so that the specimen may not float off, and this being covered with a little thin talc or glass supported at the sides, so that it shall not press upon the embryo to be removed to the field of the microscope. If the specimen be favourable, the semitransparent line of the vertebral column will under a low power appear made up of a vast number of clear colourless oval cells, so closely connected as to leave no appreciable space between the individuals composing the mass. Under a higher power, however, each cell will present a definite outline with a central nucleus or nuclei, and even in some nucleoli. The cells give the appearance of density and clearness of substance, and with their definite and smooth outline present a great contrast to the highly granular cells of development that surround them. In each vertebra there is some show of a radiate arrangement, for many cells are egg-shaped, and have their small ends placed towards the centre of the growing mass. At this period of the formative process the cells are so close to each other that there is no space for intercellular tissue.

With the growth of the embryo the cartilage advances, and its development as a perfect tissue is completed by the separation of the cells from each other by the interposition of an intercellular tissue. This latter is transparent and dense, but without traces of definite structure, unless it be a minutely granular tissue. Temporary cartilage is thus shown to be composed of cells having parietes and contents, and intercellular, (see fig. 457) or, as some

Fig. 457.

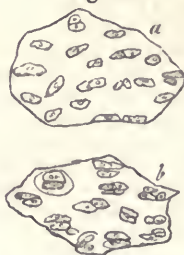

a, temporary cartilage, with the corpuscles and intercellular tissue; *b*, temporary cartilage, with the corpuscles forming for ossification.

have called it, hyaline substance, through which the cells or corpuscles are equally distributed. In cartilage thus constituted, the development of bone proceeds. With the commencement of the development of bone, great changes occur in the arrangement of the cartilage corpuscles as the immediate precedents of ossification. They are no longer equally distributed through the hyaline substance, but are found arranged in parallel columns of variable lengths, in the line of the length of the bone. The corpuscles forming into columns necessarily leave intervening columns of intercellular tissue. A notion has pretty generally prevailed that the corpuscles already formed marshal themselves into this order. I think, however, that on further investigation it will be found that each corpuscle has developed others, and that they have been developed in one direction only, and that towards the line where osseous formation has commenced; for we find that the first perceptible change in

temporary cartilage on the approach of ossification is that the corpuscles, instead of being solitary, are arranged in groups of variable numbers according as they are near or far off the site of immediate ossification; that they have a linear arrangement, and where there are two or three only this is somewhat semilunar, with the straight edges near each other; and that the greatest diameter is lateral. (See *fig. 457, b.*) Moreover, the columns are not continued uninterruptedly through the cartilage, but are broken off, and near their terminations new ones commence, not, however, in a line with the former, but opposite their intercolumnar spaces. (See *fig. 458.*)

Fig. 458.



Temporary cartilage, with corpuscle arranged in columns.

a, intercolumnar or cellular tissue; *b*, parietes of the corpuscle; *c*, central cavity of the corpuscle.

Thus at the end farthest from the point of ossification the corpuscles are flattened and closely arranged, presenting an appearance not unlike a pile of pence. But as we trace the line down towards the bone, each corpuscle becomes more distinct, is separated from those on either side, becomes itself enlarged, and of nearly equal dimension in each direction. (See *figs. 458 and 460.*) The intercellular tissue becomes distinctly visible between each corpuscle. The space also between the columns, though always considerable, is increased when the corpuscles have undergone the above change. (See *fig. 459.*)

Fig. 459.

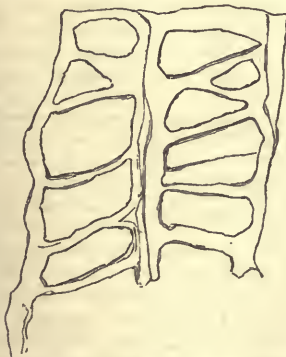

Section of the intercellular or hyaline substance, the corpuscle having been removed.

Not only are the described changes in form

and relative position observable, but a further remarkable development takes place in each corpuscle. The parietes of the cell, which at first formed but a small part of the whole, at this latter situation has so far increased in dimension that it forms by far the greater part of the mass, while the central portion, which at first appears to constitute the whole corpuscle, notwithstanding its increase of size, is now to be regarded only as a nucleus, presenting the appearance of a cavity or granular cell, of a form approaching that of a sphere. (See *fig. 460.*)

Fig. 460.



Section of temporary cartilage, which has undergone the last stage towards ossification.

a, intercolumnar tissue; *b*, the enlarged parietes of corpuscle; *c*, central nucleus of the corpuscle.

Cartilage, when it has been subject to the above changes, in the next transition becomes bone. In order to understand this process it will be necessary to bear in mind the following points: first, that the enlarged cartilage corpuscles are arranged in vertical columns; that each column is surrounded by the intercellular tissue, and that each corpuscle is separated from those above and below by a layer of intercellular tissue; and, lastly, that each corpuscle has distinct parietes with central nucleus, or cavity, containing granules or having granular parietes. Osseous tissue is in all instances developed in the form of minute granules, so the earliest appearance of bone in cartilage is marked by the presence of these spherical granules in the intercolumnar and intercellular tissue, which is thereby increased in density and opacity. This constitutes the first stage in the process of the development of bone, and may be observed by making a thin section of a bone at the point of junction of the bone and cartilage, where the shaft is connected with the epiphysis. (See *fig. 461.*) The granular appearance will be

Fig. 461.

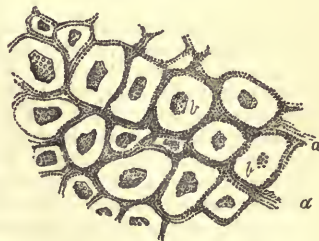

Transverse section of temporary cartilage in the first stage of ossification.

a, a, intercellular tissue ossified; *b*, the transparent parietes of the enlarged corpuscle; *c*, the central nucleus, which in the specimen from which this figure was taken was granular.

increased if a little acid be added to the section; caustic alkali will produce a similar effect. The intercellular tissue having become granular, the parietes of the corpuscles next undergo a similar change, and the central nucleus or cavity can no longer be identified. The accession of granules to the parietes of the corpuscles constitutes the second stage of the process of ossification.

The third stage is an action of a different nature, and is fulfilled in the absorption of the osseous matter interposed between the cells, and also of that portion of the ossified cells which lay in contact with the intercellular tissue of the columns.

By this change, the column, once composed of closed cells, is converted into a tube marked by numerous indentations corresponding in number to the cells which entered into its formation, there being a contraction at the points of junction between the cells. The tube so formed, supposing this condition to be permanent, would have closed ends, and the length would be determined by the ends of the columns of cells from which it was formed. (See *fig. 462.*)

These elongated tubes, I believe with the authors of "The Physiological Anatomy," to be the Haversian canals in their rudimentary state. They do not, however, retain this form of tubes with closed ends, but like individual cells become perforated and communicate with other tubes similarly formed; but as these do not follow each other in straight lines, the openings are formed at the sides of the tubes instead of their ends, so that these communications are at angles with the tubes. These and other openings which are formed between the cells or tubes lying parallel to each other are those Haversian canals in their rudimentary state which traverse bone at right angles to its length, and form anastomoses with the longitudinal Haversian canals, which in bone are by far the most numerous.

In the tubes no trace is left of the central nucleus or cavity of the original cartilage corpuscle; they contain, however, small spherical bodies composed of very minute granules. These are transparent and resemble in appearance those peculiar globules found in the blood and commonly designated lymph globules. (See *fig. 462.*)

They are very numerous, and, indeed, almost fill the cavity. They have a red tinge, and constitute almost entirely the mass of red matter found in the interior of all recently formed and forming bone. These bodies were described by Dr. Todd and Mr. Bowman, and they suppose them to be concerned in the development of vessels, since up to this period of ossification no bloodvessels exist in the forming tissue, but make their appearance so soon as the tubes become pervious.

If a transverse section be made of bone in this stage of its formation, there will be no difficulty in recognising, first, the ossified intercellular tissue, then the ossified parietes of the once cartilage corpuscle, which, being

now the lining of the tube, will eventually be the external lamina of an Haversian system; and, lastly, the granular globules contained in the tubes.

The last point for consideration in the development of bone is the formation of the bone-cells. Several recent authors consider the cells to be formed from the nucleus of the cartilage corpuscle; I have not been able to confirm their statements, but have been led to entertain a different opinion of their origin. The formation of tubes having been completed, the inner layer formed from the parietes of the corpuscle is at first thin, and, could it be withdrawn entire, would look like

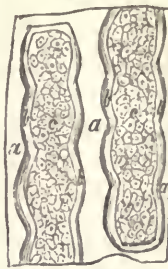

Section of the tubes formed by the cells.

a, intercellular tissue ossified; *b*, ossified parietes of the corpuscles; *c*, granular globules contained in the tubes.

a tube formed by the junction of a number of hollow beads. Partial separation may, however, be produced, as seen in *fig. 463.* This state of alternate dilatation and contraction seen in the tube at its first formation is soon lost, and the tube becomes of nearly equal diameter throughout from the filling up of the dilatations by the deposition of osseous matter in the usual granular form. But in this filling up of the dilatations small cells are left, and these are the bone-cells in the rudimentary condition, and form the outer layer of cells in the Haversian system. (See *fig. 463.*) At first it is difficult to distinguish the tubes of the bone-cells, but if a section be taken near the perfected bone, they will be seen in various stages of development. At this late period of the formation, bone-cells appear in the ossified intercellular tissue, which from the first formed a connection between the systems of tubes, and which in fully formed bone unites the Haversian systems. With this perfect state.

Fig. 463.



Section showing the development of the bone cells and the separation that may be produced between the ossified intercolumnar tissue and the tissue of the united cells.

a, ossified intercolumnar tissue; *b*, ossified parietes of the united cells; *c*, the Haversian canal in its rudimentary state; *d*, bone cells in their first stage of development.

becomes the external lamina of an Haversian system: so that the parietes of the cell in

the development of bone is the formation of the bone-cells. Several recent authors consider the cells to be formed from the nucleus of the cartilage corpuscle; I have not been able to confirm their statements, but have been led to entertain a different opinion of their origin. The formation of tubes having been completed, the inner layer formed from the parietes of the corpuscle is at first thin, and, could it be withdrawn entire, would look like

a tube formed by the junction of a number of hollow beads. Partial separation may, however, be produced, as seen in *fig. 463.* This state of alternate dilatation and contraction seen in the tube at its first formation is soon lost, and the tube becomes of nearly equal diameter throughout from the filling up of the dilatations by the deposition of osseous matter in the usual granular form. But in this filling up of the dilatations small cells are left, and these are the bone-cells in the rudimentary condition, and form the outer layer of cells in the Haversian system. (See *fig. 463.*) At first it is difficult to distinguish the tubes of the bone-cells, but if a section be taken near the perfected bone, they will be seen in various stages of development. At this late period of the formation, bone-cells appear in the ossified intercellular tissue, which from the first formed a connection between the systems of tubes, and which in fully formed bone unites the Haversian systems. With this perfect state.

From what has been stated it will be seen that the cartilage cell or corpuscle is the first part formed; that this cell generates others; that they form the lining of the primary tube; that the lining becomes the external lamina of an Haversian system: so that the parietes of the cell in

perfect state. From what has been stated it will be seen that the cartilage cell or corpuscle is the first part formed; that this cell generates others; that they form the lining of the primary tube; that the lining becomes the external lamina of an Haversian system: so that the parietes of the cell in

the embryo may be considered the element of the laminae.

Again, the intercellular tissue found in the embryo forms the medium of connection between the cartilage cells or corpuscles, as they are called, between the primary tubes, where bone is developing, and lastly, becomes the bond of union between the Haversian systems.

The foregoing description applies to the growth of the shaft of a long bone in the cartilage connecting it with the epiphysis.

The laws regulating the growth of the epiphysis in the cartilage which unites it to the shaft of the bone are but a slight modification of those which regulate the growth of the shaft. The cartilage corpuscles, however, here form small rounded groups, and ossification proceeds in the intercellular tissue around them, and the groups themselves eventually form a cavity, by which means the spongy head of the bone is formed. The flat bones are developed much as the long ones, the thin edges of these being tipped with cartilage, which develops its cells, and intercellular tissue.

A bone at the time of its development is of equal density through the whole diameter at the point where ossification is just perfected. The arrangement of compact and spongy, as seen in the various bones, is an after process which takes place gradually, and in relation to the individual bones of which the framework of the body is composed.

On considering the process of development of bone, it will be apparent that the arrangement of cells, intercellular tissue, &c. answers the purpose of giving a definite form and arrangement for the future nourishment of the bone, but that osseous tissue is independent of any particular form. Thus intercellular becomes osseous tissue, as does the tissue of the cells. I wish to lay stress upon this point, as it bears particularly upon the character of certain formations of bone in unnatural situations, or *adventitious bone*.

Ossification of permanent cartilage.—The cartilages of the larynx at an advanced age are liable to become ossified, and in such cases, as the formation of osseous tissue goes on but slowly, the process may be observed with ease. In this case the corpuscles do not develop others as in temporary cartilage where increase of size is required, but retain their usual appearance. While the osseous granules are developed in the intercorpuscular tissue, at first but few of them are seen, and these spherical and isolated; they soon, however, become numerous, and unite, thereby forming an osseous mass. The intercellular or intercorpuscular tissue having advanced in ossification, the corpuscles, or rather their parietes, pass through the same process, and by degrees the whole cartilage becomes converted into bone.

The formation of the individual granules is more readily observed in these cartilages than in any other situation. This form of ossification establishes an interesting and explanatory link of connection between bone and the various osseous plates we find in abnormal situations. For in the latter the spherical granules appear,

and these, at first few and isolated, and lying amongst the fibres of the tissue, rapidly increase in number, unite, and form an osseous mass.

Osseous plates occur in various soft tissues as the result of deranged action, where in the healthy condition of the part they are not found. Thus we have osseous plates formed in the coats of arteries, in the pleura, in the diaphragm; also osseous masses in the uterus; and sometimes in the muscular tissue and in the placenta. These plates are all formed in the same manner, namely, by the development of minute spherical osseous granules, which form into a mass, the shape of which is modified by the form of the tissue in which the development occurs.

I have examined many of these formations and find them to be composed of true osseous tissue, but not true bone; for they have not the definite Haversian systems, which, formed of osseous tissue, constitute bone. But they have cavities scattered through them; these, however, have no definite shape, but assume all kinds of irregular forms, and though they are no doubt necessary to the vitality of the mass, yet their action cannot be very perfect. Spiculae of osseous matter are sometimes met with in cancerous tumours, but here it is very rare to find an Haversian system. The osseous plates found in the dura mater are, however, true bone, and are developed like the flat bones. I am decidedly of opinion that these masses are endowed with vitality, and are not mere concretions as some have regarded them, though this vitality is of a low degree.

Formation of osseous tissue in union of fractured bones.—Supposing the subject in which the fractures occur to be young, cartilage similar in every respect to temporary cartilage is produced between the fractured extremities of the injured bone. In the centre of this ossification commences, the process being somewhat similar to ossification of permanent cartilage, or holding an intermediate place between that process and the ossification of epiphyses.

The corpuscles here increase in size but not in number. The ossification commences in the intercellular tissue, and proceeds to the parietes of the cells, thus forming areolæ of bone.

The action may also commence in the cartilage in contact with the fractured surface. This I believe to be the process by which repair is effected in all cases where union of fractured bones takes place, but my experiments have been confined to young animals.

I have examined various cases where union has not been effected in consequence of the patient's advanced age, and the fracture being at the neck of the femur or of the shaft of the same bone. In these I found no cartilage, and but a scanty amount of condensed cellular tissue. In this latter, however, traces of an attempt at repair may generally be found in the presence of osseous matter in granules or granular masses. In these there is no arrangement of tubes or bone-cells of definite character; indeed

these osseous masses are generally small, and sometimes without material density, the individual granules not having firmly united. In fact they resemble in every point adventitious bone.

If in a young animal the fracture be not kept tolerably quiet, the motion between the fractured bone will prevent the formation of cartilage, which seems necessary to the development of bone, and here, therefore, osseous masses will alone present themselves. This fact is very interesting in a surgical point of view, and might be treated more at length; but having given a detailed account of the development of bone and of the distinction to be made between true bone and adventitious osseous tissue, I shall conclude the article.

(*J. Tomes.*)

OVARY.—See SUPPLEMENT.

OVUM.—See SUPPLEMENT.

PACHYDERMATA.—An extensive group of herbivorous quadrupeds, constituting a distinct order of the class Mammalia, generally remarkable for their ponderous bulk and unwieldy appearance, and seemingly forming the transition between the gigantic Cetacea, which from their size are only adapted to an aquatic existence, and the vegetable-eating Mammals of strictly terrestrial habits. Even the localities where they are met with would seem to indicate that they constitute such a connecting link, seeing that their most typical forms are peculiarly adapted to be occupants of the river and the marsh, from the Hippopotamus, that

might almost be considered an aquatic animal, to the Tapirs and the Hog, which still love to wallow in mud although they approximate in their habits to the ruminating quadrupeds. At the present day the order Pachydermata contains but few genera, and these for the most part embrace a very limited number of species. But in former periods of the history of our globe they must have existed under much greater variety of form, seeing that the tertiary deposits yield to the geologist, in abundance, the remains of very numerous genera now totally extinct, to the list of which modern researches are adding day by day; it is indeed more than probable that many of the existing races will speedily perish, for the hand of man is against them, and the bullet and the spear are doing their work of extermination rapidly, so that the Tapir and the Elephant, like the Palæotherium and the Mastodon, may soon be classified with extinct existences.

The order of Mammalia under consideration is usually divided into PROBOSCIDIANS, including such Pachydermata as are provided with a proboscis and tusks, of which the Elephant is the only existing example, and into ORDINARY PACHYDERMATA, which are unprovided with a proboscis, and characterized by possessing four, three, or two large digits on their feet, which are cased in horny hoofs—the last group being distinguishable from the Ruminantia by the simple construction of their stomachs, although closely approaching them in many points of their economy. The above division, however useful to the zoologist, is nevertheless by no means based on nature, the proboscis of the Elephant being only a maximum

Fig. 464.

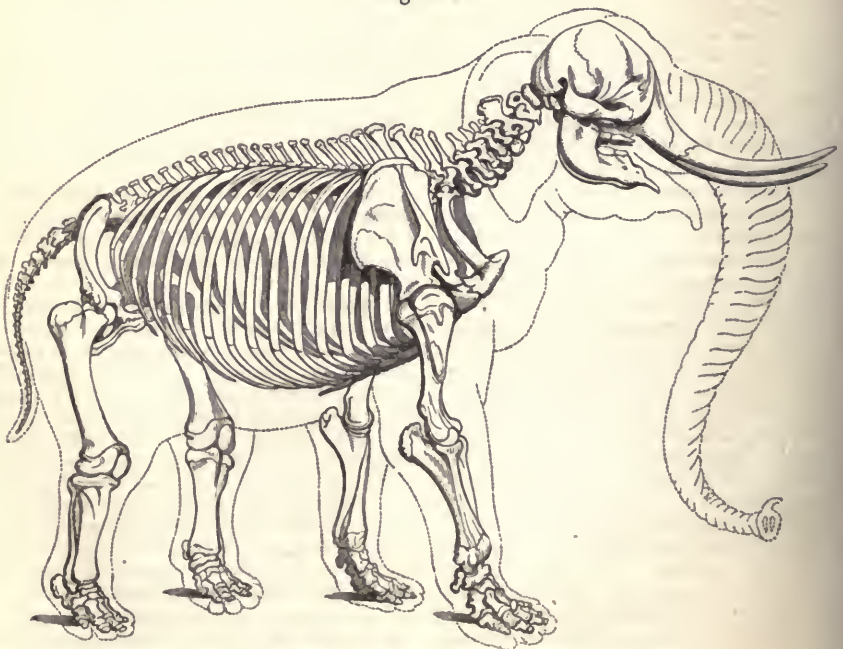

Skeleton of Elephant (*Elephas Indicus*).

degree of development of the snout of the Pig and the semi-probovidean nose of the Tapir.

The following genera of Pachydermatous Quadrapeds have been distinguished by naturalists, many of which are still in existence, but the majority are met with only in a fossil state, the names of the latter being printed in italics.

Elephas, (fig. 464.)	Hippopotamus
<i>Mastodon</i>	<i>Toxodon</i>
<i>Dinotherium</i>	<i>Coryphodon</i>
Tapirus	<i>Acerotherium</i>
<i>Puleotherium</i>	<i>Elasmotherium</i>
<i>Lophiodon</i>	<i>Macrauchenia</i>
Hyrax	<i>Hexaprotodon</i>
Rhinoceros	<i>Anthracotherium</i>
<i>Anoplotherium</i>	<i>Charopotamus</i>
Dicotyles	<i>Hyracotherium</i>
Phacochærus	<i>Dichobune.</i>
Sus	

Osseous system.—The skeleton of the Pachydermata is generally remarkable for the massive character which is conspicuous in every region, indicative, at a glance, of the ponderous strength and generally inactive habits of the animals belonging to this order; but inasmuch as they are destined to obtain their food under very various circumstances, which demand a corresponding diversity of structure in different parts of their bony framework, some detail will be necessary in adverting to this part of their economy.

Cranium.—The cranium of the Elephant, the only living genus of Proboscidean Pachyderms, is quite unique in its external configuration, and from its vertical elevation confers a remarkable aspect of sagacity to the animal; its intelligence, however, although really surprising when contrasted with the stupidity of other genera belonging to this class of quadrapeds, has doubtless been much exaggerated in consequence of its imposing appearance. This peculiar contour of the skull depends upon several circumstances having nothing whatever to do with cerebral development, but being entirely dependent upon mechanical arrangements required to support the enormous tusks that project from the upper jaw, and to give origin to the muscles of the proboscis, a nasal apparatus here only met with in a state of complete development. The extreme shortness of the bones of the nose, the nearly vertical position of the upper maxilla and *ossa incisiva*, and the swollen vault of the forehead produced by an excessive enlargement of the frontal sinuses, (fig. 466,) which gives extent of surface to the exterior of the skull, all concur to mask the real condition of the cranial cavity, which, as is easily seen in the next figure, (fig. 465,) occupies but a very small portion of the posterior and central portion of this gigantic cranium.

The general character of the individual bones of the cranium and their modifications in the principal Pachydermatous races will be understood from the appended figures better than from any lengthened description.

The *occipital bone* is very extensive, forming by itself the entire posterior wall of the cranial

Fig. 465.

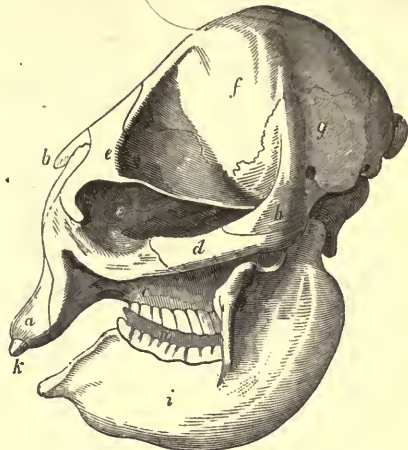

Skull of young Indian Elephant.

a, intermaxillary bone; b, nasal bone; c, superior maxillary; d, jugal; f, frontal; g, parietal; h, temporal; i, inferior maxilla.

cavity, and even in the Elephant advancing considerably upon its upper surface, where at an early period it becomes so firmly consolidated with the parietals, and these again with the frontals and temporals, that the whole roof of the skull appears to be formed of one bone. In the hog tribe, the Hippopotamus and the Tapir, it terminates superiorly in an abrupt and broadly expanded crest, into which the muscles of the neck are inserted; and not unfrequently the deep fossæ and prominent ridges visible upon its posterior aspect testify to the massive strength required in this part of the muscular system, either to

Fig. 466.

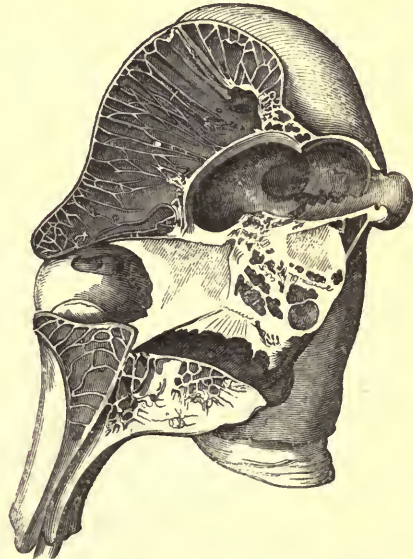

Vertical section of Elephant's skull, shewing the relative proportions between the cranial cavity and the sinuses of the skull.

support the unwieldy head or to tear up the ground in search of food, as the hog tribe do with their powerful snouts. In the young animal this bone always consists of four separate pieces—a basal, two lateral, and a superior occipital (fig. 471, c 1, c 2, c 3 :) but these soon become inseparably united into one mass.

Fig. 467.

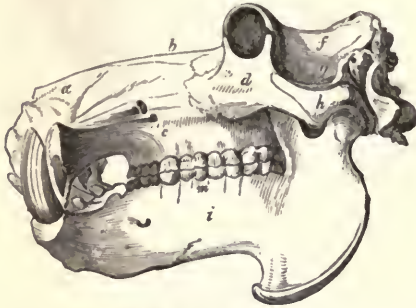

Skull of Hippopotamus.
Letters as in Fig. 465.

The parietal bones (figs. 465, 467, 468, 471, f) are moderately extensive, covering the superior and lateral portions of the skull. In the young animal they are always separated by a mesial suture, (fig. 469, b, b,) but in the adult are united by the obliteration of this suture into one piece, so as to appear but a single bone; a provision, no doubt, for admitting the enormous force of the temporal muscles to be exerted without danger of divaricating the two lateral halves, which might otherwise be torn asunder at the line of junction. In the Tapir there is a lofty interparietal crest, giving great additional surface for the origin of the temporal muscles.

Fig. 469.



Skull of a young Boar, *Sus Scrofa*, shewing the osteology of the cranium and face.

The frontal bones are of very great extent, and besides enclosing the anterior part of the cranial box, form a large proportion of the orbital cavity. In the young animal (fig. 469, a, a) they are invariably two in number, separated by a suture along the mesial line, and in the American Tapir this separation is permanent; but generally they become consolidated at an early age, leaving no trace of their original separation.

The ethmoid is, in the Pachydermata, of very considerable size, proportioned to the acuteness of the sense of smell with which these animals are gifted. The cribriform plate holds a position exactly similar to that which it presents in the human subject, implanted between the frontal and sphenoid bones, and testifies, by its great extent of surface and the numerous foramina which pierce it, that the olfactory organs are highly developed. Towards the nasal surface, likewise, the ethmoidal cells and

Fig. 468.



Skull of Rhinoceros.
Letters as in Fig. 465.

Fig. 470.

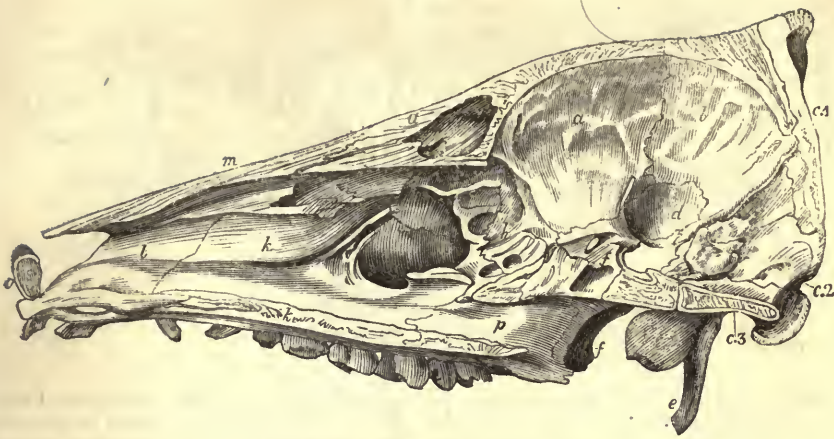

Vertical section of the skull of a young Boar.

Fig. 471.

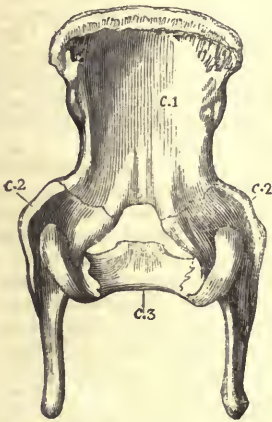

Occipital bone of a young Boar, shewing its division into four pieces.

In the above three figures the parts indicated are as follows:—*a, a*, frontals; *b, b*, parietals; *c, c, 2, c 2, c 3*, occipital; *d*, temporal; *e*, lateral processes of occipital bone; *f*, sphenoid; *g*, supra-orbital plate of os frontis; *h*, os lacrymale; *i*, jugal bone; *k*, superior maxillary; *l*, inter-maxillary; *m*, nasal; *n*, inferior maxilla; *o*, ossified nasal cartilage; *p*, palatine.

minores almost along their whole length and mask the pterygoid processes, so as to give a very peculiar appearance to the base of the cranium.

The bones of the face are remarkable for their massive development, but as their position is sufficiently indicated in the next woodcuts, it would be useless to particularize them further.

Ribs and sternum.—The thoracic cavity throughout all the Pachydermatous genera is enormous in proportion to the great bulk and excessive weight of the viscera. The ribs, in fact, are continued backwards almost to the pelvis, and from their extraordinary size and

Fig. 472.

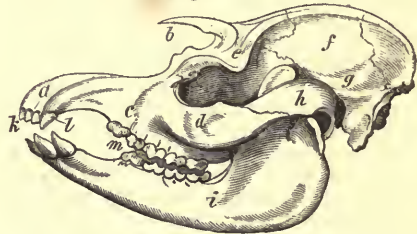

Skull of American Tapir.

Fig. 473.

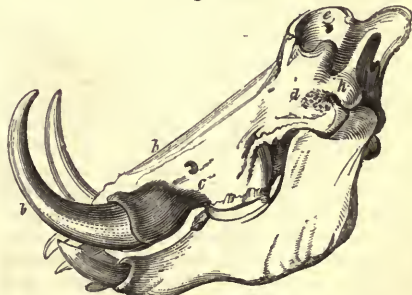

Skull of *Sus Larvatus*. Letters as in figure 465.

turbinated laminae are very large, so that the delicacy of the sense with which they are connected is evidently only inferior to that of the carnivorous quadrupeds.

The *sphenoid* occupies the same position as in the skull of Man, and in the hog tribe is very similar in its shape and the general arrangement of its processes to the human. In the Elephant the anterior and posterior clinoid processes are but slightly developed, so that the base of the cranium internally has a very flat appearance, whilst externally, such is the enormous development of the sphenoidal cells, that they stretch on each side beneath the alae

Fig. 474.

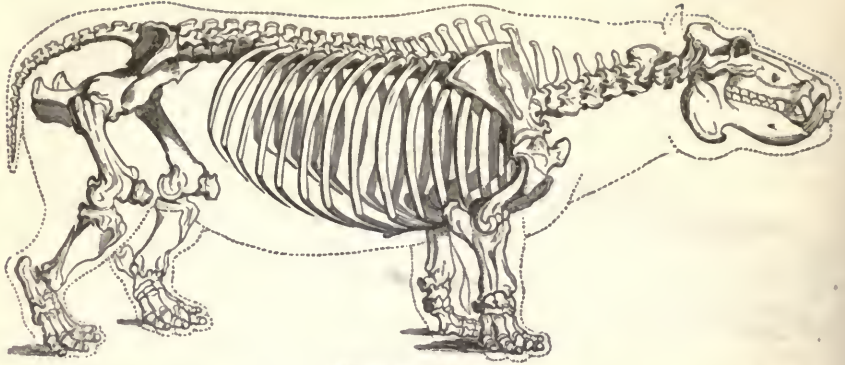

Skeleton of Hippopotamus.

breadth constitute a kind of osseous case, enclosing a considerable portion of the abdominal cavity, and calculated to give origin to muscles of power proportioned to its ponderous contents.

In the *Hyrax*, dissected by Pallas, there were twenty-two ribs on the left side and only twenty-one on the right: of these seven were true ribs, six false attached to the sternum by the intervention of costal cartilages, and the rest merely imbedded in the muscles of the flanks. The *sternum* consisted of six pieces, of which the last or ensiform was further prolonged by a spatulate cartilage.

In the *Tapir* the ribs are twenty in number on each side, whilst there are but four lumbar vertebræ. The Elephant, likewise, has twenty pairs of ribs and only three lumbar vertebræ. The Rhinoceros has nineteen pairs of ribs, and the Hog only fourteen.

The *sternum* is of considerable length and compressed laterally. In many genera, moreover, it is prolonged in front to a considerable distance, in order to allow more ample space for the attachment of muscles.

Anterior extremities.—The limbs of the Pachydermata are necessarily constructed more with a view to ensure strength adequate to sustain their ponderous bulk than to permit of agile and active movements. The smaller genera, indeed, such as the *Suidæ*, have their bones so arranged as to permit of considerable fleetness in running, but in the more colossal genera the condition of the extremities secures support at the expense of speed, and flexibility is sacrificed to solidity and firmness.

Scapula.—The shoulder-blade of the Elephant, independently of its size, might be distinguished from that of any other living animal by the following circumstances. When *in situ*, its posterior side, which is deeply concave, is by far the shortest of the three, while the anterior and spinal costæ are of nearly equal length. In consequence of the preceding circumstance this scapula is broader in proportion to its length than that of any other large quadruped, and, moreover, the spine of this bone, besides its acromial process, has towards its middle a broad sickle-shaped projection, looking backwards and spreading over

the infra-spinatus muscle. In all other Pachydermata the shape of the scapula is that of an elongated triangle, with the angles of the base much rounded off and the spine very short in proportion to the extent of the dorsum; nevertheless, in the Rhinoceros there is a falciform process projecting from the spine something like that of the Elephant, and both in the Hippopotamus and the Tapir rudiments of a coracoid process. The scapula of the Tapir (fig. 475) is also remarkable for a deep and almost circular notch between the rudimentary acromion and its anterior costa.

Clavicle.—None of the Pachydermata have the slightest rudiment of a clavicle, an arrangement which permits the anterior shoulders to be closely approximated beneath the thorax, and thus brought nearer to the centre of gravity.

Humerus.—The humerus is in all cases short, massive, and remarkable for the size and strength of the ridges and prominences for the origin and insertion of the muscles connected with it. The head of the bone which articulates with the scapula is very flat, and although large, forms but a very small proportion of its scapular extremity, the rest being made up of enormous protuberances, to which are affixed the muscles of the shoulder. (Figs. 474 and 475.)

The lower articulating surface is a simple pulley, articulating with the conjoined heads of the radius and ulna, so as to admit of flexion and extension only, no movements of pronation or supination being here admissible.

The humerus of the Elephant (fig. 464) is distinguishable from that of all other quadrupeds by the prodigious extent of the external condyle, which extends upwards nearly one-third of the length of the bone, where it terminates abruptly so as to give a square form to this part of the bone.

Radius and ulna.—As the position of the fore-arm in the Pachydermata is permanently that of pronation, no arrangement has been made in any instance to articulate the radius with the ulna by means of a moveable joint, a certain degree of elasticity (the result of ligamentous connection) being all the motion allowed even where the separation between the two bones is most complete. Sometimes, indeed, as in the case of the Hippopotamus and

some of the hog tribe, the two bones of the fore-arm are completely consolidated into one mass, the only vestiges of their having been originally distinct being the indication of a

suture near the distal extremity of the fore-arm and a deep groove running along the middle third of the bone for the lodgement of the inter-osseous artery. In the Rhinoceros and Tapir, (figs. 475

Fig. 475.

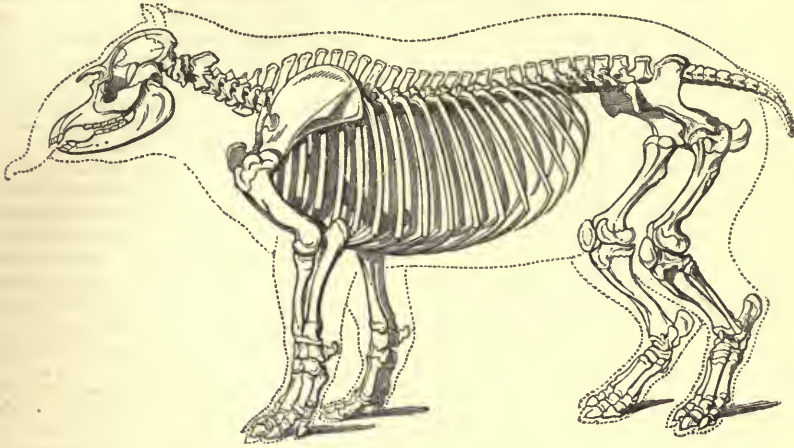

Skeleton of American Tapir.

and 476,) however, these bones remain permanently distinct, the elbow-joint being formed by the radius in front, which articulates with both condyles of the humerus and the ulna posteriorly, which completes the articulation. At their distal extremity the radius lies in front and to the inner side of the ulna, with which it is either ankylosed or immovably connected by ligaments, both assisting to form the radio-carpal articulation. In the Elephant, the arrangement of these bones is very curious and perhaps unique: the upper head of the radius is firmly fixed between two projections in front of the head of the ulna, and assists in forming the elbow-joint articulating with the outer condyle of the humerus only. It then passes obliquely downwards across the anterior face of the ulna to its distal extremity, where it expands into a broad articulating surface, and assists almost coequally with the ulna in forming the carpal joint.

Carpus.—The bones of the carpus are chiefly remarkable for their large dimensions; they are, however, always distinct and generally the same in number as in Man, although from their altered shape they little conform to the names bestowed upon them in the human subject. The first row, consisting of the analogues of the scaphoid, the lunar, the cuneiform, and the pisiform bones, is firmly connected by ligaments with the distal extremities of the ulna and radius to form the wrist-joint, which, however, is here only capable of the movements of flexion and extension. The second row consists of the representatives of the trapezium; the trapezoid, the os magnum, and the unciform bones support the metacarpus and are generally quite distinct, although occasionally two or more of them are consolidated into one mass.

In the Rhinoceros, which has but three toes, the trapezoid, the os magnum, and the unciform

bones each support a single metacarpal bone. The trapezium is totally wanting, but there are two supernumerary pieces in connection with the scaphoid and unciforme.

Metacarpus.—The metacarpal bones are generally short and excessively robust, their number of course corresponding with that of the toes. Thus in the Elephant there are five, and in the Hippopotamus, Hog, and Tapir only four, which are small and extremely massive in proportion to the weight they have to sustain. In the genus *Sus*, where the whole burden of progression is thrown upon the two middle toes, and a considerable degree of activity is permitted, the corresponding metacarpal bones are much elongated, and far surpass in size and strength those which support the external and internal fingers, which have rather the appearance of appendages to the outer and inner sides of the metacarpus, than bones articulated with the carpal series.

The metacarpus in the Rhinoceros consists of only three bones conformable to the number of fingers.

Phalanges.—The Elephant alone of all the Pachydermata has five complete fingers; but, although the bones are thus perfectly developed, they are so concealed in the living animal by the hoof and overhanging skin of the fore-foot, that such a condition of this part of their skeleton would hardly be suspected.

In the ungulate tribes, which have only four fully formed fingers, there is still a little bone representing the rudiment of a thumb, although in the generality of artificial skeletons this ossicle is wanting. In the *Suidæ* the two lateral fingers are much shorter than the two middle ones, so that in walking the former do not touch the ground at all; they are, however, quite complete as relates to the number of their phalanges; and the last phalanges of all the

toes are moreover moulded to the shape of the horny roof which covers them, a circumstance in which they differ remarkably from the larger genera.

Pelvis.—The pelvis of the larger genera are of enormous size, accommodating themselves in this respect partly to the prodigious masses of muscle to which they give origin, and partly to the monstrous capacity of the abdominal cavity. In the *Elephant* and *Rhinoceros* the ossa ilii are very broad, rounded anteriorly and concave towards the abdomen. In the Tapir, the ilium has somewhat the form of the letter T, one branch being articulated with the sternum, while the neck of the bone forms the handle. The pelvis of the Hog very nearly approximates in shape that of carnivorous quadrupeds.

Femur.—The femur of the *Elephant* (fig. 464) is remarkable for the simplicity of its shape, which has some resemblance to that of the human skeleton, owing to its general smoothness and the absence of those strong crests and ridges which characterise it in most other gigantic quadrupeds. In all other tribes of the Pachyderms these bones are short, straight, and flattened in the middle, presenting upon the outer border a wide and prominent ridge terminating inferiorly in a hook-like process, which, as well as the trochanter major, is in the case of the *Rhinoceros* excessively prolonged.

Tarsus.—The bones of the tarsus are similar both in number and arrangement to those of the human skeleton. The *astragalus* is of great size, and all its articulating surfaces very extensive so as to afford a wide basis of support. The *calcaneum* is likewise remarkably prominent and massive.

Metatarsus.—The metatarsus is in the *Elephant* made up of five distinct bones, of which, however, the external one is but imperfectly developed. In all the other Pachydermatous genera there are only four metatarsal bones corresponding with the number of the toes. Of these the two central ones are far the largest,

and sustain alone the entire weight of the hinder part of the body, seeing that the most external and most internal toe of each foot scarcely reaches the ground; and at length in the *Suida* the metatarsal bones of these toes become reduced to mere rudiments appended to the sides of the foot, and serve less as organs of support than as appendages given to prevent the creatures so organized from sinking into the marshy soils or soft mud, which they mostly frequent as though to testify the intermediate position which they occupy between the aquatic and terrestrial Mammalia.

Phalanges.—The number of toes upon the hind foot of the *Elephant* is five, each of them, with the exception of the outer one, consisting of three short and massive phalanges; but the external toe is represented by a single massive and irregular-shaped piece. In the living animal all these bones are so encased in the thick skin covering the sole, that the division of the foot is only indicated by the prominent extremities of the toes.

The skeleton of the *Elephant* is, indeed, quite peculiar in form, so that there is not a single bone or extremity of a bone which may not easily be distinguished from that of any other animal; and it may likewise be remarked that many of the bones of the *Elephant* more nearly resemble those of the human species than the analogous ones of any other quadruped, especially of the larger inhabitants of this part of the world, such as oxen or horses. As examples of this, may be pointed out the atlas, all the cervical vertebræ, and the bodies of the dorsal vertebræ; the scapula and pelvis on account of their great breadth, the femur from its length and the simplicity of its shape, the astragalus, the os calcis, and all the bones of the metacarpus and metatarsus. It is, therefore, scarcely to be wondered at that even professed anatomists, who had never examined the skeleton of the *Elephant*, have sometimes mistaken the bones of this animal for the fossil remains of human beings, and consequently of giants.

Fig. 476.

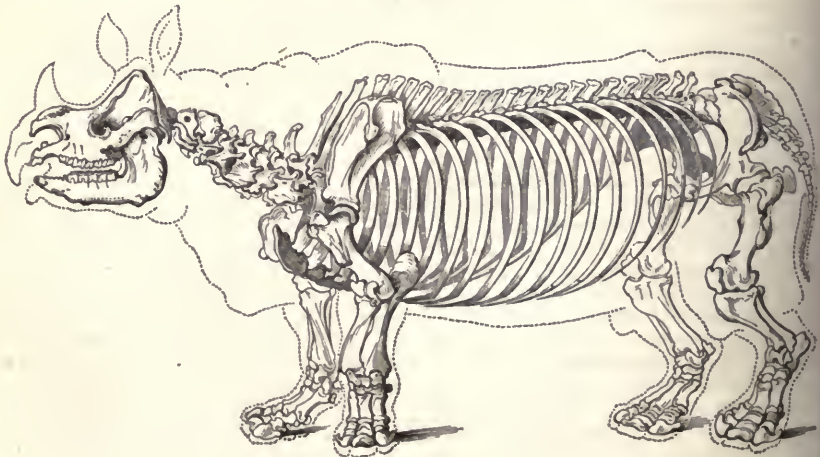

Skeleton of *Rhinoceros*.

In the *Hippopotamus*, the *Rhinoceros*, and the *Tapir*, the separation of the toes is more apparent externally, but still the phalanges, which are three in number to each of the four toes, are excessively strong and bulky when compared with their length. A kind of gradation is likewise to be traced through these genera, whereby the foot of the Elephant becomes gradually transformed into the cloven hoof of the hog tribe, owing to the progressive diminution in size of the inner and outer toes, and the gradual conversion of the terminal phalanges of the central toes into that prismatic form which adapts them to fit the horny envelopes that encase them like shoes.

Throughout all the hog genera the weight of the body is entirely supported on the two central digits, the bones whereof are proportionally strong and well developed, while the phalanges of the inner and of the outer toe, which do not touch the ground, remain permanently of very rudimentary size.

Teeth.—In no order of Mammiferous animals do the teeth present so much diversity of structure and irregularity of disposition as among the Pachydermatous races; it will be therefore necessary, in adverting to this part of their economy, to describe the principal modifications which the dental organs assume in different genera, before we proceed to investigate the manner of their formation; and this we do more willingly, because from the character and arrangement of the teeth we can alone satisfactorily determine what have been the habits of extinct genera, the list of which is already considerably more extensive than that of living forms. Professor Owen, to whose labours in this department science is already so deeply indebted, has in his recent work on the Comparative Anatomy of the Teeth* examined this part of our subject with all the minuteness required for geological researches, and from his kindness we are enabled to lay the following abstract before our readers.

In the genus *Sus*, the wild progenitor of our domestic breeds of Hogs, *Sus scrofa*, the complete set consists of forty-four teeth, viz.—

Incisor.	Canine.	Premolar.	Molar.
5.3	1.1	4.4	3.3
3.3	1.1	4.4	3.3

In the wild Boar both the upper and lower canines curve forwards, outwards, and upwards; their sockets inclining in the same direction, and being strengthened above by a ridge of bone which is sometimes extraordinarily developed, these teeth become converted into most formidable weapons. These teeth, which have the character of true tusks, are three-sided; the broadest convex side being directed obliquely inwards and forwards, while the outer and posterior sides are nearly flat; and the hinder surface being destitute of any covering of enamel; whilst the two other sides are encased with that material, the tusk wears obliquely from behind upwards and forwards to point, while its posterior margins present

enamel edges that are always sharp and trenchant. Each of these tusks in the lower jaw

Fig. 477.

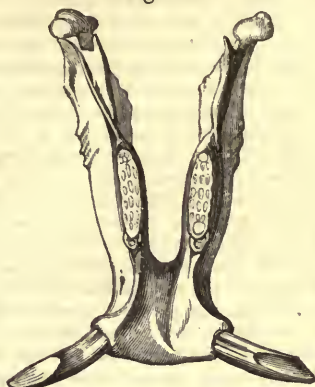

of the German wild Boar will measure eight inches in length along its curve, and in the wild Boars of Assam they have been noticed measuring one foot, so that when wielded by such strong and brawny muscles as those of a Hog's neck, it is easy to conceive that terrific wounds may be inflicted by such instruments.

In the Baberoussa or "Horned Hog" the development of the canines is still more extraordinary. Those of the upper jaw seem as if their sockets had been pulled out or produced from the alveolar border of the upper maxillary bone, and then abruptly bent upwards, giving the tooth a direction upwards and backwards. The tooth pierces the integument of the upper lip like a horn, and its growth being unchecked by any opposing tooth, sometimes forces the lip again through the integument and into the substance of the skull. The lower tusks have the ordinary direction, but rise rather more vertically and much higher than in the wild Boar. These strangely situated teeth are well adapted by their position to defend the eyes and assist in the act of forcing the head through the dense entangled underwood of a tropical forest, as suggested in Home's Comparative Anatomy, vol. i, p. 221, but their use has not been determined by actual observation.

In the next group of Pachydermata (*Charopotamide*) the dental formula of the existing type of the family Dicotyles, the *Peccari*, is as follows.

Incis.	Canine.	Premolar.	Molar.
2.2	1.1	3.3	3.3
3.3	1.1	3.3	3.3

The upper canines are moderately long, narrow, and compressed, with an entire covering of enamel; while the lower are long, slightly curved, and have no enamel posteriorly. To this type of dentition belonged the *Hyracotherium* and the *Charopotamus*, both extinct genera, the former having been about half the size of the existing *Peccari*, while the latter was about one-third larger. The *Hippophyus*, likewise an extinct genus, found in the Himalayan

* Odontography, Bailliere, 8vo. 1845.

tertiary deposits, and of about the size of the *Chæropotamus*, appertained to the same family.

A third kind of dentition characterizes the *Hippopotamidæ*, in which the tendency to excessive and, as it may be termed, monstrous development of the canine teeth, for which the typical *Suidæ* are remarkable, affects both the canines and the incisors. Of this group the only existing representative is the *Hippopotamus* of the great rivers of Africa. In the *Hippopotamidæ* the implanted base of each of the incisive and canine teeth is simple and excavated for a large persistent matrix, which causes their perennial growth by constantly adding materials at the base of each to replace what is worn from their abraded extremities. The direction of the abraded surfaces is in part provided for by the partial disposition of the enamel; in the upper median incisor this is laid upon the fore and outer part of the tooth, while in the lateral incisor there is a narrow strip of enamel along the convex side of the tooth. The enamel is soon worn away from the crowns of the lower incisors, but it is persistent in the canines, where it extends to the end of the implanted base; in the upper canine being laid upon the posterior and outer, but not on the fore part, whilst its position is reversed upon the inferior canine.

The extinct genera of *Hippopotamoid* Pachyderms at present discovered are the *Hexaprotadon*, the *Merycopotamus*, and the *Anthracotheurium*.

Perhaps one of the most singular forms of the dental apparatus hitherto met with among Pachydermal Quadrupeds is that of the *Toxodon*, a large extinct genus, represented by two species both equalling the *Hippopotamus* in size, whose remains have been discovered by Mr. Darwin and M. de Angelis in the recent tertiary deposits of South America. The teeth of the *Toxodon* consisted of molars and incisors, separated by a long diastema or toothless space. In the upper jaw the molars were fourteen in number, seven on each side, and the incisors four, which latter differ in their proportions in the two species. In the lower jaw there were six incisors and *twelve* molars.

All the molar teeth are long and curved and without fangs, as in the *Wombat* and most of the herbivorous species of the Rodent order: in existing races, however, with curved grinders, as the *Aperea* or Guinea-pig, the concavity of the upper grinders is directed outwards, the fangs of the teeth of the opposite sides diverging as they ascend in the sockets; but in the *Toxodon* the convexity of the upper grinders is outwards, as in the *Horse*, but with so much greater curvature that the fangs converge and almost meet at the middle line of the palate, forming a series of arches capable of resisting great pressure. It was this structure which suggested to Professor Owen the generic term conferred by him upon this most remarkable extinct Mammal.*

Of the upper incisors there are two small ones situated in the middle of the front of the intermaxillaries, and exterior to these two large

ones, in close contiguity with the small incisors, which they greatly exceed in size.

The sockets of the two large incisors extend backwards in an arched form, preserving an uniform diameter, as far as the commencement of the alveoli of the molar teeth; the curve which they describe is the segment of a circle, the position, form, and extent of the sockets being such as are only found in those of the corresponding teeth of the *Rodentia* among existing *Mammalia*; and it may likewise be inferred that the pulp which formed them was persistent, and that the growth of those incisors, like those of the *Rodentia*, continued throughout life. The six lower incisors were all of nearly equal size, hollow at their bases, and partially coated with enamel, like the "dentes scalprarii" of the *Rodentia*; they differed, however, from these in having a prismatic figure, like the incisor teeth of the *Sumatran Rhinoceros*, or the tusks of the *Boar*. That they were opposed to teeth of a corresponding structure in the upper jaw is proved by their oblique chisel-like cutting edge.

The name of *Elasmotherium* has been given to an extinct Pachyderm with fangless molars, surpassing the *Toxodon* in size, and of which only the lower jaw and its dentition is yet known; but the characters of the teeth are sufficiently remarkable, owing to the beautiful undulating folds into which the enamel is thrown, a circumstance from which the name of the genus is derived.* The original jaw, preserved in the Museum of Moscow, is unique, and was discovered in the frozen drift or diluvium of Siberia.

In the *Rhinocerotidæ*, including the typical *Rhinoceros*, the extinct *Acerotherium*, which had no horn, and the equally hornless small existing genus *Hyrax*, the molar teeth are implanted by distinct roots. There are no canines; and as to the incisors the species vary, not only in regard to their form and proportions, but also their existence, and in the varieties of these teeth we may discern the same inverse relation to the development of the horns which is manifested by the canines of the *Ruminants*. Thus the two-horned *Rhinoceroses* of Africa, which are remarkable for the great length of one or both of the nasal weapons, have no incisors in their adult dentition, neither had that great extinct two-horned species (*Rh. tichorinus*), the prodigious development of whose horns is indicated by the singular modifications of the vomerine, nasal, and intermaxillary bones in relation to the firm support of those weapons. The *Sumatran bicorn Rhinoceros* combines with comparatively small horns moderately developed incisors in both jaws, and the same teeth are present in the nearly allied two-horned *Rhinoceros* called after its discoverer *Schleiermacher*.

The incisors are well developed in both the existing unicorn *Rhinoceroses*, *Rh. Indicus* and *Rh. Sondaicus*, but they attain their largest dimensions in the singular extinct hornless species, the *Rh. incisivus* of Cuvier. In the

* Τοξον, arcus; ὀδόν, dens.

* Ἐλασμα, a plate; θηρίον, a beast.

adult *Rhinoceros* no traces of canine teeth are visible, but Professor Owen succeeded in detecting their existence in a rudimentary condition in the mature fœtus of the *Rhinoceros Indicus*, although both the teeth and their sockets disappear at a very early age.

The vast hiatus which in the series of existing Mammals divides the *Rhinoceros* from the *Tapir*, and this from the *Elephant*, was once filled up by interesting transitional species, which have long become extinct, such as the *Paleotherium* and the *Macrauchenia*, the *Lophicdon*, *Coryphodon*, and others requiring no particular notice in this place. But that most extraordinary of extinct Pachyderms, the *Dinotherium*, must not be so lightly passed over, inasmuch as its dentition appears to have been quite unique in character, as may be seen on reference to *fig. 478*, which represents the lower jaw of this gigantic quadruped. From this it will be seen that the molar and premolar teeth resemble in some respects those of the *Mastodon*; but the great peculiarity of the *Dinotherium* exists in its tusks projecting from the lower jaw. These tusks are two in number, implanted in the prolonged and deflected symphysis of the lower jaw, in close contiguity with each other, and having their exerted crown directed downwards and bent backwards,

while their deeply implanted base is excavated by a wide and deep conical pulp cavity, like the tusks of the *Mastodon* and *Elephant*. No such tusks nor germs of such have yet been discovered in the upper jaw, so that it is highly probable that this gigantic Pachyderm was of aquatic habits, like the *Hippopotamus*, and that its tusks served to detach and tear up by the roots the aquatic plants upon which it fed, as well as for weapons of defence or combat.

No family of Mammalian Quadrupeds has suffered more from the destructive operations of time than that of the Proboscidian Pachydermata. Two species only, the *Indian* and the *African Elephants*, continue to represent this type in the Mammalian series of the present day; whilst those that manifested the modifications of the dental system which gradually reduce the complexity of the Elephantine dentition to the comparative simplicity of that of the *Dinother* and *Tapir*, have long since been blotted out of the series of living beings. Of these the gigantic *Mastodons* are the most conspicuous — animals nearly allied to the existing *Elephants*, but differing from them in the construction of the grinding surfaces of their molar teeth, which had their crowns studded with conical eminences more or less resembling the teats of a cow—whence the

Fig. 478.

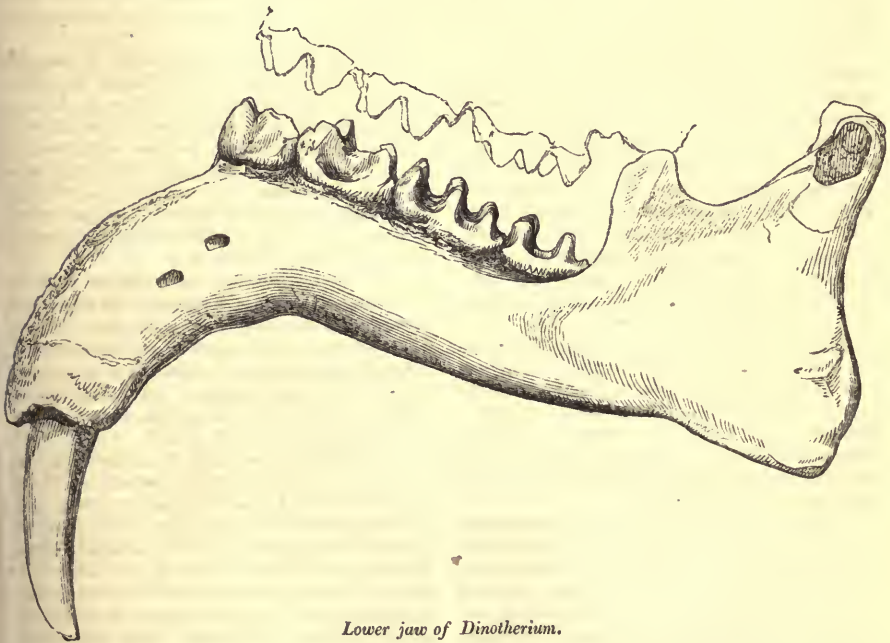

Lower jaw of Dinotherium.

generic name is derived.* In addition to these grinding teeth the *Mastodons* were provided with two enormous tusks, resembling those of the *Elephant*, implanted into the intermaxillary bones of the upper jaw; and moreover those *Mastodons* with the more simple and typical

molar teeth likewise manifest the *Dinotherian* character in having tusks in the lower jaw of the adult male and in the young of both sexes.

The dentition of the *Elephant*, the sole surviving genus of the great Proboscidian family, consists of two long tusks, one situated in each of the intermaxillary bones, and of large and complex molars in both jaws. Of the

* *Μαστίς*, a nipple; *ὀδὸς*, a tooth.

latter there is never more than one wholly, or two partially in place and use on each side at any given time; for like the molars of the Mastodons, the series is continually in progress of formation and destruction, of shedding and replacement, and in the Elephants all the grinders succeed one another horizontally, from behind forwards, none being displaced and replaced by vertical successors or premolars.

The total number of teeth developed in the Elephant Professor Owen believes to be

$$\begin{array}{r} 2 \cdot 2 \\ \text{Incis.} \quad \text{---} \\ 0 \cdot 0 \end{array} \begin{array}{r} 6 \cdot 6 \\ \text{Molars} \quad \text{---} \\ 6 \cdot 6 \end{array} = 28,$$

the two large permanent tusks being preceded by two small deciduous ones, and the number of molar teeth which follow each other being at least six; but Mons. Corse was of opinion that this replacement of teeth is repeated at least eight times in the Indian Elephant, which would consequently have thirty-two teeth successively taking their respective places in the jaws.

The deciduous tusk makes its appearance beyond the gum between the fifth and seventh month; it rarely exceeds two inches in length, and is about a third of an inch in diameter at its thickest part, where it protrudes from the socket; the fang is solidified, and contracts to its termination, which is commonly a little bent and is considerably absorbed by the time the tooth is shed, which takes place between the first and second year.

The socket of the permanent tusk in a newborn Elephant is a round cell about three lines in diameter, situated on the inner and posterior side of the aperture of the temporary socket. The permanent tusks cut the gum when about an inch in length, a month or two usually after the milk teeth are shed. The widely-open base of the tusk is fixed upon a conical pulp, which, with the capsule surrounding the base, progressively increases in size, stimulates a concomitant increase in the capacity and depth of the socket, which cavity soon obliterates that of the deciduous tusk.

These incisive teeth of the Elephant not only surpass other teeth in size, as belonging to a quadruped so enormous, but they are the largest of all teeth in proportion to the size of the body, representing in a natural state those monstrous incisors of Rodents which are the result of accidental suppression of the wearing force of the opposite teeth.

The molar teeth of the Elephant are remarkable for their great size, even in relation to the bulk of the animal, and for the extreme complexity of their structure. The crown, of which a great proportion is buried in the socket, and very little more than the grinding surface appears above the gum, is deeply divided into a number of transverse perpendicular plates, consisting each of a body of dentine, coated by a layer of enamel, and this by a less dense bone-like substance which fills the interspaces of the enamelled plates, and here more especially merits the name of cement, since it binds together the several divisions of the tooth before they are fully formed and united by the

confluence of their bases into a common body of dentine.

The manner in which these complex teeth are formed is a subject of great interest, and has been ably investigated by many celebrated anatomists, particularly by the two *Campers*, father and son, M. Corse, Robert Blake, and John Hunter, whose splendid preparations illustrative of the process are contained in the Museum of the Royal College of Surgeons in London. It is to Cuvier, however, we are indebted for the most complete and luminous exposition of this important piece of physiology, as may be gathered from the following account extracted from his great work, "*Recherches sur les Ossements Fossiles.*" "The molar tooth of the Elephant, like every other mammiferous tooth, is formed in the interior of a membranous sac, now generally called the *capsule* of the tooth. This capsule has in the Elephant a rhomboidal form, and is closed on all sides, excepting the small openings for the passage of nerves and vessels. It is lodged in a bony cavity of the same shape as itself, excavated in the maxillary bone, which afterwards forms the socket of the tooth."

"It is, however, only the external lamina of the capsule which is thus simple in its arrangement, the inner lamina being, as in all other herbivorous animals, thrown into numerous folds, as will be understood when we have described the pulp upon which the tooth is formed."

"This pulp has in every animal its peculiar arrangement. To represent that of the Elephant, we must imagine that from the bottom of the capsule as from a base, there arise numerous parallel and transverse walls which mount upwards towards that part of the capsule which is placed next to the gums. These little walls are only adherent to the floor of the capsule, their opposite extremity or summit being free from all adherence."

"The free summit is much thinner than the base, so that it might be called the edge, and is moreover deeply cleft in many parts, so as to form numerous sharp points and indentations. The substance of these little walls is soft, transparent, and very vascular, containing apparently much gelatine: it becomes hard, white, and opaque in spirits of wine."

"It will be now easy to understand the manner in which the inner membrane of the capsule is folded, if we imagine it to form prolongations which penetrate into all the intervals between the little walls above described. These prolongations adhere to the upper part of the capsule, that is, to the side of it which is nearest the gums, and also to its lateral parietes, but are not adherent to its base, from whence the little gelatinous walls above described arise. Consequently it is easy to understand that there may be a continuous cavity amazingly folded upon itself, extending between all the gelatinous walls (which are descending in the upper teeth, ascending in the lower teeth) and these membranous partitions (ascending in the upper teeth, descending in the lower teeth.)"

"It is in this conceivable cavity that the ma-

terials will be deposited to form the teeth, viz. the *bone* or *ivory* (*dentine*) which will be formed by the gelatinous processes coming from the bottom of the capsule, and the *enamel*, which will be deposited by the membranous septa, and by the general internal surface of the capsule and its prolongations, the base only excepted."

There is, however, according to Cuvier, a very delicate membrane interposed between the ivory and the enamel, which, previous to the deposit of the ivory, immediately infolds the ivory pulp wall, and invests it very closely; but as the ivory pulp transudes the ivory, it is pushed inwards, and separated from this membrane, which then forms a covering common both to the ivory and to the pulp that secretes it.

On the other side the *enamel* is deposited upon the exterior of this membrane by the surface of the prolongations of the internal lamina of the capsule, and by its pressure upon the ivory obliterates the intervening membrane, so that the latter soon becomes imperceptible in the newly formed tooth, or its place is only indicated when a section is made, by a fine greyish line which separates the enamel from the ivory. It is, however, evident that this thin membrane is the only bond of union between the two substances as they become indurated at the bottom of the capsule, for without it they would indubitably separate from each other.

The ivory and the enamel are therefore conjoined by a kind of juxta-position. The former is deposited by layers advancing from without to within, the internal layer being that last formed and also of greatest extent, exactly as in the growth of shells; and as its deposition commences at the most prominent points of the gelatinous, ivory-forming pulp of the tooth, it is at these points that the ivory-forming substance is thickest, and goes on becoming thinner as it recedes from them.

If, therefore, we bring our thoughts to bear upon the epoch when the deposition of ivory commences, it is easy to conceive how there is first formed a little crust of ivory upon each of the prominent points of the indented margins of the ivory pulp, and as new layers are continually within each other, the little crusts are changed into conical caps; when the newly deposited internal layers have descended as far as the bottoms of these indentations, all the caps become united into a single transverse piece; and lastly, when the deposition of ivory has proceeded as far as the bases of the ivory pulps, all the transverse plates will become united into a single crown of a tooth, which would present the same eminences and the same depressions as were conspicuous in the pulp which formed it, if in the mean time other substances had not been in progress of deposition, and partially filled up the intervals between them.

The *enamel* is deposited upon the external surface of the ivory by the internal membrane of the capsule, under the form of little fibres, or rather of minute crystals, all disposed perpendicularly to that surface, so as to form,

during the earlier periods of its deposition, a kind of velvet with a very fine pile. When a capsule of a young tooth is opened, the little molecules of the future enamel are in fact easily perceived adhering to the inner surface of the capsule, from which they are easily detached. Some are even seen floating in the fluid that intervenes between the capsule and the germ of the tooth. The opinion of Hunter that the enamel is only a sediment deposited from the fluid interposed between the capsule and the tooth is inexact, inasmuch as he does not attach sufficient importance to the functions of the capsular membrane, from which in reality the molecules of enamel proceed; nevertheless, it is very true that these molecules are originally situated between this membrane and the tooth before they become attached to the latter. But to proceed.

A thick layer of enamel being thus deposited around the ivory forming the crown of the tooth, partially fills up the intervals by which the transverse plates and their indentations were formerly separated. The remainder of these interspaces now remains to be filled up, which is effected by the formation of a third substance, called the *cementum* or *crusta petrosa*. This superadded material, which is very different in its characters from either of the others, is formed by the same membrane and the same surface as formerly produced the enamel. The proof of this is, that the membrane in question always remains external to the *cementum*, in precisely the same relation to it which it previously had to the enamel, and that it continues soft and free as long as the deposition of the *cementum* leaves room for it. The only change perceptible is in its texture. Whilst it continued to secrete enamel, it was thin and transparent; but when it begins to secrete *cementum*, it becomes thick, spongy, opaque, and of a reddish colour.

The membranous prolongations of the capsule of the tooth are retracted towards the top and towards the sides of the cavity, in proportion as the *cementum* which they deposit fills up the spaces between the different lamina of the tooth. The summits even of the laminae are covered with *cementum* before the tooth begins to be worn. Sometimes, indeed, the same prolongation of the capsule is secreting *cementum* near around the top of a lamina, whilst it is forming *enamel* lower down. From the same cause, the upper portion of the interspaces is already filled up with *cementum*, while the lower parts remain separate, under which circumstances the lower portion of the capsular prolongation becomes separated from the upper, and only receives its nourishment through its lateral adhesions to the capsule.

The deposit of enamel commences almost at the same time as the formation of the ivory, and the secretion of the *cementum* speedily follows; so that the summit of each lamina has all the three substances belonging to it completely formed long before its base and contiguous laminae are soldered together by their upper portions, even before their bases are completed. We may likewise add that all

these different operations are by no means equally in progress in all points of the tooth at the same time, but they occur much earlier in front than behind; so that the anterior laminae may be already consolidated by their summits and even by their bases while the bases of the middle ones remain separate, and when the posterior laminae are not even formed, or only represented by the patches of ivory that are first deposited upon the apices of the pulps.

There was formerly much discussion as to the number of grinding teeth proper to the Elephant, and as early as 1715 the Royal Society of London observed that there is sometimes only one and sometimes two on each side in either jaw, and moreover that the first tooth is longer or shorter in proportion to the second in different individuals. Pallas first explained the real mode of the succession of these teeth, accounting for all these irregularities, and showing that the Elephant has at first only a single tooth on each side, until a second, developing itself, replaces the first, so that during a certain period there are two, until the shedding of the first again leaves only one. Cuvier first announced that this succession and consequent alternate change in the number of the teeth was repeated more than once, because he found the detached germs of a third grinder in the jaw of an Elephant, with two teeth in situ.

It thus becomes easy to understand how the grinding teeth of the Elephant, notwithstanding the enormous wear to which they are perpetually subject, are kept constantly ready for use, and renovated in front as fast as they are worn away behind. No sooner has the body of the first-formed tooth pierced the gums than it begins to undergo important changes. As the Elephant is herbivorous, its teeth are necessarily worn away by mastication like the teeth of all other herbivorous animals, a circumstance which is indeed necessary in order that the grinding surface may be constantly kept in a condition to bruise vegetable substances. The little indentations on the tops of the laminae are first worn off, until the wearing down has reached the interior of the tooth, when each denticle of course presents an oval disc of ivory, surrounded by a ring of enamel and enclosed in the cementum, three substances, which, being of very different degrees of hardness, are ground away unequally, so as always to present a rough grinding surface like that of a mill-stone.

The tooth, moreover, by its rhomboidal figure and very oblique position in the jaw, presents its anterior portion above the gums long before the posterior, so that the surface produced by mastication forms an obtuse angle with the plane of the upper surface of the tooth: hence it happens that when the front of the tooth is deeply worn away, the middle laminae are scarcely used at all, and the hinder ones remain quite intact, presenting the summits of the indentations of their crowns under the form of little round eminences. In the same way the anterior denticles are altogether destroyed before the posterior are very far worn down, a circumstance which explains another phenomenon

which is peculiar to the Elephant, viz. that its teeth diminish in length at the same time that they are worn away in depth.

Whilst the exposed part of the tooth is thus worn away, that part of the root which corresponds with the portion ground down is removed by a very different process. When examined under these circumstances, the roots of the anterior denticles have the appearance of being eaten away as by a kind of caries, so that all the front of the tooth is thus removed when the grinding surface has ceased to be efficient, and the tooth, when about to be shed, is reduced to a very small size, however large it might have been originally.

The tooth which is in use is therefore perpetually moving forward in consequence of this process, and making room for that which is in progress of formation in the hinder part of the jaw to succeed it. This latter, in turn, by its development assists in pushing the first forwards, so that it is strictly true that in the Elephant the second set of teeth grows *behind* the milk set, instead of above or below them, as in other animals (*fig. 479*).

Fig. 479.



The tusks of the Elephant are very different in their structure from the molar teeth, consisting of two substances only, the *ivory* and the *enamel*. These tusks grow during the whole life of the animal, and sometimes attain enormous dimensions, measuring eight or nine feet in length, and weighing upwards of two hundred pounds. In the females of the Asiatic Elephant the tusks are very small, but in the African Elephant both sexes have these defences largely developed. These remarkable teeth, which are evidently the representatives of the enormous tusks bestowed on some of the Cetacea, such for example as the Narwal (*Monodon*), are implanted in enormous sockets formed by the intermaxillary bones of the upper jaw. The central portion of each tusk, the *ivory*, which forms by far the greatest portion of the tooth, is secreted by an enormous pulp lodged in a deep cavity which is excavated in its root, from the surface of which it is deposited layer by layer in successive strata. The pulp or nucleus from which the mass of the tooth is thus formed has not the slightest organic connection with the ivory which has been the product of its secretion; not a fibre or vessel, or even the slightest cellulosity passing from one to the other. The tusk is therefore only kept in its socket by the tight embrace of the parts around it, and its direction may be readily changed by gentle and continued pressure, in the same way as dentists succeed in changing

he direction of the single-fanged teeth of their patients by the application of wires.

Digestive System.—The digestive apparatus is enormously developed in all the animals belonging to this order, being in this respect not only adapted to the quantity of materials consumed for the support of their unwieldy bodies, but likewise in accordance with the strictly vegetable nature of the aliment upon which they feed, which, compared with animal substances, is necessarily bulky and innutritious. We select a few examples.

The stomach of the Elephant is simple, but in shape it is much more elongated than in the human subject. Its cardiac extremity is prolonged into a pouch of considerable size, the lining membrane of which is gathered into thirteen or fourteen large valvular folds, which, from their great size, seem to form so many broad valves. The muscular tunic of this pouch and around the cardia is remarkably thick, and its contents such as to indicate some analogy between this portion of the stomach and the *abomasus* or fourth stomach of ruminating quadrupeds.

The small intestines are very voluminous, and the colon and cæcum of enormous dimensions, presenting longitudinal tendinous bands and wide pouches as in the human subject. The following table will serve to shew the prodigious extent of the intestinal canal of an Elephant seventeen years of age, and only seven feet and a half in height.

	ft.	in.
Length of the small intestines from the pylorus to the cæcum	38	0
Circumference of ditto	2	0
Length of cæcum	1	6
Circumference of cæcum	5	0
Circumference of colon	6	0
Length of colon and rectum together	20	0
Total length of intestinal canal, exclusive of the cæcum	58	6

The *liver* requires no special notice, but the arrangement of the biliary ducts of the Elephant is very remarkable; and various opinions are recorded by the older anatomists as to whether the Elephant did or did not possess a gall-bladder, most of them denying its existence, while others mistook enlargements of the biliary canals for a true *vesiculum felleis*.

The gall-bladder of the Elephant (*fig. 480*) is, in fact, situated between the coats of the *duodenum* itself, (*b, c, e, p,*) quite at the termination of the biliary duct which comes immediately from the liver. It consists of a great oval pouch divided by transverse valves or septa into four compartments (*n, o*). The fundus and walls of this pouch are studded with glandular granules; the bile enters it at one extremity from the hepatic duct, (*f, g,*) and at the opposite end passes into the interior of the intestine (*a, d, e, c*) through a mamillary projection, situated upwards of two feet from the pylorus, through the orifice of which the point of a probe (*g, r*) is represented as protruding. The arrangement of the pancreatic conduits is likewise remarkable. The pancreas

Fig. 480

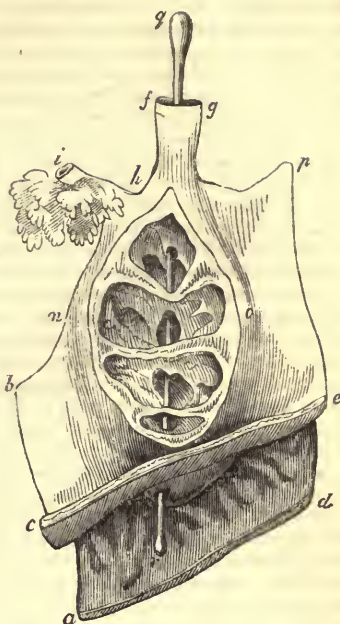

consists of a loose arrangement of glandular masses not very closely connected with each other, from which separate ducts are given off, which terminate in a common canal. This latter, however, soon divides into two branches, one of which pours the secretion which it conveys into the upper compartment of the biliary pouch, where it is mixed up with the bile therein contained preparatory to its introduction into the intestine, while the other branch of the pancreatic duct opens into the duodenum itself, about two inches lower down, so that at the orifice bile mixed with the pancreatic secretion enters the duodenum, while from the lower aperture the fluid received is pure pancreatic juice.

The *spleen* of Pachydermatous animals differs in no noticeable respect from that of other quadrupeds. In the Elephant it measures four feet in length, yet even this is thought small when compared with the gigantic size of the animal.

The stomach of the Hippopotamus, or, at all events, of a fetal Hippopotamus dissected by Daubenton, presents a very remarkable conformation. Externally it appeared to be composed of three parts; the principal portion, extending from the cardiac extremity to the pylorus, was much elongated, resembling more a portion of intestine than an ordinary stomachal receptacle. Besides this central part, extending from the œsophagus to the pyloric valve, were two long appendages like two cæcums, one arising on the right side of the œsophagus and running along the exterior of the stomach throughout almost its entire length, and then folding backwards, the other and shorter cul de

sac issuing from the posterior aspect of the cardiac extremity of the stomach and projecting towards the right side. The construction of the interior of this stomach is still more extraordinary than its external appearance, for it is so divided by septa, that food coming into this viscus through the œsophagus may pass by different channels, either into the central portion, which seems properly entitled to the name of stomach, or into either of the great diverticula appended to it. The inferior walls of the central stomach have nine or ten cavities in them, something like those of the Camel and Dromedary. The lining membrane both of the stomach and diverticula is granular and wrinkled except near the pylorus, where the parietes become smooth and folded into numerous plicæ somewhat resembling those of the third stomach of a ruminant, although there is no probability that rumination occurs in the animal under consideration.

In the *hog tribe* the proportionate dimensions of the alimentary canal are very great when compared with the size of the animal's body, the large and small intestines of the Hog or wild Boar measuring together from sixty to sixty-five feet in length, the large intestines alone being in the wild Boar thirteen and in the domestic Hog fifteen feet long. The stomach is capacious, the entrance of the œsophagus being situated nearly in the centre of its lesser curvature, so that the cardiac *cul de sac* is exceedingly large, and is moreover prolonged into a kind of cowl-shaped appendage, which gives it a very peculiar aspect. On opening the stomach the epithelium of the œsophagus is found to be prolonged for some distance into its interior, where it covers a square space of considerable extent, the borders of which are well defined. At the entrance to the pylorus there is a large nipple-shaped projection upwards of an inch in length in the full-grown animal; and moreover, however much the stomach may be distended, there always remains a deep fold crossing it at its upper part, between the œsophagus and the pylorus, and another equally extensive bounding the commencement of the great cardiac *cul de sac*, these folds evidently indicating a relationship with the more complex stomachs met with in ruminating animals, especially as the lining membrane only assumes a villous aspect in the pyloric region of the viscus.

The *liver* consists of four lobes, and there is a distinct gall-bladder, either lodged in a deep fissure, or imbedded in the substance of the middle lobe. The *spleen* is long, flat, and somewhat of a prismatic shape, and the pancreas consists of three portions, which unite near the pylorus.

The *Hyrax Capensis* has a stomach which to a certain extent reminds the anatomist of the complex condition of that viscus met with in many animals nearly related to the Pachydermata. The cardiac extremity is large, and forms a capacious cavity, which is divided by a deep constriction from a second compartment of smaller dimensions, which opens into the pyloric portion of the organ. The whole viscus is moreover so bent upon itself owing to the

smallness of the lesser curvature, that the pyloric and cardiac extremities are almost in contact with each other. The cœcum is likewise proportionably of enormous size, being larger than the stomach itself, and from this a spirally folded intestine of no very great calibre runs to a kind of second cœcum of large capacity, which has its commencement prolonged upwards by means of two conical appendages like horns, whence it has been named by Pallas *intestinum bicornæ*, and this last, after becoming considerably diminished in size, terminates in the rectum.

Salivary glands.—The salivary organs are very large. In the Hog there are two sublingual glands; one, which is very long and narrow, accompanies the duct of the maxillary gland, and is composed of small lobes of a pale reddish colour; the orifice of its excretory duct is near that of the maxillary. The second sublingual gland is placed in front of the former, and is of a square form; it discharges its secretion through eight or ten short ducts, which pierce the mucous membrane of the mouth. The parotid is large, its duct opening opposite the third molar tooth; and in addition to these there are the molar glands, which form two elongated masses, situated along the alveoli of the superior and inferior molar teeth, and extending forward as far as the canines; these pour their secretion into the mouth through numerous little orifices.

Os hyoides.—The os hyoides in the Elephant has its body or central portion, which resembles a flattened lamina, slightly arched from below upwards, consolidated with the posterior cornua, which divide into two branches as they curve gently backwards and inwards. The anterior cornua articulate with the styloid process of the temporal. In other Pachyderms the general disposition of the hyoid pieces is very similar to the above, but in the Rhinoceros their arrangement approximates what is met with in horned ruminants, the anterior cornua being articulated to the styloid by an intervening osseous piece.

The laryngeal apparatus exhibits nothing extraordinary in its arrangement.

Circulatory and respiratory systems.—The organs of circulation and respiration likewise, in their general arrangement, differ from those of other Mammalia in no important particular. We may, however, notice one or two deviations from the usual type in the origins of the chief venous and arterial trunks.

In the Hyrax the arch of the aorta gives off the arteria innominata, which divides into the right subclavian and the two common carotids, and then a second single trunk, which is the left subclavian.

The Elephant in several points of its economy exhibits remarkable affinities with the Rodentia, in proof of which the correspondence of the structure of its heart with that of some of the Rodents is very striking. Thus the right auricle receives three venæ cavæ, a right and a left superior and an inferior, which latter presents the usual arrangement. Moreover, the Eustachian valve, which is placed between

the orifices of the inferior and left superior cavæ, present, in addition to the inferior portion usually met with, the rudiment of a superior division of the valve, extending from the posterior aspect of the orifice of the superior cava. A similar arrangement is met with in the Porcupine and other Rodents.

Urinary organs.—In the young animals the kidneys are separated into several lobes by very deep sulci, but in the adults this lobulated appearance is in a great degree obliterated. In other respects the renal apparatus, ureters, and bladder have nothing peculiar in their structure or disposition.

Generative organs (male).—In the structure of the external generative apparatus of the male Elephant, the principal feature worthy of remark is the existence of two special muscles destined to the retraction of the organ after its erection, an arrangement which is frequently rendered necessary in consequence of its enormous size in that animal, which is stated to be proportionately greater than in any other quadruped. These muscles arise from the anterior part of the os pubis on each side of the penis, and uniting at a little distance from their origin form a common tendon, which runs in a groove along the dorsum of the penis to be inserted into the glans. The action of these muscles will of course be to retract the member into its sheath after erection or after the discharge of urine, which requires a kind of semi-erection, precisely as is the case in the Horse. The other muscles connected with the generative apparatus agree exactly with those met with in the generality of quadrupeds, from which they only differ in size; these are the *acceleratores urinæ* and the *transversales perinæi*.

The *corpora cavernosa*, besides the mesial tendinous septum between them, are traversed by strong secondary septa derived from the external envelope, which is of great thickness in proportion to the enormous size of the organ.

The *verumontanum*, the *prostates*, *Cowper's gland*, the *vasa deferentia*, and the *vesiculæ seminales* occupy their usual positions, and have nothing remarkable in their structure or arrangement.

The testes of the Elephant are not contained in any scrotal pouch or even lodged in the groins, as has been asserted by some authors, who have been deceived by the existence of large glandular masses situated in the inguinal regions; but are deeply situated in the abdomen in close contact with the kidneys, to which they are attached by membranous prolongations resembling little *omenta*; consequently the *vasa deferentia*, which are very large and tortuous, pass immediately to their destination in the commencement of the urethral canal, being closely accompanied by the ureters during the greater part of their course, and lying between those tubes and the rectum.

As another example of the general structure of the male generative organs in Pachydermatous animals, we select those of the Boar. In this creature the glans penis is very long and nearly cylindrical except at the extremity, where it becomes of a prismatic shape ending in a point,

which is suddenly bent upon itself. The body of the penis consists of only a single cavernous body, and just above the testes at about four inches from the insertion of the prepuce presents a very singular arrangement, being bent twice upon itself at intervals of about an inch, so as to form at this place a close sigmoid curve; it is flattened for the greater part of its length, but becomes rounded and thinner in the neighbourhood of the glans. The testicles are very large, and the epididymis of each upwards of an inch in length. The *vesiculæ seminales* are very extensive, occupying their usual position near the termination of the *vasa deferentia*. The *prostates* reach from the *vesiculæ seminales* as far as the ejaculator muscles, lying on each side of the urethra. Each prostate, moreover, is covered externally by a layer of muscular fibre, which is one or two lines in thickness.

In the *American Tapir*, according to Professor Owen, the testes are elongated glands four inches in length, situated externally in a slightly indented scrotum at the distance of six inches from the anus. The *cremaster* is remarkably powerful, being composed of a strong fasciculus of fibres continued from the lower margin of the internal oblique muscle, of upwards of one inch in breadth. The *tunica vaginalis* has, as usual, a free communication with the cavity of the abdomen. The penis, which is of great length, is not furnished with levator muscles, but is supported by a quantity of elastic cellular membrane, which extends from the abdominal muscles along the *dorsum penis*.

Generative organs (female).—These present the arrangement usually met with in quadrupeds furnished with a cornuted uterus, the relative size of the uterine apparatus varying in proportion to the fecundity of each genus.

The only description of the female generative organs of the Elephant with which we are acquainted is the following, given by M. Perrault of the parts of one dissected by him in the menagerie of Versailles, many points of which are sufficiently remarkable. That anatomist describes the vulva as being placed almost in the middle of the belly, at a distance of more than two feet from the place where it is usually situated in other animals. The clitoris extended all along this space beneath the vagina and was two inches in diameter, so that, although covered by the skin of the abdomen, it was so apparent as to have been always mistaken for a penis, and the animal was in fact considered to be a male until dissection revealed the mistake.

The vagina extended backward from the vulva to the pubis in a contrary direction to that which it takes in other animals, and at the pubis it formed an angle about the middle of its length, so that the second half ran forward in the usual manner: its lining membrane was very smooth. The edges of the orifice of the womb extended into the vagina for the length of two inches, the neck of the uterus being, as it were, closed by two sigmoid valves, so disposed, according to Mons. Perrault, to prevent

the urine from entering the womb, because the urethra opens into the vagina so near the os tincæ that the urine flows more readily towards the womb than towards the vulva, the angular bend in the vagina forming an obstacle to its passage in the latter direction.

The body of the uterus was oval, and measured a foot and a half in length by ten inches in breadth. The cornua uteri were each two feet eight inches in length, and four inches and a half in circumference: their openings into the womb were surrounded by a prolongation of their lining membrane, hanging into the uterus like a fringe or valve, so that any thing which had passed from the cornua into the uterus could not return again from the uterus into the cornua, which latter were united to each other for about a foot from the body of the uterus. The Fallopian tubes were only two inches in length, and the ovaria of very small size.

In the *Sow* the vulva occupies its usual situation between the pubic symphysis and the anus. The glans clitoridis is bent upon itself and terminates in a point resembling the penis of the Boar in miniature. The walls of the vagina are much plicated for an extent of two or three inches from the orifice of the womb, and in this part its canal is considerably wider than near the entrance of the vulva. The *os tincæ* is only indicated by a slightly elevated margin. The *cornua uteri* are of great length, being convoluted much after the manner of the small intestines. The fimbriated extremities of the Fallopian tubes are only connected at one point with the ovaria, the rest being loose and floating. The ovaries in the common *Sow* are of very irregular contour, the Graafian vesicles (as big as peas) standing prominently out from their surface.

In the *Elephant* the mammæ are pectoral and only two in number, one situated on each side of the breast.

The *Rhinoceros*, the *Tapir*, and the *Hippopotamus* have likewise only two mammæ, but they are placed beneath the belly.

In the *Hog* there are generally ten nipples both in the male and female; these are situated beneath the belly, five on each side, but sometimes there are five on one side and six on the other, and occasionally six on both sides.

Of the Nervous System. Brain.—The brain in the *Pachydermata* is largely developed, and the convolutions upon its surface comparatively small, though very numerous and separated from each other by deep sulci. In the *Elephant* the absolute size of the organ exceeds that of man, but is very small in proportion to the bulk of the animal, especially when we take into the account the great size and intellectual aspect of the head. In an *Elephant* dissected by the Parisian *Academicians*, which was seven feet and a half high from the ground to the top of the back, and eight feet and a half in length from the forehead to the tail, the brain and cerebellum together weighed nine pounds. The convolutions upon the surface of the cerebrum were well marked, and the proportionate size of the cerebellum is described to have been enormous; the brains of

the *Rhinoceros* and *Tapir* are equally large in proportion, but the relative size of the cerebrum, especially of its anterior and superior regions, when compared with the rest of the brain, is much less. The hippocampus and corpus striatum are well developed, and the lateral ventricles are continued forwards into the dilated olfactory bulbs. The cerebellum is very large and expanded transversely, its surface being still further increased by numerous and complex anfractuositities. The pons Varolii corresponds in size with the development of the lateral lobes of the cerebellum, and the corpora olivaria are remarkably prominent. In other respects the brain of the animals included in this order presents no peculiarities worthy of special notice. The nerves take their rise in the usual manner, and have the same distribution as in other *Mammalia*. In those races, however, which have the nose largely developed, the fifth pair is remarkable for its great size, and in the *Proscoidian* species these nerves are of enormous dimensions.

The dura mater is very thick, proportioned rather to the size of the skull and of the entire animal than to that of the brain itself; and its two fibrous layers are found in the larger species to be separated by a quantity of cellular substance in which the vessels ramify.

The spinal chord presents no peculiarity worthy of being distinctly alluded to.

Of the Special Senses. Touch.—In animals whose limbs seem to be converted into mere pillars of support, and whose hoof-cased feet are totally destitute of all power of prehension, it would hardly have been expected that any nicety of appreciating tactile impressions should exist in the situations usually appropriated to this sense, more especially when we take into the account the thickness and density of the integument with which they are clothed.

The nasal apparatus, however, in all the *Pachydermata*, is richly endowed with nerves of sensation, and obviously forms a very perfect organ of touch. It is moreover in some measure converted into an instrument of prehension, or is employed for digging the soil in search of food, as well as for the usual offices assigned to it; in fact it is in this group of quadrupeds alone that the nasal cartilages and the muscles of the nose assume their full development, and accordingly will merit special notice in this place.

In the *Hog* the cartilages of the nose form a complete tube, which is a continuation of the bony nostrils, and near the end of the snout, in the vicinity of the *septum narium*, the extremity of the cartilages becomes ossified, and in the dried skull seems to form an additional bone (*fig. 481*). Four strong pairs of muscles, derived from the bones of the face, confer upon the organ considerable power of motion, and render it very efficient in tearing up the earth. Of these muscles the first pair arises in front of the orbit from the lacrymal bone, and terminates in a strong tendon which spreads out upon the upper aspect of the nasal cartilages. Two other pairs situated beneath the preceding are derived from the superior

maxillary bone in front of the zygomatic process: these muscles are partially united, but their tendons run separately to be inserted, one into the side, the other into the base of the snout. The fourth pair is comparatively of small size, arising from the nasal bone, and running obliquely beneath the tendons of the two last, terminates near their insertion. The snout and all the above longitudinal muscles are moreover enclosed by a layer of annular fibres, which are a continuation of the *orbicularis oris*, so that considerable mobility in any required direction is thus amply provided for.

In the construction of the snout of the Tapir the arrangement of the nasal cartilages and muscles of the nose is still more elaborate, forming a rudimentary proboscis which is only surpassed in complexity by the trunk of the Elephant, the only existing type of the true Proboscidian Mammalia: in fact it is constructed upon the same principles, the great difference consisting in the diminutive size of the organ in the Tapir when contrasted with the prodigious dimensions of the corresponding parts in the Elephant's proboscis. The nose of the Tapir is composed of two membranous tubes, amply provided with mucous lacunæ, and enclosed in a fleshy mass surrounded by the skin, which consists of longitudinal muscles that take their origin beneath the lower margin of the orbit, and of fasciculi of transverse fibres passing between the skin and the external surface of the membranous nasal tubes. There is a pair of muscles in every way similar to the *elevators* of the upper lip of the *Horse*, derived from the precincts of the orbit, and uniting into a common tendon to be inserted into the upper aspect of the nose, a pair of depressors arising from the intermaxillary bones, and also a slip derived from the *occipito-frontalis*, which is implanted by the intervention of a tendon into the base of the proboscis.

The proboscis of the Elephant, the only existing example of a completely developed nasal apparatus, forms an elongated cone of four or five feet in length, and gradually tapering from the root towards the point, which is terminated by a kind of thumb-like appendage which is endowed with exquisite sensibility, so as to be useful in picking up the smallest objects. Internally the Elephant's trunk is perforated by a double tube, formed by a strong tendinous membrane, through which innumerable mucous crypts pour fluid abundantly into the nose. The membranous tubes are continued upwards as far as the bony nostrils, but, a little before their junction with the latter, they form two curves, the nasal passages being closed at this point by a cartilaginous elastic valve, which may be opened at the will of the animal, but closes by its own elasticity when the muscles which open it cease to act.

All the interval between the membranous tubes which follow the axis of the proboscis, and the skin by which it is invested externally, is filled up with a thick layer of muscular substance composed of two sets of fibres. Of these one set passes from the exterior of the membranous tubes to a strong tendinous mem-

brane situated immediately beneath the skin in such a way that on making a transverse section of the trunk, these muscles represent the radii of a circle: their action will be, of course, to approximate the membranous tubes and the external integument of the trunk, and thus by compressing the intervening space, their contraction will have the effect of elongating the whole proboscis, without at the same time diminishing the calibre of the membranous tubes, as would have been the case had annular fibres been employed instead of this remarkable arrangement.

The other muscles of the proboscis are disposed longitudinally, and form a multitude of fasciculi, disposed in short curves in such a manner that the two extremities of each fasciculus are implanted into the membranous tubes, while the convexity of the arch is adherent to the external tendinous membrane. These fasciculi surround the whole trunk, and extend along its entire length; their effect being to shorten it from end to end or in any part the animal may please. It is evident that by these partial elongations or shortenings of one side or the other, the Elephant can bend its trunk in any direction with the utmost ease, and make use of it as efficiently as a hand in the performance of many important offices. In addition to the above account of the anatomy of this remarkable apparatus given by the Parisian Academicians, Cuvier ascertained that all the longitudinal fasciculi which enter into the composition of the trunk are derivations from four great muscles, which, though almost blended together in the trunk itself, are distinct enough near their commencements. Of these the two anterior arise from the whole breadth of the frontal bone above the *ossa nasi*, while the two lateral muscles take their origins from the superior maxillary bones beneath and in front of the orbit. The posterior or inferior aspect of the Elephant's proboscis is covered with fibres, which seem to be continuations of the *orbicularis oris*, and which run obliquely downwards and inwards so as to meet their fellows from the opposite side at an acute angle. With such a structure it is evident that the nasal prolongation of the Proboscidian Pachyderms is able to move in every needful direction, and perform all the duties of a lithe and flexible arm, strong enough to tear the branches from the trees, and sufficiently manageable to be available for the most delicate manipulations.

The instruments of the senses present few peculiarities.

In connection with the organs of smell we may conveniently mention the sinuses which communicate with the nasal cavities, which in many Pachydermata are extremely developed. The *frontal sinuses* of the Elephant are of enormous extent, reaching throughout all the thickness of the frontal, of the parietal, of the temporal, and even extending into the condyles of the occiput. The whole of this extensive cavity is divided into cells by numerous imperfect septa, irregularly disposed. In the Hog tribes they are equally extensive, but far more shallow; they reach as far back as the occiput,

Fig. 481.

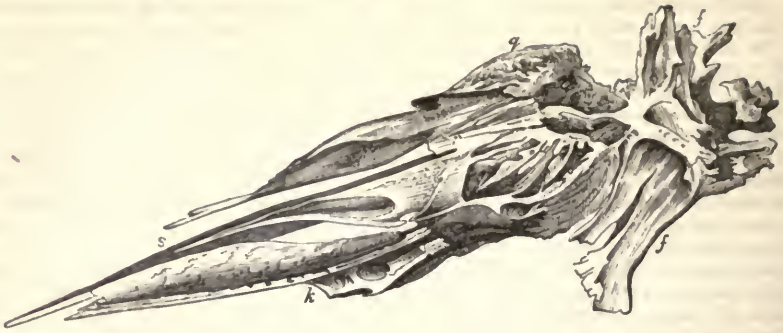
*Sphenoidal and vomerine plates of a young Boar (Sus Scrofa).*

and are divided into communicating cells by longitudinal or slightly oblique lamellæ of bone. In the *Babiroussa* there are four rows of such cells, and in the common *Hog* seven or eight. In the Hippopotamus and Rhinoceros the frontal sinuses can scarcely be said to exist.

The *maxillary sinuses* are very large in the Elephant, and are divided into numerous intercommunicating cells which open into the side of the nose by a wide orifice. In the *Hog* tribe these sinuses do not exist, but in their stead there is a cavity in the malar bone, which in the Ethiopic Boar is very large. A similar cavity of smaller size exists in the Hippopotamus.

The *sphenoidal sinuses* are very small except in the Elephant, in which, like the preceding, they are of unusual dimensions, extending even into the pterygoid processes; but they are not divided into cells as are the other sinuses of this creature.

Eye.—The optic apparatus requires but a few passing observations.

The external boundary of the orbit is completed by a strong ligamentous margin.

The third eyelid is very largely developed in the Elephant, and can be drawn over the eyeball to a considerable distance towards the outer angle of the eye. It is provided in this animal with two special muscles which do not exist in other quadrupeds. One of these, which seems to draw the nictitating membrane over the eye-ball, arises from the lower margin of the orbit, towards the outer canthus; while the other, which is the antagonist of the former, draws it back again towards the inner angle.

The Harderian gland is of very great size, and opens by a capacious duct upon the inner surface and close to the base of the third eyelid; in some species, however, as in the Elephant, numerous small accessory glands are met with, the excretory orifices of which terminate near the margin of the nictitating membrane. The nictitating membrane itself is very large, and sometimes contains a flat, thin, and slightly curved cartilage. Moreover, in the Elephant especially this membrane really deserves to be considered as a proper eyelid, being moved by a distinct muscle, the *nictitator*, the fibres of which pass in a regular curve over the base of

the membrane, but afterwards deviate from the curve and form an angle to include the extremity of the nictitating cartilage, which consequently moves in the diagonal of the contracting forces so as to be drawn outwards over the front of the eyeball.

Ligamentum nuchæ.—The ligamentum nuchæ is of enormous strength, more especially in the larger Pachydermata, such as the Elephant and Rhinoceros, where the ponderous head necessarily requires unusual support.

In the American Tapir this ligament consists of three strong portions, two of which pass in a parallel direction from the elongated spinous process of the first dorsal vertebræ, to be inserted together into the superior and posterior angle of the central ridge of the cranium supporting the whole length of the elevated crest and mane; the third portion runs beneath the other two, to be inserted into the most elevated part of the elongated spinous process of the *vertebra dentata*.

BIBLIOGRAPHY.—*Stukely*, Essay towards the anatomy of an Elephant, 1722. *Duvernoi*, Acta Petropolitana, 1727. *Blair*, Phil. Trans. abridged by Baddam, vol. v. *Perrault*, Mémoires pour servir à l'histoire naturelle des animaux. *Buffon et Daubenton*, Histoire naturelle, 4to. 1764. *Cumper*, Description anatomique d'un Eléphant mâle, 1802. *Pallas*, Spicilegia zoologica, tom. i. 4to. 1784—contains an anatomical description of the Hyrax under the title of *Cavia Capensis*. *Owen*, Proceedings of the Zoological Society of London, 1830-31, and *Yarrell*, in the fourth vol. of Zoological Journal for dissections of the Tapir. *Owen*, Odontography; or, a treatise on the comparative anatomy of the teeth, 8vo. 1845. *Cuvier*, Anatomie comparée, 8vo.; Ossemens fossiles, 4to.

(*T. Rymer Jones.*)

PACINIAN BODIES, so named after Filippo Pacini, professor of anatomy at Pisa, who discovered them in 1830, and subsequently published two memoirs upon them. They are peculiar minute organs appended to the nervous system, and present an arrangement altogether novel and full of interest, though as yet their use is entirely unknown.

The essential structure of these corpuscles appears to be the following. A single tubular or white nervous fibre leaves the fasciculus of which it forms a part, and carrying with it a

process of the fibrous neurilemma, advances right into the centre of a series of concentric ovoidal capsules of fibrous membrane, through a channel which perforates them all, and which has its proper wall, to which every capsule is attached. All the capsules, except from five to twenty of the inner ones, have spaces between them containing a clear watery fluid. These spaces do not communicate with one another or with the channel in which the nerve runs. Each one is distended by its own fluid, and in the natural state is more or less tense, offering

flattened (so that its section is oval instead of round), and in particular much paler. The dark border which has distinguished it hitherto now disappears, and if it were not for the transparency of the contents of the capsules its further course would be untraceable. It is, however, when fresh, and with a good light, distinctly seen to proceed along the very axis of the central capsule from one end to the other, and finally to be implanted by more or less of a swelling (*fig. 483*) into the further extremity

Fig. 482.

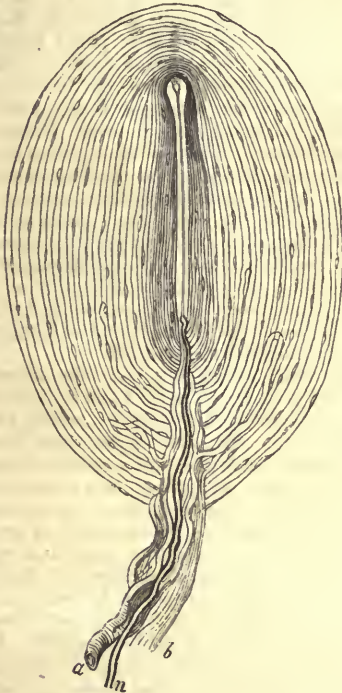

Pacinian corpuscle, from the mesentery of a cat; intended to shew the general construction of these bodies. The stalk and body, the outer and the inner system of capsules, with the central cavity, are seen.

a: Arterial twig, ending in capillaries, which form loops in some of the intercapsular spaces, and one penetrates to the central capsule. *b.* The fibrous tissue of the stalk, prolonged from the neurilemma. *n.* Nerve-tube advancing to the central capsule, there losing its white substance, and stretching along the axis to the opposite end, where it is fixed by a tubercular enlargement.—*From Todd and Bowman.*

resistance to external pressure. The innermost capsule of all is an elongated nearly cylindrical cavity, somewhat larger at the further end, and always contains a clear fluid, which distends it and prevents its sides from falling together. The nerve-tube has the ordinary double dark contour as well as every other character of those found in the ordinary cerebro-spinal fibres until its entry into the central capsule. At that point it becomes less bulky, somewhat

Fig. 483.

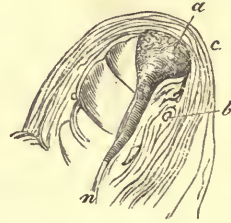

Extremity of the pale nerve-fibre in the inner capsule of a Pacinian body from the mesentery of a cat.

n, pale fibre advancing into the further end of the central capsule; *a,* conical swelling by which the nerve is fixed; *b,* corpuscle of the inner capsule; *c,* capsules of the internal system. Magnified 300 diameters. *From Henle and Kölliker.*

of this central compartment. The originally dark border of the nerve-tube does not cease with absolute abruptness, but the two lines of the border coalesce in a somewhat sloping manner, and the pale continuation has merely a single bounding line, and that so exceedingly thin as not to allow of being described as an investment distinct from the rest of the fibre. This line, as Henle and Kölliker have remarked, is more evident when the edge of the flattened fibre is towards the observer than when the flat surface is upwards, in which latter position it is sometimes altogether absent.

Such is the general plan of the structure of these bodies. Their usual length is from 1-20th to 1-10th of an inch, and their stalk is often 1-10th of an inch long. Though usually oval, they are often more or less elongated and bent on themselves. Sometimes the internal capsules only are bent, while the outermost are simply oval. In the human subject they are found in large numbers, detached or in clusters, in the subcutaneous areolar and adipose tissues of the palm and sole, in connection with the cutaneous nerves, as well as more sparingly in the same connection at other parts of the extremities. A few are also met with in the sympathetic plexuses; and in the cat in particular they are usually so abundant in the mesentery and omentum, as instantly to arrest the eye when these parts are spread before it. They are here indeed most favourably situated for examination. They are included merely between the duplicature of the transparent peritoneum, can be obtained in great numbers perfectly fresh, and admit of being inspected without the addition of any water or other medium.

Fig. 484.



One of the nerves of the palm with the corpuscles appended, and of natural size. After Henle and Kölliker.

To the naked eye they here present a beautiful semi-transparent pearly lustre, with a whitish opaline streak along the axis, resulting from the greater proximity and density of the series of internal capsules. In some animals of this species they have appeared to me almost wanting. It is remarkable that in no instance have they been detected in connection with nerves purely motor, nor, it is affirmed, on the fifth nerve or the glosso-pharyngeal.

The *stalk* consists, as has been said, of a production of the neurilemma enclosing a single nerve-tube. It sometimes happens that there are two nerve-tubes, but then there are two corpuscles on the single stem, either in close apposition, or actually enveloped by a few capsules common to both. The nerve-tube in the stalk is undulating, and being accompanied by white fibrous tissue is easily distinguished by its peculiar structure. The artery and vein supplying the corpuscle are also included in the stalk.

The *channel* which the stalk occupies in its passage through the capsules, is conical and comes to a termination at the proximal end of the innermost capsule. It is furnished with a membranous wall, with which the fibrous tissue of the stalk is united on the inside and the several capsules on the other, and by this means the intercapsular spaces are preserved closed, and their fluid retained. This wall usually presents irregularities of outline, and often a cellular appearance, where the capsules, and especially the inner ones, join it. It is perforated by the minute vessels as they enter some of the intercapsular spaces (fig. 482).

The *capsules* themselves are inelastic membranes, analogous probably to the white fibrous tissue, and furnished with clear transparent nuclei that project chiefly on the inner surface. This is true of all the capsules, but in the outer system or those thicker and stronger ones between which fluid intervenes, there is evidence of a double wall; for in addition to the clear

double line which distinguishes all, these present also on their outside, when seen edgewise, a series of dots, which indicate a system of transverse or circular fibres, and in fact the corpuscle, when brought into focus, shows no other fibrillation than this transverse one. Almost all appearance of a fibrous texture is removed by acetic acid, so that the yellow or elastic fibre does not appear to form any portion of the capsular membranes. The outermost capsule, indeed, is invested with both the elastic and the inelastic fibres, but these are to be regarded as belonging rather to the areolar tissue in which the corpuscles are imbedded, than to these organs themselves. The capsules are united together by the wall of the channel of the stalk. They are also joined here and there by partial membranous septa passing directly or obliquely across the intercapsular spaces, and which seem to be of the same nature as the capsules themselves. Pacini describes further a union of the capsules at the distal end in the axis of the corpuscle, which is denied by Henle and Kölliker to exist. I have had, however, unequivocal evidence of its existence, especially between the inner capsules, when they have been artificially distended by water, although it often appears to cease towards the surface. When the end of the capsules is bent on itself, the line of this intercapsular union is less easy to trace.

The small *artery* supplying the corpuscle subdivides in the channel of the stalk into its three, four, or more capillaries, which pierce the wall and enter the intercapsular spaces. After advancing in these for a variable distance they form loops, and return by a similar route to the small corresponding vein. In the larger corpuscles I have seen a little bunch of vessels formed near the further end by some of these capillaries. In most cases a single capillary accompanies the nerve-tube as far as the central capsule, and then passes for some way upon its wall, sometimes in a spiral direction. If a perfectly fresh corpuscle from the mesentery of a cat be examined before the blood has drained off, the addition of a little water will occasionally induce a rapid movement of the contents of these minute vessels under the eye of the observer, by gaining entrance to their interior; and few objects are more beautiful than the miniature circulation thus artificially brought about for a brief period. The capillaries have their proper walls, furnished with nuclei.

The *central cavity*, in size, and particularly in shape, is liable to much variety. It has been already stated to be not unfrequently bent upon itself towards the further end; sometimes it is bifurcated, or, more correctly, branched, the offset then passing in a recurrent course either from the commencement or the middle part of its length. In this case the branch is surrounded by the same series of internal close capsules, and external ones separated by fluid, which encircle the principal cavity, only accommodated to the irregular conformation. However the central cavity is modified, it always retains its transparent character, and on its inner

Fig. 485.

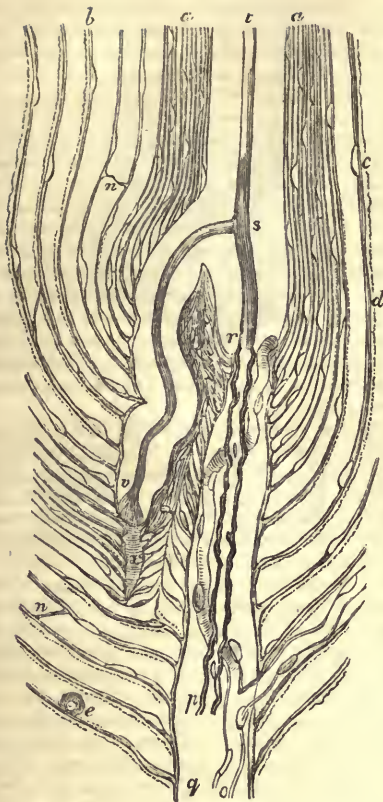

Portion of a Pacinian corpuscle, from the mesentery of a cat.

a a, the internal capsules; *b b*, capsules of the external system, with intervening fluid. Corpuscles, as at *c*, are seen in all the capsules. The outer capsules show a double layer, *d*; *e*, occasional form of corpuscle in the intercapsular spaces; *n n*, connecting membrane between two capsules; *o*, capillary vessel containing corpuscles or nuclei in its wall, and lying with *p*, a tubular nerve-fibre in *q*, the channel of the stalk, the fibrous tissue surrounding them not being represented. The vessel divides into two branches, one of which perforates the wall of the channel of the stalk and enters an intercapsular space, and the other advances as far as the central capsule. The nerve has the double contour as far as *r*, where it enters the central capsule; from that point it is pale and faint. This specimen represents an offset of the central cavity, and of the pale nerve at *s*. The stem continues its course, *t*, towards the further end of the central cavity, while the offset follows the curved axis of the subordinate cavity as far as *v*, where it ends in a bulb by which it is fixed. Several of the capsules are united together at *x*. Magnified about 300 diameters.

surface exhibits very faintly marked elongated nuclei, which most probably belong to the wall of the inner capsule.

There is little to add to the description of the *nerve-tube* already given. It is faintly granular in texture, and occasionally regains, at

one or more points of its course within the central capsule, the dark contour which it had lost on entering it. This is particularly the case when it follows a bend of the cavity, and certainly seems to indicate the presence there of a material elsewhere deficient. It is rare, however, to see this re-assumption of the dark border in any very well-marked degree. The mode of attachment of the end of the nerve-fibre varies, being generally by a single tubercle or conical swelling, sometimes by two, and sometimes even by three such. Whatever the number of branches, however, their aggregate thickness is about the same as that of the simple fibre from which they spring. Where the central cavity exhibits the offsets above-mentioned the pale nerve-fibre is also invariably branched, its subordinate branch always traversing the axis of the subordinate cavity, and being regularly fixed at its extremity. It is interesting to observe how accurately the nerve-fibre preserves its place in the axis of the central cavity, however abruptly that may be bent or branched, a fact which might be supposed to indicate some degree of viscosity in the clear substance through which it runs.

Respecting the *function* or *use* of the Pacinian corpuscles no satisfactory account has yet been given, nor even a plausible explanation offered. Their presence in so great abundance on the nerves of the palm and sole, and their absence from motor nerves, suggests the obvious enquiry, whether they may not be connected in some way with the sense of touch, or at least with the function of sensation, to which the fact of their concentration in such numbers in the splanchnic nerves of some animals as obviously answers in the negative. Undoubtedly, however, we may anticipate much from a more extended research into their connections with the several parts of the nervous system in man and animals, than the very recent date of their discovery has yet allowed. The speculation that they may be concerned in the phenomena of what is called animal magnetism is not to be passed over with contempt, if only because it has been hazarded by their distinguished discoverer, Pacini, who, in common with many other unprejudiced and not incapable observers, is inclined to believe in the reality of some of the less marvellous effects which popularly pass under that title, such, in particular, as the mesmeric somnolence and catalepsy. Yet so vague an hypothesis, perhaps, barely deserves to be placed in juxtaposition with the descriptive anatomy of the corpuscles.

It will be more to the purpose to institute a brief comparison between these bodies and the electrical organs of the torpedo, a description of which will be found under the head of ANIMAL ELECTRICITY. Since that article was written, however, further researches, and especially those of Savi,* have added some points of importance which it will first be necessary to no-

* Savi, *Etudes Anatomiques sur le système nerveux et sur l'organe électrique de la Torpille*. Vide Matteucci, *Traité des phénomènes electro-physiologiques*. Paris, 1844.

tice. The prisms of the electrical organ, as Hunter described, are divided by very numerous horizontal diaphragms into spaces containing a thin fluid, and on these diaphragms the nerves and vessels of the organ are ultimately distributed in great abundance. Each of these superposed diaphragms consists of a layer, possibly double, in and not upon which the nerves ramify. The nerves of the electrical organ have never any ganglia formed upon them. Their tubules always have the double contour which marks the presence of the white substance of Schwann. The ramifications penetrate between the prisms, and each diaphragm receives tubular fibres at several points of its circumference, though Savi is doubtful whether these are derived from two or more tubules of the branch supplying them. In the diaphragm, however, they are uniformly spread out in a network with five or six-sided meshes, the sides of which are everywhere formed by a single tubule with double contour of the same diameter and structure as the tubules of the trunk of the nerve. If this network is supplied from several different tubules, these tubules must be described as inosculating to form it; if from a single tubule, this must be regarded as again and again branching dichotomously, and the branches repeatedly anastomosing. Whichever be correct, the existence of a true network of ultimate nerve-tubes with double contour is certainly a fact of much importance, and hitherto unique; and it appears to be satisfactorily established by the repeated accurate observations of Savi.

The series of superposed membranes in the prisms of the electrical organs may have an analogy with the concentric capsules of the Pacinian bodies. Their separation by intervening fluid is another point of resemblance. But in their relation to the nerves they are quite unlike. In the one, each membrane has a plane network of nervous tubules in its substance; in the other a single nerve-fibre is placed in the axis of a series of concentric membranes. The condition of the nerves is also different. In the one the white substance of Schwann everywhere invests the nerve; in the other it is suddenly lost on entering the central capsule. The branching of the nerve-tubes in the electrical organ has a correspondence with the frequent tendency of the pale fibre of the Pacinian corpuscle to divide into two or more parts. On the whole, perhaps, the comparison may suffice to raise the question, whether the Pacinian corpuscles may not be organs designed to generate some kind of force, which the nervous communication with the centres may serve to connect either with volition or some emotional impulse or feeling.*

There is another set of organs, however, in the electric torpedo, the discovery of which we owe to Savi, and which bear a closer resemblance to the Pacinian corpuscles than the electric organs themselves. These are what he terms the *follicular nervous apparatus*, and

which I shall briefly describe nearly in his own words.*

"This apparatus is found bordering the anterior part of the mouth and nostrils, and extends over the surface of the anterior part of the electrical organs, and over the front half of their outer edge, where it rests upon the cartilage and aponeurotic coverings of the fin. Some parts of the apparatus are found on the back, but the greater portion on the ventral surface of the animal. It consists of extensive linear series of follicles, or closed membranous cells with double walls filled with a gelatinous fluid, and enclosing a small amorphous granular mass, which nearly resembles the amorphous grey matter of the cerebral hemispheres. A nervous branch gives some fibres to this granular mass, while other similar fibres united into bundles pass out of the follicle, penetrate the grey mass of the adjoining follicle, and mingle with its nerve.

"The nerves distributed to this apparatus come exclusively from the fifth pair, and more particularly from the branches springing from the anterior portion of the root. Each follicle (*fig.* 486) is of a spheroidal form, slightly compressed on the side which adheres to the neighbouring follicle, and its diameter is about $\frac{1}{4}$ th of an inch. I have found these dimensions the same in animals of very different size. These follicles are never free or floating in the gelatinous fluid so abundant in these fishes: on the contrary, they are always firmly fixed, as if with a special view to their security, for they are planted on unyielding aponeurotic expansions, like that of the muzzle, or else on fibrous bands extending along the fin, and having no other use. When the gelatinous fluid which envelops these follicles is examined under the microscope, it is seen to contain numerous fibres passing in various directions, and fixed to the surface of the follicles.

"Each follicle is formed of two membranes (*f* and *g*) which adhere together on the side towards the fibrous band which supports the organ, whilst on the opposite side they are separated by about a third of the vertical diameter of the follicle. These organs may be easily examined by a very slight magnifying power, it being only necessary in the first place to remove the investing gelatinous substance, and then to subject them to moderate compression for the display of their interior. In a follicle thus compressed, we observe first the cut portion of the tendinous band *cc*, then the outer membrane enclosing the other, in which is the rounded granular mass *e* already mentioned. This latter seems to rest upon the lower wall of the internal membrane. The external membrane adheres by its lower border to the fibrous band beneath it in such a way, that between this external wall of the follicle and the internal is left a space, in which the nervous ramification *d* advances and adheres to the rounded mass of granular substance.

"In the follicles of the longitudinal series of the fin, of which we here speak, the nervous

* Henle and Kölliker endeavoured to elicit evidence of an electric discharge from the Pacinian bodies of the cat's abdomen, but without success.

* *Op. cit.* p. 332.

(Fig. 486.)

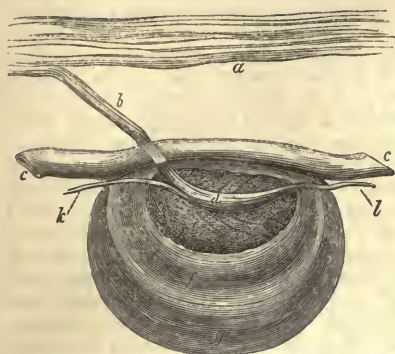

One of the follicular nervous organs of the electrica torpedo.

a, branch of fifth pair of nerves; *b*, twigs going to the organ and passing through *cc*, the fibrous band; *d*, the nerve as it lies on *e*, the granular mass; *f* and *g*, the inner and the outer capsules containing fluid; *k*, anastomosing filament from the preceding follicle; *l*, anastomosing filament to the succeeding follicle. Much magnified and slightly compressed. From Savi.

twig is derived from the fifth pair and passes first through a slit in the tendinous band. After passing this aperture it bends underneath the granular mass, and again emerges at the base of the follicle, but at the opposite side from that at which it entered. It is remarkable that the nerve is much thinner at its exit, and reduced to an exceedingly delicate filament (*l*), which proceeds along the tendinous band to the next follicle, penetrating its wall and joining its nerve at the point of its flexion under the granular mass (*k*).

“On examining under the microscope the rounded granular mass, made flat by the compressor, and after the removal of the membranes of the follicle, we see the nerve running lengthwise over it from end to end, the anastomosing branch coming from the preceding follicle (*k*) and the very delicate filament which proceeds to that next in order (*l*). We further remark that the nerve of the follicle, in its course along the granular mass, gives off a great number of elementary fibres, which disseminate themselves through the mass and thus reduce the nerve to so small a size. Sometimes I have fancied that these fibres formed loops and returned; but I have never obtained a clear view of their termination. I am no less doubtful regarding the course of the elementary fibres of the anastomosing branch coming from the preceding follicle. Sometimes I have seen these fibres return towards the slit in the tendinous band and rejoin the nerve in order to regain the centre. In other cases I have seen these fibres pursue their primitive direction, and pass on with the rest towards the opposite end of the granular mass. Hence I imagine that the fibres of the anastomosing bundle do not all follow the same course, and that while some advance into the granular mass, others turn back towards

the centre through the slit in the fibrous band.” “It occasionally happens that two nervous twigs pass from the main branch to the same follicle. When this happens, there are always two distinct granular masses.” M. Savi then describes accurately the arrangement of the several series of these follicles in the torpedos which he examined, an account of which is not necessary for our present purpose. In one example he found that the follicles amounted in all to two hundred and fourteen.

We cannot adduce these remarkable and peculiar structures as at present throwing any light on the function of the Pacinian corpuscles, since we must confess with M. Savi that as yet we are entirely ignorant both of their real nature and use. Nevertheless the resemblance is such as, it is hoped, will warrant the introduction of the preceding account, which is new in this country, and very interesting in itself. It is unnecessary to recapitulate the several points of similarity and difference, which, after the detailed description of each now offered, may be readily apprehended by the reader himself.

It only remains that we should direct attention to the very admirable memoir of Henle and Kölliker on this subject. They corroborated the principal results of Pacini, and added many most valuable observations which the use of higher powers of the microscope and perhaps greater experience in research had enabled them to make. These observations M. Pacini has recently informed me he has himself almost entirely confirmed. An excellent abstract of their labours appeared in the *British and Foreign Medical Review* for January, 1845, and in the following April Dr. Todd and myself gave an account of these structures, drawn up from original observations and containing some new results, though on the whole confirmatory of those previously published. See the *PHYSIOLOGICAL ANATOMY AND PHYSIOLOGY OF MAN*, vol. i. p. 395.

It is right to add that MM. A. G. Andral, Camus, and Lacroix, met with these bodies in 1833, and that they were noticed subsequently by Cruveilhier and Blandin in their respective works on descriptive anatomy, but without any real light being thrown on their nature or internal structure.

(William Bowman.)

PAR VAGUM NERVE. (HUMAN ANATOMY.)—(*Nervus Vagus*; *Pneumogastric*; part of the *sixth pair* of nerves of the older anatomists; *one* of the three divisions of the *eighth pair* in the classification of Willis; the *ninth pair* of Andersch; the *tenth pair* of Sömmerring; the *moyen sympathique* of Winslow.) The par vagum, like the other cerebro-spinal nerves, consists of two nerves exactly similar at their origin, and placed on different sides of the mesial line of the body. It has a very long course,—passing down the neck, and through the thorax to the upper part of the abdomen,—is distributed upon numerous and dissimilar organs, and anastomoses very freely and extensively with the *sympathetic* and various *cerebro-spinal* nerves. It is the chief nerve

of the lungs and stomach, and hence its appellation of pneumo-gastric.

The *nervus vagus* arises by several filaments, generally from six to ten, from the restiform body of the medulla oblongata, parallel to and a little posterior to the groove between the olivary and restiform bodies, and from a line to a line and a half distant from the posterior edge of the olivary body. The arciform band of superficial filaments passing between the anterior pyramidal and restiform bodies cross among the lower filaments of this nerve. The filaments of the *vagus* are attached to the restiform body in a vertical, straight, and thin band of from three to four lines in length, the upper end of which is separated from the lower edge of the glosso-pharyngeal nerve by a few small bloodvessels only. The upper half of these filaments of the *vagus* are at their origin closely approximated, so that the lower edge of the one above is in contact with the upper edge of the one below, while the lower filaments, especially the two last, are considerably more distant from each other. The lowest filament is placed only a little above and in the same line with the uppermost filament of the spinal accessory, and it is frequently difficult to determine where the filaments of the accessory begin, and where those of the *vagus* end. From this origin each *vagus* proceeds forwards and outwards between the lower surface of the lateral lobe of the cerebellum and that portion of the dura mater covering the basilar process of the occipital bone, to reach the foramen lacerum posterius, through the anterior part of which opening it escapes from the interior of the cranium. In this part of its course it frequently anastomoses with the glosso-pharyngeal, and its filaments become more subdivided, but at the same time more closely aggregated, so that it is thicker and narrower. On reaching the foramen lacerum posterius it enters a sheath or canal in the dura mater, anterior and a little internal to the commencement of the internal jugular vein, immediately anterior to the spinal accessory nerve, and posterior to the glosso-pharyngeal. As these three nerves enter the foramen lacerum, they perforate the dura mater, the glosso-pharyngeal by a separate and distinct opening, the *nervus vagus* and spinal accessory by an opening common to both. Sometimes there is a small bridle of dura mater, at other times only a fold of the arachnoid separating the *vagus* and accessory at this part. At the lower part of the foramen lacerum the *spinal accessory* is closely applied to the posterior surface of the *vagus*. The dura mater is prolonged downwards into the foramen lacerum upon these three nerves in the form of two sheaths, one sheath surrounding the glosso-pharyngeal, and the other the *vagus* and accessory. From the proximity of these three nerves, as they pass through the foramen lacerum posterius, and from their intimate connection in some parts of their course and subsequent distribution, they were long considered to form only a single nerve.

As the *vagus* lies in the foramen lacerum it presents a greyish oblong swelling, resem-

bling the ganglion on the posterior root of a spinal nerve (*ganglion primum nervi vagi of Wutzer, ganglion radialis n. v. of Bendz, ganglion superius n. v., ganglion jugulare n. v.*) This ganglionic enlargement begins immediately after the nerve has entered the foramen lacerum, so that its upper edge may be sometimes seen from within the cranium; it is of an oval form, and it extends along the course of the nerve from a line and a half to two lines.* Mr. James Spence† has pointed out that a small filament belonging to the lower part of the *vagus* passes over the posterior surface of this ganglion without entering it, and joins itself to the superior filaments of the spinal accessory.‡ This fact, as we shall afterwards find, has a direct bearing upon the physiology of the nerve. A communicating filament passes between the ganglion superius of the *vagus* and the superior cervical ganglion of the sympathetic, another between it and the ganglion petrosus of the glosso-pharyngeal, (vide article GLOSSO-PHARYNGEAL,) and one or more between it and the spinal accessory.§ From the

* Arnold (*Der Kopftheil des vegetativen Nervensystems beim Menschen*. S. 107) describes this ganglion as varying little in size, and as measuring a line and a half to a line and three quarters in breadth, a line to a line and a half in length, and three quarters to one line in thickness. He found a difference of about two lines between the measurement of the circumference of the ganglion and the trunk of the nerve immediately below, the former generally measuring five and the latter three lines. Bischoff (*Nervi Accessorii Willisii Anatomia et Physiologia*, 1832, p. 20) gives the same measurements as those of Arnold, from whom he has evidently copied them. Bendz (*De Connexu inter Nervum Vagum et Accessorium Willisii*, 1836, p. 17) describes it as a rounded ganglion, somewhat flattened, measuring about two lines in the antero-posterior diameter, and nearly two lines in the vertical direction. Valentin (*Söemmering's Vom Baue des Menschlichen Körpers, Hirn und Nervenlehre*. Viertes Band. 1841. S. 482) describes it as an oblong rounded swelling, somewhat flattened, and about from a line and three quarters to two and a half lines in length.

† *Edinburgh Medical and Surgical Journal*, No. 153, 1842.

‡ Remak (*Froriep's neue Notizen für 1837*, No. 54) states that some of the filaments of the *vagus* do not pass through this *superior ganglion* of the *vagus* in the dog, cat, and rabbit; and Volkmann (*Müller's Archives*, Heft v. 1840) confirms this observation of Remak on the dog; and further mentions that the same enlargement exists in the sheep, while in the calf all the filaments pass through the ganglion. The accuracy of such dissections, especially those made on the human species, and the physiological inferences deduced from them, have been called in question, (e. g. Hein in *Müller's Archives* for 1844, p. 336, and Bischoff in the same work for 1833, p. 156), on the grounds that this anatomical arrangement is not constant, and besides that it is difficult to distinguish between the lower fibres of the root of the *vagus* and the upper fibres of the root of the *nervus accessorius*.

§ Bendz describes and delineates (*De Connexu inter Nervum Vagum et Accessorium Willisii*. Tab. i. Hannie, 1836) two small communicating filaments passing between the spinal accessory and the ganglion jugulare of the *vagus*. Valentin (*Söemmering Vom Baue des Menschlichen Körpers, Hirn und Nervenlehre*. Viertes Band, 1841) describes a similar anastomosis. Arnold (*Icones Nervorum*

lower and external part of this ganglion a small nerve arises, (*ramus auricularis nervi vagi*), which is seen joined by another small branch from the lower part of the ganglion petrosus of the glosso-pharyngeal.* The ramus auricularis proceeds outwards and a little backwards anterior to the jugular vein, and lies in a groove in that portion of the petrous portion of the temporal bone which assists in forming the fossa jugularis, perforates the osseous partition between the fossa jugularis and the aqueduct of Fallopius, and enters the internal side of the latter about one or two lines above its lower termination in the stylo-mastoid foramen. It now divides itself into two branches, a small ascending twig which joins the portio dura nerve, and a larger portion which enters a canal on the external side of the aqueduct of Fallopius, proceeding outwards and a little backwards through that portion of the spongy portion of the temporal bone which forms the lower wall of the external meatus. The larger branch subdivides into two other branches as it lies in this canal. One of these emerges upon the external surface of the cranium through a small opening between the mastoid process and the posterior margin of the meatus auditorius, and divides into two or three twigs, which pass through openings in the cartilage of the pavillon of the external ear, and are ultimately distributed upon the tegumentary covering of the internal surface of the concha and meatus auditorius externus. The other branch of the nerve passes through the mastoid process and joins itself to the auricular branch of the portio dura, and along with it is distributed upon the posterior surface of the pavillon of the external ear.† The trunk of the spinal accessory is closely connected to the posterior surface of the superior ganglion of the vagus by cellular tissue, and immediately below the lower end of the ganglion it throws a considerable branch into the vagus. The exact place and manner in which these auxiliary fibres from the accessory join the vagus differ in different individuals, and sometimes in the two sides of the same individual, but most generally the spinal accessory divides itself at the lower part of the foramen lacerum into two branches, the *internal* and *external branches of the spinal accessory*. The internal branch runs immediately into the

anterior and outer part of the vagus, and while one portion of its fibres goes to form a part of the *superior pharyngeal branch* of the vagus, the other portion joins itself to the trunk of the vagus, and accompanies it down the neck. Sometimes the fibres of the internal branch of the accessory are arranged in two bundles, and in such cases the one generally joins itself to the vagus a little below the other. The *external branch* of the accessory proceeds downwards and outwards, perforates the upper part of the sterno-cleido-mastoid muscle, and ultimately terminates in the trapezius muscle.

The superior ganglion of the vagus was known to Ehrenritter.* It appears also to have been well known to Wutzer, for it is both mentioned and figured by him in his monograph *De Corporis Humani Gangliorum Fab. et Usu*, 1818. Wutzer has in fig. vii. certainly represented it as being placed somewhat inferior to the ganglion petrosus of the glosso-pharyngeal, instead of being rather above it: yet as he terms it ganglion primum n. v. and figures the ganglion secundum in its proper position, there can be no doubt that he was well aware of its existence. It has been supposed by some that Lobstein† had also pointed out the existence of this ganglion, while others maintain that his description is not sufficiently explicit to enable us to decide whether it refers to the upper or lower ganglion of the vagus. It appears, however, much more probable that it is the superior ganglion, for after mentioning that the vagus presents a reddish appearance, similar to a ganglion, (*rubella parum quasi ganglion mentiretur*), he describes the superior pharyngeal branch of this nerve as arising below it. Müller‡ has attempted to shew that Comparetti was the first anatomist who described this ganglion, and that he was even acquainted with the ramus auricularis of the vagus; but Arnold,§ on the other hand, maintains, and we think justly, that the description of Comparetti applies equally well, if not better, to the ganglion petrosus of the glosso-pharyngeal. Desmoulins and Magendie|| observed the superior ganglion of the vagus in the carnivorous Mammalia and in the Ruminantia, and also a branch passing from it to join the portio dura, but denied that this ramus auricularis exists in man. Cuvier¶ had also previous to this pointed out the ramus auricularis in the calf. It was not, however, until Arnold's description of this ganglion had been made public, that it became generally known to anatomists, and its true nature and its anatomical relations exactly ascertained.** Ar-

Capitis, plate iv.) represents an anastomosis between the accessory and ganglion jugulare. Krause (*Hanbuch der Menschlichen Anatomie*, S. 1066, 1843, and Hein (*Müller's Archives* for 1844. Heft iv. p. 337) describe the superior filaments of the root of the accessory as connecting themselves to the lower filaments of the vagus, and that a few of the filaments of the accessory may enter the ganglion jugulare of the vagus. Bischoff (*Nervi Accessorii Willisii Anatomia et Physiologia*, 1832) neither delineates nor describes any communicating filaments passing between the spinal accessory and the ganglion jugulare of the vagus.

* In Valentin's description (*opus cit.* p. 483) of this auricular branch, the strengthening twig is said to come from the hypoglossal nerve, (aus dem zungenfleischsnerven,) but this must either be some error of the press or some *lapsus scribendi*.

† Vide Arnold's *Icones Nervorum Capitis*, tabul. iii. et v.

* Salzberg, *Med. Chir. Zeitung*, 1790. B. 4. S. 319, as quoted by Bendz.

† *Dissertatio de Neruo Spinali ad Par Vagum Accessario*. Ludwig Scrip. *Nerv. Min. Select.* tom. ii. p. 235.

‡ *Archiv. für Anat. Phys. &c.* Heft ii. s. 275, 1837.

§ *Bemerkungen über den Bau des Hirns und Rückenmarks*, &c. S. 178. Zurich, 1838.

|| *Anatomie des Systèmes Nerveux des Animaux à Vertèbres*. Deuxième partie, p. 435 & 463, 1825.

¶ *Idem opus*, p. 435.

** *Der Kopftheil der vegetativen Nerven Systemes*. Heidelberg und Leipsic, 1831.

nold was the first who described the ramus auricularis in the human species.

Passage of the vagus along the neck to the origin of the inferior or recurrent laryngeal branch—After the vagus emerges from the inferior aperture of the foramen lacerum posterius, it lies between the internal carotid artery and the internal jugular vein, the artery being internal and anterior, and at first separated a small distance from it, the vein being immediately posterior and external. The glosso-pharyngeal is still placed on its anterior side, but soon leaves it and crosses the anterior surface of the internal carotid artery on its way to the root of the tongue. The spinal accessory is still on its posterior side, but a little above the transverse process of the atlas the external branch begins to diverge backwards and outwards, and passes beneath the upper part of the internal jugular vein to reach the inner surface of the upper part of the sterno-cleido-mastoid muscle. The sympathetic nerve lies immediately posterior to it. The hypoglossal approximates its outer edge immediately below the foramen lacerum, gradually gets upon its anterior surface, is seen emerging from the angle left between it and the external branch of the accessory, where these nerves begin to separate, and opposite the transverse process of the atlas, and sometimes a little below this, it has crossed over its anterior edge, and proceeds forwards and inwards to reach the tongue. The hypoglossal, in crossing over the anterior surface of the vagus, is very closely bound to it by cellular tissue, and some small communicating branches pass between them. Some small communicating branches also pass between this portion of the vagus and the external branch of the spinal accessory, the superior ganglion of the sympathetic, the glosso-pharyngeal, and the nervous loop formed by the anterior branches of the first and second cervical nerves in front of the transverse process of the atlas. The vagus also in this part of its course generally sends a branch to join the descendens noni, and more rarely the descendens noni is almost entirely or altogether formed by this branch of the vagus.* All these nerves and bloodvessels in the upper part of the neck are surrounded and connected together by cellular devoid of adipose tissue. The vagus, after joining itself to the internal carotid artery, accompanies it to the point of bifurcation of the common carotid, and then continues its course down the neck, enclosed in the same sheath with the common carotid and internal jugular vein, the artery being internal, and the vein external and also anterior. The nerve maintains the same relation to these two vessels on both sides as far as the lower part of the neck, where on the right side the artery and vein diverge from each other, the artery passing inwards and the vein outwards, to join itself to the vena innominata; while on the left side the vein and artery have

scarcely separated from each other, when the junction between the former and left subclavian vein takes place. On the right side the nerve is seen lying in the interval between the internal jugular and the internal carotid, and while crossing the anterior surface of the right subclavian artery nearly at right angles, it sends off the right inferior laryngeal or recurrent nerve. On the left side it passes downwards into the thorax, still lying close to the outer side of the left common carotid; but as it proceeds onwards, it crosses obliquely the left subclavian artery near its origin, and passing over the transverse portion of the arch of the aorta, it there gives off the left inferior laryngeal nerve. On both sides it passes into the thorax beneath the vena innominata.

The vagus, on emerging from the foramen lacerum, is near to the outer edge of the rectus capitis anticus minor muscle and in front of the rectus capitis lateralis; in its passage down the neck it first crosses the anterior surface of the lateral part of the atlas, then proceeds along the anterior surface of the rectus capitis anticus major muscle, and lastly it descends upon the longus colli. In the upper part of its course it lies deep, and crosses beneath the styloid process of the temporal bone and stylo-pharyngeus muscle. In the middle of the neck the two vagi nerves have approached nearer to each other, and are much more superficial. In the lower part of the neck they are again placed deeper, and are covered by the sterno-hyoid, sterno-thyroid, and sterno-cleido-mastoid muscles.

As the vagus emerges from the lower part of the foramen lacerum, its fibres are arranged somewhat loosely together, and are not enclosed in any dense and compact neurilemma, so that it is larger here than at the lower part of the neck; and when the cellular tissue surrounding it is removed, the outline of the superficial fibres can be readily traced. About half an inch below the lower edge of the superior ganglion it enlarges still more, forming an oblong rounded swelling, from nine lines to an inch in length, and extending from about the transverse process of the atlas to midway between the transverse processes of the second and third cervical vertebræ (*plexus gangliiformis nervi vagi, ganglion secundum n. v. of Wutzer, ganglion trunci n. v. of Bendz, ganglion inferius n. v.*) In the human species, though this swelling has a greyish colour, yet its appearance is that of a plexus more than of a true ganglion; and Valentin states* that he has not yet obtained satisfactory evidence that it contains the ganglionic nucleated globules without the presence of which there can be no true ganglion, and he believes that the greyish

* In many of the Mammalia this swelling is more circumscribed and less elongated than in the human species, and forms a very distinct and true ganglion. Bischoff (oper. cit. tab. ii.) has given representations of it in the cat, fox, sow, mole, and weasel; and Mr. E. Cook, (Guy's Hospital Reports, vol. ii. p. 311,) in the guinea-pig, dog, and sheep. In all these animals it occupies that part of the trunk of the vagus from which the superior laryngeal nerve arises.

* Krause (Handbuch der Menschlichen Anatomie, S. 1053 & 1063. Hannover, 1842) states that probably these strengthening filaments of the vagus furnish the cardiac branch of the descendens noni.

appearance of this swelling depends upon fat globules placed in the intervals of the plexus. At the lower part of this gangliform enlargement the nerve becomes smaller, rounder, firmer, and of a whiter colour.* This inferior or second ganglion of the vagus has been long known. Fallopius† speaks of an oblong olivary swelling on the vagus soon after its exit from the cranium. Willis‡ has described it in the following words: "nervi truncus, ibidem major factus, in tumorem quemdam corpori calloso, seu ganglio similem, attolli atque excrescere videtur," and in fig. ix. he has delineated it under the name of "plexus gangliformis paris vagi." Viuessens§ also describes and figures it, and terms it "plexus gangliformis cervicalis nervi octavi paris." Winslow|| describes it as "une espece de ganglion." It has also been described by Prochaska,¶ Wutzer, Scarpa, Bellingeri, &c. Some have considered it to be a true ganglion, others only a plexus. Some restrict the term of inferior ganglion to that portion of the enlargement of the nerve immediately below the origin of the superior laryngeal nerve, and have described it as being placed upon the internal fibres only, so that, according to this view, some of the external fibres of the vagus and the strengthening fibres of the spinal accessory do not pass through it.

The vagus in its passage down the neck gives off *pharyngeal, laryngeal, œsophageal, cardiac, and vascular* branches.

Superior pharyngeal branch (ramus pharyngeus seu primus n. v.)—This is by much the largest and most important pharyngeal branch of the vagus, and is frequently designated, *par excellence*, the pharyngeal branch of the vagus. It arises from the anterior surface of the vagus shortly after its exit from the foramen lacerum, and opposite the upper part of the atlas, and is evidently formed by fibres, partly from the internal branch of the accessory, and partly from the vagus. Generally the greater part of its filaments, occasionally nearly the whole, appear to come from the accessory. It passes inwards and a little downwards across the anterior surface of the internal carotid artery, to which it is generally pretty closely connected by cellular tissue, and lies a little inferior to the glosso-pharyngeal nerve.** Immediately after crossing the internal carotid, it passes over the ascending pharyngeal artery, and after a short course

it reaches the surface of the middle constrictor muscle of the pharynx. As it is crossing the carotid it is generally joined by one, two, or three small branches descending from the glosso-pharyngeal, and at the point of their junction a small plexus or ganglion is formed on the pharyngeal. (Vide article GLOSSO-PHARYNGEAL NERVE.) At this point the pharyngeal generally divides into several branches.* Two of these are considerably larger than the others, and one of them passes inwards and upwards, and the other inwards and downwards over the lateral surface of the pharynx; while the smaller branches, two or more in number, pass upon the surface of the internal carotid and neighbouring bloodvessels, especially the arteria pharyngea ascendens, to assist in forming the nervous plexuses surrounding them. The two larger branches which pass upon the surface of the pharynx are soon joined by branches from the superior ganglion of the sympathetic. The upper branch passes over the superior pharyngeal constrictor to its upper edge, sending filaments to that muscle, to the elevator palati, the palato-pharyngeus, the azygos uvulæ, and also to the stylo-pharyngeus, and anastomoses freely with the pharyngeal and tonsillitic branches of the glosso-pharyngeal nerve and twigs of the sympathetic coming from its superior cervical ganglion. The lower runs downwards over the surface of the middle and inferior constrictors, distributes twigs to these muscles, and anastomoses with the *inferior pharyngeal* branch of the vagus, the pharyngeal branches of the superior laryngeal, and with some filaments of the sympathetic.

Inferior pharyngeal branch (ramus pharyngeus inferior).—This branch arises a very little below the last, and runs parallel to it and across the anterior surface of the internal carotid. It is joined by a considerable branch from the superior ganglion of the sympathetic, which generally forms an arch with it around the ascending pharyngeal artery. It soon divides itself into different branches, which are distributed upon the lower part of the middle constrictor muscle, and over the whole of the inferior constrictor, and anastomoses with the twigs of the other nerves found on the surface of these muscles.

Valentin describes under the name of *middle pharyngeal nerves (rami pharyngei medii seu tenuiores n. v.)* some small filaments arising from the anterior surface of the vagus immediately below the superior pharyngeal, and which pass forwards to join the pharyngeal branches of the glosso-pharyngeal. The free anastomosis of the nerves we have mentioned, viz. the glosso-pharyngeal and sympathetic, with the numerous subdivisions of the pharyngeal branches of the vagus, intermixed with a few twigs from the superior laryngeal, and also with some small filaments from the upper part of the cervical plexus of nerves, and an occasional twig from the hypo-glossal, form an elongated and intricate plexus (plexus pharyn-

* Oper. cit. S. 484.

† Opera omnia, p. 407. Francof. 1600.

‡ Cerebri Anatome, p. 226. 1666.

§ Neurographia Universalis, p. 118, and pl. xxiii. Edit. Novissima. Lugduni, 1716.

|| Exposition Anatomique de la Structure du Corps Humain, tom. iii. p. 237. Paris, 1732.

¶ De Structura Nervorum, 1779.

** Cruveilhier (Anatomie Descriptive, tom. iv. p. 958, 1836,) describes the pharyngeal branch as passing behind (derrière) and not in front of the internal carotid. Cloquet (Traité d'Anatomie Descriptive, 2de partie, p. 620,) also described it as passing behind the internal carotid. No doubt this nerve may occasionally pass behind the artery, and similar varieties are to be found in the course of all nerves; but it is equally certain that its usual course is in front of the artery, and this inaccuracy must have occurred through some inadvertency.

* Wrisberg (De Nervis Pharyngis, Ludwig's Script. Min. Nerv. Sel. tom. iii. p. 53) describes five branches radiating from the ganglion pharyngeum.

geus) upon the lateral surface of the pharynx. (See article GLOSS-PHARYNGEAL NERVE.)

Superior laryngeal branch (ramus laryngeus superior) arises from the inner side of the vagus, about four or five lines below the superior pharyngeal branch, and from the upper and inner part of the *second* or *inferior* ganglion. It is considerably larger than the pharyngeal branch, and in the first part of its course proceeds almost directly inwards, then inwards and downwards, passing behind the internal carotid and in front of the longus colli muscle.* While it is behind the carotid it generally divides into its two branches, the *internal* and *external*. The internal is much the larger and more important, crosses the lateral part of the middle constrictor of the pharynx obliquely downwards, forwards, and inwards, joins itself to the laryngeal branch of the superior thyroid artery and runs along its upper edge, passes between the lower margin of the os hyoides and upper margin of the thyroid cartilage, and reaches the upper edge of the larynx by perforating the thyro-hyoid ligament posterior to the external edge of the thyro-hyoid muscle, above the upper edge of the inferior constrictor and below the lower edge of the middle constrictor of the pharynx, and a little in front of the round ligament connecting the superior cornu of the thyroid cartilage to the larger cornu of the hyoid bone. Sometimes one or two small twigs pass between the trunk of the vagus and the superior laryngeal soon after the origin of the latter, and the external branch of the superior laryngeal occasionally comes directly from the trunk of the vagus, a little below the origin of the internal branch. While the superior laryngeal nerve is passing behind the internal carotid, it sends off several small twigs, some of which communicate with the pharyngeal plexus, a few pass downwards and throw themselves into some of the cardiac nerves, and the greater part run upon the surface of the internal and external carotids, and assist in forming, with the more numerous branches from the sympathetic, the arterial plexus of nerves winding round the carotid arteries and their branches.

External branch of the superior laryngeal. It is strengthened by some twigs from the superior ganglion of the sympathetic, passes downwards and forwards over the inferior constrictor muscle of the pharynx and lateral surface of the larynx, gets below the outer edge of the sterno-thyroid, and continues its course below it and the thyro-hyoid muscle. It gives some twigs to the inferior constrictor muscle, some filaments also to the upper part of the sterno-hyoid and thyroid muscles, and to the thyroid body. The continuation of the nerve after sending a twig downwards to anastomose with another twig from the inferior laryngeal nerve behind the thyroid body, ultimately terminates in the crico-thyroid muscle.†

* The superior laryngeal nerve rarely passes in front of the internal carotid.

† A small twig from the external branch of the superior laryngeal perforates the thyroid cartilage occasionally, and anastomoses with some of the

Internal branch of the superior laryngeal. As soon as this branch has perforated the thyro-hyoid ligament and reached the outer surface of the mucous membrane immediately beneath it, it divides into numerous branches which are flattened and radiating, some passing upwards and forwards towards the base of the tongue and sides of the epiglottis, others forwards, downwards, and inwards in the aryteno-epiglottidean folds to the surfaces of the epiglottis, and others downwards upon the posterior surface of the larynx. The branches which proceed forwards and upwards are small and pass onwards to the glosso-epiglottidean folds; and while some of their filaments terminate in these folds and in the mucous membrane at the lateral and back part of the tongue, others turn inwards and are distributed upon the submucous glands and the mucous covering of the anterior and upper part of the epiglottis. Several pretty strong branches pass forwards and inwards in the aryteno-epiglottidean folds to the side of the epiglottis. Some of these proceed upon its anterior surface and are there distributed upon the mucous membrane and the submucous glands, sending also a few filaments through small apertures in the epiglottis to be ramified in the mucous membrane on its posterior or laryngeal surface; while other branches pass upon the posterior aspect of the epiglottis,—some of them occupying notches on its outer edge,—and are distributed upon the submucous glands and mucous membrane covering that surface. A few branches proceed downwards and forwards over the outer surface of the lining mucous membrane of the larynx, send some filaments to the laryngeal sac, and may be traced as far as the inferior or true vocal chords. A long slender branch passes downwards on the outer surface of the thyro-arytenoid muscle, and between it and the inner surface of the thyroid cartilage, and frequently anastomoses with an ascending branch of the recurrent or inferior laryngeal. One or two slender filaments enter the thyro-arytenoid muscle, and these, after a long and winding course among the fibres of that muscle and those of the crico-arytenoideus lateralis, ultimately run to the mucous membrane of the larynx. A pretty large branch runs backwards in the posterior part of the thyro-arytenoid fold of mucous membrane, transmitting at the same time a few filaments downwards; and on reaching the arytenoid cartilage it sends several filaments upon the posterior surface of the proper arytenoid muscles, and continuing its course downwards between the mucous membrane of the pharynx and the crico-arytenoideus posticus muscle, it anastomoses with one of the posterior ascending branches of the recurrent. The greater part of the filaments which enter among the fibres of the arytenoideus posticus and transversus muscles may be traced to the mucous membrane of the larynx, and only a very few appear to terminate among the muscular fibres; others anastomose with arytenoid

descending branches of the internal branch of the same nerve.

branches of the superior laryngeal of the opposite side, and with the arytenoid branch of the recurrent; and occasionally a filament perforates the arytenoid cartilage to reach the inner surface of the larynx.

Vascular and cardiac branches.—The vagus in its passage along the neck sends off directly from its trunk several filaments, which throw themselves into the arterial nervous plexuses surrounding the carotid arteries and their branches; and also others which pass downwards and join themselves, either directly or indirectly, to the cardiac plexus. These branches are very variable in their number, size, and origin, so that it is impossible to give any description of them which will be found generally applicable, and they commonly differ on the two sides in the same individual.

Vascular branches (rami vasculares).—Several small branches arise from the trunk of the vagus between the origin of the superior laryngeal nerve, and about a line or so below the level of the bifurcation of the common carotid, and chiefly pass upon the carotid arteries and their branches. Valentin* has divided these into—

1. *Rami carotici*, consisting of two or three larger and some smaller twigs, coming off from the vagus near the origin of the superior laryngeal and also from the commencement of the superior laryngeal. They run inwards and forwards upon the internal carotid.

2. *Ramus ad divisionem arteriæ carotidis* is principally distributed upon the common carotid at its bifurcation.

3. *Rami vasculares posteriores et interni* are generally three in number, come from that part of the trunk of the vagus on a level with the bifurcation of the common carotid, and run principally, as their name implies, to the nervous plexus on the posterior and inner part of the large neighbouring arteries.

4. *Rami vasculares anteriores et interni* spring from the trunk of the vagus a very little below the origin of the last, run to the outer side of the common carotid, and assist with some of the other branches of the vagus and sympathetic in forming a nervous network on the outer and anterior side of this artery, while one or more twigs proceed downwards to join the superior cardiac nerve of the vagus.

Cardiac nerves.—Two or three cardiac branches come from the inner side of the vagus at some little distance from each other; the upper of these generally arises a little below the bifurcation of the common carotid. These branches proceed downwards and inwards, communicate freely with each other, send some filaments upon the surface of the common carotid artery, anastomose freely with the cardiac branches of the superior and middle cervical ganglia of the sympathetic and with the recurrent, pass chiefly in front of the large arteries at the root of the neck, and terminate in the upper part of the cardiac plexus of nerves. Frequently, more especially when the upper cardiac branches are small, or when some of them are want-

ing, we find a pretty large cardiac branch arising from the vagus about the upper part of the lower third of the neck, and passing downwards, on the right side in front of the subclavian, on the left in front of the arch of the aorta, it throws itself into the upper part of the cardiac plexus. Two or more branches also leave the trunk of the vagus as it passes the subclavian on the right and the arch of the aorta on the left side, pass inwards and throw themselves partly into the cardiac plexus and partly into the anterior bronchial plexus.

Inferior laryngeal or recurrent branch.—(*Ramus laryngeus inferior seu recurrens.*) On the right side the recurrent arises from the vagus as it is passing over the anterior surface of the subclavian artery, while on the left side it is sent off from the vagus, generally from its inner side, as it is crossing the anterior surface of the transverse portion of the arch of the aorta. On the right side it hooks round the subclavian on the inner side of the scalenus anticus muscle, and passing upwards and inwards, first below the subclavian artery and then below the common carotid, it reaches the right side of the trachea. On the left side it hooks round the arch of the aorta and obliterated ductus arteriosus, and passing upwards and inwards below the aorta, the left subclavian at its origin, and the left common carotid, it reaches the left side of the trachea. The recurrent soon after its origin generally receives one or two additional twigs from the trunk of the vagus. Immediately after it leaves the trunk of the vagus, it anastomoses freely with branches of the sympathetic, chiefly with the internal branches of the two inferior cervical and first dorsal ganglia of the sympathetic,—and while the right sends some twigs upon the outer surface of the subclavian artery, the left sends some upon the surface of the aorta. It also throws several twigs into the cardiac, tracheal, and bronchial plexuses. The left sends some twigs to the tracheal plexus, while the corresponding twigs of the right side come from the trunk of the vagus. The two recurrens then proceed upwards along the sides of the trachea towards the larynx,—the left resting upon the anterior surface of the œsophagus,—and are both covered by the sterno-hyoid and sterno-thyroid muscles. In this part of the course of the recurrent it generally receives communicating twigs from the cardiac branches of the superior and middle cervical and sympathetic ganglia, and it also anastomoses with some of the upper cervical cardiac branches of the vagus. It also sends several twigs to the œsophagus and trachea, (*œsophageal and tracheal twigs of the recurrent,*) some of which perforate the fibrous membrane between the cartilaginous rings of the trachea, and reach its mucous surface, while others are distributed among the muscular fibres which complete the cartilaginous rings behind. As it approaches the larynx it sends a twig upwards and forwards, which anastomoses with a descending twig of the external branch of the superior laryngeal; and it gives some filaments to the thyroid body, to the mucous membrane of the lower part of

* Op. cit.

the pharynx, to the inferior constrictor of the pharynx, and also occasionally one or two slender filaments to the crico-thyroid muscle. It likewise sends a branch upwards over the posterior surface of the larynx, first passing between the œsophagus and back part of the trachea, and then beneath the mucous membrane of the anterior part of the pharynx and crico-arytenoideus posticus muscle, sending some filaments to the œsophagus and mucous membrane of the pharynx, and anastomosing with the posterior descending twig of the *internal branch* of the superior laryngeal. The trunk of the recurrent now passes upwards in front of the lower edge of the inferior constrictor muscle, gets into the sulcus on the posterior surface of the articulation between the lower cornu of the thyroid cartilage and the external surface of the cricoid cartilage, and then passes along the outer edge of the crico-arytenoideus posticus upon the external surface of the crico-arytenoideus lateralis and thyro-arytenoid muscles, where it terminates. In its course along the side of the larynx it generally sends a twig upwards to anastomose with one of the descending twigs of the *internal branch* of the superior laryngeal. As it is passing the crico-arytenoideus posticus it sends some twigs into the external edge of that muscle, all of which enter among its fibres except one. This last twig, which does not enter among the fibres of the muscle, runs beneath its outer edge, and proceeding upwards and inwards between its anterior surface and the posterior surface of the cricoid cartilage, it reaches the lower edge of the arytenoideus obliquus and transversus, and is lost among their fibres. As the *continuation* of the *recurrent* passes over the surface of the cricoid-arytenoideus lateralis, it sends some filaments inwards among the fibres of this muscle, and then proceeds upwards upon the thyro-arytenoid, into the interior of which it dips. Its terminating filaments are distributed in the thyro-arytenoid muscle, and a few only can be traced to the lining membrane of the larynx. We have thus seen, that while nearly all the filaments of the *internal branch* of the superior laryngeal, distributed to the larynx, ultimately run to its mucous surface, the greater part of the filaments of the *recurrent* are distributed in the muscles which are attached to and move the arytenoid cartilages.

The peculiarity in the course of the inferior laryngeal from which it derives its name of *recurrent*, depends upon the changes in the relative position of the branchial arteries to the larynx in the embryo, after they have assumed the form presented in the adult by the arch of the aorta and the large vessels which spring from it. In those cases where the right subclavian artery, instead of arising along with the right carotid by a common trunk (*arteria inominata*), comes off from the arch of the aorta beyond the origin of the left subclavian, or, in other words, is the last in order of the large arteries which supply the head and thoracic extremities, and then proceeds across the spine behind the œsophagus to reach its usual position behind the scalenus anticus muscle on the right side, the recurrent

does not arch round the right subclavian, but is given off from the trunk of the vagus as it is passing the larynx.*

Course of the vagus through the thorax.—After the *right vagus* has given off the recurrent, it passes behind the ascending portion of the arch of the aorta, and proceeding downwards, inwards, and backwards behind the right bronchus, right pulmonary artery and veins, reaches the œsophagus as it lies in the posterior mediastinum. The *left vagus*, after passing from the anterior surface of the arch of the aorta, also proceeds downwards, inwards, and backwards behind the left bronchus, left pulmonary artery and veins, and also reaches the œsophagus in the posterior mediastinum at the same part where the right vagus joins it. Both nerves closely accompany the œsophagus down the posterior mediastinum, and pass from the thorax into the upper part of the abdomen through the same opening (œsophageal opening) in the diaphragm. At the upper part of the chest, the vagi become flattened from before backwards, and are consequently broader and thinner than in the neck.

Immediately after the vagus has given off the recurrent it sends numerous twigs inwards. Some of these pass upwards and inwards to assist in forming the cardiac plexus; some proceed transversely inwards upon the anterior surface of the lower part of the trachea, and anastomose with other branches from the vagus arising higher up, and also with branches from the recurrent and sympathetic to form the anterior and inferior tracheal plexus (plexus trachealis anterior et inferior); while others pass upon the posterior surface of the lower part of the trachea, anastomose with other branches from the recurrent and sympathetic, and thus form the posterior and inferior tracheal plexus. The vagus at this part also sends a few twigs upon the upper part of the thoracic portion of the œsophagus, forming a free anastomosis on its surface with other twigs from the recurrent and the posterior bronchial plexus (plexus œsophagei thoracici superior). It likewise sends some branches inwards and downwards to throw themselves into the lateral portion of the lower part of the cardiac plexus; while a few others pass still more downwards to reach the anterior

* Two cases of this variety, in the origin and course of the inferior laryngeal nerve and right subclavian artery, are recorded by Dr. Siedman (Edin. Med. and Surg. Journal for 1823, p. 564) and Dr. Hart (in same Journal, 25th vol. 1826). I have myself had an opportunity of examining two cases of this kind. In those cases of double monstrosity where the head and larynx are double, and the two bodies are fused together immediately below this, so that the lower part of the neck, the thorax, and thoracic extremities are single, and where consequently we have four vagi nerves in the upper part of the neck, and only two at the lower part, the right recurrent of the right larynx hooks round the subclavian artery, and the left recurrent of the left larynx hooks round the arch of the aorta, while the other two vagi, or the left recurrent of the right larynx, and the right recurrent of the left, give off their superior laryngeal branches as they pass the larynges. I had an opportunity of dissecting one case of this kind.

surface of the pulmonary veins and branches of the trunk of the pulmonary artery, and anastomose with branches from the inferior part of the cardiac plexus prolonged upon these vessels. Other branches proceed downwards and inwards upon the anterior surface of the bronchii, and anastomose with the descending branches of the anterior and inferior tracheal plexus, with the nervous filaments accompanying the pulmonary bloodvessels, and with some branches direct from the sympathetic to form the anterior pulmonary plexus (plexus pulmonalis anterior). A few twigs also proceed from this portion of the vagus into the anterior mediastinum, and are chiefly distributed in the thymus gland. As the trunk of the vagus passes behind the bronchus it sends off several pretty large branches upon the posterior surface of that tube, and also a few smaller ones upon the posterior surface of the pulmonary bloodvessels. These branches form a great part of the posterior pulmonary plexus (plexus pulmonalis posterior), and anastomose with twigs from the posterior and inferior bronchial, with some filaments from the superior thoracic œsophageal and the anterior pulmonary plexuses. The branches of the pulmonary plexuses, after sending off some nervous filaments which run for some distance below the pleura, (vide Reisseisen De Fabrica Pulmonum, 1822, tab. vi. plate 2,) accompany the bronchial tubes and bloodvessels into the interior of the lungs, and follow the divisions and subdivisions of the bronchial tubes. The two trunks of the vagi, after leaving the lower edge of the bronchi, soon reach the œsophagus, where each nerve divides into three or four chords upon the surface of the œsophagus; those formed by the subdivisions of the left vagus lying on its anterior and left side, those by the right vagus on its posterior and right side. The chords of the same nerve anastomose freely by large branches, and also by smaller and less numerous branches on both sides of the œsophagus, with those of the opposite nerve, and thus form an extensive and open network upon the surface of the œsophagus, called the inferior œsophageal plexus (plexus œsophageus thoracis inferior).* From these chords nervous filaments pass into the walls of the œsophagus, and they also exchange some communicating filaments with the sympathetic. Immediately before the vagi pass through the œsophageal opening of the diaphragm, the chords into which each nerve has divided again reunite; those of the left nerve collecting into one trunk, while those of the right frequently form two branches which run close to each other.† As they pass through the œsophageal opening, the right nerve, or the larger, is placed on the

posterior surface of the œsophagus, and the left, or the smaller, on its anterior surface.*

Distribution of the vagus in the abdomen.

Left vagus.—As it enters the abdomen it sends some small branches upon the anterior surface of the lower part of the œsophagus, some of which enter the walls of that tube, others anastomose with œsophageal twigs from the right vagus, and others are prolonged downwards upon the cardiac end of the stomach. As it proceeds downwards over the cardiac surface of the stomach it also passes towards the right side and forms a curve, the convexity of which looks to the left. From the convexity of this curve several small branches run across the anterior surface of the cardiac orifice and the upper part of the large *cul de sac* of the stomach, and some of these anastomose with filaments from the left portion of the solar plexus, and from the phrenic nerve.‡ From the concavity several small branches run upwards and to the right between the layers of the smaller omentum to join the left hepatic plexus.‡ The left vagus now divides itself into several branches, which pass towards the pyloric surface of the stomach, along the upper edge of the anterior surface of the stomach, very close to the smaller curvature of that organ, and along the lower edge of the coronary artery of the stomach, sending numerous filaments into the nervous plexuses of the sympathetic surrounding the coronary and superior pyloric arteries, and also branches downwards over the anterior surface of the stomach. These latter branches, after running a greater or less distance below the peritoneal covering of the stomach, penetrate the muscular coat where some of their filaments terminate, while others pass through it to reach the mucous coat. The few branches of the left vagus which reach the pyloric orifice are partly distributed upon the walls of that portion of the organ, and partly throw themselves into the celiac plexus. Some of the filaments of the latter portion may be traced into the numerous plexuses surrounding the gastro-duodenalis branch of the hepatic artery, into the right hepatic plexus, and may sometimes be followed as far as the artery of the gall-bladder. The branches which leave the left vagus as it lies on the anterior surface of the lower part of the œsophagus, and cross the anterior surface of the cardiac orifice of the stomach, divide and subdivide below the peritoneum in a forked manner, and also anastomose freely with each other, forming a kind of plexus which has been termed the anterior cardiac plexus of the stomach. As the branches of the left vagus pass along the smaller curvature of the stomach, they not only anastomose freely with the plexuses of the superior coronary and superior pyloric arteries, but with each other, forming a plexus along the upper edge of the anterior surface of the stomach, stretching from the cardiac to the pyloric orifice,

* Some anatomists call that part of the plexus formed by the left vagus the *left œsophageal plexus*, and that formed by the right vagus the *right œsophageal plexus*.

† Wrisberg (Ludwig's Scrip. Nerv. Min. Select. tom. iv. p. 59) says, that he has seen the nervous chords of both vagi unite into a single trunk on the œsophagus, which again divided itself into two branches (right and left vagi) before passing through the diaphragm.

* Wrisberg (opus cit.) states, that the vagi send a few filaments to the diaphragm.

‡ Valentini, oper. cit. s. 500.

‡ Vide Swan's Demonstrations of the Nerves of the Human Body, plate viii. 1830.

which Valentin* has termed plexus gastricus anterior et superior.

Right vagus.—As the right vagus is entering the abdomen it sends numerous branches upon the posterior part of the termination of the œsophagus and of the cardiac extremity of the stomach. Part of these disappear in the muscular fibres of the œsophagus and stomach; others anastomose with the branches of the left vagus, while others proceed downwards and to the left side upon the posterior surface of the large cul-de-sac of the stomach, sending filaments into the muscular coat, and also anastomosing with the filaments of the splenic plexus accompanying the vasa brevia. The right vagus also sends some branches upon the posterior surface of the stomach, to be distributed in that part of the organ, a few of which proceed as far as the large curvature, and course along it from left to right. It also sends two or three branches along the smaller curvature, which anastomose with the coronary plexus and branches of the left vagus. A considerable portion of the right vagus,—so large as generally to present the appearance of being the continuation of the trunk of the nerve,—proceeds from the posterior surface of the cardiac region of the stomach, backwards and downwards to the left side of the cœliac axis, sending branches to the splenic, the coronary, and to the superior mesenteric plexuses, to the plexus surrounding the pancreatic branches of the splenic artery; and it ultimately terminates in the left semilunar ganglion. The branches of the right vagus running upon the posterior surface of the lower part of the œsophagus and cardiac orifice of the stomach have been termed the posterior cardiac plexus.† Dr. Remak has discovered numerous small ganglia upon the filaments of the cardiac nerves, as they are ramified upon the surface of the heart;‡ also upon some of the filaments of the pulmonary plexus, and upon some of the finer branches of the superior laryngeal nerve.§ These ganglia can scarcely be seen by the naked eye, and it is only when examined by the microscope that we can satisfactorily determine their nature. These ganglia appear to be placed upon the filaments of the sympathetic, conjoined with the branches of the vagi, and not upon those of the vagi.

According to Volkmann and Bidder the vagus nerve contains, in all vertebrated animals, a greater number of sympathetic than cerebro-spinal filaments; and this preponderance of the sympathetic over the cerebro-spinal is more marked in the lower than in the higher vertebrata. This remark is in conformity with the observations of E. H. Weber upon the relative size of the vagus and sympathetic in the different families of the vertebrata, from which it appears that in the lower vertebrata the vagus

increases, the sympathetic diminishes, in size. The branches of the vagus distributed in the œsophagus, heart, lungs, stomach, liver, and gills, are chiefly composed of sympathetic filaments, while the recurrent one of the motor branches is chiefly composed of cerebro-spinal filaments.*

Connection of the vagus and spinal accessory. We have seen that, as the vagus and accessory emerge from the foramen lacerum posterius, the internal branch of the accessory joins itself to the vagus, and that while part of its filaments go to assist in forming the superior pharyngeal branch of the vagus, the rest proceed downwards with the trunk of the vagus, and become incorporated with it. Bischoff states† that he has not been able to trace the filaments of the accessory into any of the branches of the vagus except the pharyngeal, while Bendz‡ has been more successful. He states that the portion of the accessory which accompanies the vagus down the neck sends a few filaments to the upper part of the inferior ganglion of the vagus, and then joins itself to some of the posterior and external fibres of the vagus which do not pass through the ganglion. Below the ganglion these fibres form part of the trunk of the nerve, being enclosed in the same neurilema with those which pass through the ganglion. At the lower edge of the ganglion, or sometimes a little lower, the accessory portion sends off some filaments which often join the external branch of the superior laryngeal, but more frequently give twigs to the sterno-thyroid muscle. Other fibres of the accessory portion accompany the vagus into the thorax, and some of them assist in forming the recurrent nerve. Some small twigs from the accessory join the pulmonary and cardiac plexuses; the remainder accompany the vagus to the stomach, where they are lost. Mr. Spence states that those fibres of the vagus which do not pass through the superior ganglion are joined by the internal branch of the accessory; and that these together form a small flat band, which may be traced among the other fibres of the vagus to the lower part of the neck, where it is joined by some of the other fibres of the vagus which have passed through the ganglion, and seems to go principally to the formation of the recurrent nerve.

We have seen that the vagi are distributed over a large space and upon many organs. They send branches to the external ear, to the pharynx, the larynx, the œsophagus, the trachea, the thyroid body, the heart, the lungs, the stomach; also to the liver, the spleen, the pancreas, the small intestines, and probably to other viscera of the abdomen. In their course they communicate very freely and extensively with the sympathetic,§ and to a greater or less

* Opus cit. S. 503.

† Many anatomists describe the branches given off by both vagi near the cardiac orifice of the stomach as forming a single cardiac plexus, the larger portion of which is formed by the right vagus.

‡ Casper's Wochenschrift für die gesammte Heilkunde den 9ten März, 1839.

§ Medicinische Zeitung. Berlin, 8 Jan. 1840.

* Die Selbstständigkeit des Sympathischen Nervensystems, by Bidder and Volkmann. Also the article Nervenphysiologie in Wagner's Handwörterbuch der Physiologie, p. 584.

† Oper. cit. p. 25.

‡ Oper. cit. p. 20, 21, 23.

§ In many of the mammalia the cervical portion of the sympathetic joins the trunk of the vagus immediately below the inferior ganglion of the vagus.

extent with several of the other cerebro-spinal nerves, as the spinal accessory, the glosso-pharyngeal, the hypo-glossal, the portio dura, the two superior cervical, and sometimes with some of the lower cervicals. The vagi are very extensively ramified upon the internal tegumentary membrane, as the mucous membrane of the pharynx, larynx, œsophagus, stomach, trachea, and lungs, and send only one small branch, viz. the ramus auricularis, to the external tegumentary membrane. Many of its branches are distributed upon the muscular fibres surrounding the upper part of the digestive and respiratory tubes.

Physiology of the nervus vagus.—From the distribution of this nerve in so many of the most important organs in the body which it is impossible to insulate, or prevent their mutual actions and reactions upon each other, and from its numerous and intimate connections with several other nerves, investigations into its physiology are beset with unusual difficulties. As, however, its lesions are attended by the most serious derangements of the respiratory and digestive organs, and as a knowledge of its functions bears in a prominent manner upon many interesting questions both in special and general physiology, it has naturally attracted the frequent attention of the physiologist, and has been made the subject of numerous experimental investigations.

Do the roots of the vagus contain any motor filaments?—No one can for a moment doubt that the trunk of the vagus, in its course down the neck, does contain motor filaments, but there is every reason to believe that it derives at least the greater part of these from the spinal accessory. From the resemblance of the vagus and spinal accessory as they lie in the foramen lacerum posterius to the anterior and posterior roots of a spinal nerve,—the vagus with its superior ganglion corresponding to the posterior, and the spinal accessory to the anterior root,—many anatomists and physiologists have of late maintained that the roots of the vagus, like the posterior roots of the spinal nerve, contain no motiferous filaments. It is scarcely necessary to add, that the junction of the *internal branch* of the accessory and the vagus immediately beyond the superior ganglion of the latter, increases still further this resemblance between these and a spinal nerve. This opinion has been maintained on anatomical considerations alone, by Arnold, Scarpa, and Bendz,* and has been further strengthened by the experiments of Bischoff,† Valentini,‡ and Longet.§

* *Tractatus de Connexu inter Nervum Vagum et Accessorium Willisii*, Hauniae, 1836. According to Müller, this idea of the resemblance of the anatomical arrangement of the vagus and accessory to a spinal nerve had previously suggested itself to Görres in his *Exposition der Physiologie*, 1809.

† *Nervi Accessorii Willisii Anat. et Phys.* 1832. Bischoff, however, has more lately satisfied himself by experiment that the root of the vagus does contain motor filaments.

‡ *De Functionibus Nerv. Cereb. et Nerv. Sympath.* Caput xi. Bernæ, 1839.

§ *Recherches Experimentales sur les Fonctions des Nerfs, des Muscles du Larynx, &c.* p. 31, Paris,

It is on the other hand maintained, that this opinion is too exclusive, and that, though there can be no doubt of the greater part of the filaments of the roots of the vagus being incident and sensiferous, yet they do contain some motiferous filaments. We have seen that, probably both in man and in some of the other mammalia, a few of the filaments of the vagus do not pass through its superior ganglion, and consequently the anatomical argument is not so conclusive as it at first appears to be. An examination of the experimental proof adduced in favour of these two opinions shews that the former is chiefly founded upon negative, and the latter upon positive evidence. Müller** saw muscular movements of the pharynx follow excitation of the roots of the vagus within the cranium; but from having neglected some precautions in the performance of the experiment, he himself is not disposed to attach to it much weight. I have related some experiments in which I observed muscular movements in the pharynx, larynx, and œsophagus, from irritation of the vagus within the cranium, on the dog immediately after death.† Volkmann has performed similar experiments upon calves, sheep, goats, and cats, and perceived muscular contractions in the levator palati, azygos uvulæ, the superior and inferior constrictor muscles of the pharynx, the palato-pharyngeus, and cricothyroid.‡ The experiments of Stilling,§ Wagner,|| Van Kempen,¶ Hein,** and Bernard†† are also all in favour of the opinion that the root of the vagus contains motor filaments.

1841, and *Anatomie et Physiologie du Système Nerveux*, &c. tom. ii. p. 262. Paris, 1842.

* *Elements of Physiology*, translated by Baly, pp. 703-4. Second edition.

† *Edinburgh Medical and Surgical Journal*, 1838.

‡ Müller's Archives, p. 493, for 1840. Volkmann expressly states that these muscular contractions were also observed on irritating the vagus within the cranium in the calf, though in that animal all the filaments of the vagus appeared to him to pass through its superior ganglion.

§ Stilling states that he saw movements of the pharynx, the glottis, and the stomach in two cats, on exciting the roots of the vagus within the cranium. Vide Bischoff's Bericht über die Fortschritte der Physiologie in Jahre 1842, in Müller's Archives for 1843. Heft vi. p. 154.

|| *Lehrbuch der Physiologie. Dritte Abtheilung*, S. 329. Leipzig, 1842.

¶ Van Kempen observed contractions of the constrictors of the pharynx, the palato-glossus, the œsophagus, and the interior muscles of the larynx. *Essai Experimental sur la Nature fonctionnelle du Nerf-pneumogastrique*, Louvain, 1842. Vide also Bischoff's Bericht, &c. supra cit. pp. 154-5. Bischoff states (p. 155) that he himself observed movements of the soft palate, in which the contractions of the levator palati muscle were very decided, on the irritation of the roots both of the vagus and of the accessory.

** Hein observed contractions in the levator palati, azygos uvulæ, and palato-pharyngeus, but in the last muscle less frequently than in the two former, on irritating the root of the vagus, and the same muscles were thrown into contraction by irritation of the root of the accessory. He also perceived contractions in the stylo-pharyngeus from irritation of the root of the glosso-pharyngeal nerve, as in the experiments of Mayo and Volkmann, Müller's Archives, Heft iii. 1844. S. 297.

†† *Archives Générales de Méd.* 1844.

We believe that we are justified in concluding from the evidence here adduced, that the vagus, even at its origin, and before it has received any fibres from the accessory, does contain a few motor filaments.*

We shall here make a few remarks upon the *immediate* effects of chemical and mechanical excitation of the trunk of the vagus as it lies in the neck, and then proceed to examine in detail the functions of its auricular, pharyngeal, laryngeal, œsophageal, cardiac, pulmonary, and gastric branches. When the trunk of the vagus has been exposed in the neck in a living animal, and is cut, bruised, or rendered suddenly tense by forcible stretching, the animal generally gives indications of severe suffering, while in some cases the animal remains quiescent, and, as far as we can judge, suffers little, if any.

There can be no doubt, from the distinct testimony of numerous experimenters,† that the trunk of the vagus does contain sensiferous filaments, but there are good grounds for believing that the application of chemical agencies or the infliction of mechanical injuries upon this nerve below the origin of its superior laryngeal branch, are not attended with the same amount of pain as would attend similar lesions of one of the ordinary spinal nerves. Dr. Marshall Hall and Mr. Broughton remarked, that when the compression of this nerve is continued "for a few moments, an act of *respiration and deglutition follows, with a tendency to struggle and cough.*"‡ Romberg observed excitation of the vagus in the neck in a horse produce cough;§ and it appears that Cruveilhier had made previously the same observation.|| In some of the cases in which I made this experiment on dogs, I observed powerful respiratory muscular movements, but never succeeded in inducing cough. Longet has been equally unsuccessful in producing cough by this means.¶ The respiratory muscular movements which follow excitation of the vagus in the neck are not dependent upon any

direct action transmitted downwards to the lungs or muscles of respiration, but upon a reflex action, as Dr. Marshall Hall pointed out, arising from certain impressions being carried upwards to the medulla oblongata by the incident fibres of the vagus, followed by the transmission of a motor influence outwards from this portion of the central organ of the nervous system along the motiferous nerves distributed in the muscles moved. The excitation and mechanical injury of the vagus in the neck induces various other results, some of which may be included among their *immediate* effects, such as those upon the movements of the intrinsic muscles of the larynx, the diminution of the frequency of the respirations, &c.; but these will be more methodically introduced among the remarks which we have to make upon the functions of the individual branches of the nerve.*

Auricular branch.—From the origin of this branch from the superior ganglion of the vagus, and from being partly distributed to the integuments of the pavilion of the external ear, it is probable that it is composed of sensiferous filaments. If the portion of this branch which throws itself into the portio dura be sensiferous, the portio dura may contain some sensiferous filaments as it issues from the stylo-mastoid foramen.†

Pharyngeal branches.—As a great part, sometimes nearly the whole, of the superior pharyngeal branch of the vagus comes directly from the internal branch of the spinal accessory, we may, on anatomical grounds alone, conclude that it contains motor filaments. In irritating this branch in dogs, both alive and immediately after death, we observed extensive movements of the muscles of the pharynx and soft palate without any distinct indications of pain. As, however, the animal must necessarily be sub-

* The opinion that the internal branch of the spinal accessory furnishes no motor filaments to the trunk of the vagus has been several times of late attributed to me. That this is a mistake, any one may satisfy himself by reading the account which I have given of these experiments, from which I drew the following conclusions. "That the internal branch of the spinal accessory assists in moving the muscles of the pharynx we are satisfied, not only from the experiments just stated, but also from those upon the pharyngeal branch of the *par vagum*. Of the probable destination and functions of the other filaments of the *internal* branch of the *accessory*, we cannot pretend to judge without more extended inquiries. We certainly do not consider that these experiments entitle us to assert that they are not motor filaments." Edinburgh Medical and Surgical Journal, vol. 173, 1838.

† We have elsewhere collected the statements of different authors on this point. (Edin. Med. & Surgical Journal for 1838-9.)

‡ Transactions of the British Scientific Association, vol. iv. p. 677.

§ Müller's Archives for 1838.

|| Nouv. Biblioth. Med. t. ii. p. 172, 1828, as quoted by Longet.

¶ Anatomie et Physiologie du Système Nerveux, &c. t. ii. p. 309.

* In some animals, as in the dog, the division or compression of the vagus in the neck is immediately followed by diminution of the pupil of the eye of that side, the protrusion of the cartilaginous membrane at the inner canthus over the inner part of the anterior surface of the eyeball, the retraction of the eyeball deeper into the socket, and a slight approximation of the eyelids; and subsequently by inflammation of the conjunctiva. Petit (Histoire de l'Académie Royale des Sciences, année 1727) was the first who observed these effects, and justly attributed them to injury of the sympathetic nerve. It is only in those animals in which the sympathetic joins itself to the vagus in the upper part of the neck, that the division or compression of the trunk of the vagus produces any change on the eye. Vide Edin. Med. and Surgical Journal, No. 140, for experiments on this subject by the author of this article, and Valentin's Traité de Functionibus Nerv. Cereb. &c. p. 109.

† Arnold believes that the sympathy occasionally observed between the external ear and the lungs may be owing to this auricular branch of the vagus. He refers to some cases, where the presence of hardened cerumen, of a bean, of a pea, and other foreign bodies in the cartilaginous tube of the external ear, has induced long-continued cough and even vomiting. (Bemerkungen über den Baue des Hirns und Rückenmarks, &c. S. 168. Zürich, 1838.) In some individuals coughing can readily be induced by irritating the inner surface of the meatus auditorius externus.

jected to considerable suffering before the nerve can be exposed, this result cannot be taken as a conclusive test that it contains no filaments of common sensation. We also found that division of this branch on both sides rendered the second stage of deglutition difficult, by paralysing the muscles of the pharynx. The morsels of food were forced through the now passive bag of the pharynx to the commencement of the œsophagus by the repeated efforts of the muscles of the tongue and those attached to the larynx and hyoid bone. From these facts, we concluded that the pharyngeal branches of the vagus are chiefly, perhaps entirely, composed of motiferous filaments, and that they convey outwards the motive influence by which the muscles of the pharynx and soft palate are excited to contraction in the reflex muscular movements of deglutition.* It is possible that they may also contain a few sensiferous and incident filaments. Valentin, on irritating these branches in different animals immediately after death, saw the pharynx contract in a marked manner through its whole length.†

Volkman states, as we have already had occasion to mention, that various muscles of the soft palate and pharynx were thrown into contraction on excitation of the vagus within the cranium.‡ He further observes, that he could not perceive any movements in the muscles of the pharynx or soft palate on irritating the spinal accessory within the cranium. This last result is certainly one which we would not expect, but the remarks we have to make upon it will be more appropriately introduced in the article SPINAL ACCESSORY NERVE.§ Longet observed very marked contractions in the pharynx on galvanizing the pharyngeal branch of the vagus in the horse and the dog.|| Though the experiments we have referred to, in illustration of the functions of the pharyngeal branches of the vagus, differ in some respects, they all agree in this, that extensive and active muscular movements of the pharynx may be produced by their excitation, and that they therefore contain many motor filaments. We have adduced some facts which would seem to shew that they contain few, if any, motor filaments.

Laryngeal branches.—When the *superior*

* Edin. Med. and Surg. Jour. 1838.

† De Functionibus Nerv. Cerebraliū, &c. p. 17, 1839.

‡ Volkman concludes, as we have already mentioned, from his experiments that the stylo-pharyngeus and middle constrictor muscle of the pharynx do not derive their motor filaments from the pharyngeal branch of the vagus, but from the glosso-pharyngeal. In the article GLOSSO-PHARYNGEAL, we have stated, that, when this nerve is insulated carefully from the neighbouring nerves, no direct muscular movements follow its excitation. Valentin (opus cit. p. 38) and Longet (opus cit. tom. ii. p. 223) have from these experiments arrived at the same conclusions as we have on this point.

§ We may merely state in the mean time that Longet (opus cit. tom. ii. p. 27) has drawn from his experiments the conclusion that the spinal accessory furnishes all the motor filaments of the muscles of the larynx.

|| Opus cit. tom. ii. p. 271.

laryngeal nerve is laid bare in a living animal and pinched with the forceps, the animal gives indications of severe suffering, while on repeating the same experiment on the inferior laryngeal the animal seldom gives any indication of suffering pain. When an opening is made into the trachea, and a probe introduced through it into the interior of that tube and passed upwards, it excites little or no uneasiness until it reaches the interior of the larynx, when violent paroxysms of coughing and signs of great uneasiness immediately follow. The division of the *inferior laryngeal* nerves has no effect in diminishing the severity of these paroxysms of coughing or in quieting the struggles of the animal, while they instantly cease on cutting across the *internal branch* of the *superior laryngeal nerves*. Before Magendie published his observations upon the functions of these nerves it appears to have been generally believed that the different intrinsic muscles of the larynx received motor filaments both from the superior and inferior laryngeal nerves. Magendie has, on the other hand, maintained that the *superior laryngeal* moves those muscles which shut the superior aperture of the larynx, and the inferior laryngeal those which open it, and he supposed that this view sufficiently explained the closure of the superior aperture of the larynx on the division of both inferior laryngeal.* We found that on applying different excitants to the *superior laryngeal* nerve before it gave off its *external branch* in several animals immediately after death, that the crico-thyroid muscle was thrown into powerful contraction and the cricoid approximated to the thyroid cartilage, while all the muscles attached to the arytenoid cartilages remained quiescent. On irritating the *inferior laryngeals* all the muscles attached to the arytenoid cartilages were thrown into contraction, and as the force of those muscles which close the superior aperture of the larynx preponderates over that of those which open it, the arytenoid cartilages were drawn forwards and inwards, and the superior aperture of the larynx was closed. By applying the excitation to the nerves for a short time and in rapid succession, the superior aperture of the larynx could be made to close and open alternately,—to close during the period of excitation and to open during the intervals,—and it was also remarked that the outward movement, or that of opening, was dependent upon the elasticity of the parts. The inferences from these results were strengthened by an examination of the anatomical distribution of the laryngeal nerves, and confirmed by experiments upon living animals.† From these and other facts related in the paper referred to, we arrived at the following conclusions. The *superior laryngeal* furnishes one only of the intrinsic muscles (the crico-thyroid) of the larynx with motor filaments, while it supplies nearly all the sensiferous and incident filaments of the larynx,

* Compendium of Physiology, pp. 132 and 399. Milligan's Translation, 4th ed. 1831. Leçons sur les Phénomènes Physiques de la Vie, tom. ii. p. 228, 1837.

† Edin. Med. and Surg. Jour., pp. 138, 139, 1838.

and also some of those distributed upon the pharynx and back parts of the tongue, so that it is chiefly composed of sensiferous and incident filaments. The *inferior laryngeal* furnishes incident and sensiferous filaments to the greater part of the trachea, to the cervical portion of the œsophagus, a few to the mucous surface of the pharynx, and still fewer to the larynx; it supplies the motor filaments of the cervical portion of the œsophagus and of all the muscles which are attached to and move the arytenoid cartilages, and is chiefly composed of motor filaments.* When any excitation is applied to the mucous membrane of the larynx in the healthy state, this does not excite the contraction of the muscles which move the arytenoid cartilages by acting *directly* upon these through the mucous membrane, but is the result, as Dr. M. Hall† had maintained, of a reflex or excitomotory action, in the performance of which the *superior laryngeal* is the incident, and the *inferior laryngeal* the motor nerve. In each recurrent nerve two sets of motor filaments are included, one set transmitting the nervous influence which stimulates the opening muscles of the larynx to act synchronously with the other muscles of inspiration, the other set transmitting the nervous influence which calls the closing muscles into synchronous action with the muscles of expiration.‡

Upon these views we can readily explain how, when the inferior laryngeal nerves are cut, all the movements of the muscles of the arytenoid cartilages are arrested, and the superior aperture of the larynx, as was first pointed out by Legallois, can no longer be dilated during inspiration. In fact, the sides of the larynx are not only no longer separated by an active influence, but are rendered quite passive, and yield readily within the limits of their natural movements to any external force applied to them. When the recurrent nerves are cut in an adult animal, where the cavity of the larynx is large, a quantity of air may still find its way through the diminished aperture, adequate, in many cases, to carry on the respiratory process in a sufficient manner, particularly if the muscles of inspiration are not acting violently. If, on the other hand, the capacity of the larynx be proportionally smaller as in young animals, the air rushes through the diminished superior aperture of the larynx in a narrower stream and with increased force, more especially when the inspiratory movements are powerful—or in other words, when the capacity of the thorax is suddenly and greatly enlarged,—and an insufficient quantity of air reaches the lungs. This quantity is still further reduced by the circumstance that the now passive sides of the superior aperture of the larynx are carried inwards by the

current of air, and at each inspiration the arytenoid cartilages may be so closely approximated as to prevent the ingress of air and suffocate the animal. It is the inspiration alone of the animal which is difficult, for the expiration is easy. The occurrence or non-occurrence of dyspnœa, or suffocation, after section of the inferior laryngeals, is to be explained by the greater or less capacity of the larynx in the individual animal, and the activity and extent of its respiratory movements at the time. The *crowling sound* which frequently attends this condition of the larynx is a mere physical effect, and depends upon the current of air rushing rapidly through the diminished aperture of the larynx, and may be imitated in the dead larynx. Severe dyspnœa amounting to suffocation may arise both from the opposite conditions of irritation and compression of the inferior laryngeal nerves or the trunks of the pneumogastric above the origin of this branch. We have stated above that on irritating one recurrent nerve we observed that the arytenoid cartilages were approximated so as in some cases to shut completely the superior aperture of the larynx, and we have already explained how paralysis of this nerve by compression or any other cause should produce this effect by arresting the movements of all the muscles attached to the arytenoid cartilages.* We also found that after the section of both superior laryngeal nerves in dogs and rabbits they swallowed solids and fluids readily, and without exciting cough or difficulty of breathing.† Mr. Hilton has arrived at the conclusion, from the anatomical distribution of the nerves alone, that the superior laryngeal is chiefly sensitive, and that the only motor filaments which it contains are distributed in the crico-thyroid muscle, while the inferior laryngeal supplies all the muscles attached to the arytenoid cartilages with motor filaments,—a view in exact accordance with that which we have given above.‡

Volkmann in his experiments found that the movements of the glottis were not affected by dividing the superior laryngeal nerves.§ Longe||

* Professor Henderson (Cormack's Journal of Medical Science, p. 10, for 1841) adduces cases to show that in the human species the narrowing of the superior aperture of the larynx, termed laryngismus stridulus, may be induced both by irritation and paralysis of the recurrents.

† An account of the above experiments and inferences was read at the meeting of the British Scientific Association in 1837; a short epitome of them was given in the Athenæum for Sept. 16, 1837, and they were published in full in the Edinburgh Medical and Surgical Journal for January, 1838.

‡ Guy's Hospital Reports for October, 1837, forming part of the 2nd volume.

§ Opus cit. Volkmann states that on irritating the external branch of the superior laryngeal in dogs and calves, not only the crico-thyroid muscle was thrown into contraction, but also the constrictor pharyngeus superior and the thyro-hyoid. If this be confirmed, these two last muscles must receive their motor nervous filaments from two sources, as the constrictor receives a supply from the pharyngeal branch of the vagus, and the thyro-hyoid from the hypoglossal.

|| Recherches Expérimentales sur les Fonctions des Nerfs, des Muscles du Larynx, &c. Paris, 1841.

* We also suggested that some of these filaments distributed in the trachea might be motor, though we had not succeeded in obtaining experimental evidence of it.

† Lectures on the Nervous System and its Diseases, Lecture 1, 1836.

‡ Each of these two sets may again be subdivided into other two—one composed of the excitomotory filaments of Dr. M. Hall, the other of sensiferovital filaments.

has published various experiments upon these nerves very similar to those which we had performed, and obtained nearly the same results. Longet states that the respirations become increased in frequency after dividing the recurrents. Other experimenters have lately satisfied themselves of the accuracy of these experiments.

Effects of the laryngeal nerves on phonation.

—The effect of the lesion of the recurrent nerves in enfeebling the voice was well known to Galen and the older physiologists.* We found in making this experiment that the voice, as Monro Secundus† and others have stated, is not altogether lost, for in some cases, at least, the animal could still emit a faint howl. Longet‡ has observed that the voice is completely lost in old animals, while young animals are still able to produce acute sounds different from the natural voice if the crico-thyroid muscle moved through the *external* branch of the superior laryngeal be not paralysed, and he attributes this difference to the relative size of the larynx at these ages. We can have no doubts in attributing the effects of lesion of the inferior laryngeals upon the voice to the paralysis of the muscles attached to the arytenoid cartilages.§

Magendie mentions that an animal after section of the *superior laryngeal nerves* “loses almost all its acute sounds it acquires, besides a constant gravity which it had not previously.”|| This he attributed to the arrestment of the movements of the arytenoid muscles, but we have shown that the section of these nerves has no such effect. Bischoff could perceive no change upon the voice after he had divided these nerves in two dogs.¶ Longet states that the division of those nerves above the origin of the *external branch*, or of the *external branch* alone, is followed by a disagreeable hoarseness of the voice.** If the variations in the length of a tube alter the graveness and acuteness of the sounds which it emits, we would expect that the lesion of the superior laryngeals should, by arresting the movements of the crico-thyroid muscle, produce some change in this respect. Longet believes that the crico-thyroid muscles are, during their contraction, tensors of the vocal chords, and that the changes upon the voice induced by dividing the superior laryngeals depend upon the effect which paralysis of these muscles has upon the tension of the vocal chords.††

Œsophageal branches.—Muscular contractions have been observed in the œsophagus on

irritating the trunk of the vagus, by Arnemann,* Cruikshank,† Mayo,‡ and others. When the trunk of the vagus is irritated above the origin of the recurrent, the muscular fibres of the œsophagus along its whole length are thrown into active contraction. In experiments upon rabbits we found that the œsophagus became impacted with food eaten after section of the vagi in the neck, when very little of it had reached the stomach and when no efforts at vomiting had occurred, while its muscular fibres could still readily be thrown into active contraction by *direct* excitation. From this we inferred that before the presence of the ingesta in this tube can excite its muscular fibres to contract and propel its contents onwards, the same conditions of the nervous system are necessary as for the production of the excitatory movements, and that certain of the filaments of the vagi act as incident and others as motor nerves. That the food also collects in the œsophagus in the horse and sheep after division of the vagi may be inferred from the experiments of Dupuy§ and others. In subsequent experiments upon dogs we found that substances seem to pass pretty freely along the œsophagus in that animal after section of the vagi. It would appear, however, that even in the dog the food is occasionally retained in the œsophagus after dividing the vagi.|| Arnold (opus cit. p. 144) observed in his experiments upon hens and pigeons that the œsophagus and crop were so relaxed after section of the vagi that when the animals shook their head and neck, or kept the head in a depending position, a quantity of chyme flowed from the bill.

From a review of all these facts we are inclined to agree in the opinion lately expressed by Dr. M. Hall, that in some animals the muscular contractions of the œsophagus are excitatory, while in others they are called into action by direct excitation. We cannot at present determine whether the propulsion of the food along the œsophagus in the human species partakes more of the former or of the latter class of movements. Magendie has ascertained that various muscular movements go on in the lower part of the œsophagus, more especially when the stomach is full, by which this tube is contracted during inspiration and relaxed during expiration, and that they are suspended by dividing the vagi. These we may class among the reflex muscular movements. The œsophagus is endowed with little sensibility, and in the natural and healthy condition of the organ the ingesta are propelled along it to the stomach without exciting any sensation. From a consideration of all the

* Vide Haller's *Elementa Physiologiæ*, tom. iii. p. 408, Lausan. 1766.

† Observations on the Nervous System, p. 65.

‡ Opus supra cit., p. 14 and 15.

§ I have seen some cases of partial aphonia in the human species arising from the compression of one recurrent in the upper part of the chest by an aneurism of the aorta.

|| Compendium of Physiology, p. 138, 1831.

¶ Opus cit. p. 27.

** Dupuytren had previously maintained that lesion of the superior laryngeals was followed by a disagreeable hoarseness, *Biblioth. Medic. tom. xviii.*, 1807, as quoted by Longet.

†† Opus cit. p. 8 and 27.

* As quoted by Soemmerring *Corporis Hum. Fabrica*, tom. iv., p. 272, 1794.

† Medical Facts and Observations, vol. vii., p. 153, or *Phil. Transact.*, 1795.

‡ Anatomical and Physiological Commentaries, No. ii., p. 15.

§ *Journal de Médecine, Chirurgie, &c. Dec. 1846*, tom. 37, p. 351.

|| Baglivi *Opera Omnia*, p. 676, Anvers, 1715, et *Valsalvæ Opera cum Epistolis Anatomicis, &c. J. B. Morgani Epist. Anatom. xiii. 37*, Venet. 1740.

above facts we believe that the œsophageal filaments are chiefly incident and motor, and a few of them only are sensiferous.

Cardiac branches.—We have in a former part of this work (article HEART) had occasion to state that several celebrated physiologists have failed in exciting the muscular contractions of the heart by irritation of the trunk of the vagus before it gives off its cardiac branches, or of these cardiac branches themselves. We have very frequently repeated this experiment upon animals immediately after death, and we have not been able to satisfy ourselves that galvanic and mechanical excitation of these nerves has any effect in renewing or increasing the contractions of the heart. No doubt we have not unfrequently seen the contractions of the heart become more frequent and vigorous during the performance of this experiment; but as similar changes in the strength and rapidity of its contractions are occasionally observed in an animal after death when no artificial excitant has been applied to these nerves, and from causes which cannot at present be explained, we did not think ourselves entitled to attribute these changes in the heart's action to the excitation of the nerves. Valentin* has stated that he has produced muscular contractions in the heart in different animals by irritation of the trunk of the vagus. He also states† that similar contractions of the heart were produced by excitation of the spinal accessory and of the three superior (sometimes also of the fourth) cervical nerves, and he maintains that the motor portion of the cardiac nerves comes from the spinal accessory and the superior cervical nerves. Longet‡ mentions that he failed in influencing the rhythm of the heart by the application of galvanism to the vagi in dogs, rabbits, and sheep, but very frequently succeeded by scraping the cervical cardiac branches of the vagus. Allowing that it is possible to increase the contractions of the heart by galvanic or mechanical excitation of the vagus or its cardiac branches, it must be admitted by every one that there is a very marked difference between the heart and voluntary muscles in this respect, for all those who have failed in their experiments on the nerves of the heart, have felt not the smallest difficulty in producing contractions of the voluntary muscles by excitation of their nerves. The increased frequency of the pulsations of the heart observed during and for some minutes after the division of the vagi may be fairly referred to the struggles and terror of the animal, and the feeble and rapid pulsation of the heart which precedes death from this experiment is not owing to any direct effect upon that organ. The sudden death occasionally remarked after the division of these nerves, and which some of the early experimenters attributed to arrestment of the contractility of the heart, was in fact dependent upon the suffocation of the animal by the suspension of the movements of the muscles which dilate the superior aperture

of the larynx. We have related several experiments which appear to prove that when injuries of the brain and mental emotions affect the contractility of the heart, the nervous influence is not transmitted by the cardiac branches of the vagi alone, but may also pass along the filaments of the sympathetic or ganglionic system of nerves.

Pulmonary branches.—Do the pulmonary branches of the vagus contain motor filaments? We have made various unsuccessful attempts to produce contractions in the muscular fibres of the bronchial tubes by excitation of the vagi in the neck.* Dr. C. T. B. Williams† was also unsuccessful on attempting this experiment, though he succeeded in producing contractions in the bronchial muscular fibres by their direct excitation, as by transmitting galvanism through the substance of the lungs, &c. Longet and Volkmann have not only succeeded in exciting contractions of the muscular fibres of the bronchii by direct stimulation, but also by excitants applied to the branches of the vagus.‡ To what extent are the pulmonary branches of the vagus sensiferous? Brachet relates some experiments which seem to prove that the sensation arising from the want of fresh air in the lungs, or the *besoin de respirer*, is annihilated by the division of vagi.§ Mr. Grainger|| repeated one of Brachet's experiments, and seemed satisfied that his conclusions were correct. There are certain sources of fallacy attending the mode in which Brachet performed his experiments against which he has not taken the necessary precautions.

We have satisfied ourselves by numerous experiments that the *sense of anxiety* arising from the want of fresh air in the lungs continues after dividing the vagi when the access of air to the lungs is prevented;¶ and Volkmann** and Longet†† from their experiments have also arrived at the same conclusion. It is possible that certain impressions which may excite the *besoin de respirer* are conveyed upwards to the encephalon through the medium of the sympathetic, but it is more probable that in the conditions induced by the experiment it was more immediately dependent upon the circulation of ill-arterialized blood through the tissues of the body, and more especially through the encephalon. We do not mean to deny that impressions conveyed along the vagi to the encephalon may not excite the *besoin de respirer*; on the other hand, we believe that it is very probable that this sensation as first felt, when the respiration is suspended for a short time in the healthy condition of the body, is dependent upon impressions conveyed along this nerve. When,

* Opus cit. for 1839.

† Transactions of British Scientific Association for 1840, p. 411.

‡ Longet, opus cit. tom. ii. p. 289, and Volkmann in Wagner's Handwörterbuch der Physiologie, article Nervenphysiologie, p. 586.

§ Système Nerveux Ganglionaire, p. 133-4-5.

|| On the Spinal Chord.

¶ Opus cit. for 1838.

** Muller's Archives for 1841. See also Forbes' British and Foreign Review for Jan. 1842, p. 223.

†† Opus cit. tom. ii., 291-2, 1842.

* Opus cit. p. 48, 62 and 66.

† Opus cit. p. 62.

‡ Opus cit. &c. tom. ii. p. 314.

however, the respiration has been suspended for a longer time and venous blood begins to circulate along the arteries, the other excitants of the *besoin de respirer* come into operation.

Brachet,* Krimer,† and Longet,‡ have from their experiments arrived at the conclusion that the sensations occasioned by irritation of the inner surface of the trachea and bronchial tubes, and which usually precede coughing, are annihilated by dividing the vagi. We have made repeated experiments on this point, and though we could not satisfy ourselves that these sensations were affected to the extent maintained by these authors, we believe that they are at least blunted.

To what extent do the filaments of the vagi act as incident nerves?—It has been proved by the experiments of Legallois,§ Flourens,|| and others, that all the respiratory and muscular movements cease on destroying the medulla oblongata, though the other parts of the encephalon situated above this may be injured in various ways without necessarily producing this effect. It is further well known that if the spinal chord be cut across, all the respiratory muscles are paralysed which receive their nerves from that portion of it below the point where it was divided, while those muscles which receive their nerves from that portion of the spinal chord still continuous with the medulla oblongata perform their usual functions. From these and other facts it may be considered as ascertained that all impressions made at the lungs and elsewhere capable of causing respiratory movements, must be conveyed to the medulla oblongata before they can produce any reflex excitation of the muscles of respiration. That the vagi can convey these impressions from the lungs is not only rendered probable from their attachment to the medulla oblongata, but may almost be considered as proved by the result of the experiments upon the spinal chord to which we have just referred. It, however, by no means follows that the vagi are the sole excitant nerves of respiration. It has been fully ascertained by numerous experimenters, more especially by those who have investigated the functions of this nerve from the time of Legallois, that an animal will continue to breathe after the division of both vagi in the neck, if care be taken to secure the ingress and egress of air to and from the lungs. It is now well known, as we have already had occasion to point out in examining the functions of the laryngeal branches, that if the vagi be injured above the origin of the recurrent laryngeals, none of the muscles attached to the arytenoid cartilages can any longer act in unison with the muscles of respiration, all their movements cease, and the superior aperture of the larynx can no longer be dilated during inspiration. If the larynx be large, and the animal refrain

from any violent effort, an adequate quantity of air may still find its way to the lungs, and the respirations are at first performed with ease. If, on the other hand, the larynx be small, its superior aperture may be mechanically closed and the animal may be immediately suffocated, or the air may still pass through the larynx but in diminished quantity, and the animal may labour under dyspnoea from the moment the nerves are divided, up to its death. Even when means are taken to secure the free entrance of air into the lungs, an immediate and marked diminution in the frequency of the respiratory movements follows the division of both vagi in the neck. A. G. F. Emmert concluded, but apparently more upon theoretical grounds than from any direct observations made in the two experiments he had at that time performed on rabbits, that after lesion of the vagi the respirations become less frequent and prolonged.* Mayer reckoned the number of respirations, both before and at various periods after section of these nerves in five experiments upon the ass, dog, and rabbit, and found a very marked diminution in their frequency after dividing the nerves.† Mr. Broughton mentions, that in a horse in which the vagi were divided “the respirations became slow, twelve in a minute;” and in another horse “the respirations fell to five in the minute.”‡ At what period after the division of the nerves these last observations were made, and what was the number of the respirations previous to the commencement of the experiments, we are not informed. Sir Astley Cooper has given the result of two experiments upon rabbits which well illustrate the effect of the division of the vagi upon the respiratory movements.§ In our experiments we ascertained that the diminution in the frequency of the respiratory movements, generally to less than half of their former number, is an *immediate* effect of the division of both vagi. The respiratory movements seem to be performed more slowly, and, generally, even from the first, in a somewhat heaving manner.|| Arnold in his experiments upon hens also observed a very considerable diminution in the frequency of the respiratory movements.¶ Brachet has asserted** that an animal continues to breathe after section of the vagi, because it has acquired the habit of using the respiratory muscles. Dr. Marshall Hall has maintained that after the vagi are divided the respiratory movements are no longer a function of the excito-motory but of the cerebral portion of the nervous system; ††

* Archiv. für Physiologie von Reil und Autenrieth, Neunter Band. 1809, s. 417.

† Tiedemann's Zeitschrift für Physiologie, Zweiter Band, 1826, s. 77.

‡ Quarterly Journal of Literature, Science, &c. vol. x., p. 305 and 307.

§ Guy's Hospital Reports, No. 3, Sept. 1836, p. 409.

|| Transactions of British Scientific Association for 1838, and Edin. Med. and Surgical Journal for 1839, vol 51.

¶ Bemerkungen über den Bau des Hirns und Rückenmarks, &c. s. 148. Zurich, 1838.

** Oper. cit. p. 132.

†† Philosophical Magazine for Jan. 1835. Lec-

* Oper. cit. p. 157-8-9.

† Untersuchungen über den Husten, as quoted by Müller.

‡ Oper. cit. tom. ii. p. 289.

§ Sur le Principe de la Vie.

|| Recherches Expérimentales sur les Propriétés et les Fonctions du Système Nerveux, &c. Paris, 1824.

and he has adduced in support of this view the statement of Cruveilhier that after the function of volition has been suspended by destroying the cerebrum, the respiratory movements are instantly arrested on dividing the vagi near their origin.* In putting this opinion to the test of experiment we found that though the respirations were very much diminished in frequency by the removal of the cerebrum and cerebellum and then dividing the vagi, they nevertheless continued for a longer or shorter time.† Similar results have also been subsequently obtained by Volkmann,‡ by Flourens,§ and by Longet.¶ From these facts we are entitled to conclude that the vagi are not the sole exciters of respiration, and that impressions may be made upon the medulla oblongata capable of exciting the involuntary respiratory movements after the vagi have been divided in the neck, and when impressions made on their expanded extremities in the lungs can no longer be conveyed inwards to the central organs of the nervous system. The importance of the vagi as incident nerves of respiration is not only proved by the marked and immediate diminution in the number of the respirations which follows their division,¶ but also in a more striking manner by the morbid changes which take place in the lungs.

Morbid changes in the lungs after dividing the vagi.—The injury or division of the vagi is almost always fatal after a few days, even when precautions are taken to secure the free ingress of air into the lungs. The period of death in such experiments varies in different animals. Rabbits generally die earlier than dogs. The greater number of dogs die before the third day, and comparatively few live beyond the fifth day. In seventeen experiments upon dogs we found that eleven died before the completion of the third day, and seven of these eleven before the completion of the second day. Longet says that he performed this experiment on thirty dogs, and they all died on or before the fifth day, and none of the rabbits operated on, lived beyond thirty-six hours.* Dupuy in his experiments found that horses lived to the fifth, sixth, and seventh day, when care was taken to admit a sufficient quantity of air into the lungs.†† De Blainville informs us that the pigeons on which he operated died on the sixth or seventh day;‡‡ and in the experiments of Arnold§§ upon hens and pigeons, these animals died between the second and fifth day. In

general the lungs are the only organs found in an abnormal state after death from injury or division of the vagi. We found the lungs unfit for the healthy performance of their functions in fifteen out of seventeen dogs experimented upon. These organs are almost always more or less congested with blood, especially at the depending parts, and the bronchial tubes and air cells frequently contain much frothy serum. In some portions of the lungs the congestion of blood is occasionally so great as to render them dense and devoid of air. This condensation is not unfrequently greater in some parts than what can be accounted for by the mere congestion of blood in the vessels, and probably depends in a great measure upon the escape of the solid parts of the blood into the tissue of the lung. The frothy serum has frequently a greater or less deep tinge of red. Portions of the lung are likewise occasionally found condensed from pneumonic effusion. In seventeen experiments on dogs distinct evidences of pneumonia were observed in five, and in two of these it had run on to gangrene. These morbid changes upon the lungs are sufficient to explain the imperfect arterialization of the blood, and the diminished evolution of internal caloric which precedes death. We have endeavoured to prove that these morbid changes in the lungs are the result of the diminished frequency of the respiratory movements which immediately follows the division of the vagi. The vagi are the chief exciters of the respiratory muscular movements, and when they are tied or divided the respirations are instantly diminished to less than half their former number. The flow of blood through the lungs is dependent upon the continuance of the respiratory process, and the great diminution in the activity of the respiratory muscular movements must be followed by a retardation and congestion of the blood in the lungs. Such a congestion of blood, as is well known, is generally followed by an effusion of serum, and also predisposes the organs so circumstanced to various morbid changes, chiefly of an inflammatory nature. In the lungs this congestion is not only followed by the escape of the serum, but also of the more solid material from the vessels, rendering the tissue dense. The effused serum is mixed up with air moving along the bronchial tubes during inspiration and expiration, and it thus becomes frothy. A little blood may also exude from the congested mucous membrane of the bronchial tubes, giving the serum there effused a reddish tinge. As these changes proceed, the respiratory process becomes more and more imperfect, the blood flowing along the arteries approaches more and more to the venous hue, all the vital properties of the tissue are enfeebled, the internal temperature sinks, and the animal dies of protracted asphyxia. The division and other injuries of the pneumo-gastrics have no direct effect upon the production of the animal heat; they only occasion this indirectly by enfeebling the function of respiration. We have elsewhere* ad-

tures on the Nervous System, p. 25. Memoirs on the Nervous System, p. 87, 1837.

* Lancet, 17th Feb., 1838, p. 733.

† Opus cit. for 1839.

‡ Opus cit. for 1840.

§ Opus cit. Seconde edition, p. 204, Paris, 1842.

¶ Opus cit. tom. ii., p. 307, 1842.

¶ A diminution of the number of respirations, but to a less extent generally, results from dividing one of the vagi.

** Opus cit. tom. ii., p. 306.

†† Journal de Médecine, Chirurg., &c., tome xxxvii., p. 356, Dec. 1816.

‡‡ Nouv. Bullet. de la Societ. Philom. tome i., ann. ii., p. 226.

§§ Opus cit. s. 163.

* Edinburgh Medical and Surgical Journal for 1839.

duced evidence to shew that these morbid changes do not necessarily follow the division of both vagi in all animals, and that the dog in a few rare cases may either die of inanition from the arrested secretion of the gastric juice and without any morbid alterations in the lungs, or may even survive the operation and recover from its effect.

Magendie, Wilson Philip,* Mr. Swan,† and Longet,‡ found that section of one vagus induced diseased action in the lung of the same side. The lesions observed by these experimenters differed very considerably in their character. Dupuytren,§ on the other hand, could discover no alteration in the lung of the side on which the vagus had been divided in two dogs and a horse, though these animals were allowed to live more than a month. In an experiment made by Magendie before his pupils, the results were completely at variance with his former expressed opinions. The right lung of a dog was found perfectly healthy, though a portion of the vagus of that side was removed six months before.¶ We have removed a portion of one vagus in seventeen animals, and allowed them to live a longer or shorter period,—from twenty-four hours to six months,—and in none of these could we detect any morbid changes in the lungs which we could attribute to the injury of the nerve. This immunity of the lung from the usual morbid changes, when one nerve only was divided, we attribute to the smaller diminution of the respiratory muscular movements, than when both nerves are divided.

Functions of the gastric branches. Do the gastric branches of the vagus contain some motiferous filaments?—Mr. Mayo¶ and Müller** failed in exciting muscular contractions in the stomach by irritating the trunks of the vagi, while this experiment succeeded in the hands of Bichat,†† Tiedemann and Gmelin,‡‡ and Longet.§§ Breschet and Milne Edwards||| inferred that muscular movements can be excited in the stomach of a living animal by galvanizing the lower end of the divided vagi in the neck from its effects upon the digestive process. We have carefully and repeatedly performed the experiment of irritating the vagi, and are confident that though it occasionally fails, yet it often succeeds.¶¶ These muscular movements in the stomach differ considerably from those in the œsophagus. They are more slow and are vermicular.

* Experimental Inquiry, &c. p. 145.

† Essay on the Connection of the Heart and the Functions of the Nervous System, &c.

‡ Opus cit. p. 351.

§ Biblioth. Méd., 1807, t. xvii., p. 21., as quoted by Longet.

¶ Leçons sur les Phénomènes Physiques de la vie, tom. i., p. 203-4.

¶¶ Anatomical and Physiological Commentaries, No. 2, p. 15.

** Elements of Physiology.

†† Anatom. Générale, tom. iii., p. 360. Paris, 1812.

‡‡ Recher. Experim. Physiol. et Chem. sur la Digestion, p. 374.

§§ Opus cit., p. 322.

||| Archiv. Gén. de Méd., tome vii.

¶¶ Opus cit.

They generally commence at the cardiac orifice and proceed to a greater or less extent towards the pyloric orifice. Longet thinks that he can explain this discrepancy in the results of this experiment, as he found that it succeeded when the stomach was engaged in the process of chymification, and failed when it was empty. Though we are satisfied that the gastric branches of the vagus contain some motor filaments, yet we do not believe with Breschet and Milne Edwards, Brachet, Longet, and others, that the muscular movements of the stomach depend entirely upon the integrity of the vagi. Magendie* observed these muscular movements continue after section of the vagi; and we ascertained from experiment that if a dog recovers from the first effects of the operation of cutting the vagi, the stomach can still propel the chyme onwards into the duodenum. Arnold,† from his experiments upon hens and pigeons, concludes that the contractions of the stomach are less influenced than those of the œsophagus and crop by division of the vagi. The grains taken into the stomach after this operation were found, however, to be considerably less bruised than in sound animals.

Effects of lesion of the vagi upon the sensations of hunger and satiety.—Though the sensation of hunger is referred to the stomach, yet it is evident from well established facts that this sensation is actually situated in the encephalic portion of the nervous system. This sensation is not dependent, as far as we know, upon any physical condition of the stomach itself, and in all probability arises from certain organic changes in the body, connected with the want of additional supplies of nutritious matters from without. Brachet relates two experiments to show that the sensations of hunger and satiety are arrested by section of the vagi,‡ but these are liable to certain sources of fallacy against which proper precautions were not taken. Four of seventeen dogs we experimented on, lived beyond the fifth day after the division of the vagi, and exhibited no signs of having lost the sensation of hunger; on the other hand their actions indicated that they still retained this sensation. Longet has from his experiments arrived at conclusions on this point similar to ours.§ There can be no doubt that the sensation of hunger is almost always suspended for a longer or shorter time after the division of the vagi, probably occasioned in some measure by the pain and terror attending the operation, but if the animal live for a few days the sensation of hunger may return.

Though the facts from which Brachet has arrived at the conclusion that the sensation of satiety is annihilated by the division of the vagi, do not, as we have elsewhere shown,|| warrant this inference, yet it is probable for reasons which will occur to every one in reflecting

* Compendium of Physiology. Translated by Milligan, 4th edit., p. 261.

† Bemerkungen über den Bau des Hirns und Rückenmarks, &c., S. 145.

‡ Système Nerveux Ganglionaire Expt. 52-3.

§ Opus cit., tom. ii., p. 329.

|| Opus cit.

upon the matter that this sensation is more dependent upon the physical condition of the stomach than that of hunger. At the same time we must confess that we have ourselves obtained no very satisfactory evidence from experiment, that this sensation is annihilated by division of the vagi.

Effects of lesion of the vagi upon the function of digestion.—That section or ligation of the vagi is generally followed by vomiting,—in those animals susceptible of it,—by loathing of food and arrestment of the digestive process, has been incontrovertibly proved by numerous experimenters. That perfect digestion may occasionally take place after division of the vagi in the neck even when the cut ends are kept considerably apart, is now, we are fully convinced, sufficiently established. Leuret and Lassaigne have detailed an experiment where the process of digestion went on in a horse after division of the vagi with loss of substance.* In one of Arneemann's experiments on dogs, the digestive process must have been re-established, as the animal was killed on the 165th day after the operation of dividing both vagi.† In an experiment made by Sédillot on a dog the digestion must at least have been partially restored, as the animal lived two months and a half.‡ Sédillot also mentions that Begin kept a dog alive for a month after the division of both vagi. M. Chaumet further states that no obvious change was observed in the digestion in this dog;§ and he also mentions that in some similar experiments made by himself a dog lived fourteen days and digested. In four out of seventeen dogs experimented on, we obtained sufficient evidence of the restoration of the digestive process. In these animals we had not only removed a portion of the vagi, but also of the recurrent nerves. Many experimenters, among whom we may enumerate Haller,|| Brunn,¶ De Blainville,** Dumas,†† Dupuy,‡‡ Legallois,§§ Macdonald,|||| Wilson Philip,¶¶ and Dr. Hastings,*** have never obtained evidence of the continuance of the digestion after lesion of the vagi, but such negative experiments cannot be considered as neutralizing the results of the positive

experiments we have mentioned above: they only show what every physiologist who has experimented much on this subject must be obliged to confess, that the digestive process is generally arrested after section of the vagi during the short time the animal usually lives after these nerves have been tied or divided, but they can never overthrow the results derived from positive experiments, provided that these have been accurately performed and are free from all sources of fallacy.

Effects of lesion of the vagi upon the secretion of gastric juice.—We have already detailed facts sufficient to prove that the removal of a portion of both vagi does not always arrest the digestion of food, and consequently does not necessarily prevent the secretion of the gastric juice. Mayer found the chyme acid in rabbits after section of the vagi. Dieckhof and Müller state that in all their experiments performed upon geese the fluid secreted from the surface of the stomach after section of the vagi was always acid, but was less in quantity than in the sound animal.* Breschet, Milne Edwards, and Vavasseur,† Dr. Holland,‡ and Brachet,§ maintain that in their experiments the gastric juice was secreted, since the food in the stomach was more or less altered. In two experiments we ascertained that the half digested food vomited, though taken into the stomach some days after division of the vagi, permanently reddened litmus-paper; and we consider the presence of chyle in the lacteals and thoracic duct as observed in the experiment of Leuret and Lassaigne, and in three of our own experiments, as furnishing decisive evidence of the secretion of gastric juice. In one of our experiments the animal was rapidly recovering flesh and strength when he was killed three weeks after division of the vagi and recurrences with loss of substance. Arnold, in his experiments upon hens and pigeons, ascertained that the fluid secreted from the stomach was acid, that it was not perceptibly diminished in quantity, and that it was capable of converting the food into chyme.|| Longet, in his experiments upon quadrupeds, found that the fluid secreted from the stomach coagulated milk and reddened turnsol paper. He further states, that the quantity of gastric juice secreted appeared to him to be greater than in the sound animal.¶ In a great number of experiments, more especially if the animal survive the operation a short time only, the secretion of gastric juice is temporarily suspended, and this enables us to explain the frequent occurrence of negative results in such researches.

Effects of lesion of the vagi upon the secretion of mucus from the inner surface of the stomach and intestines.—Sir B. Brodie relates from experiments in which animals were poisoned by arsenic where the usual watery and

* Recherches Physiologiques et Chimiques pour servir à l'Histoire de la Digestion, p. 133-4. Paris, 1825.

† Versuche über die Regeneration der Nerven. hundert und zehnter versuch., S. 99. 1787.

‡ Thèse au Nerf Pneumogastic, &c. Paris, 1829.

§ Essai sur la Physiologie de l'Estomac. Paris, 1828.

|| Opera Minora, tom. i., p. 359-60. Expert. 132-5-6.

¶ De Ligaturis Nervorum. Ludwig Scrip. Nerv. Min. Sel., tom. ii., p. 286-7. Expt. 2, 3, and 6.

** Propositions extraites d'un Essai sur la Respiration. Paris, 1806.

†† Journal Général de Médecine, tom. xxxii.

‡‡ Journal de Médecine, Chirurgie, &c., tom. xxxvii.

§§ Sur le Principe de la Vie, p. 214.

|||| Dissertatio Experimenta quedam de Ciborum Concoctione complectens. Edinburgh, 1818.

¶¶ Inquiry into the vital Functions.

*** Quarterly Journal of Science, &c., vol. xi., p. 40.

* Elements of Physiology, translated by Baly, vol. i., p. 597, 2nd edit.

† Opus cit. tom. ii. p. 483.

‡ An Experimental Inquiry, &c. chap. x. Edin. 1829.

§ Opus cit.

|| Opus cit. p. 142.

¶ Opus cit. tom. ii. p. 332.

mucous secretions were not poured out from the mucous surface of the stomach and intestines, though it presented the inflammation usual in such cases.* We have carefully repeated these experiments, and obtained different results. The quantity of watery and mucous secretions was nearly the same in animals after the vagi had been divided, as in animals upon which this operation had not been performed.† These experiments upon the effects of lesion of the vagi upon the different secretions poured out from the inner surface of the digestive canal, though they do not prove that the function of secretion is independent of the nervous system, seeing that numerous filaments of the sympathetic nerve are also distributed there, are yet sufficient to neutralize the evidence drawn from the effects of lesion of the vagi upon these secretions adduced by those who maintain that secretion is dependent upon the nervous system.

Effects of lesion of the vagi upon the rapidity of absorption from the inner surface of the stomach.—It has been stated by Dupuy† and Brachet, that the most active poisons introduced into the stomach after division of the vagi in much larger quantities than usual, produce their effects much more slowly. On the other hand Müller mentions that in thirty experiments on Mammalia performed under his direction by M. Wernscheidt, “not the least difference could be perceived in the action of narcotic poisons introduced into the stomach, whether the nervus vagus had been divided on both sides or not, provided the animals were of the same species and size.”§ We have made several comparative experiments on this point,|| and obtained results which agreed nearly with those mentioned by Müller.

The following short summary contains the principal conclusions founded upon the facts and observations above detailed, at which we have arrived regarding the functions of the nervus vagus.

1. Though the trunk of the nervus vagus at its attachment to the encephalon principally consists of sensiferous and incident filaments, it yet contains a few motor filaments. The motor filaments contained in some of the branches of the vagus chiefly come from the spinal accessory.

2. The filaments of the *auricular branch* of the vagus are sensiferous and incident.

2. The *pharyngeal branches* of the vagus are principally if not entirely motor, and move the muscles of the pharynx and soft palate in obedience to certain impressions made upon the incident filaments of the glosso-pharyngeal and fifth pair of nerves distributed upon the mucous surface of these organs.

4. The *superior laryngeal branch* is chiefly composed of sensiferous and incident filaments which are abundantly distributed upon the

mucous surface of the larynx, and much more sparingly upon the inner surface of the lower part of the pharynx. The few motor filaments contained in the superior laryngeal are distributed in, and move the crico-thyroid muscle. When the superior laryngeal branches are divided or tied, every excitation of the inner surface of the larynx fails to excite sensation, or any reflex and muscular movement, and the two crico-thyroid muscles are paralysed.

5. The *inferior laryngeal or recurrent branch* is ramified in, and regulates the movements of all the muscles attached to the arytenoid cartilages, viz. the *crico-arytenoideus posticus* and *lateralis*, the *thyro-arytenoideus*, and the *arytenoidei*. The inferior laryngeal also furnish the sensiferous filaments to the upper part of the trachea, a few to the mucous surface of the larynx, and still fewer to the pharynx. The sensiferous filaments of the inferior laryngeal are, however, few in number and do not impart much sensibility to the parts in which they are distributed, presenting a striking contrast in this respect to the superior laryngeal. When the inferior laryngeal is cut or tied, the muscles attached to the arytenoid cartilages are no longer moved voluntarily as in speech, or involuntarily as in the muscular movements of respiration; and the arytenoid cartilages may be mechanically carried inwards by the currents of air rushing into the lungs, so as to shut up the superior aperture of the larynx and produce suffocation. When any excitation is applied to the inner surface of the larynx in the healthy state, this does not produce the contraction of the muscles which approximate the arytenoid cartilages by acting directly upon them through the mucous membrane; but this muscular contraction is effected indirectly and by a reflex action, in the performance of which the superior laryngeal acts as the incident or afferent nerve, and the inferior laryngeal as the motor or efferent nerve. It is also probable that these filaments of the inferior laryngeal distributed in the muscular fibres of the trachea are motor. The inferior laryngeal branch is the principal nerve of phonation, and when paralysed the voice becomes very faint. The effects of the paralysis of the *superior laryngeal* upon the voice are much less marked and are much more doubtful.

5. The *oesophageal branches* of the vagus are partly afferent and partly efferent nerves. In some animals, as in the rabbit, the section of the vagi in the neck is followed by the suspension of the movements of the oesophagus during deglutition, and the food is no longer conveyed along it in the usual manner. This lesion of the vagi does not produce these effects by destroying the contractility of the muscular fibres of the oesophagus, but by breaking the continuity of the nervous circle necessary for the accomplishment of all reflex movements. In some other animals, as in the dog, the food is still propelled along the oesophagus after section of the vagi, so that it is probable that in these animals the muscular fibres of the oesophagus are also called into contraction by direct excitation.

* Philos. Trans., 1812, p. 102.

† Opus cit. for 1839, vol. li.

‡ Opus cit. p. 366.

§ Opus cit. p. 186.

|| Müller's Elements of Physiology, translated by Baly, vol. i. p. 263, 2nd edit.

¶ Opus cit. vol. li.

6. The *cardiac branches of the vagus* have no direct effect in maintaining the movements of the heart. Though the movements of the heart may be materially influenced by causes acting through the vagus, yet mental emotions and injuries of the central organs of the nervous system affect the heart's action through the sympathetic after the vagi and recurrens have been divided in the neck.

7. The *pulmonary branches of the vagus* consist chiefly of incident filaments and convey impressions, capable of producing respiratory muscular movements, made on the inner surface of the lungs to the medulla oblongata. When the vagi are cut or tied in the neck the respirations instantly fall in frequency, and are reduced to about one half their former number. The existence of motor filaments in these branches has not yet been satisfactorily established.

8. Though excitation of the *nervus vagus* in the neck causes muscular contractions of the stomach, yet the muscular movements of the stomach are not entirely dependent upon the gastric branches of the vagus, and the stomach may still propel the chyme into the duodenum after the vagi and recurrens have been divided. Lesion of the gastric branches of the vagus does not necessarily arrest the secretion of the usual fluids poured out into the interior of the stomach, though these are generally changed to a considerable extent both in quantity and quality by causes acting through the nervous system. The rapidity of the absorption of poisonous substances from the inner surface of the stomach is not perceptibly diminished by the division of the vagi.

9. Division or ligature of the vagi in the neck is almost always fatal. The cause of death, in by far the greater number of cases, is congestion of the lungs with blood induced by the diminished frequency of the respiratory muscular movements. In a few cases the animal dies of inanition from derangement of the functions of the stomach.*

(John Reid.)

PAROTID REGION.—This region (in surgical anatomy) is of a somewhat pyramidal form, the base corresponding to the surface of the skin, and the apex to the pharynx. The

* The author embraces this opportunity of correcting some of the errors which have been overlooked in printing this article.

P. 882, col. 1, l. 11, for "cross," read "crosses."

" 2, foot note marked †, l. 7, for "enlargement," read "arrangement."

P. 888, col. 2, foot note, l. 17, for "while the other two vagi, or," &c. to the end of the sentence, read "while the other two vagi give off the left recurrent of the right larynx and the right recurrent of the left, as they pass the larynges."

P. 890, col. 1, last line, for "that in the," read "that while in the."

P. 890, col. 2, l. 5, for "while the recurrent one of the motor branches is," read "while the recurrent, one of the motor branches, is."

P. 893, col. 1, last line except one, for "motor filaments," read "sensiferous filaments."

superficial boundaries of the region are, *superiorly*, the root of the zygoma and the articulation of the jaw; *inferiorly*, a line drawn from the angle of the jaw to the anterior border of the sterno-mastoid muscle; *anteriorly*, the posterior border of the masseter muscle; and *posteriorly*, the meatus auditorius, the mastoid process with the anterior border of the sterno-mastoid muscle.

In the present article it is intended to give the relative anatomy of the parts contained in this irregular and ill-defined region.

Commencing the dissection by removing the integument from the parotid region, we expose some delicate muscular fibres which constitute the upper part of the platysma or the risorius Santorini; these fibres, however, are not constantly present. After removing a fine reticular tissue, the superficial surface of the *parotid fascia* is seen. This is a strong fibrous fascia which is continuous below with the cervical fascia; it passes over the superficial surfaces of the parotid, being attached above to the zygoma, and behind to the cartilage of the ear, while in front it is thinner and is prolonged over the masseteric region. The fascia also dips down into the substance of the gland and divides it into lobes and lobules.

The *Parotid Gland*, from which the name of this region is derived, is the largest of the three salivary glands. Its form is irregular, and is determined by the surrounding parts into the interstices of which it is packed and moulded.

Relations of the parotid.—A description of the relations of the parotid gland will include the greater part of the relative anatomy of the parotid region. The *external surface* or *base* of the gland corresponds to the skin; it is of a somewhat irregular quadrilateral form, and its boundaries are identical with those of the parotid region, except that a portion of the gland, the *socia parotidis*, is prolonged forwards with the duct over the masseter muscle. The *anterior surface* of the parotid is grooved to receive the posterior border of the ramus of the jaw; it also corresponds to the internal pterygoid muscle, the stylo-maxillary ligament, and the masseter muscle, upon the external surface of which it is prolonged, but separated from it by some loose cellular tissue, by branches of the portio dura nerve, and by the transverse facial artery. The *posterior surface* corresponds to the cartilaginous portion of the external meatus, upon the convexity of which it is moulded, and to which it is connected by dense cellular tissue; this surface is also related to the mastoid process and to the sterno-mastoid and digastric muscles. It is related *superiorly* to the zygoma and the tempero-maxillary articulation; *inferiorly* it fills up the space between the angle of the jaw and the anterior border of the sterno-mastoid muscle. It here comes into relation with the submaxillary gland, but is separated from it by the stylo-maxillary ligament. The *internal* or *deep surface* of the parotid is very uneven; it fills up the posterior part of the glenoid cavity and the space between the ear and ramus of the jaw; it surrounds the styloid process and the muscles

which arise from it, and passes down between the styloid process and the pterygoid muscles, so as to come in contact with the pharynx and the internal carotid artery, as well as the internal jugular vein, and the eighth, ninth, and sympathetic nerves. A portion of the gland passes with the internal maxillary artery between the ramus of the jaw and the internal lateral ligament; it here comes into contact with the inferior maxillary nerve, and sometimes reaches the space between the external and internal pterygoid muscles.

In addition to the relations here pointed out to the parts by which it is surrounded and limited, the parotid has important relations to vessels and nerves which pass through its substance or are deeply imbedded within and beneath it.

Arteries.—The *external carotid artery* passes into the lower border of the gland near its deep surface; as it ascends it becomes more superficial, and is continued upwards under the name of the *superficial temporal*, which passes up between the ear and the articulation of the jaw, crosses over the zygoma, and so emerges from beneath the parotid gland and its fascia.

The *internal maxillary artery* passes off from the carotid at right angles. At its origin it is imbedded in the substance of the parotid, and is nearly on a level with the lower extremity of the lobe of the ear; it bends downwards and inwards, and escapes from the parotid by passing between the ramus of the jaw and its internal lateral ligament.

The *transversalis faciei* arises from the carotid or from the superficial temporal artery at a variable distance between the angle and neck of the jaw. Its origin is imbedded in the substance of the parotid; it then goes upwards and forwards, and passes out beneath the anterior border of the gland, lying between it and the masseter muscle.

The *posterior auricular artery* is a small branch of uncertain origin. When regular it arises from the external carotid, above the digastric and stylo-hyoid muscles, opposite the point of the styloid process; it is here partly concealed by the parotid gland, in the posterior part of which it is imbedded; it then passes upwards and backwards between the ear and the mastoid process. While this artery is imbedded in the parotid it sends off a small *stylo-mastoid* branch, which passes upwards to enter the stylo-mastoid foramen. In addition to the above-mentioned arteries there are several branches variable in their number, size, and situation, which pass off from the carotid and its branches and are distributed to the substance of the parotid gland.

Veins.—The veins corresponding to the terminal branches of the external carotid artery accompany the arteries and are consequently imbedded in the parotid gland. The temporal and internal maxillary veins unite and form a common trunk, which lies superficial to the external carotid artery. This common trunk receives the posterior auricular and the transverse facial veins, as well as some veins from

the substance of the parotid, and so the commencement of the external jugular vein is formed. There is also a communicating branch which passes through the parotid gland from the internal to the external jugular vein; this branch may be looked upon as one of the origins, and in some cases it is the chief origin of the external jugular vein.

Nerves.—We have next to study the relations of the nerves which are found in the parotid region.

The nerve which lies most superficially in this region is the *great auricular*, some small branches of which lie superficial to the parotid fascia and are distributed to the skin of the parotid region, while other branches pierce the fascia, and pass through the parotid in a direction forwards and upwards to be distributed on the skin of the cheek. The nerve then sends off two branches, the superficial auricular and the deep auricular.

The *superficial auricular* branch of the great auricular nerve passing vertically upwards in the dense fibrous tissue which connects the parotid with the skin, reaches the inferior part of the concha, and is distributed to the skin of the ear.

The *deep auricular* branch passes through the substance of the parotid, to place itself in front of the mastoid process, crossing at an acute angle the auricular branch of the facial nerve, which is deeper than it, and with which it anastomoses by a branch of considerable size. The nerve then passes backwards and divides into branches which are distributed to the external ear, and to the skin over the occipital region.

The *auriculo-temporal* nerve arises from the trunk of the superior maxillary by two portions, between which passes occasionally the middle meningeal artery. It passes backwards beneath the external pterygoid muscle, and between the internal lateral ligament and neck of the jaw; it then divides into two branches, a superficial or temporal and a deep or auricular branch. The *superficial temporal* passes up between the ear and the articulation of the jaw, crossing the root of the zygoma, and becoming superficial above the parotid gland; it then supplies the skin of the temple and side of the head. In its course this nerve sends off one or two branches which communicate with the portio dura nerve; it also sends branches to the tempero-maxillary articulation and to the external auditory meatus. The *auricular* branch forms a plexus behind the neck of the jaw and around the internal maxillary artery; it then divides into several branches, some of which pass through the parotid to be distributed on the external ear, while others anastomose with branches of the cervical plexus, particularly with the great auricular nerve. One branch joins the dental nerve just before it enters the dental canal, and another passes into the tempero-maxillary articulation.

The *portio dura* nerve passes out of the stylo-mastoid foramen and enters the substance of the parotid gland. At its exit from the foramen the nerve sends off three small branches,

the posterior auricular, the digastric, and the stylo-hyoid.

The *posterior auricular* nerve passes off from the anterior part of the portio dura; it passes upwards and forwards round the anterior surface of the mastoid process, and is joined by the great auricular nerve of the cervical plexus; it then becomes superficial, accompanies the artery of the same name, and is distributed to the ear and side of the head.

The *digastric* nerve passes backwards and is distributed by several filaments to the posterior belly of the digastric muscle. It sends an anastomotic filament to the glosso-pharyngeal nerve.

The *stylo-hyoid* nerve arises often from a common trunk with the preceding; it enters the stylo-hyoid muscle after passing along its superior border.

After the portio dura has given off the above-mentioned branches it passes forwards through the substance of the parotid gland below the meatus auditorius externus; it then crosses over the posterior auricular artery and the styloid process, the external jugular vein and the external carotid artery, and before reaching the ramus of the jaw it divides into two branches, the tempero-facial and the cervico-facial, which diverge from each other.

The *tempero-facial division* passes upwards and forwards in the substance of the parotid, forming with the trunk of the facial nerve an arch, the concavity of which is above; it then crosses the neck of the lower jaw and receives at this point one and sometimes two branches from the auriculo-temporal branch of the inferior maxillary nerve. The tempero-facial nerve then breaks up into a number of branches which anastomose and form arches, from the convexities of which proceed a number of diverging filaments, some of which pass upwards and others forwards, emerging from beneath the parotid, to be distributed to the muscles of the face.

The *cervico-facial division* is smaller than the preceding; it takes the same direction as the trunk of the nerve, passing downwards and forwards in the substance of the parotid; at the angle of the jaw it divides into three or four branches; these subdivide into secondary branches, some of which pass forwards to supply the muscles of the lower part of the face, while others are distributed to the upper part of the cervical region.

Lymphatic glands.—Several lymphatic glands are found imbedded in the superficial surface, and in the substance of the parotid. These may readily be distinguished from the tissue of the parotid by their red colour. They are not uncommonly the seat of disease, and if their removal becomes necessary the operation may be done without much difficulty and without great risk of wounding any important textures. But a slight consideration of the deep connexions of the parotid and of its close relations to the many important parts which pass through it, and by which it is surrounded, will be sufficient to convince the surgeon that the removal of this gland cannot be effected without extreme difficulty and danger, and

that it must necessarily be attended by injury to some of the important parts in this region. The division of the facial nerve, and consequent palsy of the face, may be looked upon as one of the most serious and certain consequences of an attempt to excise the parotid.

(George Johnson.)

PARTURITION, MECHANISM OF.

Parturition is the act in which the matured fruit of healthy conception and gestation is transmitted along the passages of the mother. "Rien de plus curieux que le mécanisme par lequel le fœtus est expulsé; tout s'y passe avec une précision admirable," is the quotation which the celebrated Naegelé has used for a heading to his essay on this important process in the human subject, the first in which it has been completely and accurately described. Perhaps in no department of physiology do we gain so much instruction from comparative anatomy as here; when we examine the ovipara, especially the higher orders of them, we are struck with the simplicity of the parturient process, and with the equally simple laws by which it is governed. The oval form of the egg shows that its long diameter must run parallel with the canal through which it has to pass, and in these classes of animals this single law constitutes nearly the whole mechanism of parturition in them.

In the vivipara the process becomes somewhat more complicated; the fœtus enveloped in its soft and fluctuating bag of membranes and the more perfect pelvis bring many other relations into play which do not exist in the lower classes; hence in the viviparous animals we see that the manner in which the fœtus advances through the passages of the mother varies considerably, still however not so much as to render it incompatible with the law above mentioned.

In considering the process of parturition in the lower classes of animals it will be scarcely necessary to go beyond the Vertebrata, for in the lowest classes, especially the zoophytes, it admits of but little comparison with them, the analogy rather inclining in the contrary direction, viz. towards the vegetable kingdom. In some of the other classes, viz. Vermes, &c., little certain is known as to this process beyond that the generative organs are of the simple tubular character; we must except, however, the Insecta, in many of which the ova and the mode of their expulsion strongly resemble a much higher class, viz. the Aves.

The Fishes, which are the lowest class of the Vertebrata, have no bony canal or pelvis; the whole apparatus for parturition is a tube the lower part of which at least is fibrous; in the larger fishes it is muscular and capable of considerable dilatation. In the Ray and Shark tribe we first see this canal divided into two parts, viz. the ovary and oviduct; still the process is of the simplest character, the ova being propelled precisely like the contents of an intestinal tube. In the viviparous sharks, the *Blenius viviparus*, and still more remarkably in the Cetacea, where as belonging to the Mammalia we first see the oviduct divided into a

tube and uterus, and where the fœtus is generally so large, the parturient process is equally simple, the uterus and vagina being converted by gradual dilatation into a simple continuous canal. In the higher classes of Reptilia we first perceive a regularly formed pelvis, viz. in the Sauria, and still more completely in the Chelonia, the pelvis in the latter being considerably advanced in point of development, even as compared with the higher Mammalia; indeed as regards pelvic development these two classes of the Reptilia ought rather to be placed above the Aves, in whom, with one exception, the pelvis is much more imperfect. The rudimental trace of a pelvis which is seen in certain of the fishes is evidently a modification of a scapula, and intended as part of the apparatus for propulsion, being connected with the ventral fin. In the Cetacea this is marked by the existence of two small thin flat bones imbedded in muscle on each side the vent. In Birds this formation is still more marked, and here we first see distinctly the analogy pointed out by Meckel between the attachments to the trunk of the upper and lower extremities, the ilium corresponding to the scapula, the ischium to the coracoid process, and the pubic bone to the clavicle; the pelvis in them presents the transition from the scapular bones of the lower extremities, if we may so call them, in some of the fish tribe, to the completely formed bony canal of the higher Mammalia. The pelvic bones in Birds are still subservient to little else than the purposes of locomotion, the ossa pubis not uniting in front, their points terminating at a considerable distance from each other, but connected by a ligamentous band which is elastic and capable of considerable dilatation; the process of parturition here is as simple as in the inferior classes, the egg passing along the cloaca through the half bony, half fibrous canal of the pelvis. One solitary instance of a perfect pelvis presents itself among the Aves, viz. in the ostrich, and where the symphysis pubis does not seem capable of much dilatation, although from the size of the egg there can be but little room to spare in the pelvis during its expulsion; an apparent approach to this formation is occasionally seen in birds which attain a considerable age from the deposition of bony matter into the pubic ligament. An equally solitary example of an imperfect pelvis among the Mammalia is furnished by the lesser ant-eater, the pubic bones not being united.

The lowest grade of parturition which (excepting the Cetacea) is observed in the Mammalia, is seen in certain Insectivora, viz. the mole, shrew, &c. in which this process is akin to that in those animals which either have no pelvis at all, or have them of a very imperfect kind. In the mole, &c. the pelvic cavity is so small as to be utterly useless for the purposes of parturition, not even containing the rectum, which, together with the vagina, passes down in front of the pelvis. In this instance, therefore, we have once more a strong analogy to parturition in the lower ovipara, especially as in the above-mentioned animals the

uterus is still at a low grade of formation, being cylindrical and scarcely to be distinguished from its Fallopian tube.

A still further advance towards the perfect pelvis is seen in the Guinea-pig, an animal in

Fig. 487.

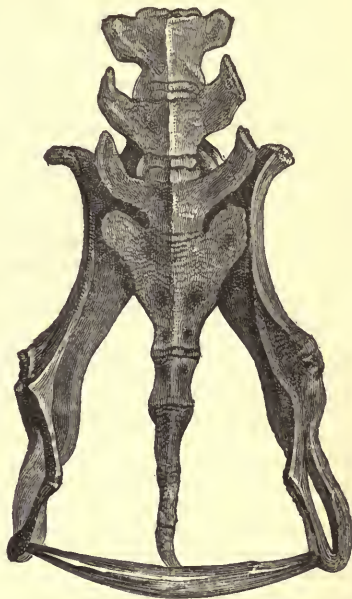

Pelvis of the Guinea Pig at the time of parturition.

Fig. 488.

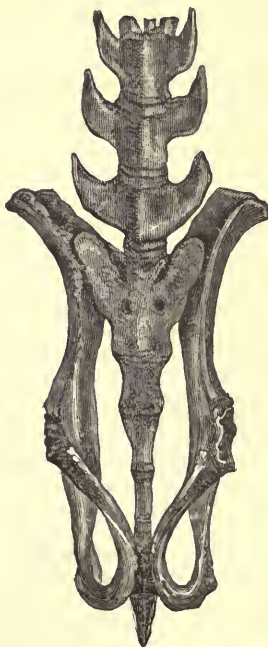

Pelvis of the Guinea Pig 72 hours after parturition.

which the fœtus attains a size utterly incompatible to pass through the small pelvis of the mother were it not for the extraordinary elasticity of the pubic ligament, being capable of allowing the ends of the pubic bones to diverge from each other to the distance of nearly an inch and a half. The capability of the pelvis being enlarged by this mechanism depends upon the shortness of its transverse, and the great length of its antero-posterior or sacro-pubal diameter, the ossa innominata running forwards from each side of the sacrum in a nearly parallel direction, or rather forming an isoskeles triangle, its apex at the pubes, its base at the sacrum. This greater length of the antero-posterior to that of the transverse diameter may be traced with few exceptions along the whole chain of *pelviferous* vertebrata until we reach the human subject, and even here, until the age of puberty, we find a similar relation between these diameters. This form of pelvis is eminently adapted for dilatation during parturition; the ossa innominata, moving, as it were, upon a hinge at their sacro-iliac synchondroses, are capable of a considerable separation at their pubic ends, by which means the pelvis is greatly enlarged and passage of the fœtus much facilitated.

In some animals, as cows, the swelling and softening of the ligamento-cartilaginous unions is distinctly seen on the approach of labour, the lumbar vertebræ and sacrum sinking between the ilia, and these bones "slipping," as it is called, over each other at their sacro-iliac symphyses as the animal moves her hind legs.

The axis of the pelvis in animals being with few exceptions parallel with the spine, and the outlet from the formation of the sacrum being so large, it will be seen that up to the Ruminantia the mechanism of parturition is extremely simple, the more so as until we reach this class the uterus in great measure preserves its tubular formation, rendering it next to impossible that the fœtus should come in any other direction than with its long diameter corresponding to the axis of the canal through which it has to pass.

In the Marsupiatæ the fœtus is expelled at so early a stage of development, and is therefore so small, that little or no dilatation of the pelvis is required; in these animals we see the pelvis well developed, and the difference between the length of the transverse and antero-posterior diameters inconsiderable: in them it is probable that little or no separation of the pubic bones takes place during parturition.

In the other and higher classes of the Mammalia the hard and well developed head of the fœtus and its inflexible limbs, especially in the Ruminantia, as also the horse, ass, &c., present very considerable obstructions to its passage through the pelvis, and require that it should take a certain position during labour in order that it may be born with such a degree of facility and within such a period of time as shall not endanger its own life or that of its mother.

Although the pelvis among the higher Mammalia still presents many remarkable points of difference from that of the human race, least

perhaps in the *Quadrumanæ*, still on the other hand the mechanism of parturition in these animals resembles in many respects this process in man. The embryo has a somewhat similar position in the uterus as it has in the human subject. In the early periods of pregnancy in both cases, the limbs stand off from the trunk, whereas in the latter months they are pressed close to the body. The lower extremities or hind legs in animals are always turned upon the abdomen; in some instances the knees are bent, in others not.

The arms of the child are crossed upon the breast; in animals the forelegs are usually placed along the side of the head and generally a little below it; it is rare that one or both are found above the head, although it has sometimes occurred that the two forelegs have been found crossing each other over the head. The forelegs are seldom found bent down *under* the abdomen.

The embryo usually lies upon its belly, or on one side; and from being scarcely ever found upon the back it may be presumed that this position is very rare.* The head is mostly turned towards the os uteri, although cases are by no means uncommon, even among the larger animals, of its being turned to the fundus uteri. In the larger animals (mare, cow, sheep, goat, &c.) the embryo at first lies tolerably unconstrained, whereas at a later period it descends into the smaller part of the uterus, and hence at this time we usually find the nose bent down upon the breast. In the child this position with the chin upon the breast exists from a very early period.

In the smaller animals, viz. the dog, cat, rat, &c., the head at the end of pregnancy mostly lies flat on the lower jaw, and therefore presents with the nose, whereas in the larger animals the occiput presents, and this probably withdraws again as labour comes on. The ears are always pressed close to the head, being turned either forwards or backwards; they are usually found bent forwards in the dog, cat, and horse, and backwards in the cow, sheep, goat, rabbit, hare, &c.

Although the human fœtus usually presents also with the head, the whole mechanism of its parturition is very different from that of the animals above-mentioned; the angles of the pelvic axes with the spine and with each other, and the relative size of the antero-posterior and transverse diameters, are so different that we find the greater part of the process subservient to laws which do not exist in the lower animals; nevertheless the grand primary law with which we commenced holds equally good in the human subject as in the lowest ovipara, and upon this depends the great distinction between natural and unnatural presentations; for so long as the long diameter of the child is parallel with the axis of the passage through which it comes, the child will present with its cephalic or its pelvic extremity, and can be born in that position; whereas if its long diameter does not correspond with that of the axis of the pelvis,

* Joerg.

the child lies across and presents with the arm or shoulder, a position in which it cannot be born. The two first are therefore called *natural*, the last *unnatural* presentations. In the human subject neither the antero-posterior nor the transverse are the longest, but the oblique diameters, both of the brim cavity and outlet of the pelvis, and it is only in the directions of these diameters that the pelvis is of a tolerably uniform size throughout. They are named the right and left oblique diameters according to that sacro-iliac synchondrosis from which they are drawn.

The great peculiarity in the mechanism of human parturition is that in either of the *natural* presentations the presenting part enters the pelvis *obliquely*, not only as to the transverse diameter, but as to the axis of its brim; it passes through the cavity and outlet nearly in the same position; so that it not only takes that direction in which the pelvis is most roomy, viz. in the oblique diameters, but in which it will *itself* occupy the least possible space. Having stated this law, it will now be necessary to describe these presentations of the child in illustration of it.

The cephalic end of the child may present in two ways, either with the head or the face; the former is by far the most common; it is also the most favourable for mother and child, and at one time was looked upon as the only natural and favourable presentation. The head presents either with the right or left parietal protuberance, the sagittal suture running parallel with the right or left oblique diameters, and in both cases, at the beginning of labour, crossing the os uteri.

These three facts at once confirm the law above mentioned, viz. that the head enters the pelvis *obliquely* both as to its long and perpendicular diameters, or, as before expressed, *obliquely* as to the transverse diameter and axis of the brim; for if (as is well known to be the case) the os uteri at the beginning of labour is situated at the upper part of the hollow of the sacrum, the vertex of the head will be turned towards this part of the pelvis, and the parietal protuberance being that part which is lowest and in the centre of the pelvis, it follows that the perpendicular diameter of the head will run obliquely upwards and forwards with the axis of the brim.

The first position, viz. where the right parietal protuberance presents, and the sagittal suture corresponds to the right oblique diameter of the pelvis, is known by the posterior or small fontanelle being felt in the vicinity of the left foramen ovale, the anterior or large fontanelle in the opposite direction near the right sacro-iliac synchondrosis: this has been called the first position from occurring more frequently than the other, viz. in the proportion of five to two. As the head approaches the pelvic outlet, the occiput turns somewhat more forwards, so that instead of the protuberance, the posterior and superior quarter of the right parietal bone presents: this is the part of the head which the finger at this period of labour first touches upon during examination, which

first passes under the pubic arch, and first distends the os externum; the position of the head is nevertheless still oblique, for the right branch of the lambdoidal suture will be felt parallel with the left descending ramus of the pubic arch. In still further proof of what has now been stated, we may mention, that if the head be some time in its passage through the vagina, it becomes so tightly encircled by it as to produce a considerable obstruction to the circulation in the scalp; hence we shall feel a tumefaction of the cranial integuments on that part of it which presents. On examining, therefore, the head of a new-born child which has presented in the first position, it has a circular swelling of the scalp situated upon the posterior and superior quarter of the right parietal bone. This is the *caput succedaneum*, the Vorkopf of the German authors, and, as was pointed out by the late Professor Chaussier of Paris, is a distinct evidence of the manner in which the child has presented during labour. The shoulders enter the pelvis in the contrary oblique diameter to what the head does, so that if the head in the first position has passed through with its long diameter corresponding to the right oblique diameter of the pelvis, the shoulders will be found in the left oblique diameter—from this circumstance, after the head is born, the face is turned backwards and to the right.

The second position of the head is the reverse of the first. The left parietal protuberance presents. During the descent of the head through the brim into the cavity of the pelvis, the sagittal suture is in the right oblique diameter as in the first position, only now the posterior fontanelle is directed towards the right sacro-iliac symphysis, the anterior one to the left foramen ovale. The head descends in this position until it approaches the pelvic outlet, when it makes the quarter of a turn and passes from the right into the left oblique diameter, the anterior fontanelle now corresponding to the left sacro-iliac symphysis, the posterior one to the right foramen ovale. As the head enters the vagina and begins to pass under the pubic arch, it is the posterior and superior quarter of the left parietal bone which now presents, and upon which the puffy swelling of the scalp is situated; as in the first position it was the right lambdoidal suture which corresponded to the left branch of the pubic arch, so here it is the reverse, the left lambdoidal suture at this moment will be found parallel with the right branch of the pubic arch; in like manner, the face when born turns backwards and to the left. This change in the position of the head from one oblique diameter to the other is not peculiar to the second position, for we meet with it occasionally in the first, the anterior fontanelle being turned to the right foramen ovale, the posterior one towards the left sacro-iliac synchondrosis, the change in this case usually taking place at a much earlier period of labour than in the second position, whether it is owing to the position of the rectum or not is difficult to say. The uniformity with which this change occurs in the position of the head from one oblique

diameter to the other was first pointed out by Professor Naegelé, of Heidelberg, and must be looked upon as a fact of great importance in the mechanism of parturition, second only to the discovery of the oblique position of the head by Solayres de Renhac and Matthias Saxtorph in 1771. Sometimes the head does not make the change above mentioned, but comes out with the forehead more or less forwards, the swelling of the cranial integuments being situated on the right or left frontal bone.

The face, like the head, may present in two ways, either with the right or the left side foremost. As in the head presentations the sagittal suture crosses the os uteri, so in the present instance is this the case with the ridge of the nose.

In that position which is of most frequent occurrence the chin is turned to the right side of the pelvis, the right eye and zygoma being lowest and in the middle of the pelvis; this, therefore, shows that the face, like the head, comes obliquely not only as to the transverse diameter of the pelvis, but also as to the axis of its brim. The ridge of the nose is not only the part of the face which we first are able to distinguish when the os uteri is but slightly dilated, but from its conducting the finger in one direction to the soft cushiony end of the nose, and in the other to the broad hard expanse of the forehead, it furnishes us with an excellent means of ascertaining not only that the face presents, but in what position.

As the os uteri dilates and the face advances, the chin turns towards the right foramen ovale, so that by the time it has entered the vagina, it is no longer the right eye and zygoma which form the presenting part, but the right cheek, this being now the part which the finger first touches upon during examination, precisely as in the first position of the head, it is the superior and posterior quarter of the right parietal bone; so, in like manner, it is this part of the face upon which the bruise-like swelling is situated, which it brings with it into the world. It would seem that there is a considerable analogy between the first position of the head and that of the face, and that the one can probably pass into the other; in both the right side presents, and if the head in this position swings round upon its transverse diameter, it becomes the first position of the face.

The other or second position of the face is merely the reverse of the first. The left eye and zygoma present at the beginning of labour; and as the chin, which is turned more or less to the left, moves somewhat forwards, it becomes the left cheek which first passes through the os externum, and upon which the swelling of the face is situated.

According to the best averages, we may state that face presentations occur about once in 290 labours, and from the observations of Professor Naegelé, jun., the proportion of the second position to the first is as 1.29 to 1. Beyond being now and then a little more tedious, labours where the face presents are not more unfavourable for the mother than where the head presents; for the child, however, they are not

so favourable; the pressure upon the neck produces considerable cerebral engorgement, which now and then proves fatal.

The lower part or pelvic extremity of the trunk may present with the nates, the knees, or the feet; but as the former are by far the most bulky, we may bring them under the general head of *nates presentations*. In this case the child may present with the back or abdomen forwards, in either of which the transverse diameter of its pelvis runs obliquely, that ischium, which is turned forwards, being lowest in the pelvis. The position with the back of the child more or less forwards is the most common, being in the proportion of 3 to 1 of the other position. The presenting ischium advances through the os externum; the abdomen and chest follow; and the arms, which are crossed upon the breast, are usually born at the same moment. The shoulders follow in the same direction, that shoulder being first expelled which is turned more or less forwards. The head, with the chin pressed upon the breast, enters the pelvis in the opposite oblique diameter to what the shoulders did; and while the occiput rests against the symphysis pubis, the chin, followed by the rest of the face and forehead, sweep over the perineum as the head turns upon its transverse diameter from below upwards. Sometimes, although rarely, the chin is not depressed upon the breast, but the head enters the pelvis in a contrary direction, viz. with the occiput pressed into the nape of the neck, the face turned upwards, and is born in this position. Where the abdomen of the child is turned forwards, it almost invariably turns more or less backwards during the progress of the labour, either shortly after the nates are expelled, or as the thorax is advancing through the pelvic outlet.

In all these presentations, the process of labour appears to resemble, as far as possible, that in the lower classes of animals. The first stage is employed in attaining two important objects; firstly, in giving the child a natural position, viz. with its long axis parallel with that of the passage through which it has to come, and in so dilating the os uteri that the whole of it shall disappear, the uterus and vagina forming one continuous canal, exactly resembling, as far as the mechanism of the expulsion is concerned, the same process in the lower animals.

As far as we know, it is only in the human subject where it is possible for the fœtus to present across, or where its long axis does not correspond with that of the passage; in this case it presents with the arm or shoulder, and cannot be born in this position. This unnatural presentation chiefly arises from the contractions of the uterus in the first stage being more or less perverted or obstructed by certain causes; thus if the uterus be much distended with liquor amnii, the slight precursory contractions at the commencement of labour will have little or no effect in keeping the fœtus with its long axis parallel with that of the uterus, for the sides of the uterus are now too far separated to act upon it, and as the uterus from its distention approaches to the globular form, the child will lie

just as well in one direction as in another. Moreover, when the uterus has been subject to irregular spasmodic contractions during the last week or two of pregnancy, by which its form is more or less altered, we frequently find that when labour comes on the child presents with the arm or shoulder. It is chiefly to this cause that we must attribute those remarkable cases which every now and then occur of the arm or shoulder presenting in four or five successive labours in the same individual, a fact which was first pointed out by Professor Naegelé, sen. The full-grown living fœtus can, therefore, present in only three ways, viz. with the head or face, with the nates or inferior extremities, and with the arm or shoulder. When other parts of the child present, it arises either from its having been some time dead in utero or from being premature.

(Edward Rigby.)

PELVIS.—See SUPPLEMENT.

PENIS.—(*Membrum virile*; Grec. *ανδρειον αιδιδιον*; Germ. *das Glied*, or *die Ruthe*; Fran. *verge*; Ital. *membro virile*.)

The term *penis* would appear from its derivation (*a pendendo*) to have been the popular designation of the male organ of man and of the higher animals among the Roman people. Like many other terms that we have received from our predecessors, the present has reference to a merely visual character of the organ in a small group of animals, irrespective of the important office which it is intended to fulfil in the general animal economy. At the present day, however, with a more enlarged scale of information with regard to the laws and attributes of living beings, while we retain the name, we assign to it a more comprehensive definition than its original application was intended to convey.

The penis, throughout the animal kingdom, is the organ of transmission of the male fluid to the germinal product of the female sexual apparatus; and in the mammiferous class it performs the additional office of efferent duct to the urinary secretion. In consideration of its more obvious purpose, the penis has been termed the organ of *intromission*; but this appellation, though correct in general, is incorrect in particular instances, for there are many among the inferior animals in which a rudimentary penis exists, but no intromission can possibly occur.

As generation divides its claim with nutrition in the lowest animal organisms, we are naturally led to the expectation of finding the representative of this organ among the lowest divisions of the animal scale, and this expectation is realized by research. In proceeding to this investigation, however, it cannot too strongly be impressed upon the mind, that in the lowest even as in the highest, modifications do occur which are conformable to the wants or convenience of the animals in whom they are found, without reference to any supposed gradation of development or improvement. Thus in *Infusoria* a sexual apparatus consisting of ovary, testis, and vesiculæ seminales, has been de-

scribed by Ehrenberg; and in *Rotifera* the same author has observed a contractile organ which serves to impel the seminal fluid into the oviduct. Here, then, almost on the boundary line of the animal world, is a self-impregnating animal, provided with a distinct transmittent organ by which impregnation is effected. But remarkable as this conformation may appear at first sight, examples equally wonderful become multiplied as we proceed onwards in our enquiry.

Bory St. Vincent has pointed out the existence of an intromittent spiculum in the Vinegar Eel (*anguillula aceti*), one of the *Vibrionidæ*; and Ehrenberg has observed a similar structure in another species, the *Anguillula fluviatilis*. Among the *Cestoid Entozoa*, which are androgynous, a distinct intromittent organ is found in *Ligula* and *Tenia solium*. In *Trematoda*, which are likewise androgynous, but impregnated by mutual concurrence, a penis is also met with, and is of considerable size. In *Acanthocephala*, the large intromittent organ of *Echinorhynchus gigas*, the entozoon of the kidney, has been described by Cloquet; and in *Nematoidea* the penis has attained a size and importance which renders it a generic character. Thus the genus *Filaria* is distinguished from *Trichocephalus* by a difference in form of the preputial covering, and a similar character distinguishes *Ascaris* from both the preceding. Most of the smaller species of *Ascaris* are remarkable, from possessing a double intromittent organ, and a similar conformation is met with in *Linguatula*, the entozoon of the frontal sinuses of the canine race; in *Cucullanus*, and in *Syngamus trachealis*, the tracheal parasite of gallinaceous birds.

Proceeding a step higher in the animal scale we find in the class *Annelida* that the organs of generation are hermaphrodite, and so disposed as to admit of mutual impregnation. In some genera the penis is well developed and distinct, as in *Planaria* and *Hirudo*; but in others the mutual apposition of the sexes is so perfect as to render an intromittent organ unnecessary. On this principle the penis is absent in the Earth-worm. In the Leech the penis is long and slender, placed on the twenty-fourth segment of the body, while the vulva occupies the twenty-ninth.

In *Cirrhopoda*, the barnacles or acorns of the sea, the intromittent organ is well developed, and from the mode of existence of these animals and their hermaphrodite organization, may be employed as a means of self or of reciprocal impregnation.

The class *Crustacea* is composed of animals which are diœcious in their sexual organization, and whose males are provided with a distinct intromittent organ. In the lowest groups, namely, the *Entomostracous Lernææ*, the penis is double; and in *Decapoda* and *Brachiura* it is temporary and formed by an eversion of the vas deferens, an adaptation of means to an end that we shall find repeated among the lower classes of *Vertebrata*. Throughout the whole of this class impregnation is effected by reciprocal union.

The class *Insecta* is diœcious, and an intromittent organ is a common character throughout the entire race. In some insects, as in *Aphis*, the penis is double, and in the greater number it is associated with special organs, termed *claspers*, which assist in the impregnating act.

The greater number of *molluscous animals* are inhabitants of the deep, and amongst them considerable diversity, as respects mode of generation, exists. Some are hermaphrodite in organisation, and self impregnating; others are hermaphrodite and mutually impregnating; a considerable proportion are diœcious, the male and female apparatus being on different individuals, and the impregnating fluid being conveyed by the medium in which they live from the male to the female animal; while some few are diœcious and impregnate by mutual concurrence. The air-breathers, or Pulmonary Mollusca, are all hermaphrodite and impregnate by reciprocal coitus. The two last alone of the preceding modes of impregnation are those in which a true intromittent organ is required; hence, although rudiments of a penis may be discovered in many Mollusca, it is only in the mutually impregnating hermaphrodites and in the concurring diœcia that it attains a size sufficiently bulky to render it an important character. Thus in the class *Tunicata*, which for the most part comprises self-impregnating hermaphrodites, no intromittent organ has been described. In the inhabitants of bivalve shells, which are either self-impregnating hermaphrodites, as the Oyster, or mediately impregnating diœcia, as the fresh-water Mussel, Anodonta, there is no penis. The marine Gasteropoda are diœcious; some, as the *Patella*, impregnating their females through the medium of the sea water by which they are surrounded, and others, including the whole of the *Pectinibranchiata*, impregnating immediately, being provided with a large penis for that purpose. In the genus *Trochus* the vas deferens terminates at the root of the penis, and the latter is grooved; and in *Carniaria* the intromittent organ is bifid as well as grooved. In the Pulmonary Gasteropoda, as the snails and slugs, the generative organization is hermaphrodite, impregnation being reciprocal, and the penis of very large size. Among *Encephalous Mollusca*, as in *Pteropoda*, the organisation is also hermaphrodite, and the penis of large size. In *Cephalopoda*, the highest class of molluscous animals, the generative structure is diœcious, but the penis is not intromittent. The penis in *Sepia* and *Octopus* is short and rudimentary, and pierced by a canal for the transmission of the seminal secretion; but in the hooked Calamary the organ is simply grooved along its under part.

In passing from the higher invertebrata to the class of *Fishes* we meet with a degradation of organization as regards the generative system. The penis, which we have seen to be properly formed for intromission in several of the invertebrate classes, is reduced to a mere papilla on the surface of the cloaca in fishes. In the Viviparous Blenny, however, in which internal impregnation takes place, the penis is larger in

size, and is probably increased in length during coitus by eversion of the mucous lining of the vas deferens. In some of the higher cartilaginous Fishes it is interesting to remark that the rudimentary state of the penis is compensated for by the development of an apparatus which seems intended to secure the contact of the cloacæ for an appreciable time. This apparatus consists of a pair of clasping organs, a provision to which we have already had occasion to advert when speaking of the generative organs of insects.

In *Amphibia*, as in Fishes, impregnation is effected by means of a close approximation, and in most instances by contact of the cloacæ. There is no penis, but as a substitute for this organ the male animal is possessed of an organisation fitted to maintain an embrace for a considerable period.

The penis of the *Ophidian* group of *Reptiles* is a true intromittent organ, and remarkable for the peculiarity of its structure. It consists of two cœcal processes, developed from the cloaca at its posterior part, and extending back into a cavity prolonged for a short distance towards the tail. These cœca are lined by a horny papillated epithelium; they are invested with a moderately thick layer of erectile tissue, and have proper muscles attached to their extremity. When the animal is excited by the venereal orgasm the turgescence of the erectile tissue causes the eversion of the cœca and their protrusion through the aperture of the cloaca. Restored to the state of repose, they are retracted by their muscles, and drawn back into their original position. In the Rattlesnake a singular modification of the intromittent organ occurs, in the bifid termination of each of the cœca. We cannot view the peculiarity of structure exhibited by *Ophidia*, without recalling to mind the similarly inverted disposition of the intromittent organ, which we have already seen among the Invertebrata, namely, in *Arachnida*.

The Lacertine *Sauria* are possessed of an inverted intromittent organ, similar to that of *Ophidia*. In the Crocodile, however, the penis is no longer an inverted cœcal pouch; it is grooved along its under part, attached by two crura to the pubic bones, and furnished with a rudimentary glans at its extremity. But even in the Crocodile there exists a peculiarity of structure which allies the family with the lacertine *Sauria* and *Ophidia*. The structure to which I allude, is a canal which is prolonged from the peritoneal cavity for a short distance into the substance of the penis, and there terminates by a cœcal extremity.

In *Chelonia*, the same kind of intromittent organ occurs as is found in Crocodiles, a grooved penis contained within the vestibule of the cloaca, attached to the pubic bones, and hollowed by one or more peritoneal canals. An important difference, however, is met with, when we compare the two groups of *Chelonia*, the marine and the land tortoises. In the former, scarcely any obstruction to impregnation results from the covering of the animal; the penis is consequently small. But in the land tortoise, where the shell extends beyond the limit of the

soft parts and acts as an obstacle to intromission, the penis is remarkable for its size and length.

Among *Birds*, the penis is rudimentary in a great proportion of the class. In aquatic birds, however, it is large and constructed on the same principle as the penis of serpents, so as to be capable of eversion. In the order *Anseres*, the intromittent organ is remarkable for its length, and is furnished with a groove which runs spirally around its axis. In terrestrial birds, the penis is large and grooved, and provided with a ligament of elastic tissue, which effects its retraction.

Throughout the whole class of *Mammifera*, the existence of an intromittent organ, furnished with an urethral canal, is a common character. In *Monotremata*, the penis is not conspicuous externally, but is contained in a sheath distinct from the cloaca, and protrudes through the latter under the influence of excitation. In this order, moreover, we meet with the interesting condition of an urethral canal, which is intended solely for the purpose of transmitting the seminal secretion, while the urine passes away by the cloaca. In *Marsupiatia*, the penis, which is of large size, is also situated in the interior of the animal in a sheath contiguous to the cloaca, but it passes through the latter when in a state of erection. Among *Rodentia*, the most remarkable character of the intromittent organ is the presence of recurved spines upon the glans penis; this apparatus reminds us of the clasping organs seen in insects and in the higher cartilaginous fishes, and is obviously intended to fulfil a similar function. The order *Edentata* affords two opposite conditions of the intromittent organ in relation to size; these conditions having reference, as in *Chelonia*, to the convenience of the animals. Thus in the *Bradypus* or Sloth, the penis is rudimentary, while in the *Armadillo* the organ is exceedingly large. In *Cetacea*, which from the nature of the medium in which they live, are subject to impediment in the impregnating act, the penis is enormous. In *Ruminantia* and *Pachydermata* the organ is of large size, and presents but little variety of form. In some genera it is more or less curved while in the state of repose; in others it is straight. The intromittent organ in *Carnivora* is rendered remarkable by the presence of a bone, the os penis, which is more or less developed in different genera. Thus in *Plantigrade Carnivora* it is of large size, while in the feline race it is cartilaginous and rudimentary.

In all the orders of *Mammifera* hitherto examined, the penis is contained either within a sheath in the interior of the body, as occurs in *Monotremata*, *Marsupiatia*, and *Cetacea*, or in a sheath of the integument upon the exterior. But in *Quadrumania*, the transition class to man, the sheath of integument no longer exists, and the organ hangs pendent from its attachment. The os penis still remains to identify the quadrumanous race with the inferior classes, but in the higher genera, the Chimpanzée and Orang, even this character of inferior organisa-

tion is lost. Mayer,* it is true, has declared the existence of a small cartilage, of a prismoid form, and about a line or a line and a half in length, in man. This he regards as the homologue of the os penis in inferior animals. It is situated, he says, in the submucous tissue of the upper part of the urethra within the glans penis; but he finds it only in strong and powerful men. Should this observation be confirmed by succeeding research, we ought to be able to find such a structure, even more considerable in its development, in the *Chimpanzée*. For my own part, I am unable to corroborate Mayer's discovery, having failed in numerous examinations of the human organ instituted for the purpose of finding it.

Having thus briefly reviewed the animal kingdom in relation to the existence of an organ of transmission for the reproductive secretion of the male, and having determined the conditions under which that organ is developed and its modifications produced, we may in the next place proceed to consider the conformation and structure of the penis, taking as the proper standard of comparison the intromittent organ of man.

The penis of man is situated at the lower part of the abdomen, below and in front of the symphysis pubis, and presents some difference in character, accordant with its state of excitement or repose. In the latter condition it is cylindrical in form and hangs loosely in front of the scrotum; in the former, its shape is prismoid, with rounded edges and slightly grooved along the sides, one facet of the prism broader than the other two forming the upper surface or dorsum of the organ, and a rounded angle the inferior border. Moreover, in the state of repose, the organ makes a sudden curve in front of the pubis, the concavity of the bend looking downwards; while in the state of erection it is directed upwards, and forms a gentle curve towards the parietes of the abdomen.

For convenience of description and reference, we are wont to consider the penis as divisible into a middle portion or *body*; the upper surface of the body being called the *dorsum*, a free and rounded extremity the *glans*, and a *root* or attached extremity by which it is connected with the ramus of the ischium at each side. The length and bulk of the organ vary with the conditions of erection and repose, and also with the individual.

The anatomical constituents of the penis are, the integument and subcutaneous areolar tissue, with the fascia penis; two bodies proper to this organ, the corpus cavernosum and corpus spongiosum, mucous membrane, muscles, vessels, and nerves.

The integument of the penis is remarkable for the thinness and fineness of its texture, its exceeding elasticity, and generally for a deeper tint of colour than that of the surrounding skin. The tenuity of the skin is equal to that of the eyelids, but is exceeded by the integument of the scrotum, and contrasts very strongly with

* Froriep's Notizen, No. 883.

the thick and dense dermis of the neighbouring parts of the abdomen and thighs. Its colour is brown, but varies in its depth in different individuals, being darker in those of a dark complexion, and little differing from the skin of the rest of the body in persons of an opposite character. As in other parts of the body, it is well provided with sebaceous glands, but these are more numerous in that portion which invests the under part of the organ than in the dorsal region. Near to the free extremity of the penis the integument forms an ample fold, the fore-skin or prepuce (*præputium*), which serves to envelope the glans when the organ is in repose, and to increase the investing covering when it is distended and enlarged. The prepuce is connected to the glans on its under part by means of a narrow fold termed the *frænum præputii*, and is lined by mucous membrane. Along the edge of the prepuce the mucous membrane is continuous with the skin of the penis; at the base of the prepuce it is reflected over the glans, and at the summit of the latter is continuous with the mucous membrane of the urethra through the *meatus urinarius*. Upon the under part of the glans the mucous membrane enclosing some fibrous tissue constitutes the narrow fold above described, the *frænum præputii*. At the base of the body of the penis, the integument is continuous with that of adjoining parts, with the skin of the pubes superiorly, and of the scrotum laterally and beneath. In this situation, moreover, it is altered in its characters; it is thicker in its texture and furnished with numerous hairs. The latter differ from the hairs of the pubes in taking the direction of the axis of the penis, and in being, unlike the former, perfectly straight. Along the inferior border of the penis the integument presents a somewhat prominent line, which is continuous with the *raphé* of the scrotum behind and with the *frænum* of the prepuce in front. This is the *raphé* of the penis, and indicates the mode of formation of the urethra, by the conjunction of two lateral segments on the middle line.

The subcutaneous areolar tissue connecting the integument to the body of the penis is extremely lax, and wholly devoid of adipose formation. The laxity of this tissue has the effect of permitting an enormous increase of size in the organ without inconvenience; thus in the state of repose the prepuce usually covers the glans either partially or completely, and protects the mucous membrane from the attrition of dress; but in the state of erection this duplication is wholly effaced, and the integument rendered tense over the entire organ. In large herniæ and in very large tumours of the scrotum again, the integument, from its extreme looseness of attachment, is withdrawn from the penis, and contributes to the investment of the swelling. In this way the whole of the integument is sometimes distended with the tumour, and the penis lies buried in the enlargement; its situation being only distinguishable by means of a valvular opening, through which the urine trickles. Like all loose cellular tissue which

is indisposed to the production of fat, the cellular tissue of the penis, in a state of inflammation, is particularly liable to serous infiltration, which renders the organ swollen and œdematous.

The *fascia penis* is a thin but dense layer of white fibrous tissue, which immediately invests the penis, forming for it a kind of sheath, and is continuous with the superficial perineal fascia. On the dorsum penis the fascia covers in the dorsal vessels and nerves, and is closely connected with the aponeurosis of the erectors penis muscles; indeed it is rendered tense and stretched over the organ by the action of those muscles.

The *corpus cavernosum* forms more than two-thirds of the bulk of the penis; it is usually described as two distinct bodies under the name of *corpora cavernosa*, but it is more correct to consider it as a single organ divided posteriorly into two parts, and separated in the interior by an imperfect partition. Apart from the other components of the penis the *corpus cavernosum* represents a lengthened cylinder somewhat flattened from above downwards and grooved along the middle line both upon its upper and under surface; the upper groove lodging the dorsal vein, arteries and nerves, and the under the *corpus spongiosum*. Anteriorly the *corpus cavernosum* terminates in an oblong and rounded extremity, which is received into a depression on the posterior surface of the glans; and posteriorly it divides into two rounded and conical processes, about two inches in length, which separate from each other and are firmly inserted into the everted edge of the ramus of the ischium and pubis under the name of *crura penis*.

The *corpus cavernosum* is closely connected to the glans penis and *corpus spongiosum* by dense areolar tissue and by a few vessels of communication. Behind and inferiorly it is attached to the rami of the ischia by its two *crura*; and above it is connected to the symphysis pubis by means of a strong fibrous ligament of a triangular form, the *ligamentum suspensorium penis*. This ligament is inserted by one border into the fibrous structure covering the symphysis pubis, and by its base is continuous with the aponeurosis of the erectors penis muscles and with the fascia penis; the remaining border being free and directed forwards. In a few rare instances the *ligamentum suspensorium penis* has been found to contain some muscular fibres.

The *corpus cavernosum* is composed of a cellular structure enclosed in a thick fibrous tunic of great strength. The tunic is constructed of longitudinal fibres closely interwoven with each other so as to constitute a tissue which possesses perfect elasticity, and yields freely to distension up to a certain point, but resists enlargement beyond that limit. From the interior of this tunic are given off a number of fibrous bands and cords (*trabecule*) which pass in a radiated direction from the middle line of its inferior wall to the rest of the internal circumference of the cylinder, to which

they are firmly attached. The trabeculæ are most abundant in the middle line of the organ, where they are extended in a vertical direction from the middle line of the inferior to the middle line of the superior wall, forming a partial septum between the two lateral halves of the corpus cavernosum. The median partition is most complete posteriorly; in front it is very deficient, and being composed of parallel fibrous cords, between which the cellular structure of the two sides of the organ communicate, has given rise to the idea from which it received its name of *septum pectiniforme*. The fibrous cords of the corpus cavernosum serve, by means of their attachment to every point of the interior of its fibrous tunic, to equalise the pressure of the circulation during erection, and prevent the undue distention of its walls. The fibrous tunic is variable in degree of thickness in different parts of its extent; thus it is thin upon the crura penis, and is thin also in the situation of the inferior groove and at its extremity; in the two latter situations it is pierced by several vessels which communicate with those of the corpus spongiosum and glans penis.

The cellular structure of the corpus cavernosum is composed of a plexus of dilated veins, which communicate with each other so freely as to represent, when divided by a section, a perfect network of cells separated from each other by membranous parietes. The area of these venous cells are smallest near the circumference of the corpus cavernosum, where they are separated by a greater thickness of parietes, and greatest in the centre of each lateral half, where the intervening septa are thin and membranous. The veins are lined in their interior by a continuation of the common internal coat of the veins, and the interspaces between them are occupied by contractile fibrous tissue. The contractile fibrous tissue is disposed in parallel fibres separated to unequal distances by common areolar tissue; it is most abundant in the thicker parietes of the veins of the circumference of the corpus cavernosum, and is diminished to two or three fibres in the thinner walls of the central veins. The fibres are straight in their direction, and arranged transversely with regard to the cylinder of the corpus cavernosum. Upon meeting the cylinder of a vein in their course they diverge at an acute angle, and continue their straight direction until again obstructed by another vein, when they again separate without exhibiting any tendency to converge and enclose the vein. At the point of divergence they are crossed by other fibres at the same angle, but coming in a different direction, so that the parietes between each vein are formed by numerous fibres of this tissue, crossing each other at the angles of interstice between three or four veins, but straight and parallel between every two contiguous veins. The contractile fibrous tissue is remarkably abundant in the horse, where, from the redness of its hue, it resembles muscular substance; in man it is not abundant but very distinct, and in some situations I was enabled to detect it encircling the cylin-

ders of the veins, and forming as it were an additional coat to those vessels.

The contractile fibrous tissue of the corpus cavernosum has been made the subject of controversy between several of the physiologists of Germany, on account of its resemblance to muscular substance and the absence of other attributes of muscular fibre. It is described by Müller in the 48th number of the *Medicinishe Zeitung des Vereins für Heilkunde in Preussen*, as a peculiar, red, fibrous substance, and in the *Archiv* for 1835* he speaks of it as a "substance having a fleshy muscular appearance, of a pale red colour in the penis of the horse, and also in the dog and man. It forms an irregular network of columns (Balken) distantly resembling the network and trabecular structure of the muscular column of the heart." His next inquiry was to determine the nature of this substance. "To decide," he says, "whether a reddish fibrous tissue be muscular or otherwise, there are three modes,—the microscope, chemical re-agents, and experiment on the living body. In vivisection of the horse, dog, and ram, I saw no contraction of this substance under the influence of the galvanic current. The results of microscopic investigation in the horse are unfavourable to the opinion that it is muscular, for the fasciculi present no indication of the characteristic transverse striæ of muscular fibre, for although the transverse striæ be indistinct on the muscular fasciculi of organic life, they nevertheless exist. In stating the results of chemical investigation, I must remark that I speak solely of this peculiar substance as examined in the horse, and not of that of any other animal or of man. To render these experiments accurate and certain, it is necessary to remove from the tissue every particle of tendinous fibre which may pervade it, for this, as we shall perceive, has a very different chemical composition. In chemical characters, the substance under consideration does not belong to those tissues which afford gelatine by boiling, as is the case with tendinous, cartilaginous, and cellular tissue; for, after seven hours' boiling, I was unable to extract from the pure tissue, separated from all foreign substances, the slightest trace of gelatine. By boiling we obtain a substance precipitable by infusion of galls, which does not gelatinize, but gives off a powerful odour of osmazome. It agrees with muscular fibre and fibrine in being precipitated from a solution in acetic acid by ferro-cyanate of potash, and differs in this respect from the class to which cellular tissue, tendinous tissue, and elastic tissue belong, for these are not invariably precipitable from a solution in acetic acid by ferro-cyanate of potash. It would, however, be incorrect to deduce the conclusion that this tissue must therefore be muscular, for there exists an entire class of substances whose solution in acetic acid is precipitable by ferro-cyanate of potash, such as albumen, fibrine, muscular tissue, and corneous tissue."

* Page 28, in his report for the preceding year, in reply to a misapprehension on the part of Krause.

Krause,* having recourse to the chemical investigation of this substance in man, came to a very different conclusion from that of Müller. "After many hours boiling," he says, "the fibres of the corpus cavernosum of man are converted almost wholly into gelatine, whereas, in boiling muscular substance, the cellular substance alone suffers this change, and the muscular fibre becomes still more evident. Again, if a portion of the boiled internal structure of the corpus cavernosum, not as yet reduced to jelly, and a portion of muscular fibre boiled for an equally long time, be examined with the microscope, the difference is more apparent than in the fresh condition. A solution of the fibrous structure of the corpus cavernosum (previously well washed with water) in concentrated acetic acid is not precipitated by ferrocyanate of potash, whereas a similarly treated solution of muscular fibre affords an abundant white or blueish-white precipitate." In reply to Krause's analysis, Müller remarks: "it will be seen that our investigation on the corpus cavernosum of the horse gives a precisely opposite result to that of Krause on the same part in man; whence it follows, either that Krause has examined this peculiar substance mingled with other structures, as cellular tissue, &c., or that it does not exist in man. Had Krause investigated the tissue described by me in the penis of the horse, he would undoubtedly have met with the same results which I have so constantly obtained."

Besides the fibres of contractile fibrous tissue distributed through the parietes of the venous canals, the arteries and nerves of the corpus cavernosum also ramify in the intercellular substance in their course through the structure of the penis.

The *corpus spongiosum* (corpus cavernosum urethræ) is a lengthened cylindrical body situated along the under surface of the corpus cavernosum in its inferior groove, and forming the inferior border of the penis. It commences posteriorly between and beneath the crura of the penis by a rounded enlargement, the *bulb*, and terminates at the extremity of the organ in the *glans penis*; the intermediate portion is cylindrical in form, and enlarges gradually from its middle towards the two extremities, the bulb posteriorly and the base of the glans in front.

The glans penis resembles in form an oblique section of a cone, rounded at its apex; it is slightly compressed from above downwards, and is terminated posteriorly by a prominent border, the *corona glandis*. At the apex of the glans is a small vertical slit, the *meatus urinarius*, which is bounded by two more or less protuberant labia, and extending backwards along the middle of its under surface is a grooved raphé, to which is attached the *frænum præputii*. The colour of the glans penis presents a deeper tint of red than that of the neighbouring integument, and is invested by mucous membrane. At the meatus urinarius this membrane is continuous with the mucous lining of the urethra, and at the base of the

glans is reflected on the inner surface of the prepuce, as far as the free margin of the latter. The corona glandis is studded by a number of small papillary projections, formed by sebaceous glands, the *glandulæ Tysoni* (*odoriferæ*), which pour out a whitish, unctuous, and strongly scented secretion to lubricate the surface of the glans and prepuce. Behind the glans is a deep furrow, bounded by the corona in front, and posteriorly by the fold of the prepuce.

Examined with the microscope, the surface of the glans penis is found raised into small rounded papillæ which cover every part of its surface.

The corpus spongiosum is traversed in the direction of its length by the common urino-sexual canal, the urethra. At the commencement of the corpus spongiosum, the urethra occupies a groove upon the upper surface of the bulb; further on it enters the substance of the body, but lies much nearer to the upper than the lower surface, while at its termination it occupies the lower segment of the glans.

The corpus spongiosum resembles the corpus cavernosum in being composed of a plexiform vascular structure enclosed in a dense and strong fibrous investment, but it differs from that body in the smaller size of its venous canals, the thinness of its fibrous tunic, and especially in enclosing the canal of the urethra. The vascular structure of the corpus spongiosum, like that of the corpus cavernosum, consists of dilated veins of smaller size than those of the latter body, and separated in the same manner by membranous parietes. In the glans penis the veins are even smaller than in the body of the corpus spongiosum, particularly near the surface and around the embossed border of the corona glandis. The contractile fibrous tissue appears to me to be similarly distributed between the veins, but is smaller in quantity than in the corpus cavernosum. Mayer also describes this tissue as existing in the parietes of the venous canals of the corpus spongiosum, but Müller denies its existence in that body, and observes, "in the corpus spongiosum, where Mayer also admits this substance, it is not present, at least it is perfectly clear that it does not exist in that body in the horse." The fibrous tunic of the corpus spongiosum is continuous at its bulb with the anterior layer of the deep perineal fascia.

The *mucous membrane* of the penis is the lining of the urethra and the investment of the glans and internal surface of the prepuce. In the canal of the urethra, near the extremity of the organ, it is of a deep pink colour, and becomes gradually paler as it approaches the bladder. By the contraction of the coats of the urethra it is thrown into longitudinal folds; and it is furnished with numerous small lacunæ, which are especially numerous along the upper surface of the cylinder. The openings of these lacunæ are directed forwards, and are calculated to afford an impediment to the passage of any small instrument into the bladder by catching its point. One lacuna of larger size than the rest is situated in the upper wall of the urethra, at about an inch and a half from the

* Hecker's Annalen, February, 1831.

meatus; it terminates by several ramified ducts in the submucous tissue of the canal. The mucous membrane of the urethra is separated from the tissue of the corpus spongiosum by a moderately thick fibrous layer, which is continuous with the external tunic of the spongy body.

Sir Everard Home conceived that the external tunic of the canal of the spongy portion of the urethra was muscular, and states with regard to it: "the muscular covering by which the membrane is surrounded or enclosed is made up of fasciculi of very short fibres, which appear interwoven together and to be connected by their origins and insertions with one another; they have all a longitudinal direction." "The fasciculi are united together by an elastic substance of the consistence of mucus." Sir E. Home is mistaken with regard to the muscularity of the external tunic of the spongy urethra, but his description, as it relates to the disposition of the fibrous tissue, is correct. Indeed it is evident that it is to this tissue that Sir E. Home alludes, from a subsequent passage in his essay, wherein he identifies his muscular coat with the fibrous lining of the canal of the corpus spongiosum. Thus he writes: "Immediately beneath the muscular portion of the urethra is the cellular structure of the corpus spongiosum." And this inference is still further corroborated by his belief that the external fibrous tunic of the corpus cavernosum has also "an admixture of muscular fibres."

The muscles of the penis are, the *erectores urinæ*, *ischio-bulbosi*, and *compressores venæ dorsalis*.

The *erector penis* (*m. ischio-cavernosus*) is the muscle of the corpus cavernosum. It arises by tendinous fibres from the anterior part of the tuber ischii, from the internal border of the ramus of the ischium, and from the root of the crus penis; it then curves in an oblique direction around the corpus cavernosum, and terminates partly by becoming inserted into the side of that body, and partly by a tendinous aponeurosis, which is continuous with a similar aponeurosis derived from the opposite muscle. In the first part of its course the muscle is tendinous; where it is spread out on the crus penis and corpus cavernosum it forms a thin fleshy layer, which is prolonged for about one-third along the penis, while in the rest of its extent it is again tendinous, and constitutes the thin aponeurosis above described. The *erector penis* appears to effect its action as an erector by compressing the crura and vena dorsalis, and is aided in this office by the connection of its aponeurosis by means of the suspensory ligament with the symphysis pubis. When called into exercise both muscles act together, and by their united action embrace the root of the penis, and strongly compress it. The effect of pressure on the vena dorsalis must obviously be to impede the return of the venous blood from the penis, and the compression of the crura produces the same result on the veins of the corpus cavernosum.

The *acceleratores urinæ* (*m. bulbo-cavernosus*) are the muscles of the corpus spongiosum;

they are situated on the posterior third of that body, and form a thin muscular plane which surrounds its cylinder, and is spread out upon the under surface of the bulb. Each muscle arises from the posterior border of the deep perineal fascia at the middle line, and from a median raphé which is closely adherent to the under surface of the bulb and corpus spongiosum, and which connects it with its fellow of the opposite side. From this extensive origin the fibres of the muscle pass obliquely outwards and forwards, the most posterior to be inserted into the ramus of the ischium and pubis, the middle and most numerous to encircle the corpus spongiosum, and uniting by tendinous fibres with the muscle of the opposite side upon the upper surface of that body, to be inserted into the inferior groove of the corpus cavernosum; and the anterior forming a narrow fasciculus to pass outwards upon the corpus cavernosum and be inserted into its fibrous tunic and into the fascia penis. The posterior fibres are almost transverse in their direction, and cross the triangular interval between the bulb and crus penis, being separated from the deep perineal fascia by the superficial perineal vessels and nerve, and by the *ischio-bulbosus* muscle when it exists.

The *acceleratores* are well calculated to contract forcibly the canal of the urethra, and thus to communicate an expulsive impetus to the stream of urine or seminal secretion passing along the tube. The expulsive action of these muscles is made sensible to the hand when we withdraw a catheter; and the strength of its gripe, when the catheter has been lodged in the bladder. Indeed their complete contraction constitutes an impassable though temporary obstruction to the passage of the catheter along the urethra, and gives rise to that form of impediment which is known by the name of spasmodic stricture. The contraction of these muscles, moreover, acting suddenly on the urethra, serves to expel the last portions of urine and seminal secretion. Besides the influence which they exert on the urethra, the *acceleratores urinæ* also enact the part of *erectores* of the penis, by producing so much pressure on the bulb and posterior part of the corpus spongiosum as may impede the return of blood through the *venæ corporis spongiosi*, and at the same time press forwards the contents of the venous plexus of the bulb into the anterior part of the corpus spongiosum and glans penis; and their action in this respect is increased by the tension made by their anterior fasciculi on the fascia penis, and through it on the vena dorsalis.

The *ischio-bulbosus* (*m. transversus perinei alter*; *m. transversus perinei profundus*) is a small fan-shaped muscle situated in the triangular interspace between the bulb of the urethra and crus penis, and is not infrequently wanting. It arises by a pointed origin from the ramus of the ischium, and passing obliquely inwards across the triangular space above described, spreads out into a thin fan-shaped plane, and is inserted into the fibrous tunic of the bulb. On one occasion I found this muscle

so large that it extended forwards to the middle of the penis, and usurped the place of the accelerator urinæ, which was absent. The ischio-bulbosus muscle is separated from the transversus perinei by the folded border of the deep and superficial perineal fasciæ, and from the compressor urethræ by the anterior layer of the deep perineal fascia. It covers in the internal pudic vessels and nerve.

The action of the ischio-bulbosi muscles is to compress the bulb, and by their pressure to aid the posterior fasciculi of the acceleratores urinæ in producing turgescence of the corpus spongiosum. In the variety to which I have alluded above, the ischio-bulbosi must have performed the whole of the duty of the acceleratores.

The *compressor venæ dorsalis penis* is a small muscle, first described by Dr. Houston,* of Dublin. According to that gentleman it is found very commonly among mammiferous animals, and also in the human subject when the muscular system is well developed. To its existence in the dog and cat I can bear witness, having repeatedly prepared it for Dr. Jones Quain, who was wont to demonstrate it in his lectures; I have been less successful in the human subject, and have never obtained a satisfactory view of a distinct pair of muscles in the situation indicated by Dr. Houston. "In man," writes this author, "the compressores venæ dorsalis are less distinct than in most of the mammalia. They arise from the rami of the pubis above the origin of the erectores penis and crura, and ascending in a direction forwards are inserted above the vena dorsalis by joining with each other in the mesian line. They form a thin stratum of muscular and tendinous fibres about an inch long and three quarters of an inch broad, and may perhaps be looked upon as portions of the erectores penis, which, instead of being inserted into the sides and lower part of the corpora cavernosa, mount over those bodies to exert their compressing influence on the vena dorsalis. They enclose between these and the penis, the veins, arteries, and nerves of this region. Their anterior fibres are distinguished from those of the erectores by the fibrous attachment of the crura to the pubis; their posterior margins are kept distinct from the front part of the levatores ani, known under the name of Wilson's muscles, by the pudic artery, which divides them in its course towards the dorsum of the penis."

"The best procedure to display these muscles is the following. Detach the bladder and levator ani with the hand from one side of the pelvis; then divide with the saw the pubis and ischium about one inch from the symphysis, and break off the bones at the sacro-iliac articulation; next dissect away carefully the remaining portion of the pubis from the symphysis, periosteum, and crura penis, and then the compressores venæ, bearing still their natural relations to the crura and other muscles, may be exposed with very little difficulty. The

insertion of the muscles being in a great measure outside the pelvis, they may also be demonstrated without the section of the bones, by cutting on them in front of the pubis and looking carefully for their tendon at the side of the vena dorsalis: from the tendon the knife may be carried downwards and backwards in the course of the fibres, and nearly the whole of the muscle can be thereby exposed. It must, however, be remembered that it will be needless to search for them in a thin emaciated individual, where the other muscles of the perineum are so pale and soft that even they can scarcely be distinguished. The subject should be robust, and the muscles red, in order to demonstrate them."

Respecting the action of these muscles Dr. Houston observes: "The use of the musculi compressores venæ is self-evident and cannot be mistaken; the effect of their contraction will be to close the vein and mechanically obstruct the current of blood. A simple experiment will prove to demonstration that such will be the necessary result of their contraction. Let the muscles be stretched in the natural direction of their fibres, and any fluid forced into the vein will not find a passage through the vessel beyond the spot where it is compressed by their tendon: a very gentle pull of the muscles will be sufficient to produce this effect. In cases where the vein runs through the tendon the pressure will be most efficacious, but even in those in which the tendon is arched over the vein its descent from the contraction of the muscles will sufficiently compress the delicate tunics of the vessel to produce the required effect."

The arteries of the penis are derived from the internal pudic, itself a branch of the internal iliac artery. They are three in number on each side; the artery of the bulb, the artery of the corpus cavernosum, and the arteria dorsalis penis.

The *arteria corporis bulbosi* is given off from the internal pudic at a point corresponding with the level of the urethra, and passes transversely inwards to the bulb, which it enters close to the lower part of the urethra. In its course inwards it lies along the upper border of the transverse portion of the compressor urethræ muscle, and crosses that muscle obliquely from within outwards. It is situated between the two layers of the deep perineal fascia, and is surrounded by a sheath derived from the anterior layer of the fascia as it enters the bulb. Having entered the corpus spongiosum, the artery runs forwards in the midst of the venous canals of that body to the glans penis, in which it distributes its ultimate branches. In its course the arteria bulbosi gives off numerous ramusculæ, which ramify in the walls of the venous canals.

The *arteria corporis cavernosi* is given off from the internal pudic, somewhat nearer to the symphysis pubis than the preceding, and opposite the point of junction of the crura penis; it pierces the fibrous tunic of the crus penis on its inner side, to enter the structure of the corpus cavernosum. In the latter it

* Dublin Hospital Reports, vol. v. page 459.

runs forwards by the side of the septum pectiniforme, distributing many branches in its course, which ramify in the parietes of the venous canals.

The *arteria dorsalis penis* may be regarded as the continuation of the internal pudic, after the latter has given off the *arteria corporis cavernosi*. It commences opposite the junction of the crura penis, and piercing the anterior layer of the deep perineal fascia, ascends to the groove upon the dorsum penis. In this groove it runs forwards to the base of the glans, where it divides into several branches, which enter the substance of that body and are distributed to its structure. The *arteria dorsalis* is separated from its fellow by the dorsal vein, and gives off numerous branches in its course to the fibrous structure of the penis and integument.

The veins of the penis correspond with the arteries which they accompany in their efferent course. The *vena corporis bulbosi* and *vena corporis cavernosi*, issuing respectively from the bulb and crura penis, take the course of the internal pudic artery, and constitute the internal pudic veins. At the root of the penis these veins communicate with the dorsal vein.

The dorsal vein commences by numerous large branches, the chief of which issue from the base of the glans beneath the corona, and form by their communications a considerable plexus on the anterior part of the corpus cavernosum, the others being the veins of the prepuce and integument. The union of these veins constitutes two trunks of equal size, which, after running side by side for a short distance, unite and form the dorsal vein. The dorsal vein in its course towards the root of the penis passes beneath the aponeurosis of the erectors muscles, together with the attachment of the suspensory ligament, and after piercing the deep perineal fascia, divides into several branches which join the prostatic and vesical plexus. It receives in its course several large branches from the corpus spongiosum, which curve around the corpus cavernosum in order to reach it, and communicates at the root of the organ with the deep veins of the penis. The dorsal vein is situated in the middle line of the groove of the dorsum penis, having its corresponding artery at either side, and being covered in by the fascia penis and conjoined aponeurosis of the erectors penis muscles. It is in this relation to the fascia penis and aponeurosis of the erectors that enables the latter to compress the vein forcibly against the dense fibrous coat of the corpus cavernosum, and thus intercept the current of venous blood.

The question of the ultimate arrangement of the bloodvessels in the substance of the penis leads to enquiry into the nature of erectile tissue, a subject to which a separate article has been devoted in the earlier pages of this work, and to which I must now refer my reader. From my own investigations into the structure of this tissue in the corpus cavernosum and corpus spongiosum, I have come to the conclusion that the arteries ramify and terminate in capillaries as in other parts of the

body, and that these latter very speedily become dilated veins. In the distribution of the veins the only peculiarity of this tissue exists; these by their tortuous windings form an inextricable plexus, which fills the whole area of the fibrous tunics of the corpus cavernosum and spongiosum, and constitutes their component substance. In this plexiform aggregation of veins, the walls of the vessels so closely approach as to leave between them only so much connecting tissue as serves for the ramification of the arteries and nerves of the organ, and for the passage of the fibrous trabeculae and fibres of the contractile tissue. It follows from this arrangement that the area of the veins bear a much greater proportion to the bulk of the tissue than do the septa between them, and, consequently, that if a section of the corpus cavernosum be made, its parenchyma will have the appearance of a cellular network, an appearance that is rendered much more striking when the penis has been inflated and dried. It is obviously this appearance of the parenchyma of the corpus cavernosum that has gained for it the character of being composed of cells, and in truth, as far as the plane of the section is concerned, the portions of venous canals which open on the surface have all the attributes of divided cells. According to the position of the veins at the point of section, the cell in one spot is shallow and small, in another it is lengthened, either in the longitudinal or in the transverse direction of the axis of the corpus cavernosum, and in a third, again, the apparent cell is irregular in form, from the conjunction at that point of two or more veins. If, in the next place, we turn our attention to the septa of the apparent cells, we shall meet with spots in which from the close assemblage of the veins the septum has the appearance of a star giving off a number of thin lines in a radiated direction to form partitions between three, four, or five veins which meet at that point. Now let us suppose that this observation is being made on the parenchyma of the corpus cavernosum, the arteries of which have been previously injected with fine injection. Where do we look for the injected arteries? Obviously in the septa, and especially at that thicker portion of the septum where several veins lie in contact. And what, we may ask, is the probable appearance of the arteries in that star-like point of septum which I have described above? I can answer this question, from repeated observation. It is that of a short trunk giving off two, three, or four small and short terminal branches, which diverge in an oblique direction from the extremity of the small trunk, and terminate abruptly at the cut margin of the septum. I have seen the appearances here described many times, sometimes better, sometimes less distinct, and more frequently as a bifid division than another, and these I apprehend are the *arteria helicinae* of Müller. Besides the preceding, the special characters of the *arteria helicinae* are their projection in the form of a tuft into a venous canal, and the curved, swollen, and conical form of the small branches

at their extremities. The first of these appearances is due to the accidental position of the section under the microscope, so that the short trunk with its terminal twigs appears to be placed within the area of a vein projecting into it like a blossom on its stalk; the second results from the contraction of the coats of the artery, the effects of the longitudinal contraction giving rise to the curve and to the enlargement near its extremity, and the transverse contraction, by producing the expulsion of some part of the injection, to the conical form of the extremity itself. "These remarkable arteries," writes Müller,* "have a great resemblance to the tendrils of the vine, only that the arteries are much shorter in proportion to their thickness; from this resemblance I have named them *arteriæ helicinæ* or tendril-like arteries. We may also compare their ends to the top of a crook. By close examination with the microscope they may be seen projecting into the venous cells, not, however, bare, but covered with a fine membrane that under the object-glass looks horny."

If the description which I have here given of erectile tissue be the true one, it is clear that the *arteriæ helicinæ* have no existence, and that that appearance of the small vessels, to which Müller has given this name, is a necessary consequence of the natural distribution of the ordinary vessels of the organ. I may be permitted to remind my junior reader that it was through the medium of the *arteriæ helicinæ* that Müller supposed the venous canals of erectile tissue to be filled during erection, while, for the purposes of nutrition and maintaining the ordinary circulation of the organ, the arteries pour their blood into capillaries, and these into veins. Excepting during the moment of discharging their blood, this physiologist conceived that the small curved terminal twigs were impermeable, and that it was only under the influence of the erectile nervous function attending erection that the impetus of the arterial blood was sufficient to open the concealed apertures at their extremities.

The *lymphatic vessels* of the penis are found chiefly on its dorsum, taking the course of the dorsal vein. At the root of the organ they curve outwards to the groin, and communicate with the upper group of inguinal glands. I have frequently seen a small lymphatic gland on the dorsum penis near its root.

The *nerves* of the penis are derived from the internal pudic and from the hypogastric plexus; those from the former source are the anterior superficial perineal nerve, the nerve of the bulb, and the dorsalis penis nerve.

The anterior superficial perineal is a branch of the perineal division of the internal pudic. It enters the perineum at the posterior border of the deep perineal fascia, and passing onwards in the groove between the erector penis and accelerator urinæ, gives branches to the scrotum, and is finally distributed to the integument of the under part of the penis as far as the prepuce.

The nerve of the bulb is also a branch of the perineal division of the internal pudic, and likewise enters the perineum through the posterior border of the deep perineal fascia. Between the superficial and deep fascia, and behind the transversus perinei muscle, the nerve passes obliquely forwards to the bulb, where it gives off several long and slender branches, which run forwards on the fibrous tunic of the corpus spongiosum, and then enters the bulb in company with the artery, to be distributed to the vascular parenchyma of that body and to the urethra as far as the glans penis.

The perineal division of the internal pudic nerve also gives branches to the acceleratores, erectores, and ischio-bulbosi muscles.

The dorsal nerve of the penis is the superior or deep division of the internal pudic. This nerve accompanies the internal pudic artery to the anterior part of the arch of the pubis, where it pierces the deep perineal fascia and passes onwards to the dorsum penis. In the latter situation it lies externally and somewhat superficially to the dorsal artery, and enters the base of the glans penis by several branches, to be distributed to the papillæ of that body. Near the root of the penis the dorsal nerve gives off a large branch, which passes obliquely along the side of the corpus cavernosum, and divides into numerous long and slender branches, which are distributed to the integument of the upper and lateral aspect of the penis, to the fibrous covering and substance of the corpus cavernosum, and to the prepuce. The *nervi dorsales* communicate with each other, on the dorsum penis, by anastomosing filaments.

The nerves derived from the hypogastric plexus are slender ramuscles, which accompany the arteries of the corpus cavernosum and bulb into the interior of the penis, and are distributed to its internal structure.

Development.—The first indication of the development of a penis is perceived towards the end of the fifth week after conception, at which time it exists in the form of a slight prominence, situated immediately in front of the common urino-sexual aperture. By the seventh or eighth week this prominence assumes the lengthened character of the future organ, and is grooved along its under side, the groove being an extension of the common urino-sexual cleft. The glans penis makes its appearance during the ninth week, and the urinary groove is continued beneath it. During the tenth and eleventh weeks the urinary groove becomes separated from the anus by the growth of a transverse septum, and the borders of the groove begin to lengthen and coalesce on the median line, in order to form the urethra. This process commences from behind, and proceeds forwards towards the glans, attaining its completion at about the fifteenth or sixteenth week. When it remains imperfect from arrest of development, it constitutes that form of deficiency which is termed Hypospadias. The prepuce is developed at the same time with the closure of the urethra.

* Archiv, 1835.

PERICARDIUM.—See HEART.

PERINEUM (in Surgical Anatomy).—The perineum (in the general acceptation of that term) is one of the names applied by anatomists to the extensive region which contains the lower part of the rectum intestine, together with a portion of the genito-urinary organs and their appendages, and of which the circumference corresponds in a great measure to the periphery of the inferior aperture of the pelvis; in the present article, however, it is intended to describe the perineum in the male subject only, as the parts which it comprises in the female are noticed in detail under other headings in this work.

The limits which we would assign to this region are sufficiently precise: superiorly, or towards the abdominal cavity, it extends as far as the reflections of the recto-vesical layer of the pelvic fascia and the great cul-de-sac of the peritoneum, including within its precincts the prostate gland and the neck of the bladder, together with a part of the inferior surface of that viscus and the vesiculæ seminales and vasa deferentia; inferiorly, the perineum is quite superficial, being covered by the integuments only; and it is circumscribed partly by the fixed boundaries of the inferior aperture of the pelvis, and partly by the obturator fascia, an aponeurotic expansion which appears to line a portion of the inner surface of the os innominatum, but is in reality separated from the bone by the obturator internus muscle and the internal pudic vessels and nerve.

In describing this complicated region it will be advantageous to consider in the first place the osseous and ligamentous structures which circumscribe the inferior outlet of the pelvis, and to notice in a general manner the course of the rectum and urethra, together with so much of the urinary bladder as is connected with the perineum, for in the sequel it will appear that the rectum and the urethra are the principal elements of the region, and that almost all the other parts contained in it are appendages of either the one or the other, so that by the adoption of this method a key to the anatomy of all the subordinate structures will be obtained.

The inferior aperture of the male pelvis examined after the removal of the soft parts (the sacro-sciatic ligaments being preserved) is diamond-shaped; it is limited anteriorly by the arch of the pubis, posteriorly by the extremity of the coccyx, and laterally by the rami of the pubis and ischium, the tuberosity of the ischium, and the great sacro-sciatic ligament at each side respectively. It presents three diameters, viz. the antero-posterior, the transverse, and the oblique. The first extends from the coccyx posteriorly to the symphysis pubis in front; the second passes transversely between the tuberosities of the ischia; and the third stretches from the point midway between the tuber ischii and the arch of the pubis, to the centre of the great sacro-sciatic ligament of the opposite side. In a well-formed male pelvis these three diameters are almost equal, being each of them nearly three and a-half inches in extent; but in conse-

quence of the mobility of the coccyx that bone may be moved backwards considerably, and under such circumstances the antero-posterior diameter becomes increased to a corresponding amount.

This large space admits of a very natural division into two triangles, one in front, the other posteriorly; the base of each respectively corresponds to the line passing transversely between the tuberosities of the ischia, and the apex of the one is formed by the arch of the pubis, whilst that of the other is constituted by the extremity of the coccyx.

The anterior triangle is equilateral; its sides are formed by the rami of the ischium and pubis, and are each from three inches to three and a-half inches in length; it contains the urethra and the root of the penis, with their appendages, and may be named the urethral division of the perineum.

The posterior triangle is bounded laterally by the great sacro-sciatic ligaments, and in the recent state by the edge of the gluteus maximus muscle also. The coccyx usually protrudes forwards so much that the area of the posterior triangle is less than that of the anterior, notwithstanding that the base of each of them is represented by the same line. This posterior triangle contains the anus with the inferior portion of the rectum, &c., and is usually called the anal division of the perineum.

It should be borne in mind that the measurements of the inferior outlet of the pelvis may present considerable variations in different subjects, and that the operator may be obliged to modify the length and the direction of his incisions in lithotomy to suit such cases. M. Dupuytren, for example, in twenty-three subjects which he examined, found the distance intermediate between the tuberosities of the ischia to vary from two inches to three and a-half inches; and M. Velpeau, who measured forty subjects, observed in one case these processes to be but an inch and three quarters asunder, whilst in another they were four inches apart.

In order to perform successfully many of the operations in this region the surgeon requires an accurate knowledge of the axes of the pelvis, and to study the modifications which these imaginary lines exhibit in childhood and old age as compared with adult life. In the full-grown male the axis of the superior aperture of the true pelvis takes a direction from the vicinity of the umbilicus downwards and backwards to the coccyx, whilst the axis of the inferior aperture passes upwards and slightly backwards through the mid space between the tuberosities of the ischia to the promontory of the sacrum; these two lines intersect each other in the pelvic cavity, forming an angle slightly obtuse and salient posteriorly: the axis of the true pelvis (or in other words a line passing through the centres of the upper and lower apertures respectively) is therefore a curved line concentric with the curvature of the sacrum, and having its concavity directed forwards and downwards towards the symphysis pubis.

During childhood the true pelvis is imperfectly developed; it has but little depth, and its

capacity is so limited that the viscera which occupy the pelvis of the adult are mostly contained in the abdominal cavity of the infant. The straits of the pelvis have each of them likewise an aspect different from that of the adult; in the child the superior aperture looks much more directly forwards, and the inferior aperture much more backwards than they do after puberty. These peculiarities are inherent in the infantile pelvis: they are independent of any inclination in the vertebral column, and they must therefore modify considerably the direction of the pelvic axes during the early years of growth.

In the old subject again the superior aperture is once more directed forwards as in the infant, whilst the inferior aperture inclines backwards; at this period of life, however, the change in the pelvis arises not from any intrinsic alteration in its bony parietes, but simply from the senile curvature of the spine above, added to the habitual flexion of the hip and knee-joints below, so constantly observed in the aged individual.

To understand the course of the rectum and the urethra, as well as the relations of the base of the bladder, the anatomist must study these parts within the pelvis, since it is impossible to display them satisfactorily in the ordinary dissection of the perineum; much assistance may be derived from preparations affording a side view of the pelvic viscera, and one of the most useful is an antero-posterior section carried through the middle line and dividing the urethra, prostate gland, bladder, and rectum, &c., after these organs have been moderately distended and hardened by alcohol.

RECTUM.—The portion of intestine which belongs to this region commences at the great cul-de-sac of the peritoneum and terminates at the anus. It is perfectly devoid of any serous investment, and presents considerable varieties in size and direction in different subjects. The age and the habits of the individual are found to exert a remarkable influence upon its course and dimensions, and accidental variations in the line of reflection of the serous membrane, which create corresponding changes in the depth of the perineum, are occasionally observed even in the adult, and ought to be taken into account by the operator.

The great cul-de-sac of the peritoneum is usually about three-and-a-half inches distant from the anus, so that, making allowance for the curved course of the intestine, we may estimate the length of the perineal portion of the rectum in the adult at somewhat less than four inches. In forming this estimate, the condition of the urinary bladder as regards its distension should not be overlooked, for when that reservoir is empty and contracted, the rectum receives an extensive serous investment, and at such times the cul-de-sac of the peritoneum approaches the anus perceptibly, whilst under the opposite condition (that of repletion) the bladder displaces the serous membrane partially, carrying its cul-de-sac upwards towards the abdomen. Individual varieties, irrespective of these changes in the bladder, are, however, of constant occurrence, and in many in-

stances the rectum in the adult is covered by serous membrane anteriorly to within two inches of the anus, the bladder being at the same time fully distended. In the young subject the peritoneum stretches very far downwards along the surface of the bowel, and at birth it very generally covers the front of the rectum to within one inch of the anus; at the age of five years the cul-de-sac of the peritoneum and the anus are still separated by a very trifling interval; but from this period up to puberty the intermediate distance gradually increases, *pari passu*, with the growth of the pelvis and the development of the inferior fundus of the bladder.

At its commencement the perineal portion of the rectum runs obliquely downwards and forwards, this direction it maintains as far as the prostate gland, but it there alters its course and turns slightly backwards to terminate at the anus. Superiorly it presents a slight curvature concentric with that of the sacrum, so that the anterior surface of the gut is there slightly concave, and its posterior surface slightly convex from above downwards: inferiorly, however, the curvature of the intestine is reversed; it appears as it were to turn round the point of the coccyx to gain the anus, and therefore the convexity of the lower part of the gut is directed forwards whilst its concavity looks backwards. This curved course of the rectum ought to be borne in mind by the surgeon in his attempts to introduce instruments into its interior.

In the child the sacrum and coccyx present but a trifling curvature, and therefore the rectum reaches the anus by a less circuitous route than that just described, and which is the normal condition in the adult; during childhood the inclination backwards of the lower extremity of the gut scarcely exists, it possesses but a single curve concave forwards, which, like that of the sacrum and coccyx, is but faintly marked, so that the intestine is much straighter in early life than after puberty. In old age the rectum immediately above the anus is sometimes inflected from side to side so as to assume a zigzag appearance: these lateral inclinations are the result of the enormous enlargement which the bowel occasionally undergoes in the advanced periods of life, its length being actually increased at the same time that its cavity is dilated.

In the adult subject the rectum is somewhat cylindrical in shape, but it increases in capacity as it descends, and presents a marked dilatation just above the sphincters, whilst the anus and so much of the gut as is embraced by those muscles exhibit a decided contraction. In the child the dilatation just described is but little marked, whilst in advanced life it very frequently becomes excessive, and is best appreciated when the intestine is fully distended with fæces or artificially inflated; under such circumstances the anterior wall of the rectum is hollowed into a deep depression or gutter, in which the prostate gland and base of the bladder are imbedded, and the bowel swells outwards and forwards upon each side of the prostate,

losing altogether its cylindrical shape. It will be readily understood that when such a disposition prevails in a calculous subject, the rectum must undergo serious danger during lithotomy performed according to the lateral or bilateral methods, and that therefore the precaution of emptying the bowel previous to these operations is highly advisable.

The relations of the perineal portion of the rectum deserve from the surgical anatomist his most attentive consideration. Anteriorly the inferior fundus of the bladder, together with the vesiculæ seminales and vasa deferentia, come into contact with the rectum immediately beneath the line of reflection of the peritoneum; lower down the prostate gland rests upon the front of the rectum, to which it is very intimately connected, nothing but some cellular tissue intervening between them, whilst still lower down the membranous portion of the urethra and the bulb are related to the rectum, though not immediately, for neither of those parts of the urinary apparatus is found to *touch* the parietes of the gut. The bulb of the urethra in the adult is usually situated about half an inch in front of the rectum and about one inch above the anus; the membranous portion of the urethra lies about ten lines anterior to the rectum, and rather more than an inch and a half above the anus, whilst the prostate gland is placed within one line of the anterior wall of the gut, and about two inches above the anus. These anterior relations of the rectum explain how the finger introduced into its cavity may assist the catheter in its passage along the urethra in the living subject; how by the same manœuvre the surgeon obtains valuable information as to the state of the bladder and prostate gland in various morbid conditions of those organs; how, in sounding, he is able at times to raise up the calculus by his finger so as to bring it into contact with the instrument; how the bladder may be punctured from the rectum and the urine withdrawn by this route in certain cases of retention; how, acute inflammations and other diseases of the bladder and urethra or their appendages so frequently occasion morbid sympathies in the intestine, such as prolapsus, tenesmus, hemorrhoids, &c.; and above all, how great must be the danger to the bowel, and how urgent the necessity for protecting it during the lateral operation of lithotomy.

Posteriorly a quantity of loose cellular tissue connects the lower part of the rectum to the sacrum and coccyx; it is there related, particularly when distended, to the pyriformis and ischio-coccygeus muscles, and towards its anal extremity to some of the fibres of the levatores ani and the ano-coccygeal ligament.

On either side the rectum gives insertion to a portion of the recto-vesical layer of the pelvic fascia, which, though weak and cellular in that locality, nevertheless admits of being fairly traced to the walls of the gut; but the levatores ani muscles constitute the principal lateral relations of the intestine. In their descent they cover its surface extensively, and form in great measure the partition between the bowel and the ischio-rectal fossæ.

The perineal portion of the rectum affords in some respects a striking contrast to the upper part of the same intestine; being totally devoid of serous investment, it is more fixed and (except at the anus) more dilatible than the superior division of the bowel, and its connexions with the recto-vesical layer of the pelvic fascia, the ano-coccygeal ligament, the genito-urinary passages, and the middle tendinous point of the perineum, contribute to fix it still more firmly in its position.

The coats of the rectum present certain peculiarities interesting to the surgical anatomist. Its muscular tunic is of uncommon strength, and consists of two very distinct layers analogous in many particulars to those of the corresponding strata in the œsophagus; the superficial layer is formed of highly developed longitudinal fibres, florid in colour (as contrasted with those of the remainder of the large intestine), and which spread out so as to invest the whole circumference of the gut: the fibres of the deeper layer are circular, and acquire increased development towards the anal extremity of the intestine, where they are continuous with the internal sphincter. The mucous membrane is remarkable for its thickness and vascularity and for the great laxity of its connexion with the other tissues of the gut: it adheres so loosely to the subjacent coat in the vicinity of the anus that it sometimes protrudes through that opening, and in this manner one form of prolapsus ani is produced.

Upon the free surface of the mucous membrane a number of longitudinal folds run down to the immediate neighbourhood of the anus; they are called the columns of the rectum, and converge slightly as they descend; their number is variable though it seldom exceeds eight or ten, and between them inferiorly some transverse semilunar folds may be observed, of which the free concave margins are directed upwards. In these folds of the mucous membrane the physiologist recognises a provision to facilitate the distension of the gut, and to their presence some surgeons attribute the occurrence of certain morbid conditions of the intestine. In addition to these folds, which are constant, others have likewise been described within the rectum; these latter were named by the late Dr. Houston "the valves of the rectum," and appear at times remarkably distinct. When present they are each of a semilunar shape, and formed by a duplicature of mucous membrane containing cellular tissue and a few muscular fibres between its folds. Each valve is attached by its convex margin to the walls of the gut, whilst its free edge is directed more or less inwards towards the cavity of the intestine. One of these valves is situated (according to Houston's statement) opposite to the base of the bladder, on the anterior wall of the gut and about three inches distant from the anus, whilst another is sometimes placed within one inch of the anal orifice.

That projections from the parietes of the rectum, such as have been described by Houston, may be made apparent by a certain mode of preparation cannot be denied, but that they can

or do exert much influence in supporting the weight of the column of faeces within the intestine, or in obstructing the progress of instruments through it, may be very fairly questioned; for when the rectum has been removed from the dead subject and laid open, these valves are in general no longer visible, and the natural curvatures of the bowel explain sufficiently the difficulties encountered in the introduction of rectal tubes or bougies in the living.

Bladder, vesiculæ seminales, and vasa deferentia.—It is here necessary to notice briefly so much of the under surface of the bladder as is uncovered by peritoneum, and to consider in a cursory manner the vesiculæ seminales and vasa deferentia. These structures are situated very deeply in the perineum, and therefore they are dissected with advantage from within the pelvis.

On looking down into the pelvic cavity in a recent subject after the peritoneum has been displaced and the bladder drawn gently to either side, the anatomist obtains a satisfactory view of the course and connections of the recto-vesical layer of the pelvic fascia, which there constitutes the superior boundary of the perineum. The recto-vesical is the innermost layer of the pelvic fascia; after investing the inner surface of the levator ani muscle it is reflected upon the prostate gland and side of the bladder, and more posteriorly upon the rectum; a line drawn from the lower extremity of the symphysis pubis to the spinous process of the ischium is nearly the level at which this reflection takes place. This fascia is closely connected in front to the upper surface of the prostate gland, and in that situation it forms the anterior true ligaments of the bladder; it next adheres to the edges of the gland, and more posteriorly to the sides of the bladder, there constituting the lateral true ligaments of that viscus; whilst still further back it is identified with the sides of the rectum as has been already described. Its attachments to the bladder at either side respectively are situated a little above the vesiculæ seminales.

This fascia forms the line of demarcation between the perineum and the upper portion of the pelvic and the abdominal cavity. It is of sufficient strength to resist powerfully the descent of any of the abdominal viscera through the space between the bladder and the parietes of the pelvis, and affords equal resistance to the progress upwards of matter or other effusions from below; it may be considered as a sort of shelving roof to the perineum, and a concave floor to the abdomen. Its density and strength are at their maximum in front, whilst both these properties diminish as it approaches the rectum. Above it, is found a quantity of loose adipose cellular membrane, continuous without line of demarcation with the subserous tissue of the abdomen, whilst below it are situated the cellular tissue of the perineum and the several parts comprised in the depths of that region. His knowledge of its connections teaches the anatomist that urine effused above the level of this fascia must soon reach the peritoneum and produce the most disastrous

consequences; whilst the experienced surgeon endeavours in every operation upon the perineum to limit his incisions, so as to spare the fascia now under consideration.

That portion of the inferior surface of the bladder which projects into the perineum is bounded posteriorly by the peritoneal cul-de-sac, and extends forwards as far as the prostate gland, whilst the line along which the recto-vesical fascia takes attachment to the bladder forms its lateral limits. The dimensions of this part of the bladder are exceedingly variable, being modified by the degree of vacuity or repletion of the organ itself at the time of examination, as well as by the age of the individual; but its measurements are always much greater transversely than from before backwards. In the adult it is in general of moderate extent, but it increases considerably when the urinary reservoir is fully distended, and it diminishes as that viscus becomes empty, whilst the variable depth of the cul-de-sac of the peritoneum (already dwelt upon in a former part of this article) is calculated still further to render its size uncertain. In the child this region of the bladder scarcely exists, an anomaly explained by the pyriform shape of the organ in early life, the narrow neck of the bladder being then its most dependent portion, and the peritoneum being prolonged very far downwards towards the anus. In old age the perineal portion of the bladder often exhibits extraordinary development, becoming by far the lowest part of the whole organ, and forming a pouch which projects remarkably towards the rectum. In many instances calculi become lodged within this depressed part of the viscus, far beneath the level of the cervix vesicæ, so as to elude detection by the sound; and in this manner is explained the valuable assistance which the finger introduced into the rectum so frequently affords the surgeon in exploring the bladder for a stone. The perineal portion of the bladder rests in great measure upon the rectum; in the middle line it is in immediate contact with the gut, but towards either side a part of the vesicula seminalis and vas deferens is interposed.

This region of the bladder has received special attention from anatomists in consequence of its presenting a small triangular space, in which the operation of recto-vesical paracentesis is, or ought to be, performed. The triangular space in question is usually small and very nearly equilateral; its base, directed backwards and upwards, is formed by the peritoneal cul-de-sac; the vasa deferentia and the vesiculæ seminales to the right and left respectively constitute its sides, whilst the notch in the prostate gland represents its apex. The surgeon ought to consider carefully the extent of surface which the area of this triangle comprises, as well as the average distance from the anus at which it is placed; for should the bladder be punctured behind this "place of election," the peritoneum must be wounded; and should the trocar be introduced in front of it, the prostate gland and common ejaculatory ducts would be endangered, whilst the slight-

est deviation to either side brings the corresponding vas deferens and vesicula seminalis into peril. In the majority of full-grown subjects the space under consideration is about three inches distant from the anus, so as to permit the index finger of the operator to reach it without difficulty; but from statements already made the reader will perceive that many exceptions to this rule may be encountered in practice. Again, the sides and base of this triangle (so long as the neighbouring parts remain in situ) are in general each of them respectively less than one inch in length; yet when the bladder is removed from the subject and artificially distended, and when the connections of the peritoneum are disturbed by dissection, the space to which we refer becomes immensely enlarged, and the anatomist is then apt to form a most exaggerated and erroneous idea of its natural dimensions.

Against the recto-vesical paracentesis many very serious objections may be raised. In early life it should not be attempted, because at that period the peritoneum descends so low, and the under surface of the bladder is so little developed, that injury to the serous membrane of the abdomen would almost necessarily ensue. Even in the adult the great uncertainty of the depth of the peritoneal cul-de-sac, added to the utter impossibility of ascertaining its extent in the living subject, constitutes a weighty argument against the operation; whilst the enlarged prostate (so very common in old men) must frequently forbid its performance in after life; and the danger of wounding the vas deferens or the vesicula seminalis, or of producing urinary infiltration or a permanent fistula, may be fairly urged against this mode of relieving the bladder, at whatever age undertaken. The other methods employed for the same purpose in extreme cases of retention of urine are also no doubt open to valid objections, but any further consideration of this subject would be out of place in the present article.

In order to perform lithotomy successfully, or to tap the bladder with safety, the surgeon should ever bear in mind the direction of the axis of that organ. In the adult male the axis of the bladder runs nearly parallel to the axis of the upper strait of the pelvis; but upon a lower plane, that is to say, nearer to the pubis, if produced, it would pass superiorly through the linea alba between the umbilicus and the pubis, and it would touch the inferior extremity of the coccyx below. In the child its direction is very variable, for the urinary reservoir being then in the abdomen and in contact with the anterior wall of that cavity, must necessarily move in obedience to the abdominal muscles, and every change of position which the bladder undergoes exerts a marked influence upon its axis. During childhood the axis of the bladder appears in *the dead subject* to run from before backwards nearly horizontally, because the distended bladder, no longer supported by the abdominal muscles, turns forwards over the pubis; but in *the living child*,

when the recti abdominis are forcibly contracted, the line in question becomes nearly vertical.

THE URETHRA.—Anatomists describe the urethra as a canal presenting a double curvature, of which the anterior segment is highly moveable, and of which the posterior is in a great measure fixed. The anterior segment (comprising the spongy portion of the urethra from the meatus urinarius to the vicinity of the bulb) exhibits, in the flaccid condition of the penis, a marked curvature concave downwards, which disappears, however, during erection, and which exerts little influence upon catheterism, since the surgeon easily obliterates it by raising the penis until it forms an angle of about forty degrees with the anterior wall of the abdomen. The posterior segment (consisting of the whole of the prostatic and membranous portions of the urethra, and also of the posterior part of its spongy portion) presents on the contrary a permanent curvature concave upwards, and belonging essentially to the perineum, it requires in this place a special description. To dissect the perineal portion of the urethra with advantage, the anatomist ought to remove the greater part of the ossa pubis and the ascending rami of the ischia from a recent subject, with the penis, the bladder, and the rectum attached; this can be easily accomplished by cutting the horizontal ramus of the pubis at each side perpendicularly with a saw as near the acetabulum as possible, after which the instrument may be made to traverse the foramen ovale, and divide the ramus of the ischium in the immediate vicinity of its tuberosity. If the bladder be then inflated from one of the ureters, and the rectum distended, the preparation will exhibit in a satisfactory manner the urethra and many other parts described in this article, of which but an imperfect view is obtained in the ordinary dissection of the perineum from below.

The posterior segment of the urethra represents a reversed arch, of which the centre lies about ten lines beneath the symphysis pubis, whilst the extremities incline upwards, the one in front and the other behind the symphysis. Ample provisions exist to render this arch permanent; its centre, constituted by the membranous portion of the urethra, is transmitted through the triangular ligament, and adheres by its circumference to the edges of the opening through which it passes; its posterior extremity, formed by the prostatic urethra, is tied up to the back of the pubis by the anterior true ligaments of the bladder, whilst the true suspensory ligament of the penis in front, and the prolonged attachments of the crura penis, pinning that organ up to the anterior surface of the pubis, raise the spongy portion of the urethra at its commencement, and consequently elevate the anterior extremity of the arch. The permanency of this arch depends of course mainly upon the strength and resistance of the aforesaid ligaments; yet, although the properties of these structures are well known to anatomists, a difference of opinion prevails as to the pos-

sibility of rendering the urethra straight by simple traction of the penis.

The true suspensory ligament is calculated by its position and strength to prevent the surgeon from depressing the penis sufficiently to straighten the urethra, and in the dead subject no force so applied, short of what suffices to tear the ligament in question and to rupture partially the attachment of the crura penis to the bones, can efface the curvature of the posterior segment of the canal, but if the suspensory ligament be divided by the knife, and if at the same time the crura penis be detached ever so little from the pubis, the slightest traction exercised subsequently upon the penis renders the urethra perfectly straight. The writer by no means intends to deny that catheterism by straight instruments is a feasible operation: to straighten the urethra by drawing the penis in certain directions, and without any other aid, is one thing, and to introduce a straight instrument into the bladder along the urethra is a totally different matter; to accomplish the former, either in the living or the dead subject, so long as the true suspensory ligament is uninjured and the crura penis retain their attachments, will be found absolutely impossible, whilst the latter operation may very generally be performed by any surgeon who possesses ordinary dexterity. The principle on which the introduction of straight instruments is effected admits of ready explanation. By raising the penis as before described the operator renders the urethra, from the glans to the bulb inclusive, perfectly straight, and therefore the staff traverses the passage so far without impediment, but any attempt to force it farther in the same direction would rupture the lower wall of the urethra, and propel the point of the instrument towards the rectum. The hinder portion of the canal leads upwards and backwards to the bladder, and it therefore remains to be explained how a straight instrument, occupying the spongy part of the urethra, and with its point directed downwards and backwards towards the rectum, can have its course so changed as to pass upwards and backwards to the bladder. The solution of the problem is easy: the handle of the instrument is first drawn forwards so as to form a right angle with the pubis, and then depressed until it becomes nearly parallel with the patient's thighs, whilst at the same time an onward movement is communicated to it, whereby the point glides upwards and backwards into the bladder. In these movements the staff obviously represents a lever of the first order, the fulcrum formed by the lower wall of the urethra opposite to the true suspensory ligament of the penis, and the beak of the instrument being elevated as its handle is depressed.

In addition to its curvature, that part of the urethra which belongs to the perineum presents other features of interest to the surgical anatomist. In the dead subject its diameter is naturally far from uniform, whilst in the living its calibre is exceedingly liable to vary, according to the contraction or relaxation of the

muscular expansions which in certain situations invest it. Its parietes also exhibit in many places peculiarities of organisation calculated to embarrass the surgeon, and therefore some further notice of this part of the canal becomes here necessary.

The prostatic portion of the urethra is an inch and a quarter or at most an inch and a half in length. In the adult it takes an oblique direction from above and behind downwards and forwards; but in the aged subject it runs more horizontally, a change produced by the development of the "bas fond" of the bladder; and in the child its course is nearly vertical in consequence of the position of the bladder at that period of life. The prostatic urethra is slightly contracted at each extremity, whilst in the intermediate space it is somewhat widened, the dilatation being most observable near its lower wall. The verumontanum or caput gallinaginis, a prominent fold of mucous membrane, extends in the middle line along the floor of this part of the canal: it exhibits anteriorly a depression named the sinus pocularis, the orifice of which is directed forwards, whilst on either side the aperture of the common ejaculatory duct usually opens. The verumontanum is placed between two deep depressions called the prostatic sinuses; these contain numerous orifices of the prostatic ducts, a few only being observable on the upper wall of the urethra. At the posterior extremity of each sinus a transverse fold of mucous membrane, of which the free concave margin looks forwards, may be occasionally observed; this has been called the "pyloric valve" by M. Amussat; but in the majority of subjects no such structure exists, and when present it is generally occasioned by an incipient enlargement of the third lobe of the prostate gland, which, projecting upwards from below, elevates the mucous membrane at either side, so as to produce the valvular arrangement in question.

From this brief exposition it follows that many impediments to catheterism may be encountered in the prostatic portion of the urethra. The ducts which open upon its walls having their orifices mostly directed forwards, are sometimes morbidly enlarged, when they might easily arrest the point of a fine bougie; whilst the prostatic sinuses forming depressions below the level of the floor of the urethra and the folds of mucous membrane just described, are also calculated at times to entangle a small-sized instrument. Most of these impediments are situated along the floor of the urethra, and from their very nature they are likely to obstruct none but the smallest instruments. To avoid them, therefore, the surgeon should if possible select an instrument of large size and direct the point along the upper wall of the passage. The difficulties of catheterism are sometimes vastly increased by disease of the prostate gland, but obstructions of that description are beyond the scope of this article. The remarkable sympathy so constantly observed in practice between the testicle and the urethra is explained by the manner in which the lining membrane

of the vas deferens becomes continuous with that which carpets the urethra at the orifice of the common ejaculatory duct.

The membranous portion of the urethra is intermediate between the prostatic and the spongy portions of that canal. *In situ* its length seldom exceeds three quarters of an inch, but when detached and extended it appears about an inch long. Its direction is nearly horizontal, but its upper surface presents a very slight curve, concave towards the pubis. Its under surface is overlapped from before by the bulb, a disposition which diminishes somewhat the apparent length of its lower wall. Its anterior extremity is fixed by the triangular ligament of the urethra, a structure of uncommon strength, through which it passes; but posteriorly it projects behind the triangular ligament for a short distance, and being there girded by Wilson's muscles, which support it like a sling, it possesses in that situation considerable mobility. The membranous portion of the urethra is naturally the narrowest part of the canal, presenting in this respect a marked contrast to the prostatic and spongy portions. Its parietes are endowed with considerable powers of resistance, being strengthened in front by the triangular ligament, which sends forwards upon them an expansion continuous with the fibrous covering of the bulb; whilst a still stronger expansion derived from the back of the triangular ligament surrounds the urethra beneath Wilson's muscles, and affords it powerful protection posteriorly. Between this latter investment and the mucous membrane a peculiar structure exists of which the exact nature is rather doubtful, some considering it a modified erectile tissue, whilst others look upon it as muscular.

The membranous portion of the urethra merits from the surgical anatomist an attentive consideration. It is here that the operator lays bare the groove of the staff in lithotomy performed after the lateral or bilateral methods; this is the situation in which spasm usually arrests the catheter, the obstruction being produced by undue action of Wilson's muscles. Foreign bodies, such as calculi, are very likely in consequence of its diminished calibre to be impacted in this part of the canal, and its anterior extremity is frequently the site of permanent stricture.

In using a curved catheter the surgeon should slacken the penis upon the instrument so soon as its point has fairly traversed the triangular ligament; for if, during the further depression of the handle, the penis be forcibly stretched upon the catheter, its point may push the upper wall of the urethra against the back of the pubis, and in that manner produce considerable mischief. It is also of advantage to communicate a slightly onward movement to the catheter at this part of the passage, as the bladder is situated much more posteriorly, and in the introduction of any instrument, whether curved or straight, it should be borne in mind that spasmodic obstructions yield in general to gentle but continued pressure, and that attempts to force such strictures are usually productive of

increased spasm, and, if persisted in, of laceration of the urethral canal.

In connexion with the perineum, so much of the spongy portion of the urethra only as is covered by the *acceleratores urinæ* muscles requires to be considered, and of this the bulb constitutes the largest and most important part. The bulb is an oval swelling, in which the *corpus spongiosum urethræ* commences posteriorly, it varies in size according to the subject, being small during childhood, enlarging very much at puberty, and often presenting excessive dimensions in old men; during erection, too, it is turgid and swollen, though at other times it remains comparatively flaccid. The length of the bulb, when well developed, may be estimated at an inch and a half, and its thickness or depth from the cavity of the urethra at about eight lines. Its posterior extremity is thick and overlaps the membranous portion of the urethra, whilst anteriorly the bulb becomes gradually narrower, but there is no exact line of demarcation between that body and the remainder of the *corpus spongiosum*. The bulb is situated between the *crura penis* and in front of the triangular ligament of the urethra, to which it is connected by the expansion of fibrous membrane already described; it is covered by the *acceleratores urinæ*, and derives from them a muscular sheath all but perfect. The bulk of this body is constituted by a spongy erectile tissue, remarkably soft, and possessing intrinsically little powers of resistance, but a thin fibrous membrane of investment affords it some protection from without. The canal of the urethra in this situation presents a slight dilatation (most observable inferiorly) named the sinus of the bulb, and the delicate ducts of Cowper's glands, two in number, open into the lower and lateral parts of the passage still further forwards. It should be particularly noted that the bulb, *measured at the exterior*, is in point of size quite out of proportion to the width of the corresponding part of the urethral canal, the canal presenting but a slight dilatation, whilst the dimensions of the bulb are very considerable; and of equal importance in practice is the fact that the axis of the bulb differs widely from the axis of the corresponding portion of the canal, the axis of the bulb running in a very oblique direction downwards and backwards towards the lower extremity of the rectum, whilst the axis of the canal lies upon a higher plane and runs much more nearly horizontally backwards.

In a healthy urethra the principal difficulties of catheterism, whether performed by straight or by curved instruments, are encountered at this part of the passage: the sudden change in direction which the urethra here undergoes, the abrupt narrowing of the membranous portion immediately behind the dilatation of the bulb, the mobility of the urethra in front of the triangular ligament, and its immobility where it passes through that structure, the ease with which a catheter perforates the delicate tissue of the bulb, and, above all, the striking difference in direction observable between the axis of the bulb and the axis of the correspond-

ing portion of the urethral canal, explain this sufficiently; nor should it be forgotten that the muscular girth formed by the acceleratores urinæ is often the seat of spasm.

The error in catheterism of most frequent occurrence here is the perforation of the floor of the urethra at the bulb, after which the extremity of the instrument passes between the rectum and the urethra. The surgeon commits this mistake by neglecting to depress the handle of the catheter in time to raise the point out of the sinus of the bulb into the membranous portion, and so much the more readily as the slightest force exercised in this wrong direction is sufficient to perforate the spongy tissue.

The premature depression of the handle of the catheter may likewise injure the urethra, but in a different manner, for if that manœuvre be executed too soon and with undue force, the point of the instrument will lacerate the upper wall of the canal anterior to the triangular ligament.

A difficulty may, however, be experienced in entering the membranous portion of the urethra, even though the handle of the catheter be depressed at the proper time; the surgeon in such cases fails to "hit off" the aperture in the triangular ligament which transmits the urethra, and the point of the instrument swerving laterally, comes to press against the front of the triangular ligament at one side of the orifice, instead of traversing the orifice itself. To guard against such a casualty, care must be taken to keep the point of the catheter fairly in the middle line, and (should any obstruction arise) to exercise slight traction upon the penis for the purpose of rendering tense the fibrous covering of the bulb, and in that manner stretching the opening in the triangular ligament.

From these principles it clearly follows that, except under peculiar circumstances, curved instruments are to be preferred, for their adaptation to the curvature of the canal enables them to reach the bladder without exercising undue pressure upon any part of the passage; whilst the straight staff conducted ever so skilfully must to a certain extent strain or disturb the permanently curved portion of the urethra. But, besides this obvious advantage, the natural impediments to catheterism (placed chiefly along the floor of the passage) are also most easily surmounted by the curved instrument, for its point can at any moment be readily raised by the operator, whilst he accomplishes the same object much more imperfectly in using the straight staff. It cannot be denied, however, that, for certain purposes, straight instruments possess a decided superiority, and therefore every surgeon should be prepared to employ them when the occasion suits.

The preceding outline describes with sufficient accuracy the course and relations of the principal organs belonging to the perineum, and therefore it now only remains to study the anatomy of this region from below, according to the usual method of dissection. The subject is of course supposed to be placed in the ordinary position, with a full-sized staff introduced into the bladder, the rectum artificially distended,

the scrotum raised and drawn forwards, the hands bound firmly to the ankles at each side respectively, the pelvis elevated on a block, and the knees separated to a convenient distance from each other.

Prepared in this manner, the perineum presents anteriorly a well-marked median prominence corresponding to the urethra, and which for obvious reasons enlarges considerably in the living subject during erection. At either side of this urethral prominence a parallel depression exists, external to which the resisting edges of the rami of the ischium and pubis may be always readily recognised by the finger. At the posterior part of the perineum the point of the coccyx may be felt distinctly in the middle line; the tuberosities of the ischia covered by a great depth of soft parts project remarkably at the sides, constituting the extreme lateral limits of the region, whilst the mid space between these eminences exhibits a deep depression containing the anus. In front of the anus a central elevation of the skin termed the raphé extends forwards along the perineum, and may be traced distinctly to the scrotum and penis; it serves as a guide to the surgeon in many operations, pointing out the middle line accurately so long as the integuments retain their normal relations.

Integument.—The characters of the cutaneous covering of the perineum are not uniform throughout; in some situations its thickness is very considerable, whilst in others it appears remarkably delicate. In front the skin becomes gradually finer as it approaches the scrotum, and at the margins of the anus its delicacy is extreme; but in the neighbourhood of the tuber ischii and along the edge of the gluteus maximus it possesses great density and offers considerable resistance to the scalpel: at the circumference of the region it in fact gradually assumes the properties of the neighbouring tegumentary membrane, resembling that of the scrotum anteriorly, merging insensibly into the integument of the buttock and thigh laterally, and even approaching to the characters of mucous membrane in the vicinity of the gut; it is generally of a dark brown colour in the healthy adult, and of a lighter hue in the child; but there are in this respect numerous individual varieties; the darker the tint the more highly developed usually are the subjacent muscles. Cutaneous follicles abound in the perineum and occur in greatest numbers near the anus and at the root of the scrotum, where their secretions are most required. The skin around the anus is thrown into rugæ disposed in a radiated manner, and which produce a puckered appearance so long as the orifice remains contracted: they disappear during its dilatation, and are designed to favour the extreme distension to which the anal extremity of the intestine is occasionally subjected during defæcation. The folds in question become at times the seat of fissure, ulceration, or excrescence, which may demand surgical interference for their relief.

In the lateral operation of lithotomy the first incision should commence at the left side of the raphé, about an inch or an inch and a quarter

in front of the anus, and extend in an oblique direction backwards and outwards to the point midway between the tuber ischii and the orifice of the gut. In the bilateral operation the first incision is semilunar, the cornua placed at either side between the tuber ischii and the anus, and equidistant from these points respectively, the centre situated about three quarters of an inch in front of the anal aperture, and the concavity of the curve directed backwards. For convenience the operator in general begins this incision on the right side of the perineum.

On removing the integuments the anatomist brings into view anteriorly the superficial fascia of the perineum, surrounding the anus the cutaneous sphincter, and at either side of the gut a large quantity of adipose cellular tissue, which fills up in great measure the interval between the intestine and the tuber ischii. If the dissection have been carefully conducted, some nervous twigs are also visible near the rami of the ischium and pubis; they are mostly cutaneous and derived from the sciatic branch of the lesser sciatic nerve (the "perineal cutaneous" of many authors, the "long inferior pudendal" of Sæmmering) in its course to the scrotum and root of the penis. This nerve or its branches are always superficial and liable to injury in many operations performed upon the perineum.

The superficial fascia.—The superficial perineal fascia has been by some anatomists described as two membranes essentially separate and distinct from each other, that nearer to the surface being called the "subcutaneous cellular membrane" of the region, and the deeper of the two being designated "the superficial fascia of the perineum." To the writer this description appears unnecessarily minute, for in fat subjects it is exceedingly difficult to effect such a separation, and under the most favourable circumstances the dissection in question is too artificial; with equal propriety might the superficial fascia of the abdomen be divided into layers, for like that in the perineum, its cutaneous surface is cellular and often loaded with fat, whilst its deeper surface assumes very much an aponeurotic appearance.

The superficial perineal fascia is a celluloponeurotic expansion interposed between the integuments and the principal muscles, &c. of the region, (to this, however, the superficial sphincter muscle, which is absolutely subcutaneous, forms an exception;) in the anterior or genito-urinary division of the perineum it is of very considerable thickness, being mostly cellular and fatty superficially, and becoming more dense the deeper the dissection is carried; numerous fibrous bands are interwoven with this expansion, and appear more and more evident the farther from the integument it is examined, so that at length, just like the superficial fascia of the abdomen, it assumes very much the characters of fibrous membrane. The varieties in density which this fascia presents in different subjects are nearly endless; in corpulent persons its grossness is sometimes excessive, and when condensed by inflammation its depth becomes extreme: this explains the surprising

distance from the surface to which the surgeon usually cuts in liberating the matter of a perineal abscess, and shews the lithotomist the necessity of duly estimating the thickness of this structure before he commences his operation. Traced forwards the superficial fascia becomes gradually thinner until at length it degenerates into cellular membrane continuous almost without line of demarcation with the dartos, and as it approaches the scrotum it becomes loose in texture, whilst its cells communicate freely with each other and contain little adipose substance, if any. Followed laterally it seems at first sight to merge gradually into the subcutaneous cellular tissue of the thigh, but when examined from beneath by being raised in a flap from the middle line outwards, it is found to adhere by strong tendinous attachments to the edge of the pelvis, and so powerful is this adhesion that all attempts to pass the handle of a scalpel outwards between the fascia and the rami of the pubis and ischium uniformly fail.

In the posterior or anal division of the perineum the superficial fascia is little more than a cellular web, appearing, however, somewhat denser in the space between the tuber ischii and the anus; here its continuity with the subcutaneous cellular membrane of the gluteal region may be easily demonstrated, and it also dips in deeply into the ischio-rectal fossa, where its cells become inordinately loaded with fat. If the superficial fascia be carefully raised from before backwards, a deep process of this membrane may be seen to form a partition between the genito-urinary and the anal divisions of the perineum. The process referred to constitutes a septum, which, after dipping in deeply behind the transversi perinei muscles, becomes identified with the base of the triangular ligament of the urethra; to demonstrate this connection, however, requires some nicety of manipulation and a suitable subject. In raising this fascia the anatomist cannot fail to observe that its adhesion to the subjacent parts is everywhere extremely loose, except in the situations already specified.

The peculiar structure and the connections of the superficial perineal fascia afford a satisfactory explanation of the course which urinary effusions generally take in the living subject. When urine escapes into the perineum in consequence of rupture or ulceration of the urethra, provided the solution of continuity be seated superficial to the triangular ligament of the urethra, the liquid makes its way forwards to the scrotum, and after distending that part it proceeds upwards to the abdominal parietes, occasionally reaching the umbilicus, or even attaining to a higher level. The effusion rarely passes downwards along the thighs, or backwards to the neighbourhood of the anus, and its progress to the surface in the perineum is invariably tedious. In such cases the close adhesion of the superficial fascia to the rami of the pubis and ischium prevents the urine from reaching the thigh; the connection of the superficial fascia to the base of the triangular ligament of the urethra opposes its progress

towards the anus; the density of the triangular ligament of the urethra impedes its passage into the pelvis; whilst the loose connection between the superficial fascia and the subjacent structures in front, the remarkable laxity of the dartos, and the continuity of this latter with the superficial fascia of the perineum on the one hand, and with that of the abdomen on the other, are so many circumstances inviting the stream to the scrotum, the penis, and the walls of the abdomen. The promptest treatment is demanded to remedy mischief such as has been described. A free division of the integuments and fascia in the perineum over the seat of rupture, for the purpose of giving the urine vent and putting a stop to further effusion, becomes indispensable, and without this measure all others must be unavailing.

The laxity of the superficial fascia as it approaches the scrotum should deter the surgeon from commencing his cutaneous incisions in the lateral operation of lithotomy too far forwards, lest urinary infiltration should ensue; and the density of the same structure in other situations indicates an early incision for the release of matter imprisoned beneath it.

For a description of the posterior or anal division of the perineum, including the ischio-rectal fossæ and the neighbouring fibrous membranes, the reader is now referred to the article ANUS, where all the structures connected with the lower extremity of the rectum are described in detail. It should be borne in mind, however, that some branches of arteries (the inferior or external hemorrhoidal) pass across the ischio-rectal fossæ, entangled in the fat which occupies those excavations. The inferior hemorrhoidal vessels are usually three in number at each side; they derive their origin from the internal pudic artery, as it lies beneath the obturator fascia; their destination is the lower extremity of the gut and its appendages, and one of them (the most anterior) gains the front of the intestine to anastomose with a similar vessel from the opposite side, and with branches of the transversalis perinei also. The inferior hemorrhoidal vessels are remarkably tortuous and rather uncertain in their course; the anterior of them is sometimes divided in the lateral or bilateral operations of lithotomy, a circumstance which has led to this cursory notice of their anatomy.

When the superficial fascia has been displayed, many new parts become apparent in the genito-urinary division of the perineum; a quantity of loose adeps and also a very thin glistening fibrous expansion which adheres closely to the subjacent muscles and obscures the dissection, must, however, be carefully removed before the deeper structures are satisfactorily displayed. The central tendinous point of the perineum, the superficial perineal bloodvessels and nerves, the transversalis perinei artery with its accompanying veins and nerves at each side respectively, the urethra itself, still however obscured by the acceleratores urinæ muscles, the crura penis, each partly enveloped by the erector penis muscle, the

transversi perinei muscles, and two small triangular spaces bounded by muscles and placed one at either side of the urethral prominence, are the principal objects which come into view.

The central tendinous point of the perineum is situated in the middle line, equidistant from the anus and the bulb of the urethra. It is a common point of insertion to many muscles; thus the superficial sphincter of the anus can be fairly traced to this spot, and so can many fibres of the acceleratores urinæ, the transversi perinei, the levatores ani, and Wilson's muscles. Here muscular fibres from opposite sides of the perineum become blended with each other; here, too, those from before and those from behind are intermixed, and some even descend from within the pelvis to identify themselves in this place with others which are subcutaneous.

The superficial perineal artery (the perineal artery of some anatomists), though not a large vessel, yet takes a lengthened and very regular course. Its origin is from the internal pudic artery at some little distance behind the transversus perinei muscle, whilst the parent trunk is still under cover of the obturator fascia; it immediately pierces that membrane, and likewise very generally passes through the base of the triangular ligament of the urethra. The artery next curves around the transversus perinei muscle lying on its superficial surface and running across its fibres. The vessel then inclines forwards and inwards through the triangular interval between the accelerator urinæ and the erector penis muscles, until at length it reaches the scrotum, and assuming the name of "the arteria septi," it terminates in a free anastomosis with the other arteries supplying the envelopes of the testicles. The superficial perineal artery lies deep posteriorly, but its position becomes very superficial as it approaches the scrotum; its branches are distributed freely to the muscles and integuments, and they likewise anastomose internally with branches from the corresponding artery of the opposite side, and externally with superficial branches from the thigh. Two veins accompany this artery; they are frequently dilated and tortuous in front, and in certain diseased conditions of the testicle or its coverings they sometimes form a complicated net-work in the scrotum.

The inferior or superficial division of the pudic nerve ("the perineal nerve" of many authors) follows pretty nearly the course of these vessels; like the artery, it is destined for the scrotum, where it terminates by several long and very fine branches, after supplying in its progress numerous twigs to the transversus perinei, accelerator urinæ, levator ani, and erector penis muscles. One very remarkable branch of this nerve (the bulbo-urethral of Cruveilhier) may be traced fairly into the bulb, whilst another (the external perineal of the same anatomist) runs superficially along the lateral part of the region, reinforcing and anastomosing with the perineal cutaneous branch of the lesser sciatic nerve.

The transversalis perinei artery is of small size; it springs from the internal pudic, a little anterior to the source of the superficial perineal artery, but these two vessels not unfrequently arise by a single common trunk. The transversalis perinei artery passes through the obturator fascia, and often perforates the base of the triangular ligament of the urethra; it quickly becomes superficial, applying itself to the cutaneous surface, and running usually near the posterior edge of the transversus perinei muscle, it thus gains the central tendinous point of the perineum, where it anastomoses with the inferior hemorrhoidals from behind, the transversalis and superficialis perinei arteries from the opposite side, and with the neighbouring superficial perineal. This vessel is accompanied by two veins and by one or more branches of the superficial division of the pudic nerve.

The accelerator urinæ muscle (the ejaculator seminis of some anatomists, the bulbo-cavernosus of others) extends from the central tendinous point of the perineum forwards along the urethra, being identified with the corresponding muscle of the opposite side in a raphé which occupies the middle line; and so intimate is this connection that both might be conveniently described together as a single muscle. The fibres of the accelerator urinæ spring from the side of the raphé, and pass from thence outwards and upwards upon the urethra. The anterior fibres incline very obliquely forwards and outwards to arrive at the surface of the corpus cavernosum penis, where they terminate. In consequence of this disposition the acceleratores urinæ muscles are separated from each other in front by a Y-shaped interval in which the urethra appears. The succeeding fibres, after embracing the urethra laterally, are lost on a short horizontal tendon, which likewise receives the corresponding fibres of the opposite muscle. This tendon is placed above the urethra, beneath the junction of the crura penis, and anterior to the triangular ligament of the urethra. The posterior fibres incline outwards more than the others, and are inserted into the superficial surface of the triangular ligament of the urethra, many of them extending nearly to the crus penis. The accelerator urinæ muscle lies on the bulb and the neighbouring portion of the corpus spongiosum. In conjunction with its fellow it constitutes a fleshy sheath, all but perfect, for the urethra. Its action is to compress the canal, and at the same time to draw forwards the bulb. It is employed in expelling the semen and the last drops of urine from the sinus of the bulb; and by contracting spasmodically it may even arrest the progress of a catheter, an occurrence explained by the manner in which many of its fibres completely surround the passage.

The erector penis muscle (called sometimes "the compressor penis," or "the ischio-cavernosus,") is placed obliquely along the lateral margin of the genito-urinary division of the perineum, where it partially envelopes and conceals from view the corresponding crus

penis. It is elongated, broader in the centre than at the extremities, and curved so as to embrace the crus on which it is moulded. The erector penis springs by a narrow tendinous attachment from the inner surface of the tuber ischii, and from the extremity of the great sciatic ligament beneath the transversus perinei muscle; the fleshy fibres soon succeed, and after continuing in an oblique direction upwards, forwards, and inwards, they end in a fibrous expansion which inclines outwards and forwards to terminate by two processes on the surface of the corpus cavernosum penis. Anatomists are not agreed on the action of this muscle: it may serve to draw down and to compress the crus penis, and in that manner to influence the circulation therein, but it can have no direct concern in causing the erection of the organ.

The transversus perinei muscle ("the ischio-perineal" of some anatomists) passes from the tuber ischii to the central tendinous point of the perineum; in this course the muscle inclines forwards and slightly downwards, so that its direction is not exactly transverse. It is attached externally to the inside of the tuber ischii, above the origin of the erector penis and the crus penis; and internally it is confounded with the several muscles already specified as reaching the central tendinous point. The transversus perinei is often of a triangular shape, the base at the ischium, and the apex at the central tendinous point of the perineum; it is mostly fleshy, except at its insertion, which is aponeurotic. This muscle is exceedingly uncertain as regards its development, being sometimes replaced by a few scattered fibres derived apparently from the levator ani, and occasionally reinforced by a second muscle, termed the transversus perinei alter. The transversus perinei alter, when present, lies anterior and superior to the other, and extends from the ramus of the ischium to the bulb, where it becomes confounded with the accelerator urinæ. The transversus perinei is related by its superficial surface to the superficial perineal fascia, the superficial perineal and the transverse perineal vessels and nerves, the insertion of the superficial sphincter ani, and the origin of the erector penis and the crus penis. Its deep relations are the levator ani and Wilson's muscles, together with the triangular ligament of the urethra. The transversus perinei contributes to the strength of the perineum by raising and fixing the central tendinous point; it also assists the levator ani in raising and supporting the rectum and the pelvic viscera. The transversus perinei muscles have been by some described as a single digastric muscle, semilunar in shape, and with the concave margin directed backwards and upwards towards the gut; the result of the simultaneous action of these two bellies would be to raise and compress the intestine in front, and thus to assist in completing the process of defæcation.

The triangular spaces are situated one at either side of the urethral prominence; each is bounded internally by the accelerator urinæ and the urethra, externally by the erector penis

and the *crus penis*, posteriorly by the *transversus perinæi*, which constitutes the base of the triangle, whilst the apex is in front where the *crus penis* and the urethra unite. These spaces are small in the natural condition, but when carefully dissected they become very distinct; the superficial perineal vessels and nerves traverse them from base to apex; by separating the *accelerator urinæ* from the *erector penis* the anatomist obtains a view of the triangular ligament of the urethra between these muscles, and he may also form some estimate of its thickness and strength by the touch.

When the muscles and other structures belonging to the same layer of parts have been removed, the *crura penis* along the sides of the region, the urethra in the centre, and the triangular ligament of the urethra stretching across the arch of the pubis, are brought fairly into view; still further back, in the middle line, the recto-urethral triangular space may be partially seen, and also some fibres of the *levator ani* muscle descending to their insertion from behind the triangular ligament.

It is unnecessary in this article to describe the *crura penis* minutely. Each *crus* adheres to the rami of the ischium and pubis, becoming gradually thicker and larger as it approaches the symphysis, and at length the two *crura* unite to form the body of the penis; the lateral margins of the triangular ligament of the urethra, and the great pudic vessels and nerves in the last part of their course, are overlapped by the *crura* as they ascend.

The anatomy of the urethra in respect to catheterism has received the fullest consideration already, but the position of the bulb may be now again studied with advantage. This body lies in front of the triangular ligament of the urethra, and projects backwards and downwards towards the rectum; it is situated about one inch from the anus, and scarcely more than half that distance from the anterior wall of the intestine; yet the narrow interval between the bulb and the rectum constitutes a portion of the recto-urethral triangular space, through which the early incisions in the bilateral operation of lithotomy are carried. The bulb is retained in its position by a thin expansion derived from the anterior layer of the triangular ligament, and continuous with the membrane which invests the *corpus spongiosum urethræ*.

The triangular ligament of the urethra ("the deep perineal fascia" of some anatomists, "the perineal ligament" of M. Carcassone, "the middle perineal aponeurosis" of M. Blandin) presents itself next for examination. To expose the superficial surface of this ligament it is only further necessary to detach the *crura penis* from the bones and to free the bulb from its connections, but to exhibit the deeper surface satisfactorily the dissection must be conducted from within the pelvis. The triangular ligament of the urethra extends from the rami of the ischium and pubis at one side to the corresponding edges of bone on the other; its superficial surface, directed forwards and downwards, is in contact (so long as the parts remain

in situ) with the *crura penis*, the bulb of the urethra, and the muscles already specified; its posterior surface, directed upwards and backwards, is related to the prostate gland, the membranous portion of the urethra, Wilson's muscles, and the *levatores ani*; its base, directed downwards and backwards towards the rectum, gives attachment to the deep process of the superficial perineal fascia, and presents a double curvature, being prolonged in the middle line into a peak, which adheres to the central tendinous point of the perineum; its apex corresponds to the lower extremity of the symphysis pubis, and includes the sub-pubic ligament between its laminae, whilst its lateral margins adhere firmly to the rami of the ischium and pubis, and are distinctly continuous with the obturator fascia on either side. The opening which affords a passage to the urethra is situated about half an inch or rather less above the base of this ligament, and nearly one inch beneath the symphysis pubis, whilst that which transmits the dorsal veins of the penis is placed immediately below the sub-pubic ligament. The triangular ligament possesses uncommon strength; it serves to fix and to strengthen the urethra and to fill up the arch of the pubis, completing the walls of the pelvis where the bones are deficient, and thus supporting powerfully the abdominal and pelvic viscera. It constitutes a perfect partition between the superficial and the deep structures in the perineum, dividing the genito-urinary portion of this region into two distinct compartments; and it consists of two laminae inseparably united to each other in some places, not so in others, for Cowper's glands, the sub-pubic ligament, the arteries of the bulb, the internal pudic vessels in a part of their course, and the so-called muscles of Guthrie, are developed between its layers.

Cowper's glands may be displayed by the careful removal of the superficial layer of the triangular ligament; they are two small greyish bodies, each resembling a pea in shape and dimensions, and placed one on either side behind and above the bulb, beneath the membranous portion of the urethra, and between the laminae of the triangular ligament. Their ducts, which open into the urethra in front of the bulb, have been already described.

Guthrie's muscles, two in number, are situated (according to their discoverer) between the layers of the triangular ligament; each of them, as described by him, arises narrow and tendinous from the descending ramus of the pubis near its junction with the ischium, and becoming fleshy it passes transversely inwards, and soon divides into two fasciculi, of which one spreads out on the upper surface and the other on the lower surface of the membranous portion of the urethra. In this manner the muscles from opposite sides meet in a tendinous raphé on the middle line of the urethra both above and below, the superior raphé being prolonged from the prostate gland to the junction of the *crura penis*, and the inferior raphé extending from the prostate to the bulb. Viewed either from above or from below, these muscles are

fan-shaped, appearing expanded at the urethra and contracted at their origin from the bone, and they are believed to have the power of compressing the urethra so as to close the canal. Notwithstanding the accurate descriptions of Mr. Guthrie, many excellent anatomists have failed to demonstrate the exact arrangement of fleshy fibres which he has remarked, but the majority incline to the opinion that the peculiar reddish material in question is of a muscular nature.

The arteries of the bulb (one at either side) spring from the internal pudic after those vessels have arrived at the triangular ligament of the urethra, and whilst they are overlapped by the crura penis. Interposed between the laminae, and situated about a quarter of an inch above the base of the triangular ligament, the artery of the bulb runs nearly transversely inwards, and near the urethra divides into two branches, of which one is small and destined for Cowper's gland, whilst the other is of large size and perforates the bulb to supply the corpus spongiosum urethrae. The arteries of the bulb are of considerable magnitude, particularly after puberty, so that they bleed profusely when wounded; they retract between the layers of the triangular ligament when divided, and this added to the narrowness of the perineum in front, and to the distance from the surface at which they are placed, renders it difficult for the surgeon to secure their cut extremities or otherwise to control their hemorrhage. The consequences of such an accident may prove speedily fatal; extreme care must therefore be taken to protect these vessels from the knife during lithotomy.

The artery of the bulb is endangered in the second period of the lateral operation whilst the surgeon cuts into the membranous portion of the urethra to lay bare the groove of the staff. The knife should be introduced into the urethra behind the bulb, and below and behind the course of the artery, and little or none of the triangular ligament except the posterior lamina where it invests the membranous portion of the urethra, should be divided in this incision, for the vessel requiring protection lies about one quarter of an inch above the base of the ligament, and therefore none but the very lowest fibres of that structure can be cut with impunity; in short the incision must be made into the membranous portion of the urethra as it lies behind the triangular ligament, and the bulb must be studiously avoided. Irregularities in the direction of these arteries calculated to embarrass the operating surgeon are occasionally encountered; arising sometimes prematurely from the pudic, they ascend very obliquely to the bulb; and again, although given off from the pudic at the usual place, they now and then take a curved course to their destination, the convexity of the curvature looking downwards and backwards; when either of these varieties occurs, the vessels in question run much closer to the base of the triangular ligament than usual, and are therefore imminently endangered in lithotomy.

The internal pudic arteries in their third

stage belong to the perineum. This stage commences where the vessel enters the pelvis at the lesser sciatic notch, and ends at the ramus of the pubis, where it divides into its terminating branches. Posteriorly the trunk of the internal pudic is (strictly speaking) placed outside the precincts of the perineum, being separated from the ischio-rectal fossa by the obturator fascia, but it runs so close to that part of the region, and sends so many of its branches through the intermediate partition to lose themselves in perineo, that its description may be here legitimately given. At the commencement of its third stage, the internal pudic is interposed between the obturator fascia and the obturator internus muscle, the muscle separating it from the bone, whilst the falciform process of the great sciatic ligament covers the artery inferiorly: in this situation it lies at a great depth from the surface, being upwards of an inch above the level of the tuber ischii, and at least two inches and a-half distant from the integument; it here also describes a slight curve inclining upwards, forwards, and inwards, towards the edge of the ramus of the ischium. In the latter part of its third stage the internal pudic artery insinuates itself between the laminae of the triangular ligament, and after continuing thus for some distance it at length perforates the superficial layer, places itself between the crus penis and the ramus of the pubis, and there finally divides into the artery of the crus and the dorsal artery of the penis.

On entering the pelvis the pudic arteries of opposite sides are widely separated from each other, but in the neighbourhood of the pubis they gradually converge until their ultimate branches meet on the dorsum of the penis; their position likewise becomes more and more superficial as they proceed.

In the early part of its third stage the pudic artery is accompanied by the trunk of the internal pudic nerve, and afterwards for a short distance by both the branches of that nerve; but the deeper of the two (*viz.* the dorsalis penis) alone continues in relation with the artery in the latter part of its course. Two veins accompany the artery throughout.

The position of the internal pudic vessels exposes them to injury in the lateral operation of lithotomy; but if their relations be considered it will appear that the danger of hemorrhage from this source has been much exaggerated. The falciform process of the great sciatic ligament, the crus penis, the projecting edges of the bones, and the obturator fascia afford these vessels so much protection from below that the operator seldom wounds them in cutting into the bladder, nor is such an injury possible unless the edge of the knife be lateralized to an extreme degree; but if the knife be carelessly withdrawn from the bladder, they certainly incur considerable risk, for in that step of the operation a layer of fibrous membrane alone protects the vessels, and the convex edge of the instrument, if directed unduly outwards, might readily enough divide them. When such an accident has occurred, all attempts to tie the bleeding artery in the ordinary manner have

usually failed, for so deeply do the pudic vessels run, and so firmly bound down are they by the triangular ligament and the obturator fascia, that the ligature, as commonly applied, has proved useless in the hands of even the most dexterous surgeons. The open mouth of the artery may, however, in such cases be often secured by the aid of a curved needle carried deeply into the wound, and some practitioners (amongst the number M. Roux) have succeeded by the same means in tying the pudic artery itself in the vicinity of the tuber ischii, a proceeding attended with complete success. The judicious application of pressure to the bleeding point by an apparatus so constructed as to plug the wound at the same time that it permits the urine to escape freely, has been also followed by satisfactory results. The same principles of treatment are applicable to hemorrhage from accidental wounds of the arteries of the bulb in lithotomy.

On dividing the triangular ligament of the urethra the dissector arrives at the deep compartment of the anterior division of the perineum, but to examine its contents with advantage he requires a section of the pelvis, such as that advised in a former part of this article. This compartment is limited superiorly or towards the abdomen by the recto-vesical layer of the pelvic fascia; inferiorly or towards the surface by the back of the triangular ligament of the urethra; and posteriorly by the rectum; its shape is somewhat triangular, and it contains Wilson's muscles, many fibres of the levatores ani, a part of the membranous portion of the urethra, the prostate gland, a plexus of veins excessively developed in some subjects, and at times also an irregular artery justly dreaded by the lithotomist.

Wilson's muscles (the compressores urethræ) are two triangular fleshy fasciculi, which arise from the back of the symphysis pubis, each by a narrow tendon; their point of attachment is about one-eighth of an inch beneath the anterior true ligament of the bladder, and the same distance above the lower margin of the cartilaginous arch of the pubis. The two muscles, expanding as they descend, separate from each other at the membranous portion of the urethra, and passing one on each side of that part of the canal they again unite beneath it in a sort of tendinous raphé, which extends from the prostate gland to the bulb; many of their fibres may be likewise traced to the central tendinous point of the perineum. A cellular interstice intervenes between the two muscles at their origin, and from the levatores ani they are separated at each side respectively by cellular tissue and some small veins. Wilson's muscles may elevate and compress the urethra so as to close the canal; their influence in catheterism is decided and has been already discussed; one of them, the left, is divided in the lateral, and both are cut in the bilateral operation of lithotomy. In some subjects Wilson's muscles are absent, or rather they are inseparable from the levatores ani; but in such cases the anterior fibres of these latter muscles surround the urethra, perform all the offices assigned to the

compressores urethræ, and are similarly circumstanced as regards operations on the perineum.

The recto-urethral space, but partially seen so long as the triangular ligament of the urethra remains in situ, becomes fully exposed after the division of that fibrous septum. This space results from the inclination backwards of the lower extremity of the rectum, whilst the urethra inclines forwards through the arch of the pubis; its form is triangular, the base at the integuments of the perineum, the apex at the prostate gland, the membranous and the bulbous portions of the urethra constituting its anterior wall, and the rectum bounding it posteriorly. In cutting from the integuments to the urethra through the recto-urethral triangle, the anatomist encounters, first, the superficial perineal fascia; next, the extremities of the several muscles which meet and are confounded with each other at the central tendinous point of the perineum, and also the small arterial anastomosis situated in the same locality, still deeper the peaked prolongation of the triangular ligament; and, lastly, Wilson's muscles at their junction beneath the urethra.

The membranous portion of the urethra is situated within ten lines of the rectum, and the bulb projects still further backwards, lying but half an inch apart from that intestine, so that, in the lateral and also in the bilateral operations, the lithotomist incurs some risk of wounding the bowel as he lays bare the groove in the staff. In the bilateral method the operator endeavours, by a semilunar incision carried across the recto-urethral triangular space, to reach the staff as it lies in the membranous portion of the urethra, and from the proximity of the bulb to the rectum both these parts are endangered as the knife traverses the intermediate space. In the lateral method the rectum is not so likely to be injured in the corresponding step of the operation, because the bowel is further removed from the membranous portion of the urethra than from the bulb, and besides the urethra is incised somewhat upon its lateral aspect. In either case the surgeon best ensures the safety of the intestine by taking care to have the fæces evacuated before the operation commences, by holding the staff well up into the arch of the pubis, and by directing the point of the knife *forwards* as he cuts into the urethra.

The recto-urethral triangular space is the position usually occupied by that rare form of rupture, a perineal hernia; in this disease the hernia leaves the abdominal cavity at the bottom of the great cul-de-sac of the peritoneum, and drawing down the serous membrane in its progress it gradually insinuates itself between the prostate gland and the rectum, and at length protrudes between the rectum and the bulb. In the perineum the sac is in general rather superficial. The tumor occasionally deviates from the middle line, and projects outwards and backwards behind the transversus perinei muscle into the ischio-rectal fossa; it rarely undergoes strangulation, being in almost every instance reducible.

The prostate gland demands the special attention of the surgical anatomist, for much of

the operator's success in lithotomy turns upon his knowledge of the relations, the size, and the density of this organ as well as of the resistance of its capsule. The prostate is heart-shaped; it has been also not unaptly compared to a chesnut. Its base, directed backwards and upwards, embraces the neck of the bladder, and usually presents a notch for the entrance of the ejaculatory ducts; its apex, truncated and directed forwards and downwards, is in contact with Wilson's muscles and separated from the triangular ligament of the urethra by an interval of less than half an inch; its under surface, grooved longitudinally in the middle line, looks somewhat backwards and rests upon the rectum with the intervention of a quantity of rather dense cellular tissue, in which fat never accumulates; its upper surface, inclining slightly forwards and less extensive than the lower, is connected to the pubis by the anterior true ligaments of the bladder; and its sides, which are rounded, are covered by the levatores ani muscles. The vesiculæ seminales are related to the base of the prostate gland, and the dorsal veins of the penis lie upon its upper surface, which is scarcely three-quarters of an inch distant from the pubis. The rectum, when empty, is in contact with the under surface only of the prostate, but when distended, it also encroaches upon the sides of the gland; this occurs to an extreme degree whenever the bowel presents the dilatation so commonly observed in elderly persons; in such cases the prostate appears embedded in the walls of the gut, a disposition fraught with danger to the intestine in the ordinary operation for stone.

The prostate gland varies so much in size at different periods of life, and even in different individuals of the same age, that it is impossible to specify its exact dimensions. The organ is small in the child; it increases greatly at puberty; in middle age its measurements are still larger, and in the decline of life they become not unfrequently excessive. In the healthy adult subject the extreme length of the prostate gland from base to apex may be estimated at from an inch and a quarter to an inch and a half; its depth at the base seldom exceeds one inch, whilst from side to side it measures somewhat more than an inch and a quarter. The urethra traverses the prostate from base to apex, and runs much nearer to the upper than to the lower surface of that body, so that the canal is very unequally surrounded by glandular substance. At the base of the prostate the glandular substance above the urethra varies from two to four lines in depth; below the canal it is upwards of six lines deep; laterally its thickness may be estimated at about eight lines, whilst in the direction of the ordinary incision in lithotomy, viz. downwards and outwards, from nine to twelve lines is the average measurement. Exceptional cases have been reported by Velpeau and others, in some of which no trace of glandular substance existed above the urethra, and in others little or none beneath it; the latter variety might lead to unpleasant consequences in lithotomy.

The prostate gland is enveloped by a dense

capsule continuous with the fibrous membrane derived from the posterior layer of the triangular ligament of the urethra, and investing the membranous portion of that canal. This capsule is identified above with the anterior and lateral true ligaments of the bladder, and its strength is such as to impart great firmness to the prostate, and a power of resistance altogether foreign to the glandular substance. The anatomist finds it extremely difficult to lacerate the prostate so long as the capsule retains its integrity, but a trifling force suffices to tear or to split the gland after it has been deprived of this covering. The strength of the capsule explains the difficulty experienced by lithotomists in dividing the prostate gland by the cutting gorget, and was doubtless in great measure the cause of those distressing accidents which so frequently resulted from the slipping of that instrument, and which have led to its disuse in latter years. The common ejaculatory ducts traverse the prostate gland from behind forwards and upwards; they are closely approximated to each other, and for practical purposes may be considered to occupy the middle line. It would be impossible to effect with certainty a median section of the gland in the living subject without injury to one or both of these ducts: this constitutes a strong objection to the recto-vesical operation of lithotomy, but they are out of danger in the lateral and bilateral methods.

The veins in the neighbourhood of the prostate gland and of the neck of the bladder are remarkable for their plexiform arrangement, and are called the vesico-prostatic plexus. This plexus, receiving anteriorly the dorsal veins of the penis after their entrance into the pelvis, and communicating posteriorly with the hemorrhoidal veins, delivers its blood into the internal iliacs; it lies chiefly upon the upper and lateral surfaces of the prostate, and on the lateral and inferior aspects of the neck and neighbouring portion of the base of the bladder. The veins which constitute this plexus are covered by a layer of the capsule of the prostate, and bound down to the bladder by a strong membrane derived from the recto-vesical lamina of the pelvic fascia. They communicate in the freest manner with each other, and are but moderately developed in young and healthy subjects, whilst in elderly persons and in cases of chronic disease of the bladder, as well as in calculous affections, they occasionally attain to an immense size and assume a varicose disposition. The hemorrhage from vessels so enlarged might be followed by a fatal result in lithotomy. The mouths of these veins remain permanently patent after they are divided; this results from the fibrous investment which binds them down, and has been supposed by the French surgeons to predispose them to phlebitis after operations, by exposing their delicate lining membrane to the irritating influence of the urinary stream.

An irregular artery is sometimes found along the side of the prostate gland, and has been the source of fatal hemorrhage when divided by the lithotomist. This vessel is destined to

replace one or more of the terminating branches of the internal pudic, and when present, always continues on to form the dorsal artery of the penis; it occasionally gives off the artery of the bulb and the artery of the crus penis, or this latter branch alone, during its progress. When the irregularity now described occurs, the pudic artery of the same side suffers a corresponding diminution in size, and stops short in the perineum after furnishing a variable number of branches. The irregular trunk here alluded to springs in general from the internal iliac, or from one of the branches of that artery; but from whatever source derived, it runs along the side of the prostate gland to the neighbourhood of the pubis, where it mounts above the urethra and passes beneath the symphysis, in company with the dorsal veins of the penis. This irregular vessel runs nearly in the line of the incision in lithotomy, whether performed according to the lateral or the bilateral methods, and pursuing such an unfortunate course it can rarely escape the knife during these operations. Examples of this irregularity have been recorded by Blandin, Velpeau, Shaw, and others.

The preceding description of the deep compartment of the perineum would be imperfect without some application of the anatomy of that space to practical purposes, particularly as the third incision in the lateral operation of lithotomy is performed within its limits. In this step of the operation the surgeon, in order to make way for the calculus, cuts through the remainder of the membranous portion of the urethra, together with the left lobe of the prostate gland, and in doing so he must also divide Wilson's muscle and some fibres of the levator ani. From the many important parts which surround the prostate, this incision is beset with difficulties. The rectum is much endangered; this arises from its proximity to the under surface of the prostate gland, and from its occasional dilatation. To insure the safety of the gut it should be emptied by the administration of an enema previous to the operation; the handle of the staff should also be depressed before the third incision commences, and the edge of the knife should be duly lateralised; without the latter precaution all other expedients to save the intestine are useless. The depression of the handle of the staff raises the beak of the instrument behind the pubis, and causes the knife to enter the bladder as much as possible in the axis of that viscus, a line of incision best calculated to protect the bowel; and by performing this manœuvre at the proper moment the operator raises the prostatic portion of the urethra from the rectum, thus contributing still further to the security of the gut.

Hemorrhage is the most formidable consequence of the third incision in lithotomy. The pudic artery incurs a certain amount of risk when the operator, in his anxiety to save the rectum, directs the edge of the knife too much outwards, but from a former part of this article the reader may perceive that such an accident is of rare occurrence. The irregular artery

which runs along the prostate is much more to be dreaded, for the surgeon can neither foresee nor avoid the danger, and from its position all attempts to tie the vessel when wounded must necessarily prove fruitless, whilst the absence of a resisting surface beneath the bleeding orifice prevents the plug from commanding the hemorrhage.

A profuse loss of blood from the vesico-prostatic plexus of veins may be also encountered, and is most likely to happen in elderly persons. The largest of these vessels are situated at the neck and along the base of the bladder, so that the surgeon guards against such a casualty most effectually by confining his incisions as much as possible within the limits of the prostate gland.

The French writers consider phlebitis and diffuse cellular inflammations to be the most common causes of death after lithotomy, and they attribute both these fatal affections to an incision carried beyond the base of the prostate. They maintain that the cut surface of the gland is sufficiently tough and resisting to bear the urine with impunity, and that the lax cellular membrane around the neck of the bladder, and the veins in the same locality, speedily inflame when irritated by that secretion. In Paris the bilateral operation is therefore mostly practised, as it gives the largest incision practicable within the circumference of the prostate gland, at the same time that it protects the common ejaculatory ducts, the rectum, and the pudic artery from injury.

In these countries the lateral method is still generally preferred, whether it be that British surgeons usually find a section of one side of the prostate sufficient for the extraction of the calculus, or that a moderate division of the neck of the bladder in their hands seldom leads to the above described unfortunate results, particularly if a ready outlet for the urine be ensured by a free section of the superficial structures.

In the bilateral operation a double risk of wounding the irregular dorsal arteries of the penis must be incurred; and should the blades of the lithotome, in consequence of a misconception of the width of the prostate gland or of the transverse measurement of the bony boundary of the perineum, be too widely divaricated, a twofold liability to venous hemorrhage and to injury of the rectum will be the result, and the pudic vessels on both sides will be endangered,—accidents which demand due consideration from the practitioner in weighing the relative merits of these rival operations.

In dividing the prostate gland the knife is apt to slip from the groove of the staff by reason of the great toughness of the capsule, and to pass between the rectum and bladder, causing extreme mischief. When this part of the operation is performed with the simple knife, the lithotomist guards against such an unpleasant accident by incising the membranous portion of the urethra *freely* before he commences the third incision, and by depressing the *handle* of the knife considerably as he pushes its *blade* onwards to the bladder; by the former precaution he makes certain that the

point of the knife is properly lodged in the groove of the staff, and by the latter that it follows the groove fairly into the bladder. Some excellent instruments have been devised to prevent the occurrence of so serious an accident, but to describe them here would be too wide a digression.

The lithotomist is liable to commit other mistakes still in the same stage of the lateral operation. His incisions may fall short of the bladder altogether, leaving the prostate insufficiently divided; or he may, on the other hand, transfix the bladder by plunging his knife too deeply. The former error may lead to disappointment in extracting the stone, and to severe injury of the neighbouring parts in the attempt to do so; it admits, however, of correction if discovered in time, but the latter mistake must be irreparable. Occurrences such as these result from an imperfect knowledge of the depth of the perineum, and may be accounted for by the great variation in this respect which the region presents in different subjects. Dupuytren and Velpeau found the distance from the neck of the bladder to the integument of the perineum to vary in different cases to the extent of two inches and upwards, the disparity depending chiefly on the degree of obesity of the individual.

The deep compartment of the anterior division of the perineum has claims upon the attention of the practical surgeon independent of lithotomy. Matter sometimes forms within this space, and from the contiguity of the rectum on the one hand, and of the urinary organs on the other, such collections produce most distressing symptoms. The triangular ligament of the urethra prevents the abscess from gaining the surface directly, so that at length it either bursts into the rectum or makes its way gradually behind the base of the ligament. The finger introduced into the gut affords satisfactory information as to the nature of such cases, and free incisions through the perineum are followed by the most marked relief.

Effusions of urine from accidental ruptures of the urethra occur less frequently behind the triangular ligament than in front of it, for in the former situation the canal is so thoroughly protected by its deep position that contusions inflicted upon the surface of the region but rarely affect it. False passages from the forcible introduction of instruments take place in general anterior to the triangular ligament; but when the urethra gives way behind a stricture in consequence of violent expulsive efforts of the bladder, the urine sometimes escapes into the deep compartment of the perineum, and destructive consequences are sure to ensue unless counteracted by timely treatment.

Prostatic diseases are attended by a train of symptoms which depend upon the sympathies of neighbouring organs. When the gland suppurates (not an uncommon consequence of acute inflammation), the matter usually discharges itself by the urethra, the tough capsule determining its route; but at times the abscess bursts into the rectum, or it may even point in

the perineum after passing behind the base of the triangular ligament.

BIBLIOGRAPHY.—The following authorities may be consulted with advantage, in addition to the various systems of descriptive anatomy. *Abraham Colles*, A treatise on surgical anatomy, Dublin, 1811. *James Wilson*, A description of two muscles surrounding the membranous portion of the urethra, *Med.-Chir. Trans.*, vol. i, p. 175, London, 1812. *C. A. Key*, A short treatise on the section of the prostate gland in lithotomy, London, 1824. *Alf. A. L. M. Velpeau*, *Traité d'anatomie chirurgicale, ou anatomie des régions*, Paris, 1826. *William Hargrave*, A system of operative surgery, Dublin, 1831. *Ph. Fred. Blandin*, *Traité d'anatomie topographique ou anatomie des régions*, Paris, 1834. *J. F. Malgaigne*, *Manuel de médecine opératoire*, Paris, 1834. *G. J. Guthrie*, On two new muscles of the membranous portion of the urethra, *Lond. Med. and Surg. Journ.*, 1833. *Robert Harrison*, The surgical anatomy of the arteries of the human body, Dublin. *Thomas Morton*, The surgical anatomy of the perineum, London, 1838. *Alf. A. L. M. Velpeau*, *Nouveaux éléments de médecine opératoire*, Paris, 1835.

(*Robert Mayne.*)

PERITONEUM.—The serous membrane of the abdomen, investing the inner surface of the abdominal walls and the outer surface of the abdominal viscera, and forming, by duplication, sheets with both surfaces free, called omenta, mesenteries, suspensary ligaments, &c.

The peritoneum of the male subject, in accordance with the rule of serous membranes, is a shut sac: in the peritoneum of the female the single exception to this rule is met with: here the Fallopian tubes open into the peritoneal cavity, and their mucous surface is continuous, through their fimbriated extremities, with the serous surface of the peritoneum. Another circumstance that renders the female peritoneum peculiar amongst serous membranes is, that it is necessarily ruptured in the occurrence of a normal process, namely, in the escape of an ovum.

The manner in which a single serous shut sac, by a kind of intus-susception, invests the external surface of viscera and the internal surface of the cavity in which they are contained, is admirably illustrated by the well-known comparison of a double night-cap. Where the cavity contains only a single viscus of a simple rounded form, as, for instance, the pericardium containing the heart, the comparison is very apt. But when, as in the case of the abdomen, numerous viscera of irregular shape are contained in the cavity, the matter is much more complicated, and the resemblance, therefore, far less striking. Yet is the relation of the parietal part of the peritoneum to the visceral part, and of both to the abdominal viscera, essentially similar to that indicated in this well-known simile. The complexity of the peritoneal folds seems mainly to depend upon a strict adherence to such a simple relation, in the case of each of a great number of viscera, with their vessels, &c. contained in a single cavity. Each viscus, whatever its shape, whether closely or loosely connected, must have its

arteries, its veins, its nerves, and its lymphatics passing to and from it, and the whole must be invested by a single shut sac without loss of continuity. The complexity thus arising demands for this membrane a lengthened description.

We propose, first, to trace its continuity throughout its entire extent; next, to describe the sheets with two free surfaces, which it forms by duplication; thirdly, to examine the manner in which it invests each of the viscera, and the abdominal parietes, that is to say, the extent to which it does so in the case of each, the point at which it arrives at and quits each, and so on; and, lastly, to describe its connexions, or the adhesion of its external surface, varying in intimacy, with the parts which it invests. The most important points connected with the anatomy of the peritoneum will be incidentally involved in the consideration of the first of these propositions.

CONTINUITY OF THE PERITONEUM.—To demonstrate the unbroken continuity of the peritoneum, we are compelled, in description, to trace it in various directions, starting from a certain point and following it up till, having performed a complete circuit, we return again to our starting point. In doing so we shall avoid restricting ourselves to the mesial or any other sectional line. We believe that such a restriction, closely adhered to, tends to convey an erroneous impression, namely, that of a line instead of a superficial expanse. In thus tracing the peritoneum, it is better to let the mind rest upon the idea of a free surface, rather than upon that of a membrane. By a membrane one is apt to understand a separable skin; but in some situations not only is it impossible, by any ordinary manipulation, to separate the peritoneum from its connections, but two layers of it often form together a structure so thin that one can hardly help regarding it as a single membrane. In no instance is any part of a serous membrane free on both its surfaces. The external surface of the peritoneum, like that of all other serous sacs, is every where adherent, either to the subjacent structures, or, as in its duplications, to itself; whilst, on the other hand, its internal surface is, normally, every where free. It follows then, that wherever, in the peritoneal cavity, the finger can be placed on a free surface, there is a layer of peritoneum immediately beneath it; that if a continuous free surface is demonstrated, the continuity of the serous membrane is proved; that in fact a free serous surface represents a layer of serous membrane, and may be described instead of it when continuity alone is sought to be proved. We shall therefore at present use the expressions free surface and layer of serous membrane as synonymous; the free surface of a viscus instead of the serous membrane investing a viscus.

When the abdominal cavity is laid open in front by a crucial incision, the inner surface of the reflected flaps is seen to be free, glistening, and of a pale red colour. By a slight exami-

nation of the cut edges this is found to be the free surface of a membrane, whereof the other surface is connected to the subjacent structures by areolar tissue: the free surface is the parietal serous surface of the abdomen: the membrane is the parietal portion of the peritoneum. If an incision has been carried from the navel to the xiphoid cartilage, a falciform, membrane-like process, strikingly resembling the *frœnum linguæ*, is seen connected with the anterior parietal peritoneum, a little to the right of the middle line, projecting backwards, and towards that aspect presenting a free concave border. It is the falciform ligament of the liver. The base or broadest extremity of the falx is sessile along an antero-posterior line upon the upper surface and anterior edge of the liver; which line corresponds with and runs into the great antero-posterior fissure on the under surface of the liver; and this fissure receives the round ligament, and consequently the free edge of the falx which encloses it. The apex of the falx is at a point on the inner surface of the anterior abdominal parietes, corresponding to the navel. The surfaces of the falciform ligament are continuous with the serous surfaces of the parietes and liver; its free border, as incidentally mentioned above, encloses a structure called the round ligament of the liver, which gives a considerable thickness to this part.

The round ligament of the liver is the umbilical vein of the fœtus, degenerated to a fibrous cord in the adult, and it runs across, as that vein did, from the navel to the antero-posterior fissure of the liver, defining the free border of the falciform process in question. The composition, then, of the falciform ligament of the liver is—a portion of peritoneum doubled or folded, so that its outer surface is brought in contact with itself, as happens when a sheet of paper is folded so as to make two leaves. The two surfaces thus brought into contact, are united together by areolar tissue, as if the two leaves were stuck together with paste; and the round ligament lies along in the extreme edge of the fold, like a string that holds a sheet of two leaves in a book-cover. The vessels necessary for the nutrition of these structures ramify in the interposed areolar tissue. It seems as if the umbilical vein, in making the shortest route from the navel to the longitudinal hepatic fissure, had carried back before it a fold of the superjacent peritoneum.

We have spent more time in describing this, the first peritoneal fold we have come to, than is due to its importance, because it affords us, that which we want in this early stage of our description, an instance of the manner in which the peritoneum invests the various organs, having the advantage of extreme simplicity. A bowel is invested by the peritoneum and it occupies a situation in a fold precisely analogous to that which the round ligament occupies in the falciform ligament; whilst the vessels and nerves of the bowel pass to and from it imbedded in the areolar tissue uniting the apposed surfaces.

Placing a finger of each hand on each side

of the falciform ligament of the liver, they may both be slipped along on the free surface of the anterior parietal portion of the peritoneum in a direction at first upwards, then slanting, then backwards, until they are each of them arrested in a corner, or cul-de-sac. They have passed along first on the peritoneal lining of the anterior abdominal muscles, and afterwards on that of the diaphragm. They are now arrested from being slipped along any further in the same direction by the peritoneum leaping across, or extending across, from the lower surface of the diaphragm to the upper surface of the liver. In order to pass them along any further on the peritoneal surface they must be carried off laterally or slipped downwards over the upper surface of the liver. We will pursue the latter course. The corners, or cul-de-sacs, in which we suppose the fingers to rest, are those formed by the falciform ligament, the liver, the diaphragm, and the coronary ligament all meeting together: the latter is the name given to that portion of the peritoneum which extends across between the diaphragm and the liver.

First, then, let the finger which is placed on the left side of the falciform ligament be slipped down over the upper surface of the left lobe of the liver, round its anterior edge, and backwards along its inferior surface; it will be arrested by a membraniform sheet extending across from the fissures of the liver to the lesser curve of the stomach, called the lesser or gastro-hepatic omentum. There for the present we leave it, and now let the other finger be in like manner passed down over the upper surface of the right lobe of the liver, around its anterior surface, and backwards along its under surface, either over the gall-bladder or to the right of it: behind the neck of the gall-bladder, by giving it a direction inclining towards the left, it may be slipped behind the same sheet as arrested the other finger; that is to say, it may be brought to rest upon the posterior surface of the lesser omentum, upon whose anterior surface we left the other finger. This position it gains by being slipped along on the narrow isthmus of liver called lobulus caudatus situated behind the portal fissure, in doing which it passes through a kind of foramen, called the foramen of Winslow, whereof the lobulus caudatus is the superior boundary. The inferior boundary of this so-called foramen is formed by the duodenum; the posterior by the vena cava; and the anterior by the vena portæ, the gall-duct, and the hepatic artery. These are the organs and vessels which surround the foramen of Winslow: they are, however, all covered by peritoneum in such a manner that the finger passed round the foramen, which is about one inch in diameter and of a somewhat semicircular form, glides around on a continuous circle of peritoneum.

The free surface of the lower aspect of the right lobe of the liver has been seen to extend, through the foramen of Winslow, along the lobulus caudatus; the continuity of surface of course extends to the lobulus Spigelii, from whence it may be traced towards the left and

forwards to the posterior aspect of the lesser omentum, and backwards to the posterior abdominal parietes.

The finger being placed on that part of the peritoneum which covers the right kidney, it may be made to glide along the free surface up to the posterior boundary of the foramen of Winslow, and into the foramen itself, which demonstrates the peritoneal continuity in this direction. In much the same way the finger may be slid along on the duodenum until it is thereby conducted into the foramen.

With regard to the continuity of the peritoneal surface of the anterior boundary of the foramen of Winslow, if the finger be placed on the anterior surface of the lesser omentum and slid along on it towards the right, it comes to a free edge thickened by the vessels and duct mentioned above; doubling around this edge it may be made to glide into the foramen; thus demonstrating that the anterior and posterior surfaces of the lesser omentum are continuous with one another around the vessels and duct that thicken its free border and form the anterior boundary of the foramen of Winslow.

Now since, as we remarked above, a free peritoneal surface always indicates a layer of peritoneum, the lesser omentum having two free surfaces consists of two layers; and its two surfaces being continuous around the vessels mentioned, its two layers are continuous in like manner. It, therefore, is a portion of peritoneum doubled or folded upon itself, enclosing vessels and a duct in the extremity of the fold; just as we saw was the case with the falciform ligament enclosing, in the extremity of its fold, the obliterated umbilical vein.

When a double peritoneal sheet passes across from one bowel to another, or from the parietes to a bowel, it is described as attached along the lines where it first lights upon or comes in contact with such parts. Speaking in such a way, the lesser omentum is attached to the liver and stomach by the whole extent of its borders, except that small portion between the duodenum and porta which is free: and in fact this border is said to be free only because that which it encloses is small; if the gall-duct were an inch in diameter, the right border of the lesser omentum would be said to be attached to the gall-duct. Disregarding at present the last observation; the line of attachment, then, of the lesser omentum is continuous all around except at its free border. Let us trace this line of attachment from the porta of the liver to the pyloric end of the stomach in the circuitous direction in which alone it can be done. From the porta, then, we trace this line along the posterior half of the antero-posterior fissure of the liver, inclining a little to the left of this fissure so as to reach the cardiac end of the stomach, and thence along the lesser curvature of the stomach to the pylorus.

The gastric attachment of the lesser omentum is placed transversely, whilst its hepatic attachment runs antero-posteriorly, with only a moderate inclination from side to side, so that this omentum has a kind of twist.

It seems as though the gall-duct in gaining the shortest route from the liver to the duodenum had carried out the superjacent peritoneum from the cardia and lesser gastric curvature into a fold, as far out as the position of the straightest line from the porta to the pylorus; that this fold would have projected in the middle line, but that the enlargement of the right lobe of the liver displaced its posterior part with the cardia to the left, whilst the duodenum being brought into adhesion with the posterior abdominal walls displaced its anterior part to the right, and that both displacements have resulted in an almost transverse instead of an antero-posterior horizontal direction. In many vertebrate animals, especially those below the class Mammalia, the duodenum is not adherent to the posterior abdominal parietes, and the pylorus as well as the cardia is frequently in the middle line, whilst the two lobes of the liver are of pretty equal transverse extent; in such cases the lesser omentum extends antero-posteriorly in the middle line, (*figs.* 490, 491,) and this, we consider, is its typical position. This point will be more fully considered when we come to a particular description of the omenta; at present we are endeavouring to demonstrate the continuity, merely, of the peritoneum throughout: it is the existence of the omenta, or rather their distorted position in the human subject, that renders this demonstration so difficult.

It is necessary at this stage of our description to study the peritoneal sheet, or bag, with two free surfaces, called the greater omentum. On making an incision, as above, through the abdominal parietes, the liver and stomach are at once brought into view; but the small intestines are concealed by the great omentum covering them in front. It is a membraniform apron, having plentiful reticulations of vessels, and often loaded with fat, especially near the vessels. Viewing it undisturbed it appears to be pendent from the greater curvature of the stomach, and to have a free inferior border touching, usually, the pelvic region; but on lifting it up and looking at its posterior aspect, it is seen to be attached also to the transverse portion of the colon, which at once informs one that it is double. The fact of its being double, however, may be much more strikingly demonstrated in the following manner. If a catheter be held in the foramen of Winslow, and air be blown through it, the great omentum (provided there be no abnormal breach of continuity or adhesion in it) will become inflated like a great bladder; the inflation extending, not only downwards below the greater curve of the stomach, but to the left beyond its fundus, and also to the lesser omentum. The cavity so inflated is called the sac of the omentum, or the posterior cavity of the peritoneum, and the foramen of Winslow is the orifice that leads to this sac—the neck that connects together the anterior and posterior cavities of the peritoneum, making them one.

The foramen of Winslow is not generally big enough to admit more than one or two fingers to be passed through it; but an incision being made through the lesser omentum, the hand

may be introduced into the omental sac and passed downwards behind the stomach and in front of the transverse colon, until it reaches the lowermost extent of the great omentum, or bottom of the great omental pouch; it will thus be between the two layers of what we considered like a double apron, but which, rather, is a pouch. The hand may now be carried in either lateral direction until it is arrested by the sides of the pouch, which correspond, on the right with the point where the colon crosses the duodenum, and on the left with the point where the colon, from being transverse, becomes descending,—that is to say, the sides of the pouch hang down from these points. Above the latter point, the hand may be carried towards the left, beyond the fundus of the stomach and somewhat behind the spleen, where it will be arrested by an attachment to the posterior parietes, the line of which extends from the cardia to the left bend of the colon.

There is, therefore, a great pouch of peritoneum, the inside and outside of which are both free; and consequently it has an internal or lining layer and an external layer; we will presently show how these are continuous with each other and with the peritoneal investments of surrounding parts. The left side of the mouth of this pouch is carried up into a long corner reaching the cardia; its continuous line of attachment extends from the cardia along the greater curvature of the stomach to the pylorus; then along a small extent of the duodenum till it reaches the transverse colon; next along the transverse colon to its left bend, and thence along on the posterior abdominal parietes of the left hypochondriac region, or rather over the left kidney, to the cardia whence we started. The spleen is sessile upon the external surface of this bag to the left of the fundus of the stomach. That portion of it which intervenes between the stomach and colon is called the great omentum, and that portion which is situated to the left of the fundus of the stomach is called the splenic omentum.

We may now return to our demonstration of the continuity of the peritoneum by tracing its free surface as before. The two surfaces or layers of the lesser omentum were seen to be continuous around the vessels enclosed in its free right border, at the foramen of Winslow. These two layers, as yet adherent, separate at the lesser gastric curvature, invest the stomach—one behind and the other in the front—meet again, and again adhere along the fundus and greater curvature, forming a sheet with two free surfaces, which to the right extends to the spleen and abdominal parietes, and downwards to the transverse colon; that part of it, however, which intervenes between the stomach and colon is bagged out or excessively widened so as, in ordinary circumstances, to hang down in a pouch as low as the pelvis. Having reached the front of the transverse colon, the layers again separate to invest it—one above and the other below—meet again on its posterior aspect, and again adhering together form the transverse mesocolon, which extends from the colon to the posterior abdominal parietes, where having ar-

rived they finally separate, partially investing, as they do so, the transverse portion of the duodenum. Thus both layers reach the abdominal parietes along the continuous line of attachment of the splenic omentum and the transverse mesocolon; the internal layer from this continuous line invests the pancreas and other parts behind the stomach, then the lobulus Spigelii, and thus is conducted to the posterior surface of the lesser omentum, from which we started. The external layer of the omental sac, having reached this line of parietal attachment as part of the splenic omentum to the left, passes off on the left kidney and the lateral abdominal parietes and diaphragm; having reached it below as the transverse mesocolon, it may thence be traced downwards to the root of the mesentery.

The small intestine is enclosed in the extremity of the fold of a duplicature of peritoneum. That part of the fold which extends across from the posterior parietes to the intestine is called the mesentery. The two component layers of the mesentery are adherent by their apposed surfaces, except where vessels, &c. intervene, so that it is a parieto-visceral sheet with two free surfaces. The parietal attachment of the mesentery is called *its root*, and extends obliquely across the spine from the left side of the second lumbar vertebra, where the duodenum emerging from the root of the transverse mesocolon becomes jejunum, to the right iliac fossa, where the ilium enters the cæcum. Though the parietal attachment or root of the mesentery is but a few inches in length, its visceral attachment by means of numerous ample foldings, like a ruffle, corresponds in length with the twenty feet of small intestine. Tracing, then, the peritoneum heretofore forming the external layer of the great omental sac from the point where it reaches the posterior parietes as part of the transverse mesocolon, downwards, we come to that side of the root of the mesentery which looks upwards and to the right; thence we trace this surface continuous along the mesentery, over the bowel, back again along the other side of the mesentery, so reaching that side of its root whose aspect is downwards and to the left; in both which directions the peritoneum may be traced onwards. To the left it reaches the right side of the descending colon, invests the front of that bowel, and passes off on the other side of it to the lateral parietes: occasionally only does it dip beneath the descending colon so as to come in contact with itself and form a mesentery for it. A little lower down, however, namely, in the left iliac fossa, it always forms a mesentery for the sigmoid flexure of the colon, and, still lower down, for the first part of the rectum. The distinction, however, between iliac mesocolon and mesorectum, as the mesenteries of the sigmoid flexure and rectum are called, is quite arbitrary and unnatural; a continuous mesenteric duplicature, broad in the middle and tapering to each end, serves to give attachment to both the sigmoid flexure and the first part of the rectum. Proceeding from the root of the mesentery downwards in the middle line, the peritoneum covers the sacro-vertebral prominence, and, just below, it ar-

rives at the rectum and forms a mesentery for its first portion as above stated. The peritoneum invests the front only of the second portion of the rectum, and at a variable distance from the anus quits it and extends across to the back of the bladder in the male, or vagina and uterus in the female, so that the lowermost portion of the rectum is destitute altogether of peritoneal investment.

From the other side of the root of the mesentery, namely, that which looks upwards and to the right, we may trace the continuity of peritoneal surface off to the right lumbar region, investing the ascending colon in a like, and similarly variable, manner to that in which it was described as investing the descending colon; and to the right iliac fossa, where it invests the cæcum, sometimes, but not most frequently, forming a narrow mesentery for it called the meso-cæcum. A bit of mesentery is usually afforded to the vermiform process, but this, of course, we do not reach by proceeding off laterally from the last-mentioned aspect of the root of the mesentery.

As mentioned above, the peritoneum extends across from the front of the rectum to the back of the bladder, in the male subject; the level at which it does so varies with the state of fullness or emptiness of the bladder, and also is said to vary, *cæteris paribus*, in different individuals; frequently it is so low that the peritoneum, passing across, touches the prostate. This is in the middle, between the front of the rectum and back of the bladder, but laterally the peritoneum is elevated into two antero-posterior folds, which extend across from the sides of the rectum to the sides of the bladder; these are called the recto-vesical folds or posterior ligaments of the bladder: anterior and external to them there are two other small folds. External to the recto-vesical folds the peritoneum does not descend nearly so low as it does between them; and therefore there is a remarkable, deepish, cul-de-sac, of the same breadth as the rectum, between that intestine and the bladder.

The posterior and lateral aspects and fundus of the bladder are invested with peritoneum, but not its anterior aspect: the peritoneum passes from the fundus of the bladder, by an even slant, on to the anterior abdominal parietes, not making any dip in front of it except when it is much distended. In the female there is a deep cul-de-sac of peritoneum between the rectum and uterus, descending low enough to be in contact with the vagina: between the uterus and bladder there is a second but much shallower cul-de-sac.

We have now traced the peritoneum over the ascending and descending portions of the colon to the abdominal parietes in the right and left lumbar region; from the recto-vesical folds and sides of the bladder to the iliac fossæ; and from the fundus of the bladder to the anterior abdominal parietes of the hypogastric region; from all or any of these positions, or from any point between them, we may trace the peritoneal free surface uninterruptedly up to our first starting point, the

navel and falciform ligament of the liver. From the last-named position we have before reached the anterior and posterior surfaces of the lesser omentum, the former by tracing the free surface over the left lobe, and the latter by tracing it over the right lobe, of the liver. From the sides of the falciform hepatic ligament, proceeding in each lateral direction, in a horizontal sectional line taken at the level of the foramen of Winslow, to the left we find the free peritoneal surface continuing, uninterrupted by any folds, to the external surface of the gastro-splenic omentum in the left hypo-

Fig. 489.

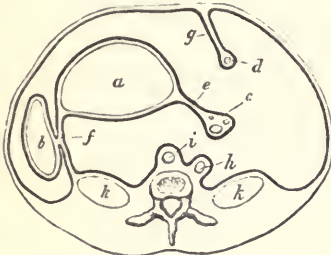

Diagram representing a transverse section of the human subject at the level of the first lumbar vertebra, *i. e.* through the foramen of Winslow.

a, the stomach; *b*, the spleen; *c*, the gall-duct and hepatic vessels; *d*, the round ligament of the liver; *e*, the lesser omentum; *f*, the gastro-splenic omentum; *g*, the falciform ligament of the liver; *h*, the vena cava; *i*, the aorta; *k, k*, the kidneys. The thick line represents the peritoneum. The space between the hepatic duct and vessels, *c*, and the vena cava, *h*, is the foramen of Winslow.

Fig. 490.

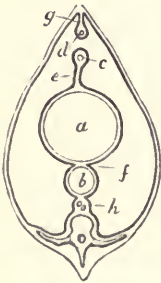

Diagram representing a transverse section of a Lizard, showing the stomach, spleen, lesser omentum, gastro-splenic omentum, and falciform hepatic ligament, in their mesial or typical position.

a, the stomach; *b*, the spleen; *c*, the gall-duct and hepatic vessels; *d*, the round ligament of the liver; *e*, the lesser omentum; *f*, the gastro-splenic omentum; *g*, the falciform ligament of the liver; *h*, the aorta, &c. The thick line represents the peritoneum. There is here no foramen of Winslow.

It will be seen by comparing these diagrams, that much of what seems so intricate in the human peritoneum results from a lateral displacement of an extremely simple arrangement, a displacement which attains its maximum in man, and is due, partly to the lungs being confined to the thorax, and partly to the great lateral, and small antero-posterior, measurement of the human figure.

chondriac region; to the right we find it continuing uninterrupted through the foramen of Winslow, covering its posterior boundary, to the internal surface of this same gastro-splenic omentum: to witness its continuity, however, up to the latter point, it is of course necessary to cut through the lesser omentum—in the human subject, but not in those animals which have no foramen of Winslow. (*Figs.* 489, 490.)

We have now examined the continuity of the peritoneum in all the main directions, and the mode in which it is maintained over the principal viscera and along the connecting sheets with two free surfaces. There yet remain for examination several folds and other remarkable arrangements of this membrane; the description of these is most conveniently deferred till we come to the consideration of our other propositions, when much that is at present wanting in order to render our proof of the continuity of the peritoneum throughout complete, will be supplied.

The peritoneal cavity is one cavity, in the same sense as the whole of the interior of an hour-glass is one cavity; that is to say, it is two large cavities made one by being connected by an extremely narrow communicating neck. Supposing the whole of the peritoneal sac could be detached from the connections of its external surface and expanded, it would be a sac of exceedingly irregular figure, divided into two parts by an extremely narrow constriction.

OMENTA, MESENTERIES, AND LIGAMENTS.—By these terms we understand the sheets with two free surfaces, formed by duplication of the peritoneum and adhesion of the surfaces thereby brought into apposition; to describe these is our second proposition, and to that we now pass.

A parieto-visceral sheet is usually called a *mesentery* or a *ligament*; a sheet with two free surfaces passing from one viscus to another is called an *omentum*.

The *falciform ligament of the liver* has already been fully described. We agree with Cruveilhier that its main use is to conduct the umbilical vein from the navel to the antero-posterior fissure of the liver. This, indeed, can hardly be called a use, especially in the adult; we would say rather that the existence of the falciform ligament necessarily results from the situation and course of the umbilical vein. It perhaps serves in some degree to retain the liver in situ, but it is not advantageously placed with regard to this office.

The *coronary ligament of the liver* is the name given to those portions of the peritoneum which leap across, so to speak, from the under surface of the diaphragm to the upper and posterior aspect of the liver. The anterior and posterior of these portions do not come in contact with one another in the middle, the liver being at that point in immediate contact with, and adherent to, the diaphragm; but towards each side the two layers gradually approach each other, and at length come in contact and adhere, and are prolonged as folds bearing another name. The coronary ligament fixes the liver to the diaphragm, or rather the

deficiency of peritoneal investment to the diaphragm and liver between its anterior and posterior portions allows the liver to adhere to the diaphragm, and small vessels and lymphatics to pass from the one to the other.

The *triangular ligaments of the liver* are the continuations of the layers of the coronary ligament, become adherent as above, leaping across from the rounded posterior corners of the liver to the nearest or postero-lateral portion of the upper concave abdominal parietes, that is to say, to the diaphragm. Their form is, as their name indicates, triangular; their anterior borders are free; their posterior and internal borders are attached, the former to the parietes, the latter to the liver. They help to keep the liver in situ.

The *lesser omentum* has been partially described above. Between its layers are included the vena portæ, the hepatic artery, the gall-duct, and the hepatic plexus, along its free border; and the pyloric and coronaria ventriculi arteries, with accompanying veins and nerves, along its gastric attachment. Except in the course of these vessels, it is a thin transparent membranous sheet, with a very small amount of strength. The vessels destined for its own proper nutrition are extremely few and small. With regard to its use, Cruveilhier thinks that it is a true mesentery of the stomach, mesogastrium, but on this point we would offer the following remarks. One characteristic of a mesentery is, that it retains its bowel in situ, and this office the lesser omentum doubtless partially performs towards the stomach; but another characteristic of a mesentery is, that it gives passage to the arteries and veins of the bowel to which it belongs, and this office the lesser omentum performs, not for the stomach, but for the liver. It is the splenic omentum, or that part of the great omentum whereupon the spleen is sessile, extending between the parietal line of attachment running from the cardia to the left bend of the colon, and the fundus of the stomach, that conducts the principal gastric vessels, as the coronaria ventriculi, vasa brevia, and gastro-epiploica sinistra, from the parietes to the stomach. The splenic omentum fulfils indeed both these offices towards the stomach, and occupies with regard to it the position of a parieto-visceral fold, a relation still more characteristic of a mesentery. We therefore are inclined to consider the splenic omentum as the mesogastrium; and some facts in comparative anatomy, (*figs. 490, 491,*) as well as that mentioned above, of its affording transit to the hepatic vessels, seem to indicate that the lesser omentum is the mesentery of the gall-duct and liver.

The *splenic omentum* is the name given to that long corner of the great omental pouch which extends up to the left of the fundus of the stomach as high as the cardia. It obtains its name from the circumstance of the spleen being situated on its outer aspect. The spleen, in a certain sense, is included between the layers; it is invested, however, by the outer layer alone,—the inner layer passes by it uninterruptedly. Soemmering mentions a *liga-*

mentum phrenico-gastricum, a peritoneal fold connecting the cardiac end of the stomach to the diaphragm; it is the very uppermost corner of this part of the great omental sac, which gets somewhat behind the cardia, and is not unfrequently complicated by one or two small falciform folds, rendered very conspicuous by pulling up the stomach. The attachments of this part of the great omental pouch have already been described; between its layers are contained, at its very tip or uppermost corner, the arteria coronaria ventriculi, with its accompanying vein and nerves;* and lower down the splenic vessels and nerves as far as from the parietes to the spleen, and the branches of the splenic vessels called vasa brevia and gastro-epiploica sinistra, as far as to the fundus of the stomach. There are a few lymphatic glands near the root of the spleen; such glands, together with fat in variable quantities, are very commonly included between the layers of the peritoneal duplicatures. The use of the splenic omentum is to retain the spleen and stomach in situ, and to give transit to the splenic and gastric vessels.

The *great omentum*, called also the gastrocolic omentum. The apron-like appearance and the sac-like form of this singular structure, and also its attachments, have been described above; it is necessary to add the following remarks. It extends much further down in the adult than in the foetus. It reaches lower down on the left side than on the right. Owing to the proximity of its lower edge to the femoral and inguinal rings, it frequently constitutes a part or the whole of the contents of hernial sacs. It reaches lowest down when the stomach is empty, and is very considerably drawn up by distension of that organ. It is usually spread apron-like evenly over the small intestines, but is not unfrequently found lying folded up on one side or the other of the abdomen, occasionally even turned up over the liver and stomach. It is frequently loaded with immense quantities of fat, and indeed is seldom or never destitute of it along the sides of the vessels which form such a beautiful net-work between its layers. In the intervals or meshes of this network the omentum is so extremely thin that it is difficult to believe it composed of two layers, and not unfrequently the membrane is deficient in these situations, giving to the whole the appearance of a piece of lace finely perforated. This is always the condition of the great omentum of the dog, in which animal we have repeatedly assured our-

* The arteria coronaria ventriculi is rarely actually included between the layers of the splenic omentum in the human subject; the posterior aspect of the cardiac end of the stomach coming into immediate adhesion with the diaphragm, frequently allows of this artery reaching it without being enclosed in any peritoneal duplicature; not unfrequently, indeed, it is found to enter the corner of the gastro-hepatic omentum at once, and sometimes it occupies one of the little falciform folds just mentioned, but occasionally it is situated as the description indicates, and as this is its constant course in all or most of the inferior animals, we consider it and describe it as its normal one.

selves, by using great care in manipulation, that it is not the result of violence; it exists also in the mesenteries of some animals.

The arteries that ramify in the great omentum are branches of the gastro-epiploica dextra and sinistra, and some anastomosing ones from the colica media which pass round the colon and enter the omentum on the side of the intestine opposite to that on which the artery reaches it. Veins and doubtless nerves accompany these arteries, and there are some lymphatic glands enclosed between the layers of the great omentum along the greater curvature of the stomach.

The use of the great omentum has never been satisfactorily pointed out. It is peculiar to, and universal in, the class Mammalia, and therefore always co-exists with a diaphragm; probably it has some reference to the incessant motion and constantly recurring compression to which the intestines are subject from the action of that muscle in respiration. It is frequently seen dipping very deeply between the convolutions of the intestines, and occupying their interspaces as a moveable packing material, as if thereby enabling them to retain their cylindrical form whilst subject to incessant disturbance.

The great omentum, being continuous as one sheet with the splenic omentum, may be regarded as a great pouch or widening of the mesentery of the stomach. In those animals, such as the Carnivora, which have a very short colon, the great omentum does not extend from the stomach to the colon, but from the stomach to the pancreas, or to a transverse line of attachment corresponding in position with that of the transverse part of the duodenum in the human subject. The large intestine in these animals crosses over the small intestine at a point very near the termination of the latter in the cæcum, that is to say, over the lower part of the ileum, where it usually has a proper mesentery.*

The annexed drawing represents the abdominal viscera of a lizard. There is a preparation, showing the same parts of a lizard, in the Hunterian collection, (No. 444 D, Physiological Series.) The whole of the intestines of this animal, from the œsophagus to the rectum, are connected to the posterior abdominal parietes by one continuous mesentery attached along the mesial line. In the sheet situated anterior to the stomach, connecting that organ to the liver and enclosing the gall-duct in its free edge, we recognise the lesser omentum in what we heretofore considered its typical position. In that part of the mesentery which connects the upper part of the stomach to the posterior parietes we recognise the splenic omentum; the spleen is seen enclosed between its layers—apparently a large mesentery which, immediately succeeding the last mentioned, connects the middle and lower part of the stomach to the parietes, we cannot help regarding as the great omentum (the pancreas

* In some Carnivora, as the cat, the large intestine cannot be said fairly to pass over the small intestine at all.

Fig. 491.

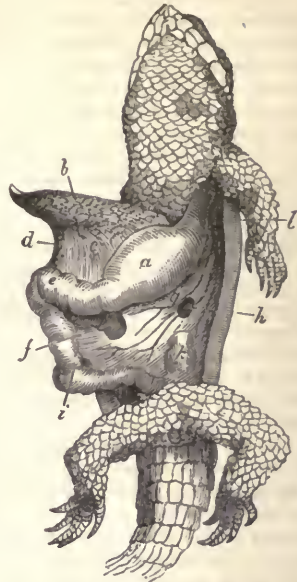

Abdominal viscera of a Lizard.

a, stomach; b, liver; c, lesser omentum; d, gall-duct; e, duodenum; f, pancreas; g, great omentum; h, spleen; i, cæcum; k, ovary and kidney; l, lung.

is just below this). Now pouch out this part towards the left, and a great omentum, such as is found in the Carnivora, is produced, with the same relation of other parts, except in the obliquity of the parietal attachment in the last-named animals, which is but slight. We have but to enclose the transverse colon between the layers of this sac, to obliterate that portion of the mesentery which is connected to the pancreas and duodenum, and to carry the transverse portion of the latter across just in the line of parietal attachment, in order to produce the condition of the parts which exists in man. It will readily be perceived how, in the mean time, a foramen of Winslow will have been formed by this imaginary manipulation.* We should deem this pouching or widening of the gastric mesentery to have reference to the great distention to which the stomach is liable, but that the sac is far too ample to be obliterated by any possible distention of that organ.

The transverse mesocolon, formed of two layers of peritoneum, derived as described above, is about six inches broad in the middle, and gradually narrows off on each side. It retains the transverse portion of the colon in situ, and transmits the veins, arteries, and nerves to this part of the intestine. At its root its two layers separate, leaving a prismoid space, which gives

* The whole duodenum of many mammalian animals, the cat for instance, has a mesentery; in that case the lower boundary of the foramen of Winslow is determined by the hepatic artery; in these animals this portion of the alimentary tube passes off downwards, so that no part of it is transverse.

passage to the transverse portion of the duodenum.

The *mesentery* is the peritoneal fold that connects the small intestine to the posterior abdominal parietes, giving transit to the vessels and nerves of that part of the intestinal tube. Numerous lymphatic glands, called mesenteric glands, are also included between its layers. It is eight inches in breadth at its widest part, and narrows off towards each end, where the small intestine becomes adherent to the parietes. Its parietal attachment, as mentioned above, is only a few inches in extent, whilst its visceral border is usually twenty feet long.

The *ascending mesocolon*, *descending mesocolon*, and *mesocæcum*, when they exist, and the *iliac* or *sigmoideal mesocolon* and *mesorectum*, which always exist, perform all the offices of mesenteries to those parts, respectively, of the intestinal tube which are indicated in their names.

The *appendices epiploicae* are numerous small masses of fat, somewhat pyriform, and having a peritoneal investment, attached along the large intestine. Their use is not known; perhaps they serve as packing to the sacculated bowel on which they are placed.

The *recto-vesical folds* give transit to some vesical vessels and the umbilical arteries of the foetus. The cellular tissue enclosed by them is very lax, so that they are easily unfolded by distention of the bladder.

The *broad ligaments of the uterus* are two folds of peritoneum passing from the lateral borders of the uterus to the opposite abdominal parietes. The line of their summits is about level with that of the superior border of the unimpregnated uterus. This summit or superior border of the broad ligament is defined by the Fallopian tube which it encloses; a little lower down on its posterior aspect the ovary is sessile upon it, invested in a secondary fold of its posterior layer: and the round ligament of the uterus passing between its layers from the side of the uterus to the inguinal canal carries out another little secondary fold in front of it. The broad ligament, then, and its secondary folds, enclose the ovary with its ligament, the Fallopian tube, the round ligament of the uterus, and the spermatic vessels and nerves. The layers of the broad ligament itself, but not those of its secondary folds, are connected together by loose areolar tissue, and are separated (the broad ligament itself becoming effaced) by the enlargement of the uterus in pregnancy.

There are a pair of *recto-uterine peritoneal folds* in the female and a pair of *vesico-uterine folds*; the former pass across from the sides of the rectum to the sides of the uterus, and represent the recto-vesical folds of the male; the latter pass across from the sides of the uterus to the sides of the bladder. The layers of both pairs are very loosely connected together.

There is a slight median fold and two slight lateral folds of the peritoneum lining the anterior abdominal parietes, converging from the fundus and sides of the bladder to the navel; they enclose the remains of the *urachus* and of the two umbilical arteries of the foetus.

At the point corresponding with each inter-nal abdominal ring in the male subject, there is a little infundibuliform depression or dimple of the peritoneal surface; it indicates the point from which a portion of peritoneum, being carried down with the testicle in its descent, was separated to form the tunica vaginalis—in the female; from the same points a cylindrical sheath of peritoneum accompanies the round ligament a little way into the inguinal canal; this sheath has been called the *canal of Nuck*.

With regard to our third proposition,—THE SEROUS COAT AFFORDED BY THE PERITONEUM TO THE VARIOUS VISCERA invests some of them completely, except along little linear spaces, imaginary rather than real, where it reaches them as mesentery, &c.: others it invests on one side only, and others again still more partially.

The *liver* has an investment of peritoneum complete, except at its posterior, thick, rounded border, over a space of inconstant form between the anterior and posterior layers of the coronary ligament, where the liver is in immediate contact with the diaphragm, the space corresponding with the gall-bladder, and along the little linear spaces where the falciform and triangular ligaments and the lesser omentum are attached to it.

The *gall-bladder* is invested with peritoneum on its lower aspect only; that side which is presented towards the liver is in immediate contact with it.

The *stomach* is completely invested with peritoneum, except at the two little linear spaces along its curvatures, where the lesser and greater omenta are attached to it.

The *spleen* is invested by the peritoneum completely, except at its hilus, where its vessels enter from the omentum.

The first or ascending portion of the *duodenum* has a complete peritoneal investment, except at a little linear space along its lower aspect, where the great omentum is attached to it, so that this portion is free to move. The second, or descending portion has peritoneal investment on its anterior aspect only. The third or transverse portion is invested with peritoneum along a very narrow portion of the upper, and a somewhat less narrow portion of the lower part of its anterior aspect; the whole of its posterior aspect and the middle part of its anterior are destitute of peritoneal covering, the former being adherent to the posterior abdominal parietes, &c., the latter corresponding with the root of the transverse mesocolon. Its upper aspect is adherent to the pancreas, which encroaches upon the upper one of the two spaces mentioned as invested with peritoneum. At the point where the duodenum is crossed by the colon, which is just where from descending it becomes transverse, the two bowels are in immediate contact, so that the duodenum is, at this point, destitute of peritoneal covering around its entire circumference. Where the superior mesenteric artery crosses the duodenum, the peritoneum is borne off from it by that vessel.

The *pancreas* is invested with peritoneum on its anterior surface only.

The peritoneum passes over the anterior surface of the *kidneys and suprarenal capsules*, but is not usually in immediate contact with them; a large quantity of loose areolar and adipose tissue being interposed.

The *jejunum and ilium* have a complete investment of peritoneum, except along the little linear space where the mesentery is attached to them.

The *cæcum and the ascending and descending colon* are always invested with a peritoneal coat in front, and this extends to a variable distance around their sides, sometimes completely covering them except at the little posterior linear spaces where their respective mesenteries, in such cases existing, are attached to them.

The *transverse portion of the colon* is completely covered by peritoneum except along two little linear spaces on the opposite sides of it, namely, on its anterior and posterior aspects, where the great omentum and transverse mesocolon respectively, as described above, are attached.

The *sigmoid flexure of the colon and the first portion of the rectum* are invested completely with peritoneum, except along the line of attachment of their respective mesenteries.

The *second portion of the rectum* has a peritoneal investment on its front only: its lateral and posterior aspects are destitute of such covering. The peritoneum, as above stated, passes across from the rectum to the bladder without descending low enough to afford any investment whatever to the lowermost or third portion of the rectum. The conventional division of the rectum into three portions is, in fact, founded upon this circumstance of its being first completely, then partially, and lastly not at all invested with peritoneum, as you proceed from above downwards. The summits of the recto-vesical folds landmark the point of junction of the upper and middle portions.

The whole of the posterior aspect, the fundus and the three upper fourths of the anterior aspect of the *uterus* are invested with a peritoneal coat. The os uteri, which projects into the vagina, the lower fourth of the anterior aspect, which is in immediate contact with the bladder, and the little lateral linear spaces where the broad ligaments are attached, are destitute of it.

The peritoneum reaches the *vagina* behind the uterus, and invests a small portion of it in that situation, but does not come into relation with it in front of the uterus.

The *ovary* is very closely and completely surrounded with peritoneum, which reaches it at its attachment to the broad ligament; we must in this case as heretofore describe a little linear space, at the point of attachment, as destitute of peritoneal vestiture.

The *bladder* is covered by peritoneum over a different extent in the two sexes. In both male and female its anterior aspect is destitute of peritoneal covering; and its fundus, in both sexes, has a peritoneal investment equally complete: with regard to the posterior aspect, however, in the male, the peritoneum covers it often as far down as the prostate, whilst it leaves

uncovered a large portion of the lower part of this aspect of the bladder in the female.

The parietal portion of the peritoneum invests the *anterior and lateral abdominal walls* completely, except at the lower part, where it is borne off from the anterior walls by the bladder and along the linear attachment of the falciform ligament of the liver; the *under surface of the diaphragm*, except between the layers of the coronary ligament of the liver, and along the linear attachments to it of the falciform and triangular hepatic ligaments, the phrenico-gastric ligament, and the splenic omentum; the *posterior parietes*, except where the viscera, ducts, and vessels enumerated above as invested with the peritoneum on their front only, intervene. It does not, however, reach the *inferior abdominal parietes*, that is to say the *levator ani*, at any point, a quantity of loose cellular tissue occupying the interspaces of the pelvic viscera between that muscle and the lowest point to which the peritoneum extends.

We now come to the last of our propositions.

THE EXTERNAL OR ADHERENT SURFACE OF THE PERITONEUM is attached to the apposed tissues with different degrees of intimacy in different situations—a circumstance of great importance with regard to certain surgical operations. This attachment is intimate or otherwise, according as the areolar tissue that constitutes the connecting medium is abundant or scarce, loose or compact, in different situations. The connecting areolar tissue is continuous through the openings in the abdominal parietes with the other areolar sheets of the body. The *parietal portion* of the peritoneum is strengthened by a fibrous layer, so that abscesses seldom burst through it; whilst the visceral portion, being destitute of this layer, is not unfrequently burst through by abscesses of an abdominal viscus, as the liver. The peritoneum lining the under surface of the diaphragm is the most firmly attached of all the parietal portion. That which lines the anterior abdominal parietes is very intimately adherent along the *linea alba* and sheath of the rectus, but very loosely just above the pubis and about the internal abdominal ring. It is extremely loosely attached to the posterior abdominal parietes and immediately superjacent organs, and in the lumbar and pelvic regions and iliac fossæ—a very fortunate circumstance with regard to placing ligatures on the large abdominal and pelvic vessels without laying open the peritoneal cavity.

The *visceral portion*, as it covers the liver and spleen and the alimentary tube, is very intimately adherent to them except at the middle portion of the rectum. That which partially covers the bladder adheres very loosely to it; owing to which, together with the looseness of the peritoneal attachment above the pubis in front, to the rectum behind, and to itself in the recto-vesical folds, the bladder when distended rises high above the pubis between the abdominal parietes and peritoneum, pushing the latter up so as to diminish the depth of the recto-vesical cul-de-sac and

leave its inferior fundus uncovered by it; consequently the bladder when distended may be punctured above the pubis or through the rectum without injuring the peritoneum.

In the mesenteries, omenta, and other peritoneal duplicatures, where the external surface of the peritoneum adheres to itself, the adhesion is generally extremely intimate. They are most separated where deposits of fat have taken place between them. The recto-vesical folds and the broad ligaments of the uterus alone, of all the peritoneal duplicatures, have their layers loosely adherent.

The peritoneum is very frequently the seat of extensive inflammation, the lymph effused in which process, besides causing adhesions of the abdominal viscera to one another and to the parietes, frequently covers the free peritoneal surface with a thick adherent layer or false membrane; and this, like some other tissues formed from lymph, shrinks or cicatrizes in every direction, and thereby produces some very curious secondary effects. In such cases, if the great omentum is free at its lower border, it becomes tucked up to the greater convexity of the stomach and apparently obliterated; or if adherent, as to a hernial sac, the shrinking of the new tissue that covers it drags down the stomach. The thin sharp edges of the liver become rounded by this agent, and the calibre of the intestinal tube diminished; sometimes the intestine is even strictured by the contraction of an unusually large deposit at a particular part. The tendency of this tissue to shrink, however, being controllable by sufficient mechanical resistance, is most manifest in those directions in which it experiences no such opposition; for which reason it tells more on the length than on the circumference of an intestine, and Cruveilhier met with a case of chronic peritonitis in which the small intestine measured only seven feet in length. If the hand is placed on the belly of a person in whom this condition exists, the muscles are felt to glide loosely over the peritoneum rendered tense beneath them.

For the minute anatomy of the peritoneum see SEROUS MEMBRANE.

(*Simon Rood Pittard.*)

PHARYNX and MOUTH. (Gr. φαρυγξ.)—The pharynx is a large, muscular, and membranous pouch, placed behind the nose, mouth, and larynx, and resting upon the cervical vertebræ: it extends from the base of the skull above to a level with the fourth or fifth cervical vertebra and the lower border of the cricoid cartilage, and is at this point continued into the œsophagus: it occupies the middle line of the body and is a symmetrical organ: of a very irregularly funnel-shaped form, it is wide above and open in front to the cavities of the nose and mouth, and contracts as it descends behind the larynx: by the relation of this latter organ the interior of the pharynx is converted into a tube to be continued downwards to the stomach under the name of œsophagus. A common channel to the digestive and respiratory pas-

sages, it is alike beautifully adapted by its construction, on the one hand to receive the food and convey it onward to the alimentary canal, and on the other to preserve a perfectly free communication between the atmospheric air and organs of respiration: to this latter function may be added the power of modulating vocal sounds.

As the pharynx is so closely associated, both in function and anatomical relation, with the mouth and palate, I shall subjoin to its description that of these latter organs. In the further examination of the pharynx the following arrangement will be adopted. 1st. The description of its aponeurosis and muscles. 2ndly. Its attachments considered generally. 3rdly. To examine its cavity with the several openings related to it. 4thly. The mucous membrane and glandular apparatus; and, lastly, the vessels and nerves distributed to it.

1. *The fibrous membrane.*—This aponeurosis, named cephalo-pharyngeal, contributes to the formation of the pharyngeal parietes above, and is essentially the means by which the pharynx is affixed to the base of the skull: it forms a sort of framework for the support of the muscular and mucous tunics above, and is imperceptibly lost as it descends between these structures: it is thin but strong and well-marked superiorly, and connected, by uniting intimately with the periosteum, to the under surface of the basilar process of the occipital bone, and, by a particularly dense slip, to its spine centrally; this latter may be considered as the origin of that tendinous raphé which, descending in the median line along the back of the pharynx, acts as an uniting medium to the constrictor muscles of either side: the basilar attachment of the cephalo-pharyngeal aponeurosis occurs immediately anterior to the insertions of the recti capitis antici muscles, and is consequently some little distance in advance of the occipital condyles and foramen: extending laterally, the aponeurosis next springs from the under surface of the petrous portion of the temporal bone as far outwardly as the external orifice of the carotid canal, just anterior and internal to which it turns suddenly forwards and inwards, forming a sharp angle, then passes beneath the inner surface of the levator palati muscle, to attach itself to the cartilaginous portion of the Eustachian tube, near the anterior extremity of which it terminates by being gradually lost upon the mucous membrane: descending from these several points, and bounding the upper part of the pharyngeal cavity posteriorly and laterally, it insinuates itself between the mucous membrane and superior constrictor muscle, and splitting up into filaments which pass between the numerous mucous glands that are found at this part of the pharynx is lost from an inch to two inches below the base of the skull: posteriorly, on either side the median line, and between the upper semicircular margins of the superior constrictor muscles and the base of the skull, a considerable part of this aponeurosis is uncovered by muscular fibres, constituting what are called the sinuses of Morgagni: the fibrous

membrane is of great width at its origin, the external carotid foramina marking off the lateral limits, but it quickly narrows as it descends: the sharp angle which it forms is brought into relation with the internal carotid artery and superior cervical ganglia of the sympathetic nerve: in the interior of the pharynx a longitudinal sulcus, sometimes crossed by a transverse slip, will be found behind the opening of the Eustachian tube, leading to a cul-de-sac which occupies this angle.

The pharynx is surrounded by muscular fibres which have been collected into three distinct muscles on either side, and named, from their action, constrictors; these may be considered as intrinsic: two other muscles on either side are inserted into its walls, and are extrinsic as not belonging so exclusively to it. The constrictor muscles are membraniform, spreading as thin muscular laminae around the sides and back part of the pharynx, and have a common insertion into a posterior median raphé: they partly overlap each other from below upwards, so that the inferior constrictors alone can be wholly examined without interfering with the rest, and are invested on their outer surface with a dense fascia: they arise by numerous and distinct points of attachment, which gave occasion to their being divided originally into several muscles, each with its appropriate name given according to its particular origin: these are now reduced to three on each side, and arranged into superior, middle, and inferior.

*Constrictor pharyngis inferior.** — This muscle is the thickest and strongest of the set, has an irregular quadrilateral outline, and is situated at the lower part of the pharynx: it derives its origin from the cricoid and thyroid cartilages by two slips: the one, triangular and fleshy, arises from the side of the cricoid cartilage between the origins of the crico-arytenoideus posticus and crico-thyroideus muscles: from the latter it occasionally receives a few fibres: the other, broader and more extensive, lies on the ala of the thyroid cartilage, and arises from the two tubercles, which the ala presents on its external surface, and from a tendinous structure that stretches obliquely from one tubercle to the other: it is here blended with the attachments of the sterno-thyroid and thyro-hyoid muscles: it also embraces the inferior cornu of the thyroid cartilage: from these points it spreads round the side and back of the pharynx to the posterior median raphé, into which it is inserted conjointly with the muscle from the opposite side: the fibres pass in different directions: the superior are longer and pursue a more oblique course upwards, while the nearer they are examined to the lower margin of the muscle, the shorter and less oblique they become, and at length assume nearly a transverse direction. The origins of the inferior constrictor muscle are concealed by the thyroid gland and sterno-thyroid muscle: it is in relation laterally to the

sheath of the carotid vessels, and posteriorly to the cervical vertebræ and deep muscles of the neck: its internal surface is applied partly upon the mucous membrane and the terminal fibres of the stylo-pharyngeus and palato-pharyngeus muscles, but to a greater extent upon the middle constrictor muscle: the oblique upper margin extends as high as the middle of the pharynx and close by its thyroid attachment allows the superior laryngeal nerve to pass beneath it: the circular fibres of the œsophagus are continued from its lower margin, but distinguished by their greater delicacy and paler colour: close to the cricoid cartilage the inferior or recurrent laryngeal nerve slips beneath its lower margin. Some of the lower fibres have occasionally been noticed to arise from the first ring of the trachea.

*Constrictor pharyngis medius** is of a triangular form, fixed by its apex to the hyoid bone and by an extensive base to the median raphé behind: its origin is received into the angle formed by the greater and smaller cornua of the os hyoides, to which processes the muscular fibres are attached as well as to the lower part of the stylo-hyoid ligament: the origin extends along the greater cornu quite to its posterior extremity, and is concealed by the hyo-glossus muscle, the lingual artery intervening: from this contracted commencement the middle constrictor spreads widely over the back of the pharynx, the superior fibres obliquely ascending towards the basilar process of the occipital bone, to the spine of which they are connected through the medium of the raphé, the muscle itself rarely reaching so high; the middle fibres take a more or less transverse direction, while the inferior descend under cover of the inferior constrictor: the whole muscle is inserted, with its fellow from the opposite side, into the raphé. After emerging from beneath the hyo-glossus it is related to the external carotid artery and superior laryngeal nerve laterally, and to the vertebral column behind: by its internal surface it overlaps the superior constrictor, and is applied upon the stylo- and palato-pharyngei muscles and the mucous membrane. Near the great cornu of the hyoid bone the stylo-pharyngeus muscle insinuates itself beneath its upper border, separating it from the superior constrictor.

Constrictor pharyngis superior,† quadrilateral in shape and complicated from its very numerous attachments. The fibres of this muscle are paler and it is altogether thinner than the two former: it arises, firstly, by short tendinous fibres from the lower half of the posterior edge of the internal pterygoid plate and its hamular process; secondly, from an aponeurosis described as the inter- or pterygo-maxillary ligament common to it and the buccinator muscle, and which stretches from the inner pterygoid plate to the posterior extremity of the alveolar border of the inferior maxillary bone; thirdly, from the back part of the mylo-hyoid ridge;

* Hyo-pharyngeus.

† Cephalo-pharyngeus, pterygo-pharyngeus, mylo-pharyngeus, glosso-pharyngeus.

* Thyro-pharyngeus, crico-pharyngeus.

and, lastly, is said to arise from the side of the tongue near its base: this lingual origin is considered by some anatomists as a part of the genio-hyo-glossus muscle:* arising thus, the superior constrictor winds round the pharynx and is inserted into the cephalo-pharyngeal aponeurosis, upon which it is placed, and joins with its fellow from the opposite side at the median raphé. The superior fibres make a semicircular sweep upwards towards the spine of the basilar process, to which they are connected by the raphé: the rest pass more transversely to their insertion and are partially overlapped by the middle constrictor: between the upper border of this muscle and the base of the skull the pharyngeal aponeurosis is left uncovered by muscular fibres. The superior constrictor corresponds posteriorly to the cervical vertebræ, and is separated laterally from the internal pterygoid by a triangular space which is occupied by the internal carotid artery, internal jugular vein, and the eighth and ninth pairs of nerves: the stylo-pharyngeus muscle is also related to its outer side before it descends beneath the middle constrictor: by its internal surface it is applied upon the levator palati and palato-pharyngeus muscles, the mucous membrane and the tonsil.

The muscular layer thus formed round the pharynx is of varying thickness, the greatest strength prevailing behind the buccal cavity, where the inferior constrictor, in itself the strongest of these muscles, overlaps the middle: on the other hand, there is but little occasion for muscular action behind the nasal fossæ, so we find, in accordance with this circumstance, a greater delicacy in the fibres of the superior constrictor and a deficiency of muscle altogether higher up: probably, also, the overlapping of these muscles from below upwards and the oblique direction of many of their fibres have reference to the downward passage of the food. The margins of the constrictors, as these muscles lie on each other, are not very distinct, particularly towards the back part of the pharynx. Additional muscular slips have occasionally been observed by different anatomists, which may be briefly noticed:—1. fibres from the petrous process of the temporal bone to pass downwards and backwards; 2. from the basilar process directed inwards; 3. from the internal pterygoid plate and hamular process directed downwards and inwards; 4. from the spinous process of the sphenoid and from the cartilaginous portion of the Eustachian tube.

Use.—Besides constricting the cavity of the pharynx, the inferior and middle constrictors can raise the larynx and carry it backwards, the latter through the medium of the os hyoides.

The extrinsic muscles of the pharynx are two on either side, the stylo- and palato-pharyngei.

* Cruveilhier says "that those fibres of the genio-hyo-glossus, which occupy the interval between the os hyoides and the stylo-glossus, cover the corresponding portion of the pharynx, or rather the amygdaloid excavation." Valsalva and Santorini regard these fibres as forming a distinct muscle, and name it the glosso-pharyngeus.

Stylo-pharyngeus.—This is a long slender muscle, broader below than above, and arises from the inner side of the styloid process at its base, and from the neighbouring part of the vaginal process: it descends inwards and forwards towards the greater cornu of the os hyoides, and expanding insinuates itself beneath the upper edge of the middle constrictor muscle to be applied upon the mucous membrane of the pharynx: it is inserted with the palato-pharyngeus into the posterior border of the thyroid cartilage: soon after its origin it passes with the stylo-glossus muscle between the external and internal carotid arteries, lying upon the latter and the internal jugular vein: a particular feature in this muscle is its close relation to the glosso-pharyngeal nerve, which winds round its lower border from behind forwards: as it descends, its next relation is the side of the superior constrictor, and passing between it and the constrictor medius it is applied upon the mucous membrane of the pharynx.

Use.—The stylo-pharyngei raise and widen the pharynx, preparing it for the reception of the food: they are important muscles in deglutition: the larynx is also raised by them.

Palato-pharyngeus.—This muscle will be again referred to as belonging to the palate: its fibres are contained in the fold of mucous membrane known as the posterior pillar of the fauces: it expands upwards to the soft palate, and downwards to the pharynx under the superior constrictor: it descends to spread its fibres on the mucous membrane, and is inserted with the stylo-pharyngeus into the posterior border of the thyroid cartilage.

2. *General review of the attachments of the pharynx.*—By referring to the foregoing descriptive anatomy of its aponeurosis and muscles, the pharynx will be seen to form from one-half to two-thirds of a vertically elongated cylinder, open in front; and although before terminating, the interior of the pharynx is converted into a complete canal, it is so only by the relation of a totally distinct organ, viz. the larynx. Descending perpendicularly from the base of the skull to the lower border of the cricoid cartilage, the pharynx is applied evenly to the anterior aspect of the bodies of the cervical vertebræ and deep muscles of the neck, having a remarkably loose areolar tissue intervening, important as preserving to it a perfect freedom of motion, while, by its anterior edges, it is fixed to the internal pterygoid plates, to the pterygo-maxillary ligaments, by means of which it is continuous with the lateral walls of the mouth, to the inferior maxillary bone, the sides of the tongue and cornua of the os hyoides, thus forming behind the nasal and buccal cavities a large pouch, whose parietes being constantly strained apart by these attachments, preserve a perfectly free cavity, a circumstance of considerable importance with reference to the continual passage of air to and from the respiratory apparatus: continuing downwards, the pharynx next embraces the sides of the thyroid and cricoid cartilages, but as there is no longer occasion for this tension of its walls,

they become flaccid, and are loosely applied to the posterior surface of the larynx, and so continued into the œsophagus: if examined from behind, the pharynx is seen to be of great breadth at the base of the skull, but narrows until opposed to the buccal cavity, where it again widens to contract somewhat abruptly at its termination: its lateral relations to the carotid vessels and nerves of the neck have been considered in the descriptions of the constrictor muscles.

3. *The cavity and its openings.*—The interior of the pharynx exhibits a cavity of considerable size, which is continuous with those of the nasal fossæ and mouth anteriorly and the canal of the œsophagus below. To study the varying dimensions of this cavity and the different openings which communicate with it, the pharynx must be slit up posteriorly and in the median line; its greatest breadth is behind the mouth, the buccal portion, which may be measured by the interval between the posterior extremities of the alveolar border of the lower jaw, and is rather more than two inches; thence narrowing upwards, the internal pterygoid plates will by their distance from each other, which is about one inch, give the diameter of the cavity at its nasal portion, while the distance between the posterior edges of the alæ of the thyroid cartilage will denote its breadth at the inferior or laryngeal portion: the antero-posterior diameter can vary but little, in consequence of the relation which the vertebral column has to the pharynx behind: during the act of deglutition these measurements are of course altered, but there is much less change of form in the upper or nasal portion of the cavity than in the rest of its extent. Dropping into the cavity from before backwards and from above downwards is the velum palati with the uvula depending from the centre of its posterior border: above this moveable curtain are seen the posterior openings of the nose with its median septum, the vomer: these are situated between the internal pterygoid plates, extend upwards to the base of the skull, and are limited below by the velum; they are quadrilateral in their outline and continued into the upper part of the pharyngeal cavity; a little way within the nasal fossæ and along their outer walls are seen the meatuses of the nose and the posterior edges of the inferior turbinated bones; prolonging these latter backwards by an imaginary line, we are brought to the openings of the Eustachian tubes; they are two narrow elliptical fissures, their long diameters, about three-eighths of an inch, directed from above downwards, and situated one on either side of the pharynx above the soft palate, and impinging the posterior edges of the internal pterygoid plates; they look forwards and inwards towards the inferior and middle meatuses of the nose, and are marked by prominent and rounded margins internally; an accurate knowledge of their relation to the nasal fossæ is of practical use in directing a probe or syringe into their canals; behind the openings of the Eustachian tubes are the longitudinal sulci which lead upwards and backwards to a cul-de-sac that occu-

pies the angle formed by the sudden bending forward of the aponeurosis of the pharynx; below the velum is the posterior constricted aperture of the mouth, which will be again referred to in the description of the soft palate; it is limited above by the velum, below by the base of the tongue, and laterally by the posterior pillars of the fauces; the uvula depending from the velum centrally gives it a double arched outline above, but it is capable of assuming changes of form by the varied movements of its boundaries, which are especially concerned in deglutition; below the isthmus faucium and behind the base of the tongue is the superior aperture of the larynx, surmounted in front by the epiglottis; it is a triangular opening, the base directed forwards, and it has also an oblique direction from above downwards and from before backwards; it is generally completely closed during deglutition by the epiglottis being forced down upon it; on either side of the posterior surface of the larynx, between the thyroid and cricoid cartilages, are two gutters which lead downwards to the œsophageal opening of the pharynx; this opening has its long diameter from side to side in the flaccid state of its walls, but assumes a circular form when distended by the passage of food through it.

4. *Mucous membrane and glands.*—The interior of the pharynx is lined by a mucous membrane continuous with that investing the several cavities which open into it; it is of a reddish colour, and adherent to the muscular parietes by a thin submucous areolar tissue; from covering the back part and sides of the interior of the pharynx, it is to be traced along the under surface of the basilar process united to the periosteum through the medium of its submucous tunic, which at this part acquires considerable thickness, and is occasionally the seat of polypus; laterally and above it is reflected over the guttural orifice of the Eustachian tube, enters the canal, and is conducted by it to the cavity of the tympanum, forming an exceedingly thin lining to both; continuous with the mucous membrane, investing the upper surface of the velum, it passes through the posterior nasal openings into the nose; it may be next traced through the isthmus faucium, covering the under surface of the velum and posterior pillars of the fauces, to be continuous with the membrane of the buccal cavity, while more interiorly, after assisting to form the aryteno-epiglottidean folds of the laryngeal mucous membrane, it is reflected over the posterior surface of the larynx, to which it is connected so loosely by an areolar tissue as to be thrown into longitudinal folds, a provision for the dilatation of this part of the pharynx during the passage of the food; lastly, it is continued into the œsophagus. The mucous membrane above the velum palati, upon its upper surface and within the Eustachian tubes, is coated with epithelial prisms, corresponding in this respect with that which lines the greater part of the nasal cavities, while below the velum the epithelium assumes the lamelliform or scaly character. (See MUCOUS MEMBRANE.) As it invests the upper

part of the pharynx its free surface presents numerous slight elevations occasioned by the glands which are situated beneath it; these indeed are scattered over the whole pharynx, but are especially abundant at its upper part, where they form a compact lamina between its musculo-membranous tunic and the mucous membrane, opening upon the surface of the latter by slender ducts.

5. *Vessels and nerves.*—The bloodvessels distributed to the pharynx are derived from several sources, but chiefly from an especial trunk, viz. the ascending or inferior pharyngeal artery; this vessel arises from the posterior part of the external carotid, often its first branch, near the bifurcation of the common carotid; it ascends to the base of the skull, lying close by the side of the pharynx and upon the rectus capitis anticus major muscle, sending off numerous small branches, which, intermingling with the pharyngeal plexus of nerves, are distributed to the constrictors and stylo-pharyngeus, to the velum, arches of the palate and tonsil, ending in minute ramifications on the mucous membrane; the next most regular supply is from the inferior palatine and tonsillitic branches of the facial artery; the internal maxillary, lingual and superior thyroid vessels contribute an irregular supply of small and unimportant twigs. The veins form a considerable plexus, the pharyngeal venous plexus, which is produced chiefly by the frequent anastomoses of the pharyngeal vein with the small branches that accompany the inferior palatine and tonsillitic arteries, and with some of the commencing twigs of the internal maxillary vein; the pharyngeal vein, which receives the blood from this plexus, opens, either singly or in conjunction with the lingual, into the internal jugular vein; of the lymphatics, but little is known; they probably enter the chain of glands which lie along the outer side of the carotid sheath. An intricate plexus of nerves, the pharyngeal plexus, is situated upon the sides of the pharynx, the branches being particularly numerous upon the middle constrictor muscle near its origin; it is of some length, and subject to variety in the number of its filaments in different subjects; it interlaces with the ramifications of the arterial twigs from the ascending pharyngeal, and derives its branches from the three portions of the eighth pair of nerves and from the superior cervical ganglion of the sympathetic; the glosso-pharyngeal nerve sends downwards two or more branches to the plexus; one of these I have seen to join the superior laryngeal nerve; they are given off just before the nerve winds round the lower border of the stylo-pharyngeus muscle; subsequently one or two branches penetrate this muscle to be distributed to the pharyngeal mucous membrane; the pneumo-gastric detaches one or two pharyngeal branches; the larger one appears in a great measure formed by a branch from the spinal accessory nerve; these join with the filaments from the glosso-pharyngeal; the superior laryngeal nerve by its external branch also contributes a few filaments; lastly, from the superior cervical ganglion of the sympathetic, twigs are

derived, which, communicating with those already mentioned, complete this intricate plexus; the branches from it are distributed to the pharyngeal walls, to the soft palate, and stylo-pharyngeus muscles. The digastric branch of the facial nerve and the lingual or its descending branch are described as sometimes communicating with this plexus: for the more minute anatomy of these nerves see PAR VAGUM, GLOSSO-PHARYNGEAL NERVE, AND SPINAL ACCESSORY.

Mouth, (Gr. *στομα*; Lat. *os*; Fr. *bouche*.)—The mouth is an oval cavity, symmetrical, and situated at the lower part of the face, below the nasal fossæ, between the jaws, and in front of the pharynx, with which it communicates by a posterior opening, called the isthmus faucium, and has also a dilatable aperture anteriorly guarded by the lips: it is liable to considerable alterations of form and size, from complete closure to a state of extreme extension, when it represents a quadrangular pyramid with the base in front: the greatest change occurs in its vertical diameter from the movements of the lower jaw; in it are performed the various functions of mastication, tasting, partly that of deglutition, and it is subservient also to the production of articulate sounds. The mouth or buccal cavity is bounded both laterally and anteriorly by the alveolar borders of the upper and lower maxillary bones and teeth, the lips completing the boundary in front and the cheeks laterally: above it is roofed in by the arched palate and more posteriorly by the velum palati; inferiorly the tongue forms its floor. In the examination of these boundaries the reader is referred to the articles FACE and TEETH for the description of the maxillary bones and teeth.

The *lips* (*labia*) are two moveable curtains placed in front of the mouth, presenting between them when applied to each other a transverse slit convertible by their separation into a more or less considerable opening, which constitutes the anterior aperture of the buccal cavity: the lips are united at the lateral limits of this fissure to form the commissures or angles; the anterior surface of the upper lip, which usually projects a little beyond the lower, is covered with hair in the adult male, and exhibits in the median line a vertical groove continued to its free border from the septum of the nose: two ridges bound this furrow on either side, and from thence the upper lip passes off laterally to the cheek, insensibly in the young and plump face, but otherwise a line of demarcation is produced by an oblique fold of the skin which descends from the side of the nose to near the commissure of the lips on either side of the face: the anterior surface of the lower lip descends more or less abruptly backwards to the chin, divided from it by a transverse groove: it is covered with hair usually at the centre only, and slightly bulging near its free border shelves off gradually to the sides of the face: the free borders are the thickest parts of the lips, their large development forming a characteristic feature in the Negro; in their outline they differ, presenting

in the upper lip a projection in the centre, from which a curved line, gently arching upwards, proceeds laterally, while, in the lower, the centre exhibits a depression, and the line from it proceeds in a contrary direction, so that when the mouth is closed these borders are applied evenly to each other: they are of a red colour, turned outwardly, and marked from before backwards by slight wrinkles produced by the contraction of the orbicular muscle; their chief interest to the anatomist is in showing the continuity of the skin with the mucous membrane. Besides the tegumentary coverings of skin and mucous membrane, these organs contain within their thickness the orbicularis muscle, with which are blended the insertions of the greater number of the muscles of the face (see FACE), whose varied actions render these features so peculiarly expressive of the passions: numerous glands, vessels, and nerves, and an areolar tissue complete their structure. The labial glands constitute a thick lamina between the muscular and mucous layers, producing slight elevations upon the surface of the latter; they resemble the salivary glands in appearance, are of small but varying size, placed close to each other but perfectly distinct, each possessing a separate excretory duct, which opens upon the free surface of the mucous membrane. The lips are most abundantly supplied with vessels and nerves; the coronary arteries, from the facial, course along their free borders directly beneath the mucous membrane; they also receive numerous twigs from the buccal, infra-orbital, and mental branches of the internal maxillary and submental branch of the facial; the veins accompany the arterial branches; the lymphatics terminate in the glands at the base of the jaw, as evidenced by the frequent enlargement of the latter from the irritation of cancerous or other sores about the lips: the nerves are derived from the portio dura and fifth pair.

Use.—The lips are of great importance, more particularly the lower, in retaining the saliva within the cavity of the mouth, and are actively engaged in the acts of sucking and blowing; the utterance of many articulate sounds depends chiefly upon their action, and when viewed as organs of expression they are particularly adapted by their extreme mobility to indicate the passing thought.

The cheeks (buccæ) form the lateral extensible walls of the buccal cavity; examined from the interior of the mouth they will be found limited above and below by the reflexion of their investing mucous membrane upon the external surfaces of the superior and inferior maxillary bones: their superficial surface is bounded behind by the external ear and the posterior border of the lower jaw, below by the horizontal ramus of the same bone; superiorly they may be arbitrarily separated from the temple by the zygoma, and from the orbit by the lower margin of its cavity, and are continued anteriorly into the sides of the nose and lips; they therefore present somewhat of a quadrilateral outline, and in the young and

healthy form a rounded projection outwards, but in the emaciated fall in towards the mouth. The skin of the cheek is smooth, thin, and delicate in front and above, and remarkable for its extreme vascularity, as seen in the act of blushing; it is covered behind and below in the adult male with hair, and in the aged its surface is more or less furrowed with wrinkles: the subcutaneous cellular tissue is dense and loaded with a variable quantity of fat, a particularly abundant mass of which is lodged between the buccinator and masseter muscles. The muscular structure of the cheeks has been already described in the article FACE. Between the muscles and mucous membrane arc irregularly dispersed a considerable number of buccal glands; they are of small size, similar to those of the lips, and like them open upon the mucous surface by separate ducts: these openings are not likely to be mistaken for that of the parotid duct, which is marked by a very distinct prominence, is of larger size and situated opposite the interval between the second and third molar teeth in the upper jaw: there is an aggregation of several of these buccal glands, imbedded in the fat between the buccinator and masseter muscles, forming a larger glandular mass which opens into the mouth opposite the last molar tooth, and has been called the molar gland. The cheeks receive a rich supply of vessels from the facial, transverse facial, and internal maxillary arteries; the veins correspond to these branches and empty themselves into the internal and external jugular veins. The lymphatics probably terminate in the glands of the neck. As with other parts of the face, the cheeks derive their nervous filaments from the portio dura and fifth pair.

Use.—While the tongue guides the food outwardly to the teeth, the cheeks act in retaining it between them during mastication; they are employed during the act of sucking, and when distended by air or fluids they are actively engaged in forcibly expelling them, as exemplified in playing upon wind instruments or in squirting liquids from the mouth.

The palatine arch and gums.—The palatine arch or hard palate forms the greater part of the superior boundary of the buccal cavity: it has a parabolic figure, bounded laterally and in front by the teeth, and is continued posteriorly into the velum palati without exhibiting any line of demarcation: it presents mesially a whitish ridge, more prominent before than behind, which commences from a small eminence situated immediately behind the incisor teeth and corresponding with the lower orifice of the anterior palatine canal; the ridge then extends backwards and is traceable as far as the uvula; from it are passing laterally a variable number of transverse rugæ, apparent only at the anterior part of the palate, its buccal surface being, in the greater part of its extent, perfectly smooth. The palatine arch is framed by the palate processes of the superior maxillary and palate bones,* and invested on their

* See FACE.

under surface by a dense and thick mucous membrane: numerous glands with vessels and nerves also enter into its structure. The mucous membrane covering the bony palate with that forming the gums is of a paler colour than elsewhere in the interior of the mouth, and is united by a remarkably condensed and thick submucous areolar tissue to the periosteum, especially in the mesial line, where the two structures appear blended: on either side the union occurs by fibrous prolongations, allowing a thick layer of glands and the vessels and nerves of the palate to intervene: the membrane has a thick investment of epithelial scales, and is capable of resisting considerable pressure; of greater thickness before than behind, indifferently sensible, and in structure bears some analogy to that of the skin: the glands in every way resemble those of the cheeks and lips, and open in like manner upon the mucous surface; two larger openings than the rest may often be seen on either side the median line towards the back part of the palate.

The gums (Gr. *ουλα*, Lat. *gingiva*) resemble in colour and structure the palatine membrane, except that the glandular apparatus is here reduced to mere follicular pores. They cover either surface of the alveolar processes of the jaws, intimately connected with the periosteum, and extend a little way beyond the alveoli to rest against the necks of the teeth by a festooned edge. The denticulated processes of this edge are continued across the alveoli between the teeth, by which means the gums on either surface communicate with each other; between these processes the concave margin of the gum is reflected upon itself to enter the alveoli, lining their inner surface, and closely applied to the fangs of the teeth. (See *TEETH*.) The palate and gums receive their arterial branches from the internal maxillary and facial arteries, and their nerves from the sphenopalatine or Meckel's ganglion. (See *FIFTH PAIR OF NERVES*.) The palatine nerves gain the palate through the anterior and posterior palatine foramina, and course along immediately beneath the periosteum, lodged in grooves, together with the accompanying arteries, upon the inferior surface of the palatine processes of the superior maxillary and palate bone. The palatine arch constitutes the septum between the nasal and buccal cavities, and forms the fixed and resisting surface against which the tongue acts in deglutition and in the articulation of certain sounds; previous to the irruption of the teeth and after their decay, the gums are continued over the alveolar processes, and by their almost cartilaginous hardness supply their place; they are rendered peculiarly soft and spongy by the influence of mercury and scurvy upon the system.

The velum palati is a soft moveable curtain stretching backwards and downwards into the cavity of the pharynx from the posterior border of the hard palate, but so continuous with it as to exhibit no indication of their union. From its oblique direction the buccal or inferior surface is also anterior; it is concave, prolongs

backwards the roof of the mouth, and presents the median ridge already noticed on the under surface of the hard palate. The nasal or superior surface looks upwards and backwards, is smooth, convex, and continuous with the floor of the nasal cavities; these surfaces terminate in a thin border posteriorly, which is prolonged downwards in the middle line to form the uvula. The uvula is of a conical shape, and varies in length and size in different individuals; it is occasionally found to be bifid at its extremity; it gives rise on either side near its base to two folds of mucous membrane, called the pillars of the fauces, which descend diverging towards the sides of the tongue at its back part, leaving between them an interval which is in a great measure occupied by the tonsil; the anterior pillar proceeds from the base of the uvula in front, and arching outwards and downwards terminates at the side of the tongue a little in advance of the V-shaped ridge of papillæ; the two anterior pillars together form what is denominated the anterior arch of the fauces. The posterior pillars constitute in fact the free border of the velum; they are nearer to each other at their commencement than the anterior, and from this circumstance (although on a plane posterior) can be seen at the same time with the anterior pillars on looking into the mouth; they spring from the sides of the uvula to take an arched course outwards and downwards and terminate in the sides of the pharynx. The posterior pillars laterally, with the velum and uvula above and the base of the tongue below, bound the constricted aperture between the cavities of the mouth and pharynx, which is called the isthmus faucium; the uvula dropping in the centre gives the superior outline of this opening a double arched form: it is extremely dilatable, and may be contracted nearly to complete closure by the muscular action of its walls; it is essentially concerned in the act of deglutition. The fossa which is left on either side between the anterior and posterior pillars is of a triangular shape, narrow above where the pillars approach each other, broader and deeper below as they diverge. The lower part of this will nearly correspond to the angle of the jaw.

Muscles of the velum palati.—These are on each side, the circumflexus or tensor palati and levator palati mollis, which descend from above to be attached to the velum near its upper surface; and the palato-glossus and palato-pharyngeus muscles, which descend from it to the tongue and palate; lastly there is the central azygos uvulæ muscle.

The circumflexus palati, tensor palati, or the peristaphylinus externus (pterygo-staphylin. Chauss.) is a flat, thin muscle, lying to the inner side of the internal pterygoid, and with it occupying the pterygoid fossa; it arises by tendinous and fleshy fibres from the scaphoid depression situated at the upper part of the inner pterygoid plate, and extending more outwardly, from a part of the external surface of the cartilaginous portion of the Eustachian tube. The muscle descends, partly tendinous and partly fleshy, resting against the outer surface of

the internal pterygoid plate, but of sufficient breadth to extend beyond its posterior edge, and terminates in a tendon which winds round the hamular process; it is here retained in its situation by a small ligament and is surrounded by a synovial capsule to facilitate its movements. The tendon now alters its direction, for suddenly expanding into a thin but strong aponeurosis it spreads horizontally forwards and a little upwards to be inserted into the whole of the posterior border of the palatine process of the palate bone and into its posterior nasal spine, uniting with the tendon from the opposite side in the median line. It is in relation, so far as regards the vertical portion of the muscle, by its outer surface with the internal pterygoid, and by the inner with the internal pterygoid plate and the superior constrictor muscle of the pharynx. The horizontal tendons of these muscles form a firm aponeurotic expansion in the substance of the velum, which, when tightened by the contraction of the vertical muscular fibres, affords a powerful resisting surface to the upward pressure of the food while being thrust by the tongue through the isthmus.

The levator palati or peristaphylinus internus (petro-staphylin. Chauss.) is a flat and narrow muscle, and commences by a thin tendinous and fleshy origin which is attached to the under rough surface of the petrous portion of the temporal bone and neighbouring part of the cartilaginous portion of the Eustachian tube on its inner side; from thence it descends, resting upon the cephalo-pharyngeal aponeurosis, then slips beneath the upper edge of the superior constrictor muscle, and passes upon its internal surface to reach the palate; the muscle now takes a more horizontal direction inwards, and expanding spreads its fibres in the substance of the velum to unite with its fellow from the opposite side in the median line, and is also inserted into the posterior border of the expanded tendon of the circumflexus palati. The insertions of the levator and circumflexus palati muscles on either side form a thin stratum, tendinous in front and muscular behind, through the whole extent of the soft palate. The levator palati in its vertical course is related by its outer surface to the Eustachian tube and circumflexus palati muscle, from which latter it is soon separated by the superior constrictor of the pharynx; it is covered internally by the pharyngeal aponeurosis and mucous membrane: it is an elevator of the pendulous portion of the soft palate.

The palato-pharyngeus or pharyngo-staphylinus consists of a delicate bundle of fibres contained in the fold of mucous membrane, known as the posterior pillar of the fauces; it expands upwards into the substance of the velum and downwards into the pharyngeal walls. The muscular fibres which spread in the velum are very delicate and mingled with those of the palato-glossus: they are situated immediately beneath the levator palati muscle and reach across the palate to join with fibres from the muscle of the opposite side in the middle line: some of the fibres are attached also to the posterior edge of the circumflexus

palati tendon: arching over the upper and posterior margin of the tonsil they contract to descend as a thin bundle in the posterior pillar of the fauces, and again expanding pass into the lateral wall of the pharynx between the mucous membrane and constrictor muscles; here they meet with the fibres of the stylo-pharyngeus muscle and have an attachment with them to the posterior border of the thyroid cartilage and to the pharyngeal mucous membrane. The principal action of these muscles is to contract the isthmus faucium, which they can do superiorly almost to obliteration; they can scarcely have much effect in raising the pharynx; if this latter be the fixed point, they may draw down the velum and so act as antagonists to the levatores palati.

The palato-glossus, or constrictor isthmus faucium (glosso-staphylinus), occupies the anterior pillar of the fauces and spreads its fibres in the velum with the palato-pharyngeus, then descends to expand upon the side of the tongue near its base, mingling its fibres with the stylo-glossus muscle. They may either act upon the velum by depressing it or raise the sides of the tongue to it.

Azygos uvulæ or palato-staphylinus is a slender fusiform muscle, or rather a pair of muscles lying side by side: a narrow slip of tendon attached to the posterior nasal spine gives origin to the muscular fibres, which proceed backwards and downwards in the middle line, resting upon the circumflexus and levator palati muscles, and are lost in the substance of the uvula, which organ they shorten.

The thickness of the soft palate is mainly dependent on a dense mass of small glands, a continuation in short of the series already described as occupying the structure of the palatine membrane. They form an extremely thick layer anteriorly, but as the velum thins to its posterior free border, so these glands become the more scattered as they are traced backwards; they lie between the muscles and the mucous membrane investing the under surface of the velum; a few also are scattered beneath the mucous membrane covering its upper surface, and a larger proportion of them in the substance of the uvula, its bulk being chiefly formed by them.

The tonsils or amygdalæ (*αμυγδαλις*) are lodged in the interval between the pillars of the fauces: they are almond-shaped, with their larger extremities directed upwards, but vary in size in different individuals. They appear to consist of an assemblage of mucous glands, whose excretory ducts terminate in small sacs that are imbedded in the substance of the tonsil, and which open by larger or smaller orifices upon the surface of the mucous membrane. When the tonsils are inflamed these sacs exude a whitish secretion, which has some resemblance to an ulcer on their surface. The palato-glossus descends in front of and the palato-pharyngeus behind these organs; they are supported externally by the superior constrictor muscle, and are covered upon their internal surface by the mucous membrane of the mouth. In inflammatory enlargements of the tonsil it is closely

related to the internal carotid artery, which vessel will be applied to its outer side and behind it, so that when an opening is required in the tonsil, the point of the lancet should be directed inwards towards the cavity of the mouth. The tonsils and soft palate are well supplied with blood by the palatine and tonsillar branches from the facial, by the ascending pharyngeal and internal maxillary arteries. A considerable plexus of veins is formed round the tonsil, which terminates in the pharyngeal venous plexus. Besides the nervous twigs derived from the palatine branches of Meckel's ganglion, the soft palate also receives filaments from a plexus formed around the tonsils by the tonsillar branches of the glosso-pharyngeal, which has been called the *circulus tonsillaris*. For the description of the tongue, the remaining boundary of the cavity of the mouth, see TONGUE.

Course of the mucous membrane.—The mucous membrane of the mouth is continuous with that of the pharynx and larynx. Commencing with the gums anteriorly, it passes upon the exterior surfaces of the upper and lower maxillary bones, and from thence is reflected on the cheeks laterally and upon the inner surface of the lips anteriorly, forming a small fold in the median line, called the *frænum*, to each; it invests the free borders of the lips and becomes continuous with the skin at a well defined line of demarcation. When the jaws and teeth are closed, the cheeks and lips are naturally in apposition with them; but if separated by distending the cheeks, the mucous membrane we have been tracing will be seen to line an anterior or second buccal cavity forming a kind of antechamber to the interior of the mouth. Proceeding from the gums posteriorly the membrane descends upon the interior of the lower jaw to be reflected upwards to the under surface of the tongue, and forms for it anteriorly and in the median line a prominent fold, the *frænum linguæ*; this occasionally is prolonged forwards to the apex of the tongue, interfering with its movements in the act of sucking: a slight division of the *frænum* under these circumstances is all that is required. From the under surface of the tongue the mucous membrane invests that organ and is continued from its base to the epiglottis, and after forming three folds, called glosso-epiglottic, is reflected over its free edge to be continuous with the laryngeal membrane. From the gums of the upper jaw posteriorly it invests the hard and soft palate and passes round the posterior free border of the latter, after enclosing the uvula, to cover its nasal surface. From the cheeks laterally it is to be traced over the anterior pillars of the fauces, the internal surface of the tonsils dipping into its mucous crypts, and lastly forming the folds of the posterior pillars is continuous with the mucous membrane of the pharynx. Throughout the cavity of the mouth it is invested with epithelial scales, and its submucous areolar tissue is remarkably increased in thickness and density when forming the gums and palate.

Function.—The pharynx, mouth, and palate are most obviously associated in the process of deglutition, in which we may trace three successive stages: in the first, the food after being reduced to a softened pulp by mastication and admixture with the saliva is conveyed to the back part of the mouth by the movements of the tongue against the hard palate; this is a purely voluntary act and can be arrested at the will of the individual: the food carried past the anterior arch of the fauces, the second act of deglutition immediately succeeds; this involves the consentient action of numerous muscles and is a most complicated process. If the movements of the *velum palati* and the posterior pillars of the fauces are examined during an effort to swallow, the former is perceived to become somewhat more arched towards the cavity of the mouth and to be rendered tense, but it appears to maintain nearly its naturally oblique direction. It has been supposed that the *velum* is raised during deglutition, in order to prevent the food from passing to the nose, but this opinion is now generally considered erroneous. Müller says, "Most writers incorrectly state that during deglutition the food is prevented from entering the posterior nares by the soft palate being raised, a movement which, if performed, could not in any case completely cut off the pharynx from the posterior nares." With the stretching of the *velum* the posterior pillars or palato-pharyngeal muscles will be seen to approach each other, particularly above, so as to reduce the *isthmus faucium* to a narrow triangular slit, broadest below. If the food is now pressed backwards by the tongue, it will be urged through this dilatable chink in a direction downwards and backwards, occasioned partly by the oblique resisting surface of the *velum*, and partly by the wider aperture left between the posterior pillars inferiorly, perhaps also by their greater disposition to yield in that direction to the pressure of the food as it passes between them; meanwhile the pharynx (and the larynx with it) has been drawn upwards, and at the same time widened by the action of the stylo-pharyngeal muscles, to receive the morsel, which in passing into it presses the epiglottis down upon the superior aperture of the larynx, and gliding over it is then immediately carried on to the œsophagus by the action of the constrictor muscles. The epiglottis in being shut down upon the opening of the larynx protects the respiratory tube, but it is not absolutely essential for that purpose; experiments have been performed on animals where the epiglottis has been removed, and it has been destroyed by disease in the human subject without any material difference evidenced in deglutition, the action of the laryngeal muscles closing the aperture of the larynx. This second act of deglutition may be performed at will though only the saliva is swallowed, but the effort soon becomes fatiguing. When the food, however, has reached beyond a certain limit in the mouth, no effort on our part can prevent deglutition from taking place. (For the influence of the nerves upon this function

and that of taste see PAR VAGUM, SPINAL ACCESSORY, GLOSSO-PHARYNGEAL.) The further passage of the food through the œsophagus into the stomach (see (ESOPHAGUS) constitutes the third stage of deglutition and occurs involuntarily.

MORBID ANATOMY OF THE PHARYNX AND MOUTH.

Congenital malformations.—The pharynx in a very few instances only, presents any malformation; when such exists the pharynx terminates in a cul-de-sac. Sir A. Cooper has recorded a case of this kind, in which also the œsophagus was altogether wanting and the stomach without a cardiac orifice: the child lived eight days. In acephalous monsters a total deficiency of the pharynx has been noticed, but this is of very rare occurrence. The hard and soft palates are occasionally liable to congenital fissure: owing to an arrest of development they fail to unite in the median line, and the result is what has been termed the cleft palate: this defect may be confined to the velum palati, or it may include the bony palate, and will sometimes extend through the front of the jaw: where the bony palate is involved the defect may vary from a mere fissure to an entire absence of the palatine arch, so that the nose and mouth are converted into a common cavity. The upper lip is not unfrequently fissured either on one or both sides of the median line, constituting the single or double hare-lip. This deformity may exist with or without the fissured palate, but cannot be considered as dependent simply on an arrest of development; for at no period of fœtal life is the lip known to present this peculiar condition: the fissure may only partially divide the lip, or it may extend into the nose in an oblique or vertical direction. It is very rare to find the lower lip fissured.

Foreign bodies in the pharynx may produce immediate suffocation, either by mechanically obstructing the opening of the larynx or by inducing spasm of the glottis; when any difficulty occurs in the extraction of these bodies, it is more generally dependent on their form than size. Angular portions of bone, needles, &c. are likely to become fixed by the contraction of the pharyngeal walls upon their pointed edges.

Structural changes.—The mucous membrane of the pharynx and posterior part of the fauces is very frequently the seat of inflammation, either simple or of a specific character; thus, it rarely escapes in scarlatina and syphilis without exhibiting the effects of these poisons: the latter often producing, by ulceration and sloughing, total destruction of the soft or even of the hard palate and causing fearful mischief. The tonsils generally participate in these inflammatory affections, or they may become inflamed primarily. In quinsy, the swelling of the tonsil is excessively rapid, and the disease is prone to terminate in suppuration. One effect of frequent inflammatory attacks is an indolent enlargement of the tonsil, a condition which is often with difficulty re-

medied, and occasionally requires excision of that organ.

Abscess sometimes occurs in the reticular tissue between the pharynx and cervical vertebrae, and protrudes the posterior wall of the former forwards, so as to interfere with deglutition.

Ulceration of the pharynx occasionally happens; it may be the result of a simple or specific inflammation, and will sometimes proceed to the destruction of its walls: fistulous openings between it and the larynx or other neighbouring parts may be thus produced. Cancer of the pharynx is fortunately not common, but cases have been noticed in which it has occurred.

Polypi have sometimes been found to take their growth from the mucous membrane of the pharynx, and most commonly spring from that portion of it which covers the posterior aspect of the larynx. Dr. Monro mentions a case of this kind in which the polypus was of considerable length, hanging down in the œsophagus; another seat of origin in the pharynx is from the membrane as it invests the under surface of the basilar process of the occipital bone: they have been seen to grow also from the soft palate.

A pouch is occasionally formed either behind or on either side of the pharynx by an extrusion through the muscular coat of its mucous membrane. A preparation in the Museum at St. Thomas's Hospital exhibits such an arrangement: a blind pouch about three inches in length, and of course communicating with the interior of the pharynx, descends by the side of it: the muscular parietes do not appear to have been at all prolonged upon its surface.

The cheeks, gums, and lips in children are sometimes involved in a destructive ulceration, to which the term *cancreum oris* has been applied; it may extend to almost any length, destroying the cheek, the lips, the gums, and teeth: it is seldom seen in adults. The gums, besides the softened and spongy change induced by scurvy and the well known effect caused by the introduction of mercury into the system, are also affected with the disease called *epulis*. In this case the gum is enlarged, reddened, and ulcerates, and demands excision of the entire diseased structure: it is generally considered of a malignant nature. The lower lip is sometimes the seat of cancerous ulceration; it has been questioned whether this disease is really true cancer. Sir A. Cooper, however, says, in his lectures, "That the disease is of a scirrhus nature, even at the beginning, any surgeon must be satisfied; it is hard, has a bleeding surface, everted edges, and, as it proceeds in its destructive course, communicates disease to the glands: there is likewise felt in it, at particular periods, the most dreadful pain. An operation for the complete removal of the disease is the patient's only real hope of succour." It is very rare for the same disease to originate in the upper lip.

(William Trew.)

PISCES. (Eng. *Fishes*; Fr. *Poissons*; Germ. *Fische*.)—The lowest class of the vertebrate division of the animal kingdom, embracing numerous oviparous races of beings fitted by their organization to live only in water, and consequently they are the appropriate inhabitants of the ocean and of inland streams and lakes. Being strictly aquatic in their habits, Fishes respire through the medium of the element in which they live by means of gills or branchiæ, that are connected with a framework of bony or cartilaginous arches situated on the sides of the neck, to which the water obtains free access, generally passing in at the mouth and escaping through lateral openings situated behind the head. Their heart is bilocular, and consists of an auricle and ventricle, which, receiving the venous blood from the system, propel it over the respiratory surface, whence it is collected into an arterial trunk, the aorta, by which it is distributed over the body without the intervention of a systemic heart. Their blood is of very low temperature, and their bodies are generally covered with scales of various kinds, whereby they are preserved from maceration in the surrounding water, and fitted to glide smoothly through the fluid medium wherein they live. Their principal instrument of progression is their tail, which is generally expanded into a broad fin, that strikes the water by alternate lateral movements. Besides this *caudal* fin others are frequently met with situated along the median line of the body, to which the names of *dorsal* and *anal* fins have been appropriated accordingly as they are situated upon the back or behind the anal outlet of the body. The position of these *azygos* fins is vertical, and their use to a fish is similar to that of the keel or of the helm to a ship. The representatives of the anterior and posterior extremities of other Vertebrata likewise take the form of fins, and are only fitted for progression in the water: these are generally four in number, namely, the two *pectoral fins*, which represent the anterior extremities; and the two *ventral fins*, corresponding with the posterior limbs of Quadrupeds. Great variety is met with both in the number and position of these locomotive members; generally all four are present; frequently one pair is deficient, and sometimes they are altogether wanting. In situation they likewise vary, more especially the ventral pair, which in some races, instead of being behind, are situated in front of the abdomen, in connection with the scapular apparatus, and even anterior to the pectoral fins.

In the construction of their cerebral system Fishes evidently stand lowest in the vertebrate scale, and every part of their economy indicates their inferiority to Reptiles, Birds, and Mammals.

The general attributes of Fishes and their relative position in the animal scale are so well laid down by their great modern historian, Cuvier, that it would be presumptuous not to give his own words.

“Breathing by the medium of water, that is to say, only profiting by the small quantity of oxygen contained in the air mixed with

the water, their blood remains cold; their vitality, the energy of their senses and movements are less than in Mammalia and Birds. Thus their brain, although similar in composition, is proportionally much smaller, and their external organs of sense not calculated to impress upon it powerful sensations.”*

“Fishes are in fact, of all the Vertebrata, those which give the least apparent evidence of sensibility. Having no elastic air at their disposal, they are dumb, or nearly so, and all the sentiments which voice awakens or entertains they are strangers to. Their eyes are as it were motionless, their face bony and fixed, their limbs incapable of flexion and moving as one piece, leaving no play to their physiognomy, no expression to their feelings. Their ear, enclosed entirely in the cranium, without external concha, or internal cochlea, composed only of some sacs and membranous canals, can hardly suffice to distinguish the most striking sounds, and, moreover, they have little use for the sense of hearing, condemned to live in the empire of silence, where every thing around is mute.”

“Even their sight in the depths which they frequent could have little exercise, if most of them had not, in the size of their eyes, a means of compensation for the feebleness of the light; but even in these the eye hardly changes its direction, still less by altering its dimensions can it accommodate itself to the distances of objects. The iris never dilates or contracts, and the pupil remains the same in all intensities of illumination. No tear ever waters the eye—no eyelid wipes or protects it—it is in the Fish but a feeble representative of this organ, so beautiful, so lively, and so animated in the higher classes of animals.”

“Being only able to support itself by pursuing a prey which itself swims more or less rapidly, having no means of seizing it but by swallowing, a delicate perception of savours would have been useless, if nature had bestowed it; but their tongue almost motionless, often entirely bony or coated with dental plates, and only furnished with slender nerves, and these few in number, shews us that this organ also is as obtuse as its little use would lead us to imagine it.”

“Their smell even cannot be exercised so continually as in animals which respire air and have their nostrils constantly traversed by odorous vapours.”

“Lastly, their touch, almost annihilated at the surface of their body by the scales which clothe them, and in their limbs by the want of flexibility in their rays, and the nature of the membranes investing them, is confined to the ends of their lips, and even these in some are osseous and insensible.”

“Thus the external senses of Fishes give them few lively and distinct impressions. Surrounding nature cannot affect them but in a confused manner; their pleasures are little varied, and they have no painful impressions from without but such as are produced by wounds.”

“Their continual need, which, except in the

* Cuvier and Valenciennes, *Histoire des Poissons*.

breeding season, alone occupies and guides them, is to assuage the internal feeling of hunger, to devour almost all that they can. To pursue a prey or to escape from a pursuer makes the occupation of their life; it is this which determines their choice of the different situations which they inhabit; it is the principal cause of the variety of their forms and of the special instincts or artifices which nature has granted to some of the species."

"Vicissitudes of temperature affect them little, not only because these are less in the element which they inhabit than in our atmosphere, but because their bodies taking the surrounding temperature the contrast of external cold and internal heat scarcely exists in their case. Thus the seasons are not so exclusively the regulators of their migration and propagation as amongst Quadrupeds or more especially Birds. Many Fishes spawn in winter; it is towards autumn that herrings come out of the north to shed upon our coast their spawn and milt. It is in the north that the most astonishing fecundity is witnessed, if not in variety of species, at least in individuals; and in no other seas do we find anything approaching to the countless myriads of herrings and cod which attract whole fleets to the northern fisheries."

"The loves of Fishes are cold as themselves; they only indicate individual need. Scarcely is it permitted to a few species that the two sexes should pair and enjoy pleasure together; in the rest the males pursue the eggs rather than seek the females; they are reduced to impregnate eggs the mother of which is unknown, and whose produce they will never see. The pleasures of maternity are equally unknown to most species; a small number only carry their eggs with them for a short time; with few exceptions Fishes have no nest to build and no young to nourish: in a word, even to the last details, their economy contrasts diametrically with that of Birds."

In no class of the animal kingdom do we find such diversity of form as in that of Fishes. Some amongst them are perfectly spherical, as the *Diodons*. Others are discoidal, or flat and circular, and this shape may be produced by two very different conditions, resulting either from an excessive narrowing or inordinate expansion of the two sides of the body. In the first case it is compressed and much elevated, as in *Vomer* and *Orthogoriscus*, while in the second case it is much depressed, flattened, and very broad, as in the *Skates*. Other species are oval, more or less elongated and slightly compressed laterally, such as *Carp*, *Trout*, &c., which is the most ordinary shape. Nevertheless when these become extended longitudinally (as in the *Pikes* for example), we are insensibly conducted by all intermediate gradations of form to the cylindrical *Eels*, or to compressed and riband-shaped Fishes, such as *Cepola*. Perhaps the most remarkably shaped Fishes are those whose bodies are bounded by nearly flat surfaces, and which circumscribe angular figures, such as triangles, squares, pentagons, hexagons, &c., (*Ostracion*, *Syngnathus*.) There are even certain genera in which the two

sides are not symmetrical, one being flattened and the other vaulted, and in these races even the bones of the cranium are so disproportioned that both eyes are turned to the same side of the animal (*Pleuronectidæ*).

The following arrangement, being a modification of the classification proposed by Cuvier, will facilitate our investigations relative to the anatomy of the numerous members of this extensive class.

PISCES.

DIVISION I.—CHONDROPTERYGII.

Skeleton cartilaginous, fins supported by cartilaginous rays.

ORDER I.—Branchiæ fixed.

1st Family.—PLAGIOSTOMATA. *Squalus*, *Zygana*, *Squatina*, *Pristis*, *Raia*.

ORDER II.—Branchiæ free.

1st Family.—STURIONIDÆ. *Accipenser*, *Spatularia*, *Chimæra*.

DIVISION II.—OSTEOPTERYGII.

Skeleton composed of true bone.

ORDER I.—ACANTHOPTERYGII.

The Fishes belonging to this division are at once recognised by the stiff spines which constitute the first fin-rays of the dorsal fin, or which support the anterior fin of the back in case there are two dorsals. In some cases the anterior dorsal fin is only represented by detached spines. The first rays of the anal fin are likewise spinous as well as the first ray of the ventral fin. This order, which comprises by far the greater number of osseous Fishes, is divisible into the following families.

1st Family.—PERCIDÆ. *Perca*, *Labrax*, *Lates*, *Centropomus*, *Grummistes*, *Aspro*, *Apongon*, *Cheilodipterus*, *Pomatomus*, *Ambassis*, *Lucio-Perca*, *Serranus*, *Plectropoma*, *Diacope*, *Mesoprion*, *Acerina*, *Rypticus*, *Polyprion*, *Centropristis*, *Gristes*, *Cirrhitæ*, *Chironemus*, *Pomotis*, *Centrarchus*, *Priacanthus*, *Dules*, *Therapon*, *Pelates*, *Helotes*, *Trichodon*, *Sillago*, *Holocentrum*, *Myripristis*, *Beryx*, *Trachichthys*, *Trachinus*, *Percis*, *Pinguipes*, *Percophis*, *Uranoscopus*, *Polynemus*, *Sphyræna*, *Paralepis*, *Mullus*.

2nd Family.—SCLEROGENIDÆ (hard cheeks). *Trigla*, *Prionotes*, *Peristedion*, *Dactylopterus*, *Cephalacanthæ*, *Cottus*, *Hemistriperus*, *Hemilepidotus*, *Platycephalus*, *Scorpana*, *Pterois*, *Blepsias*, *Apistes*, *Agriopes*, *Pelors*, *Synancia*, *Monocentris*, *Gasterosteus*, *Oreosoma*.

3d Family.—SCIENIDÆ. *Sciæna*, *Eques*, *Hæmulon*, *Pristipoma*, *Diagramma*, *Lobotes*, *Cheilodactyles*, *Scolopisides*, *Micropterus*, *Amphiprion*, *Premnas*, *Pomacentres*, *Dascyllus*, *Glyphisodon*, *Heliases*.

4th Family.—SPARIDÆ. *Sargus*, *Chrysopterus*, *Pagrus*, *Pagellus*, *Dentex*, *Cantharus*, *Boops*, *Oblada*.

5th Family.—MENIDÆ. *Mæna*, *Smaris*, *Cæcio*, *Gerrus*.

6th Family.—SQUAMMIPENNES. *Chato-*

don, *Psettus*, *Pinelepterus*, *Dipterodon*, *Brama*, *Pempheris*, *Fozoles*.

7th Family.—SCOMBERIDÆ. *Scomber*, *Xiphias*, *Centronotus*, *Rhincobdella*, *Campidon*, *Seriola*, *Nomeus*, *Temnodon*, *Caranx*, *Vomer*, *Zeus*, *Stromateus*, *Sesarinus*, *Kurtus*, *Coryphæna*.

8th Family.—TÆNIOIDES. *Lepidopus*, *Tri-chiurus*, *Gymnetrus*, *Stylephorus*, *Cepola*, *Lophotes*.

9th Family.—THEUTIDÆ. *Siganus*, *Acanthurus*, *Prionurus*, *Naseus*, *Axinurus*, *Pridon*.

10th Family.—WITH LABYRINTHIFORM PHARYNGEAL BONES. *Anabas*, *Polyacanthus*, *Macropodes*, *Helostomus*, *Asphromenus*, *Trichopodes*, *Spirobranchus*, *Ophicephalus*.

11th Family.—MUGILIDÆ. *Mugil*, *Tetra-gonurus*, *Atherina*.

12th Family.—GOBIDÆ. *Blennius*, *Anar-rhicas*, *Gobius*, *Callionymus*, *Platypterus*, *Lab-rar*.

13th Family.—WITH PECTORAL FINS FEET-LIKE. *Lophius*, *Batrachus*.

14th Family.—LABRIDÆ. *Labrus*, *Xirech-thys*, *Chromis*, *Scarus*.

15th Family.—WITH FLUTE-SHAPED MOUTHS. *Fistularia*, *Centriscus*.

All the other osseous Fishes have the rays that support the fins soft and composed of numerous pieces articulated with each other, with the exception, in some cases, of the first ray of the dorsal or of the pectoral. These are divided in accordance with the situation of the ventral fins, which are sometimes placed beneath the abdomen, sometimes appended to the framework of the shoulder, or, lastly, are altogether wanting. Three distinct orders are thus established, viz., MALACOPTERYGII ABDOMINALES, MALACOPTERYGII SUBBRACHIALES, and MALACOPTERYGII APODES.

ORDER II.—MALACOPTERYGII ABDOMINALES. Having their ventral fins suspended beneath the abdomen and behind the pectorals, without any connection with the bones of the shoulder. This order comprehends most fresh-water Fishes.

16th Family.—CYPRINIDÆ. *Cyprinus*, *Cobitis*, *Anableps*, *Pacilia*, *Lebias*, *Fundulus*, *Molinesia*, *Cyprinodon*.

17th Family.—ESOCIDÆ. *Esox*, *Eroctetus*, *Mormyrus*.

18th Family.—SILURIDÆ. *Silurus*, *Malapterurus*, *Aspredo*, *Loricaria*.

19th Family.—SALMONIDÆ. *Salmo*, *Sternoptyx*.

20th Family.—CLUPEIDÆ. *Clupea*, *Odonotognathus*, *Pristigaster*, *Notopterus*, *Engraulis*, *Megalops*, *Elops*, *Butirinus*, *Chirocentrus*, *Hydon*, *Erythrinus*, *Amia*, *Sudis*, *Osteoglossum*, *Lepisosteus*, *Polypterus*.

ORDER III.—MALACOPTERYGII SUBBRACHIALES. This order is distinguished by the ventral fins being situated beneath the pectoral, the pelvis being suspended immediately from the framework of the shoulder.

21st Family.—GADIDÆ. *Gadus*, *Lepidolep-rus*.

22nd Family.—PLEURONECTES. *Platessa*, *Hippoglossus*, *Rhombus*, *Solea*, *Monochirus*, *Achirus*.

23rd Family.—DISCOBOLI. *Lepadogaster*, *Cyclopterus*, *Echeneis*.

ORDER IV.—MALACOPTERYGII APODES. Ventral fins totally wanting.

24th Family.—ANGUILLIFORMES. *Muræna*, *Succopharynx*, *Gymnotus*, *Gymnarchus*, *Lep-tocephalus*, *Ophidium*, *Ammodytes*.

ORDER V.—LOPHOBRANCHII. In all the preceding orders the gills are pectinated, but in the Lophobranchii the respiratory organs consist of little round tufts, disposed in pairs along the branchial arches.

25th Family.—SYNGNATHIDÆ. *Syngnathus*, *Pegasus*.

ORDER VI.—PLECTOGNATHI. This order of Fishes is distinguished by having the superior maxillary bones consolidated with or firmly united to the intermaxillaries, which latter form the margin of the jaw. The opercula and branchiostegous rays are, moreover, so concealed by the thick skin that nothing is visible externally but a small branchial fissure.

26th Family.—GYMNODONTES. *Diodon*, *Tetraodon*, *Orthogoriscus*, *Triodon*.

27th Family.—SCLERODERMES. *Balistes*, *Ostracion*.

DIVISION III.—DERMAPTERYGII.

Skeleton cartilaginous or membranous; fins without either cartilaginous or bony rays, or possessing the merest rudiments of them.

ORDER I.—CYCLOSTOMATA.

28th Family.—*Petromyzon*, *Myxine*.

ORDER II.—BRANCHIOSTOMATA.

29th Family.—*Branchiostoma*.

As regards the texture of their bones, Fishes may be divided into osseous, fibro-cartilaginous, and true cartilaginous.

The cartilaginous, otherwise called Chondropterygii, and which by their entire skeleton, by their branchiæ, the external border of which is fixed to the skin, and from which the water escapes through narrow and multiplied orifices, as well as by other details in their economy, are distinguished from other Fishes, have never true bones; their skeleton consists internally of a semi-transparent cartilage, which in Rays and Sharks is coated at its surface only with a layer of opaque and calcareous grains.

The Sturgeon and Chimæra have the bones of the spine as soft as those of the Chondropterygii, but the first of these genera has in many of the bones of the head and shoulder, at least a layer at the surface, completely ossified.

Other Fishes differ widely from each other in the hardness of the parts of their skeleton, and the fibro-cartilaginous have from this circumstance been erroneously associated with the Chondropterygii. In these, however, the calcareous matter, that is to say, the phosphate of lime, is deposited by fibres and layers in the cartilage, which serves as a basis to their bones, as is the case with the most perfectly osseous

Fishes. It is only less abundant, and consequently the texture of the bone does not become so hard or homogeneous.

It is very gratuitously that the skeleton of ordinary Fishes has been supposed to be more flexible, of a softer nature, and more extensible than in the superior classes of Vertebrata. Most Fishes have their bones as hard as or harder than other animals, and there are even some, in the texture of which neither pores nor fibres are distinguishable, and which appear homogeneous or even vitreous to the eye.

No Fish, either osseous or cartilaginous, has a medullary canal in its bones; but there are some, as the Trouts, in which the bony tissue is more or less penetrated with an oily fluid.

There are some Fishes in which, whilst the rest of the skeleton acquires great hardness, some parts remain always cartilaginous, as for example, the head of the Pike.

SKELETON OF OSSEOUS FISHES.—In osseous Fishes, we shall regard the skeleton as being composed of the head, of the respiratory apparatus, of the trunk, comprising the body and tail, and of the limbs, viz, the pectoral and ventral fins. The vertical fins, viz, those of the back, anus, and tail, may be regarded as forming part of the trunk.

The head having more moveable appendages than that of Quadrupeds must be divided into a greater number of regions. We may distinguish in it the cranium, the jaws, the bones placed under the cranium behind the jaws, serving for their suspension and motions; the opercular bones, forming flappers, which open and shut the openings of the branchiæ; the bones surrounding the nostril, which are nearly external, as also are those around the eye or the temple, or which cover a part of the cheek.

The *respiratory apparatus* comprises the os hyoides and its appendages, that is to say, the branchiostegous rays and the arches supporting the branchiæ, as also the different pieces attached to these arches, and which altogether perform the functions of larynx and of trachea; lastly, the bones placed at the entrance to the pharynx, forming in some measure a second pair of jaws.

The *trunk* is composed of the vertebræ of the back and tail (for we can hardly say there is a neck, neither is there any sacrum,) of the ribs, of the bones called interspinous, which support the dorsal and anal fins; also the rays of these fins, as well as of the tail. These rays, whether they have branches or articulations, or are simply spinous, are always divisible into two lateral halves. There is rarely a sternum, properly so called, in Fishes; and when it exists, it is formed of pieces which are almost external, and which unite the lower extremities of the ribs.

The *anterior extremity* or pectoral fin comprehends the shoulder, which is an osseous semicircle composed of many bones, suspended at the upper part to the cranium or spine, and uniting inferiorly with its fellow of the opposite side. We may here find bones analogous to the two pieces of the scapula of Reptiles, to

the humerus and to the bones of the forearm; there is even generally a process composed of two pieces protruding backwards, in which we might seek to see the coracoid bones and even the clavicle.

The two bones comparable to the radius and ulna carry at their edge a row of ossicula, which appear to represent those of the carpus, and which support the rays of the pectoral fin, with the exception of the first, which articulates at once with the radial bone.

The *posterior extremity* is much more variable in position than among Mammalia; its external or moveable portion, called the *ventral fin*, emerges sometimes before, sometimes behind, and sometimes immediately beneath the anterior extremity. The pelvis is composed of four bones, the largest and most constant of which, being always in front of the anus and genital orifices, may be considered as a sort of pubis, and these carry on a part of their posterior edge the rays of the ventral fin, without intermediate bones which can correspond either to femur, tibia, fibula, or tarsus. The rays of the pectoral and ventral fins, as of those of the single ones, are divisible longitudinally into two portions.

Vertebral column.—The vertebræ of a Fish are at once recognisable by the deep conical cavities which form the articulating surfaces whereby they are connected together, so that a double hollow cone always occupies the interval between two vertebræ, which in the living state is filled up by a soft membranous and gelatinous substance, which passes from one intervertebral cavity into another through holes which generally perforate the centres of the bodies of the vertebræ.

In Fishes, as in all other animals, each vertebra presents superiorly a ring for the passage of the spinal medulla bounded by the superior spinal laminæ (*neurapophyses*), which is generally surmounted by a long spinous process, (fig. 493, 4,) at the base of which are situated both upon the anterior and posterior aspect little eminences that correspond to the articulating processes of other Vertebrata; but most generally these processes only touch or slightly overlap those of the neighbouring vertebræ without their being connected together by articulating facets. Sometimes, indeed, they exist on one side of the vertebra and not on the other, so that they have no correspondents wherewith to articulate. The annular part of the first vertebra is frequently separated from the body during the whole lifetime of the Fish, but in the other vertebræ no such separation is visible.

In some families, as in the *Murenidæ*, part of the anterior vertebræ have a little crest or vertical apophysis developed from beneath the body. Other races have a portion of the bodies of their vertebræ soldered together; of this there are examples among the *Cyprinidæ*, *Fistularidæ*, and *Siluridæ*.

Those vertebræ which are situated above the abdominal cavity have transverse processes developed to a greater or less extent. These, in some instances, as, for example, in the *Cy-*

prinidæ, remain for a long time only attached by suture to the bodies of the vertebræ, from which they are easily distinguished.

In certain Fishes, as, for example, in *Merlus*, the transverse processes are very large and give attachment to the swimming bladder. Sometimes the ribs are suspended from the transverse processes, or sometimes they are derived immediately from the bodies of the vertebræ. In this respect there are great varieties.

In those vertebræ that are situated behind the abdominal cavity there is an inferior foramen for the lodgement of the great blood-vessels of the trunk bounded by inferior spinal laminae (*hæmapophyses*), and, like the superior, generally supporting long spinous processes, (fig. 493, 5,) so that the vertebræ seem to consist of similar parts, both above and below the body.

These inferior arches of the caudal vertebræ are considered by Cuvier as being formed by the inordinate development of the transverse processes, which he describes as here becoming directed downwards and united to each other, so as to form the inferior ring; and, certainly, in the generality of Fishes, by tracing the apparently gradual conversion of the abdominal into the caudal vertebræ, such is the conclusion at which the comparative anatomist would naturally arrive. In many Fishes, however, as, for example, in the *Murænidæ*, these inferior arches with their appropriate spines are in the caudal region co-existent with distinctly developed transverse processes, evidently shewing that they must be regarded as being totally different elements of the skeleton, namely, the *hæmapophyses*. (See OSSEOUS SYSTEM.)

The inferior or hæmapophysial elements, like the superior arches, have in many instances oblique processes developed from them, which in some cases are very large and branched, so as to form a kind of interlacement around the vascular canal. This is especially observable in certain *Tunnies*.

As the vertebræ approach the tail, their processes are gradually shortened, and the vertebral canal becomes narrowed or obliterated, (fig. 493, 8,) and at length the terminal vertebræ have their apophyses consolidated with each other and with the interspinous bones, so as to form in some Fishes, as the *Perch*, a vertical triangular plate, to the posterior margin of which are articulated the rays of the caudal fin (9). In Fishes with long and pointed tails like the *Eels* this disposition is wanting; but in other races, such as the *Pike*, the real composition of this part of the skeleton is easily recognisable.

Ribs and sternum.—The ribs of Fishes have nothing to do with respiration, merely serving to support the muscular parietes of the body; they consist of the dorsal portion only, which is articulated by a single head, either to the transverse processes or to the bodies of the vertebræ themselves. Frequently they give off long bony processes, which penetrate among the muscles; and sometimes also similar processes are attached above the ribs to the bodies of the vertebræ themselves, so that the flesh of some Fishes appears full of little bones as fine

as hairs. The ribs vary extremely in different genera. Sometimes they are round and slender, sometimes compressed and falciform; occasionally they seem to surround the whole abdomen, and in many species are quite rudimentary or altogether wanting. The *sternum* is entirely deficient in most Fishes; sometimes, however, it does exist, as in *Clupea*, *Vomer*, &c.; in such cases it consists of a longitudinal series of impair bones, differently shaped in different genera, to the sides of which the ribs are attached inferiorly.

Cranium.—The cranium of osseous Fishes, when all its parts are completely developed, is made up of no fewer than twenty-six bones, six of which are azygos, viz. the *basilar*, the *principal sphenoid*, the *anterior sphenoid*, the *vomer*, the *ethmoid*, and the *interparietal* or *superior occipital*; and twenty are in pairs, namely, the *frontal*, the *anterior frontal*, the *posterior frontal*, the *parietal*, the *mastoid*, the *external occipital*, the *lateral occipital*, the *petrous*, the *great alar* and the *lesser alar* bones; but as these have all been described and figured in a preceding article, and their homologies with the cranial bones of the other vertebrate classes fully discussed, (vide OSSEOUS SYSTEM, Comp. Anat., vol. iii. p. 826,) it would be superfluous to dwell upon them more at length in this place.

Bones of the face.—The bones of the facial apparatus have likewise been pointed out and figured in the article above referred to. They consist, when the series is complete, of the following pieces, which, seeing the extremely various forms of the face in this class of animals, present innumerable varieties as regards their development and relative importance, notwithstanding that their general arrangement is tolerably persistent throughout the class.

The *maxillary* (fig. 436, 18, vol. iii. p. 826) and the *intermaxillary* (fig. 436, 17) form the anterior boundaries of the face and circumscribe the anterior and lateral limits of the mouth: the latter, however, is in Fishes the most important bone of the two, and is most commonly armed with teeth, while the former is very generally destitute of dental organs, and being imbedded in the fleshy substance of the upper lip, has been called by some authors the labial bone or os mystacis. It is indeed upon the relative shape and size of the intermaxillary bone that the form of the upper jaw of Fishes principally depends, and in some cases, as for example in the *Sword-fish* (*Xiphias*), *Lepidosteus*, &c. these bones are enormously prolonged anteriorly, so as to form an elongated beak or powerful rostrum which constitutes a formidable offensive weapon.

The face of Fishes, properly so called, is made up of several bony pieces very variable both in their size and number, which have been named the *prænasal* (fig. 436, 20,) the *suborbital* (fig. 436, g, g, g,) and the *supra-temporal* bones; all of these, however, with the exception perhaps of the prænasal, belong to the exoskeleton (vide vol. iii. p. 845.) In the hard-cheeked Fishes ("jous cuirassées" of Cuvier) these osseous plates are enormously developed, and indeed form a kind of bony mask enclosing all

the muscles and other soft parts of this region of the head.

The *Triglæ* or *Gurnards* offer the best examples of the "hard-cheeked *Acanthopterygii*," which owe their name to the following arrangement of the above mentioned osseous pieces. The first suborbitals are of enormous size, entirely covering the face, articulating in front with the bones of the snout, and posteriorly with the preoperculum and two smaller suborbitals placed

cutting edges, so that few Fishes have their heads so well defended against the attacks of their foes.

The *Pleuronectidæ*, or Flat-fishes as they are commonly called, offer a most remarkable exception to the usual arrangement of the bones of the face, which exhibits a want of symmetry unparalleled in any other vertebrate animals. In this family, which includes the *Turbot*, the *Plaice*, the *Sole*, and others similarly organized, the whole trunk of the body is so much compressed laterally that such fishes, instead of swimming in the usual position, lie upon their left sides—a circumstance which, added to the singular fact that the right side is equally coloured both upon the dorsal and ventral regions, while the opposite is entirely white, has given rise to the vulgar supposition that the white surface is the ventral and the coloured the dorsal region of the fish—an error of which the anatomist is immediately made aware by a simple inspection of the skeleton (fig. 493). But in the construction of the head, by a strange apparent distortion of the elements composing the face and cranium, both eyes are allowed to be situated upon the right or upper surface of the body. This remarkable result is entirely due to the suppression of those processes and bones on the left side of the head which normally constitute the orbital cavity, whilst on the right side they are permitted to attain a very complete development. The principal frontal bone (figs. 436, 437, 1, vol. iii. p. 826-7), which in all Fishes is azygos, occupies its usual situation, but whilst on the left side it is flat and bounded by a nearly straight margin, on the right side of the mesial line it presents as usual the processes which form the roof and posterior boundary of the orbit. The outer margin of the orbital cavity is formed by one large bony piece, the representative of the sub-orbital chain of bones, (fig. 436, g g g)

Fig. 492.

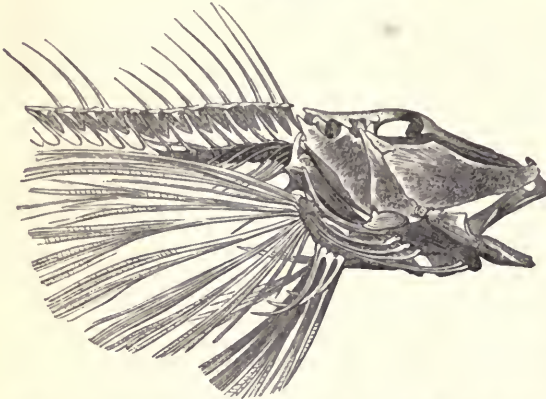

Skeleton of *Trigla lyra*, showing the bones of the face and the pectoral fin rays.

at the posterior angle of the orbit. Its articulation with the preoperculum is accomplished by means of an immoveable suture, so that the suborbital bones and the preoperculum must move together. The upper part of the face, moreover, is formed by the immoveable consolidation of the anterior frontals with the anterior extremity of the prænasal bones, which expand into a disc, and in some instances of the vomer likewise, which is slightly visible beneath the skin between the ossa nasi. All these bony pieces, as well as those composing the upper portion of the cranium, are hard, granular, and often armed with spines and

cutting edges, so that few Fishes have their heads so well defended against the attacks of their foes.

Fig. 493.

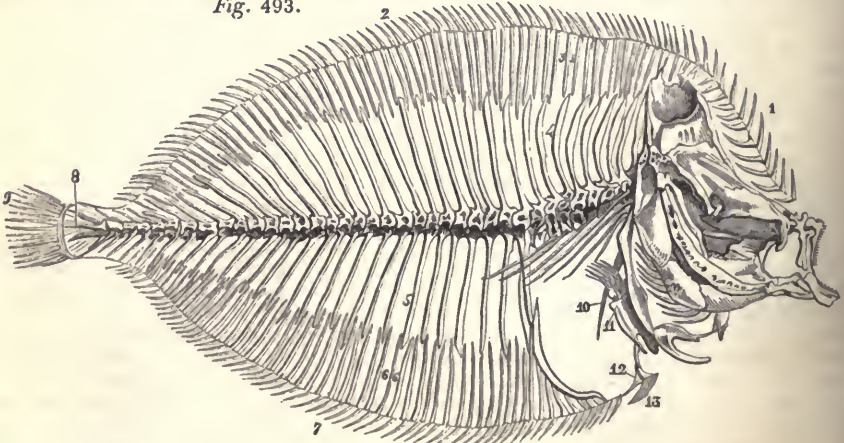

Skeleton of the *Sole*.

which does not exist at all upon the opposite side of the head, while anteriorly the anterior frontals (2) and the nasal bone (20) complete this part of the face. An orbital cavity is thus constructed upon the right or upper side of the head of the Pleuronectidæ, which suffices for the lodgment of the two eyes, which thus take the only position in which both could be made useful.*

Another equally remarkable arrangement is observable in the construction of the jaws of the Pleuronectidæ, which are in many genera very unequally developed on the two sides of the median line, only in this case the preponderance of development is just the reverse of what exists in the orbital portion of the face, for here the bones of the right or upper side are small, while those of the left or inferior half are of considerably greater size and strength. Moreover, the former are but sparingly furnished with teeth, while the latter support the chief part of the dental apparatus; so that by this structure the mouth becomes twisted toward the ground, and the teeth so disposed as to work most effectually in that direction.

In the Syngnathidæ, Ostracions, and other Fishes, where the exoskeleton is inordinately developed, so as to form a suit of bony armour in which the exterior of the body is completely covered, the endoskeleton is proportionately weak and imperfectly formed, many of the

to be composed of a kind of snout (*a*), derived from the external armour of the head, in which the orbits (*b*) are excavated, the intermaxillary bones (*d*) and the lower jaw (*e*) alone being recognisable. The gill covers (*h*) belong to the exoskeleton, while the hyoid apparatus (*f*) and branchial arches (*g*) are but very imperfectly formed. The osseous zone that sustains the pectoral fins consists of a single bone, which is so consolidated with the tegumentary skeleton as completely to separate the abdominal cavity from the branchial chambers; and in the piece *m*, which forms the basis of the fin itself, the usual divisions are quite undiscernible. The vertebrae, both of the back and tail, (*o*, *g*) are reduced to mere bony rings, while the pelvic circle, (*p*) that supports the abdominal fins, (*l*) is, like the rest of the skeleton, firmly connected with the external bony armour.

In the construction of the *anterior extremities* a few peculiarities may be specified.

Certain genera, more especially the *Salmonidæ* and the *Cyprinidæ*, have attached to the radius and ulna upon their inner side a third bone, which by its anterior extremity is connected to the anterior margin of the *os humeri*, thus forming a kind of buttress to support the fin. In the *Siluridæ* there likewise exist three bones in the fore-arm which at an early period become consolidated to each other, probably on account of the great strength requisite in that race of Fishes to support the great spinous ray of the pectoral fin. In the *Muraenidæ*, where there are but two bones, these are suspended to the arch of the shoulder at the point of junction between the scapula and the humeral bone. In species that have no pectoral fins the radius and ulna do not exist.

There still remains to be noticed a long styliform bone generally composed of two pieces (*fig. 437, 49, 50, p. 827, and fig. 493, 10*), of which the upper piece (49), more or less flattened in shape, is suspended from the *os humeri* (48), to the posterior and superior part of the inner surface of which it is adherent. This styliform bone runs backwards along the side of the body behind the pectoral fin, and is plunged to a greater or less extent amongst the flesh.* Some anatomists have regarded this process as the homologue of the clavicle, but from the position which it occupies, running backwards, it seems rather to represent the *coracoid bone*, which is in this case lost among the muscles on account of the want of a sternum to which it might be articulated.

It sometimes happens that this bone unites with that of the opposite side, and occasionally is of such length and strength as to reach backwards as far as the commencement of the anal fin. A not less curious disposition of this bone is observed in *Batrachus*, where the superior division extends upwards beyond the humerus to be connected with the spinous process of the first vertebra.

Fig. 494.



bones remaining in a rudimentary condition. This is well seen in the osteology of the Flying Hippocamp, (*Pegasus draco*, *fig. 494*), where the bones both of the head and trunk seem to perform quite a secondary part as contrasted with the dense tegumentary framework covering the body. The whole face seems

* The above description of the structure of the face in the Pleuronectidæ is derived from a disarticulated skull of the Halibut, contained in the Museum of the Royal College of Surgeons in London.

In the *Cyprinidæ* this bone is of very rudimentary size, and is totally wanting in the *Muraenidæ*, the *Anarrhicus*, and the *Siluridæ*.

The carpal bones, which support all the rays of the pectoral fin except the first, are generally placed, as above described, in a single row consisting of four or five pieces, but occasionally each of these bones presents a constriction near its middle, so as to have the appearance of being divided into two.

It is the bones of the carpus, and not those of the arm or fore-arm, which are elongated to give the pediculated structure to the feet of the frog-fishes, making them look like arms. In *Lophius* these are only two in number; in *Polypterus* there are three, and in *Batrachus* five. In these Fishes the radius and ulna are reduced to a very small size.

Posterior extremity.—The os innominatum, the femur, the bones of the leg and of the tarsus, are all represented in the osseous Fishes by a single bone (fig. 493, 12) of a triangular shape, and presenting several processes and prominent lamellæ. The apex of this triangle is directed forwards, and in the subrachial Fishes is attached in the angle formed by the junction of the two ossa humeri (11), at the point where the latter bones are united to each other by symphysis beneath the throat. In the true abdominal Fishes the pelvic apparatus is unattached to any part of the skeleton, being simply imbedded in the muscles beneath the belly.

The posterior extremity of the piece last mentioned gives attachment to the rays of the ventral fin (13), at the inner margin of which it not unfrequently gives off a long process extending backwards. The two pelvic pieces of the opposite sides are most frequently united to each other by a suture; but it sometimes happens that they remain partially separated either towards their anterior part, as in *Lophius*, or posteriorly, as in *Batrachus*.

Many Fishes, as *Muræna*, *Gymnotus*, *Xiphias*, &c. have no ventral fins, and in such cases the pelvic apparatus is altogether wanting.

Fin rays of the extremities.—These rays, with the exception of the most external one belonging to the ventral fin, are all soft and composed of numerous articulations, but towards their base they are more compact than elsewhere, the articulations being there scarcely visible. The base of each ray is enlarged so as to permit of its being firmly attached to the radial bone and to those of the carpus and pelvis.

The first ray of the pectoral fin is rarely branched, and its articulations are sometimes so completely consolidated as to simulate a spinous ray. This is the case, for instance, in *Silurus* among many other Fishes; but in such cases they are not really spinous rays in spite of their near resemblance, but derivations from the dermal skeleton, so that such Fishes are in all respects strictly malacopterygious.

Vertical fins.—The vertical fins of the osseous Fishes, namely, the dorsal, the caudal, and the anal fins, cannot be compared to any portions of the skeletons met with in other Vertebrata. They belong, in fact, to the exoskeleton (see

OSSEOUS SYSTEM), but are so intimately related to the real bones both in structure and office, that they must be described in this place as being essentially connected with the bony framework of the body.

Every one of the vertical rays entering into the composition of these fins consists of two portions, an *interspinous bone*, which is imbedded in the flesh of the fish between the great lateral muscles, and serves as a basis to which the ray is attached, and the ray itself, which is visible externally and generally assists in supporting the membrane of the fin.

Interspinous bones.—The interspinous bones form a series reaching along the back to an extent proportioned to the length of the dorsal fin, and in a similar manner are appended beneath the post-abdominal region of the ventral surface coextensively with the anal fin, which they resemble. Each interspinous bone (fig. 493, 3, 3, 6, 6) resembles in its shape the blade of a dagger plunged into the flesh, while its head corresponding with the handle of the dagger remains on a level with the skin to give attachment to the base of the ray. This portion of the interspinous bone has an apophysis conjoined with it by suture, which in many instances is prolonged into a point that is connected to the articulation of the next ray of the fin. The interspinous bones are generally so disposed that their points penetrate between the spinous processes of the vertebræ, each being attached to these processes by a ligamentous membrane; but there are some Fishes, as the *Pleuronectidæ* (fig. 493), and (as regards the composition of the anal fin) the *Siluri*, in which there are two interspinous bones to each spinous process, and in other cases the relations between the two become quite lost, as, for example, where three or even four spinous processes are interposed between some of the vertebral spines, a fact which in itself is sufficient to disprove the hypothesis of Geoffroy, extensively promulgated in this country by the writings of Professor Grant, namely, that the interspinous bones of Fishes are dismemberments of the spinous processes, one-half of the latter becoming displaced and forming the interspinous bone as well as the ray which it supports.

On this point Cuvier remarks that in many genera, such as *Muræna*, *Ophicephalus*, and *Gymnotus*, the inferior interspinous bones are separated from the vertebræ by the cavity of the abdomen, which is prolonged to a considerable distance beyond the commencement of the anal fin; whilst in other cases, as in the *Pleuronectidæ*, there are interspinous bones even upon the cranium (fig. 493, 1). These circumstances, joined to the fact that in those portions of the back or of the tail which have no fins attached to them there are generally no interspinous processes although there are vertebral spines, make it impossible to regard the bones in question as being derivations from the vertebral column.

Rays of the vertical fins.—Each fin-ray (fig. 493, 2, 7) is connected with its corresponding interspinous bone by a ginglymoid articulation. The rays are of two kinds: *spinous rays*, such as

Fig. 495.

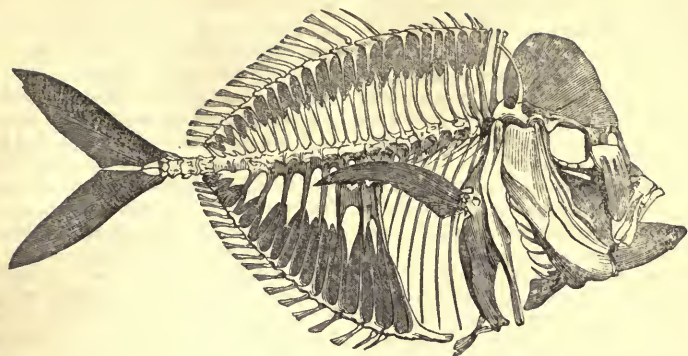

*Skeleton of *Lampris guttata*, showing the interspinous bones, easily recognisable from their dark tint.

are met with in acanthopterygious Fishes, and branched or soft rays, such as are found in the Malacopterygii. They are all divided by a longitudinal raphé, or suture, into two lateral halves, so that each appears to be formed of two rays conjoined,—a circumstance which forms an additional argument against these parts of the skeleton being dismemberments of the vertebræ.

The rays of the caudal fin are always soft and articulated; but in many Fishes some of those at its root, both above and below, are gradually diminished in size until nothing is left of them but the hard part forming the base.

Skeletons of Chondropterygii.—In the true cartilaginous Fishes, such as the *Sharks* and *Rays*, the bones are always destitute of those osseous fibres which give hardness to the skeleton in the preceding races possessing a true bony skeleton. Their interior remains permanently soft and cartilaginous, while their external surface is strengthened by becoming encrusted with a layer of granular-looking calcareous matter.

As there is in the Chondropterygii no disposition of bony particles radiating from ossific centres, there can be no division of the cranium into distinct bones, nor of course any sutures: the whole cranium consists of a single cartilaginous piece, in which, however, it is easy to dis-

tinguish the same regions, the same fossæ, the same eminences, and the same holes as in the skull of one of the osseous Fishes; but, although it is not difficult with a little attention to point out the situation of the different bones, to define their limits is impossible.

The bones of the face are likewise consolidated with the great cranial mass, and consequently are quite undistinguishable except from their position in relation to organs into the composition of which they enter.

The structure of the skull therefore appears exceedingly simple when compared with that of an osseous fish. The whole pterygo-temporal apparatus is represented by two pieces, one of which corresponding with the temporal, tympanic, symplectic, and jugal bones of Cuvier, or the tympanic pedicle, as Professor Owen calls the long stem, which in the osseous Fishes is composed of those elements, is here represented by a single piece (*fig. 496, c*) interposed between the side of the cranium and the point of junction between the upper and lower jaws—an arrangement precisely similar to that which is observable in the Batrachian Reptiles.

The other piece belonging to the pterygo-temporal apparatus (*fig. 496, e*) forms, in conjunction with its fellow of the opposite side, almost the whole of the upper jaw, covering

Fig. 496.

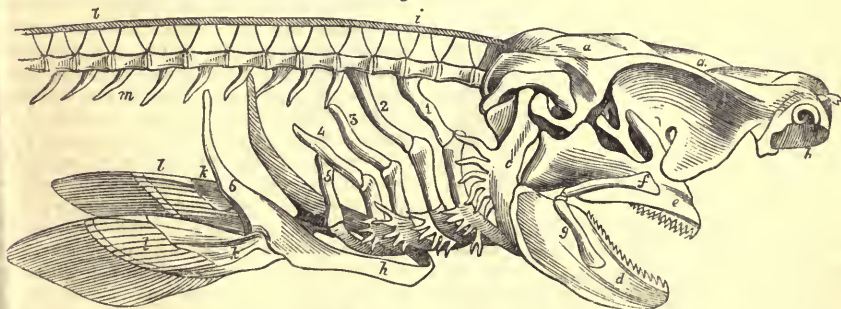

Anterior portion of the skeleton of a female Shark (*Acanthias niger*).

a, a, cartilaginous skull; *b*, nasal cavity; *d*, lower jaw; *e*, upper jaw; *f, g*, connecting pedicle; *1, 2, 3, 4, 5*, branchial apparatus; *6, h*, zone supporting (*h, l*) pectoral fins.

the greater part of the roof of the mouth, and likewise supporting all the formidable teeth with which this jaw is armed. Posteriorly it gives attachment to the inferior maxilla by two large articulating surfaces, and above it is only connected to the skull by the muscles implanted into it. From its upper margin it gives off a process, shown in the figure, which remains permanently cartilaginous, and in the living state is imbedded among the muscles that form the inner wall of the orbit; the whole is thus left completely moveable so as to give great latitude to the motions of the jaws.

The superior maxillary bone (fig. 497, *d*) and the intermaxillary bone (*c*) are of very small size, being merely imbedded in the substance of the upper lip and connected superiorly by ligament to the face and the piece last described. Inferiorly these bones are attached to a third (fig. 497, *e*), which is fixed by ligaments to the outer

surface of the lower jaw at about one-fourth part of its length from the symphysis, so that the three together form an osseous and ligamentous band that circumscribes the angle of the mouth and materially diminishes the *riectus* of the jaws. The inferior piece (*e*) is most probably one of the elements belonging to the lower jaw detached from its usual connections with that bone.

The inferior maxilla (fig. 497, *f*) consists of two lateral halves united by a symphysis; each half consists of a single piece of considerable breadth, presenting a deep sulcus superiorly for the lodgement of the teeth.

The branchial apparatus is placed further back than in the osseous Fishes, being situated beneath the commencement of the spine—a circumstance which causes the bones of the shoulder to recede backwards also.

The whole of the opercular apparatus is wanting in the cartilaginous Fishes with the exception of the Sturgeons (*Sturionidæ*), which seem in many respects to occupy an intermediate place between them and the osseous division.

The *os hyoides* in *Squatina* and the Sharks generally is composed of three pieces, one situated in the mesial line, and two lateral branches. The mesial piece or body of the *os hyoides* corresponds to the bones of osseous Fishes; while the large rami, instead of mounting up to be connected with the styloid bones, terminate immediately behind the articulation of the lower jaw, with which they are intimately connected by means of strong ligaments. From its posterior margin branchiostegous rays are given off precisely as in the former group, but these have nothing to do with the formation of an opercular flap, the branchial apertures being here of a very different character.

The branchial arches in their general arrangement resemble those of the osseous Fishes, but there are nevertheless important differences to be remarked. In *Squatina* there exists inferiorly a kind of sternal apparatus which occupies the mesial line. This consists posteriorly of a central piece (497, *e, e, e*), that very nearly resembles a broad spear-head, forming a kind of sternum; the handle of the spear closely representing the xiphoid cartilage of the human sternum; and in front of this are three pieces on each side, something like the costal cartilages. Of these the anterior pair are united to each other in the mesial line, while the second and third are fixed to the sides of the central piece first mentioned. The arches supporting the branchiæ are five in number on each side, (fig. 497, *f, f*) each consisting of an inferior and superior portion connected with each other by moveable articulations. The inferior portion consists of a single piece, the superior of two, united together by ligaments. The anterior arch is connected by ligaments to the body of the *os hyoides*, and also to the central pieces. The four posterior are attached by ligament to the succeeding lateral processes of the sternal apparatus, and thus a framework is formed that almost entirely surrounds the neck. The superior extremities of these arches are fixed beneath the anterior

Fig. 497.



Inferior view of the skull, branchial arches, and pectoral apparatus, of *Squalus centrina*. (After Carus.)

a, nasal cavity; *b*, olfactory organ; *c*, superior labial or intermaxillary cartilage; *d*, intermaxillary bones; *e*, inferior portion extending between the preceding and the lower jaw; *e, e, e*, central sternum-like pieces; *f, f, f, f, f*, branchial arches; *i, i, i, i, i*, branchial appendages; *k*, scapular zone; *l, m, n*, pectoral fins.

vertebræ of the spine by a loose ligamentocellular substance.

In other Sharks and in the Rays (*fig. 496, 1, 2, 3, 4, and fig. 500, 3, 4, 5*) the ossification of these pieces is very imperfect; the branchiæ, in the latter more especially, being almost entirely sustained by membranous structures.

Fig. 498.

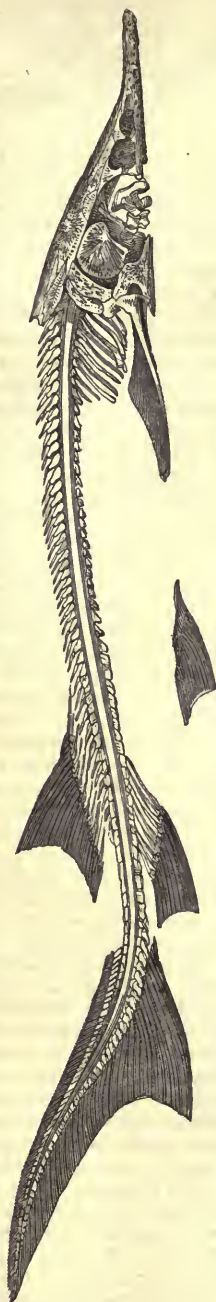

Skeleton of Sturgeon (Accipenser Sturio).

The *pharyngeal bones* in the true Chondropterygii are totally wanting.

In some Sharks, as, for example, in *Galeus*, there are vestiges of a true *sternum* situated below the branchial apparatus, from the anterior edge of which it is suspended by ligamentous attachments, while posteriorly it is connected with the centre of the zone, to which the pectoral fins are attached. To the sides of this sternum are appended five or six pairs of sternal ribs, but the ossification of these bones, as well as of the sternum itself, is very incomplete.

The *vertebral column* of the cartilaginous Fishes presents two or three very remarkable peculiarities. In the Ray-tribe (*fig. 500, 6*) all the vertebræ of the anterior portion of the spine for a considerable distance are immovably fixed together by an incrustation of earthy matter that forms a kind of tube or sheath in which they are encased, the number of vertebræ thus anchored to each other being only indicated by the foramina through which the spinal nerves make their escape.

Another peculiarity is that both in the Sharks and Rays there are twice as many superior vertebral laminæ as there

are vertebræ. This is owing to the development of spinal laminæ to cover the intervertebral spaces, in addition to those which constitute the spinal canal in other vertebrata.

To the transverse processes of the vertebræ covering the abdomen rudiments of *dorsal ribs* are appended. In the Raïdæ, however, these are very small; but in Sharks, (*fig. 496, m.*) and more especially in the Sturgeons (*fig. 499, b, c.*) they attain considerable dimensions.

Along the whole length of the post-abdominal region of the vertebral column there are developed hæmapophysial arches and inferior spinous processes, but the latter are always exceedingly short and imperfectly formed. This is well seen in the Sturgeon (*fig. 498*), in which fish, although the central portion of the vertebral column remains permanently cartilaginous, the hæmapophysial arches and spines are distinctly bony.

There are no interspinous bones, the dorsal and anal fins being only connected to the spinous processes of the vertebræ by broad ligamentous expansions. The structure of the caudal fin is likewise very different from what is met with in the osseous Fishes. In the Sharks and Sturgeons, (*fig. 498*), which have the tail deeply furcate, the vertebral column is continued into the upper portion along its entire length, the caudal fin being entirely supported by long rays connected both superiorly and inferiorly to the extremities of the spinous processes of the individual vertebræ.

The framework to which the anterior extremities or pectoral fins are attached is a strong osseous zone which encircles the body immediately behind the branchial apparatus. This zone consists superiorly of the *scapular* and *supra-scapular* pieces, and inferiorly of a broad osseous belt (*fig. 497, k.*) which encloses the fore part of the abdominal cavity, representing the *coracoid* and *clavicular apparatus* of the Reptilia. In the Raïdæ the supra-scapular pieces are inseparably connected with the spinous processes of the dorsal vertebræ, but in the different races of Sharks they are loose and unattached. At the junction between the dorsal and abdominal portions of the above zone are attached by strong articulations the pieces which support the rays of the pectoral fin. These pieces represent the whole brachial and carpal apparatus of the higher Vertebrata. In the Rays these are of enormous dimensions, (*fig. 500, 8, 9, 10, 11*) extending posteriorly so as almost entirely to surround the cavity of the abdomen, whilst anteriorly they are prolonged in a similar manner in front of the cranium. To the external aspect of this vast carpus are attached upwards of a hundred fingers supporting the enormous pectoral fins, which here form by far the greater portion of the body, giving it that square shape for which these Fishes are so remarkable. Towards the circumference of the body each of the fin-rays bifurcates (12), so that the total number of phalanges entering into the composition of this prodigious hand is one of the most remarkable facts in comparative osteology.

Fig. 499.

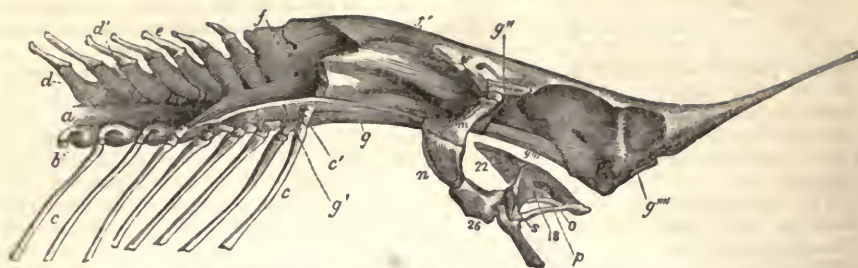

Cartilaginous skull and anterior portion of vertebral column of the Sturgeon (*Accipenser sturio*).

a, cartilaginous axis of spine; b, c, transverse apophyses and ribs; f, f', g, g', g'', g''', g''', cartilaginous cranium; i, k, ocular and nasal cranial cavities; m, n, pedicle by which the mouth is connected with the cranium; 26, bone supporting the lower jaw; 18, 22, palatine cartilages; o, p, s, cartilages representing the superior maxilla.

Fig. 500.

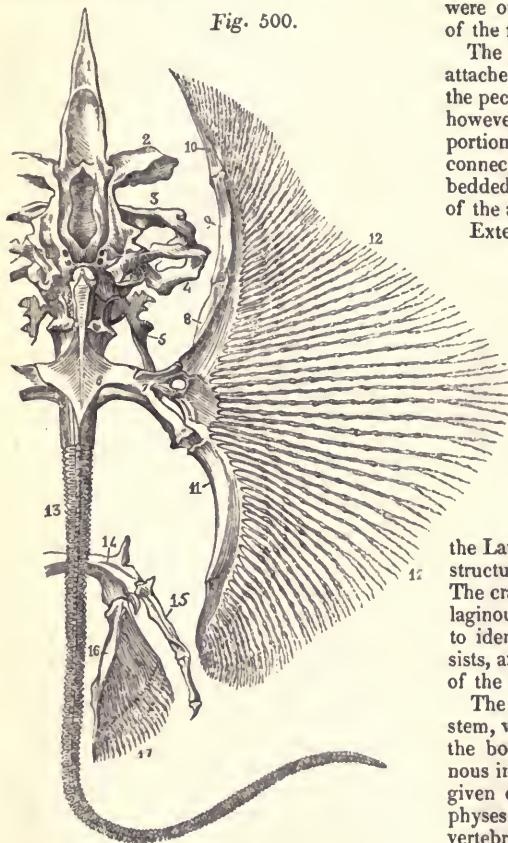

Skeleton of Ray.

1, snout; 2, 3, 4, 5, branchial arches; 6, consolidated anterior vertebrae; 7, humeral apparatus; 8, 9, 10, 11, carpus; 12, fin rays; 13, posterior detached vertebrae; 14, pelvic apparatus; 15, clasper; 16, tarsus; 17, fin rays of posterior extremities.

The pectoral fins of the Sharks (fig. 496, 497) and Sturgeons (fig. 498) are formed after the same plan as that of the Skate, only upon a considerably smaller scale, representing as it

were only a moiety of the posterior division of the fin of the preceding genus.

The posterior extremities or ventral fins are attached to a zone similar to that which supports the pectorals (fig. 500, 14). The pelvic zone is, however, very incomplete, the superior or iliac portion being quite deficient, so that it has no connection with the spine, but is simply imbedded among the muscles at the posterior part of the abdomen.

Externally the pelvis supports the first ray of the ventral fin (fig. 500, 15), which is very large, and likewise a long stem (16) composed of numerous articulations, to the commencement of which the succeeding fin rays are appended. Inferiorly the former is prolonged in the male Rays into a very curious spoke-shaped apparatus called the "clasper," of the nature of which we shall have occasion to speak further on.

Skeleton of Dermapterygii.—In the cyclostomatous Fishes, such as the Lamprey, the skeleton is of still more simple structure than in the plagiostomatous genera. The cranium exhibits through life a soft cartilaginous texture; nevertheless it is not difficult to identify the different pieces of which it consists, and to point out their analogies with those of the osseous Fishes.

The spine consists of a soft cartilaginous stem, which passes along the entire length of the body. It is enclosed in a strong membranous investment, from which prolongations are given off that perform the office of spinal apophyses; but the only indications of distinct vertebrae exist in the presence of slight and almost imperceptible rings of osseous substance distinguishable upon the surface of the cartilaginous stem above mentioned.

The Cyclostomata have neither pectoral nor ventral fins, so that in this respect they are the most imperfect of all Fishes: even the vertical fins situated above and beneath the tail are only supported by a few soft and scarcely sensible fibres representing the fin-rays.

The most remarkable part of the skeleton of the Lampreys (*Petromyzon*) is the cartilagi-

Fig. 501.

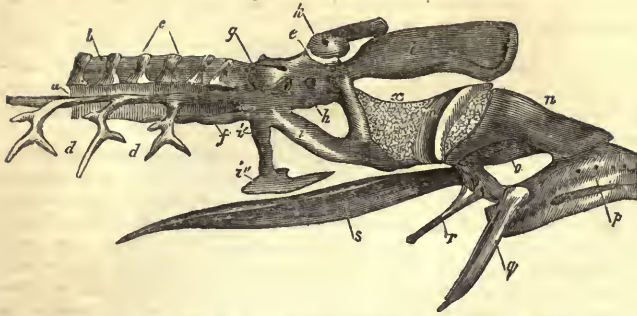
Skull of Sea Lamprey (*Petromyzon marinus*). After J. Muller.

a, cartilaginous spinal axis; *b, c*, rudimentary cartilaginous neural arches; *d, d*, part of cartilaginous respiratory framework; *g*, auditory capsule; *h*, cranium; *i, i'', i''''*, processes therefrom giving attachment to the muscles of the tongue; *k*, nasal capsule; *l*, cartilage covering hinder part of mouth; *n, o, p, q*, anterior cartilages entering into composition of mouth; *r, s, os*, hyoides.

nous framework situated on the sides of the neck, enclosing the branchial apparatus, and allowing respiration to be accomplished by a peculiar mechanism which will be described in its proper place. This singular structure consists of seven pairs of cartilaginous arches derived from a kind of sternum situated in the mesial line beneath the throat. These arches, which have nothing in common with the branchial arches of Fishes, mount upwards interruptedly towards the spine, giving off anterior and posterior processes to form a kind of frame to the branchial orifices. Anteriorly this remarkable apparatus is attached to the cranium, while posteriorly it terminates in a thin cartilaginous capsule, which encloses the heart; it will, however, be better to describe it further on.

In *Ammocetes* the skeleton is even more imperfect than in the Lamprey, all its parts remaining permanently in a membranous condition, so that they would seem to resemble worms more than vertebrated animals, and in fact were absolutely classed as worms even by the great Linnæus.

Skeleton of Branchiostoma.—In this remarkable Fish the entire spine is made up of a succession of very delicate membranous rings without any apophyses whatever; neither in young specimens is the slightest trace of a cranial dilatation of the vertebral column apparent, probably owing to its being at this period quite gelatinous in its texture, and consequently translucent; and even in adults such is its softness that it is impossible to distinguish it satisfactorily; but along the back from sixty to seventy vertebræ are easily counted, the divisions between them being indicated by slight bulgings and lines passing obliquely from above downwards on the sides of the column. In this way a separation between the rachidian rings is rather indicated than proved to exist; for, although there is, so to express it, a tendency to divide at the points indicated, the division is rather artificial than natural.

According to Mr. Goodsir, the chorda dorsalis is formed externally of a fibrous sheath,

and internally of an immense number of laminae, each of the size and shape of a section of the column at the place where it is situated. When any portion of the column is removed, these plates may be pushed out of their sheath like a pile of coins. They have no great adhesion to one another, are of the consistence of parchment, and appear like flattened bladders, as if formed of two fibrous membranes pressed together.

Two ligaments may be detected, one running along the upper, the other along the lower aspect of the spinal column; and from its sides aponeurotic laminae pass off to form septa of attachment between the layers of muscles. Along the mesial plane above the column a similar aponeurosis separates the superior lateral muscular masses, and by splitting inferiorly, so as to join the sides of the rachidian chord, forms the canal for the spinal medulla. Foramina exist all along this canal for the passage of the nerves. A similar aponeurotic septum is situated along the inferior part of the column from the anal opening to the extremity of the tail. Imbedded in these two aponeuroses are cartilaginous rudiments representing the superior and inferior vertebral spines, but these are of extreme softness and delicacy; and the traces which exist of the transverse processes and ribs are in the same soft condition, so that they are with difficulty distinguishable. In Branchiostoma, therefore, the locomotive skeleton may be said to consist of the vertebral column only, without either cranium or appended limbs.

There is, however, an exceedingly elaborate framework of soft cartilaginous arches which surrounds the branchial chamber, and forms a kind of branchial thorax, the nature of which will be examined further on.

Arthrodial system.—The articulations of the bones of Fishes present the same varieties as those of other animals; only the arthrodial and ginglymoid are more rarely met with because their limbs have not to execute such complicated movements.

It is by means of a ginglymus that the lower jaw and operculum are attached to the pterygo-palatine apparatus, and the latter to the cranium. The same articulation occurs between the rays of the dorsal and anal fins with the interspinous bones, and between the first ray of the pectoral fin with the bone analogous to the radius.

There are, moreover, in Fishes two kinds of articulations having determinate movements which are not met with in the other classes: one is formed by two rings joined one to the

other, as those of a chain, and another, which at the will of the fish becomes very moveable or very fixed. We find examples of both these in the family Silurus.

The articulations with determinate movements offer ligaments, cartilaginous surfaces, and a synovial fluid, as in higher animals.

The articulations between the bodies of the vertebræ are effected by means of a fibro-cartilaginous substance which traverses the bodies, and which sometimes, as in the Sturgeon and the Lamprey, takes the form of a long cord.

The articulations of the opercular bones between themselves, the pieces composing the branchial apparatus, the bones of the shoulder, of the arm, of the carpus and pelvis, and of the last to the shoulder, are effected by means of interposed fibro-cartilaginous substance.

Muscular system.—The general character of the myology of Fishes has been treated of in a

preceding article, (*MUSCULAR SYSTEM, Comp. Anat.*) It will therefore only remain for us in this place to give such an account of their arrangement as the limits of this article permit, dividing them into groups so as to facilitate reference to the accompanying figures, representing the dissected muscles of the Perch, as described by Cuvier.

The *great lateral muscles* on each side of the trunk of the body form a mass that extends from the back of the head and posterior surface of the pectoral zone all the way to the sides of the base of the caudal fin. These two great muscles are divided transversely by aponeurotic laminae into as many layers of fibres as there are vertebræ, giving the flaked appearance to the flesh of Fishes, (*fig. 502, f, g, h*), and are connected to all the vertebræ and vertical processes of the spine as well as to the inter-spinous bones.

Superior and inferior slender muscles of the

Fig. 502.

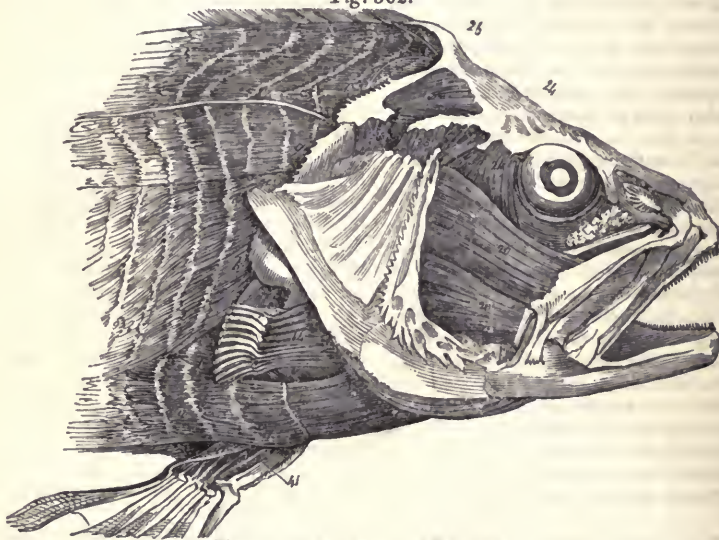

Myology of the Perch. After Cuvier.

trunk.—These are situated in the interspace between the lateral muscles, both along the middle of the back and also of the ventral aspect of the body.

Proper muscles of the fins.—In the caudal fin these are of three kinds, some being superficial, others deep-seated, and a third passing from one ray to another.

In the dorsal and anal fins the arrangement of the proper muscles is very simple, because they are all disposed uniformly, each fin-ray having six, viz. four deep-seated and two superficial.

The superficial muscles are inserted into the fin-ray at its base, one on the right and the other on the left side, and serve to move it in corresponding directions. The deep-seated set (*figs 505, 3 and 4*) arise from the interspinous bones, and are inserted into the anterior and posterior aspects of the base of the ray, serving to elevate or depress it vertically.

The movements of the shoulder are effected by the great lateral muscles inserted into them, or by strips derived therefrom.

The muscles of the pectoral fins (*figs. 502, 503, 505, 14, 15, and 16*) are inserted into the fin-rays, which they serve to elevate or depress at pleasure.

The muscles of the ventral fins, (*fig. 503, 17 and 18*) arise from the pelvic bone, and serve to expand or advance the fin-rays of the abdominal members.

The muscles of the jaws are represented by a large mass, (*fig. 502, 20, 20*), derived from the palato-temporal arch and the anterior edge of the preoperculum, which is inserted into the lower jaw, and serves to close the mouth; an arrangement very different from that of the temporal and masseter muscles of the higher vertebrata.

Muscles of the palato-tympanic arch consist of a depressor, (*fig. 504, 22*), derived from the

Fig. 503.

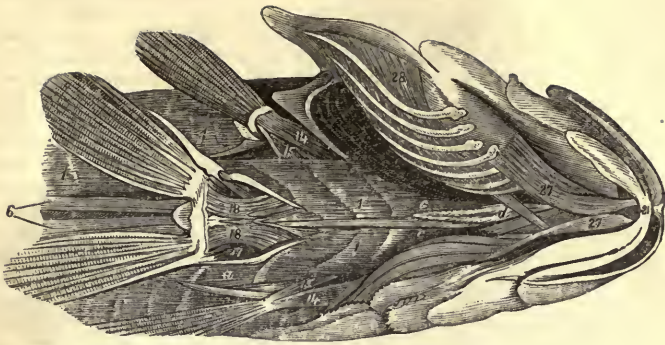

Myology of the Perch. After Cuvier.

sphenoidal and alar bones; and an elevator, (fig. 502, 24,) which comes from beneath the orbit, and antagonizes the preceding by dilating the cavity in which the branchiæ are lodged; these two are the principal muscles employed in respiration.

Muscles of the operculum.—The movements of the operculum are very similar to those of the palato-tympanic arch, and its muscles likewise consist simply of an elevator and a depressor (figs. 504 & 505, 25, 26.)

Muscles of the os hyoides.—The principal of these (figs. 503 & 505, 27) seems to correspond to the *genio-hyoides*, and has a similar office; its antagonist is a prolongation of the great lateral muscle of the body (fig. 503, 1, 1.)

Muscles of the branchiostegous membrane.—These consist of a layer of fibres (figs. 503, 504, 28) running transversely across the inner surface of the branchiostegous rays; this is in some Fishes assisted by accessory muscular fibres derived from the os hyoides.

Muscles of the branchial and pharyngeal apparatus.—These must be divided into several groups, some of which connect this apparatus with the skull, others to the spine, others to the humeral bone, and others to the os hyoides; while some connect one part of the apparatus to another. Their general distribution is shewn in fig. 505, 32, 35, 37, &c., but to describe them more minutely would carry us beyond our limits.

In the *Ostracions*, or box-fishes, which have their entire body, with the exception of their jaws and fins, enclosed in a dense case of armour, the arrangement of the lateral muscles of the trunk is considerably modified; they occupy, indeed, the same situation, but are only attached at the head and tail. In this case

Fig. 504.

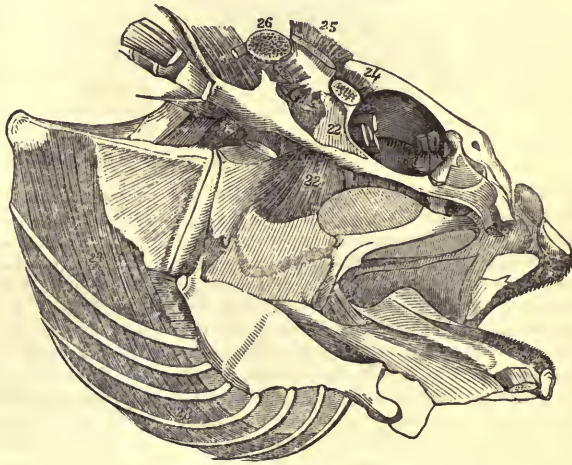

Myology of the Perch. After Cuvier.

insertions into the vertebral column would have been useless, seeing that the tail is the only moveable part. The texture of these lateral muscles is also much simpler, their fibres being almost all longitudinal. The ribs are entirely wanting, these parts being replaced by a silvery aponeurosis, which forms the walls of the abdomen and lines the interior of the shell.

In the Plagiostome cartilaginous genera there are considerable differences in the arrangement of the muscular system which will demand a brief notice. The *Raïde*, or *Skates*, for example, so remarkable for the construction of their skeleton, are not less so in respect to the disposition of the muscles that move its different parts. In these fishes the muscles of the trunk resemble very strikingly those which are met with in the tails of quadrupeds. They are four in number, arranged upon two planes, so that there are two superior lateral and two inferior lateral muscles.

The superior laterals arise from the middle portion of the vertebral column above the abdo-

Fig. 505.

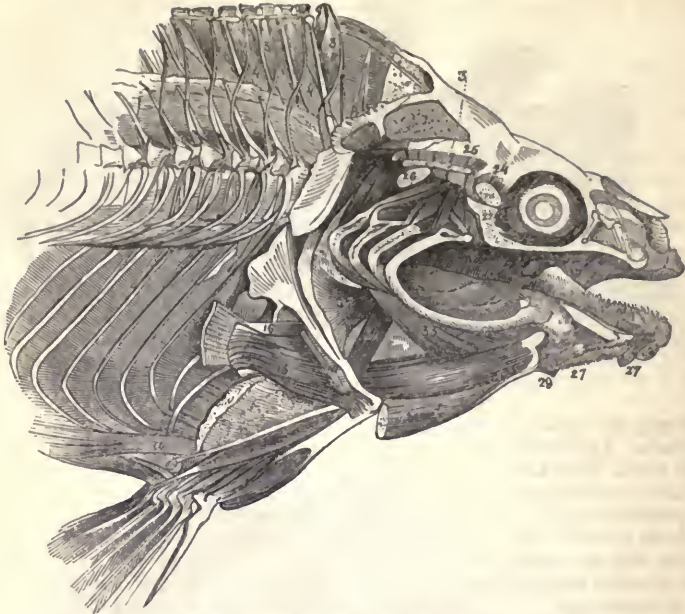
*Myology of the Perch. After Cuvier.*

men by strong fleshy origins covered with dense aponeurosis. Above the pelvic arch they divide into numerous tendinous slips which run backwards in separate sheaths, each successively approximating the middle line of the body, where they are inserted on the dorsal aspect of each vertebra as far as the extremity of the tail.

The inferior lateral muscles, like the preceding, take their origin in the lumbar region, and present nearly the same arrangement, only their tendons are much more slender than those of the superior set. At their termination each tendon bifurcates, allowing that appropriated to the succeeding vertebra to pass through it so as mutually to form sheaths to each other, so that they are all, except the last, both *perforati* and *perforantes*.

Osseous Fishes have no special muscles appointed for the movements of the head, but in the Rays there are three destined to this office, one serving to move the head upon the trunk, the other two raising and depressing the extremity of their elongated snout.

The former is situated upon the upper aspect of the body above the branchial cavity. It arises from the vertebral column and from the anterior portion of the pectoral zone. Its insertion is into the posterior region of the head, which it raises towards the back.

Of the two muscles of the snout, the superior arises also from the scapular cincture by a short fleshy belly, from which a thin cylindrical tendon is given off. This runs in a mucous sheath, above the branchiæ to the base of the snout where it is inserted, serving of course to raise it upwards.

The other is situated beneath the body within the branchial cavity, where it arises from the

anterior cartilages of the vertebral column. It runs obliquely outwards, and afterwards inwards, so as to describe a curvature, the convexity of which is external. Its insertion is almost entirely fleshy into the base of the rostrum, which it bends or curves towards the belly.

The muscles of the huge pectoral fins form two thick fleshy layers, covering these limbs both above and below, and dividing into as many fasciculi as there are fin rays, into which they are inserted. A similar arrangement exists likewise in the ventral fins, the representatives of hinder extremities.

The muscles of the jaws in the cartilaginous Fishes are more numerous than in those possessed of an osseous skeleton. The lower jaw of the Skate is depressed by a large oblong muscular mass, composed of straight parallel fibres, which, taking its origin from the anterior margin of the transverse cartilaginous belt that sustains the pectoral fins, runs forward to be inserted near the centre of the inferior maxilla, which it thus powerfully depresses.

Two small muscles, one on each side, contribute to the same effect. These are attached in front near the commissure of the lips, and running inwards, almost cross each other beneath the preceding, which is *azygos*; there they are attached partly to the skin, and partly to the transverse cartilage.

Those muscles which raise the lower jaw act likewise upon the upper. One attached to its lateral part mounts over the upper jaw, as over a pulley, and runs to be implanted above the upper jaw, which is here moveable, into the base of the cranium.

A second is broad and short. Its fibres are

straight, parallel, and fleshy, passing from the superior margin of the upper jaw to the inferior margin of the lower.

The third presents a very singular arrangement, having its fibres interlaced in a very remarkable manner. These, however, may be divided into three principal masses, two of which are anterior and one posterior.*

One of these masses is situated in front of and above the upper jaw near the commissure. It is attached to its superior margin, and runs obliquely to join the external edge of the second mass. This latter occupies nearly the same position relative to the lower jaw; it passes behind the other and is conjoined with it externally. The third or posterior mass is derived from the end of the upper jaw, and joins the hinder margin of the second. All these fibres so singularly interlaced co-operate in holding the mouth closely shut when the Skate has seized its prey.

Lastly, there are two very long muscles derived from the spine, which pass between the palate and the cranium to be inserted into the upper jaw. These bring the mass of the mouth forward again after it has been retracted by the broad oblong azygos muscle above described, which passes between the pectoral zone and the inferior maxilla.

Fig. 507.

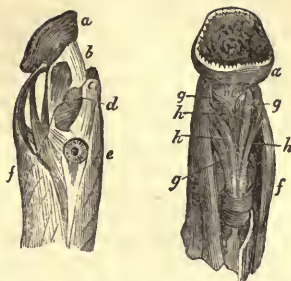

Head of Lamprey, after Carus, shewing muscles.

a, b, c, cartilages of the mouth; *d, e, f*, external muscles inserted into ditto; *g, h*, muscles derived from the hyoid apparatus.

In *Sharks* the lateral muscles of the body and fins resemble those of the osseous Fishes. Their jaws, however, constructed after the same principle as in the Skate, are equally moveable, and their muscles almost similar; only here, as their mouth is situated much nearer the anterior extremity of the skull, the two great muscles coming from the spine to the upper jaw are wanting.

Fig. 506.

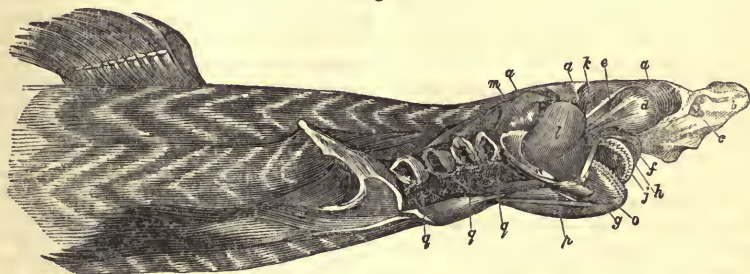
Myology of Shark (*Squalus glaucus*). After Carus.

a, a, a, cranium; *b*, rostrum; *c*, olfactory organ; *d*, eye-ball; *e*, muscles of eye; *f*, upper-lip; *h, j*, teeth; *k*, lower surface of skull; *l, m*, muscular masses which close the mouth, resembling those of the Skate described above; *g*, broad muscle passing from upper to lower jaw; *p*, depressors of lower jaw, as in the Skate; *q, q, q*, entrances to the gill-chambers.

In the Lampreys (*Petromyzonida*) the oral sucker is moved by slips derived from the anterior termination of the great lateral muscle (fig. 507, *f*) as well as by a set of very strong fasciculi derived from the hyoid apparatus, which, by retracting the interior of the disc, cause the adhesion of the sucker, and move the different parts of the dental apparatus described in a preceding page, (*g, h, m*.) The action of these will, however, be better understood by inspecting the figures than by any detailed description.

Tegumentary system.—The essential character of the skin, says Agassiz,† is that it completely envelops an animal, and thus forms a kind of external skeleton which protects it over its whole

surface, as the osseous skeleton protects and supports the internal viscera. In the invertebrate races of animals there are no other solid parts except those which are produced by or connected with the tegumentary system, but which nevertheless can by no means be compared with the osseous system of the Vertebrata, which is quite peculiar to the latter, and has no analogy whatever with the solid framework of the inferior classes.

The skin, moreover, (observes the same illustrious author,) is not exclusively limited to the external surface of the body, but penetrates into and invests the internal cavities, on the inner surfaces of which it likewise produces solid structures of various kinds to which different offices are assigned, as, for example, the teeth and all the corneous pieces which in many classes are met with upon the lining membrane of the digestive tube. It

* Cuvier, Leçons d'Anatomie Comparée.

† Agassiz, Recherches sur les Poissons Fossiles, 4to. 1834.

therefore becomes necessary to distinguish two modifications of the dermal skeleton, one constituting the investments of the external surface of the body, the other developed from the internal surface. These two kinds of exo-skeleton exist simultaneously in all vertebrate animals in addition to the endo-skeleton or proper osseous system, which encloses the visceral cavities or affords a framework around which the soft parts are situated. In the vertebral division of the animal kingdom not only do these two modifications of the dermo-skeleton present numerous connexions with each other, but they are likewise intimately connected with the osseous system, and in many parts of the body insensible transitions may be perceived between one and the other, as in Fishes, more particularly between the opercular bones and the scales, or between the latter and the bones of the occiput and humerus, or between the pharyngeal bones and the teeth. (See OSSEOUS SYSTEM, Comp. Anat. vol. iii., page 846.)

There exists, however, a constant antagonism in the development of the three kinds of skeleton above indicated, some of the different parts of which attain to a more perfect growth in proportion as those of the other are less complete in the different regions of the body.

Before proceeding further with this subject, it will be necessary to examine with a little attention the structure of the skin itself preparatory to describing the various dermal appendages produced therefrom.

The skin of Fishes is always much more tensely stretched over the surface of the body than in other animals, and, being closely united to the subjacent muscles by dense cellular tissue, is never endowed with that mobility which is observable among many of the higher Vertebrata. As in other classes, the skin is composed of an epidermis which forms the external envelope of the body, of a *rete mucosum*, consisting of the internal stratum of the corneous epidermis, which as yet remains soft and covers the surface of the corium by which it is secreted; and lastly of the corium itself, or the internal living skin furnished with nerves and vessels by which the outer layers of the integument are secreted as well as the different colours that ornament the exterior of the fish.

The varied colours of the fish result in fact from the deposition of corresponding pigments between the epidermis and the true skin, and in the class before us these colouring matters are particularly abundant. In the first place the inner surface of the scales is imbued with a pigment of metallic splendour, and generally of a silvery or golden hue and of brilliant lustre, besides which, more especially towards the back and over the upper aspect of the body, are points or patches of black or diversely coloured pigments, which according to their abundance and character give the peculiar markings of the fish.

The material which gives this metallic lustre to the scales of Fishes, known in commerce under the name of "argentine," was minutely

investigated by Reaumur,* who found that, when examined under high magnifying powers, it is composed of crystalline laminae, divided transversely so as to form rectangular figures about four times longer than they are broad. These crystals he believed to be contained in vessels, or in delicate tubes of animal matter, mistaking for vessels the little bundles in which they are disposed.† These different pigments have been lately discovered to consist of extremely minute crystals of various earthy and metallic substances; they are met with even in the interior of the body, as for example, upon the external surfaces of the peritoneum, of the brain and medulla oblongata, and in the interior of the eyeball. Ehrenberg observed them in the Pike; but they are met with in all Fishes, and present numerous varieties of form and composition in different species. One very remarkable phenomenon connected with the colour of Fishes, and which apparently depends upon the abundance of these pigments, and the rapidity with which they are secreted and absorbed, is the change of colour which many species undergo at different periods of the year, as, for example, at spawning time; or during their growth, or even when excited to violent exertion, or lastly after their death, when they are exposed to different atmospherical influences. During the spawning season, observes Agassiz, the tints of all species hitherto observed are more vivid and distinctly marked than at other periods; but even whilst drawing living specimens, he has observed that, when suddenly irritated or whilst making violent movements to escape from the hand when seized, these colours suddenly become much deeper and more brilliant, after which they become completely pale, and only return by slow degrees; a phenomenon which the writer above quoted supposes to depend upon a sudden exuberant secretion and subsequent absorption of the coloured pigments.

The surface of the body of living Fishes is moreover constantly lubricated by a great quantity of mucus, which in some is possessed of little tenacity, and forms a very thin layer; whilst in other species, especially in such as have but slightly developed scales, it is of more consistency and furnishes a covering of considerable thickness, as for instance in the Tench and Eel. This fluid is secreted by a muciparous canal, which extends along the whole length of the body and ramifies extensively in the bones of the head. The fluid which it secretes, which is very viscid and difficult to mix with water, exudes at the surface through a number of orifices which are visible upon the cranium, upon the bones of the face, along the jaws, upon the preoperculum, and likewise through the series of tubes which perforate the scales along the lateral line. From these sources it is distributed all over the surface of

* Histoire de l'Academie Francoise, 1716 and 1718.

† This substance, argentine, under the name of "essence de l'orient," was extensively employed in the time of Reaumur for the manufacture of artificial pearls, and was on that account an exceedingly costly article.

the fish, as may easily be proved by drying it with a napkin, after which operation it soon becomes again covered with mucus, which issues from the openings of these pores.

In the Tunny (*Scomber thynnus*) there runs beneath the skin, following the entire length of the lateral line, an organ of a redder colour than the rest of the flesh, from which the little tubes forming the lateral line proceed, each tube receiving a nervous filament from the great lateral nerve. On raising the integument over this glandular organ a large vessel is seen, which, besides giving off arteries to the neighbouring muscles, furnishes an infinite number of branches to the glandular mass, beneath which, at nearly an inch from the surface, runs the lateral branch of the eighth pair of nerves, which in most other Fishes is situated immediately beneath the skin. It is in the Raidæ or Skates, however, that this system of vessels is most largely developed. In these broad-bodied fishes there is found upon the ventral aspect of the body a large canal which surrounds the prominent muzzle, forming very regular angles and windings, distributes its secretion by three or four branches on each side, and then winds upwards to terminate by different openings. There is, moreover, on each side at the external angle of the branchiæ a kind of sac which is round and of a whitish colour, which receives a large branch from the fifth pair of nerves, from which proceed a number of long simple vessels which run in radiating fasciculi in four or five different directions, and open at remote points on the surface of the body.

In Sharks the entire substance of the snout is made up of a dense cellulosity filled with a mucilaginous fluid, in which are imbedded fasciculi of tubes that open upon the surface of the skin by wide orifices. Besides these there are large vessels of similar character, one of which runs along the whole length of the animal on each side. Innumerable muciparous follicles contribute likewise to lubricate the skin, more especially in the vicinity of the snout.

By far the greater number of genera in the class before us are covered with imbricated scales, which overlap each other like the tiles of a house; the external and visible portion of these scales is covered with a thin layer of dermis, which soon dries on exposure to the air; their internal or concealed part is lodged in a cavity which is a kind of sacculus hollowed out in the dermis itself, or formed by one of its replications—an arrangement which at first sight appears very different from what exists in Lizards and Serpents, in which what is called a scale is only a production of the cutis covered by the epidermis, that on the outer surface assumes a greater consistency and thickness; but in the genus *Sciurus* we have an intermediate arrangement between the imbricated scales of Fishes and what is met with in the scaly Reptilia. In the genus above mentioned the folds of the dermis are occupied by a calcareous plate, constituting a true scale easily separable from the cutis which envelopes it. We have only therefore to suppose the texture of this layer of cutis to be thinner and more

delicate, and we arrive at once at the scale of a fish, which seems in a fossa excavated in the cutis. In Fishes the scales thus implanted in the true skin were supposed by Cuvier to have no vascular connection with it, but to originate like a shell in the mantle of a mollusk by the gradual deposition of consecutive layers deposited from the dermis; and all their varieties of surface, their different sculpture, the ridges or spines with which they are sometimes armed, and which frequently render them very beautiful objects for the microscope, were generally thought to have a similar origin.

Dr. Mandl* appears to have been the first who, by a microscopic examination of the intimate structure of the tissues which enter into the composition of the scales of Fishes, arrived at just conclusions relative to the mode of their formation, and proved that, so far from being mere exudations of corneous matter, they are produced, like the teeth and osseous tissue, by a true internal growth and nutrition.

The following is an abstract of the result of Dr. Mandl's researches upon this interesting subject, in which he satisfactorily proves that the scales of Fishes consist of two layers, of which the inferior exhibits a structure analogous to that of fibro-cartilage, whilst the superior resembles corpuscular cartilage, and is evidently formed by the development of primitive cells.

Taking a well-developed scale, as that of a Carp, for an example, it is easy to perceive that its surface is marked with longitudinal lines arising from a common centre, and running towards the periphery of the scale, the number of which it is generally very easy to determine. The place towards which these lines converge is a space of variable dimensions, called by Dr. Mandl the *focus*. Between the longitudinal lines are seen, running parallel to the circumference of the scale, a very considerable number of concentric lines, which are crossed by the longitudinal ones at right angles; these are named "*cellular lines*," because they owe their origin to the development of cells. Besides the parts above mentioned, many kinds of scales exhibit upon their surface, and upon one of their edges, spines of different forms, called by Dr. Mandl the *teeth* of the scale, a name which he founds upon the mode of development of these appendages. Around the longitudinal and transverse lines, more especially near the point where the former converge towards the "*focus*," are numerous yellowish corpuscles of an elliptical shape, named the *corpuscles* of the scale.

Lastly, if the upper layer of the scale be raised or torn, an inferior stratum is displayed, of a fibrous character. These different structures he then proceeds to describe seriatim.

1. The *longitudinal lines*, which, arising from the *focus* of the scale, run towards its periphery, play an important part in the anatomy of the tissue we are examining, and when highly magnified are found to be so many canals exhibiting in the scales of different species

* Recherches sur la Structure interne des Ecailles des Poissons. Par le Dr. L. Mandl. Ann. des Sc. Nat. tom. xi.

every degree of formation from a simple furrow to a perfectly enclosed tube.

The broad scales or plates which form the armour of the Syngnathidæ are traversed by similar canals enclosed on all sides, which, although separate at the margins, anastomose freely towards the middle of the scale.

The longitudinal lines in all their forms constitute a series of hollow tubes that must be regarded as true canals. These canals traverse the scale in a longitudinal direction converging towards a focus, which, as will be shown hereafter, is a centre of nutrition, so that most probably these tubes perform the functions of nutritive vessels.

2. The *cellular lines*, supposed by preceding writers to be merely lines of growth analogous to those observable upon the exterior of a bivalve shell, attentive examination shews to owe their arrangement to a very different cause, originating in the development of primitive cells, which are developed in the superficial stratum of the scale and gradually assume an elongated form, become filled with corneous matter, and ultimately arrange themselves in concentric lines of greater or less breadth, which only indicate by their uneven edges their original nature.

3. The *corpuscles* seen in scales are precisely similar in their appearance to those met with in bone and cartilage, and are obviously of the same nature. They are distributed in the basis membrane, which seems to be an amorphous tissue resembling that in which the corpuscles of bone are deposited, and which forms the superficial stratum of the scale.

4. The *fibrous layer*.—On scraping off with a penknife the external surface of the scale, the cellular lines and the corpuscles with their basal membrane are removed, and the deep-seated stratum of the scale becomes visible, which is then seen to consist of fibrous lamellæ composed of fibres that cross each other at regular angles, giving to this tissue the appearance of fibro-cartilage. This layer is thickest near the focus of the scale, and become gradually thinner towards the edges.

5. The *focus* is the space towards which the longitudinal lines converge, but is not always situated in the centre of the scale; it is occupied by very large pale corpuscles and by interrupted circular lines; such at least is its appearance in the scales of Acanthopterygenous Fishes, but in the Malacopterygii, and more especially in those species which have membranous scales, it presents nothing but a smooth circumscribed surface without corpuscles or interrupted laminæ, and is then generally surrounded by the concentric cellular lines.

6. *The teeth of the scales*.—The growth of the spines and other appendages seen upon the outer surface and posterior margin of many forms of scales, more especially in those named *ctenoid* by Agassiz, is a subject of very considerable interest, and to the old physiologists, who believed all scales formed by mere exudation, must have been quite unintelligible. The production of these spines is in fact, according to the researches of Dr. Mandl, in every respect

similar to the growth of teeth, each being enclosed in a distinct capsule and developed in the following manner, as exemplified by the growth of a scale of *Corvina nigra*, one of the Scienidæ.

The posterior margin of one of these scales is occupied by conical appendages, represented in a highly magnified condition in *fig. 508*. Each of the oblong processes here depicted is seen to be enclosed in an envelope, from which, however, it is entirely separate, as is proved by the fact that when the capsule is ruptured the enclosed spine can be removed from it with the utmost facility. Examined in detail, every one of these spines exhibits an organization and mode of growth precisely similar to that of a tooth, being formed in its capsule exactly in a similar manner. The germ begins gradually to develop itself; it acquires roots, and becomes distinctly composed of different layers, so that these spines may with propriety be called the teeth of the scales, in allusion to the mode of their development. The marginal teeth are most developed, and those nearest the focus least so. Thus in the figure the two superior teeth are seen enclosed in their capsules, their bases thick and well formed, and the whole surface of the tooth smooth and continuous. In the two next teeth below, the development is much less advanced; the extremities are truncated, the external layer of the tooth does not entirely cover it, but the roots are visible. Still lower down the teeth of the scale become more and more imperfect, until the lowest are scarcely at all developed, and are barely distinguishable among the surrounding corpuscles.

Fig. 508.



A small portion of the scale of Corvina nigra, highly magnified, shewing the progressive development of the teeth upon its surface. (After Mandl.)

In other families with denticulated scales the growth of these appendages is precisely similar, as in the Gobioides, Percoides, Pleuronectidæ, &c.

From the above observations it becomes evident that the scales of Fishes can no longer be regarded as mere productions of secretion from the skin, but must be considered as possessing an inherent power of nutrition and a true growth. The denticles which exist upon many of these scales offer by their successive development a striking proof of this important fact; while the canals whereby they are traversed, and the corpuscles belonging to their structure, plainly intimate that their mode of development is similar to what exists in the teeth and in the osseous system.

The chemical composition of the scales of Fishes, moreover, very nearly approximates

that of their teeth and bones, as will be evident from the following analysis made by M. Chevreul of the scales of a *Lepidosteus*, of a *Chetodon*, and of the *Perca labrax*, after they had been thoroughly dried by exposure during six weeks to a dry atmosphere. In drying, the scales of *Lepidosteus* lost 11.75 per cent., of *Chetodon* 13 per cent., and those of the *Perca labrax* 16 per cent.

	Scales of		
	Lepidosteus	Perca labrax.	Chetodon.
Fatty matter principally consisting of oleine	0.40	0.40	1.00
Azotized matter	41.10	55.0	51.42
Chloride of sodium	00.10	Trace	Trace.
Sulphate of soda	00.10	00.90	1.00
Subcarbonate of soda	00.10	00.00	0.00
Subcarbonate of lime	10.00	3.06	3.68
Phosphate of lime (of bone)	46.20	37.80	42.00
Phosphate of magnesia	2.20	0.90	0.90
Peroxide of iron	Trace	Trace	Trace
Loss	0.00	2.84	0.00
	100.00	100.00	100.00

In a preceding article (see OSSEOUS SYSTEM, Comp. Anat.) we have endeavoured to shew that the scales which invest the exterior of the body constituting the exoskeleton of Fishes, by progressive modifications in their size, texture, and arrangement, are converted into very various organs, namely, the apparently osseous plates that cover *Lepidosteus* and *Ostracion*, the formidable prickles that stud the external surface of the *Diodons*, the opercular flaps of the Sturgeon, and even those of the osseous Fishes; the spines of *Gasterosteus*, and those which in *Silurus*, *Balistes*, and *Lophius*, were likewise proved to belong to the epidermic or tegumentary system; lastly, the fin-rays and interspinous bones of the vertical fins were found to be derivations from the exoskeleton, instead of being, as they have long been considered, parts appertaining to the endoskeleton or true osseous system.

The dental organs of vertebrate animals have very naturally been regarded by the old anatomists who confined their osteological researches to the investigation of the human skeleton, as forming a part of the bony framework of the body, notwithstanding that the teeth in every particular of their economy were confessedly very different from any other pieces of the skeleton.

Any one who with a little care examines the dental apparatus of Fishes will, however, speedily be convinced that the *teeth* in common with the epidermic structures above enumerated are all of cuticular origin, their connection with the real osseous skeleton, by their roots becoming consolidated with certain bones of the mouth or implanted into the jaws, being by no means an essential or even constant circumstance.

Every one knows that the skin covering the body of the Skate or Thornback is thickly studded with calcareous spines, some of microscopic size, but others of considerable dimensions. On tracing these cuticular spines towards the mouth they are found, as they pass over the manducatory surfaces of the upper and lower jaws, to become suddenly very much increased in size, and are arranged with such regularity that they constitute a very formidable set of dental organs, consisting of ten or a dozen rows of sharp teeth, which answer every purpose connected with the seizing and swallowing of food. These teeth, however, or scales, for such they indubitably are, have no connection with the jaws that support them except through the intermedium of the cutis or mucous membrane covering the mouth, from which they are developed, and are continually in these Plagiostome genera in progress of formation behind as they are worn away in front, their development being accomplished in the following manner.* A series of minute and closely aggregated papilliform matrices or pulps rise in succession from the mucous membrane behind the teeth already formed, which gradually become ossified by the deposition of calcareous salts in the

Fig. 509.

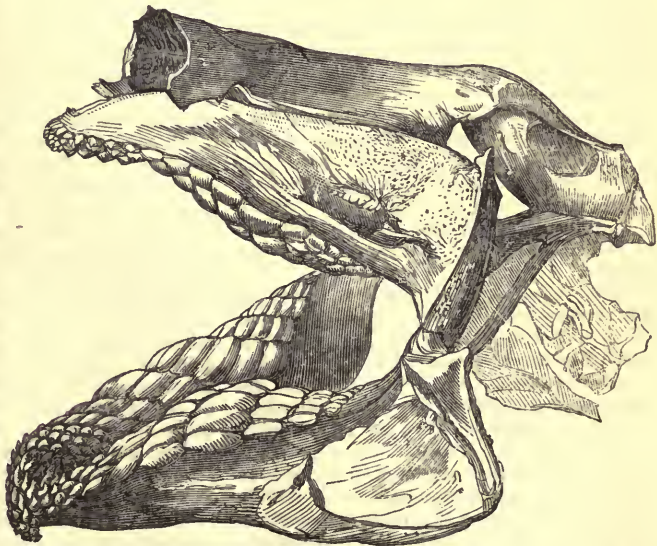

Skull and jaws of Port Jackson Shark (*Cestracion Philippii*), shewing the forms and arrangement of the teeth.

peripheral cells and radiating tubes of which the pulp consists.

* Owen, Odontology, 4to. 1840.

In *Mylobates*, a kind of Ray, in which the teeth are most perfectly adapted for crushing and bruising food, the arrangement of the dental apparatus is very curious. In this fish the teeth form broad plates, which are of hexagonal shape, and so closely fitted together by their edges that they form a complete tessellated pavement.

In the *Cestracion Philippii*, or Port Jackson Shark, both the above descriptions of teeth are found united in the same jaws, the anterior resembling the sharp teeth of the common Rays, while the posterior are broad and disposed like the paving-stones in a street (fig. 509). The *Mylobates* affords, moreover, an additional proof of a very convincing description that the teeth of Fishes are developed from the lining membrane of the mouth quite independently of the jaws, seeing that here there is a row developed from the mesial line of the jaws, precisely over the symphysis—a circumstance never observable in the higher animals, where the jaws and teeth are brought into closer relation with each other.

The teeth of the Squaloid Fishes or true Sharks are renewed by a very similar mode of growth. In these redoubtable monsters of the deep the teeth consist of numerous rows of broad and trenchant laminae, the anterior row of which (fig. 510, *a*) stands up perpendicularly from the jaws ready for use, while the succeeding layers are recumbent, being covered over by a fold of the mucous lining of the mouth. These teeth, like those of the Rays, are perpetually renovated, new and sharp rows being constantly ready behind to replace the old and worn ones in front as soon as the latter fall out or become useless.

The situation of these teeth and their mode of growth is represented in the annexed figure. Their only connection with the cartilaginous jaw is evidently through the medium of the interposed fibro-mucous layer (*d*), which, as it slowly advances forward, carries the teeth with it, and thus brings the successive rows progressively into use. In the Sharks there is no distinct pulp, the dense exterior layer of the tooth being formed by the calcification of the "membrana propria" of the pulp, so that when divided they are found to be permanently hollow, as represented in the figure (*c*).

In the Cyclostomatous Fishes the teeth are still more evidently mere cuticular appendages, seeing that in their case there are no bony jaws to which they can be affixed. In the *Myxine Glutinosa*, the Hag-fish, one of the most humbly organized but at the same time the most formidable of the finny tribes, this is extremely evident. The *Myxine* is generally found buried in the substance of some large fish which it has attacked, and by means of the tremendous apparatus we are about to describe succeeds in penetrating, tearing, and devouring the soft parts of its unfortunate victim as it pioneers its way into its interior. In order to effect this these fishes are furnished with a single sharp and recurved fang attached to the centre of the roof of their mouth and fixed to the cartilages of the cranium by strong

Fig. 510.

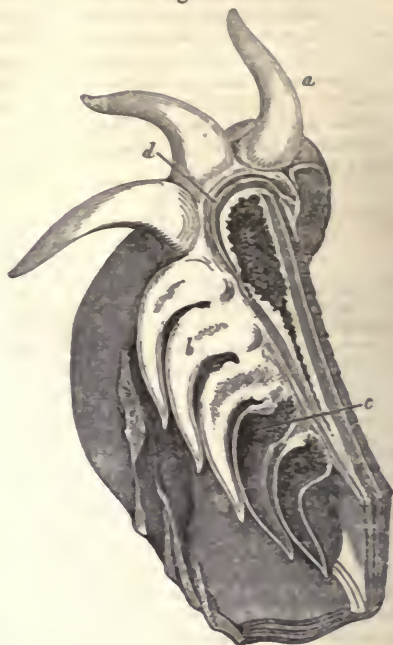

fibrous bands. Inferiorly the surface of the tongue is covered with four rows of sharp horny blades, two rows being placed on each side, the whole apparatus being susceptible of being advanced and retracted by means of strong muscles. It is not difficult, therefore, to imagine the efficiency of a dental apparatus such as this in enabling the *Myxine* to accomplish its murderous purpose.

The Lampreys, likewise, whose parasitic habits are not very dissimilar from those of the *Myxine*, have a very singular dental apparatus, which is quite distinct from the cartilaginous skeleton, and evidently purely composed of epidermic structures. The teeth of the Lamprey are composed of horny plates or tubercles of different forms, which are disposed with great regularity over the whole surface of the sucker-shaped mouth. Each of these horny teeth is supported upon and secreted by a pulp derived from the mucous membrane of the mouth, much in the same manner as other corneous epidermic structures, and from their disposition will evidently secure a deadly hold of any victim seized upon. Besides these labial teeth there is one fixed to the roof of the mouth which is obviously analogous to the solitary palatine fang of *Myxine* last described. This (fig. 511, *b*) is composed of two horny cones attached by fibrous ligaments to the palatine cartilages in the roof of the mouth. The tongue (*d*), which, like that of the *Myxine*, is here very moveable and capable of being retracted and protruded by means of strong muscles, is likewise armed with serrated teeth, with which, as with a rasp, the Lamprey tears through the flesh of its prey.

Fig. 511.

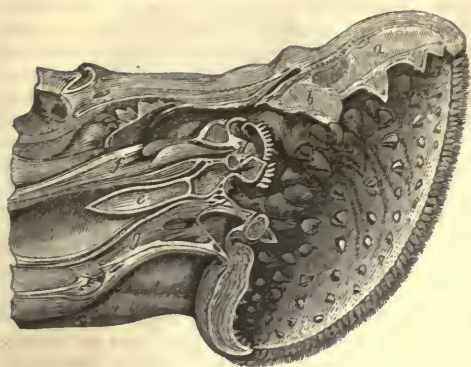

Seeing, therefore, that the teeth of Fishes are derivations from pulps formed by the mucous lining of the mouth, it can be a matter of small astonishment to find that they can be developed in any part of the oral cavity where the necessities of a given species may require their presence, without relation to the jaws, with which alone they are connected in the highest races of Vertebrata and in the human subject.

Accordingly in the class under consideration teeth are found attached to any or all of the following parts of the mouth and of the pharynx, viz. to the superior and inferior maxillæ, to the intermaxillary bones, to the palate bones, to the vomer, to the tongue, to the branchial arches, and to the superior and inferior pharyngeal bones. The ichthyologist is therefore compelled to designate the different parts of the dental system according to the bones or other structures whereon they are situated, and distinguishes intermaxillary teeth, maxillary teeth, mandibular teeth, vomerian teeth, palatine teeth, pterygoid teeth, lingual teeth, branchial teeth, superior pharyngeal teeth, and inferior pharyngeal teeth, all of which may sometimes be coexistent, rendering the teeth of Fishes prodigiously numerous. As relates to their form the dental organs offer a far greater number of varieties than those of other vertebrate animals. Sometimes they are so minute as only to be perceptible by the rough or scabrous surface which the parts of the mouth to which they are attached present. If of larger size, they present the appearance of a file or rasp (*dents en rape*), or they may have the shape of small cones or hooks thickly scattered over the parietes of the mouth. Sometimes they are so fine and slender as to resemble the pile of velvet (*dents en velours*), or elongated, having the appearance of fine bristles. In *Citharina* these bristle-shaped teeth are bifurcated towards their free extremities, or they may terminate in three diverging points, as in the anterior teeth of the genus *Platax*. Or the elongated cone may be compressed into a slender trenchant plate, and this may be pointed, recurved, or even barbed like a fish-hook, as is the case in *Trichiurus* and some other Scomberoid Fishes; or it may be bent upon itself like a

tenter hook, as in *Pemlepterus* and *Goniodontes*. Sometimes the dental cones present a thickened base, giving them the appearance of the laniary teeth of carnivorous quadrupeds, as is the case with the large teeth of the *Pike*; or they may be flattened into broad plates of hemispherical or other shapes, constituting a crushing apparatus adapted to bruise the food.

A thin lamella, slightly concave like a finger nail, is the singular form of the tooth of an extinct species of cartilaginous fish named by Professor Owen *Petalodus*.* Sometimes each tooth presents a flattened incisor crown deeply notched in the middle of the cutting edge, as in *Sargus unmaculatus*. Sometimes there is a double notch, rendering the margin of the tooth trilobate, as in *Aplodactylus*; or it may be divided into five lobes by a double notch on each side of the central and largest lobe, as in *Boops*.

In the great Barracuda pike (*Sphyræna*) the crown of both the large and small lamelliform teeth is prolonged into a sharp point, closely resembling a lancet. A similarly shaped piercing and cutting tooth is in many of the Sharks furnished with one or more accessory cusps at its base, and the cutting margins of the tooth are frequently notched, serrated, or crenated. Prismatic teeth with three sides are fixed to the jaws of *Myletes*; and in some instances, as in *Scarus*, they assume the shape of four-sided prisms.

The teeth of Fishes† present greater diversity in their mode as well as in their place of attachment than is observable in any other class of animals. In a few instances they are implanted in sockets, to which they are attached only by the surrounding soft parts, as, e. g. the rostral teeth of the Saw-fish (*Pristis*). Some have their hollow base supported, like the claws of the feline tribes, upon bony prominences which rise from the base of the socket; the incisors of the File-fish (*Balistes*) afford this curious example of a double gomphosis, the jaw and the tooth reciprocally receiving and being received by each other.

The teeth of *Sphyræna*, *Acanthurus*, *Dicotyodus*, &c. are examples of the ordinary implantation in sockets with the addition of a slight anchylosis between the base of the fully formed tooth and the parietes of the alveolar cavity. But by far the most common mode of attachment of fully formed teeth is by a continuous ossification between the dental substance and the jaw, the transition being gradual from the dental to the osseous tissue. The tooth prior to its anchylosis is connected by ligamentous substance, either to a plain surface, an eminence, or a shallow depression in the bone.

Sometimes not the end, but one side of the base of the tooth is attached by anchylosis to the alveolar border of the jaw; it might be supposed that in this case the crowns of the

* Owen, *Odontography*, p. 2.

† Owen, loc. cit.

teeth in both jaws would project forwards instead of being opposed to one another, and such, in fact, must have been their position were it not that, as in *Pimelopterus*, the teeth are bent at nearly a right angle with their base. In the *Scarus*, and likewise in the marginal teeth of the *Diodon*, where these organs are straight and attached horizontally to the margin of the jaws, their sides instead of their crowns are actually opposed to each other.

In the Cod-fish, Wolf-fish, and some other species, in proportion as the ossification of the tooth advances towards its base and along the connecting ligamentous substance, the subjacent portion of the jaw-bone receives

Fig. 512.

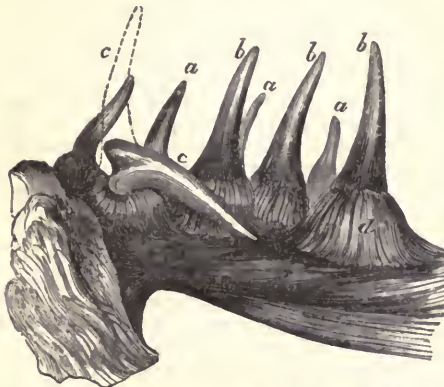

Portion of the jaw of *Lophius piscatorius*, showing the ligamentous attachment of the teeth.

a, a, a, anterior teeth; *b, b, b*, posterior teeth in their erect position; *c*, one of these teeth laid flat towards the interior of the mouth, the dotted lines indicating its condition when erect. (After Owen.)

a stimulus and develops a process corresponding in size and form with the solidified basis of the tooth. In this case the inequalities of the opposed surfaces of the tooth and maxillary dental process fit into each other, and for some time they are firmly attached together by a thin layer of ligamentous substance; but, in general, ankylosis takes place to a greater or less extent before the tooth is shed. The small anterior maxillary teeth of the Angler (*Lophius*) are thus attached to the jaw, but the large posterior ones remain always moveably connected by highly elastic glistening ligaments, which pass from the inner side of the base of the tooth to the jaw-bone (fig. 512, *d*). These ligaments do not permit the tooth to be bent outwards beyond the vertical position, when the hollow base of the tooth rests upon a circular ridge growing from the alveolar margin of the jaw; but the ligaments yield to pressure upon the tooth in the contrary direction, and its point may thus be directed towards the back of the mouth; the instant, however, that the pressure is remitted, the tooth flies back, as by the action of a spring, into its former position. The deglutition of the prey of this voracious fish is thus facilitated and its escape prevented.

The teeth of the Wolf-fish, *Anarrhicus*, are

extremely remarkable. They do not adhere immediately to the jaw or to the palate bone, but are attached to conical or hemispherical osseous epiphyses, which are fixed to these bones by a kind of suture, and are easily detached at certain periods. The base of each of these epiphyses is surrounded with a row of small foramina, doubtless intended for the admission of vessels, and mark the line of separation. On the summit of these cones the true teeth, formed as usual of dentine and enamel, are attached.

"If," says Professor Owen, in the valuable treatise from which we have extracted the preceding paragraphs, "the engineer would study the model of a dome of unusual strength and so supported as to relieve from its pressure the floor of a vaulted chamber beneath, let him make a vertical section of one of the pharyngeal teeth of the *Wrasse* (fig. 513). The base of this tooth is slightly contracted and is implanted in a shallow circular cavity, the rounded margin of which is adapted to a circular groove in the contracted part of the base. The margin of the tooth which thus immediately transmits the pressure to the bone is strengthened by an inwardly projecting convex ridge. The masonry of this internal buttress and of the dome itself is composed of hollow columns, every one of which is placed so as best to resist or to transmit in a due direction the superincumbent pressure." The use of this beautiful piece of animal mechanics is to keep the delicate successional pulp which is lodged beneath the vault of the arched tooth, from being injured by pressure during the action of these powerful crushing teeth.

Fig. 513.

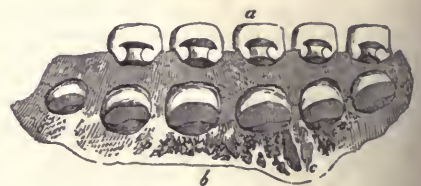

Teeth of the *Wrasse* (*Crenilabrus*).
Portion of the pharyngeal bone of the *Wrasse*.

a, structure of arched teeth; *b*, successional teeth; *c*, bone.

In *Rhizodus*, a large extinct species of Sauroid fish, the broad base of the tooth is divided into a number of long and slender cylindrical processes, which are implanted like piles in the coarse osseous substance of the jaw. They diverge as they descend, and their extremities bend and subdivide like the roots of a tree and are ultimately lost in the bony tissue. This mode of attachment of a tooth is perhaps the most complicated met with in the animal kingdom.

In order to complete our remarks concerning the teeth of Fishes it only remains to notice a few examples in which the dentition is peculiar, namely, in the Cyprinidæ, the Scari, the *Diodons*, and the *Tetradons*.

Fig. 514.



Teeth of the Tench.

a, roof of the mouth; b, the œsophagus; c, dental projection from basilar bone; d, d, pharyngeal teeth. (After Owen.)

In the *Cyprinidæ*, or Carp-genus, the bones composing the superior and inferior maxillæ are completely edentulous, but to make up for this deficiency the pharyngeal bones are armed with a remarkably powerful dental apparatus of very singular character. Each of the inferior pharyngeal bones, which are exceedingly strong and form a kind of osseous framework at the commencement of the œsophagus, supports four or five large teeth of great strength. These are opposed to a single dental piece of stony hardness and laminated structure, which is fixed upon a dilated projection from the basilar bone of the cranium (fig.

Fig. 515.



Beak of Parrot-fish (*Scarus muricatus*).

a, upper mandible, the exterior of which is completely encased in teeth; b, lower mandible partially so, the inferior teeth not having as yet protruded; c, lateral fangs. (After Owen.)

514), and thus forms a kind of anvil upon which the bruising pharyngeal teeth play, and thus crush and triturate whatever food passes into the œsophagus.

In the Scari, which have to feed upon the numerous corallines that clothe the rocks at the bottom of the ocean, the dental apparatus given to protect their jaws from injury while biting such hard substances is very remarkable. These Fishes have their jaws, which resemble the beak of a parrot (whence they receive their usual appellation "Parrot-fishes,") covered externally with a kind of pavement of teeth answering the same purpose as the horny investment of the mandibles of the bird. The teeth that form this pavement are perpetually in progress of development towards the base of the jaw, whence they advance forwards, when completed, to replace those which become

Fig. 516.

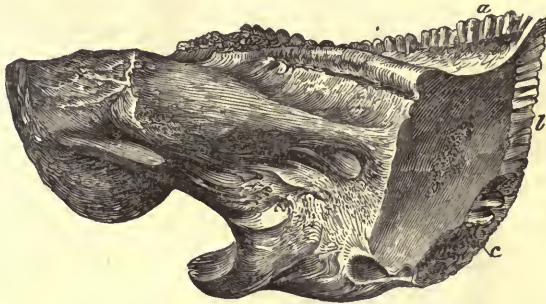

Section of the jaw of the Parrot-fish, shewing the progress of dentition.

c, teeth still enclosed in the jaw; l, do. with their extremities protruded so as to form an external pavement. (After Owen.)

worn away in front by the constant attrition to which they are subjected.

In the annexed figure (fig. 515) the external appearance of these singularly disposed teeth is well represented, while in the vertical section (fig. 516) the mode of their implantation into the anterior surface of the jaw is delineated. All these teeth were originally developed in a common alveolar cavity (516, c) situated in the substance of the jaw. The outer* wall of this cavity is much weaker than the dense and compact inner wall, and moreover it becomes thinner as it approaches the margin of the jaws and disappears (fig. 516, l) at different distances in different species of Scari before it reaches that margin. Where it exists at the base of the jaws it is sometimes, as in *Scarus muricatus* represented in the figure, perforated by numerous small foramina, through which foramina in the recent fish processes of the external periosteum are continued to the analogous membrane lining the dentigerous cavity and forming the capsule of each denticle. These processes are analogous to the gubernacula of the second series of teeth in the Mammalia, and like them serve to conduct the new teeth to the exterior of the jaw. The growing denticles (516, l) be-

* Owen, Odontography, page 115.

come elongated by the addition of successively calcified portions of their pulp to their basal or posterior extremities; the opposite end exerts a proportional pressure against the circumference of the foramen, and causing its absorption begins to protrude. The tuberculate crown of the denticle is exposed about the time when its sides become ankylosed to those of the previously protruded row. Thus, from the close apposition of the protruding denticles, the whole of the outer parietes of their common alveolar cavity subjected to the stimulus of their pressure is finally removed, and is replaced by the pavement of mutually ankylosed teeth (fig. 515, a).

In the *Diodons* and *Tetradons* the structure of the teeth is equally peculiar, but of a very different character from what has been described above. In the former genus each jaw is furnished with a double compound tooth adapted to crush and bruise the food, the structure of which at once reminds the anatomist of the molar teeth of the elephant. Each tooth (fig. 517) consists of numerous laminae superimposed upon each other, the upper ones being the oldest and most worn, while the lower ones are the largest and most recently formed. In consequence of this arrangement

Fig. 517.



Section of the lower jaw of the Globe-fish (*Diodon*), shewing the structure of its teeth.

a, circumference of jaw; b, grinding surface of tooth within the mouth. (After Owen.)

the exposed surface of the tooth that projects into the mouth (b) presents a grooved appearance, being formed of the edges of the contiguous lamellæ that are situated towards the upper part of the tooth. As these superior laminae are worn away, it is evident that they are continually replaced by the advancement upwards of the inferior plates, so that the tooth is kept constantly efficient for service. The circumference of the jaw (a) is formed of superimposed plates which grow from below in a precisely similar manner; but between these and the posterior laminated tooth a very different structure is interposed, which is revealed by the microscope to consist of a series of narrow flattened denticles lying horizontally and at right angles to the anterior surface of the jaw. These denticles are developed in a cavity between the outer and inner walls of the jaw, the floor of which is formed by a thin cribriform osseous plate separating the cavity containing the teeth from the wide vascular canal which runs in the substance of the jaw. In

the *Tetradons* a somewhat similar structure of the dental organs is met with.

The rostral teeth of the Saw-fishes, *Pristis*, are quite unique among the whole race of Fishes from the singular position which they occupy, as will be perceived by the following account of this strange apparatus extracted from Professor Owen's elaborate treatise.

"The maxillary teeth of the Saw-fish, which is an active and predatory Shark, are, notwithstanding its habits, extremely small, simple, obtuse, and wholly inadequate to destroy and secure the prey requisite for its subsistence. But this seemingly imperfect armature of the mouth is compensated for by the development from the anterior part of the head of a very singular and formidable weapon provided with strong lateral teeth, and which from its resemblance to a saw has given rise to the vernacular of 'Saw-fish,' applied to the present species of Shark."

In most of the Plagiostomes, but especially in the group of Squaloids, a conical projection or cutwater is continued from the fore-part of the head, and its framework is composed of peculiar and superadded cartilages articulated to the anterior extremities of the frontal, nasal, and vomerine bones. These rostral cartilages in the Saw-fish (*Pristis antiquorum*) are blended into a horizontally flattened plate, which is produced to a length equalling one-third that of the entire fish: this process is more completely ossified than any other part

Fig. 518.



Rostrum of Saw-fish (*Pristis antiquorum*), shewing the marginal teeth.

of the skeleton, and a series of deep alveoli is excavated in each of its lateral margins (*fig. 518*).

The teeth which are lodged in these sockets are elongated, compressed in the same plane as that of the body of the saw, and their edges converge to a sharp point, which is situated a little behind the axis of the tooth. Each rostral tooth is solid, its base being slightly concave and porous like the section of a cane, but the pores are finer and more numerous. The walls of the socket are formed by ossification of the rostral cartilages to an adequate extent; but as unnecessary weight under any circumstances, but especially at the fore-end of the fish, would be a cumbrous impediment to its motions, the spaces intervening between the sockets are hollow and filled with a gelatinous medulla. A large vascular canal traversed by branches of the facial artery and of the second division of the fifth pair of nerves enclosed in a cellular gelatinous tissue, runs parallel with the axis of the saw along the back part of the alveoli, and supplies the materials for the increase of the teeth, which are not shed and renewed like the maxillary teeth, but grow with the growth of the body by constant addition of fresh pulp-material progressively ossified at their base.

Œsophagus.—Owing to the extreme shortness of the passage between the cavity of the mouth and the stomach, the length of this tube is extremely limited in the whole race of Fishes; nevertheless, occasionally its boundaries are well marked, and its structure sufficiently distinct from that of the alimentary canal to entitle this part of the digestive apparatus to a brief notice. Its walls are generally strong and muscular for the purpose of passing the food into the stomachal cavity, but more especially so in those voracious Fishes which swallow dense and indigestible shells of various kinds, or that are subject to have their stomachs loaded with the hard bones of digested fishes, all which materials are in such instances regurgitated and thrown out of the mouth much after the manner of the "castings" of the Hawk or Owl among birds of prey. In a few races, however, the œsophagus exhibits peculiarities of structure that are remarkable. Thus in the *Torpedo* and others of the Ray genus, there is a very thick layer of a soft and semi-gelatinous substance interposed between the lining membrane and the muscular coat, the use of which it is by no means easy to conjecture. In the Sturgeon the mucous membrane of the gullet is prolonged into transverse valvular folds, analogous in their nature to the conical processes found in that of the *Turtle*. But the most striking example of a valvular apparatus situated in this part of the digestive tube is met with in the Sharks (*fig. 519*), in which race of Fishes the termination of the œsophagus is indicated by a great number of long fleshy stems, which divide and subdivide into very numerous branches, and thus form a dense and prominent fringe hanging loosely downwards towards the stomach, in such a way as to allow anything swallowed to pass freely in that direc-

tion, but by the interlacement of the fringes effectually preventing anything from returning towards the mouth. This structure is most conspicuously seen in the great Shark (*Squalus maximus*), in which species, owing to the comparative smallness of the teeth which arm the jaws, it is extremely probable that many Fishes are swallowed alive and might retain their vitality sufficiently long to struggle back again out of the stomach of their devourer, did not this strange gate effectually bar their progress.

Stomach.—This viscus is, in the generality of species, a musculo-membranous bag of very simple structure and of variable shape in different genera. Sometimes, however, its muscular walls are sufficiently strong to perform to a certain extent the functions of a gizzard: this seems to be the case, for example, in the *Gillaroo Trout* (*Salmo fario*), and to a far more remarkable extent in the Mulletts (*Mugil*), in which the œsophagus terminates inferiorly in a deep cul-de-sac that serves the purpose of a crop. The muscular stomach or gizzard opens from one side of this œsophageal bag, to which it is attached at right angles. Its shape is pyriform, the narrow end being directed towards the intestine, and its muscular walls nearly half an inch thick. Internally it presents numerous longitudinal folds, all covered with a thick cuticular lining, and evidently the whole apparatus is very analogous to the true gizzard of a granivorous bird. It was John Hunter's opinion that neither of these can be justly regarded as gizzards, since they want the most essential characters, namely, a power and motion fit for grinding, and a horny cuticular lining. According to Professor Owen, however, the latter structure exists in the gizzard of the Mullet as a distinct layer of rough and easily separable cuticle. The stomach of the Gillaroo or Gizzard-trout is certainly, as described by Hunter, more globular in its shape than that of most Fish, and endued with sufficient strength to break the shells of small shell-fish, which is probably accomplished by having more than one in the stomach at a time, and also by taking pretty large and smooth stones into the stomach, which will answer the purpose of breaking, but not so well that of grinding; nor will they hurt the stomach, as they are smooth when swallowed; but this stomach can scarcely possess any power of grinding, as the whole cavity is lined with a fine villous coat, the internal surface of which appears everywhere to be digestive. The common stream-trout, which only differs from the "Gillaroo" in having the walls of its stomach not so thick by two-thirds as the other variety, likewise swallows smooth round stones wherewith to crush the shell-fish which it occasionally devours.

Intestinal canal.—The intestines of Fishes present as many variations as regards their relative length when compared with that of the body, as do those of any of the higher Vertebrata, but their general arrangement is of a much more simple character. In the Flying-fish (*Exocoetus*), indeed, it presents the simplest possible form, being merely a straight

tube passing directly from the stomach to the anus. In the Mulletts (*Mugil*), on the contrary, the intestine is of great length and is very curiously folded, being interwoven with the folds of the liver so as to form a mass of triangular form moulded to the shape of the abdominal cavity, and affording an example of the longest and, in its disposition, the most complex intestinal canal of any of the class.

This arrangement, as Rathke very justly observes, is an obvious approximation to the disposition of the viscera most generally met with in molluscous animals, in which the folds of the intestine are prolonged into and almost buried among the folds of their very large liver.

In the *Electric Eel* (*Gymnotus electricus*) the disposition and termination of the intestinal tube is curious. First descending to the lower end of the stomach, it passes to the left side and ascends again as far as the œsophagus; it then winds downwards and backwards so as to encircle the stomach, and, lastly, advancing forwards along the ventral aspect of the abdomen, it terminates, as in the Cephalopoda, beneath the throat, in the immediate vicinity of the heart and root of the tongue.

No fish has anything like a colon or cœcum. The only distinction between small and large intestines is met with just at the termination of the alimentary tube, where it opens into a kind of cloacal cavity, usually called the *rectum*. At this point there is generally a prominent circular fold of the lining membrane constituting a kind of valve. In the Salmon several of these valvular zones succeed each other, giving to this part of the gut an appearance similar to that of the intestine of the Plagiostome cartilaginous Fishes immediately to be described.

In the Sharks and Rays, the Plagiostomes

Fig. 519.

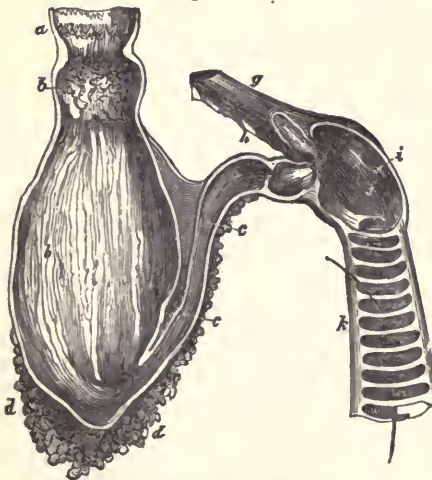

Alimentary canal of Shark.

a, œsophagus; b, b, cavity of stomach, at the commencement of which are placed the valvular fringes mentioned in the text; c, passage leading to pylorus; d, spleen; e, pyloric cavity; f, dilated chamber; g, h, bile-ducts; i, orifice of pancreatic duct; k, k, valvular intestine.

just referred to, and also in the Sturgeon, the intestine presents a very remarkable structure. Externally it resembles a wide bag nearly similar in shape and size to the stomach itself, and so short and stunted that, without some special arrangement, obviously a sufficient surface would not be afforded for the absorption of the nutritious portions of the food. By the mechanism adopted, however, this is abundantly provided. Throughout the whole length of the gut the mucous membrane is arranged in deep spiral folds (fig. 519), which wind from end to end, only leaving a small orifice in the centre of each valvular projection, whereby the different compartments formed between the spiral lamina can communicate with each other, so that the digested food by this unusual arrangement is spread over a very great superficial area, and all the benefits of a long and convoluted intestinal tube are secured. Each fold of this extensive spiral valve contains between the layers of mucous membrane that compose it an elastic substance, whereby it is kept constantly spread out and restored to its original position when displaced by the passage of food through the central channel that permeates the whole series.

In the Sturgeons a similar valve exists, but its spiral folds are not so closely arranged: the intestine, moreover, is remarkable on account of the great thickness of its muscular and internal tunics, the latter of which presents a reticulated or honey-combed appearance, the larger meshes including irregular spaces, which are again subdivided into smaller cells. Slight vestiges of the spiral intestinal valve are visible even in the Lamprey.

Salivary glands.—From the circumstances under which Fishes swallow their food, the presence of any salivary apparatus is evidently uncalled for; no fish, therefore, possesses true salivary glands. Nevertheless, in the Cyprinidæ and some other races the whole palate is covered with a soft spongy substance, from which a kind of mucosity is discharged through imperceptible pores, which has been regarded by Rathke and others as a salivary organ: Cuvier, however, denies the glandular character of this substance, regarding it as a peculiar and highly sensible tissue destined to be the seat of a sense more or less analogous to that of taste,—a supposition that is rendered more probable from the great number of nerves that enter its substance.

Pancreas.—In the osseous Fishes no pancreas, such as that met with in the higher classes of vertebrate animals, exists; it is, however, represented by a variable number of cœcal appendages, which open into the duodenum in the vicinity of the pylorus. The lining membrane of these pyloric cœca is of a glandular character, and secretes an abundance of a thin glairy fluid analogous to the pancreatic secretion. The existence of the appendages in question is, however, by no means constant; thus in the *Labridæ*, the *Siluridæ*, the *Cyprinidæ*, and many members of the pike genus, they are altogether wanting. When present, moreover, their number varies very remarkably in different Fishes; thus, sometimes, as in the

Salmonide, they are extremely numerous, while in other races, the *Pleuronctide* for example, there are only two cœca attached to the pylorus. That the pyloric appendages are strictly analogous to the pancreas, exhibiting that gland in its simplest condition, such as it presents in the embryonic state of the higher animals, is proved by the gradual transition that may be traced from the condition in which they exist as above described, and the undoubted pancreatic gland met with in the more highly organized cartilaginous Fishes. Thus in the Cod-fish (*Gadus morrhua*) the pancreatic cœca unite together as they approach the duodenum, so as to communicate with that intestine by comparatively few orifices situated in the vicinity of the pylorus; and in the Sturgeons this coalescence of the cœcal tubes is still more conspicuous, for in that race of Fishes the pyloric appendages are very short, and so connected together by vessels and cellular membrane into a single mass, that they here present a precisely intermediate condition between the free cœca of the osseous Fishes and the conglomerate pancreas possessed by the Sharks and Rays.

In the plagiostome cartilaginous Fishes last named, the pancreas is in fact a true conglomerate gland, resembling that of Quadrupeds, and in the same manner pouring its secretion into the intestine through a single excretory duct, which runs obliquely for a considerable distance between the coats of the duodenum, and terminates in the vicinity of the *ductus choledochus*.

Liver.—The liver of Fishes is generally of very great relative size, and frequently contains in its tissue such an enormous quantity of oil, that this alone forms an important article of commerce. Its texture is exceedingly soft, and from the arrangement of the vessels in its interior sometimes exhibits a fibrous appearance. The lobes of which it consists are generally very numerous, but there is always a gall-bladder, from which the bile is poured into the intestines through a single duct, which terminates in the duodenum near the pylorus.

Spleen.—This viscus, which is peculiar to the Vertebrata, first makes its appearance as we trace the animal series upwards in the class under consideration. In Fishes it is of very variable size, but is always present. Its usual position is among the folds of the intestines, and its relations with the stomach are so different to what obtains in the mammiferous races, that its functions cannot be in any way influenced by pressure caused by the distension of that organ. In its supply of arterial blood, which is subsequently transmitted to the portal system, it differs in no essential particular from what occurs in the other vertebrate classes.

All the above viscera are lodged in the cavity of the abdomen, in which they are suspended by numerous irregular folds of peritoneum; the generative and urinary organs, as well as the swimming bladder hereafter to be described, being situated beneath the spine external to the peritoneal sac, the peritoneum only covering their anterior surfaces. In many Fishes the

peritoneum does not form a closed bag, as is the case with the serous membranes in general, but on the contrary is penetrated by two large orifices situated in the vicinity of the anus, through which the peritoneal membrane becomes continuous with the external integument, and in this respect assimilates a mucous surface. Such is the case in the Sturgeons, Lampreys, Salmon, Sharks, and Rays: in the two last genera, indeed, the connection is still further extended by two orifices, through which the peritoneal bag communicates with the cavity of the pericardium. The mesentery is in Fishes very incomplete, consisting merely of irregular bands, which enclose the principal bloodvessels and unite the viscera to each other. Sometimes there are processes filled with oily fat representing the omentum.

In the *Branchiostoma* the œsophagus commences at the bottom of the buccal cavity behind the opening of the branchial sac, between the latter and the spinal axis, and after a short course terminates in a simple dilatation, which forms the stomach. About the middle of the branchial sac the alimentary tube becomes imbedded in the liver, and terminates in a delicate intestine, which extends to the anal opening.

Lymphatic system.—The principal lacteal vessels are situated near the large branches of the cœliac and mesenteric arteries and veins, and the large lymphatic trunks derived from the spleen, liver, and pancreas, accompany the chief bloodvessels of those parts.*

The lacteals and lymphatics of the assistant chylopoietic viscera are much larger in proportion to the bloodvessels than in Quadrupeds, Birds, or even in Reptiles. Their branches communicate with each other freely and repeatedly, and instead of uniting into one or two trunks, they form a right and left plexus, which are continued undiminished in size till they are about to join with the lymphatic system of the rest of the body. Neither the lacteal nor lymphatic vessels are quite cylindrical, but by being contracted a little in many places seem to be jointed, so that the anatomist would expect to find numerous valves in their course, yet these are entirely wanting, except at the termination of the whole system.

The lacteals terminate in a very remarkable structure, which is situated along the great curvature of the stomach. This consists of an elongated viscus, the inferior of which is entirely cellular, so that, when prepared by inflation and drying, its internal texture resembles the cancellated structure of bones, being composed of a great many cells of very irregular shapes, and all communicating with each other, so that probably this cellular viscus may perform the office of the absorbent glands of other animals, which in Fishes are totally wanting. Pursuing the right and left plexuses formed by the lacteals and lymphatics of the chylopoietic organs, we are led upwards along the sides and back part of the œsophagus to the sides of the spine and of the inferior venæ cavæ, and

* Monro, Structure and Physiology of Fishes, fol. 1785.

near to large veins covered by strong cartilages, which resemble our clavicles, and which therefore may be called *subclavian veins*. Towards these all the lymphatic vessels of the body are directed, the lymphatics of the kidneys and organs of generation with those of the tail and inferior parts ascending, those of the flesh and side fins of the trunk of the body running inwards, and those of the superior parts and of the brain, organs of the senses, heart, and gills, descending.

The branches of the lymphatic vessels form larger angles where they terminate in their trunks than are found in the veins, and the smaller branches are connected by transverse canals. The large lymphatics of the muscular organs, near their joining with the lacteals, are collected together in the most simple manner, without forming such intricate plexuses as are found in the course and near to the termination of the lacteal vessels: the lymph from the head and thorax in particular is conveyed chiefly by a single trunk, which receives large lateral branches from the adjacent parts. At last a single vessel on each side of the fish, and in which there is no dilatation or large receptacle, receives all the chyle and lymph, and terminates in the subclavian vein of the corresponding side very near its junction with the internal jugular vein, or nearly in the angle which these two vessels form by their joining. The blood is prevented from getting into these two vessels by a pair of valves placed at the termination of each.

In the osseous Fishes the course of the lymphatics has been traced both by Monro and Hewson,* principally in the *Gadida* and the Salmon: their general arrangement has been described above.

Four lymphatic vessels which terminate in the subclavian receptacles chiefly merit attention. The first conveys the lymph from the ventral parietes, from the ventral and pectoral fins, and from the heart. The second runs up the side of the fish parallel to the great mucous duct, and brings the lymph from the principal muscles of the tail and body. The third is deep-seated and conveys the lymph from the spine, spinal medulla, and upper part of the head, while the fourth lymphatic vessel, or rather plexus of vessels, brings the lymph from the brain and organs of the senses, and from the mouth, jaws, and gills.

The two receptacles into which all these vessels open communicate freely with each other by wide canals, which pass chiefly behind the heart and œsophagus, and each ultimately empties itself into the upper end of its corresponding vena cava inferior, contiguous to the termination of the internal jugular vein, the communications between the lymphatic and venous systems being guarded by valves.

It will be seen from the above description that the lymphatic system of Fishes offers several remarkable peculiarities when compared with what is met with among the higher Vertebrata, amongst which may be noticed the total want

of lymphatic glands, and the absence of valves in the absorbent trunks. Owing to this latter circumstance, nothing is more easy than to inject them from trunk to branch, and thus display their minute ramifications with the greatest ease. In this manner Mr. Hewson detected in the Cod a beautiful net-work of lymphatic vessels situated between the muscular and villous coats of the intestine, something analogous to what exists in the Turtle; but in Fish it is more evident that there can be no deception, seeing that the injection is contained in cylindrical vessels, not diffused in cells, as is the case in the reptile. If mercury be injected into this net-work, it spreads over the intestine; and if the intestine be inverted and slightly pressed, it can readily be seen to pass into the villi of the intestinal mucous membrane. In the stomach, however, the absorbents have a different arrangement. When minutely injected with mercury, they are seen to pass through the external coats, dividing into smaller and smaller branches, without any appearance of a net-work between the muscular and the villous coat, so that the absorbent vessels of the stomach manifestly exhibit a different arrangement from those of the intestine.

By adopting a similar mode of injecting from trunk to branch, Dr. Monro succeeded in demonstrating numberless lymphatics in the brain, eye, ear, and nose, in all of which organs their existence had been previously doubted; and, also, in proving that their ramifications in the rest of the body were far more extensive than had been supposed. He, moreover, points out another circumstance of considerable importance in a physiological point of view, viz., that on examining the minute branches of the lymphatics, they are found to consist of an immense number of anastomosing canals, many of which enter the neighbouring lymphatics at right angles instead of being directed towards the heart, by which means a net-work is produced so very intricate that, when a small portion only is examined, it is difficult or next to impossible to ascertain what has been the natural course of the lymph; it is therefore evident that, from the great number and unfavourable direction of these canals, general pressure cannot in this case be a chief cause of the progressive motion of the lymph, but that each vessel must contribute to its progress by a well-regulated action.

Another remarkable circumstance is stated by Monro in connection with the lymphatic vessels, namely, that in the Skate they open by patulous orifices situated upon the back of the Fish, of sufficient size to allow not only air, but water, milk, quicksilver, and even oil of turpentine coloured with vermilion, to be discharged upon the surface of the skin, even when the force employed in injecting these fluids was very slight, and no extravasation was produced into the cellular tissue either under the skin or in the muscular interstices. The function attributed to these open vessels by Monro is, however, even if they exist, quite hypothetical, namely, that they are for the purpose of absorbing from the ocean the fluid

* Phil. Trans. for 1769.

which is interposed between the skull and the surface of the brain.

Organs of respiration.—The respiration of Fishes is purely aquatic, the oxygenation of the blood being accomplished throughout the entire class by its exposure to the oxygen dissolved in the surrounding medium as it passes through the network of extremely minute vessels that is spread out over the extensive surfaces furnished by the gills or branchiæ.

These organs consist of vascular fringes or laminae placed on each side of the neck, over which, in the great majority of species, the water taken in at the mouth is made to pass as it issues through the opercular cavities; and in this way the branchial surfaces, being perpetually bathed with aerated water, perform the same office as the lungs of an air-breathing animal.

But while respiration is thus accomplished throughout the whole class by means that are essentially similar, there are several modifications in the mechanical arrangement of the respiratory apparatus, each of which will demand our especial notice.

Throughout all the extensive division of osseous Fishes (with the exception of the *Lophobranchii*) the construction of the breathing organs will be found to accord with the following general description. To the external convex surface of each of the four branchial arches (*fig. 522*) is attached a double series of flat, elongated, cartilaginous laminae, tapering gradually towards their extremities, the whole forming a crescent-shaped pectiniform framework, over which is spread the highly vascular membrane that constitutes the respiratory surface. On making a transverse section of the gill it is found that towards their base, whereby they become attached to the branchial arch (*fig. 520, b*), the two series of branchial laminae are united to each other, and, moreover, the structure of each leaflet of the branchia becomes apparent. The branchial artery (*c*), whereby the blood is brought to the gills for the purpose of respiration, is seen running along the convexity of the supporting arch in the middle of the base of the branchial laminae opposite each pair, of which it gives off two branches, which pass outwards to the end of the substance which unites the two layers of gills at their bases, and then severally subdivide, one of the ramuli extending along the internal margin of each branchial lamina to its extremity, the other retrograding to its base. From these two ramuli minute transverse vessels are given off, which distribute the blood over the general surface of the laminae, and ultimately form the branchial veins, from which the systemic artery is continued. Besides the respiratory laminae the branchial arches support a series of unvascular processes, which project from their concave margins, and serve to prevent substances taken into the mouth from escaping through the branchial fissures and thus getting among the gills; these processes in the Mullet (*Mugil chelo*) are extremely beautiful, forming long and delicate fringes along the concavity

of each branchial

Fig. 520.

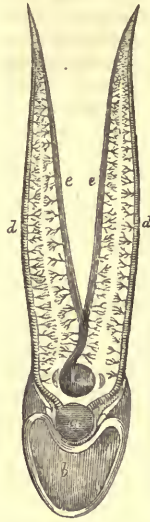

Diagram of the circulation of the blood through the branchial leaflets.

b, section of branchial arch; *a*, branchial artery; *c*, branchial vein; *d, d, e, e*, the arterial and venous trunks derived from them.

In such genera as have this external opening very large and patulous, as it is, for example, in the Herrings and numerous other races, the death of the fish ensues almost immediately on its removal from its native element, not so much on account of a deficiency of oxygen wherewith to aerate the blood in the branchiæ, seeing that that might be derived from the atmosphere, but because the gills, being no longer floated out, collapse, and thus, by preventing the passage of blood through the delicate vessels which ramify over the branchial laminae, put a stop to the circulation as completely as strangulation could do; but in some genera a provision is made to permit of a more lengthened existence out of the water where the habits of the fish render such an arrangement necessary. In the whole tribe of Eels, for example, the external fissure is removed very far back and reduced to a very small vertical slit, converting the cavity wherein the branchiæ are lodged into an elongated chamber, wherein a considerable quantity of water can be retained: in such Fishes, therefore, the circulation of the blood is by no means put a stop to by taking the fish out of the fluid it usually inhabits, but, on the contrary, many species can exist for a considerable length of time in the air, and even make their way to a distance from their native ponds, the water

adapted to bar the passage of minute or finely comminuted food through the branchial interspaces. These internal unvascular appendages to the branchial arches act, therefore, the same part as the epiglottis of mammiferous animals. Frequently there are likewise tubercular projections from the contiguous margins of the concave surfaces of the branchial arches, for the purpose of preventing the gills from becoming too closely approximated to each other, and thus interfering with the free circulation of the blood over their surfaces.

The mechanism of the respiratory process is, therefore, in these osseous Fishes exceedingly simple. The water which is constantly taken into the mouth passes through the branchial fissures, and is forcibly driven by the simultaneous action of the branchial arches of the os hyoides, of the palatotemporal flaps, and of the opercula, through the interspaces of the gills, and thus passes out through the wide fissure upon the side of the neck beneath the branchiostegous membrane.

so retained in contact with the branchiæ continually absorbing from the air a sufficiency of oxygen to carry on the respiratory process.

An important group of Fishes (the "*Pharyngiens labyrinthiformes*" of Cuv.) are characterized by a very peculiar formation of the anterior superior pharyngeal bones, which enables them to live out of the water for a considerable length of time, so that many of them, as we are assured by authors, not unfrequently come on dry land, and even, as in the case of the *Anabus scandens*, or climbing Perch, mount into trees, a faculty for which they are indebted to the following remarkable conformation.

Their inferior pharyngeals and the posterior of their superior pharyngeal bones present the usual arrangement and are studded with teeth, but the two anterior pharyngeals on each side are spread out into thin laminae folded upon themselves in divers ways, so as to form a light complicated mass, (which Cuvier* compares to a curly cabbage, or to certain forms of laminated eschars and millepores,) over which numerous vessels are distributed, but whether derived from the branchial artery or the aorta remains uncertain. In order to lodge these singular cellular organs the head is considerably dilated in breadth, and with the same intention the cranium is produced upwards by a vertical crest so as to increase the height of the lateral chambers in which the foliaceous masses are lodged. Externally, each of these chambers is partially covered by the bones of the cranium and by the opercular pieces; and when the operculum is raised, a membrane is seen to be tightly expanded between it and the opercular bone so as to enclose the cavity, leaving only a small aperture of communication with the exterior, which leads equally to the labyrinthiform apparatus and the branchial chamber. This bony labyrinth, therefore, so carefully enclosed on all sides, and which receives water equally with the branchiæ whenever the fish opens its mouth, will retain the water so taken in between its lamellæ wherewith to moisten the branchiæ for a considerable length of time, so that the fish may live for hours or perhaps even for days out of the water.

The *Lophobranchii* form a remarkable group, distinguished from all other races of osseous Fishes by the peculiar structure of their branchial organs. In these, called from their peculiar shapes and external armour "pipe-fishes," (*Syngnathus*, *Hippocampus*, &c.) the vascular fringes appended to the branchial arches, instead of consisting of lamellæ arranged in a pectinated form, are collected into tufts arranged in a double series along the convexity of each branchial arch. The essential character of these tufts varies, however, in no respect from that of gills of the ordinary construction, and in like manner the water passes from the mouth through five apertures leading from the pharynx into the branchial chamber, whence,

after bating the tufted gills, it escapes through a single small opercular fissure.

The Sturgeons (*Sturionidæ*), which in many points of their economy seem intermediate between the osseous and cartilaginous Fishes, resemble the former in the disposition of their organs of respiration. The gills of the Sturgeon are constructed precisely in the same manner as in ordinary osseous Fishes, only differing in some respects as to form, the branchial arches being more bent and the vascular laminae united for a greater extent; the respired water, moreover, escapes in like manner through a single opercular slit.

In the Plagiostome cartilaginous Fishes ("Chondropterygii à branchies fixés," Cuv.) the mechanical arrangement of the branchial organs presents very important modifications, the water which passes from the mouth over the gills no longer escaping through an opercular opening, but being expelled through five distinct orifices situated on each side of the body. In the *Sharks* and *Rays* the condition of the breathing organs is essentially similar, so that the same description will apply to both. The four branchial arches in these Fishes are of a soft cartilaginous consistence, and instead of hanging free in the branchial chamber as they do in the osseous genera, stretch quite across that cavity to have their external margins fixed to its outer walls, thus dividing it like so many bulk-heads into five distinct compartments, which have no communication with each other. A wide branchial fissure admits water from the pharynx into each of these compartments, which after passing over the gills is expelled by as many orifices situated upon the exterior of the body, the external openings being situated upon the sides of the throat in the *Squalidæ* (fig. 506, q, q, q), but in the *Skates*, in consequence of the lateral extension of the body, they are placed upon the ventral surface. The gills themselves are broad vascular membranes spread out over the opposite faces of each cartilaginous septum, so that every compartment of the branchial chamber has its walls tapetried with a respiratory surface, and forms a kind of bag lined with innumerable blood-vessels, through which the water must pass in its course from the mouth to the external openings upon the sides of the neck.

The branchial membrane which thus covers the opposed walls that bound the respective cavities into which the gill-chamber is divided, is entirely made up of numerous plicated, vascular lamellæ, each of which is gathered into close-set transverse folds sustaining the minute ramifications of the branchial vessels; and these again may be observed with a lens to be in like manner transversely plicated, thus presenting in the aggregate a surface of vast extent to the influence of the respiratory currents. In the anterior branchia the vascular layer is of course affixed only to the posterior surface of the supporting membrane, the opposite side being supported by cartilaginous rays.*

* Hist. des Poissons, tom. 8.

* Monro makes the following calculation rela-

In the Sharks the orifices of the pharynx leading into the branchial chambers are guarded by cartilaginous pyramidal processes; but in the Skates, which have the cartilaginous arches much less perfectly formed, no such defences are visible.

The Cyclostomatous cartilaginous Fishes, from the peculiarities of their habits, require another modification in the construction of the organs of respiration, seeing that, whilst they rest fixed by their suction mouths to the surfaces of stones or other foreign bodies, or while they are compelled to remain with their heads deeply plunged into the flesh of the prey upon which they live, the admission of water into the mouth and its subsequent expulsion through pharyngeal fissures would, in their case, be impracticable.

In the Myxine or Hag-fish the branchial apparatus presents externally seven round holes placed in a line along each side of the neck, and situated very far back in comparison with the usual situation of the gill-openings. Each of the seven lateral openings leads internally into a flattened circular cavity, which likewise communicates by a special canal with the interior of the pharynx. When opened, each gill-sac is found to have its lining vascular membrane gathered into closely set folds, which in turn exhibit, when accurately examined, smaller plicæ, and thus a great superficial extent of respiratory membrane is secured, much in the same manner as in the case of the *Raïde*; indeed, the general disposition of the whole apparatus is essentially similar in the two groups, the great difference being that whereas in the plagiostome genera the water passes in at the mouth and out at the gills, in the Cyclostomata it alternately passes in and out through the same orifices by a mechanism which is best exhibited in the Lampreys (*Petromyzon*).

In the last mentioned genus of Cyclostomatous Fishes, the seven holes which lead to the breathing organs are seen, on removing the skin, to be supported by a curiously contorted framework of cartilaginous pieces, which we have already noticed as being the exaggerated representatives of the sternal ribs met with in the Sharks, and which we shall subsequently see in a much more highly developed condi-

tion in Branchiostoma. These form a kind of elastic thorax around the region of the body where the branchiæ are situated, which is made to perform alternate movements of contraction and dilatation, whereby the water is perpetually sucked in and again expelled through the external openings (*fig. 521, i, i*). The branchiæ themselves (*h, h*) present nearly the same structure as in the Myxine, consisting of as many distinct

Fig. 521.

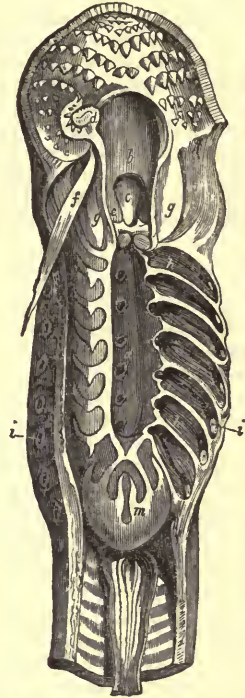
Respiratory apparatus of the Lamprey (*Petromyzon*).

a, mouth with its teeth; *b*, pharynx; *c*, opening of tube from the back of the head; *d*, cavity communicating with the respiratory sacculi of both sides; *e*, commencement of œsophagus; *f*, cartilaginous process connected with hyoid tooth, likewise marked *d*; *g*, muscles of sucking disc; *h, h*, respiratory cavities and branchiæ contained therein; *i, i*, external openings of do.; *m*, cartilaginous sac investing the pericardium.

tive to the extent of the respiratory surface presented by the gills of Fishes to the action of the surrounding medium. On each side of the body of a *Skate*, says he, there are four double gills, or gills with two sides each, and one single gill; or there are in all eighteen sides or surfaces on which the branchial artery is spread out. On each of these sides there are about fifty divisions or doublings of the membrane of the gills. Each division has on each side of it 160 subdivisions, doublings, or folds of its membrane, the length of each of which in a very large skate is about one-eighth of an inch, and its breadth about one-sixteenth of an inch, so that in the whole gills there are 144,000 subdivisions or folds, the two sides of each of which are equal to the 64th part of a square inch, or the surface of the whole gills in a large skate is equal to 2.250 square inches, that is, to 15 square feet, an expanse equal to the whole external surface of the human body.—Structure and Physiology of Fishes, p. 15.

sacculi as there are external openings, ranged along the sides of the neck, each sacculus having its vascular lining membrane finely plicated in order to increase the extent of surface to be exposed to the respired element. Every branchial sacculus, in addition to its communication with the exterior through the lateral openings of the neck, has a passage that leads into the pharynx (*d*), so that by the intervention of the pharyngeal cavity the respiratory sacculi of the opposite sides of the body are made to communicate with each other, an arrangement which explains the circumstance, that when the breathing holes of one side of the Lamprey are kept above water, the respired fluid which enters the submerged orifices, after traversing the pharynx, fills the branchial chambers of the opposite side, and is forcibly ejected therefrom

through the exposed apertures. There is, moreover, another remarkable arrangement in the Lampreys, whereby, notwithstanding the suctional character of their mouths, the members of this genus have the character of their respiratory apparatus approximated to that of other races of Fishes. This consists in the presence of a small tubular orifice situated in the middle of the back of the head, just in front of the eyes, which leads downwards into the pharynx (*b*), into which it opens by the orifice *c*, so that water can enter by this passage while the mouth is kept immovably fixed to the surface whereunto the Lamprey has attached itself.

The respiratory system of *Branchiostoma* is highly curious in its arrangement. It may be said to consist of two portions, a hyoid apparatus of a very remarkable kind, and a respiratory or branchial sac enclosed by a series of thoracic ribs, both of which will require a particular description before we proceed further with this part of our subject.

Hyoid apparatus.—The hyoid apparatus supports the mouth and guards its entrance, the oral aperture, which is in the form of a longitudinal slit, being bounded on each side by a series of hyoid cartilages, each of which consists of several pieces articulated together so as to form a continuous chain, which gradually diminishes in thickness towards its anterior extremity. To every one of these pieces is attached a cartilaginous arch composed of two cartilaginous stems, which are armed with delicate denticulations, and covered with a fine membrane, which is extended along the base of the posterior ones like a thin interdigital web, which forms the margin of the mouth.

Branchial cavity.—This is situated behind the hyoid apparatus, and consists of a kind of thorax composed of upwards of a hundred transparent, cartilaginous, and hair-like arches, the upper extremities of which are fixed in two streaks of a soft white substance, which runs along on each side of the inferior surface of the chorda dorsalis on the sides of the inferior longitudinal ligament. The inferior extremities of the ribs terminate in a more complicated manner. Each alternate rib bifurcates. The inferior branch on each side meets its fellow of the opposite side at an angle in the median line, while the superior branch likewise curves up and meets the corresponding division of its opposite, while the non-bifurcated ribs, which are shorter, terminate in a line with the bifurcation of the neighbouring pairs. There are, moreover, slender cross pieces joining the neighbouring ribs together, disposed in an alternating series like the joinings of stones in masonry. The heart is situated at the posterior extremity of the branchial sac between its posterior extremity and the commencement of the liver; it consists, according to Costa, of two delicate cavities situated transversely above and a little to the right of the intestine. These cavities (“orecchiette”) communicate, and the blood passes from one to the other, being driven forward by rapid pulsations. From the second cavity of the heart the blood is driven into the trunk of the bran-

chial artery, which is situated between the intestine and the point of attachment between the branchial ribs and the spinal column. The course of the blood is at first rapid and very distinct, owing to the size of the branchial artery being considerable; but as it runs forwards, it expends itself in numerous spiral vessels, which, accompanying all the thoracic arches and their transverse attachments, thus present a considerable surface and constitute the branchiæ of the fish. Finally, towards the anterior extremity of the respiratory cavity the branchial artery has become so much reduced in size as to be no longer distinguishable.

In addition to the extensive surface furnished by the respiratory sac there are three vascular lamellæ situated on each side of the fauces, to which Costa applies the name of opercular branchiæ, believing them to be analogous to the branchiæ attached to the opercula of the Sturgeon and other Fishes; these receive their supply of blood from an arterial trunk that surrounds the back part of the roof of the mouth.

Heart.—The heart of Fishes (*fig. 522, C, A*) is situated beneath the throat immediately behind the inferior terminations of the branchial arches, where it is lodged in a compartment partitioned off from the cavity of the abdomen by a strong tendinous septum, which forms a sort of immovable diaphragm. In the Lampreys the heart is moreover encased in a cartilaginous capsule (*fig. 521, m*) formed by the posterior portion of the cartilaginous frame-work that surrounds the branchial apparatus.

In the course of the circulation the heart of Fishes is interposed between the systemic veins and the organs of respiration, its office being to propel the venous blood received through the venæ cavæ into the gills, whence it is conveyed by the arterial system to be distributed to the body without the intervention of any contractile cavity devoted to its propulsion through the arterial trunks. For a diagram of the course of the circulation in Fishes the reader is referred to *fig. 319, vol. i.*

The heart of a fish is therefore at once distinguishable from that of any other vertebrate animal by the circumstance of its consisting of only two cavities, an auricle and a ventricle, the former of which receives the blood from the body, while the latter diffuses it over the branchial surfaces. The auricle (*fig. 522, C*) is very capacious, having its walls made up of intercrossing muscular fibres, which from their frequent decussations present internally a reticulate appearance. It receives the venous blood from a sinus (*D*), formed by the conjoined cavæ through a single orifice, which is guarded by two large semilunar valves, arranged so as to prevent the reflux of blood into the veins.

The ventricle is considerably smaller than the auricular cavity, with which it communicates by a wide lateral orifice. Its shape in the osseous Fishes is most usually somewhat four-sided, and its muscular walls, considerably thicker than those of the auricle, present internally a strong fasciculated appearance. The auriculo-ventricular opening is generally guarded by two strong valves ordinarily of a semilunar

shape, but sometimes, as for example in the Sturgeon, resembling the tricuspid valve of the heart in Mammalia, having chordæ tendinæ passing from its margin to the muscular walls of the ventricle.

In other cases again, as in the *Sun-fish* (*Orthogoriscus Mola*), the auricular aperture is guarded by four valves, two small semilunar valves being placed at right angles with and on the auricular side of the two large semilunar valves that usually exist in this situation.

The branchial artery (*fig. 522, B*) which arises from the ventricle is very different in character from an artery of ordinary appearance, its walls being exceedingly thick and muscular, and frequently fasciculated internally; its cavity is moreover dilated so as sometimes to equal in capacity that of the ventricle itself. This dilated portion of the branchial artery, to which the name of

Fig. 522.

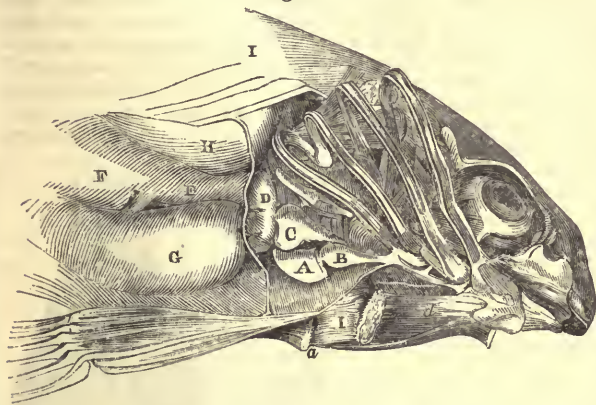

Heart and principal vessels of Perch.

bulbus arteriosus has been given, is in fact almost equivalent to a second ventricular chamber, and doubtless by its contractile power forcibly assists in propelling the blood through the gills.

The origin of the *bulbus arteriosus* is always guarded by strong valves, of which there are frequently only two of a semilunar form, but occasionally the valve is made up of four semilunar membranous folds.

But it is not only at the commencement of the *bulbus arteriosus* that valves exist, these defences being frequently multiplied in this portion of the circulating system of Fishes in a very extraordinary manner. Thus, in the Sturgeon there are three series of semilunar valves, two at the commencement and one at the termination of the bulb, the last being the strongest and most perfectly formed. Those at the base are much thickened at their margins, which are attached to the parietes of the bulb by small chordæ tendinæ. The two lower valves are each made up of four semilunar folds, whilst in the upper one there are five. In the Skate (*Raia Batis*) there are five distinct sets of valves, increasing in size to the last row, which is at the termination of the bulb.

The most probable reason of this unusual

fortification of the valvular apparatus of the branchial artery in Fishes is that, owing to the depth to which some of them descend or at which many races dwell habitually, as for example, the ground-frequenting Skates, the pressure upon the surface of the gills must render the passage of the blood over the branchiæ very difficult, so that unusual care has been taken in strengthening the *bulbus arteriosus* itself, and likewise the valvular structures in its interior.

The *bulbus arteriosus* ultimately resolves itself into the branchial artery, which gives off the trunks that supply the venous blood to the gills.

Vascular system.—The general course of the blood during its circuit through the body of a fish has been already described in a preceding article (see CIRCULATION); we shall therefore limit ourselves in this place to describe the dis-

position of the principal vascular trunks, and the manner in which the circulating fluid is distributed to different parts of the system. The vessels formed by the division of the branchial artery run in a deep groove along the convexity of each branchial arch external to the branchial vein, which runs in the same groove, taking an opposite course. The branchial vein, as we have already seen, is formed by collecting all the venules from the branchial laminae of the corresponding gill, and thus carries only the blood which has undergone the process of respiration. The branchial artery and the branchial vein are therefore

placed under precisely inverse circumstances with respect to each other; the former diminishing continually in size as it mounts upwards towards the dorsal aspect of the gills by giving off arterioles to the branchial laminae; the latter increasing in bulk as it proceeds in the same direction, owing to the constant accession of little veins derived from the fringes of the gills. In the Skates there are two branchial veins to each gill, which, however, ultimately become united into one trunk.

No sooner do the branchial veins issue from the dorsal extremities of the branchial arches than they assume the texture and the function of arteries, and ultimately all joining with each other and with those of the opposite side, they constitute by their union the aorta, by which the blood is distributed to the general system. Before their union into a single aortic trunk there are arterial vessels given off from the branchial veins themselves; thus the anterior give off, even before they leave the branchial arch, several vessels to supply the head and adjacent parts, while the heart itself and the neighbouring region beneath the throat likewise receive their supply of arterial blood through a twig derived immediately from a branchial vein.

The aorta, formed, as has been stated, by the union of all the branchial veins without the inter-

Fig. 523.

*Lepidosiren.*

position of any contractile organs corresponding with the left side of the heart of Mammalia, immediately proceeds to give off branches to the trunk and abdominal viscera. Almost close to its commencement it sends into the abdomen the large visceral trunk, which supplies all the abdominal viscera with blood, being distributed to the liver, to the stomach, to the intestines, to the spleen, to the generative organs, and to the swimming bladder.

After giving off the above large visceral artery, the aorta continues its course backwards beneath the bodies of the supra-abdominal vertebræ; but as soon as it reaches the post-abdominal vertebræ, it enters the canal formed by their inferior arches (*hæmapophyses*), through which it passes backwards to the tail. During its passage through the abdomen the aorta furnishes arteries right and left to the kidneys, between which it lies; but with this exception all its branches, which are given off opposite each vertebræ like the intercostal arteries of the human subject, are distributed to the muscles of the trunk.

Venous system.—All the arteries given off from the aorta are accompanied by corresponding venous branches, through which the blood is returned into two large veins, one above and the other beneath the vertebral column. The former running with the spinal cord in the superior vertebral canal, the other being in contact with the aorta through its whole length, these great veins frequently intercommunicate by means of inosculating branches, and the inferior one ultimately terminates in the great venous sinus that opens into the auricle of the heart. This sinus likewise receives through several different trunks the veins from the liver, from the generative organs, from the kidneys, from the pectoral and ventral fins, from the branchial organs and other parts of the throat, and likewise from the head, the blood derived from the head having been previously collected in a large sinus.

The highest form of the respiratory and circulatory apparatus met with in Fishes is found in the *Lepidosiren*, a remarkable genus found in the river Amazon and in the Gambia.* In this interesting creature the gills of the fish are combined with rudimentary air-sacs which perform the office of lungs, and, in fact, the whole arrangement of its circulatory system approximates so nearly that of the amphibious reptiles that, were it not for its otherwise completely ichthyic characters, it might almost be regarded

* Professor Owen, Description of *Lepidosiren annectens*. Trans. of Linnean Society, vol. xviii.

as belonging to that order of Reptilia with which it forms an interesting link of connection. The branchiæ of the *Lepidosiren* consist of separate elongated filaments attached by one extremity to the branchial arches, which are four in number. These cartilaginous branchial arches are developed on each side in the sub-mucous tissue, and are not attached either to the os hyoides below or to the cranium above. The membrane covering the third, fourth, and fifth arches is minutely papillose, while the margins of the first and second are finely denticulated, and between these are five branchial apertures, or interspaces, through which bristles are represented as passing in the accompanying figure, (fig. 524, 1, 2, 3, 4, 5.)

The gills do not form any external projection as in the gill-bearing Perennibranchian Amphibia, but are contained in a moderately capacious branchial chamber, the parietes of which are formed by a mucous and muscular stratum, the external outlet being a vertical slit situated immediately anterior to the filamentary pectoral limb.

“Thus,” observes Professor Owen, “although the organs of respiration through the medium of water correspond in all essential points with those of the true fishes, yet the gills approximate in their filamentary form to those of the Perennibranchiate Reptiles. And again, although the gills are four in number on each side, as in the osseous fishes, yet the number of branchial apertures and arches corresponds with that which characterizes the higher cartilaginous fishes. So that, while we perceive, even in the organs for breathing water, a ten-

Fig. 524.



Respiratory organs of *Lepidosiren annectens*. After Owen.

a, first lobe of the tongue; b, second lobe of the tongue; c, pharynx; d, pharyngeal valve; e, opening of larynx; f, laryngeal or thyroid cartilage; 1, 2, 3, 4, 5, interspaces between branchial arches.

endency towards the amphibious type, we find at the same time that the branchial as well as the osseous system manifests a most interesting transitional structure between the plagiosotomous and osseous fishes. We have next to consider that part of the respiratory system which is organized for breathing immediately the atmospheric air, or the lungs; for I do not know how otherwise to designate, according either to their physiological or morphological relations, those organs which in the technical language of the ichthyologist would be termed the swimming or air-bladder. The trachea, or to use the same technical and partial nomenclature, the "ductus pneumaticus," is a wide short membranous tube, as in the Perennibranchiate Reptiles. The glottis (*fig. 524, c*), opens near the posterior part of a long rudimental thyroid cartilage (*f*): a few lines posterior to the *isthmus faucium* the opposite end of the trachea dilates into a membranous sac, which communicates by two large lateral apertures with the lungs. These are widest at their anterior extremities, and gradually decrease in diameter to the cloaca, behind which they terminate each

Fig. 525.



Respiratory and circulatory apparatus of Lepidosiren annectens, after Owen.

a, auricle; *b*, ventricle laid open to show the termination of the vena pulmonalis, in which a black bristle is placed; *c*, bulbus arteriosus laid open; *d*, pericardium; *e*, vena cava abdominalis; *f*, vena pulmonalis; 1, 2, 3, 4, 5, 6, branchial arteries of left side; *m*, pulmonary artery; *n*, pulmonary vein.

in an obtuse point (*fig. 525*). They are lodged in the dorsal angle of the abdominal cavity behind the kidneys, and are attached by cellular tissue to all the surrounding parts, and especially to the ribs, of which they bear the impressions on their posterior surface. The an-

terior part of each lung is divided into four or five small lobes, behind which it takes on the form of a simple compressed bag, and so continues to its posterior extremity. The parietes of the lung present a moderate thickness throughout, and the whole of the internal surface is cellular, the cells having the same proportional size and form as in the respiratory portion of the lung of a serpent. The cells are largest and most subdivided at the anterior part of the lung, the livid colour of which, in the specimen dissected" by Professor Owen, "attested the great vascularity of the part."

In tracing the arrangement of the circulatory system of the *Lepidosiren* the same intermediate type of structure is most interestingly conspicuous. The heart consists of an auricle, (*fig. 525, a*), ventricle, (*b*), and a bulbus arteriosus. The vena cava (*e*) terminates in the right side of the auricle; it is joined by the two superior cavæ and by the single large pulmonary vein; this vein (*f*) does not, however, communicate with the sinus, but passes along entire and adherent to the inner surface of the vena cava as far as the auriculo-ventricular aperture, where it empties its contents into the ventricle by a distinct orifice protected by a cartilaginous valvular tubercle. It needed only that the pulmonary vein should have been dilated before its termination, in order to have established a bi-auricular structure of the heart, as in the *Amphibious Siren*. The same functional advantage is, however, thus secured to the *Lepidosiren* with a maintenance of the simple dicæalous type of the heart of the fish; this continuation of the pulmonary vein preventing the admixture of the respired with the venous blood, until both have arrived in the ventricle.

The ventricle (*fig. 525, b*) is extremely small; its parietes are thick and reticularly muscular; a small round orifice leads to the bulbus arteriosus (*c*). This is formed by a short spiral turn of the dilated aorta, which is concealed under a simple continuous fibrous coat. The area of this part of the vessel is almost entirely occupied by two continuous valvular projections or their processes, which are attached by one edge to the internal surface of the aorta, and have the opposite margin projecting freely into the arterial cavity.

The aorta in this remarkable species fulfils at once the office of a systemic, a branchial, and a pulmonary artery; it distributes on each side six vessels, (*fig. 525, 1, 2, 3, 4, 5, 6*), corresponding to the six branchial cartilaginous arches. The mucous membrane is produced into a branchial fringe on the convex side of the first, fourth, fifth, and sixth branchial arches, and the corresponding arteries are minutely subdivided before they are continued to the dorsal side of the pharynx; these four pairs of vessels are therefore true or functional branchial arteries. The mucous membrane merely invests with a simple fold the second and third branchial arches; and the corresponding arterial trunks undergo no subdivision as they wind round them, but are continued entire (as in the *Amphiuma* and *Menopoma*) to their termina-

tion at the opposite side of the vascular circle. The branches which afterwards unite to form the single pulmonary artery on each side are given off from near the termination of the second and third pairs of the primitive aortic trunk, which thus combine the functions of both systemic and pulmonary arteries. The pulmonary artery, formed by the union of the branches from the second and third branchial arteries, descends between the vena cava (*fig.* 525, *e*) in front, and the left branch of the vena pulmonalis (*f*) behind to the interspace to the lungs; here it distributes branches to the anterior lobes, and then divides; each division extends along the mesial side of its corresponding lung to the extremity. The blood distributed by the capillaries of this artery over the cells of the lung is collected into a vein (*n*) which returns along the lateral or outer margin of the lung as far as the commencement of the lobulated part; here it crosses obliquely the anterior surface of the lung and unites with its fellow. The common pulmonary vein runs parallel with and behind the vena cava for a few lines, then obliquely pierces the pericardium, and enters the sinus formed by the expansion of the vena cava, and continues attached to the parietes of that sinus till it reaches the auriculo-ventricular aperture, where it terminates close behind the cartilaginous knob before mentioned.*

Portal system of veins.—All the blood derived from the stomach, from the intestines, and from the spleen, is collected into one or sometimes into several trunks, which convey it into the liver for the elaboration of bile precisely as in other races of Vertebrata. In some genera, however, more especially the *Cyprinidæ*, the lobes of the liver are so interwoven with the intestinal folds, that the venous blood from the intestines enters the liver through innumerable small branches, none of which are of sufficient size to be regarded as a main trunk of the portal vein. Rathke,† indeed, observes, in relation to this subject, that the vena portæ of Fishes exhibits a kind of transition in its arrangement, a sort of tendency to perfection indicated by progressive concentration of the venous trunks according to the following scale:—As an improvement upon the portal system of the *Cyprinidæ*, in *Cottus scorpio* all the veins bringing the blood from the abdominal viscera form three principal trunks, which enter the liver separately. In *Cobitis fossilis* most of these veins are found united into two trunks, which penetrate the liver separately; but besides these there are some straggling branches which keep themselves independent of the two great veins. In the *Blenny* and the *Pike* there are only two portal trunks. In the *Lump-fish*, the *Shad*, &c., the two trunks are united into one; but there are still small veins which run isolatedly into the substance of the liver; and lastly, in the *Eel*, the *Perch*, &c., there is only one vena portæ, as in the most highly organized vertebrate animals.

There is a remarkable circumstance connected with the great venous trunk above alluded to which accompanies the spinal cord lodged in the superior vertebral canal, for this vein, although it receives a good proportion of the blood derived from the muscles of the upper part of the trunk, does not empty itself into the venous sinus of the heart, and, from the circumstance of its giving off numerous large branches to the substance of the kidney, has been regarded as forming a renal portal system, similar to that described by Jacobson as existing in Birds. It must, however, be observed that this superior vein communicates very freely with the inferior vein, which indubitably represents the vena cava inferior, and consequently the renal branches may be derived from, and not distributed to, the kidney.

Lateral system of vessels.—Dr. Marshall Hall discovered some years ago a pulsating cavity or heart situated near the caudal extremity of the vertebral column of the *Eel*, the contractions of which were found to be quite independent of the pulsations of the branchial heart, this organ beating 160 times in a minute, while the pulses of the branchial heart were only 60. This structure, the existence of which only was pointed out by Dr. Marshall Hall, has since been carefully investigated by M. Hyrtl,* and the following is the result of that gentleman's explorations. The organ in question is easily seen by stretching out the tail of an *Eel* upon a piece of glass, to which it readily adheres owing to the viscid secretion furnished by the skin. Its pulsations are very lively, and it seems surrounded by a transparent areola, which appeared to M. Hyrtl to consist of two sacs. The disorganization of the spinal marrow by means of a wire had no effect upon the number of its pulsations, and even when the branchial heart was tied or the animal cut in two, the caudal heart continued to beat for five or six minutes. The genera in which the caudal heart and the apparatus connected with it were examined, were *Accipenser*, *Salmo*, *Perca*, *Abramis*, *Leuciscus*, *Gadus*, *Gobio*, *Silurus*, *Esor*, *Cyprinus*, *Zeus*, *Lophius*, and several others, so that doubtless the system under consideration is common to the whole class of Fishes.

Brain.—The encephalon of Fishes is remarkable for its diminutive size in proportion to the dimensions of the animal, and also with relation to the nerves which are derived from it; in fact it occupies but a very small portion of the cavity of the cranium, the wide interval existing between its surface and the dura mater that lines the cranial parietes being filled up with loose cellulosity filled with fluid, and sometimes containing abundance of oil, or in certain instances, as for example in the *Sturgeon* and *Tunny*, of a compact and fatty substance.

It has been remarked that this interval between the cranium and the surface of the brain is much less in young subjects than in adults—a

* See Professor Owen's paper, *ubi supra*.

† *Annales des Sciences Nat.* tom. ix. p. 170.

* *Archiv. für Anat. Phys. und Wissenschaftliche Medicin* herausgegeben von J. Müller. 1843. p. 124.

circumstance which proves that their brain does not grow in the same proportion as the rest of the body; indeed Cuvier found the dimensions of the brain nearly similar in individuals of the same species, though one might be double the size of the other.

Fig. 526.



Brain of Perch, upper surface. (After Cuvier.)

a, cerebellum; *b*, hollow (cerebral) lobes; *c*, olfactory lobes; other letters as in the two following figures.

The encephalon consists of a series of lobes situated one behind the other (fig. 526), concerning the precise analogies of which no two authors seem to be agreed. In the following account of its general structure we shall therefore closely adhere to Cuvier's masterly analysis of the organization of the brain of the *Perch*, at the same time, however, noticing the opinions of anatomists, and the principal variations, observable in other Fishes, from the form of brain selected for special description.

The anterior pair of lobes (figs. 526, 527, *c, c*) invariably give origin to the olfactory nerves, and consequently are very generally called the olfactory lobes of the brain. Their surface is most frequently smooth, but occasionally marked, as for example in the Cod, with slight sulci. Their relative size varies very much, but they are generally, but not always, smaller than the succeeding pair of lobes (*b, b*). They are connected with each other inferiorly by a commissure, which is sometimes double, and the internal fibres of the medulla oblongata may be distinctly traced into their substance.

In front of these olfactory lobes there are generally one and sometimes two pairs of ganglia (figs. 526, 527, 528, *i, i*) connected with the origins of the olfactory nerves, which, when very large, might be mistaken for additional lobes of the brain. They are, however, never connected by commissural fibres to their fellows of the opposite side, and the olfactory nerve can be traced along their under surface as far as the proper anterior lobes of the encephalon (*c, c*). Internally they frequently present a ventricular cavity, which communicates beneath the anterior commissure with that of the cerebral masses next to be described.

The second pair of cerebral lobes (figs. 526, 527, 528, *b, b*) are of an oval form, and are remarkable from the circumstance that they enclose a wide cavity or ventricle, whence they have been designated by some anatomists the *hollow lobes* (fig. 527, *b*). They consist, like the cerebral lobes of the higher Vertebrata, of two layers, which are generally easily separable; the outer layer consisting of grey or cineritious matter, the inner layer of the white or fibrous substance of the brain, the fibres of the latter running trans-

versely so as to line the roof of the ventricular cavity, which is common to both sides of the brain; for although the hollow lobes are united to each other superiorly along the median line so as to form a kind of corpus collosum with a median raphé, there is no septum between the two sides. The fibres lining the ventricular cavity seem to emerge from two semicircular bands of grey matter (fig. 527, *h, h*) situated upon the floor of the ventricle.

Fig. 527.

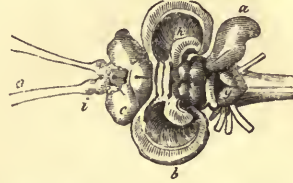

Brain of Perch, with the "hollow lobes" laid open, and the cerebellum turned to the right side. (After Cuvier.)

Letters *a, b, c*, as in last figure; *g*, supplementary cerebellic lobes; *h*, fibres lining the ventricular cavity.

At the bottom of the ventricular cavity there are likewise, in osseous Fishes, two or four tubercles of grey substance placed in front of the base of the cerebellum, and arching over the canal which leads from the large cavity contained in the hollow lobes into the ventricle behind the cerebellum, which it is impossible to consider as anything else but the representative of the fourth ventricle of the superior classes of animals, and the canal of communication as the "*iter a tertio ad quartum ventriculum*" of the human anatomist, the tubercles themselves being evidently the homologues of the *tubercula quadrigemina*.

The external fibres of the medulla oblongata are easily traceable into the lobes we are now considering, which, moreover, are connected with each other by a broad commissure exactly corresponding in situation with the anterior commissure of the human brain. There can, therefore, be no reasonable doubt that the "hollow lobes" of the Fish's brain represent the cerebral hemispheres of the encephalon of Reptiles, Birds, and Quadrupeds, and, with the data above given before us, it is not difficult to point out the analogies of the remaining parts not displayed in the figure. Thus, immediately behind the commissure is a passage leading into the cavity, which corresponds to the third ventricle, and which leads as usual to the infundibulum and towards the pituitary body that occupies its usual situation at the base of the brain.

The internal fibres of the medulla oblongata may be traced forwards into these hollow cerebral lobes, in which they spread out as in the higher animals.

At the inferior surface of the brain, beneath the "hollow lobes" just described, are two oval protuberances (fig. 528, *e, e*), which are designated by Cuvier the *inferior lobes*, between the anterior extremities of which is situated the

pituitary body (*f*). These inferior lobes are generally of considerable size, of an oval or kidney shape, and sometimes, but rarely, contain ventricular cavities, which communicate with the third ventricle, and through it with the great ventricles contained in the "hollow lobes;" they furnish fibres of origin to the optic nerves, and it is from the fissure between them and the medulla oblongata that the nerves of the third pair take their origin.

Fig. 528.



Brain of Perch, lower surface. (After Cuvier.)

Letters *a, b, c, g, h*, as in preceding figures; *e*, inferior lobes; *f*, pituitary body; *i*, swelling at commencement of olfactory nerve; *n*, optic nerves; *o*, olfactory; *p, q, r, s, t*, encephalic nerves.

The pituitary body (*fig. 528, f*) occupies its usual position on the base of the brain at the extremity of the infundibulum; it is generally of large size in Fishes, and is often connected with membranous and vascular appendages of various forms,—a circumstance which is, however, most remarkable in the cartilaginous Fishes. Occasionally, as for example in the Lophius and the Haddock, the infundibulum is prolonged into a slender filament, and the pituitary body is removed very far forward; but the uses of these parts are as problematical in Fishes as in the other classes of Vertebrata.

The cerebellum (*figs. 526, 527, a*) in osseous Fishes is of considerable size, but consists of the median portion only, no lateral lobes being as yet developed, or at least they are only indicated by slight eminences. Its shape is generally that of a blunted cone, the apex of which is bent backwards; but there are instances, as for example the Mackerel, in which it is directed forwards, and sometimes it extends so far forwards as to overlap all the rest of the encephalon. Owing to the deficiency of the lateral lobes of the cerebellum there are of course no traces of a *pons Varolii*.

Behind the cerebellum, on each side of the fourth ventricle, and sometimes even covering that cavity, are certain supplementary lobes (*fig. 527, g*) which would seem to be peculiar to Fishes, and which are very variable in their proportions, forms, and connections. In most osseous Fishes they consist of two protuberances or swellings of the sides of the medulla behind the cerebellum, which touch each other along the mesial line or are united by a commissure.

In the Cyprinidæ their volume is so considerable that they cover the greater part of the medulla oblongata, and their sides are furrowed with transverse striæ. In the Grey Mullet they are also very large, and their surface is marked with tortuous sulci, giving the appearance of cerebral convolutions. It is, however, in the Triglæ or Gurnards that these lobes are most largely developed, amounting in number to as

many as five on each side, and occupying a space equal in length to all the rest of the encephalon, and extending backwards as far as the second vertebra. It is from the last of these lobes that the second pair of spinal nerves is given off, which in this genus supplies the free rays situated in front of the pectoral fins.*

In the chondropteryginous Fishes the structure of the encephalon offers many remarkable peculiarities. Thus, in the Rays and Sharks the proportionate size of the olfactory lobes is enormous, and instead of simply having a commissural communication with each other, they are consolidated into one mass. The hemispheres enclose a capacious ventricle, but there are no distinct fibres visible upon its inner surface, neither are the representatives of the tubercula quadrigemina of osseous Fishes apparent. The cerebellum is of great relative size, but of very variable form in different species; and not unfrequently it is divided into laminæ by deep transverse sulci. The supplementary lobes behind the cerebellum are represented by folds or cords of nervous matter, which are prolonged from each side of the posterior edge of the base of the cerebellum and run backwards along the margin of the fourth ventricle.

The brain of the Tunny (*Thynnus vulg.* Cuv.) is remarkable for the extent of the cerebellum, and the complication of the internal tubercles. The olfactory nerves are small and oval. The hollow or cerebral lobes are of very great size, and nearly spherical, with a lateral fissure inferiorly. On opening them, instead of the tubercles generally met with in Fishes, there is found on each side a mass divided into three lobes, which are themselves grooved with a fissure, so that the whole resembles a cylinder or cord having six folds, twelve in all. The cerebellum is larger than the rest of the encephalon, and, arising from the medulla oblongata, curves forwards, overlaying both the hollow lobes and the olfactory lobes even as far as the anterior extremity of the latter, its breadth being little less than half its length. At the posterior part of its base there is on each side a rounded protuberance, different in character from those enlargements which are frequently met with in other Fishes at the commencement of the medulla oblongata.

Nervous system.—The olfactory nerves (*fig. 529*) arise from the olfactory lobes of the brain,

* The various names applied by different authors to the different parts described above are calculated to create great embarrassment and confusion. Thus, Haller in his 'Physiology,' and likewise in his 'Opera Minora,' calls the lobes (*c, c*) anterior olfactory tubercles, the lobes (*e, e*) inferior olfactory tubercles, the hollow lobes (*b, b*) optic thalamus, &c. M. Arasaki, in his thesis 'De cerebro et medulla spinali piscium,' calls the hollow lobes (*b, b*) tubercula quadrigemina, and regards the anterior lobes (*c, c*) as the representatives of the hemispheres. M. Weber, in his 'Anatomia comparata nervi sympathetici,' whilst he recognizes the hollow lobes (*b, b*) as the cerebral hemispheres, regards the cerebellum (*a*) as the analogue of the tubercula quadrigemina, and the supplementary lobes (*g, g*) at the commencement of the medulla oblongata as representing the cerebellum.

and vary much in their size and composition in different Fishes. For the most part they are simple, but sometimes double or triple; and occasionally they are composed of numerous filaments united into fasciculi. Generally they present a ganglionic enlargement just after their origin from the brain, or immediately before their termination in the olfactory organ, to the plicated folds of the lined membrane of which they are ultimately distributed.

2. The *optic nerves* (fig. 529, 2) arise from the second pair of the great cerebral masses, which from this circumstance have been called the optic lobes of the brain. Shortly after their origin the two nerves cross each other, but in the generality of osseous Fishes this is effected without any union of substance, the two nerves being simply united by cellular tissue (fig. 528, n). In the Skates, however, a commissure exists similar to that which is met with in the higher Vertebrata. In some Fishes each optic nerve consists of a broad flat nervous band folded upon itself like a fan, and enclosed in a tube of neurilemma derived from the dura mater; but in others their structure resembles that which exists generally in the higher animals.

3. The *third pair or motor oculi* (fig. 529, 3) arises from the medulla oblongata in the track of the pyramidal bodies, and is distributed, as in other Vertebrata, to all the muscles of the eye, with the exception of the superior oblique and external rectus. It likewise furnishes ciliary nerves, but no ophthalmic ganglion has yet been discovered in the class before us.

4. The *fourth pair* (fig. 529, 4) arises just behind the posterior point of the optic lobe from the roof of the ventricle, and terminates in the superior oblique muscle of the eye.

5. The *fifth pair of nerves* (fig. 529, 5) arises from the sides of the fourth ventricle near the base of the cerebellum. It issues from the cranium through a foramen in the great alar bone, and is distributed as follows:—1. It gives off an *ophthalmic branch* which runs along the roof of the orbit, and passing on towards the nose is distributed to the adjacent parts of the face as far as the snout and intermaxillary bone. 2. A *superior maxillary branch*, which passes under the eye to be distributed to the cheek and to the superior maxilla; it likewise sends a branch towards the nostrils and anastomoses with the pterygo-palatine nerve. 3. An *inferior maxillary branch*, which is frequently only a division of the preceding: this gives filaments to the posterior part of the palate, and passes on to the inferior maxilla and its dental canal. Frequently the palatine filaments proceed from a special branch. 4. A *pterygo-palatine branch*, which runs forwards, crossing the floor of the orbit beneath the muscles of the eyeball, follows the course of the vomer, and passes beneath this bone and the os palati to terminate at the end of the muzzle, where it is frequently joined by remarkable anastomoses with the superior maxillary branch. 5. An *opercular branch*, which passes through a canal in the os temporale and gives branches to the temporal muscle,

Fig. 529.



Brain and cerebral nerves of Cod fish (*Gadus morhua*). (After Swan.)

a, olfactory lobes; b, hollow or cerebral lobes; c, cerebellum; d, medulla oblongata; e, olfactory apparatus; f, eye-ball; g, superior oblique muscle; h, external rectus; the numbers 1, 2, 3, 4, &c., indicate the corresponding cerebral nerves.

to the cheek, to the muscles of the operculum, and to the operculum itself; it then penetrates internally to join with branches of the inferior maxillary divisions and to supply filaments to the branchiostegous membrane. 6. The fifth pair almost invariably gives off a branch which mounts to the upper part of the cranium, and joining a branch of the eighth pair issues

through a foramen formed by the parietal and interparietal bones, and runs along the whole length of the back on each side of the dorsal fins, receiving in its course filaments from all the spinal nerves, and giving off branches to the muscles and rays of the fins of the back. This branch is superficial up to the point where it plunges beneath the little external muscles of the fin-rays, and it sometimes gives off branches which are equally superficial, and that descend to the muscles of the trunk above the pectoral fins, and others which run backwards as far as the anal fin, where they form a longitudinal nerve resembling that of the back. Such is the general arrangement of this remarkable nerve, but it is by no means invariably so: thus, in the Carp it seems to proceed from the eighth pair, and not from the fifth. In the Silurus, on the contrary, it emanates from the fifth alone, while in the Perch, Cod, &c. it is derived, as has been described, equally from both these sources.

6. The *sixth pair* of nerves, or *abducens*, (*fig. 529, 6*) takes its origin, as in other Vertebrata, from the inferior surface of the medulla oblongata, and is entirely appropriated to the external rectus muscle of the eye.

7. The *seventh pair* of nerves (*fig. 529, 7*) is appropriated, as in other Vertebrata, to the sense of hearing. It arises from the medulla oblongata between the fifth and eighth pairs, and is distributed over the sacculi which contain the otoliths and the ampullæ connected with the semicircular canals of the ear. It has likewise connections with the last branch of the fifth pair, and one which is especially constant with the glosso-pharyngeal division of the eighth pair of nerves.

8. The roots forming the *eighth pair* (*fig. 529, 8*), or *nervus vagus*, are collectively almost as large as the fifth, behind which they take their origin generally by numerous filaments that issue in a single line, that runs longitudinally along the sides of the medulla oblongata beneath the lobes situated behind the cerebellum, and which unite into a ganglion (*fig. 530, t*) before its divisions are given off.

The distribution of the eighth pair of nerves in Fishes affords a striking example of the constancy with which a nerve presides over the same functions in every class of vertebrate animals.

The *glosso-pharyngeal* issues from the cranium sometimes through an aperture in the lateral occipital, sometimes through a foramen in the petrous bone, and supplies the first branchia and the parts in its immediate vicinity, whence it passes forward to the tongue, in which it is ultimately expended.

The *nervus vagus* properly so called leaves the cranium through a special foramen in the lateral occipital bone, and soon dilates into a large ganglion, from which nerves proceed to supply the three last branchiæ and the inferior parts of the pharynx. The trunk of the nerve then passes on along the pharynx and œsophagus as far as the stomach, which it likewise supplies. This distribution, as will be seen, is similar to what is found to exist in all the

vertebrate classes as far as relates to the functions over which the nerve presides, although its arrangement is necessarily modified in consequence of the changed position of the respiratory organs. The eighth pair of nerves gives off one important branch, and sometimes two, the relations of which with what is met with in the superior classes are not so apparent. The first of these is a branch which arises sometimes from the anterior roots of the vagus, and sometimes from the posterior margin of its ganglion, and runs in a straight line as far as the tail. In many Fishes, after having given off a superficial filament which follows the commencement of the lateral line, the trunk of the nerve passes straight backwards imbedded in the thickness of the lateral muscles, between the ribs and their appendices, receiving special filaments from every one of the spinal nerves quite distinct from the intercostals, and giving off branches to the skin, which pass through all the intervals between the muscular layers. In other cases, as in the Cod-fish represented in the figure, it is superficial throughout its whole course, and apparently has no communication with the spinal nerves, although perhaps such communications may exist in the shape of very delicate fibrillæ.

The second remarkable branch is that already described as joining an offset from the fifth to form the dorsal nerve.

The eighth pair likewise gives off filaments to the diaphragm or membranous septum which divides the branchial chamber from the abdominal cavity.

The last pair of cranial nerves arises behind the eighth pair from the medulla oblongata, and, after giving a branch to the swimming bladder, is distributed to the muscles of the shoulder, and those which pass between the shoulder and the hyoid apparatus; it also gives branches which anastomose with those of the first spinal nerve, and from the plexus thus formed the nerves proceed which supply the external and anterior muscles of the pectoral fins.

The second pair of spinal nerves supply the internal and posterior muscles of the pectoral fins. In the Triglæ (*Gurnards*) these nerves are remarkable for their great size, and on account of the large branches that they give off to the free rays situated in front of the pectorals. They arise from the sides of the last of the five pairs of post-cerebellic lobes, which in this race of Fishes are so remarkable.

In Fishes which have their pelvis suspended to the bones of the shoulder, whether the ventral fins appear in front of the pectorals or beneath them, or behind them, it is from the third and fourth pairs of spinal nerves that the ventrals receive their supply; the third specially supplying the muscles of the pelvis, to which likewise the fourth give some branches, but the latter is more particularly distributed to the fin-rays. The muscles of this fin likewise derive some filaments from the fifth pair of spinal nerves.

In the jugular division of Malacopteryginous Fishes, in which the ventral fins are attached

Fig. 530.

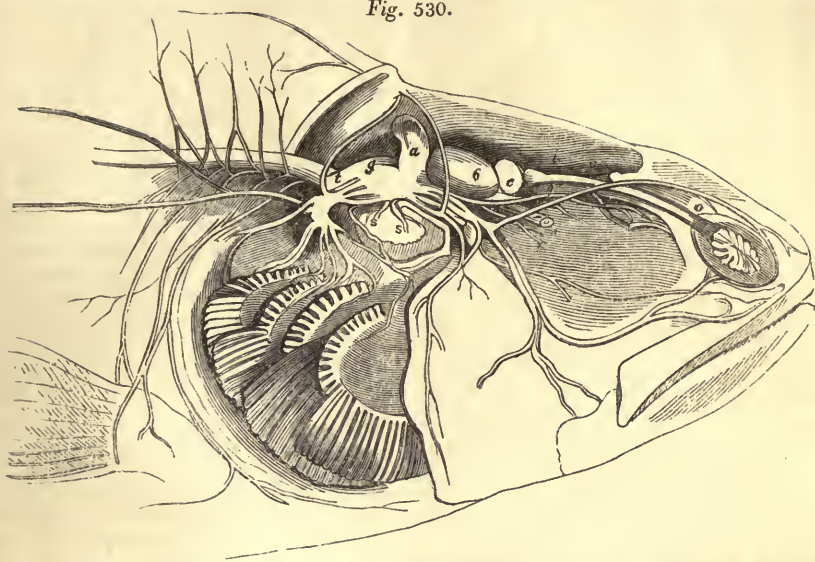

Diagram of the encephalon of the Perch, showing the general distribution of the cerebral nerves.

s, s, vestibule of the ear; other letters as in figs. 526, 527, and 528. (After Cuvier.)

beneath the throat in front of the pectorals, they are supplied from the same pairs of nerves; but in the abdominal division, where the ventrals are situated towards the hinder part of the body, they receive their supply from spinal nerves placed proportionally further back.

Sympathetic system.—The sympathetic system of nerves is in Fishes extremely small, so much so, indeed, that its existence has been denied by some anatomists; it is, however, invariably present, although its filaments are of great tenuity. It runs along the sides of the

Fig. 531.



Lateral and spinal nerves of the Cod (*Gadus morrhua*). (After Swan.)

1, 1, 1, dorsal communicating branch, derived from the fifth pair and nervus vagus, which joins all the nerves of the dorsal fins 10; 2 and 3, two branches from the trunk of the par vagum passing down along the side underneath the skin; 4, branch running beneath the skin, which communicates with the inferior branches of the spinal nerves; 8, 9, exit of the nerves from the spinal canal.

spine, as in the higher Vertebrata, receiving branches from each of the spinal nerves, and anteriorly it communicates with a branch of the fifth, and also with the nervus vagus. On the

left side, after having sent a filament to join the trunk of the par vagum on the stomach,* it

* Swan, *Comp. Anat. of Nerv. Syst.* p. 24.

sends a branch across to join its fellow on the right side in the splanchnic nerve. This forms a ganglionic enlargement on the mesenteric artery, and, after communicating with the right trunk of the par vagum, terminates on the intestines and other viscera. On each side of the aorta the prolongation of the sympathetic is continued down to the tail, giving filaments to the lateral branches proceeding from the aorta, and communicating with the spinal nerves. Near the anus filaments are sent off, which unite and accompany the spermatic artery to the ovaries.

According to the united testimony of Costa, Rathke, and Goodsir, no vestige of a brain or encephalic enlargement of the medulla spinalis is visible in Branchiostoma, a fact of extreme interest to the physiologist. In these extraordinary Fishes, the spinal cord, as described by the last mentioned gentleman, stretches along the whole length of the spine, is acuminate at both ends, and exhibits not the slightest trace of cerebral development. It is most developed in its middle third, where it has the form of a riband, the thickness of which is about one-fourth or one-fifth of its breadth; and along this portion also it presents on its upper surface a broad but shallow groove. The other two-thirds are not so flat, and are not grooved above. They taper off gradually, the one towards the anterior, the other towards the posterior end of the Fish.

From fifty-five to sixty nerves pass off from each side of the cord; but as the anterior and posterior vertebræ are very minute and run into one another, and as the spinal cord itself almost disappears at the two extremities, it is impossible to ascertain the exact number either of vertebræ or spinal nerves. These nerves, Mr. Goodsir assures us, are not connected to the spinal marrow by double roots, but are inserted into its edges in the form of simple cords.

The nerves pass out of the intervertebral foramina of the membranous spinal canal, divide into two sets of branches, one set (dorsal branches) running up between the dorsal muscular bundles; the others (ventral branches) run obliquely downwards and backwards on the surface of the fibrous sheath of the vertebral column, and are distributed to the muscles of the ventral region.

When an entire animal is examined by transmitted light and a sufficient magnifying power, the anterior extremity of the spinal cord is observed, as before mentioned, to terminate in a minute filament above the anterior extremity of the vertebral column. The first pair of nerves is excessively minute, and passes to the parts around the mouth. The second pair is considerably larger; it sends a considerable branch, corresponding to the dorsal branches of the other nerves, passes upwards and backwards along the anterior edge of the first dorsal muscular bundle. This branch joins the dorsal branches of the third and of a considerable number of the succeeding pairs of nerves, at last becoming too minute to be traced further.

After sending off this dorsal branch the second pair passes downwards and backwards on

each edge above the hyoid apparatus, and joins all the ventral branches of the other spinal nerves in succession, as its dorsal branch did along the back. This ventral branch of the second pair is very conspicuous and may be traced beyond the anus, but is lost sight of near the extremity of the tail; it evidently corresponds with the nerve represented in *fig. 531, 1*, as the dorsal communicating branch does with the nerve marked 4 in the same figure.

Sense of smell.—In the structure of their olfactory apparatus Fishes present a remarkable difference from all other vertebrate animals; their nostrils are in fact quite unconnected with the respiratory passages, consisting of mere sacculi, into which the surrounding water obtains free access, which are lined with a pituitary membrane folded into regular plicæ, so as to offer an extensive surface for contact. Their usual situation is towards the fore part of the face, where they are supported by the vomer, the maxillary, and the intermaxillary bones, the first suborbital bounding their lower margin, while above they are arched over by a bone distinguished by Cuvier as the nasal.

The openings of the nostrils are of a round, oval, or oblong shape; they are situated either at the end of the muzzle or upon its sides, or upon its upper surface, or sometimes even beneath, as in the Rays and Sharks, where they are found near the angles of the mouth. In the Lamprey they are placed quite at the summit of the head, and open by a common orifice; but in the greater number of Fishes, perhaps in all the osseous races, each olfactory sacculus presents two orifices, one in front, the other behind, which are sometimes sufficiently remote from each other, but both orifices open into the same cavity.

The anterior orifice sometimes has its edges tubular, as in the Eel, and sometimes this tubular edge is prolonged, as in the Lote and some of the Siluridæ, into a tentacle of more or less considerable length: at other times these tubular prolongations are wanting, as in the Scombridæ, in which family, moreover, the posterior nostrils are but vertical slits.

The nostrils of the Lophius offer a remarkable peculiarity, each being supported upon a little pedicle so as to resemble a mushroom, the expansion of the mushroom containing the olfactory cavity, which, as usual, communicates with the exterior by two little orifices.

In some rare instances the posterior aperture of the olfactory sacculus is situated beneath the lip, a circumstance which is more especially remarkable in some foreign Congers, and exhibits a remarkable approximation to what is met with in the amphibious *Proteus* and *Siren*.

The disposition of the pituitary membrane that lines the nasal sacculus is very simple; where the shape of the olfactory cavity is round, the folds of the membrane which lines it are disposed like the radii of a circle (*fig. 529*); but if the nasal fossæ are oblong or elongated, they are arranged along the two sides of an axis in very regular folds, resembling in their arrangement the barbs of a feather. In the number

and prominence of these folds there is great variety. In the Lump-fish (*Cyclopterus*) they are hardly perceptible; in the Perch there are only sixteen in each nasal sac, and in the Turbot twenty-four, whilst in the Conger or the Eel their number is prodigious, seeing that they extend along the entire length of the long tubular nostril. The rays themselves divide into secondary folds in the Sturgeon, and perhaps in other species; in short, various modes of plication are adopted in different races, but the object obtained is the same in all cases, namely, an extension of the surface of the olfactory membrane. This surface exhibits numerous delicate vessels, and secretes an abundant mucosity which lubricates its interior.

The olfactory nerve, at its commencement from the anterior tubercles of the brain, is sometimes single, sometimes double, and sometimes divided into many filaments of variable number, length, and thickness in different genera, which pass to the posterior or convex aspect of the olfactory sacculus. In its course and distribution differences are likewise observable. Thus, in some genera, as the Tetradons, it is exceedingly slender; in others, as in the Cod (*fig. 529*), it is likewise of great tenuity, but double or triple. The Rays and Sharks have it thick and single, and in these races it is sometimes so short as absolutely to appear merely an appendage of the brain. In the Tunny likewise it is simple throughout its whole length. In the Perch, about the middle of its course it divides into two, and its divisions become multiplied as it approaches the nose. In the Conger and Eel it is divided almost from its origin into two large trunks, each of which gives off successively a great number of branches, which subdivide into ramuscles to be distributed to all the lamellæ of their long nostril.

In many genera of Fishes the olfactory nerve, at the point where it reaches the nasal cavity, dilates into a ganglion, as may be seen in the Cod-fish, the Carp, and the Cyprinidæ generally; and, lastly, the terminal olfactory filaments penetrate into all the folds of the pituitary membrane, and terminate at their free margins.

It does not appear, at least in the osseous Fishes, that the coverings of the nasal cavities or that their openings have any muscles calculated to contract or to expand them.

Eye.—The eye-ball of Fishes presents many peculiarities of structure which are rendered necessary by their habits for the purpose of retaining the flattened figure of the cornea, and of meeting other circumstances of the condition under which aquatic vision has to be performed.

The sclerotic coat which gives shape to the entire eye-ball is a dense and fibrous investment enclosing the whole eye, except anteriorly, where a space is left for the transparent cornea. Its thickness varies in different parts to a greater extent than in any other class of vertebrate animals, being generally greatest at the posterior part of the eye, so as to preserve the cup-shaped form of the eye. In the Sturgeon, for example, its thickness in this region is prodigious, and in the Cod-fish and Shark the

same circumstance is remarkable, although in a less degree. Still further to secure the requisite form of the eye strong plates of cartilage are very frequently developed in the substance of the sclerotic, generally at the back of the eye, but sometimes round the cornea likewise, which in the larger Fishes occasionally become ossified, of which a notable example is met with in the Sword-fish (*Xiphias*), where the ossified portion of the sclerotic forms a bony cup of a spherical form surrounding the entire globe of the eye, except opposite the cornea, and where the aperture is left for the entrance of the optic nerve.

In the Rays and Sharks among the Chondropterygii, the sclerotic, which is of a cartilaginous texture, presents another peculiarity in the presence of a prominent tubercle, which projects externally to be moveably articulated with a pedicle of cartilage derived from the back of the orbit, which thus forms a pivot or centre for the movements of the eyeball. The proper cornea is an exceedingly thin laminated membrane, filling up the anterior opening of the sclerotic; its thickness, however, is considerably increased by the external integument, which passes over it externally under the name of *membrana conjunctiva*: in some species indeed, as *Cecilia* and *Gastrobranchus*, such is the opacity of this tegumentary membrane that all vision is precluded. Immediately beneath the sclerotic there is generally a large quantity of fatty cellular membrane; this is, however, sometimes wanting, but occasionally, as for example in the Moon-fish (*Orthogoriscus Mola*), its thickness is very considerable.

On removing this cellular investment a delicate membrane presents itself, of a brilliant metallic lustre (*membrana argentea*), which indeed from its softness resembles rather a layer of pigment than a true tunic of the eye-ball. It is this layer which spreads anteriorly over the front of the iris, giving it the metallic brilliancy for which in Fishes it is so remarkable.

The iris itself is formed as in other Vertebrata, but the pupil generally remains fixed and motionless; the most remarkable peculiarities noticeable in this part of the eye having reference to the shape of the pupil, which is very various in its form. Thus in the Grey Shark (*Galeus communis*) it is quadrangular; in the Rays and Pleuronectidæ the pupillary aperture is closed by a kind of palmate membrane, which hangs down like a curtain from its upper border; while in one singular case, the Anableps, there is a double pupil as well as a double cornea, although in all other particulars the structure of the eye agrees with that of ordinary Fishes.

The choroid of Fishes presents no peculiarity of structure worthy of notice; it is very vascular and deeply stained with black or dark-coloured pigment. As in the higher animals, it is separable into two layers: the outer or true choroid, which is properly the vascular layer, is of considerable thickness, while the inner layer forms the *tunica Ruyschiana*. This latter tunic, as it approaches the margin of the

iris, is gathered into numerous beautiful radiating folds (*ciliary plicæ*); these in very large eyes, as in the Moon-fish (*Orthogoriscus*) for example, are seen each of them to consist of two or three minute folds, which, as they run forwards, unite into one and terminate in a point at the circumference of the iris, but in no instance do they project freely inwards as distinct processes, so as to resemble the ciliary processes of Mammiferous Vertebrata. The ciliary plicæ, as indeed most of the posterior surface of the iris, is in immediate contact with the membrane of the vitreous humour, to which it is intimately adherent; for in Fishes there is no posterior chamber of the aqueous humour, the anterior segment of the crystalline lens projecting in many instances quite through the pupillary aperture.

In a space enclosed between the proper choroid and the *membrana argentea* is a structure quite peculiar to the osseous Fishes, for it is not met with even in the Chondropterygious races.* This consists of a spongy mass of irregular form, which partially surrounds the entrance of the optic nerve (*fig. 532, h*), and extends for some distance towards the front

Fig. 532.



Coats of the eye of the Perch. (After Cuvier.)

Fig. 1, muscles of eye-ball; *a*, superior oblique; *b*, inferior oblique; 1, 2, 3, 4, recti muscles; *i*, optic nerve. Figs. 2 and 3, *f, f, f*, fatty matter; *g*, choroid; *h*, "choroid gland."

of the eyeball. This body, which has been absurdly called the *choroid gland*, is sometimes divided into two portions; at others it assumes a somewhat crescentic form, but it is always deficient towards the lower part

of the eye. Its colour is always a deep red, and its tissue is principally made up of bloodvessels running transversely in close parallel lines. Other vessels issue from it which are frequently very tortuous and always much ramified; these run into the choroid, where they form so dense a network that it was described by Haller as a distinct membrane, and has been subsequently named *membrana Halleri*. The use of the so-called choroid gland has not been fully ascertained; most probably, however, it is essentially composed of erectile tissue, which by its dilatation and contraction may have some influence in accommodating the form of the eye to the distance of objects, or the varying density of the medium through which they are seen.

The optic nerve in many Fishes (at least among the Acanthopterygii) is made up of a broad layer of nervous matter folded upon itself like a fan (*fig. 532*) and enclosed in a fibrous envelope, which is continuous with the sclerotic coat of the eye. The nerve enters the eye at a point remote from the axis of vision, penetrating for the most part by an oblique course, so that after having pierced the sclerotic it has still a considerable distance to pass through the substratum of cellular tissue and between the masses of the "choroid gland" before it pierces the choroid and Ruyschian tunics. Its diameter is much diminished at the point where it shews itself in the interior of the eye, where it appears sometimes as a mere point, at others under the form of a round or irregular spot, or sometimes represents a straight line. It then expands into the retina, which, when the nerve is folded, as above described, has likewise a plicated appearance. The retina, as in other Vertebrata, lines all the internal cavity of the eye as far as the ciliary plicæ, thus enveloping the vitreous humour.

Another peculiarity in the structure of the Fish's eye is the existence of an apparatus apparently analogous to the marsupium of Birds, which extends from the choroid to the back of the lens, passing quite through the vitreous humour, to which the name of *falciform ligament* has been given. This structure arises by a broad origin from the inner surface of the choroid at the back part of the eye, and extending forwards, following the concavity of the eyeball along its lower surface, arrives at the ciliary zone and is connected with the back of the capsule of the lens. Its shape is falciform, as the name indicates, the convexity of the curve being attached along the floor of the interior of the eye. In the recent eye it is a delicate and almost imperceptible membrane, but maceration in spirit by rendering it opaque reveals it to consist of several layers of cellularity, most probably enclosing numerous vessels. According to Cuvier and the younger Soemmering,* the falciform ligament passes through the retina, which is fissured to let it through; but an examination of the large eyes of the Moon-fish after long immersion in spirit

* Cuvier et Valenciennes, *Hist. Nat. des Poissons*, tom. i. p. 337.

* *De oculorum hominis animaliumque sectione horizontali commentatio*. Pol. Goettingæ, 1818.

distinctly shews the plicated retina continued on to the surface of the ligament, which seems to be covered with the nervous expansion.*

Humours of the eye.—The quantity of the aqueous humour in a Fish's eye is comparatively very small, owing to the flat shape of the cornea and the almost perfect immobility of the iris. The posterior chamber is, indeed, quite deficient, the uvea of the iris being adherent to the capsule of the vitreous humour; and even the anterior chamber is frequently materially encroached upon by the protrusion of the crystalline lens through the aperture of the pupil. As a refracting medium it is evident that the aqueous humour, being nearly of the same density as the surrounding medium, could have little effect in concentrating luminous rays, this duty being principally assigned to the powerful lens immediately behind it.

The crystalline lens in Fishes is nearly of a spherical form, thus presenting the converse as regards its refractive power of what exists in the eye of Birds. The size of the lens in these aquatic animals is very great, so that it encroaches largely upon the chamber of the vitreous humour, extending to more than half way between the pupil and the back of the cavity of the eyeball. Its consistence is very great, and its nucleus so hard as to remain transparent even after immersion in spirit of wine. It is enclosed in a soft capsule, between which and the surface of the crystalline lens is a small quantity of fluid, and is fixed in a deep depression in the fore part of the vitreous humour by a circular membranous zone derived from the hyaloid tunic, which surrounds it like the artificial horizon of a geographical globe. Sir David Brewster, in an admirable paper on the anatomical and optical structure of the crystalline lens,† gives the following interesting particulars relative to its minute organization in the class of Fishes. Its form is that of a prolate spheroid, the axis of revolution being a little longer than the equatorial diameter. This axis is the axis of the eye or of vision. The body or substance of the lens is enclosed in an exceedingly thin and transparent membrane, called its capsule; and if this be punctured, a thickish fluid flows from the opening; but upon removing the capsule altogether, this fluid is found to constitute only the outer coat of the lens, the substance of the lens growing denser and harder as we approach the centre of it.

The body of the lens is not connected with the capsule by any nerves or filaments whatever; on the contrary, it floats as it were within the capsule, and on holding the lens in his hand, Sir D. Brewster observed its axis of revolution take a horizontal position whenever it was placed in an inclined direction. This was repeated several times with the same lens, although the experiment was tried unsuccessfully with others. When the lens is taken out of its capsule, and the softer parts removed by rubbing it between the finger and thumb, a

hard nucleus is obtained, which consists of regular transparent laminae of uniform thickness, and capable of being separated like those of sulphate of lime or mica.

When the surface of any lamina has been examined before it has been detached, it has the appearance of a grooved surface like mother-of-pearl; and in large lenses it is often easy to trace these apparent grooves or lines to the two poles of the axis of revolution, the fibres bounded by them being consequently widest at the equator, and growing narrower and narrower as they approach the poles. The maximum breadth of these fibres is about the 5500th part of an inch, but of course they become gradually attenuated as they approach the poles of the lens in either direction.

Having thus determined the form and size of the fibres which enter into the composition of the crystalline lens, it remained to ascertain the mode in which they were fastened together so as to resist separation and form a continuous spherical surface, and this was found to be effected by a very curious mechanism, the contiguous fibres being united by means of teeth exactly like those of rack-work, the projecting teeth of one fibre entering into the hollows between the teeth of the adjacent one. It was further found that the fibres gradually diminish in size towards the centre of the lens, and the teeth in the same proportion, so that the number of fibres in any spherical coat or lamina was the same from whatever part of the lens it was detached. In conclusion, Sir David Brewster observes, "In the lens of a Cod I found that there were 2000 fibres in an inch at the equator of a spherical coat or lamina, whose radius was $\frac{2}{5}$ ths of an inch; consequently there must have been 2500 in the spherical surface. If we now suppose that the breadth of each fibre is five times its thickness, and that each tooth is equal to the thickness of the fibre, or that five teeth are equal in breadth to a fibre, we shall obtain the following results for the lens of a Cod four-tenths of an inch in diameter:—

Number of fibres in each lamina or spherical coat	2,500
Number of teeth in each fibre	12,000
Number of teeth in each spherical coat	31,250,000
Number of fibres in the lens	5,000,000
Number of teeth in the lens	62,500,000,000

or, to express the result in words, the lens of a small Cod contains five millions of fibres and sixty-two thousand five hundred millions of teeth. A transparent lens exhibiting such a mechanism may well excite our astonishment and admiration."

The *vitreous humour* in Fishes is proportionally less abundant than in other races of Vertebrata,—a circumstance which is partly owing to the shortness of the antero-posterior diameter of the chamber of the eye-ball, and partly to the extent to which it is encroached upon by the large spherical crystalline lens; in other respects it presents no peculiarities worthy of special description.

Muscles of the eyeball.—The eyeball of

* Vide Preparation 1650, in the physiological series of the Museum of the Royal College of Surgeons, London.

† Phil. Transact. for 1833, p. 323.

Fishes is moved by six muscles analogous to those met with in other Vertebrata, and to which similar names are applicable. The *recti* muscles (fig. 532, 1, 2, 3, 4) are four in number, arising from the back of the orbit near the margin of the optic groove, and running forward to be attached in the usual manner to the sclerotic coat of the eye. The *obliqui* (fig. 532, a, b) both take their origin from the anterior part of the walls of the orbit, and pass in a transverse direction towards the eyeball, into which they are inserted, one on its superior, the other on its inferior aspect. There is no trochlear apparatus in connection with the superior oblique, as is the case in quadrupeds, but, like the inferior, it passes straight to its destination. The suspensory or choanoid muscle met with in Mammalia, in Fishes is totally wanting.

In the Sharks the muscles moving the eyeball are of very great strength, and, moreover, their efficiency is rendered more perfect by mechanical contrivances that are not met with in the ordinary Fishes. In the latter the eye is simply supported in the orbit by a quantity of loose cellulosity filled with a gelatinous or fatty semifluid substance, admirably adapted to facilitate the movements of the eye; but in the plagiostome cartilaginous Fishes the cartilaginous pedicle is provided, already mentioned, which, taking its origin from the back of the orbit between the origins of the recti muscles, runs forward to be moveably articulated, frequently by means of a very complete ball-and-socket joint enclosed in a capsular ligament, to the back of the sclerotic, so as to form a pivot upon which the eye turns. In the attachment of the recti and oblique muscles to the eye-ball an additional piece of mechanism is observable, each of these muscles being inserted into a prominent cartilaginous tubercle, which projects from the external surface of the sclerotic, and thus enables the muscle to act with greater advantage.

In the generality of Fishes there are no eyelids, the external tegument passing on to the front of the eye-ball without forming any fold or duplicature to which such a title is applicable; there are, however, exceptions to this arrangement which must not be passed over unnoticed. Thus, in the Mackerel (*Scomber scombrus*), the eye is partially defended by two vertical folds of the common integument, and in the Herring (*Clupea harengus*) there is a similar provision for the defence of the eye-ball and orbit.* The vertical folds are unprovided with any muscular structure for their movement, and are consequently transparent so as not to interfere with vision when the front of the eye is brought beneath them. It is worthy of observation that, where these folds decussate one another at their inferior extremities, the anterior one overlaps the posterior, so slight an impediment to progressive motion as the contrary position would have occasioned having been foreseen and avoided.

In the Sharks and Sturgeons the integument

forms a deep circular fold around the front of the eye, which, although motionless, is evidently of a palpebral character. A secreting *membrana conjunctiva* is reflected deeply between this circular fold and the globe of the eye, of which it covers the anterior half. In the Sharks* there is likewise a third eyelid, which is moveable; this is placed at the inferior and internal or nasal side of the orbit, and is moved over the front of the eye in a direction upwards and outwards by means of a strong round muscle (*nictitator*) which arises from the upper and posterior or temporal side of the orbit, and descends obliquely to be inserted into the lower and outer margin of the third eye-lid; passing in this course first through a muscular trochlea, and then through a ligamento-cartilaginous loop. The trochlear muscle is not, however, exclusively subservient to the action of the nictitator, but has an insertion in the upper part of the palpebral fold, which it depresses simultaneously with the raising of the third eyelid, a slight external groove above the upper eyelid indicating the extent of motion allowed.

The lacrymal apparatus is totally wanting in the whole race of Fishes, no trace of lacrymal glands or punctæ lacrymalæ being ever distinguishable; neither could a lacrymal secretion be needed in animals whose eyes are perpetually bathed by the water in which they live.

Auditory apparatus.—The organ of hearing in Fishes undergoes a gradual improvement in its structure as we advance from the lower to the more highly organized genera, presenting almost every intermediate gradation between the least complex form, in which it consists of the vestibule alone, without semicircular canals or other appendages, approximating in simplicity the ear of a Cuttle-fish (vide art. *CEPHALOPODA*), to the most complete ichthyic type of the auditory apparatus, met with in the Sharks and Sturgeons.

It is in the Lampreys (*Petromyzon*) that the auditory organ exists in its humblest state of development.† In these Fishes the ear is enclosed in a simple cartilaginous capsule of an elliptical figure, situated on each side of the skull external to the posterior cranial cartilages. The walls of these capsules are thin, and the cavity which they contain of an ovoid shape. In that side of each cartilaginous capsule (vestibulum cartilagineum, *Weber*), which is nearest the cranium, are two openings, the inferior, which is the larger, being of an oval shape closed with a firm and elastic membrane, while the superior is extremely small, giving transit to the auditory nerve as it passes into the vestibule. With the exception of these apertures, which open into the cavity of the cranium, the cartilaginous capsule is closed on all sides.

The whole of the elliptical cavity of the cartilaginous capsule is filled by a pellucid membranous sac (*vestibulum membranaceum*)

* Catalogue, Mus. Coll. Surgeons, Lond. prep. 1762.

† Vide Tract. de Aure animalium aquatiliam, auctore Ernesto Henrico Webero. Lipsiæ, 1820. 4to.

* Vide Catalogue, Mus. Coll. Surgeons, Lond. vol. iii. p. 171.

turgidly filled with a transparent fluid; the membranous vestibule, however, does not adhere to the walls of the capsule except at the orifices leading into the cranium. The membranous vestibule has its cavity divided into several compartments by folds projecting into its interior, and receives the auditory nerve, which being changed into a pulpy mass spreads out over its walls.

In the Petromyzonidæ therefore three important parts of the auditory apparatus, which are met with in the ear of all other Fishes, are wanting, viz. the sac of the *otolithe*, the *otolithe* itself, and the *semicircular canals*, except indeed rudiments of the latter may be represented by two curved folds of the membrane of the vestibule, which are joined superiorly to a similar fold, an arrangement which is met with both in the river and sea-lamprey. The auditory nerve is derived immediately from the brain.

From the above description it would appear that in the Lampreys there are two modes whereby sonorous vibrations may be communicated to the vestibule, one through the cartilaginous capsule of the ear, the other through the cranium, which communicating tremors impressed upon it from without to the fluid which is contained in its cavity, the vibration reaches the tense membrane that closes the large fenestra leading to the vestibule, and thus affects the membranous vestibular sac itself.

In a second group Weber includes those forms of the ear which have no cartilaginous or osseous vestibule separate from the cranial cavity. This kind of ear exists in by far the greater number of Fishes, being met with in all the truly osseous and branchiostegous races as well as in some Chondropterygians; in none of which is the membranous labyrinth enclosed in a bony or cartilaginous envelope, the internal ear being contained in the cavity of the skull itself near the posterior part of the cerebrum, with which, in fact, it is for the most part in apposition; for in these Fishes the cranium being very large and having only a small part of its cavity occupied by the brain itself, performs the office of an osseous labyrinth, not only by furnishing a receptacle to the internal ear in which every part necessary to the performance of its functions may be fitly suspended, but is filled with fluid with which the membranous labyrinth is every where surrounded, a provision not less necessary to the sense of hearing than is the fluid contained in the interior of the vestibule and semicircular canals. In all such Fishes, therefore, the auditory apparatus, consisting of a membranous vestibule and semicircular canals, is lodged on each side in cavities excavated in the base of the cranium and bounded by the temporal and lateral parts of the occipital bones.

The internal ear itself (*fig. 528*) is composed of the following parts: 1st. The membranous vestibule (*fig. 525, i*). 2d. The sac of the *otolithe*. 3d. The membranous semicircular canals.

The membranous vestibule is an elongated smooth sacculus of very various form in different Fishes. Its parietes consist of a pellucid membrane, and its outer surface is connected by loose cellular tissue to the sides of the cavity in which it is lodged. Its anterior extremity is somewhat dilated and contains a little *otolithe*; moreover into it open the *ampullæ* of the anterior and external semi-

Fig. 533.

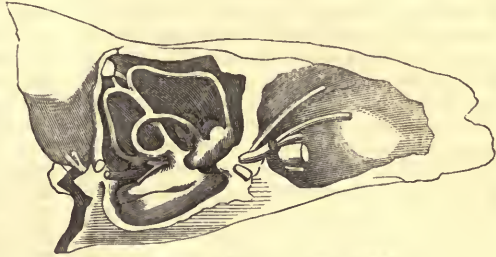

Internal ear of Perch. (After Cuvier.)

circular canals. The posterior extremity of the vestibule is narrower, and into this part opens the ampulla of the posterior semicircular canal and the hinder termination of the external one. Near the middle of the vestibular sac enters the wide duct formed by the conjunction of the terminations of the anterior and posterior semicircular canals; but whether this wide duct ought rather to be looked upon as forming part of the vestibule or of the semicircular canals may be a matter of doubt, although the latter supposition is the most probable.

Thus the six extremities of the three semicircular canals communicate with the cavity of the membranous vestibule, not by six, but by five orifices.

The membrane of which the vestibule consists is considerably thinner than that which forms the semicircular canals; indeed it is so delicate that if torn it at once collapses and is scarcely distinguishable from the surrounding parts.

In the Pike (*Esox lucius*) there is a remarkable appendage to the vestibule which is not met with in other Fishes. This consists of a pyriform membranous sacculus lodged in the commencement of the spinal canal, which opens into the vestibular cavity by a narrow orifice near the entrance of the posterior semicircular canal. The thickness of the walls of this sacculus is much greater than that of the parietes of the vestibule, resembling rather in this respect the *ampullæ* of the semicircular canals. Some of the upper spinal nerves are distributed to this organ, but they give off no branches, nor does it appear to receive any filament from the auditory nerve.

The *sac of the otolithe* in most Fishes is immediately beneath and in close contact with the membranous vestibule, but in some it is hidden in the base of the occipital bone more remote from the vestibular cavity, with which it is joined by a narrower duct. The *sacculus* is most generally divided into two portions by a median septum, in such a way, however, that the ante-

rior is much the larger compartment, to which the posterior chamber seems a superadded appendix. Both of these compartments are filled with a pellucid fluid, and each contains a stony mass or *otolithe*, of which that in the anterior is the largest, that in the posterior being comparatively of small dimensions. In *Orthogoriscus*, however, according to Cuvier, the saccus is single, and instead of an *otolithe* only contains a few granules apparently rather of mucus than of cretaceous substance.

Otolithes.—Most Fishes are furnished with three stony masses, which are intimately connected with the function of hearing. Of these, the *otolithes* or *lapilli*, one, generally the smallest, is contained in the anterior extremity of the vestibule; the other two are situated in the two compartments of the *saccus*. The *otolithe* contained in the anterior compartment of the *saccus* is generally of remarkable size, forming a considerable protuberance in the base of the occipital bone, in which it is lodged; this is conspicuously seen in the *Gadidæ* and some of the *Perch* tribe.

The substance of these *otolithes* consists of carbonate of lime, but they assume various degrees of hardness and considerable diversity of colour in different Fishes. In most cases they present a texture as hard and fragile as porcelain. In a few instances, as for example in the Sturgeon (*Accipenser Sturio*), there is only one *lapillus*, which is soft and as easily crushed and reduced to powder as a piece of chalk; as is likewise the case with the *otolithes* of the *Raidæ* and *Squalidæ*.

In shape the *otolithes* vary exceedingly in different genera. For the most part they are smooth and present this character in common, that they are marked with asperities, fossæ, and grooves for the attachment or reception of nervous filaments. Those contained in the *saccus* are frequently surrounded by a serrated margin, which is rarely the case with the *lapilli* of the vestibule. But whilst there is so much diversity in the shape of the *otolithes* belonging to different genera of Fishes, the form of those met with in the species belonging to the same genus is wonderfully constant, so much so, indeed, that not only the general outline, but the most minute fossules and grooves were found by Weber accurately to correspond in different specimens, so that it was difficult to distinguish one from the other; from which circumstance those *otolithes* might be employed with advantage as affording excellent generic characters to the zoologist. The connection of the *otolithes* with the *saccus* or with the vestibule is so difficult to be perceived, that they might be thought to be loose in the contained fluid; when, however, we find them small in the younger Fishes, and increasing in size as age advances, it is evident that they must receive nutritious vessels; they are moreover attached by nervous filaments of extreme delicacy, which pass to them from the *saccus*. In many points they touch the membranous walls of the cavity in which they are lodged; when, therefore, the sac is but loosely connected with the bones of the cranium, sonorous vibrations cannot be

communicated immediately from the cranium to the *lapilli*, but must first be communicated to the surrounding fluid.

Semicircular canals.—All Fishes, with the exception of the *Petromyzonidæ*, have three semicircular canals entering into the formation of the internal organ of hearing, and the arrangement of which is as follows. The *anterior* arises by one extremity from the anterior part of the vestibule, and, winding upwards and backwards, meets the posterior semicircular canal derived from the hinder part of the vestibular cavity; at the point of meeting the two join to form one common duct, which enters the vestibule near its middle. Both these canals are placed perpendicularly. The third or external semicircular canal issues from the anterior part of the vestibule, and winds horizontally outwards to join the vestibule again at its posterior part near the origin of the *posterior* canal. In this way the three semicircular canals open into the membranous vestibule by five orifices. In the Herring, however, (*Clupea Harengus*) not only do the anterior and posterior canals unite, but the external also joins the posterior, so that in this fish there are only four apertures communicating with the vestibule.

Each of the semicircular canals near its commencement from the vestibule swells into an oval dilatation called the *ampulla*, so that three of these *ampullæ* exist, two at the anterior part of the vestibule, and the third near its posterior extremity.

The connection between the semicircular canals and the cranium is effected by the assistance of osseous passages, in which one or two (rarely all three) of the semicircular canals are lodged, and in some Fishes, as for example in *Cobitis fossilis*, these are entirely deficient. The membranous canals are not at all adherent to the osseous passages, but are only connected with them by the intervention of a most delicate cellulosity, or are merely suspended in a fluid, with which all the osseous canals as well as the entire cranium is filled up; they are consequently extracted without the employment of the slightest force.

Those canals which are not enclosed in bony channels are simply annexed to the bones of the cranium by a fine cellular web.

From the above arrangement it may be clearly understood that these parts are purposely left but loosely connected to the surface of the bones, for otherwise the bony canals would not so greatly exceed the membranous ones in size, but on the contrary would be filled and lined by them throughout; and that sonorous vibrations most readily arrive at the labyrinth through the fluid with which the canals are surrounded.

In *Muræna unguilla* the anterior and posterior semicircular canals mount so high towards the vertex of the cranium that they are not placed by the side of the brain, but absolutely rise above it and approximate their fellows of the opposite side.

The length and calibre of the semicircular canals vary very much, not only in different species, but also when compared with each other.

The tissue of which they are composed is similar to that which forms the membranous vestibule and *sacculus*; it is, however, a tissue *sui generis*, being neither exactly comparable to cartilage, nor tendon, nor cellular membrane. It is pellucid, and when emptied of the enclosed fluid, inelastic, but flexible and easily torn. Its thickness is greater than that of the vestibule or of the sac of the otolith; but the ampullæ seem thicker than the rest, for when wounded and their contents allowed to escape they still retain their form and expansion.

The membranous labyrinth is filled with a limpid fluid.

Auditory nerves.—The labyrinth of the ear in Fishes receives its nerves from two sources,* 1st, from the auditory nerve, properly so called, which is distributed to the membranous vestibule, and to the ampullæ of the anterior and external semicircular canals; 2ndly, from the "accessory auditory nerve," which, in most instances, seems to arise not from the brain but from the trigeminal or the vagus nerve, and supplies the ampulla of the posterior semicircular canal and the *sacculus*.

Ear of plagiostome cartilaginous Fishes.—In the Skate are two canals, regarded by Monro as representing the meatus auditorius externus. The orifices of these are situated at the upper and back part of the head at a short distance from the junction of the skull with the first cervical vertebra, the opening of each being large enough to admit the end of a probe. Each of these orifices leads to a winding canal about two lines in diameter, which, after describing more than three-fourths of a circle, may be traced into the membranous vestibule of the ear. This canal is generally found filled with a white viscid matter. The vestibule is a large sac containing a very viscid pellucid humour, in consistence like the white of an egg, in which is suspended a soft cretaceous substance. To the anterior part of the large sac there is a smaller compartment communicating with the former by a narrow passage, which is likewise filled with glairy fluid, and, posteriorly, there is a third very small sacculus, similarly distended, in both of which cretaceous matter is found.

The remaining portion of the internal ear consists of three canals, analogous to the semicircular canals of the higher Vertebrata, but which here rather deserve the name of circular, seeing that each forms a complete circle; of these the anterior and the middle are joined together at their commencement by the wide intercommunicating branch which opens through the intervention of a small membranous tube into the anterior small sac of the vestibule. The third or posterior canal communicates with the large sac of the vestibule by means of a wide canal, but has no direct communication with either of the others.

Each circular canal has a dilated portion or ampulla near one of its extremities, and is filled with a pellucid viscid fluid. They are all contained in cartilaginous tubes excavated in the cartilaginous substance of the cranium, but

much wider than the membranous canals themselves, the latter being suspended in a fluid interposed between them and the perichondrial lining of the cartilaginous passages, to which they are fixed by a delicate cellulosity, in which slender vessels and very minute nerves are visible.

The auditory nerve on entering the ear divides into several branches. Of these the principal spreads out upon the inferior aspect of the great sac of the vestibule, where it forms a rich plexus; a similar but smaller plexus is formed upon the smaller anterior sac communicating with the vestibule, while the other branches are appropriated to the semicircular canals, on the ampullæ of which they would seem to be exclusively distributed; at least after forming a very beautiful expansion upon the dilated portion of the canal, it is impossible, owing perhaps to their very minute size, to trace them any further over its cylindrical part.

Generative system.—One of the most remarkable circumstances connected with the history of the finny tribes is their extreme fertility, which, compared with that of the higher Vertebrata, is truly prodigious. A codfish has been calculated to produce 9,000,000 of eggs in a single season, and innumerable races of the osteopteryginous Fishes exhibit powers of reproduction equally extraordinary. To imagine that this exuberant fecundity is destined merely for the purpose of perpetuating the species would evidently be preposterous, and we are necessarily led to look for other reasons explanatory of such teeming births. There is this leading difference between the terrestrial and aquatic domains of animated nature—the earth is inhabited only at its surface, and the vegetable banquet which is there spread out in such rich abundance is sufficient to afford the means of subsistence to all earth's progeny. But the sea, throughout all its depth, at every altitude which man has been able to explore, is peopled with innumerable races of voracious beings, all of which are necessarily dependent for their existence upon a supply of animal food, which must consequently be distributed as widely as the waves of ocean are diffused. It is to supply this great stock of living provender that the Sponges and the Polyps and all the humbler marine forms of existence are continually pouring forth their multitudinous germs, and it is for the purpose of adding to this enormous store that the majority of the osseous Fishes are so inordinately prolific.

From these considerations we perceive at once a reason for the extraordinary apathy and total absence of parental affection which forms so conspicuous a feature in the character of the whole race, and it is by no means a subject devoid of interest to observe how gradually the ties between parent and offspring are drawn closer and closer as we ascend from these humblest members of the Vertebrata and arrive at progressively increasing intelligence as we advance from class to class.

The generative apparatus of Fishes, as we have pointed out in a preceding article, (*GENERATION, ORGANS OF, Comp. Anat.*) pre-

* Weber, loco cit.

sents itself under three principal types, each of which will merit distinct consideration.

The first is that observed in the Dermapteryginous or Cyclostomatous Fishes, such as the Myxine and Lamprey; but it is not peculiar to this group, seeing that the Eels and perhaps other races have a similar organization.

On opening the abdomen of one of these Fishes, as, for example, the Lamprey, (*Petromyzon marinus*, fig. 534) an exceedingly

Fig. 534.

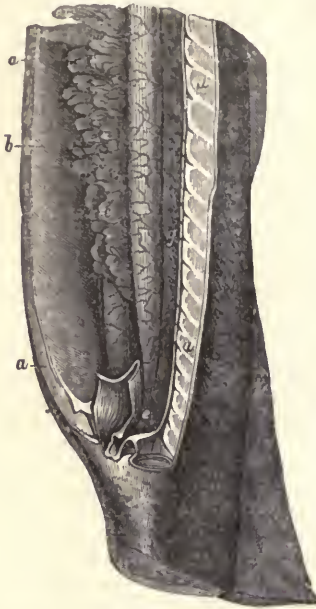

'Female generative organs of the Lamprey (*Petromyzon marinus*).

a, parietes of abdomen; b, cavity of ditto; c, ovary; e, external passage leading into abdominal cavity, through which the ova are discharged; g, kidney.

extensive membranous expansion is found suspended in loose folds, which is attached by a kind of mesentery beneath the spinal column, and extending along the whole length of the abdominal cavity. Except in the breeding

Fig. 535.



One of the folds of the ovary of the Lamprey, (*Petromyzon marinus*), showing the enclosed ova.

season, this membrane, of which a portion only is represented in the figure, (fig. 534, c,) is thin and transparent, but at the same time exhibits considerable vascularity. When the breeding season approaches, innumerable granules begin to make their appearance, between the two layers of which this expansion consists, which in the female soon proclaim themselves to be ova (fig. 535), and, as they increase in size, gradually distend the whole abdomen. On opening the fish in this condition the abdominal cavity appears to be completely filled with innumerable ova beautifully arranged in rich festoons, all of which are connected in front of the spinal column. When the ova are quite mature they are cast loose from the ovary and escape from the ovarian membrane in which they were formed, into the general cavity of the abdomen, wherein they may be found at this period floating quite loose preparatory to their expulsion. This is ultimately effected through a simple but wide orifice (e) situated immediately behind the anal aperture, and causing a free communication to exist between the peritoneal cavity and the exterior of the body, so that the ova easily pass out and are ejected into the surrounding water.

In the males of those Fishes which offer this type of the generative system the appearance of the reproductive organ is, while in a state of inactivity, so exactly similar to that of the female as to preclude the possibility of distinguishing the two from each other; but, as the breeding season advances, the difference becomes apparent; the festooned membrane, which must in this case be called the *testis*, secretes a kind of milt or seminal fluid, rich in seminal animalcules, which in the same manner as the ova of the female escapes into the peritoneal cavity and is expelled through a post-anal orifice to be diffused through the surrounding water, by the agency of which it is applied to the previously deposited spawn of the female, whose ova thus becoming vivified are left to the mercy of circumstances to be destroyed or hatched in due season.

In the second form of the generative apparatus which is common to almost all the true osseous Fishes, a very different arrangement is met with. The folds of the ovarian membrane, instead of being loosely suspended in the abdominal cavity, are now completely enclosed in two capacious membranous capsules, situated one on each side of the spine, and which when distended with ova occupy a very large share of the abdomen. On opening one of these capsules, the ova which it contains are seen, however, to be developed between the two layers of the proper ovary, exactly as in the case of the Lamprey, and to be attached in broad festoons to the interior of its walls, the essential difference being that whereas in the preceding type the eggs, when expelled from the ovary, escaped into the peritoneal sac, they now are retained by the capsular envelope of the ovary, whence they are expelled through excretory canals provided for the purpose. These, as they exist in the Herring, are represented in the annexed figure (fig. 536); from the posterior extremity of each

Fig. 536.

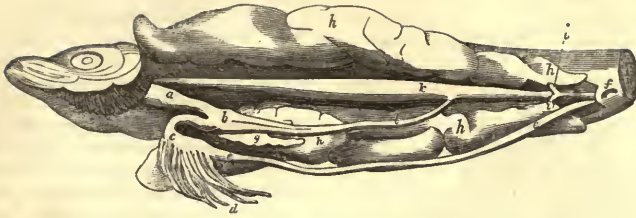
Viscera of the Herring (*Clupea harengus*).

a, oesophagus; *b*, *c*, stomach; *d*, pyloric caeca; *e*, intestine; *f*, anus; *g*, spleen; *h*, *h*, ovary; *i*, oviducts; *k*, air-bladder.

ovarian capsule arises a short canal *i, i*, and these two ducts uniting form a common tube, through which the ova pass out of the body through an aperture, *f*, situated immediately behind the anus.

In the male the disposition of the generative organs is precisely similar, the membrane contained in the two capsules secreting *milt* instead of *spawn*, which when expelled through the efferent duct and thus mixed with the water in the vicinity of the ova of the female, previously deposited, impregnates them by aspersión. Instances are recorded by Cavolini and others of a remarkable kind of hermaphroditism occasionally met with in Fishes presenting this type of structure, in which, while the generative capsule upon one side of the body contained a roe-secreting membrane, that of the other furnished milt, so that one half of the fish was male and the other female; such an arrangement, however, can only be looked upon as a *lusus naturæ*, although regarded by some of the older naturalists as a normal occurrence.

Among the Salmonidæ a very interesting arrangement of the generative apparatus is met with, which would seem to offer an intermediate condition between that of the Lamprey and that of the ordinary osseous Fishes. In the Trout and Salmon for instance, the extensive folds of the ovarian membrane are only partially enclosed in an investing capsule, the interior of which communicates by means of a wide slit with the abdominal cavity. In the common Salmon (*Salmo Salar*, Linn.) the ovary is much reduced in its relative size when compared with that of the Lamprey or of the Eel, although the ova are still developed in the folds of an irregularly transversely plaited membrane. These folds and their contained ova are, however, enveloped on their posterior and lateral aspects by a thin capsule, which is wanting on their anterior surface. Through this anterior opening in the capsule the ova are discharged into the cavity of the abdomen, whence they are finally expelled through the peritoneal apertures situated near the anus, as in the Lamprey.

Notwithstanding that the great majority of the osseous Fishes shed their spawn to be impregnated out of the body, some rare instances are met with in which the females are viviparous, producing their offspring not only already hatched, but even considerably advanced in growth. Such, for example, is the Viviparous

Blenny. In cases such as these it is evident that impregnation must occur internally, and accordingly a kind of copulation must be presumed to be effected. Yet, even in these Fishes no very obvious peculiarity is to be detected in the structure either of the male or female organs; neither is the male better provided with an intromittent apparatus than the ordinary oviparous genera.

The *Syngnathidæ*, or pipe-fishes, offer a very peculiar conformation, which is not inaptly comparable to what is met with among the marsupial Mammalia, namely, a pouch wherein the ova are carried about until after they are hatched, and in which the young are defended during the earliest period of their growth.

In the plagiostome cartilaginous Fishes the arrangement of the generative apparatus of both sexes is of a very different character, approximating that type of structure which is common to the Reptilia and Birds. In the male Shark (*Squalus acanthias*), which may be taken as an example of the group, the anatomy of these parts is as follows. The testes, two in number, (for the minute structure of which the reader is referred to our preceding article GENERATION, ORGANS OF, Comp. Anat.) are situated at the anterior part of the abdomen, on each side of the mesial line, (*fig. 537, k*), where they are attached by their inner margins to a duplicature of the peritoneum, which connects them with the region of the spine. The vasa deferentia derived from each of these glands are long and tortuous tubes (*l, l*), increasing in size as they pass backwards towards the cloaca, into which they open by an orifice common to them and to the ureters upon a kind of papillary eminence (*o*), which is here in truth a rudimentary penis adapted to facilitate the impregnation of the female which takes place internally.

The openings communicating between the cloaca and the cavity of the peritoneum (*fig. 537, p, p*), are situated a little lower down beneath a kind of valvular fold formed by the termination of the rectum.

In the vicinity of the cloacal aperture are situated the claspers, or holders, (*q, q*), so called because they are generally supposed to be used for clasping or holding the female during the sexual intercourse necessary for internal impregnation, although some authors have imagined them rather to perform the office of an intromittent organ by being actually in-

Fig. 537.

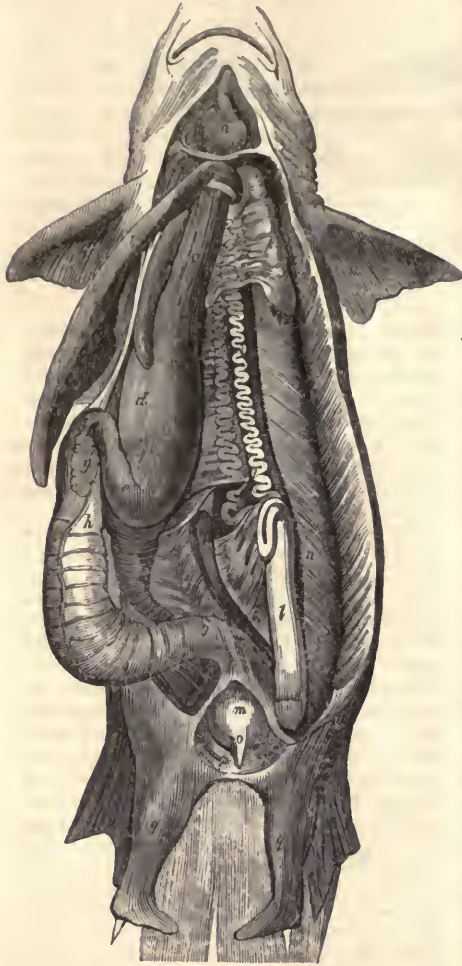

Viscera of male Shark. (After Clift.)

a, heart; *b*, liver; *c*, œsophagus; *d*, stomach; *e*, pyloric portion of stomach; *g*, pancreas; *h*, *i*, intestine; *k*, testis; *l*, vas deferens; *m*, urinary bladder; *o*, rudimental penis; *p*, *p*, peritoneal openings; *q*, *q*, claspers.

roduced into the cloaca of the other sex in the act of impregnation. The following is Cuvier's description of these remarkable organs, which are met with in the males both of the Sharks and Rays and likewise of the Chimæra, and from the composition and relations of the cartilages and muscle which enter into their structure are evidently only an extension or appendage of the ventral fins. They consist in the Rays and Skates of two cartilages articulated end to end, situated along the inner side, which forms the basis of the whole apparatus. The first of these cartilages, which is a sort of *femur*, articulates with the pelvis, and supports, in conjunction with the second (the *tibia*), the rays of the ventral fin.

A third cartilage unites this fin with the genital portion like a kind of astragalus; this

articulates with the longest cartilage of the limb.

On the side of the astragalus is an oval cartilage having a sharp inferior margin, to which may be applied the name of *os calcis*.

The *os calcis* articulates posteriorly with another principal piece of the limb which may be called the *metatarsus*. This extends all along the upper and inner border of the limb as far as its extremity, where it forms a sort of digit, to which is attached the tendon of the great abductor muscle. This large piece is formed by the consolidation of three smaller ones, two of which run parallel to each other, so as to constitute a semi-canal, into which opens a duct derived from a large gland hereafter to be described.

To the metatarsus succeed seven other cartilages, the shape of which is different in the various species of Chondropterygii, but which obviously represent the phalanges of the abdominal limb, which is moved by five strong muscles which may be named respectively the depressor, the elevator, the abductor, the adductor, and the expander of the fin. It is, however, remarkable that there is no muscular apparatus calculated to approximate these members, and when separated they are brought together again entirely by their own elasticity, a circumstance which militates strongly against their being, as is generally supposed, instruments of prehension. In the Sharks the clasper contains moreover a gland of considerable size situated beneath the fin, and extending to the exterior of the base of its genital appendage. Inferiorly, this gland is only covered by the skin, while above it is adherent by the intervention of cellular tissue to the rays of the fin. Its duct is a wide canal which opens into the groove formed by the metatarsal cartilages above alluded to, and the fluid which it secretes of a highly viscid character. It is said that in the breeding season the contents of this gland, as well as the parietes of the cavity in which it is situated, are red with blood and appear to be in a remarkable state of turgescence. It is enclosed in a double tunic, one fibrous and the other muscular, by the assistance of the latter of which its contents are evacuated.

At the lower extremity of this gland, near its orifice, there is in each clasper a capsule with muscular and cavernous parietes, the cavity of which is traversed by slender tendinous filaments. In these sacs Dr. John Davy* has observed distinct pulsations, and finding that in the living fish they were filled with blood, considers them as accessory hearts destined to assist the circulation of the blood in these appendages to the genital system.

The gland itself is of the shape of an olive; a longitudinal sulcus divides it into two portions, in each of which a transverse series of very delicate tubes is distinguishable.

In the females of the Plagiostome Chondropterygii the arrangement of the sexual organs conforms in an equally striking manner with the Reptilian type of structure. The

* Phil. Trans. 1839.

ovary is distinct from the oviduct, as in the three higher classes of Vertebrata. When the ovules are not developed,* the ovary of the *Sharks* forms a thick, oval lamina slightly notched or concave upon its inner border, suspended upon each side of the vertebral column at the very anterior extremity of the abdominal cavity, from which point it is prolonged backwards for a greater or less extent. The inferior and internal surface of this lamina, that by which the ovaria would touch each other if approximated, presents no prominences, but is of a uniform milk-white colour. The posterior surface of the organ has the same appearance,

Fig. 538.

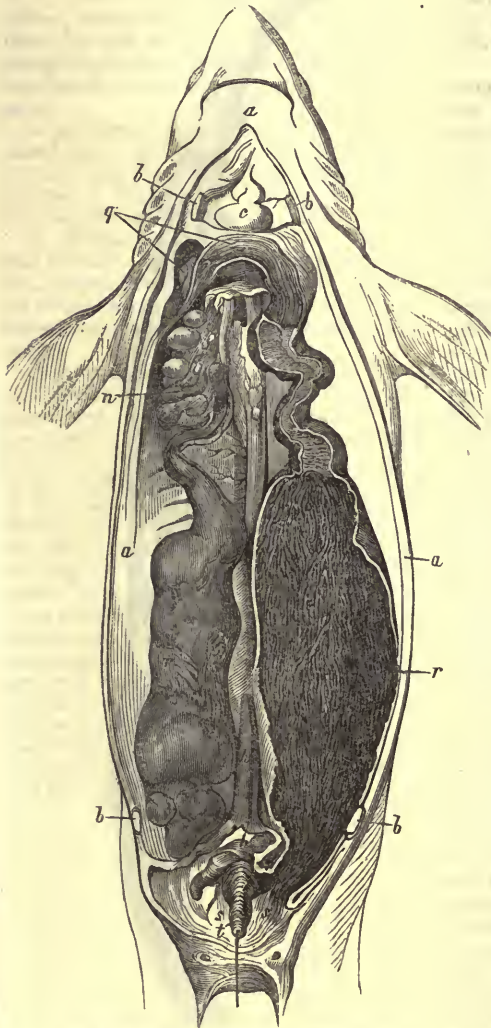

Viscera of female Shark, after Hunter.

a, skin; b, cut pectoral and pelvic arches; c, heart; h, caecal appendage to intestine; n, ovary; q, oviduct; r, uterine portion of oviduct; s, s, termination of oviducts in cloacal cavity; t, papilla on which the ureters open.

except that upon the anterior half or two-thirds of the ovary little rounded eminences of different sizes are perceptible, the smallest of which are pearl-white, while the larger are of an opaque-yellow colour; these are the ovules in process of development from the proligerous stratum of the ovary, which gradually increase in size as they advance towards maturity, and project through the upper surface of the ovary. This latter expands itself in the form of a capsule over the ovules in such a manner that as their development increases they become detached from each other, and separating themselves more and more become at length racemose.

The remainder of the ovarian lamina retains its soft, milky, homogeneous appearance, which is very characteristic, and resembles very closely one portion of the testis of the male.

In many of the viviparous Sharks, that portion of the ovary only which does not form eggs is met with upon one (generally the left) side of the body, whilst upon the opposite the organ attains its full development.

The general disposition of the rest of the generative apparatus is well shewn in the accompanying figure (fig. 538) of the sexual organs of the female Dog-fish, (*Spinax acanthias*, Cuv.) taken from one of the admirable drawings left by John Hunter, and engraved in the Catalogue of the Hunterian Museum.

The ovary (n) presents ovisacs in different stages of development attached by a duplicature of peritoneum to the side of the spine, immediately below the liver and œsophagus. The anterior orifices of the oviducts (q, q) are situated close together above the liver; their coats, which are at first thin and membranous, gradually increase in thickness, and about four inches from the orifice become suddenly thickened by the addition of a laminated glandular structure; this is, however, much less developed in the present viviparous species than in the oviparous cartilaginous Fishes, and the size of the oviduct continued from the glandular part more nearly corresponds with that of the preceding portion than in the oviparous races. Beyond the glandular portion the oviduct gradually increases in diameter, having its lining membrane thrown into longitudinal plicæ, until suddenly it dilates into a wide uterine portion (r), in which, in the viviparous Sharks, the young are retained after the eggs are hatched, until they are fit for exclusion in a living state.

In the dilated uterine portion the lining membrane is gathered in close longitudinal folds, and their free margins, which are beautifully wavy, contain each a vessel, which follows the sinuosities of the fold, and sends off branches to the parietes of the oviduct. Towards the terminations of the oviducts

* Cuvier, *Leçons d'Anatomie Comparée*, tom. viii. 1846. VOL. III.

in the cloacal cavity (*s, s*), these folds gradually subside into a few simple plications.

In some species (*Mustelus, Cuv.*) of these viviparous Sharks a very close attachment is formed between the walls of the uterine portion of the oviduct and the contained ovum, so much so indeed as to remind the anatomist very forcibly of the placental connection that exists in the Mammifera. In these, according to J. Müller, the ovum, on its arrival in the oviduct, is only covered with a kind of membranous investment or chorion, which is as thin and delicate as the amnion of Mammalia, and without apparent organization. The sac which this membrane forms is seven or eight times as long as the vitellus, and its walls being regularly plicated, are embraced by corresponding folds of the lining membrane of the oviduct, so that there is a very intimate adhesion between the two.

In the oviparous races of the plagiostome cartilaginous Fishes the structure of the oviduct is somewhat different, in order to provide for the formation of the egg-shell or horny envelope wherein the egg is contained when extruded from the body, the organization of which is not a little curious. The glandular portion of the oviduct is extremely thick, or rather is enclosed in a dense glandular mass (*rudimental gland*), the substance of which is entirely made up of close-set transverse secreting tubes, which pour their secretion into the oviduct through innumerable orifices, which are aggregated together in a part where the course of the lining membrane of the oviducal canal is interrupted, and free passage thus left for the escape of the rudimental secretion, which, becoming thus deposited on the surface of the egg, hardens into a tough horny substance, which constitutes its external covering or egg-shell. The shape of these eggs is remarkable; the egg-shell when completed resembles an oblong horny pillow-case, the four corners of which are prolonged into tendril-like processes, the use of which appears to be that they serve as anchors by becoming interlaced with the branches of submarine plants or ramose corals, and thus preserve the egg and its delicate contents from being washed away by the agitation of the waves. From the tough coriaceous or horny texture of these egg-shells, another provision becomes necessary, in order that the mature embryo shall be enabled to escape from confinement and enter upon an independent existence. In the eggs of Birds this is abundantly provided for by the brittle texture of the calcareous substance in which they are enclosed, allowing the chick to break its way out of its fragile covering, a mode of egress which, in the case before us, would evidently be impracticable. This difficulty is met by a very beautiful contrivance. The horny walls of the eggs of the plagiostome Fishes are continuous all round, except at one extremity, where, to use a homely illustration, the end of the pillow-case remains unsewn, the edges of the slit thus left being merely kept in apposition by the elasticity of the horny envelope. By this elegant arrangement all intrusion from without is

effectually prevented, and at the same time, seeing that the valves will separate on the application of a very slight pressure from within, they soon yield to the efforts of the young fish to escape from its cradle, and afterwards close again so accurately that it is difficult, without attentive examination, to detect the existence of the fissure.

As amongst mammiferous animals certain races are provided with a marsupium or pouch, in which their immature young are carried about for a considerable period previous to their birth, so do we find certain Fishes provided

Fig. 539.

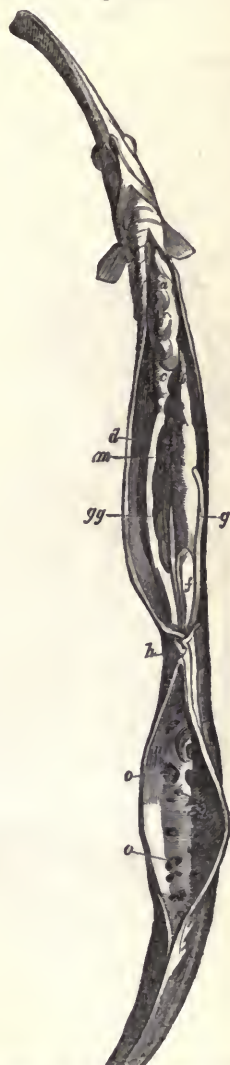

Viscera of *Syngnathus acus* (male).

a, liver; *b*, communication between the swimming bladder and the alimentary canal; *c*, stomach; *d*, intestine; *f*, allantoic bladder; *g*, *gg*, testes; *m*, kidney; *n*, marsupial pouch; *o, o*, cells in interior of ditto.

with a similar marsupial apparatus, in which the eggs are hatched and the young permitted to arrive at their full development prior to their expulsion. These are the *Syngnathidæ*, or pipe-fishes. There is, however, this remarkable difference between the mammiferous marsupials and these singularly organized genera, namely, that in the former it is the female that is furnished with the marsupial pouch, whereas in the *Syngnathidæ* the male only is so provided. In *fig. 539*, representing the male of *Syngnathus acus*, the marsupial apparatus is well exhibited; it consists of two large valves (*n*) situated beneath the tail, immediately posterior to the cloacal orifice. The internal surface of this pouch is indented with deep cells (*o, o*), more especially towards its posterior surface, where the ova are principally lodged. Here the eggs are hatched, after which the young *Syngnathi* are retained in the pouch for a considerable period before they are finally expelled.

In the female *Syngnathus* there is no sub-caudal pouch developed, but in this sex the vulva is unusually prominent, apparently for the purpose of facilitating the conveyance of the ova into the marsupium of the male.

In *Syngnathus ophidion* (Bloch) the ova, after extrusion from the female and impregnation, become attached to the cellular surface of the ventral parietes of the abdomen of the male, but are not protected by cutaneous processes or valves.

Urinary apparatus.—The kidneys in Fishes, as in all other Vertebrata, are two in number, situated on each side of the spine. They are, however, in the class before us remarkable for their very great proportionate size, sometimes extending from the anterior boundary of the abdomen quite to its posterior extremity, and occasionally uniting together in the mesial plane, so as to have the appearance of being but a single gland. Internally they present no division into cortex and fasciculate ducts terminating in a pelvic cavity, but their parenchyma is homogeneous, being entirely composed of arborescent ducts, which are immediately continuous with the ureters, which, running along the anterior surface of the kidney, receive the uriferous tubes as they pass along towards the cloaca, where they terminate. Most commonly there is a distinct urinary or allantoic bladder situated behind or dorsad to the

rectum (*fig. 539, f*), which, in some species, is bifid at the anterior extremity, as in the Frog and other amphibia.

Occasionally the urinary canals unite and terminate by a common duct (*ureter*) upon a fleshy tubercle or penis-like projection of the walls of the cloaca, as in the female Shark (*fig. 538, t*), where a bristle is represented introduced into the extremity of the urinary passage.

Renal capsules.—In the osseous Fishes these organs are supposed to be represented by two or sometimes three roundish bodies of a light grey colour, situated sometimes near the middle, oftener at the hinder extremities of the kidneys, at or near the entry of the hæmal canal; sometimes they lie free, sometimes they are imbedded in the renal tissue (Pike, Salmon, Eel); but they always possess a proper capsule and present a minutely granular texture without distinction of cortical and medullary parts.* In the yellowish suprarenal bodies of the Sturgeon, the granules are minute spherical cells filled by microscopic nucleated corpuscles. In the Plagiostomes they are represented by elongated narrow yellowish bodies situated behind the kidneys, and sometimes extending behind the dilated ureters.

BIBLIOGRAPHY.—*Cuvier*, Leçons d'anatomie comparée, 8vo. 1846. *Cuvier et Valenciennes*, Histoire naturelle des poissons, 4to. 1828. *Haller*, Opera minora, vol. iii. *Monro*, Structure and physiology of Fishes, fol. 1785. Observations on the organ of hearing in man and other animals, 4to. 1797. *Scarpa*, De auditu et olfactu, fol. 1789. *Comparetti* de aure interna comparata, 4to. 1789. *Hewson*, Phil. Trans. vol. lix. *Cavolini*, Memoria sulla generazione dei pesci e dei granchi, 4to. 1787. *Autenrieth*, Anatomie de la plie. *Wiedemann's* Archiv, tom. i. 1800. *Geoffroy St. Hilaire*, Annales des Museum d'Hist. Nat. t. ix. & x. *Rosenthal*, Ichthyomische Tafeln, 4to. 1812-22. *Spiz*, Cephalogenesis, fol. 1815. *Carus*, Lehrbuch der Zootomie, 8vo. et 4to. 1818. Erlangerungs-tafeln zur vergleichenden anatomie, fol. 1826. *Weber*, De aure et auditu. *Van der Hæven*, Dissertatio philosoph. de scleto piscium, 8vo. 1822. *Bakker*, Osteographia piscium, 4to. 1822. *Mechel*, Traité d'anat comp. 8vo. 1828-9. *Owen*, Lectures on comparative anatomy, Lond. 1847.

* Owen's Lectures, (Pisces, p. 285.)
(*T. Rymer Jones.*)

PLACENTA. See OVUM (*Supplement*) and UTERUS.



ANALYTICAL INDEX

TO THE

THIRD VOLUME.

INSTINCT. 1

- Instincts* designed for the preservation of the individual, 7
defence and offence, 7
relating to the procuring of food, 7
construction of habitations, 9
connected with hibernation, 11
instincts for the propagation and support of offspring, 13
migration, 13
choice of place for the deposit of ova, 14
nidification, 14
incubation, 14
procuring nourishment and protection for the young, 15
instincts relating to the welfare of the race or of the animal creation generally, 15
common to man and brutes, 15
motives of action contrasted with intellect, 16
congregation, 16
imperfect societies of insects, 16
for society alone, 16
of males in the pairing season, 16
for emigration, 16
for feeding together, 16
for some common work advantageous to the community, 17
of the higher animals for various purposes, 17
perfect societies of insects, as ants and bees, 18
reasons for considering the actions of ants and bees as the result of instinct, not of reasoning, 20
instances of actions of the lower animals in which short processes of reasoning seem to have been concerned, 21
acquired instincts, 23
instinct viewed with respect to the part it takes in the unceasing changes going on at the earth's surface, 23
free will in man, 24
instinct viewed with respect to final causes, 25
Intestinal Canal, see *Stomach and Intestinal Canal*
- Irritability*
definition and use of the term, 29
test of irritability, 29
question whether irritability belongs to the muscular fibre alone, or to the muscular and nervous combined, 29
arguments drawn from phenomena observed in the heart and other involuntary muscles, 29
Legallois's and Phillip's experiments of removing the spinal marrow, 29
experiment showing that the heart may be impressed through the ganglionic system after the removal of the brain and spinal marrow, 29
effect of narcotics on the heart and bowels, 30
vis insita in connection with vis nervosa, 30
new laws of action of the vis nervosa, 30
degree of irritability not the same in every organ of the body, 30
different degrees of irritability in different animals, 31
relation of the degree of irritability to respiration, 31
I. Of the pneumatometer, 31
II. Of the measure of irritability, 33
difference in the duration of the beat of the heart removed from the body in the fetal, early, and adult states of the higher animals, 34
duration of the beat of the heart longest on the left side, 34
experiment showing the effect of artificial respiration on the heart's beat, 34
deduction that arterial blood is the necessary stimulus

Irritability (continued).

- of the left side of the heart, but that venous blood is a sufficient stimulus of the right, 35
the power of enduring suspended animation a measure of irritability, 35
observations on the irritability of the heart in hibernating animals, 35
properties of activity and tenacity of life, 35
source of irritability, 36
observations of Prochaska, 36
of Nysten, 36
of Legallois, 37
observations of Müller, 37
observations of M. Segalas on the effects of strychnine, 31
observations and experiments of the author, 38
explanation of the discrepancies of former authors, 39
deductions, 40
application of the principle deduced to pathology, 40
influence of emotion on paralytic limbs, 40
influence of certain respiratory acts, 40
effects of the tonic power, 40
effect of strychnine on paralytic limbs, 40
influence of the brain and spinal marrow respectively on the anterior and posterior limbs respectively, 40
cases substantiating the foregoing observations, 41
recapitulation, 42
experiments of Dr. J. Reid, 42
experiments testing the relation of the ganglionic system to the irritability of the viscera, 43
- Joint*, see *Articulation* and the articles under the headings of the several joints
- Kidney*, see *Ren*.
- Knee-joint (Normal Anatomy)*, 44
bones, 44
cartilages, 45
semilunar cartilages, 45
ligaments, 46
synovial capsule, 46
mechanical functions, 47
adjacent bursa, 48
arteries and veins, 41
comparative anatomy of the knee-joint, 48
- Knee-joint (Abnormal Conditions of)*, 48
disease, 48
simple acute inflammation of the knee-joint or arthritis genu, 49
example of acute arthritis genu, 54
simple chronic inflammation of the knee, 55
description, 55
cases, 56
chronic rheumatic arthritis genu, 57
cases, 58
anatomical characters, 60
white swelling, or chronic strumous arthritis genu, 60
anatomical characters, 62
acute arthritis genu combined with acute osteitis, 64
with necrosis, 64
abscess without necrosis, 65
displacements occurring in chronic necrosis in the vicinity of the knee, 65
of the tibia backwards, 65
rotation of the tibia outwards the patella on the outer condyle of the femur, 65
with the tibia displaced backwards also, 66
abnormal conditions resulting from accident, 67

Knee-joint (continued).

- fractures, 67
 - transverse fracture of the femur immediately above the condyles, 67
 - oblique fracture of the lower end of the femur, 67
 - into the knee-joint, 68
 - by detachment of the outer condyle, 68
 - by detachment of the inner condyle, 68
 - T fracture, 68
 - fractures of the tibia near the knee, 69
 - transverse, 69
 - oblique into the joint, 69
 - fracture of the patella, 69
- dislocations, 71
 - of the femur from the tibia, 71
 - of the femur backwards, 71
 - of the femur forwards, 72
 - lateral dislocations of the knee, 72
 - of the femur inwards, 72
 - of the femur outwards, 72
 - dislocations of the patella, 73
 - outwards, 73
 - inwards, 73
 - incomplete luxation of the patella, 73
 - dislocation of the patella on its edge, 74
 - internal derangement of the knee, 75
 - sprains, 76
 - a small fragment of the tibia (the insertion of the crucial ligament) torn up, 77
 - rupture of the quadriceps extensor tendon from its insertion into the patella, 77
 - rupture of the ligamentum patellæ, 78
- Lachrymal Organs* (all the accessory or protecting parts of the eye except the orbit and muscles), 78
 1. The eyelids, 78
 - general description, 78
 - Rima palpebrarum, 79
 - movements of the eyelids, 79
 - winking, 79
 - Meibomian follicles, 79
 - adaptation of the eyelids, 79
 - canthi, 79
 - secondary fissure of inner canthus, 79
 - lachrymal papilla and puncture, 80
 - lacus lachrymalis, 80
 - lachrymal caruncle, 80
 - plica semilunaris, 80
 - eyelashes, 80
 - skin of the eyelids, 80
 - eyebrows, 80
 - action of the eyelids in concert with the iris, 80
 - internal structure of the eyelids, 81
 - tarsal ligaments, 81
 - tarsal cartilages, 81
 - fibrous condition of the lower tarsal cartilage in man, and of both in the lower mammalia, 81
 - Meibomian follicles lie in the substance of the tarsal cartilage, 81
 - external palpebral ligament, 81
 - internal palpebral ligament, 81
 - orbicularis palpebrarum, 81
 - levator palpebræ superioris, 82
 - palpebral conjunctiva, 82
 - skin of the eyelids, 82
 - cellular tissue of the eyelids, 82
 - roots of the eyelashes, 82
 - sebaceous follicles, 82
 - Meibomian glands, 82
 - comparative anatomy of, 83
 - secretion of, 83
 - hordeolum, 83
 2. Conjunctiva in general, 83
 - oculo-palpebral space of the conjunctiva, 83
 - superior and inferior palpebral sinuses of the conjunctiva, 84
 - folds of the conjunctiva, 84
 - lachrymal caruncle, 84
 - plica semilunaris, 84
 - membrana nictitans, 85
 - palpebral conjunctiva, 85
 - ocular, 85
 - subconjunctival cellular tissue, morbid condition of, 85
 - nature of the conjunctiva, 85
 - continuity with other parts of the mucous membrane, 85
 - lachrymal and conjunctival secretion, 85
 - intimate structure of palpebral conjunctiva, 85
 - papillary body, 85
 - epithelium, 87
 - intimate structure of sclerotic conjunctiva, 86
 - papillæ, 86
 - epithelium, 87
 - conjunctival covering of the cornea, 87
 3. Lachrymal organs properly so called, 88
 - lachrymal gland, 88
 - intimate structure, 89
 - excretory ducts, 89
 - tears, 90
 - chemical composition, 90
 - derivative lachrymal organs, 90
 - lachrymal groove, 90

Lachrymal Organs (continued).

- osseous canal for the lachrymal duct, 90
 - lachrymal papillæ, points and canalicules, 91
 - lachrymal sac, 91
 - nasal duct, 92
 - structure, 92
 - plicæ and villi, 92
 - secretion, 92
 - lachrymal muscle (tensor tarsi), 92
 - origin, 92
 - relations, 92
 - action, 93
 - nerves, 93
 - fifth nerve, 93
 - frontal division, 93
 - inferior palpebral, 93
 - seventh nerve, 93
 - third pair, 93
 - bloodvessels, 93
 - arteries, 93
 - distribution of vessels to the conjunctiva, 93
 - Comparative anatomy and development, 94
 - I. Eyelids, 94
 - in Man, 95
 - in Birds, 95
 - in Chelonia, 95
 - in Lizards, 95
 - in Fishes, 95
 - in Cephalopoda, 95
 - in Mammalia, 95
 - in Birds, 95
 - II. The conjunctiva, semilunar fold, membrana nictitans or third eyelid, lachrymal caruncle and glandule of Harder, 96
 - oculo-palpebral space, 96
 - in serpents, 96
 - membrana nictitans, 96
 - cartilage of the membrana nictitans, 97
 - muscles, 97
 - third eyelid of Birds, 97
 - muscles, 97
 - quadratus, 97
 - pyramidalis, 97
 - action, 97
 - in the Owl and Parrot, 97
 - in Chelonia and in the Frog, 97
 - glandule of Harder, 98
 - in Mammalia, 98
 - in Birds, 98
 - in Reptiles, 98
 - secretion, 98
 - III. Secreting and derivative lachrymal apparatus, 98
 - in Mammalia, 98
 - in Birds, 98
 - in Reptiles, 98
 - Sauria and Chelonia, 98
 - Ophidia, 98
 - lachrymal bone, 99
 - infra-orbital glandular sacs of ruminants, 99
 - development of the accessory parts of the eye, 99
 - eyelids, 99
 - tarsal cartilages, 99
 - lachrymal gland, 99
 - inner canthus, 99
 - lachrymal caruncle, 99
- Larynx*, 100
 - general description, 100
 - cartilages, 100
 - cricoid, 101
 - thyroid, 101
 - arytenoid, 102
 - cornicula laryngis, 102
 - cuneiform cartilages, 103
 - epiglottis, 103
 - articulations and ligaments, 103
 - extrinsic articulations, 103
 - hyo-thyroid articulation, 103
 - ligamentum thyro-hyoideum medium, 104
 - ligamenta hyo-thyroidea lateralia, 104
 - ligaments of the epiglottis, 104
 - ligamentum thyro-epiglottideum, 104
 - ligamentum hyo-epiglottideum, 104
 - ligamentum glosso-epiglottideum, 104
 - tracheo-cricoidæ articulation, 104
 - intrinsic articulations, 104
 - crico-thyroid articulation, 104
 - crico-thyroid ligament, 104
 - lateral crico-thyroid ligament, 105
 - crico-arytenoid articulation, 105
 - thyro-arytenoid ligaments or chordæ vocales, 105
 - inferior, 105
 - superior, 105
 - muscles, 105
 - extrinsic, 105
 - intrinsic, 105
 - crico-thyroidei, 105
 - action, 106
 - crico-arytenoidi laterales, 107
 - arytenoidi, 107

Larynx (continued).

- obliquus, 107
 - transversus, 107
 - thyro-arytenoidei, 108
 - action, 109
 - crico-arytenoidei postici, 109
 - thyro-epiglottidei, 110
 - aryteno-epiglottidei, 110
 - action, 110
 - recapitulation of the action of the intrinsic muscles of the larynx, 110
 - bloodvessels, 110
 - structures called glands, 110
 - arytenoid gland, 110
 - epiglottic gland, 111
 - mucous membrane, 111
 - glosso-epiglottic folds, 111
 - aryteno-epiglottic folds, 111
 - rima glottidis, 111
 - pomum Adami, 112
 - ventricles of the larynx, 112
 - nerves, 112
 - superior laryngeal, 112
 - inferior or recurrent laryngeal, 113
 - functions of the laryngeal nerves, 113
 - motions of the glottis during respiration, 113
 - phenomena observed when the recurrent nerves are diseased, compressed, or cut, 113
 - spasmodic closure of the rima glottidis, 113
 - laryngismus stridulus, 113
 - description of the larynx deprived of its extrinsic muscles, 114
 - anterior aspect, 114
 - lateral, 114
 - posterior, 114
 - inferior, 114
 - internal, 114
- Larynx (Morbid Anatomy and Pathology), 114*
- general remarks on the recency of accurate knowledge of the abnormal conditions of the larynx, 114
 - general remarks on diseased conditions of the laryngeal mucous membrane, 115
 - of the submucous tissue, 115
 - of the cartilages, 115
 - of the muscles, 115
 - of the ligaments, 115
 - acute inflammation of the mucous membrane, 115
 - of the child, or croup, 115
 - adventitious membrane, 116
 - post mortem appearance of the lungs and brain, 116
 - of the adult, 116
 - œdema of the submucous tissue, 116
 - varieties, 117
 - idiopathic, 117
 - traumatic, 117
 - œdema without evidence of inflammation, 117
 - causes of death, 117
 - spasm of the glottis, 117
 - diphtherite, 117
 - scarlatina anginosa or angina maligna, 117
 - symptoms and appearance, 117
 - sloughing, 118
 - thickening by gradual deposit, 119
 - ulcers, 119
 - gangrene of the softer tissues of the larynx, 120
 - diseased condition of the cartilages of the larynx, 120
 - phthisis laryngea, 120
 - alteration in size and shape of the epiglottis, 122
 - morbid thickening, or shrinking, 122
 - leaf-like expansion, 122
 - derangements of the functions of the larynx unattended with organic change, 122
 - exceptions to the use of the epiglottis, 122
 - epiglottis inert, 123
 - condition of the epiglottis in an animal asphyxiated by carbonic acid, 123
 - pathological conditions of the muscles of the larynx, 123
 - diseased conditions of the laryngeal ligaments, 126

Leg (Regions of the), 126

 - general survey, 127
 - external form of the leg, 127
 - calf, 127
 - integument, 127
 - varicose condition of the capillaries of the integument, 128
 - superficial fascia, 128
 - superficial veins, 128
 - major saphena, 128
 - minor saphena, 128
 - varicose ulcer, its treatment, 130
 - superficial nerves, 130
 - internal saphenus, 130
 - external saphenus or communicans tibialis, 130
 - superficial lymphatics, 130
 - aponeurosis, 130
 - of the anterior region, 130
 - of the posterior region, 130
 - superficial layer, 130
 - deep layer, 130
 - anterior region of the leg, 131

Leg, Regions of the, (continued).

- muscles, 131
 - anterior tibial artery, recurrent tibial, 131
 - operations for ligaturing, varieties, 132
 - relations, 132
 - posterior region of the leg, 132
 - muscles, 132
 - superficial layer, 132
 - gastrocnemius and soleus, 132
 - division of the tendo Achillis, 132
 - plantaris, 133
 - deep layer, 133
 - arteries, 133
 - posterior tibial, 133
 - course, 133
 - relations, 133
 - operation for ligaturing, 133
 - peroneal, 134
 - course, 134
 - relations, 134
 - operations for ligaturing, 134
 - venæ comites, 134
 - nerve, 134
 - deep lymphatics, 134
 - difficulty of preserving the proper position of the fibula in fracture, 135
 - precaution with respect to the projecting angle which the tibia, when amputated, presents anteriorly, 135
 - arteries requiring ligatures in amputation, 135
 - remarks on the application of artificial legs, 136
 - the most eligible situations for exposing the tibia in order to trephine, &c., 136
 - liability of the tibia to disease, 136
 - curve of the tibia, 136
 - fractures of the leg, 136
 - of the fibula alone, 136
- Leg (Muscles of the), 137*
- anterior group, 137
 - tibialis anticus, 137
 - extensor longus digitorum, 137
 - relations, 137
 - action, 137
 - extensor proprius pollicis, 137
 - action, 137
 - relations, 137
 - peroneus tertius, 137
 - relations, 137
 - action, 138
 - external group, 138
 - peroneus longus, 138
 - action, 138
 - relations, 138
 - peroneus brevis, 138
 - combined action, 138
 - posterior group, 138
 - superficial layer, 138
 - gastrocnemius, 138
 - relations, 138
 - soleus, 138
 - relations, 139
 - tendo Achillis, 139
 - action, 139
 - plantaris, 139
 - action, 139
 - deep layer, 139
 - popliteus, 139
 - flexor longus digitorum, 139
 - accessory muscles, 139
 - relations, 140
 - flexor longus pollicis, 140
 - action, 140
 - tibialis, 140
- Life, 141*
- I. General views, 141
 - definition, 141
 - tendency of the changes exhibited by a living being, 141
 - method of prosecuting the inquiry, 141
 - difficulty in the attainment of general laws in some departments of science, 141
 - difficulties which beset the investigation of the laws of vital action, 142
 - conditions required for the production of vital actions, organized structure and stimulus, 142
 - vital properties due to the act of organization, 142
 - II. History of opinions, 143
 - abstract terms used in the earlier ages of the world expressing a vague idea of a property inlierent in a body that exhibits it, 143
 - the term life as applied by the older philosophers, 143
 - tendencies in the unenlightened mind from which the foregoing modes of explaining vital phenomena have resulted, 144
 - modification which the forementioned doctrines have undergone, 144
 - distinctness of life and mind, 144
 - doctrine of the vital principle put forth by Barthez, vis medicatrix naturæ of Hoffman and Cullen, nisus formativus of Blumenbach, organic agent of Dr. Prout, and organic force of Müller, 145
 - Hunter's doctrine of the vital principle, 145
 - precise import attached to the term, 146

Life (continued).

- Dr. Prout's definition, 146
- III. Nature and cause of vital action, 146
all changes the results of the properties of matter called into exercise by appropriate stimuli, 140
functions groups of vital phenomena, 146
dependence of vital actions upon external stimuli, 147
every class of organs is excited to action by its particular stimuli, 147
conditions of a more general nature requisite for the performance of vital actions, as heat, light, and electricity, 147
analogy of vital phenomena to those of the universe at large, 147
illustration—the earth, solar system, and universe, 147
illustration—the steam-engine, 148
conclusion—vital actions the properties of organs called into action by appropriate stimuli, 148
- IV. The connection between vitality and organization, 148
probability that the properties which give rise to vital action exist in all forms of matter or at least in all of those forms of it capable of becoming organized, 148
total change effected in the properties of certain forms of matter by their entrance into new combinations due to the act of combination, as analogous to vital properties being due to the act of organization, 149
no property distinct from the matter which exhibits it, or capable of being superadded to it or abstracted from it, analogy of the magnetic properties of iron to vitality considered, 149
evidence of vitality being due to the properties of matter in the condition of organized tissues, to be found in the vital actions themselves, 149
the assertion that the existence of organization implies a previous existence of life, considered, 150
many actions performed by living beings common to them and inorganic matter, 150
preparation of materials for organization, 150

- V. Changes in composition, 151
formation of proximate principles, 151
grounds for the assumption of a distinct set of vital affinities, 151
reasons for believing that the compounds with which organic chemistry supplies us have a similar constitution to that of inorganic compounds, 152
the arguments in favour of vital affinity drawn from the spontaneous decomposition of organic matter, considered, 152
organic matter, considered, 152
presumed impossibility of artificially producing organic compounds or proximate principles, considered, 153
artificial and natural conversion of gum, starch, and lignin into sugar, 153
catalytic action, 153
evolution of electricity during the ordinary processes of growth of plants and animals, 154
inability of chemists to produce organic compounds probably due to their want of acquaintance with the form or condition in which their components must be brought together in order to enter into the desired union, 154
conclusions deduced from the foregoing paragraphs of the chapter, 154

- VI. Vitality in a dormant or inactive condition, 154
dormant vitality of seeds, eggs, &c. 155
length of time during which the dormant vitality may be preserved, 155
dormant vitality of seeds, 155
dormant vitality of eggs, 156
agents which destroy the vitality of seeds and eggs such as are calculated to produce important changes in their structure and composition, 156
dormant vitality of plants and animals that have attained beyond the embryo condition, 156
preservation of dormant vitality due to the maintenance of normal constitution, 157
suspension of vital action under other circumstances, 157
hibernation of plants, 157
hibernation of animals, 157
animals enclosed in rocks and trees, 158
syncope, 158
suspension of vital action in parts of the human body, 159
opinion of Dr. Daubeny, 159

Liver (Normal Anatomy), 160

- situation, 160
form, 160
position, 160
relations, 160
ligaments, 160

Liver (continued).

- fissures, 161
lobes, 162
covering, 162
color, 162
dimensions, 163
chemical analysis of human liver, 163
of bullock's liver, 163
varieties in form, 163
varieties of position, 163
gall bladder, 164
relations, 164
coats, 164
excretory ducts of gall bladder and liver, 164
coats, 164
varieties in the gall bladder, 164
structure of the liver, 164
the terms lobule and acinus as used by Malpighi, Müller, and Kiernan, 165
Glisson's capsule, 166
vaginal portion, 167
interlobular portion, 167
lobular portion, 167
portal vein, 167
vaginal branches and vaginal plexus, 167
interlobular veins, 168
lobular veins, 168
abdominal and hepatic origins of the portal vein, 168
hepatic duct, 169
vaginal ducts and vaginal plexus, 169
interlobular ducts, 169
lobular ducts and lobular plexus, 169
termination of the biliary ducts, 170
vasculature of the biliary ducts, 170
mucous membrane and follicles of the biliary ducts, 171
hepatic artery, 171
vaginal arteries, 171
intra-lobular arteries, 171
lobular arteries, 171
distribution, 171
hepatic veins, 172
interlobular veins, 173
sublobular veins, 173
hepatic trunks, 173
lymphatics, 173
nerves, 174
progressive development of the liver in the animal series, 174
liver in Invertebrata, 174
in Vertebrata, 175
comparative anatomy of the gall bladder, 176
bile secreted from arterial blood in Invertebrata, formation of portal vein in the various Vertebrate classes, anastomoses of portal and caval veins, 176
hepatic veins of diving animals, 176
development of the liver in the embryo, 177
in the Fowl, 177
in the human subject, 177
uses of the liver, 178
secretion of bile, 178
anomalous opening of the portal vein into the vena cava, 178
quantity of the bile, 180
expulsion of the bile, 180
uses of the bile, 181
red and yellow substances of Ferrein, 181
researches of M. Dujardin, 182
- Liver (Pathological Anatomy), 182*
diseases of the serous membrane, 182
acute inflammation, 182
chronic inflammation, 183
depositions in the subserous tissue, 183
diseases of the mucous membrane, 183
disorders of the venous circulation, 183
general congestion, 184
hepatic venous congestion, 184
portal venous congestion, 184
errors of Müller and Cruveilhier, with regard to the structure of the liver, 185-6
disorders of the biliary excretion, 187
biliary congestion, 187
effects of obstruction of the gall ducts, 187
diseases of the parenchyma, 187
inflammation, 188
hypertrophy, 188
atrophy, 188
cirrhosis, 188
softening, 189
induration, 190
fatty degeneration, 190
abscess, 190
tubercle, 192
scirrhus, 192
medullary sarcoma, 193
seat of origin of carcinoma, 194
fungus hæmatodes, 194
melanosis, 194
disorders of function, 194
suppression of secretion of bile, 194
alterations in the physical properties of the bile, 195

- Liver, Pathological Anatomy of the (continued).*
alterations in the chemical properties of the bile, 195
biliary calculi, 195
entozoa, 196
- Luminousness, animal, 197*
I. Enumeration of luminous animals, 197
II. Characters and properties of animal light, 199
colour, 199
smell, 199
III. Circumstances in which light is given out and by which its intensity is affected, 199
natural circumstances, 199
temperature, 199
solar light, 199
lunar light, 199
abrupt collision with other bodies, 199
loud noises, 200
internal movements of the animals themselves,—will, &c. 200
artificial circumstances, 200
accumulated electricity and electrical currents, 200
immersion in various fluid and gaseous media, 200
pressure of their bodies, 201
removal of the luminous organs, and removal of these and other organs, 201
exposure to various degrees of heat and moisture, 201
immersion in vacuo, 201
removal from all foreign sources of light, 201
IV. Seat of luminousness in different animals, 201
V. Anatomy of light-giving organs, 202
VI. Geographical distribution of luminous animals, 203
VII. Theories of animal luminousness, 203
VIII. Uses of animal luminousness, 204
IX. Luminousness of animals not innate, and other allied phenomena, 204
luminousness of the human body, and emission of light from the eyes of vertebrate animals, 204
luminousness of dead fishes and other dead animals, 205
- Lung.—See Pulmonary Organs.*
Lymphatic and Lacteal System, 205
general description, 206
history of the discovery of the lymphatic vessels, 206
distribution of lymphatic vessels in the human subject, 206
structure, 208
inner tunic, 208
fibrous tunic, 208
lymph hearts, 209
external tunic, 209
valves, 209
mode of origin of the lymphatics, 211
lymphatic or absorbent glands, 217
bloodvessels, 218
nerves, 218
structure, 218
convoluted tube, 218
lymph, 219
analysis of, 220
microscopic appearance, 221
chyle globules, 221
analysis of chyle, 222
taken from the thoracic duct, 222
before reaching the thoracic duct, 223
- descriptive anatomy, 223
position of lymphatic glands, 224
in the lower and upper extremities, 224
in the cervical region, 224
on the head and face, 224
in the great cavities, 224
mesenteric glands, 224
bronchial glands, 224
thoracic duct, 224
right lymphatic trunk, 225
lymphatic vessels, 225
of the lower extremities, 225
superficial set, 226
of the exterior of the lower part of the trunk and external genitals, 227
course of the lymphatics in the neighbourhood of the iliac arteries and the aorta, 227
lymphatics of the testicle, 227
of the kidneys, 227
of the suprarenal capsules, 227
of the lower part of the intestines, 227
lacteals, 228
lymphatics of the stomach, 229
of the pancreas, 229
of the spleen, 229
of the liver, 229
deep, 229
superficial, 229
of the thorax and thoracic viscera, 229
of the thoracic parietes, &c. 229
of the lungs, 230
of the heart, 230
deep seated lymphatics of the upper extremity, 230
- Lymphatic and Lacteal System (continued).*
superficial, 231
lymphatics of the exterior of the upper part of the trunk, 231
vasa efferentia of the axillary glands, 231
superficial lymphatics of the head and face, 231
deep seated, 232
- Lymphatic System, Abnormal Anatomy, 232*
congenital variations from the normal distribution, 232
diseased conditions of the lymphatic and lacteal vessels, 233
inflammation, 233
ulceration and adhesion of the valves, 233
thickening of the coats, 233
varicosities, 233
diseased conditions of the absorbent glands, 233
inflammation acute and chronic, atrophy, 233
deposits, 233
tubercle, 233
cancer, melanosis, and encephaloid matter, 234
calcareous and carbonaceous deposits, 234
changes in the lymph, 234
- Mammalia, 234*
characteristics derived from
the circulatory system, 234
the secretory system, 235
the alimentary system, 235
the generative system, 235
the osseous system, 235
the nervous system, 235
the organs of sight, hearing, smell, and taste, 236
primary classification of Mammalia, according to Aristotle, 236
Ray, 237
Linnæus, 238
Pallas, 238
Cuvier, 239
subdivisions of the primary groups, according to Linnæus, 241
Cuvier, 241
affinities and classification of Mammalia according to Macleay and the Quinary school, 242
primary division into two sub-classes according to Owen, 244
orders arranged with regard to their affinities, 244
- Mammary Glands, 245*
human mamma, 246
position, form, 246
nipple, 246
cuticle, rete mucosum, cutis, 246
areola, 247
tubercles of the areola, 247
internal structure of the breast, 248
ligamenta suspensoria, 248
secreting portion of the gland, cellules, glandules, milk tubes, reservoirs, 248
arteries, 248
veins, 249
nerves, 249
absorbents, 249
mammary gland in the male, 250
comparative anatomy, 251
Kangaroo, 251
Ornithorhynchus, 251
Cetacea, 251
number of efferent ducts in various animals, 252
morbid anatomy, 252
inflammation, 252
hydatids, 252
chronic mammary tumour, 253
hypertrophy of the adipose tissue, 254
irritable tumour, 254
malignant diseases, 254
cutaneous cancer, 254
scirrhus, 255
carcinoma reticulare, 255
carcinoma alveolare, 255
soft cancer, fungus hæmatodes, and medullary cancer, 255
carcinoma fasciculatum, 256
melanosis, 256
- Marsupialia, 257*
essential external character, essential internal character, 257
general remarks on the geographical distribution, &c. of the Marsupialia, 257
classification, 258
tribe I. Sarcophaga, 258
genus Thylacinus, 258
Dasyurus, 259
Phascogale, 259
tribe II. Entomophaga, 259
group α , Gressoria, 260
genus Myrmecobius, 260
group β , Saltatoria, 260
genus Perameles, 260
Cheropus, 261
group γ , Scansoria, 261
genus Didelphis, 261
tribe III. Carpophaga, 262

- Marsupialia* (continued).
- genus Phalangista, 262
 - Petaurus, 263
 - Phascogaleus, 265
 - tribe IV. Poephaga, 265
 - genus Hypsiprymnus, 265
 - Macropus, 266
 - tribe V. Rhizophaga, 267
 - genus Phascologya, 267
 - osteology of the *Marsupialia*, 268
 - the skull, 268
 - composition of the cranium, 269
 - occipital bone, 269
 - temporal, 269
 - sphenoid, 271
 - parietal, 273
 - frontal, 273
 - lacrimal, 273
 - nasal, 273
 - Intermaxillary, 273
 - superior maxillary, 273
 - perforations of the bony palate, 273
 - cauity of the cranium, 274
 - inferior maxilla, 275
 - of the Phascolotherium and Thylacotherium, 275
 - vertebral column, 276
 - cervical vertebrae, 276
 - dorsal, 277
 - lumbar, 278
 - sacrum, 279
 - caudal vertebrae, 278
 - thorax, 280
 - ribs, 280
 - sternum, 280
 - pectoral extremities, 280
 - scapula, 280
 - clavicle, 281
 - humerus, 281
 - bones of the fore-arm, 281
 - carpus, 282
 - metacarpus, 282
 - phalanges, 282
 - pelvic extremities, 282
 - os innominatum, 283
 - marsupial bones, 283
 - femur, 284
 - patella, 284
 - tibia, 284
 - fibula, 285
 - tarsus, 285
 - metatarsus, 286
 - myology, 287
 - abdominal muscles in a male Phalanger, 287
 - external oblique, 287
 - internal oblique, 288
 - transversalis abdominis, 288
 - pyramidalis, 288
 - cremaster, 288
 - muscles of the pectoral extremity in *Perameles*
 - lagotis, 289
 - trapezius, 289
 - latissimus dorsi, 289
 - omo-anconeus, 289
 - serratus magnus, 289
 - supra-spinatus, 289
 - deltoides, 289
 - subscapularis, 289
 - teres major, 289
 - triceps extensor, 289
 - pectoralis major, 289
 - biceps, 289
 - pronator teres, 290
 - flexor carpi ulnaris and radialis, flexor sublimis digitorum, 290
 - flexor profundus, 290
 - pronator quadratus, 290
 - supinator longus, 290
 - muscles of the pelvic extremity, 290
 - in the Kangaroo; sartorius, &c., 290
 - in a *Dasyure*; sartorius and glutel, 290
 - in *Perameles lagotis*; sartorius, rectus femoris, and biceps flexor cruris, 290
 - in *Dasyurus macrurus*; plantaris, soleus, fibularis posticus, flexor longus pollicis, flexor communis digitorum, 290
 - in *Phalangista vulpinea*; muscles of the anterior part of the leg, 291
 - in *Perameles lagotis*; gastrocnemius, soleus, and plantaris, 291
 - nervous system, 291
 - brain, 291
 - spinal cord, 295
 - organs of sense, 296
 - digestive system, 297
 - mouth, 297
 - lips, 297
 - masticatory muscles, 297
 - teeth, 298
 - cheek pouches, 299
 - fauces, 299
 - alimentary canal, 299
 - sebaceous follicles of the rectum, 301
- Marsupialia* (continued).
- proper sphincter of the anus, 303
 - table of the length of the intestinal canal, in a few species, 304
 - salivary glands, 304
 - tonsils, 304
 - liver, 304
 - pancreas, 305
 - spleen, 305
 - absorbents, 305
 - blood, 305
 - heart, 306
 - arteries, 307
 - veins, 308
 - respiratory organs, 309
 - tracheal rings, 309
 - thyroid glands, 310
 - larynx, 310
 - epiglottis, 310
 - thyroid cartilage, 310
 - kidney, 310
 - supra-renal glands, 310
 - ureters and bladder, 310
 - male organs of generation, 310
 - testes, 310
 - vasa deferentia, 311
 - vesiculæ seminales, 311
 - membranous and prostatic portion of the urethra, 311
 - Cowper's glands, 311
 - penis, 311
 - spermatozoa, 312
 - erectores penis, 312
 - retractor penis, 312
 - levator penis, 313
 - sphincter cloacæ, 313
 - female organs, 313
 - ovaries, 313
 - (review of the female generative organs in other groups of vertebrate animals,) 316
 - uteri and vaginæ in various species, 316
 - arrangement of the vaginal rugæ, &c., 317
 - purposes answered by the different forms of the generative organs of marsupial females, 317
 - gelatinous-mucous secretion in the vagina, 318
 - clitoris, 318
 - development of *Marsupialia*, 318
 - review of the different opinions which have been expressed on the subject, 318
 - experiment performed with a view to ascertain the period of uterine gestation, the structure of the fetal envelopes, the conditions of the new-born young, &c. in the Kangaroo, 321
 - ovarian ovum, 323
 - examination and dissection of an embryo Kangaroo at about the twentieth day of utero-gestation, 323
 - condition of the fetus of the Kangaroo at a later stage of uterine development, 325
 - new-born fetus of the Kangaroo, 325
 - new-born fetus of *Didelphys Virginiana*, and subsequent growth of the young, 325
 - condition of the young of Kangaroo whilst in the marsupium, 325
 - relative size of the brain of the embryo Kangaroo compared with that of the embryo of the sheep, 326
 - traces of the umbilical vessels, urachus, &c. in the mammary fetus of Kangaroo, 326
 - dissection of a small mammary fetus of Kangaroo, 326
 - larynx of the mammary fetus of Kangaroo, 327
 - maturation of the mammary fetus, 327
 - mammary organs, 327
 - marsupium, 327
 - observations on the claims of the *Marsupialia* to be regarded as a natural group of animals, 328
 - table of classification of the *Marsupialia*, 330
- Membrane, 331
- Meninges, 331
- Microscope, 331
- I. Optical principles governing the construction of microscopes, 331
 - influence of convex and concave lenses on the rays of light passing through them, 331
 - spherical aberration, 334
 - correction, 334
 - Herschel's doublet, 335
 - chromatic aberration, 335
 - correction, 335
 - simple microscope, 336
 - (phenomena of ordinary vision), 337
 - convex lens, 337
 - Dr. Brewster's lens of diamond, sapphire, or carbuncle, 337
 - Dr. Wollaston's doublet, 338
 - (angle of aperture), 338
 - Coddington lens, 339
 - Stanhope lens, 339
 - compound microscope, 339
 - field glass, 340
 - Huyghenian eye-piece, 341
 - Mr. Holland's doublet microscope, 342
 - eye-pieces intended to increase the field, 342
 - achromatic combinations, method of varying the magnifying power, 343

Microscope (continued).

- test objects, 344
- II. Of the mechanical arrangements of microscopes, 344
- objects to be attained
- steadiness and firmness, 344
 - capability of accurate adjustment, 345
 - the power of placing the instrument in either a vertical or horizontal position, 345
 - simplicity, 346
- best means of carrying on dissections under a
- magnifying power, 346
 - dissecting instruments, 346
 - compressorium, 347
- ordinary compound, or simple, microscope, 347
- superior compound microscope, 349
- illumination, 351
- mirror, 352
 - direct light, 352
 - condenser, 353
 - achromatic condenser, 353
 - illumination of opaque objects, 354
 - condensing mirror, 354
 - Lieberkuhn's speculum, 354
 - back ground, 354
- III. Magnifying power of microscopes, 354
- measurement of the magnifying power of microscopes, 355
- micrometers
- micrometer-screw, 355
 - micrometer eye-piece, 355
 - micrometry by means of the camera lucida, 356
 - camera lucida, 356
 - the degree of minuteness of objects which the magnifying power of the microscope renders visible, 356

Milk, 358

- cow's milk, 358
- common milk globules, cream globules, and yellow granulated corpuscles, 358
 - butter, 359
 - casein, 359
 - aposepine, 359
 - sugar of milk, 360
 - lactic acid, 360
 - substances found in the ashes of cow's milk, 360
 - proportion of cream in cow's milk, 360
- colostrum, 360
- human milk, 361
- milk from the male breast, 362
- milk of the ass, 362
- mare, 362
 - goat, 362
 - sheep, 362
 - bitch, 362
- contamination of the milk by various ingesta, 362
- analogy of milk to blood, 362

Mollusca, 363

- general characters, 363
- nervous system, 364
- senses, 364
- muscular system, 365
- digestive system, 365
- circulatory system, 365
- respiratory system, 365
- urogenetic system, 365
- generative system, 366
- classification, 366

Monotremata, 366

- general characters, 366
- Echidna, 367
- Ornithorhynchus, 367
- osteology, 368
- skull, Echidna, 368
- occipital bone, 369
 - parietal bone, 369
 - temporal bone, 370
 - frontal bone, 370
 - nasal bone, 370
 - palate bone, 370
 - superior maxillary bone, 370
 - comparison with the skull of various Edentate and Marsupial animals, 371
- skull, Ornithorhynchus, 371
- occipital and temporal bones, 371
 - parietal and frontal bones, 371
 - foramina in the floor of the skull, 373
 - oblique canal traversing the squamous suture, 373
 - facial bones, 373
 - lachrymal foramen, 374
 - ridges on the outside of the cranium, 374
 - interior of the skull, 374
 - lower jaw, 374
- vertebral column, 374
- true vertebrae, 374
 - ribs and costal cartilages or sternal ribs, 375
 - sternum, 375
 - sacrum, 375
 - caudal vertebrae, 375
 - pectoral extremities, 376
 - pelvic extremities, 378
- muscular system, Ornithorhynchus, 379

Monotremata (continued).

- nervous system, 382
- brain, Ornithorhynchus, 382
- Echidna, 382
- spinal cord, Ornithorhynchus, 385
- Echidna, 385
- olfactory nerves, Ornithorhynchus, 385
- Echidna, 385
- optic nerves, 385
- eye, 385
- third and fourth pair of nerves, 386
 - fifth pair, 386
 - sixth and seventh pair, 386
 - acoustic nerve, 386
- ear, 386
- eighth and ninth pair of nerves, 386
 - brachial plexus, median nerve, 387
 - lumbar plexus, Ischiadic nerve, 387
- Digestive system, 387
- alimentary canal, Ornithorhynchus, 387
- Echidna, 387
- salivary glands, 388
- liver, 388
 - pancreas, 388
 - spleen, 389
- circulating system, 389
- blood, 389
 - heart, Ornithorhynchus, 390
 - Echidna, 390
 - aorta and great arterial trunks, 391
 - venae cavae and renal veins, 391
 - portal vein, 391
- respiratory system, 391
- lungs, 391
 - trachea, 391
 - larynx, 391
 - thymus and other glands, 391
- renal system, 391
- supra-renal bodies, 391
 - kidneys, ureters, 391
- organs of generation, 391
- male organs, 391
 - testicle, 392
 - penis, 392
 - levator and retractor muscles, 392
 - Cowper's glands, 392
 - female organs, 393
 - ovaries, 394
 - Fallopian tubes and uteri, 394
 - uro-genital canal, 394
 - common vestibule, 395
 - clitoris, 395
 - Cowper's glands, 395
 - products of generation, 395
 - ovum, 395
 - the young—Ornithorhynchus—external characters, 399
 - dissection, 399
 - mammary organs, 402
 - crural gland and spur, 405

*Monstrosity, vide Teratology.**Motion, Animal; Animal Dynamics; Locomotion; or Progressive Motion of Animals, 407*

general remarks, 407

Section I.

- fundamental axioms, 408
- composition and resolution of forces, 408
 - parallelogram of forces, 408
 - polygon of forces, 408
 - parallelepipedon of forces, 408
- centre of gravity, 409
- the lever, 410
- the pulley, 410
- of uniform motion, 411
- motion uniformly varied, 411
- the legs move by the force of gravity as a pendulum, 411
- mechanical effects of fluids on animals immersed in them, 412
- resistance of fluids, 413
- passive organs of locomotion, 413
 - bones, 413
 - joints, 415
 - ligaments, 415
- muscles, 416
 - force of muscles at various stages of their contraction, 418

Section II. Flying, 419

- flight of insects, 419
- Coleoptera, 421
 - Dermaptera, 421
 - Lepidoptera, 421
 - nocturnal Lepidoptera, 422
 - Neuroptera, 423
 - Hymenoptera, 423
 - Diptera, 423
- table showing the area of the wings and the weight of the body in various species of insects, 424
- flight of birds, 424
- use of the tail in flight, 429
- flight of fish and other animals, 429
- Dactylopterus and Exocoetus, 429

Motion (continued).

- Draco volans, 429
- Galeopithecus and Pteromya, 430
- Pterodactylus, 430
- Cheiroptera, 430
- amount of force necessary for aerial progression, 431
- Section III. Swimming, 431
 - ciliograde animals, 432
 - Porifera and Polypifera, 432
 - cirrigrade animals, 433
 - pulmograde animals, 433
 - syringograde animals, 433
 - vermiform animals, 434
 - aquatic insects, 434
 - Decapods, 436
 - Cephalopods, 436
 - Pteropods, 436
 - Fishes, 437
 - shaped like the salmon, cod, and mackerel, 437
 - flat fishes, 437
 - analysis of the act of swimming in fishes, 438
 - aquatic birds, 438
 - quadrupeds, 439
- Section IV. Progression on solids, 440
- Radiata, 440
 - Echinida, 440
- Annelida, 441
- Insecta, 441
 - apode larvæ of insects, 441
 - pedate larvæ, 441
 - perfect insects, 442
 - Myriapoda, 443
 - Arachnida, 444
 - Decapoda, 444
 - Gasteropoda, 445
 - Cephalopoda, 445
 - Ophidia, 445
 - Amphibia, 448
 - Sauria, 448
 - Lacertæ, 449
 - Chelonia, 450
 - birds, 450
 - mammiferous quadrupeds, 451
 - horse, 452
 - walk, 452
 - trot, 452
 - gallop, 453
 - Marsupialia, 453
 - Rodentia, 454
 - Ruminantia, 454
 - Proboscidea, 454
 - Carnivora, 455
 - Cheiroptera, 455
 - Quadrumania, 455
- Section V. Man, 456
 - the vertebral column, 456
 - the legs, 457
 - walking, 459
 - tables of the measure of the inclination of the trunk in various modes of progression, 460
 - estimate of forces employed in walking, 461
 - running, 471
 - the principles in which walking and running differ, 471
 - forces employed in running, 471
 - leaping or jumping, 474
 - in insects, 475
 - in quadrupeds, 477
 - in man, 478
 - increase of the respiration and circulation in progression, 479
 - the manner in which animal force is estimated, 480

Mucus.

- mucus of the nose, 482
- urinary mucus, 482
- intestinal mucus, 482
- question of the existence of any substance to which the term mucus should be applied, 483
- analyses of ovarian effusions, effusion of ascites, and serum, 483
- synthetical formation of mucus, 483
- mucus globules, 483
 - varieties of the mucus globule, 484
 - distinction of pus and mucus, 484

Mucous Membrane.

- ultimate structure of the mucous membrane, 486
- basement membrane, 486
 - kidney, 486
 - testis, 487
 - salivary glands, 487
 - liver, 487
 - pulmonary air-cells, 487
 - alimentary canal, 487
 - skin, 488
 - cutaneous follicles, 489
- epithelium, 489
 - lamelliform or scaly variety, 489
 - prismatic, 490
 - spheroidal, 491
 - non-ciliated and ciliated, 492
- elementary tissues appended to the mucous system, 492
- bloodvessels, 492

Mucous Membrane (continued).

- lactal and lymphatic vessels, 493
- nerves, 493
- areolar tissue, 494
- of the glands, 494
- topographical view of the mucous system in man, 495
- gastro-pulmonary tract, 495
- genito-urinary tract, 495
- peculiarities of the skin, mucous membranes, and glands, 496
 - skin, 496
 - mucous membranes, 496
 - glands, 497
 - liver, 497
 - kidney, 498
 - testis, 498
 - salivary glands, 498
 - mammary glands, 499
- general outline of the functions of the mucous system, 499
 - varieties in the qualities of the products secreted by different portions of the mucous system, 503
 - mucus, 503
 - conclusions, 504
 - review of researches, 504
- Muscle*, 506
 - general description of muscular tissue, 506
 - characteristics of voluntary and involuntary muscles, 506
 - a. striped elementary fibre, 506
 - length, 507
 - thickness, 507
 - figure, 507
 - colour, 507
 - internal structure, 508
 - microscopical appearance, 508
 - transverse stripes, 508
 - longitudinal lines, 508
 - discs, 508
 - fibrillæ, 508
 - primitive particles, or sarcoous elements, 510
 - table of diameters, 510
 - Dr. Barry's opinion of spiral threads, 510
 - corpuscles, 511
 - sarcolemma, 512
 - adhesion to elementary fibre, 512
 - use, 513
 - attachment of the extremities of the fibres to other structures, 513
 - development, 513
 - b. unstriped elementary fibres, 514
 - c. mode of aggregation of the elementary fibres, 514
 - connecting areolar tissue, 516
 - bloodvessels, 516
 - venæ comites accompanying arterial branches, 516
 - proper capillaries, 516
 - nerves, 517
 - d. distribution of the striped and unstriped fibre, 517
 - striped, 517
 - unstriped, 518
 - e. distribution of the striped and unstriped fibres in the animal kingdom, 519
 - f. chemical constitution, 519
- Muscular Motion*—
 - contractility, 519
 - a property inherent in muscular fibre; doctrine of the 'vis insita', 519
 - source, 520
 - relation of contractility to the state of nutrition of the organ, 521
 - Dr. John Reid's experiments, 521
 - evidence furnished by cases of cerebral paralysis, 521
 - corroborations afforded by the fact that throughout the animal kingdom the vascular supply is accurately proportioned to the muscular irritability, 521
 - stimuli of muscular contraction, 521
 - remote, 522
 - immediate, 522
 - visible changes occurring in muscle during contraction, 522
 - in the whole organ, 522
 - in the elementary fibre, 522
 - in the discs, 523
 - in the fibrillæ, 523
 - passive contraction, 524
 - active contraction, 524
 - muscular fatigue, 524
 - appearances presented by the elementary fibre during the contraction, 524
 - emission of sound, 526
 - development of heat, 526
 - appearances presented by ruptured muscle, 526
 - opinions of various observers as to the nature of contraction, 529
- Muscular System, (Comparative Anatomy of).*
 - shown to be in conformity with the development of the nervous system, 530
 - non-existent in the Acrita, 533

Muscular System (continued).

- as apparent in the Nematoneura, 534
 in Culex, 534
 in Bryozoa, 535
 in Rotifera, 535
 in Epizoa, 536
 in Echinodermata, 537
 Encrius, Comatula, 537
 Asterias, Echinus, 537
 Holothuria, Siponculus, 537
 in the Homogangliata, 537
 in Annelida, 538
 in Myriapoda, 538
 in Insecta, 538
 in Arachnida, 539
 in Crustacea, 540
 in the Heterogangliata, 540
 in Gasteropoda, 540
 in Pteropoda, 541
 in Cephalopoda, 541
 in Vertebrata, 541
 vertebral system, 541
 costal system, 542
 hyoid system, 542
 opercular system, 543
 muscles of the limbs, 543
 in skates and rays, 543
 in Lepido-siren, 543
 in Siren lacertina, 543
 in Proteus, 543
 in Ophidia, 543
 in Sauria, 543
 muscles used in mastication, 543
 tegumentary system, 543
 vocal system, 544
 diaphragm, 544
 lingual system, 544
 ocular system, 544
 aural system, 544
 nasal system, 544
 generative system, 544
- Myriapoda.*
 general description of the class, 544
 classification, 545
 anatomy and physiology, 547
 alimentary canal, 549
 respiratory system, 549
 circulatory system, 549
 foramina repugnatoria, 550
 nervous system, 550
 in Scolopendra, 550
 senses, 550
 organs of generation, 551
 ova, 553
 development of the embryo, 553
 history of the process according to the observations of Newport on the Julus, 553
 observations of Gervais on the growth of Lithobius, 560
- Neck.*
 1. Muscles, 561
 a. anterior vertebral group, 561
 longus colli, 561
 rectus capitis anticus major, 561
 b. lateral vertebral group, 561
 Intertransversales colli, 561
 rectus capitis lateralis, 561
 rectus capitis anticus minor, 561
 scalenus anticus, 562
 posticus, 562
 c. depressors of os hyoides, 562
 sterno-hyoid, 563
 sterno-thyroid, 563
 thyro-hyoid, 563
 omo-hyoid, 563
 digastric, 563
 stylo-hyoid, 564
 mylo-hyoid, 564
 d. connected with the tongue, 564
 hyo-glossus, 564
 stylo-glossus, 565
 genio-hyo-glossus, 565
 lingualis, 565
 genio-hyoideus, 565
 e. superficial on the side of the neck, 565
 sterno-cleido-mastoideus, 565
 platysma myoides, 566
 risorius Santorini, 566
2. Fasciæ, 566
 superficial or subcutaneous areolar tissue, 566
 cervical, 568
 pre-vertebral, 569
 cervico-thoracic septum, 570
3. Regional or surgical anatomy, 570
 superficial veins and nerves, 571
 mesial region of the neck, 572
 laryngotomy and the parts concerned, 573
 tracheotomy and the parts concerned, 574
 crico-tracheotomy, 574
 anterior-inferior triangle, 574
 thyroid body, 575
 bronchocele, 575
 oesophagotomy, and the parts concerned, 576

Neck (continued).

- anterior-superior triangle, 576
 glandulæ concatenatæ, 577
 posterior-superior triangle, 577
 posterior-inferior triangle, 577
 subclavian artery, and operations connected therewith, 576
 subclavian vein, 579
 jugular vein, 579
 thoracic duct, 579
 arteria innominata, and operations connected therewith, 580
 digastric space, 581
 posterior pharyngeal region, 582
 relations of the sterno-cleido-mastoideus, 583
 practical observations relating to the anatomy and diseases of the neck, 583
 diagnosis of tumours, 583
 collateral circulation after obliteration of the main arterial trunks, 584
 anomalous arrangements of the cervical vessels, 585
 remarks on the veins, 585
- Nervous System, 585*
 general observations on the disposition and composition of nervous matter, the nature of nervous actions, and the subdivisions of the nervous system, 586
 nervous matter, 586
 how disposed through the animal kingdom, 586
 chemical composition, 587
 Vanquelin's analysis, 187
 Fremy's method of analysis, 587
 cerebrie acid, 587
 oleophosphoric acid, 587
 cholesterine, 588
 variation of the quantity of phosphorus in different periods of life, and its small amount in idiocy, 588
 L'Heritié's analyses of cerebral matter of Infants, youth, adults, old men, and idiots, 588
 nervous actions, 588
 mental nervous actions, 588
 actions of perception, 588
 common sensibility, 588
 special sensibility, 589
 actions of emotion, 589
 physical nervous actions, 589
 contraction of the iris occasioned by the stimulus of light, 589
 deglutition, 589
 excitement of the respiratory muscles by the sudden application of cold to the surface of the body, 589
 reflex action, 590
 anatomical subdivision of the nervous system;—brain, spinal cord, and ganglions, 590
 nerve, 591
 structure of cerebro-spinal nerves, 591
 neurilemma, 591
 ultimate nervous fibre, 591
 tubular membrane, 591
 white substance of Schwann, 592
 flattened band of Remak, 592
 changes produced by the action of water and other re-agents, 592
 varicose appearance of nerve-tubes, 593
 table of measurements of nerve-tubes in Alan and the other Vertebrata, 593
 absence of anastomoses in nerve tubes, 593
 comparison of nervous with muscular tissue, 593
 branching of nerves, 594
 anastomosis, 594
 decussation of the primitive fibres within the trunk of a nerve, 594
 anastomosis of descending branch of the ninth nerve with the cervical plexus, 594
 commissure of optic nerve, 595
 anastomosis by fusion; Volkmann's observations, 595
 nervi nervorum, 595
 plexuses, 595
 origin of nerves, 595
 termination of nerves, 595
 in muscle, 596
 peripheral expansion of nerves on sentient surfaces, 596
 papillæ of the skin, 596
 retina and optic nerve, 596
 olfactory nerves, 597
 the auditory nerve, 597
 structure of the ganglionic nerves, 597
 neurilemma, 597
 ramification, 597
 peripheral distribution, 598
 plexuses, 598
 nerve-tubes, 598
 cells, 598
 gelatinous fibres, 599
 difference between the structure of the sympathetic and the cerebro-spinal fibre, according to Volkmann and Bidder, 599
 nerves of the Invertebrata, 600

Nervous System (continued).

- development of nerve, 600
- recapitulation, 601
- Nervous System, Comparative Anatomy of*, 601
 - in the Acrifera, 601
 - in the Polypifera, 601
 - Actinia, 601
 - in the Radiata, 602
 - in the Mollusca, 603
 - Tunicata, 603
 - Asciolia mammillata, 603
 - Phallusia intestinalis, 603
 - Conchifera, 603
 - Gasteropoda, 605
 - Limpet (Patella), 605
 - Chiton marmoratus, 606
 - Aplysia, 606
 - Scyllaea pelagica, 606
 - Limax ater, 606
 - in the Articulata, 606
 - Entozoa, 607
 - Rotifera, 607
 - Cirropoda, 607
 - Annelida, 607
 - Crustacea, 608
 - Myriapoda, 609
 - Arachnida, 609
 - Insecta, 609
 - Habara linearis, 610
 - Geotrupes stercorarius, 610
 - Dyticus marginalis, 611
 - Saturnia pavonia minor, 611
 - Mormo Maura, 612
 - motor and sensitive function of ganglionic and non-ganglionic cords, 613
 - concluding general remarks, 614
 - in the Vertebrata, 614
 - Pisces, 614
 - anatomy of the Amphioxus Lanceolatus, 615
 - neuro-skeleton, 615
 - nervous system, 616
 - brain of fishes, 618
 - weight of the brain compared with that of the body, 618
 - olfactory tubercles, or first cerebral mass, 618
 - optic lobes, or second cerebral mass, 619
 - cerebellum, or third cerebral mass, 619
 - Amphibia and Reptilia, 620
 - brain, 620
 - weight compared with that of the body, 620
 - olfactory tubercles, 621
 - brain and spinal cord of lizard, 621
 - optic lobes, 621
 - cerebellum, 621
 - Aves, 621
 - brain, 622
 - weight compared with that of the body, 622
 - cerebral hemispheres, 622
 - optic lobes, 622
 - cerebellum, 623
 - Mammalia, 623
 - table of the relative proportions of the brain and spinal marrow in the four classes of Vertebrata, 623
 - table of the relative proportions of the body and brain in the four classes of Vertebrata, 624
 - cerebral hemispheres, 624
 - corpus callosum, 625
 - ventricles of brain, 625
 - olfactory nerves, 625
 - optic lobes, 625
 - cerebellum, 625
 - table shewing the actual and relative lengths of the cerebral hemispheres and the cerebellum in the Mammalia, 626
 - general remarks in conclusion, 626

Nervous Centres.

- coverings of the nervous centres, 627
- coverings of the ganglions, 627
- coverings of the spinal cord and brain, 627
- dura mater, 627
 - spinal, 628
- cranial, 628
 - processes, 629
 - falx cerebri, 629
 - tentorium cerebelli, 629
 - falx cerebelli, 629
- vessels of the spinal dura mater, 629
- of the cranial dura mater, 629
- sinuses, 631
 - superior longitudinal, 631
 - inferior longitudinal, 631
 - strait, 631
 - torcular Herophilli, 631
 - lateral sinuses, 632
 - occipital, 632
 - petrosal, superior and inferior, 632
 - transverse, 632
 - caveinous, 633
 - circular, 633

pia mater, 633
of the spinal cord, 633

Nervous Centres (continued).

- of the brain, 634
- continuations of the pia mater into the cerebral ventricles, 634
- choroid plexuses of the lateral ventricles, 634
- velum interpositum, 635
- choroid plexuses of the fourth ventricle, 635
 - chrySTALLINE formations in the choroid plexuses, &c. 635
- connexions, &c. of the pia mater, 636
- in reference to pathology, 636
- arachnoid, 636
 - spinal, 636
 - cerebral, 637
- cerebro-spinal fluid, 637
 - fluid in the cerebral ventricles, 640
 - orifice of communication, as described by Majendie, between the fourth ventricle and the sub-arachnoid space, 640
 - estimate of the quantity of the sub-arachnoid fluid, 641
 - cerebro-spinal fluid in reference to pathology, 642
 - manner of its secretion, 645
 - physical and chemical characters, analyses, 645
 - use, 645
 - glandulæ Pacchioni, 644
 - are they natural structures? 645
 - ligamentum dentatum, 645
- general remarks on the structure of nervous centres, 646
 - white nervous matter, 646
 - grey nervous matter, 647
 - development, 648
 - remarks on the great simplicity of form of the elements of grey nervous matter, 649
 - pigment, 649
- structure of ganglions, 649
- cerebro-spinal centre, 650
 - spinal cord, 650
 - position, 651
 - shape, 651
 - bulk, 651
 - length and circumference, 651
 - fissures, 652
 - anterior, 652
 - posterior, 652
 - grey commissure, 652
 - internal structure as shewn by transverse sections, 652
 - conclusions, 654
 - is there a central canal in the spinal cord? 655
 - bloodvessels, 656
 - anterior spinal arteries, 656
 - posterior spinal arteries, 657
 - veins, 657
 - spinal nerves, origin, anterior and posterior roots, ganglion, 657
 - sub-occipital nerve, 658
 - characters proper to the nerves of particular regions, 658
 - cervical nerves, 658
 - dorsal nerves, 658
 - lumbar nerves, cauda equina, 658
 - relations of the roots of the nerves to the columns of the cord and to the grey matter, as determined by dissection, 659
 - as determined by physiology, 660
- encephalon, 661
 - size compared with that of the body in different animals, 661
 - compared with that of the encephalic nerves, 662
 - weight of the human encephalon, 662
 - table showing the average absolute weight of the human encephalon, in males and females, 662
 - relative weight of encephalon to cerebellum, &c. in males and females, 663
 - relative weight of entire body to encephalon, cerebrum, cerebellum, &c. 663
 - conclusions, 664
 - absolute weight of the brain of the elephant and whale, 664
 - weight of brain of some animals greater than that of man, relatively to the weight of their bodies, 664
 - conclusions of Tiedeman, deduced from his observations, 664
 - remarks on the comparison of the brain of man with that of the lower animals, 664
 - the brain in different races of mankind, 665
 - method of examining the brain, 667
 - method of Willis, 668
 - method of Reil, Gall, and Spurzheim, 669
 - surface of the encephalon, 670
 - superior and lateral surfaces, 670
 - base of the brain, 670
 - anterior segment, olfactory sulcus, 670

Nervous Centres (continued).

- fissure of Sylvius, locus perforatus anticus, island of Reil, 671
- middle segment, 672
- pituitary process, tuber cinereum, 673
- optic tracts and optic commissure, 673
- corpora albicantia, 673
- crura cerebri, intercercular space, substantia perforata, pons Tarini, 673
- transverse horizontal fissure, 673
- circle of Willis, 673
- posterior segment, 673
- dissection of the brain from above downwards, 674
- centrum ovale minus and majus, 674
- corpus callosum, longitudinal tracts, 674
- lateral ventricles, 674
- septum lucidum, 674
- fifth ventricle, 674
- parts seen in the lateral ventricles, 675
- fornix, 675
- third ventricle, 676
- pineal gland, 677
- anterior commissure, 677
- soft commissure, 677
- mesocephale, 677
 - corpora quadrigemina, 677
 - processus cerebelli ad testes, 677
 - valve of Vieussens, 678
 - pons Varolii, 678
 - cerebellum, 678
 - fourth ventricle, 678.
- Medulla oblongata, 678
 - anterior pyramids, 679
 - course of fibres, 680
 - restiform bodies, 682
 - posterior pyramids, 683
 - olivary columns, 683
 - corpus dentatum, 683
 - interpretation of the various columns, 684
 - nerves connected with the medulla oblongata, 684.
- Mesocephale, 684
 - pons Varolii, 685
 - corpora quadrigemina, 685
 - processus cerebelli ad testes, 686
 - valve of Vieussens, 686
 - conclusions, 686.
- Cerebellum, 687
 - fissures, 688
 - laminae, 689
 - square lobe, 689
 - amygdala, 689
 - biventral lobe, 689
 - slender lobe, 689
 - inferior and posterior lobe, 689
 - middle lobe, 689
 - superior vermiciform process, 689
 - inferior vermiciform process, 690
 - nodule, 690
 - posterior medullary velum, 690
 - spigot, 691
 - pyramid, 691
 - long and hidden commissure, and short and exposed commissure, 691
 - single commissure, 691
 - vertical section of cerebellar hemisphere, arbor vitæ, 692
 - vertical section of median lobe, 692
 - white and grey matter, 692
 - corpus dentatum, 692
 - crus cerebelli, 692
 - fourth ventricle, 693.
- Hemispheres of the brain, 693
 - convolutions, 693
 - primary convolutions in the fox, 696
 - in the dog, 696
 - in cats and hyænas, 696
 - in ruminants, 696
 - in the elephant, 696
 - in the monkey, 696
 - in the human subject compared, 696
 - symmetry, 696
 - constant convolutions in the human brain, 697
 - the insular convolution, 697
 - convolution of the Sylvian fissure, 698
 - insula of Reil, 698
 - pair of convolutions enclosing the olfactory process, 698
 - hippocampi, 698
 - direction of the white fibres in the convolutions, 698
 - corpora striata, 698
 - course of fibres, 699
 - vesicular matter, 699

Nervous Centres (continued).

- optic thalami, 700
- corpora geniculata, 700
- corpora mamillaria, 701
- commissures, 701
 - longitudinal, 701
 - superior longitudinal commissure, 701
 - longitudinal tracts, 701
 - fornix, 701
 - lemnæ semicircularis, 702
 - transverse, 702
 - corpus callosum, 702
 - anterior commissure, 702
 - posterior commissure, 703
 - soft commissure, 703
- tuber cinereum, 703
- pituitary body, 703
- ventricles of the brain, 704
- circulation in the brain, 704
 - arterial, 704
 - venous, 705
 - question as to whether the amount of blood within the cranium is liable to variation, 705
- encephalic nerves, 707
- Sketch of the microscopic anatomy of the spinal cord and brain, 707
 - of spinal cord, 707
 - medulla oblongata, 708
 - mesocephale, 709
 - cerebrum and cerebellum, 709.
- Brief statement of the probable modus operandi of the brain, 710.
- Abnormal anatomy of nerves and nervous centres, 712
 - regeneration of nervous matter, 712
 - abnormal anatomy of the spinal cord and its membranes, 712
 - membranes, 712
 - affections of the dura mater, 713
 - of the arachnoid, 713
 - of the pia mater, 713
 - cord, 713
 - absence of the cord, 713
 - partial deficiencies, 714
 - excessive congenital development, 714
 - hypertrophy, 714
 - atrophy, 714
 - induration, 714
 - softening, 714
 - suppuration, 715
 - effusion of blood, 715
 - tubercle, 715
 - cancer, 715.
- Abnormal anatomy of the brain and its membranes, 715.
 - membranes, 715
 - dura mater, 715
 - acute disease, 715
 - adhesion to the cranium, 715
 - patches of bone in the processes of the dura mater, 715
 - fibrous tumours, 715
 - cancer, 715
 - fungus of the dura mater, 716
 - effusion of blood, 716
 - arachnoid, 716
 - acute inflammation, 716
 - opaque condition of, 716
 - adhesion, 716
 - deposits of bone or cartilage, 716
 - effusions into the subarachnoid and arachnoid cavities, 716
 - of serum, 716
 - of blood, 717
 - of pus, 717
 - pia mater, 717
 - injected state of the vessels, 717
 - tubercle, 717
- brain, 718
 - congenital abnormal conditions, 718
 - absence of the brain, 718
 - brain of idiot, 718
 - fusion of the hemispheres together, 719
 - absence of the transverse commissures, 719
 - acquired or morbid conditions, 719
 - hypertrophy, 719
 - atrophy, 720
 - softening, 720A
 - white, 720A
 - red, 720B
 - suppuration, 720B
 - hyperæmia, 720C
 - anæmia, 720C
 - cerebral hæmorrhage, 720D
 - cancer, 720E
 - tubercle, 720E
 - entozoa, 720E
 - morbid states of the ventricles, 720E
 - thickened and opaque condition of the lining membrane, 720F
 - choroid plexus, deposit of lymph on, 720F

- Nervous Centres (continued).*
 earthy concretions in, 730F
 vesicles in—formerly regarded as hydroids, 730F
 pseudo-morbid appearances of the nervous centres and their coverings, 730F
 abnormal anatomy of nerves, 730G
 absence of, 730G
 inflammation, 730G
 atrophy, 730G
 hypertrophy, 730G
 tumours, 730G
- Nervous System, Physiology of the,* 730G
 vital endowments of nerves and of nervous centres, 730G
 nervous polarity, 730H
 sensitive and motor, incident and reflex nerves, 730H
 the stimuli of nerves, 730K
 mental stimuli, 730K
 physical stimuli, 730K
 effects of the galvanic stimulus, 730L
 of the conditions necessary for the maintenance of the power of developing nervous force, 730O
 of the nature of the nervous force, 730P
 is the nervous force electricity? 730Q
 conclusions, 730S
 of the functions of nerves, 730T
 of the functions of the roots of spinal nerves, 730U
 of the functions of the nervous centres, 730X
 of the functions of the spinal cord, 730X
 Whytt's views, 721B
 summary of Prochaska's work, 721C
 facts which demonstrate a power in the cord of exciting movements in parts which receive nerves from it by changes occurring in its substance, 721G
 stimulus applied to the cord, 721G
 substances exerting a peculiar influence upon the spinal cord, 721G
 strychnine, 721G
 opium, 721H
 cold, 721H
 ether, 721H
 sensitive impressions may be reflected by the cord, 721H
 enumeration of the functions of the body with which the spinal cord is immediately concerned, 721I
 Dr. Marshall Hall's doctrine, 721I
 tone of the muscular system, 721M
 conclusions, 721N
 of the office of the columns of the cord, 721N
 antero-lateral columns, 721O
 posterior columns, 721O
 manner in which the posterior columns may contribute to the exercise of the locomotive functions, 721Q
 middle or respiratory column of Sir C. Bell, 721R
 influence of the spinal cord upon the organic functions, 721R
 on the kidneys, 721S
 erection of the penis, 721T
 mechanism of the functions of the cord, 721T
 Dr. Marshall Hall's hypothesis of an excitatory system of nerves and true spinal cord, 721U
 hypothesis of Muller and others that every nerve-fibre in the body is continued into the brain, 721B
 Todd and Bowman's hypothesis that all the nerves are implanted in the grey matter of the segments with which they are connected, and do not pass beyond, 722B
- functions of the encephalon, 722I
 of the medulla oblongata, 722I
 corpora striata, 722L
 locus niger, 722M
 optic thalami, 722M
 corpora quadrigemina, 722O
 olivary bodies, and flocks of Reil, 722O
 mesocephale, 722P
 emotion, 722P
 diseases associated with disturbed state of emotion, 722Q
 of the cerebellum, 722Q
 coordination of movements, 722R
 Gall's views, connexion of the cerebellum with the sexual functions, 722S
 of the cerebral convolutions, 722X
 Dr. Wigan's doctrine of the duality of the mind, 722Z
 sensation, 722A
 volition and attention, 722A
 dreaming, 722B
 coma, 722B
 somnambulism, 722B
 delirium, 722B
 fibres of the centrum ovale, 722B
 of the commissures, 722D
- Nervous System, Physiology of the (continued).*
 corpus callosum, 723D
 fornix, 723D
 pons Varolii, 723E
 summary of the physiology of the encephalon, 723F
 physiology of the ganglions, 723F
 functions of the ganglions, 723F
Ninth pair of Nerves, 721
 origin and course, 721
 branches, 721
 of communication with the superior cervical ganglion, 721
 descendens noni, 721
 omo-hyoid branch, 721
 plexus, 722
 sterno-hyoid and thyroid branches, 722
 cardiac branch, 722
 thyro-hyoid branch, 722
 anastomoses with branches of the fifth, 722
 ultimate distribution, 722
 comparative anatomy, 722
 root of the ninth nerve in the ox, 722
 in birds, 723
 in fishes, 723
 physiology, 723
- Nose,* 723
 bones, 723
 structure of, 723
 cartilages, 723
 structure of, 727
 muscles, 727
 pyramidalis, 728
 levator labii superioris alæque nasi, 728
 triangularis, 728
 depressor alæ nasi, 728
 depressor septi narium, 729
 muscular fasciculi which dilate and compress the nostrils, 729
 rhomboideus, 729
 integuments, 729
 skin, 729
 mucous membrane, 730
 epithelium, 730
 course, 731
- nerves, 731
 olfactory, 731
 roots, 731
 tractus olfactorius, trunk, 732
 bulb, 732
 branches, 732
 septual, 732
 labyrinthine, 733
 other nerves, 733
 vessels, 733
 development of the nose, 734
 physiology of the nose, 735
- Nose, Morbid Anatomy of the,* 736
 congenital defects, 736
 diseases, 738
 of the skin, 738
 of the nasal cavities, 738
 simple abscess, 738
 thickening of the mucous membrane, 738
 ulceration, 739
 polypi, 739
 vesicular, 740
 gelatinous, 740
 fibrous, 740
 malignant, 740
- Nutrition,* 741
 the object of, 741
 materials required for nutrition, 742
 type of the process in cellular plants, 742
 elaboration of organizable materials, 742
 reduction of every proteine compound to albumen, 742
 change from albumen to fibrin, 743
 formation of tissue, 747
 homogeneous membrane and fibres formed from fibrin independent of cells, 748
 development of tissue that originate in cells, 750
 varying activity of the nutritive process, 751
 hypertrophy, 751
 atrophy, 752
 abnormal forms of the nutritive process, 753
 inflammation, 753
 suppuration, 754
 tubercle, 754
 parasitic growths, 755
 non-malignant, 755
 malignant, 756
 general summary, 756
- Oesophagus,* 758
 direction, 758
 dimensions, 758
 relations, 758
 structure, 758
 mucous membrane, 759
 oesophageal glands, 759
 vessels and nerves, 759
 function, 759

Esophagus (continued).

- abnormal anatomy, 760
- congenital malformation, 760
- acquired malformation, 760
- structural changes, 761
- stricture, 761
- morbid growths, 761

*Olfactory Nerves, see Nose and Smell.**Optic Nerves, 762*

- descriptive anatomy, 762
- apparent origin, 762
- tractus opticus, 762
- chiasma, 762
- optic nerve proper, 762
 - first stage, 762
 - second stage, 762
- communication with other nerves, 763
- organization, 763
- real origin, 763
- evidence derived from comparative anatomy, 764
 - Fish, 764
 - Reptiles, 764
 - Birds, 764
- in Man the optic nerves derive some roots from the tubercula quadrigemina, 765
- the tubercula quadrigemina probably fulfil other purposes besides that of affording origin to the optic nerves, 766
- the human optic nerve probably derives roots from the optic thalamus, 766
- corpora geniculata: their relation to the optic nerves, 768
- tuber cinereum: its relation to the optic nerves, 768
- of the chiasma of the optic nerves, 768
- in Invertebrata, 769
- osseous Fish, 769
- cartilaginous Fish, 769
- Birds, 769
- Amphibia and Reptiles, 769
- Mammalia and Man, 769
- use of the chiasma, 771
- some remarkable varieties of optic nerves, 774
- optic nerves in certain Cephalopods, 774
- optic nerves of the compound eyes of Insects, 775
- plated optic nerves, 776
- optic nerves in cyclops monsters, 777
- general development of the optic nerves in the higher classes of animals, 777
- functions of the optic nerves, 778
- the optic nerves when present are essential to vision, 778
- in those animals which possess special optic nerves the fifth pair are totally inadequate to support vision, 778
- absence of proof that the fifth pair is absolutely essential to sight, 778
- ordinary tactile sensibility, 780
- effects of stimulation, 780
- excito-motory properties, 781
- radiated or sympathetic sensations, 782

Orbit, 782

- bones, 782
- dissection of the orbit, 783
- periosteum, 783
- lacrimal gland, 784
- fourth nerve, frontal and lacrimal nerves, 784
- levator palpebræ superioris, 784
- rectus superior, 784
- obliquus superior, 785
- third nerve, nasal nerve, 785
- lenticular ganglion, 785
- optic nerve, 785
- ophthalmic artery, 785
- lacrimal artery, central artery of the retina, supra-orbital, ciliary arteries, muscular branches, ethmoidal, palpebral, nasal arteries and frontal arteries, 786
- ophthalmic vein, 786
- fifth nerve, inferior division of the third nerve, 787
- external, internal, and inferior recti muscles, 787
- inferior oblique, 787
- orbital portion of the superior maxillary nerve, temporal branch, malar branch, tunica vaginalis of M. O'Ferrall, 788
- action of the muscles, 788
- levator palpebræ, 788
- recti, 788
- obliqui, 789
- consensual movements of the two eyes, 791
- adaptation of the eye to distances, 792

Organic Analysis, 792

- I. Proximate analysis, 793
- manipulation, 793
- reagents, &c. 793
- desiccation, 793
- incineration, 794
- filtration, 795
- decantation, 795
- A. Analysis of animal fluids, 795
- 1, for the organic constituents, 795
- qualitative analysis, 795
- fibrin, 795

Organic Analysis (continued).

- albumen, 795
- fatty matters and cholesterol, 796
- sugar, 796
- urea, 796
- uric acid and the urates, 796
- quantitative analysis, 796
- process, 796
- special consideration of the different animal principles, 797
- fibrin, 797
- fatty matters, serolin and butyrin, 798
- albumen, 798
- casein, 798
- urea, 799
- sugar, 799
- uric acid, 800
- urobenzoic or hippuric acid, 800
- lactic acid, 800
- oxalic acid, 800
- 2. for the inorganic constituents, 801
- qualitative analysis, 801
- quantitative analysis, 802
- carbonic, phosphoric, and hydrochloric acid, 802
- sulphuric and phosphoric, 803
- iodine, fluorine, and sulphur, 803
- bases, 803
 - potash, soda, ammonia, 804
 - iron, lime, magnesia, lead, 804
 - copper, 805
- B. Analysis of animal solids, 805
- cholesterin, 805
- uric acid and urates, 805
- cystic oxyde, 805
- albumen and fibrin, 805
- gelatinous tissues, 806
- hairs, 806
- earthy phosphates, 806
- carbonate of lime, 806
- oxalate of lime, 806
- C. Proximate analysis of individual secretions, 807
- of the urine, 807
- healthy urine, 807
- diabetic urine, 808
- albuminous, 809
- of the blood, 809
- the serum, 810
- the clot, 810
- of milk, 811
- of bile, 811
- of saliva, 812
- II. Ultimate analysis, 813
- analysis of a solid not containing nitrogen, 814
- of a liquid not containing nitrogen, 816
- of a body containing nitrogen, 817
- method of determining the equivalent number of an organic substance, 819
- Osseous System, 820*
- general remarks, 822
- enumeration of the parts of a perfect vertebrate endo-skeleton, 823
- (skeleton of the Crocodile), 823
- spinal column, 823
- elements of a vertebra, 824
- autogenous parts, 824
- exogenous parts, 824
- skull, 825
- occipital vertebra, 827
- parietal vertebra, 827
- frontal vertebra, 827
- bones of the cranium, 828
- frontals, 828
- anterior frontals, posterior frontals, 829
- parietals, 829
- external occipitals, lateral occipitals, inferior occipital or basilar, 829
- sphenoid, alars, 829
- squamo-temporal, petro-temporal, 829
- ingrassial bones, 829
- ethmoid, vomer, nasal bones, 830
- inferior turbinated, 830
- maxillary, intermaxillary, 830
- suborbital, prenasal, supra-temporal, 831
- palatine bones, transverse bones, internal pterygoid, zygomatic, masto-temporal, 832
- styloid, symplectic, 833
- lower jaw, 833
- opercular, angular, articular, 833
- hyo-branchial apparatus, 833
- hyoid, 833
- branchiostegous rays, 834
- branchial arches, 834
- pharyngeal bones, 834
- condition of the os hyoides in Reptiles, 835
- metamorphosis of the os hyoides, 835
- thorax, 836
- vertebral ribs, 836
- sternum, 837
- sternal ribs, 838
- limbs, 839
- anterior, 839

Oseous System (continued).

- scapula, 839
- clavicle, 839
- coracoid, 840
- humerus, 840
- forearm, 840
- carpus, 840
- metacarpus, 841
- phalanges, 841
- posterior, 842
 - ilium, 842
 - ischium, 842
 - pubis, 842
- marsupial bones, 843
- femur, 843
 - tibia, 843
 - fibula, 843
 - tarsus, 843
 - metatarsus, 843
 - phalanges, 844
- sesamoid bone, 844
- exoskeleton, 844
 - suborbital bones, &c. 845
 - opercular bones, 845
 - supra-temporal, 845
 - bones of the zygotic fins of Fish, 845

Osseous Tissue, 847

- general description, 847
- hyalitic substance, 847
- laminae, 849
- Haversian canals, 849
- corpuscles or cells, 850
- growth of bone, 853
 - madder experiments, 853
- development of osseous tissue, 854
- ossification of permanent cartilage, 857
- abnormal osseous plates in the soft tissues, 857
- formation of osseous tissue in the union of fractures, 857

*Ovary, see Supplement.**Ovary, see Supplement.**Pachydermata, 858*

- enumeration of genera, 859
- osseous system, 859
 - cranium, 859
 - occipital bone, 859
 - parietal bones, 860
 - frontal bones, 860
 - ethmoid, 860
 - sphenoid, 861
 - ribs and sternum, 861
 - anterior extremities, 862
 - scapula, 862
 - clavicle, 862
 - humerus, 862
 - radius and ulna, 862
 - carpus, 863
 - metacarpus, 863
 - phalanges, 863
 - posterior extremities, 864
 - pelvis, 864
 - femur, 864
 - tarsus, 864
 - metatarsus, 864
 - phalanges, 864
- teeth, 865
 - of Suidæ, 865
 - Chæropotamidæ, 865
 - Hippopotamidæ, 866
 - Toxodon, Elasmotherium, 866
 - Rhinocerotidæ, 866
 - Dinotherium, 867
 - Proboscidea, 867
 - Elephant, 867
- digestive system, 871
 - stomach and intestines, liver, 871, 872
 - spleen, 871
 - salivary glands, 872
- os hyoides, 873
- circulatory and respiratory system, 872
- urinary organs, 873
- generative organs, 873
 - male, 873
 - female, 873
- nervous system, 874
 - brain, 874
 - special senses, 874
 - touch, 874
 - snout, 874
 - proboscis of the elephant, 875
 - smell, 875
 - frontal, maxillary, and sphenoidal sinuses, 875-6
 - eye, 876
 - ligamentum nuchæ, 876
- Pacinian Bodies, 876*
 - general description, 876
 - stalk, 878
 - channel for the stalk, 878
 - capsules, 878
 - artery, 878
 - central cavity, 878
 - nerve tube, 879

Pacinian Bodies (continued).

- function, or use, 879
- comparison with the electrical organs of the torpedo, 879
- Par Vagus, 881*
 - origin, course in the cranium, 882
 - ganglion superius, 882
 - communicating filament with the glosso-pharyngeal, 882
- auricular branch, 883
- passage of the vagus along the neck, 884
 - branches, 885
 - superior pharyngeal, 885
 - inferior pharyngeal, 885
 - middle pharyngeal of Valentin, 885
 - superior laryngeal, 886
 - external branch, 886
 - internal branch, 886
 - vascular and cardiac branch, 887
 - inferior or recurrent laryngeal, 887
 - course of the vagus through the thorax, 888
 - distribution of the vagus in the abdomen, 889
 - left vagus, 889
 - right vagus, 890
 - connexion of the vagus and spinal accessory, 890
 - physiology of the nervus vagus, 891
 - do the roots of the vagus contain any motor filaments? 891
 - sensitive filaments, 892
 - functions of the various branches, 892
 - auricular branch, 892
 - pharyngeal branches, 892
 - laryngeal branches, 893
 - effects of the laryngeal nerves on phonation, 895
 - cardiac branches, 896
 - pulmonary branches, 896
 - to what extent do the filaments of the vagi act as lucident nerves, 897
 - morbid changes in the lungs after dividing the vagi, 898
 - functions of the gastric branches, 899
 - do the gastric branches of the vagus contain some motiferous filaments? 899
 - effects of lesion of the vagi upon the sensations of hunger and satiety, 899
 - the function of digestion, 900
 - upon the secretion of gastric juice, 900
 - upon the secretion of mucus upon the inner surface of the stomach and intestines, 900
 - upon the rapidity of absorption from the inner surface of the stomach, 901
 - summary of conclusions respecting the function of the nervus vagus, 901

Parotid region, 902

- parotid gland, 902
 - relations, 902
- arteries, 903
- veins, 903
- nerves, 903
- lymphatic glands, 904
- Parturition, Mechanism of, 904*
 - in the lower animals, 904
 - attitude and position of the fœtus, 906
 - in the human subject, 907
 - presentation of the head, 907
 - first position, 907
 - second position, 907
 - presentation of the face, 908
 - first position, 908
 - second position, 908
 - presentation of the lower extremities, 908
 - cross presentation, 908

*Peleis, see Supplement**Penis, 909*

- comparative anatomy, 909
 - in Infusoria and Rotifera, 909
 - in Entozoa, 909
 - in Annelida, 909
 - in Cirrhopoda, 909
 - in Crustacea, 909
 - in Insecta, 910
 - in Mollusca, 910
 - in Vertebrata, 910
 - Fishes, 910
 - Amphibia, 910
 - Ophidia, 910
 - Sauria, 910
 - Chelonia, 910
 - Aves, 911
 - Mammalia, 911
 - Quadrumana, 911
- in Man, 911
 - integument, 911
 - subcutaneous areolar tissue, 912
 - fascia penis, 912
 - corpus cavernosum, 912
 - structure, 912
 - trabeculae, 912
 - septum pectiniforme, 913
 - vaso-cellular structure, 913

Penis (continued).

- contractile fibrous tissue, 913
- corpus spongiosum, and glans penis, 914
- structure, 914
- mucous membrane, 914
- supposed muscular fibres of the urethra, 915
- muscles, 915
 - erector penis, 915
 - acceleratores urinæ, 915
 - ischio-bulbosus, 915
 - compressor venæ dorsalis penis, 916
- arteries, 916
 - arteria corporis bulbosi, 916
 - arteria corporis cavernosi, 916
 - arteria dorsalis penis, 917
- veins, 917
 - venæ corporis bulbosi, and venæ corporis cavernosi, 917
 - dorsal vein, 917
- ultimate arrangement of the bloodvessels, 917
- arteriæ helicinæ, 917
- lymphatic vessels, 918
- nerves, 918
- development, 918

Pericardium, see Heart

- Perineum (Surgical Anatomy), 919*
- bony and ligamentous boundaries, 919
- axes of the pelvis at different ages, 919
- rectum, 920
 - course, &c. 920
 - relations, 921
 - coats, 921
- bladder, vesiculæ seminales, and vasa deferentia, 922
- urethra, 923
 - prostatic portion, 924
 - membranous portion, 925
 - bulb and spongy portion, 925
- dissection, 925
 - superficial compartment, 926
 - integument, 926
 - superficial fascia, 927
 - central tendinous point of the perineum, 928
 - superficial perineal artery and veins, 928
 - inferior or superficial division of the pudic nerve, 928
 - transversalis perinei artery, 929
 - accelerator urinæ muscle, 929
 - erector penis, 929
 - transversus perinei, 929
 - bulb of the urethra, 930
 - triangular ligament, 930
 - Cowper's glands, 930
 - Guthrie's muscles, 930
 - arteries of the bulb, 931
 - internal pudic arteries, 931
 - deep compartment, 932
 - Willson's muscles, 933
 - membranous portion of the urethra, 932
 - prostate gland, 932
 - vesico-prostatic plexus of veins, 933
 - irregular artery sometimes found along the side of the prostate, 933
 - application of the anatomy of this part to practical purposes, 934

Peritonium, 935

- continuity of the peritonium traced, 936
- omenta, mesenteries, and ligaments, 940
- falciform ligament of the liver, 940
- coronary ligament of the liver, 940
- triangular ligaments of the liver, 941
- lesser omentum, 941
- splenic omentum, 941
- great omentum, 941
 - use of, 942
 - homology of, 942
- transverse mesocolon, 942
- mesentery, 943
 - ascending and descending mesocolon, &c. 943
 - appendices epiploicæ, 943
 - recto-vesical folds, 943
 - broad ligaments of the uterus, 943
 - recto-uterine and vesico-uterine folds, 943
 - other slight folds and depressions, 943
- the serous coating of the various abdominal viscera, 943
- external or adherent surface of the peritonium, 944
- abnormal adhesions and other results of peritonitis, 945

Pharynx and Mouth, 945

- fibrous membrane, 945
- muscles, 946
 - constrictor pharyngis inferior, 946
 - constrictor pharyngis medius, 946
 - constrictor pharyngis superior, 946
 - stylo-pharyngeus, 947
 - palato-pharyngeus, 947
- general review of the attachments of the pharynx, 947
- the cavity and its openings, 948
- mucous membrane and glands, 948

Pharynx and Mouth (continued).

- vessels and nerves, 949
- Mouth, 949
 - lips, 949
 - cheeks, 950
 - palatine arch and gums, 950
 - gums, 951
 - velum palati, 951
 - muscles of, 951
 - circumflexus palati, 951
 - levator palati, 952
 - palato-pharyngeus, 952
 - palato-glossus, 952
 - azygos uvulæ, 952
 - glands, 952
 - tonsils, 952
 - course of the mucous membrane, 953
 - functions, 953
 - morbid anatomy of the pharynx and mouth, 954
 - congenital malformations, 954
 - forcing bodies, 954
 - structural changes, 954
 - abscesses, 954
 - ulceration, 954
 - polypi, 954
 - pouching of the mucous membrane, 954
 - cancrem oris, 954
- Pisces, 955*
- general characters, 955
- classification, 956
- osseous system, 957
 - skeleton of Osseous Fishes, 958
 - vertebral column, 958
 - ribs and sternum, 959
 - cranium, 959
 - face, 959
 - anterior extremities, 961
 - posterior extremities, 962
 - fin rays of the extremities, 962
 - vertical fins, 962
 - interspinous bones, 962
 - rays of the vertical fins, 962
 - skeleton of Chondropterygii, 963
 - skull, 963
 - branchial apparatus, 964
 - ribs and sternum, 965
 - anterior extremities, 965
 - posterior extremities, 966
 - skeleton of Dermapterygii, 966
 - skeleton of Branchiostoma, 967
- arthrodial system, 967
- muscular system, 968
 - great lateral muscles, 968
 - superior and inferior slender muscles, 968
 - muscles of the pectoral fins, 968
 - of the ventral fins, 968
 - of the jaws, 968
 - of the palato-tympanic arch, 968
 - of the operculum, 969
 - of the os hyoides, 969
 - of the branchiostegous membrane, 969
 - branchial and pharyngeal apparatus, 969
 - peculiarities of the muscular system in particular Fishes, 969
 - in Ostracodes, 969
 - in Raïdes, 969
 - muscles of the jaws in Cartilaginous Fishes, 970
 - in Sharks, 971
 - in Petromyzonidæ, 971
- tegumentary system, 971
 - the skin in general, 971
 - pigment, 972
 - mucus follicles, 972
 - scales, 973
 - teeth of scales, 974
 - chemical composition, 974
- teeth, 975
 - in Cyclostomatous Fishes, 976
 - position, form, mode of implantation, and development, 977
 - examples of peculiar dentition, 978
 - Cyprinidæ, 979
 - Scari, 979
 - Diodons and Tetradons, 980
 - Saw-fish, 980
- œsophagus, 981
- stomach, 981
- intestinal canal, 981
- salivary glands, 982
- pancreas, 982
- liver, 982
- spleen, 983
- lymphatic system, 983
- organs of respiration, 985
 - in Osseous Fishes, 985
 - in Lophobranchii, 986
 - in Sturionidæ, 986
 - in Plagiostome Cartilaginous Fishes, 986
 - in Cyclostomata, 987
 - in Branchiostoma, 988
 - hyoid apparatus, 988
 - branchial cavity, 988
- circulatory system, 988

Pisces (continued).

- heart, 988
- bulbus arteriosus and branchial artery, 989
- vascular system, 989
 - branchial and systemic arterial vessels, 989
 - systemic veins, 990
- (respiratory and circulatory apparatus in Lepidosiren,) 990
 - portal system of veins, 992
 - lateral system of vessels, 992
- nervous system, 992
 - brain, 992
 - nerves, 994
 - olfactory, 994
 - optic, 995
 - third pair, 995
 - fourth pair, 995
 - sixth pair, 996
 - seventh pair, 996
 - eighth pair, 996
 - ninth pair, 996
 - second pair of spinal nerves, 996
 - sympathetic system, 997
 - nervous system of Branchiostoma, 998
- senses, 998
 - smell, 998
 - eye, 999
 - sclerotic coat, 999
 - membrana argentea, 999
 - iris, 999

Pisces (continued).

- choroid, 999
- choroid gland, 1000
- optic nerve, 1000
- falciform ligament or marsupium, 1000
- aqueous humour, 1001
- crystalline lens, 1001
- vitreous humour, 1001
- muscles of the eyeball, 1001
- eyelids, 1002
- auditory apparatus, 1002
 - in Petromyzon, 1002
 - in Osseous Fishes, 1009
 - membranous vestibule, 1005
 - sac of the otoliths, 1005
 - otoliths, 1004
 - semicircular canals, 1004
 - auditory nerves, 1005
- ear of Plagiostome Cartilaginous Fishes, 1005
- generative system, 1005
 - in Cyclostomata, 1006
 - in Osseous Fishes, 1006
 - in Plagiostome Cartilaginous Fishes, 1007
 - male, 1007
 - female, 1008
 - in Syngnathidae, 1010
- urinary apparatus, 1011
- renal capsules, 1011

END OF VOL. III.

April, 1844.

MEDICAL WORKS,

PUBLISHED BY

ADDITIONAL ERRATA IN VOLUME THE THIRD.

- Page 71, col. 1, line 1 and 2, *for* "six times," *read* "six lines."
287, col. 1, line 1, *for* "Peophagous," *read* "Poephagous."
351, col. 1, line 7, *for* "made be made," *read* "may be made."
361, col. 2, line 28 from bottom, *for* "analysis," *read* "analyses."
409, col. 1, *fig.* 207, *insert* "B" at the angle which is not lettered.
409, col. 2, last line, *for* "g," *read* "G."
417, col. 2, lines 2 and 3, *for* "quadratus femoris," *read* "quadiceps extensor femoris."
418, col. 1, line 26 from bottom, *for* "separated," *read* "adapted."
433, col. 1, line 5, *for* "or *ad-cd*, in the second movement; the tail being," *read* "or
ad-cd; in the second movement, the tail being."
line 10, *for* "ab," *read* "ad."
441, col. 1, line 7, *dele* "Sect. IV."
610, col. 1, line 5, *for* "molar," *read* "motor."
667, col. 1, line 19, *for* "foramen," *read* "fore-arm."
715, col. 1, line 39, *for* "in membranous," *read* "in a membranous."
716, col. 1, line 33 from bottom, *for* "his," *read* "this."
720x, col. 2, line 2 from bottom, *for* "posterior and posterior," *read* "anterior and posterior."
722s, col. 1, line 8 from bottom, *for* "cerebri," *read* "cerebelli."
751, col. 1, line 19, *for* "had," *read* "have."
830, col. 1, line 10 from bottom, *for* "resemble," *read* "resembling."
col. 2, line 6, *for* "it," *read* "them."
849, col. 2, in description of cut, *for* "animal," *read* "earthy."

ILLUSTRATIONS, by WOODCUT and other engraving, to be found in any publication, professing to treat of the same subjects, are introduced in the articles on the Anatomy and Physiology of the various classes of the Animal Kingdom; and the work is elegantly printed on superfine paper, in double columns, with a small and clear type, so as to compress as much information into an octavo page as is usually found in large quarto.

The Third and concluding Volume is now publishing in Parts, 5s. each, and will be completed as speedily as possible.

Price of Vol. I. £2; Vol. II. £2:10s.

MERCHANT, SINGER, AND SMITH, PRINTERS, INGRAM-COURT, FENCHURCH-STREET.

Pieces (continued).

heart, 988
 bulbous arteriosus and branchial artery, 989
 vascular system, 989
 branchial and systemic arterial vessels, 989
 systemic veins, 990
 (respiratory and circulatory apparatus in Lepi-
 dosiren,) 990
 portal system of veins, 992
 lateral system of vessels, 992
 nervous system, 992
 brain, 992

Pieces (continued).

choroid, 999
 choroid gland, 1000
 optic nerve, 1000
 falciform ligament or marsupium, 1000
 aqueous humour, 1001
 crystalline lens, 1001
 vitreous humour, 1001
 muscles of the eyeball, 1001
 eyelids, 1002
 auditory apparatus, 1002
 in Petromyzon, 1002

LONDON:

MARCHANT SINGER AND CO., PRINTERS, INGRAM-COURT, FENCHURCH-STREET.

(60)

594

April, 1844.

MEDICAL WORKS,

PUBLISHED BY

SHERWOOD, GILBERT, & PIPER,
PATERNOSTER-ROW,
LONDON.

Now completed, Vols. I. and II. of the

Cyclopædia of Anatomy and Physiology;

BEING

A SERIES OF DISSERTATIONS ON ALL THE TOPICS CONNECTED WITH

Human, Comparative, and Morbid Anatomy and Physiology;

SO ARRANGED AS TO FORM

A COMPLETE DICTIONARY OF TERMS

AND

COPIOUS WORK OF REFERENCE.

EDITED BY **R. B. TODD, M.D. F.R.S.**

FELLOW OF THE ROYAL COLLEGE OF PHYSICIANS, PROFESSOR OF PHYSIOLOGY, AND OF
GENERAL AND MORBID ANATOMY, IN KING'S COLLEGE, LONDON.

This great work consists of a Series of Dissertations under the headings of the more important subjects of **HUMAN ANATOMY**, General, Surgical, and Morbid—of **PHYSIOLOGY**—of **COMPARATIVE ANATOMY**—and of **ANIMAL CHEMISTRY**; and towards the close of the work an article will be introduced, giving a general view of the present state of **VEGETABLE ANATOMY** and **PHYSIOLOGY**. In order to unite the advantages of a Dictionary with the proposed form of the work, a very copious **INDEX** will be added, containing all the Terms employed in these Sciences.

ILLUSTRATIONS, by Woodcut and other Engravings, to a much greater extent than can be found in any publication, professing to treat of the same subjects, are introduced in the articles on the Anatomy and Physiology of the various classes of the Animal Kingdom; and the work is elegantly printed on superfine paper, in double columns, with a small and clear type, so as to compress as much information into an octavo page as is usually found in large quarto.

The Third and concluding Volume is now publishing in Parts, 5s. each, and will be completed as speedily as possible.

Price of Vol. I. £2; Vol. II. £2: 10s.

MERCHANT, SINGER, AND SMITH, PRINTERS, INGRAM-COURT, FENCHURCH-STREET.

The articles are contributed by upwards of Sixty distinguished Writers, eminent in Science, amongst whom the following may be enumerated:—

Robert Adams, Esq. Dublin.
B. Alcock, M.B. Dublin.
W. P. Allison, M.D. F.R.S.E.
John Anderson, Esq. M.E.S.
J. Apjohn, M.D. M.R.I.A.
Victor Audouin, M.D. Paris.
B. G. Babington, M.D. F.R.S.
Thomas Bell, F.R.S.
Charles Benson, M.D. M.R.I.A.
J. Bishop, Esq.
John Bostock, M.D. V.P.R.S.
John Bowman, Esq.
W. T. Brande, F.R.S.
J. E. Brennan, M.D.
G. Breschet, M.D. Paris.
W. B. Carpenter, M.D. Bristol.
John Coldstream, M.D. Leith.
David Craigie, M.D. F.R.S.E.
T. Blizard Curling, Esq.
G. P. Deshayes, M.D. Paris.
A. T. S. Dodd, Esq. Chichester.
H. Dutrochet, M.D. Paris.
W. F. Edwards, M.D. F.R.S. Paris.
H. Milne Edwards, M.D. Paris.
Arthur Farre, M.B. F.R.S.

John Goodsir, M.W.S.
R. D. Grainger, Esq.
R. E. Grant, M.D. F.R.S. L. & E.
W. A. Guy, M.D.
Marshall Hall, M.D. F.R.S. L. & E.
Henry Hancock, Esq.
Robert Harrison, M.D. M.R.I.A.
John Hart, M.D. M.R.I.A.
A. Higginson, Esq.
I. Geoffroy St. Hilaire, M.D. Paris.
Arthur Jacob, M.D. M.R.I.A.
George Johnson, M.B.
T. Rymer Jones, Esq.
T. Wharton Jones, Esq.
T. Wilkinson King, Esq.
Samuel Lane, Esq.
F. T. Macdougall, Esq.
John Malyn, Esq.
Robert Mayne, M.D.
W. A. Miller, M.D.
W. F. Montgomery, M.D. M.R.I.A.
George Newport, Esq.
R. Owen, F.R.S. G.S.
James Paget, Esq.

Richard Partridge, F.R.S.
Benjamin Phillips, F.R.S.
W. H. Porter, Esq. Dublin.
J. C. Prichard, M.D. F.R.S.
G. O. Rees, M.D.
J. Reid, M.D. Edinburgh.
Edward Rigby, M.D. F.L.S.
J. F. Royle, M.D. V.P.R.S. F.G.S.
Henry Searle, Esq.
W. Sharpey, M.D. F.R.S.
John Simon, Esq.
J. Y. Simpson, M.D.
Samuel Solly, F.R.S.
Gabriel Stokes, M.D. Dublin.
J. A. S. Monks, M.D. Bristol.
Allen Thomson, M.D. Edinburgh.
John Tones, Esq.
W. Vrolik, Amsterdam.
Rudolph Wagner, M.D. Erlangen.
W. H. Walsh, M.D.
R. Willis, M.D.
W. W. Williams, Esq.
W. J. Erasmus Wilson, Esq.
W. Yarrell, F.L.S. Z.S.

OPINIONS OF THE PRESS.

"The Cyclopædia of Anatomy and Physiology is unquestionably one of the best of the scientific works of the day . . . Dr. Todd has learned to use the magic art by which men of most opposite pursuits have been associated in one common and brilliant task . . . Few works have appeared in this country in which so large and distinguished an association of contributors have been engaged . . . If we wished for a means of estimating a man's taste for his profession, we would ask, does this Cyclopædia grace his book-shelves?"—*Lancet*, August 22, 1840.

"Considering the objects and plan of this work, the knowledge and industry of the editor, the splendid array of talent combined in its construction, and the elegant manner in which its mechanical part is executed, we cannot but regard it as one of the most important and valuable ever produced in this country."—*British and Foreign Medical Review*.

"It gives us much pleasure to observe the steady progress of this valuable work. We confess we had our doubts on its first announcement, and even for some time after the appearance of some of its earlier numbers, whether we should be justified in recommending, without further assurance of its mark and likelihood, a production which required so much time, and such able and varied assistance for its completion. We are, however, now satisfied that the Cyclopædia of Anatomy is a publication deserving of every encouragement. So far from having exhausted its attractions in the commencement, and then falling off, leaving subscribers to regret their ill-advised patronage, prematurely bestowed, it increases, we think, in value every succeeding number. The articles already given, on the subject of *comparative anatomy*, are of transcendent merit; those in physiology, also, are distinguished by great ability. In the department of *human anatomy, normal and abnormal*, the editor is assisted by several first-rate contributors. In short, taken all in all, we believe the work is one that is not likely to be rivalled in this or any other country of Europe."—*Medical Gazette*.

"No diminution of energy, zeal, or talent, is visible in the progress of the Cyclopædia. We beg to recommend it in an especial manner to the profession, in consequence of the great attention which is paid to Comparative Anatomy and Physiology—sciences which are now really deserving of the name, and which are every year becoming more and more cultivated, because they throw so much light on the Anatomy and Physiology of the Human Body. * * * The execution shows that the Cyclopædia of Anatomy and Physiology is no hasty conception, and the complete success of the work may be foretold, from the excellence which characterizes the portion of it already published."

"The most remarkable encyclopædia hitherto possessed by the medical sciences."

Repertorium für Anatomie und Physiologie, von G. Valentin

"The Cyclopædia of Anatomy and Physiology, a work peculiar in this respect, that it is the joint production of English and French contributors. The able Editors have the merit of thus setting an example of breaking down national distinctions, which are injurious to science, and of hastening the time when men of enlarged minds shall be considered as belonging to no particular country, but as members of a universal republic. The memoirs which have already appeared in this work are likely to obtain the approbation of scientific men in both countries."

Dr. Prichard's Address to the Provincial Med. Association

Now completed, the

Cyclopædia of Practical Medicine,

EDITED BY J. FORBES, M.D. F.R.S.; ALEX. TWEEDIE, M.D.; J. CONOLLY, M.D.

This important work is now completed, in four large volumes, and consists of a Series of Original Essays upon all the subjects of Medicine, contributed by no less than sixty-seven of the most eminent practical Physicians of Great Britain and Ireland; forming a complete LIBRARY of MEDICINE. Each subject has been treated by a writer of acknowledged reputation, whose particular studies have eminently fitted him for the task, and all the articles are authenticated with the names of the authors; thus giving the work a character of originality and authority which does not belong to Cyclopædias upon the plan of anonymous publication, or to compilations by single writers, however learned and industrious.

Contributors.

W. P. Alison, M.D. F.R.S.E.	John Crampton, M.D. M.R.I.A.	Robert Law, M.D. Dublin.
James Apjohn, M.D. M.R.I.A.	Adair Crawford, M.D.	Robert Lee, M.D. F.R.S.
R. Arrowsmith, M.D. Coventry.	Andrew Crawford, M.D.	Charles Locock, M.D.
Edward Ash, M.D. Norwich.	William Camin, M.D. Glasgow.	David H. Mac Adam, M.D. Dublin.
James L. Bardsley, M.D. Manchester.	John Darvell, M.D. Birmingham.	William F. Montgomery, M.D.
Edward Barlow, M.D. Bath.	Frederick Duesbury, M.D.	J. A. Paris, M.D. F.R.S.
Thomas Edward Beattie, M.D. Dublin.	John Elliotson, M.D. F.R.S.	J. C. Fritchard, M.D. F.R.S. Bristol.
John J. Bigsby, M.D. F.L.S. Newark.	J. Gillkrest, M.D.	Jones Quain, M.D.
J. Bostock, M.D. V.P.R.S. F.L.S. F.G.S. &c.	George Goldie, M.D. Shrewsbury.	Archibald Robertson, M.D.
Joseph Brown, M.D. Sunderland.	James Grant, M.D. Jedburgh.	P. M. Roget, M.D. Sec.R.S.
Thomas H. Burder, M.D.	George Gregory, M.D.	John Scott, M.D. Edinburgh.
John Burne, M.D.	Marshall Hall, M.D. F.R.S.L. and E. &c. &c.	William Stokes, M.D. Dublin.
Robert Carswell, M.D.	Thomas Hancock, M.D.	Robert J. N. Streeten, M.D.
H. W. Carter, M.D. F.R.S.E.	Bisset Hawkins, M.D.	J. A. Symonds, M.D. Bristol.
John Cheyne, M.D. F.R.S.E.	Charles Hastings, M.D.	A. T. Thomson, M.D. F.L.S.
M.R.I.A.	J. Hope, M.D. F.R.S.	Thomas Thomson, M.D. F.R.S.L.
Robert Christison, M.D. F.R.S.E.	James Houghton, M.D. Dublin.	T. J. Todd, M.D. Brighton.
Sir James Clark, M.D. F.R.S.	Arthur Jacob, M.D. M.R.I.A.	Robert B. Todd, M.B.
Henry Clutterbuck, M.D.	Charles Johnson, M.D. Dublin.	Richard Townsend, M.D. M.R.I.A.
J. Corrigan, M.D. Dublin.	William Bruce Joy, M.D. Dublin.	Robert Venables, M.B.
	J. P. Kay, M.D. Manchester.	Thomas Watson, M.D.
	William Kerr, M.D.	John Whiting, M.D.
		Charles J. B. Williams, M.D.

“Such a work as this has long been wanting in this country. British Medicine ought to have set itself forth in this way much sooner. We have often wondered that the medical profession and the enterprising publishers of Great Britain did not, long ere this, enter upon such an undertaking as a Cyclopædia of Practical Medicine.”

Medical Gazette.

“The Cyclopædia of Practical Medicine, a work which does honour to our country, and to which one is proud to see the names of so many provincial physicians attached.”

Dr. Hasling's Address to Provincial Medical and Surgical Association.

“Of the medical publications of the past year, one may be more particularly noticed, as partaking, from its extent and the number of contributors, somewhat of the nature of a national undertaking, namely, the ‘Cyclopædia of Practical Medicine.’ It accomplishes what has been noticed as most desirable, by presenting, on several important topics of medical inquiry, full, comprehensive, and well-digested expositions, shewing the present state of our knowledge on each. In this country, a work of this kind was much wanted, and that now supplied cannot but be deemed an important acquisition. The difficulties of the undertaking were not slight, and it required great energies to surmount them. These energies, however, were possessed by the able and distinguished editors, who, with diligence and labour such as few can know or appreciate, have succeeded in concentrating, in a work of moderate size, a body of practical knowledge of great extent and usefulness.”

Dr. Barlow's Address to the Medical and Surgical Association.

“The Cyclopædia of Practical Medicine” is comprehended in four large vols., printed in royal 8vo. double columns, containing as much matter as is usually found in twenty, or even thirty, ordinary-sized octavos, neatly done up in cloth, and lettered, price £6. 15s.; or handsomely half-bound in morocco, gilt and lettered, with marbled edges, £7. 7s.; serving as a

VALUABLE PRIZE-BOOK for MEDICAL STUDENTS.

DR. WAGNER'S
System of Physiology;

For the Use of Students and Practitioners in Medicine.

Translated from the German

BY ROBERT WILLIS, M.D.

With Notes and Additions by the Translator and others.

The great object which the Author proposes to himself in this undertaking, and to which he will hold all others subordinate, is this—to give the most concise and clear view possible of the older and newer Physiological Inquiries in a Systematic Form, and with particular reference to Practical Medicine. But although the advancement of the Student and Practitioner of Medicine has been the chief aim of the Author, he has not been unmindful of any one who would obtain a comprehensive view of the recent progress and present state of Physiology. He has striven especially to make his book a guide in the path of observation and experiment to those who, remote from the appliances of great cities and amply-furnished institutions, are still anxious to investigate and to prove for themselves, with such means as they have at their command. Even to the Physiologist of higher pretensions, however, he would fain hope that he had brought a present not unacceptable on many accounts; for it has still been his endeavour to see where possible with his own eyes, and to speak at all times as feeling secure on his own footing. With all this, he cannot but hold himself doubly secure in the support of the many distinguished Physiologists who have afforded him original contributions upon those subjects to which they have more particularly devoted their attention.

The Translator has also to acknowledge important aid in the progress of his work, from distinguished Physiologists not only of our own country, but of the continent.

The work is distributed into Four Parts, each of which is in itself a distinct and complete manual of the subject of which it treats.—Each part is illustrated by very numerous engravings, mostly after the Author's 'Icones Physiologicae.' The *THIRD PART* (price 10s.) now published, completes the *SPECIAL PHYSIOLOGY*, which comprises all that is interesting or important to the student. It is therefore issued with a Title and Preface, so that the Three Parts may be bound up together. The *GENERAL PHYSIOLOGY* will form a mere Supplement or Appendix to these.

CONTENTS OF PART I.—Price 10s. 6d.

BOOK I.

FIRST SECTION.—ON GENERATION.

CHAP. 1. Analysis of the Germ-preparing Organs and their Products.—2. On the Forms of the Organs of Generation.—3. Phenomena which accompany the Generative Act.

SECOND SECTION.—OF DEVELOPEMENT.

CHAP. 1. The History of the Incubated Egg.—2. Development of the Human Embryo, with Supplements from the History of that of the Mammiferous Animal.—History of the Development of the various Tissues.—Histological Development.

APPENDIX.—Organization of Spermatozoa.

CONTENTS OF PART II.—Price 9s.

BOOK II.

OF NUTRITION AND SECRETION.

CHAP. 1. Of the Blood.—2. Of the Circulation of the Blood and the Vascular System.—3. Of Digestion.—4. Of Respiration.—5. Of Secretion.—6. Of Absorption and the more intimate processes of Nutrition.

WORKS OF DR. MARSHALL HALL.

1.

THE PRINCIPLES OF THE THEORY AND PRACTICE
of MEDICINE;

Including the Third Edition of the Author's Work on DIAGNOSIS. Illustrated with numerous Cuts, and designed for the Use of Students.

In 1 vol. 8vo. price 16s. cloth lettered.

"As this work was written for the student and young medical practitioner, we are happy to have it in our power to recommend it to those for whom it was designed. Dr. Hall's work, like most that he writes, is excellent; so much so, that its brevity is the chief fault we have to find with it."

Medico-Chirurgical Review.

2.

MEMOIRS I. AND II. ON THE NERVOUS SYSTEM.

4to. with 3 Plates, price 10s. 6d. cloth.

"It is questionable whether, since the time of Harvey, any discovery has been made in physiology so important as that developed in these Memoirs.

"Amongst physiologists the author must take a high rank, and the name of Hall must henceforth be associated with that of Bell. To both, the physiological reputation of our country will be deeply indebted; but Dr. Hall's discovery is the more original of the two, because more unexpected."

Spectator.

3.

OBSERVATIONS ON THE DUE ADMINISTRATION

of BLOOD-LETTING;

Founded upon Researches principally relative to the MORBID and CURATIVE EFFECTS of LOSS of BLOOD. 9s.

"We believe the credit of having first put forward, in a strong light, the practical utility of attending to these points (blood-letting) is eminently due to Marshall Hall.

"We may take this opportunity of recommending Dr. Hall's valuable work to our readers; they will find in it several rules and observations of great importance relative to blood-letting as a diagnostic of diseases."—*Medical Gazette.*

4.

CRITICAL AND EXPERIMENTAL ESSAYS

on the CIRCULATION of the BLOOD;

Especially as observed in the Minute and Capillary Vessels of the Batrachia and of Fishes. 8vo. with Plates, 9s.

5.

COMMENTARIES ON THE CONSTITUTIONAL

DISEASES of FEMALES.

In Two Parts.

A New Edition, 8vo. with Plates, price 16s.

PART FIRST.—Of the Symptoms, Causes, and Prevention of Local Inflammation, Consumption, Spinal Affections, and other Disorders incidental to Young Females.

PART SECOND.—Comprehending the several Affections incidental to the middle and later Periods of Life, and of their Constitutional Origin.

MR. HOBLYN'S
DICTIONARY OF TERMS USED IN MEDICINE

and the COLLATERAL SCIENCES; a MANUAL for the USE of STUDENTS and the Scientific Reader: containing the Etymology and Meaning, Nomenclatures, Classification of Nosology, Materia Medica, Poisons and their Antidotes, Analyses of Mineral Waters, an Account of Climates, &c.; Tabular Sketches of Chemistry, Medical Botany, and Zoology.

Second Edition. In the Press.

"A work much wanted, and very ably executed."—*London Medical Journal.*

"This compendious volume is well adapted for the use of students. It contains a complete glossary of the terms used in medicine,—not only those in common use, but also the more recent and less familiar names introduced by modern writers. The introduction of tabular views of different subjects is at once comprehensive and satisfactory. It must not, however, be supposed that the volume is a mere word-book; it is, on the contrary, an extremely interesting manual, beautifully printed, containing much excellent matter in a little space, and is deserving of our strong recommendation."

Medical Gazette.

"Concise and ingenious."—*Johnson's Medico-Chirurgical Journal.*

"It is a very learned, pains-taking, complete, and useful work,—a Dictionary absolutely necessary in a medical library."—*Spectator.*

DR. PARIS'S
PHARMACOLOGIA;

Or, HISTORY of MEDICAL SUBSTANCES:

With a view to establishing the Art of Prescribing and of Composing Extemporaneous Formulæ upon Fixed and Scientific Principles.

A New Edition, being the Eighth, very considerably improved and closely printed, in 1 vol. 8vo. price 20s. cloth.

* * * The Publishers have much pleasure in offering this new Edition of DR. PARIS'S PHARMACOLOGIA to the Public. It is now so printed as to form one handsome volume in octavo (instead of two), and contains much new and valuable matter, derived from the recent discoveries of Dr. Paris in Pharmacological and Chemical Science; and such additional observations respecting the powers of simple and combined remedies as the extended experience of the Doctor has enabled him to offer.

"Dr. Paris's happy illustration of the operation of medicines, as diversified by combination, appears to be peculiarly his own; and he has so far succeeded in reducing his principles to scientific accuracy, and in rendering them applicable to practice, as justly to merit the praise of forming a new era in the departments of pharmacy and prescriptions. The PHARMACOLOGIA is a work entitled to the double commendation of being admirably suited to the wants of the profession, and the only one of the kind."—*Preface to the Second American Edition.*

DR. RYAN'S
MANUAL OF MEDICAL JURISPRUDENCE AND STATE MEDICINE:

Being a Compendium of the Works of BECK, PARIS, and FONBLANQUE, ORFILA, CHRISTISON, and all standard modern writers. In four Parts. Part I. Medical Ethics.—Part II. Laws relating to the Medical Profession.—Part III. All Medico-Legal Questions which may arise in Courts of Justice.—Part IV. Laws for the Preservation of Public Health. Intended for the Use of the Medical and Legal Professions.

Second Edition, considerably enlarged and improved, comprehending all that is essential in PERCIVAL'S MEDICAL ETHICS, and in BECK'S celebrated work on JURISPRUDENCE, 8vo. price 13s. cloth.

"We are acquainted with no work on Medical Jurisprudence that presents so much valuable information in so condensed and yet so clear a form."—*American Journal of Medical Science.*

DR. CONOLLY'S

FOUR LECTURES ON THE STUDY AND PRACTICE OF MEDICINE;

Delivered on different occasions in the University of London.

Price 5s. neatly bound and lettered.

"Until we read these Lectures, we were not prepared to find so high a tone, so liberal and enlightened a spirit, and above all, such truly philosophical habits of mind, in a practising physician of the present day. Happy were the students of the University in such a guide: such a tutor was not only likely to lead to sound and safe notions in medicine, but to virtue and honour, peace and good name. These Lectures are as moral as they are medical.

"Were we to extract all the passages in this little work that have given us unfeigned pleasure, we should leave nothing behind.

"We trust that this volume will be put into the hands of every medical student in the country. If he do not feel interested in it, it is because he does not understand it: let therefore his master take the book up, peruse it in an evening before his pupils, and comment upon it, pointing out such illustrations and examples as every man's experience will supply."—*Spectator*.

MR. SOUTH'S

COMPLETE DESCRIPTION OF THE BONES;

Together with their several Connections with each other, and with the Muscles.
Especially adapted for Students in Anatomy.

Elegantly printed in fcp. 8vo. Third Edition, enlarged, and illustrated with 250 accurate Woodcuts, by Branston, from Original Drawings, 12mo. price 7s. cloth lettered.

"This new edition is rendered far superior to its predecessors, by being richly illustrated with wood-engravings intermixed with the letter-press. We think it one of the best Manuals of Osteology for the Student."—*Medical Gazette*.

SIR JAMES CLARK'S

(*Physician to the Queen,*)

TREATISE ON PULMONARY CONSUMPTION;

Comprehending an Inquiry into the Nature, Causes, Prevention, and Treatment of
TUBERCULOUS and SCROFULOUS DISEASES in general.

8vo. price 12s. cloth lettered.

"Dr. Clark's treatise on Consumption is the best that has yet been published in this country, or on the continent; it shows an intimate knowledge of the improved methods of diagnosis, and of the morbid anatomy so successfully investigated by the continental pathologists, and by Professor Carswell; while it displays an acquaintance with the resources of the system, and the power of therapeutic agents, only possessed in this country and in Germany."—*Lancet*.

"We recommend strongly the study of the author's hygienic remarks to our professional brethren; indeed, we think that every parent ought to be acquainted with the excellent rules laid down on NURSING, DRESS, BATHING, AIR, EXERCISE, and EDUCATION. We have seldom seen a medical work more deserving of general circulation, or one that we would more zealously recommend to the younger branches of the profession."—*Medical Quarterly Review*.

DR. OSBORN

ON THE NATURE AND TREATMENT OF DROPSICAL DISEASES;

In Four Parts. Parts I. and II. on Dropsies from Suppressed Perspiration and Diseased Kidney; with a coloured plate representing a kidney in an advanced stage of the disease.—Part III. On Dropsies from Impediments to the Circulation.—Part IV. On Dropsies from Topical Affections.

Second Edition, with considerable additions, price 7s. cloth.

BOIVIN AND DUGÈS'
PRACTICAL TREATISE ON THE DISEASES OF THE UTERUS
 and its APPENDAGES.

Translated from the French of M^{DE}. BOIVIN, Sage-Femme Surveillante en Chef de la Maison Royale de Santé, &c.; and A. DUGÈS, Professeur à la Faculté de Médecine, Montpellier, &c.;
 with copious Notes,

By G. O. HEMING, Glasgow, F.L.S. Physician-Accoucheur to the St. Pancras Infirmary.

Elegantly printed in 1 large vol. 8vo. accompanied with 41 Plates to illustrate the Work, engraved from the original Drawings from Nature, by M^{DE}. BOIVIN, price 26s. cloth; or accurately coloured, 45s. 6d. cloth.

"The work of Boivin and Dugès, on the Diseases of the Uterus, is indispensable to the library of every practitioner; nothing can exceed in fidelity the description here given of the natural structure of the uterus, and the various morbid changes to which that organ is liable; and Dr. Heming has shown a sound discrimination in rendering it into English."—*Lancet*.

"The Preface, by Dr. Heming, contains a slight sketch of the recent improvements in this department of medical science, in which the structure of the healthy uterus, and its appendages, is considered in the infantile, virgin, pregnant, and puerperal states... Many excellent remarks are added, both from Dr. Heming's own experience, and from the writings of the best authors of this country; and wherever he has stated his own opinions, they appear to be sensible, and to the purpose. The plates to the work are of great assistance in understanding the author's descriptions, and are exceedingly cheap."

Medical Quarterly Review.

DR. HODGKIN'S
LECTURES ON THE MORBID ANATOMY OF THE SEROUS
 and MUCOUS MEMBRANES.

To which are appended,

PARASITICAL ANIMALS, MALIGNANT ADVENTITIOUS STRUCTURES, and the INDICATIONS AFFORDED BY COLOUR.

Vol. I. price 10s. 6d. cloth; Vol. II. Part 1., 12s.

"The importance of the subjects embraced by these Lectures, and the reputation which Dr. Hodgkin has justly acquired, as a zealous cultivator of pathological anatomy, are sufficient to claim the earnest attention of every reader. It is scarcely doing justice to our judgment to say that the work is simply good: it is, in every respect, an excellent production, calculated to advance the progress of pathological science, and destined to take a permanent place among the higher order of the Medical Classics of this and other countries."—*British and Foreign Medical Review.*

DR. RYAN'S
MANUAL OF MIDWIFERY AND DISEASES OF WOMEN
 AND CHILDREN;

With a complete Atlas of Operations, intended as a Companion to all Obstetric Works.

Fourth Edition, rewritten and enlarged, price 10s. cloth.

"This manual contains three times more matter, according to its size, than any other we have seen." *Medical Gazette.*

"It cannot fail to give currency to principles and practice such as every man of science must desire to see universally adopted."—*Dr. Conquest.*

"It evinces considerable research, discrimination, acuteness of observation, and talent."

Medico-Chirurgical Review.

"I have no doubt it must prove useful to all the profession."—*Professor Burns, Glasgow.*

"It is a work safe to follow, and one from which the experienced practitioner may find considerable information."—*Dr. Dewees, Philadelphia.*

WORKS OF DR. PRICHARD.

1.

A TREATISE ON INSANITY, AND OTHER DISORDERS

affecting the Mind.

Accompanied with numerous Cases, exemplifying various descriptions of Madness.

By JAMES COWELL PRICHARD, M.D. F.R.S. M.R.I.A. &c. &c.

Handsomely printed in 8vo. 14s. cloth.

"The work, we may safely say, is the best, as well as the latest, on mental derangement, in the English language."—*Medico-Chirurgical Journal*.

"Dr. Prichard's work shows an extensive knowledge of his subject."—*Lancet*.

"Dr. Prichard's rank among the most distinguished of medical authors is too well known to require any laboured introduction of him to the notice of our readers. The general character of his treatise may be said to be, that it contains the best information which is at present possessed on the various matters of which it treats. It is a fair, clear, and admirably condensed compendium of documents and statements from various authorities, collected in various establishments for the insane, in various countries; so placed together, and with such discrimination commented upon, as to convince the reader that the first object of the author has been to elicit truths on which the practitioner, the moralist, the jurist, and the legislator might rely."—*British and Foreign Medical Review*.

2.

RESEARCHES INTO THE PHYSICAL HISTORY OF MANKIND;

Containing the Ethnography of the Nations of Europe.

Vol. III. price 16s.

Vol. IV., completing this portion of the Work, will very shortly be published.

* * A few copies of Vols. I. and II. of the same Work, price 30s. are still on sale.

3.

THE EASTERN ORIGIN OF THE CELTIC NATIONS,

Proved by a comparison of their Dialects with the Sanskrit, Greek, Latin, and Teutonic Languages. Forming a Supplement to "Researches into the Physical History of Mankind."

8vo. price 7s.

"Dr. Prichard deserves much praise for establishing a point which has eluded the researches of his predecessors, and which may eventually prove a valuable contribution towards the history of the human race."—*Quarterly Review*.

4.

AN ANALYSIS OF EGYPTIAN MYTHOLOGY.

To which is added, a Translation of the PRELIMINARY ESSAY, prefixed by Professor A. W. VON SCHLEGEL to the German Edition of the same Work,

By JAMES YATES, M.A.

Royal 8vo. price 21s. cloth.

5.

A REVIEW OF THE DOCTRINE OF A VITAL PRINCIPLE,

as maintained by some Writers on Physiology; with Observations on the Causes of Physical and Animal Life.

8vo. price 7s.

DR. COLLES'S
PRACTICAL OBSERVATIONS ON THE USE OF MERCURY
 In the CURE of VENEREAL and other Diseases.

8vo. 9s. cloth.

"It is one of those rare books which proceed from members of our profession, that we feel as if we should never look upon its like again; it is full of original practical details, and is quite destitute of useless speculative theories."—*British Annals of Medicine*.

"We must rank, as a most important accession to our knowledge, Dr. Colles's demonstration of the different effects produced by different modes of administering mercury, and its beneficial application to varieties of inveterate syphilis, which assumed so destructive a character in the hands of practitioners of the old school, and so frequently baffle the efforts of disciples of the new doctrine."—*Brit. and For. Med. Review*.

DR. MONTGOMERY'S
EXPOSITION OF SIGNS AND SYMPTOMS OF PREGNANCY,

The PERIOD of HUMAN GESTATION, and the SIGNS of DELIVERY;

Accompanied with a Series of Plates, accurately drawn and coloured from Nature (now for the first time made available for reference to the Profession), representing the Changes observable in the BREASTS and their AREOLÆ, as SIGNS of PREGNANCY, from the Third Month to the period of Delivery; also Seventeen Figures, coloured from Nature, illustrative of the Effects produced in the OVARIES by Impregnation: to which is added, an Essay on the SPONTANEOUS AMPUTATION of the LIMBS of the FÆTUS, illustrated with Woodcuts.

"It is distinguished by great research and extensive original investigation. The plates are of great beauty and interest, and very valuable; they admirably illustrate the author's minute and accurate observations."—*Dublin Journ. of Med. Science*.

"We here close a lengthened, and, we trust, impartial, review of Dr. Montgomery's work, which we strongly recommend to our readers as by far the completest and best that exists on the subject of which it treats. We have already spoken of the plates, which are admirable."—*Brit. and For. Med. Rev.*

"We notice this work with pleasure, for Dr. Montgomery has treated his subject in a complete and masterly manner. We have seldom seen more beautiful specimens of coloured drawings."—*Lancet*.

DR. PARIS'S
TREATISE ON DIET;

With a view to establish, on practical grounds, a System of Rules for the Prevention and Cure of the Diseases incident to a disordered state of the Digestive Functions; including

Physiological History of Digestion
 Disorders of Old Age
 Intermixture of Animal and Vegetable Food
 Luncheons objectionable
 Quality of the different Meals, and Periods best adapted for Breakfast, Dinner, Tea, and Supper
 Quantity of Food and Liquids that should be taken at Meals
 Necessity of Exercise
 Danger of Gas-light

Importance of Ventilated Apartments
 Sleeping after Dinner
 Of the Circumstances which influence the Digestibility of different species of Food and of Drinks
 A Tabular Scheme for investigating the Causes, Nature, and Seat of Indigestion
 Of Headache arising from Indigestion, and its Cure
 Rules for Dyspeptic Patients
 Acidity of Stomach, Flatulence, &c.

A New and Improved Edition, nearly re-written, price 12s. cloth lettered.

"Dr. Paris's work has become one of authority in the profession. This edition contains much new matter, and the reader will find many suggestions with regard to the regulation of Diet and Regimen,—departments of medicine which have been occupied by draughts and pills."—*Brit. Annals of Medicine*.

"Dr. Paris's book should be in the library of every family. It forms an excellent manual for the investigation of all derangements of the digestive functions, and for the guidance of dyspeptic patients in the regulation of diet."—*Edinburgh Medical Journal*.

MR. PORTER'S
OBSERVATIONS ON THE SURGICAL PATHOLOGY OF THE LARYNX
and TRACHEA,

Chiefly with a view to illustrate the Affections of those Organs which may require the Operation of Bronchotomy: including remarks on Croup, Cynanche Laryngea, Injuries by Swallowing Acids and Boiling Water, Foreign Bodies in the Windpipe, Asphyxia, Wounds, &c.

8vo. price 8s. cloth.

"This work merits an attentive perusal of every surgeon; and we recommend it to our readers as a concise, clear, and practical digest of laryngeal pathology."—*British Annals of Medicine.*

M. LOUIS'S
PATHOLOGICAL RESEARCHES ON PHTHISIS.

Translated from the French, with Introduction, Notes, Additions, and an Essay on Treatment,

By CHARLES COWAN, M.D. &c. &c. Author of the "Bedside Manual," &c.

8vo. price 12s. cloth.

"M. Louis certainly ranks as the first physician of France, and probably of Europe."

Dr. Marshall Hall.

"Dr. Cowan was well qualified to undertake the important task which he has here executed, and the laborious duty of translation has been dignified in his hands."—*British and Foreign Med. Review.*

DR. COWAN'S
BEDSIDE MANUAL OF PHYSICAL DIAGNOSIS,

Applied to Diseases of the Lungs, Pleuræ, Heart, Vessels, Abdominal Viscera, and Uterus. Second Edition, price 3s. 6d.

"We can say, with truth, that it forms a most judicious addition to our stock of practical treatises, and will prove of the greatest use in enabling the Student to form an accurate diagnosis of some of the most important diseases to which the human frame is liable."—*Dublin Journal of Medical Sciences.*

"This little volume has the unusual recommendation of being precisely what it professes. It gives a concise but clear account of the most important physical signs of diseases as connected with auscultation and percussion. It costs but a trifle, and will burden no one's pocket. Pupils will do well to have it always with them in going round their hospitals."—*Medical Gazette.*

DR. A. URE'S
PRACTICAL COMPENDIUM OF THE MATERIA MEDICA,

Adapted to the Treatment of the Diseases of Infancy and Childhood: with numerous Prescriptions.

Enlarged Edition, containing simple Rules for the Diet and Regimen of Children, and a Glossary of Technical Terms.

12mo. 5s. 6d.

"We strongly recommend it to those commencing general practice, to whom the diseases of infants are often a stumbling-block."—*British and Foreign Medical Review.*

"Under an unpretending form, the small volume before us contains a great deal of valuable information connected with the treatment of infantile disease."—*Lancet.*

DR. BOSTOCK'S
SKETCH OF THE HISTORY OF MEDICINE,
 From its Origin to the Commencement of the Nineteenth Century.

8vo. price 7s. 6d. cloth.

" This is precisely one of those books which a non-medical man may read with interest ; it will form a valuable addition to any general library ; for medicine is a branch of philosophy which never should have been separated from the parent trunk, and the sooner it is again re-grafted upon it the better." *Athenaeum.*

DR. FORBES'S
MANUAL OF SELECT MEDICAL BIBLIOGRAPHY ;

In which the Books are arranged Chronologically according to the subjects, and the Derivation of the Terms and the Nosological and Vernacular Synonyms of the Diseases are given. With an Appendix, containing Lists of the collected Works of Authors, Systematic Treatises on Medicine, Transactions of Societies, Journals, &c. &c.

Royal 8vo. price 9s. cloth.

DR. WILLIS
ON URINARY DISEASES, AND THEIR TREATMENT ;

Being a Practical Treatise on the Functional DISEASES of the KIDNEYS, and the connection of these with general and particular Morbid States and Symptoms—Diabetes, Dropsy, Gravel, Stone, &c.

" We have thus given a feeble outline of a portion of **DR. WILLIS'S TREATISE ON URINARY DISEASES**, being unwilling to anticipate the pleasure which our readers cannot fail to derive from a perusal of the work itself. It contains a well-digested, concise, and, at the same time, complete view of the subject, and will become, we venture to predict, an indispensable companion to every practitioner of medicine."—*Lancet.*

" We have perused this book with the gratification which attends the consciousness of acquiring information."—*Medical Gazette.*

SIR JOHN SINCLAIR'S
CODE OF HEALTH AND LONGEVITY ;

Or, a General View of the Rules and Principles for Preserving Health and Prolonging Life.

Fifth Edition, in one large vol. 8vo. illustrated with Seven Portraits of Celebrated Persons who attained Extraordinary Ages, price 20s.

"* * Four heavy and expensive Editions of Sir John Sinclair's " Code of Health " have stamped its merit and utility : it is the most comprehensive and useful work on Health and Longevity yet published, and has been the storehouse from which all subsequent writers have extracted much valuable information.

" The art of preserving health, and giving longevity to man, forms a link in that chain of useful pursuits to which you have devoted all your time." He adds,— " My obligation for the communication of your interesting thoughts upon this subject, are augmented by the advantage and information I have derived by perusing them."—*The Baron d'Edelcrantz.*

" Many subjects are considered in a new point of view—many new and remarkable facts are introduced ; on the whole (he states) the author has communicated the most important results regarding the effects of external substances on health."—*Dr. Sprengel's Preface to his Translation of this work into German.*

" The subject is of the greatest importance. The work I have read with great satisfaction, and the observations which it contains are very important."—*Dr. Matthew Baillie.*

(60)

594

MANUALS FOR STUDENTS, &c.

1.

THE LONDON SURGICAL POCKET-BOOK,

(Medical, Operative, and Mechanical;)

Founded on the Popular Lectures and Works of the late Mr. ABERNETHY, Sir ASTLEY COOPER, Mr. LAWRENCE, and other distinguished Surgeons; sub-digested in the Order of Causes, Symptoms, Chirurgical and Medical Treatment, Diagnosis, Prognosis, Modes of Operation, and other agents employed in Hospital and Private Practice: including an adapted Pharmacopœia; with connected intermediate Practical Questions and Answers, preparatory to Examination before the Royal College of Surgeons; Anatomical Notes, References, Glossary, &c. for the convenience of the junior branches of the Profession, Students, &c. Price 12s. bound and lettered.

2.

THE LONDON MEDICAL, PHARMACEUTICAL,

and POSOLOGICAL POCKET-BOOK.

Price 8s. bound and lettered.

3.

PARKINSON'S

NEW LONDON CHEMICAL POCKET-BOOK.

Edited by JOHN BARNES.

New Edition, price 8s. bound and lettered.

DR. SERNY

ON SPINAL CURVATURE: ITS CONSEQUENCES AND ITS CURE.

Illustrated by the History of Thirty-three Cases successfully treated.

Price 7s. 8vo. cloth.

DR. FLOOD

ON THE ANATOMY AND OPERATIVE SURGERY OF

INGUINAL AND FEMORAL HERNIA.

Illustrated with Eight coloured Plates, drawn from Nature, on Stone, by Mr. W. Lover, from Dissections and Designs of Dr. Flood. Folio, 10s. 6d.

DR. FLOOD

ON THE SURGICAL ANATOMY OF THE ARTERIES,

and Descriptive Anatomy of the Heart; together with the Physiology of the Circulation in Man and the Inferior Animals.

12mo. cloth, price 7s.

MR. ANDERSON'S
 SKETCH OF THE
COMPARATIVE ANATOMY OF THE NERVOUS SYSTEM:

With Remarks on its Development in the HUMAN EMBRYO.

With Three Plates (43 Figures), 4to. price 8s. cloth.

"This work possesses considerable merit, and gives evidence in its author of a mind highly capable of minute research and originality of idea."—*Dublin Journal*.

"Its contents should be familiar to all connected with the profession."—*Annals of Medicine*.

MR. J. S. STREETER'S
PRACTICAL OBSERVATIONS ON ABORTION.

Illustrated with Plates and Woodcuts, 8vo. cloth, price 5s.

DR. ARNOTT'S
TREATISE ON STRICTURE OF THE URETHRA;

Containing an Account of Improved Methods of Treatment: with an Appendix, on Dilatation by Fluid Pressure in the Treatment of Urinary Calculus and other Diseases. Second Edition, 8vo. cloth, 7s.

MR. PLUMBE'S
PRACTICAL TREATISE ON THE DISEASES OF THE SKIN,

Arranged with a view to their Constitutional Causes and Local Characters;

Including the Substance of the Essay to which the Royal College of Surgeons awarded the Jacksonian Prize, and all such valuable Facts as have been recorded by continental Authors on the Subjects to the present time.

4th Edition, revised, considerably enlarged, and with additional Engravings, £1.1s. cloth.

DR. MULLER
ON THE NATURE & STRUCTURAL CHARACTERISTICS OF CANCER,

and of those MORBID GROWTHS which may be confounded with it.

Translated from the German, with Notes,

By CHARLES WEST, M.D.

Graduate in Medicine of the University of Berlin.

Illustrated with numerous Steel Plates and Wood Engravings, Part I. 8vo. 7s. 6d. sd.

"As the first fruits of the new mode of investigating this most intricate subject, the results must be acceptable to all; and all will grant that, if the results are not such as to have exhausted the greater part of the questions respecting the nature of morbid growths, the fault lies in the inquiries rather than in the incompetency of the observer, who, if it had been in the power of any man living, would have unravelled the whole subject.

"We cannot conclude without confirming the praise which has been generally awarded to Dr. West for the excellence of his translation.—*Medical Gazette*.

(20)

594

Now completed, Volume I. Price £2, of the

Cyclopædia of Practical Surgery;

EMBRACING

A COMPLETE VIEW OF ALL THE DEPARTMENTS

IN

OPERATIVE MEDICINE.

EDITED BY W. B. COSTELLO, M.D.

MEMBER OF SEVERAL LEARNED SOCIETIES, ENGLISH AND FOREIGN.

The "Cyclopædia of Practical Surgery" has been undertaken for the purpose of collecting into one copious and comprehensive digest the Doctrines of Surgery, and the valuable Views of Practice, which either rest on individual experience, or are inculcated in too isolated a manner for the general benefit. In order to stamp upon this important undertaking—hitherto a desideratum in Medical Literature—that character of authority to which it aspires, care has been taken, in the distribution of the various subjects, to confide the execution of them to persons of acknowledged ability and experience in the several departments; and thus the most distinguished writers in Great Britain and the Continent of Europe have been associated for the production of a work which, when complete, may fairly claim to be considered the most valuable publication of its kind extant in any language.

PARTS I. TO XII. *are now published.*

The Cyclopædia of Surgery is issued in Parts, at 5s. each, and printed in double columns, with a new type, cast expressly for the purpose, on superfine paper of the largest royal 8vo. size. The articles are illustrated with Woodcuts and other Engravings, wherever they are required.

"It must suffice, in our space, to mention the general plan on which the articles are prepared. First, the exact meaning or value of each term under which the subjects are displayed, is defined, according either to its general acceptation, or the writer's notion of its purport. Then, general observations on the subject to be treated are made. Next, its subdivisions are discussed, its progress as a branch of science is historically traced, and the reader is then, in the body of the article, instructed by argument, exposition, and references, in the characters, the pathology, the consequences, and the treatment, or such other points as belong to the topic under explanation. The differences of opinion entertained upon the facts amongst men of authority are stated and weighed with such judgment and absence of prejudice as the writers can command—a better plan to adopt in works of instruction, than making those interminable citations, which might more appropriately be termed *contradictions*. For the emergencies of practice generally demand that the routine should be at once dictated, and not left, like evils, to a choice.

"The Cyclopædia of Surgery embraces, of course, in its plan, Obstetric Surgery, and a description of operations, instruments, a copious bibliography, and a dictionary of terms, constituting a very satisfactory addendum to the essays. In this lesser department of the lexicon, the definitions are given with clearness and acumen, restricting to their proper use, or bringing back to their original meaning, many terms which had become vague or inapt, from rarity, misuse, or neglect. Engravings and Woodcuts are freely employed to illustrate the text, and especially adorn the subjects of Amputation, Aneurism, Bandage, Cataract, Club-foot, and Cornea."—*Lancet*, Aug. 25, 1841.

The first Eight Parts, forming Vol. I. of the Work, may be had in Cloth, price £2 : 0 : 0.

List of Contributors

TO THE

CYCLOPÆDIA OF PRACTICAL SURGERY.

John Adams, Esq.
 William Auchincloss, M.D.
 Sir G. Ballingall.
 Thomas Bell, Esq.
 Charles Benson, M.D. M.R.I.A.
 S. A. Bindley, Esq.
 P. F. Blandin.
 Thomas Leigh Blundell, M.D.
 John Blackburn, M.A.
 Sir Benj. Collins Brodie, Bart.
 Andrew Buchanan, M.D.
 Thomas H. Burgess, M.D.
 John Burns, M.D. F.R.S.
 R. Carmichael, Esq. M.R.I.A.
 Henry T. Chapman, Esq.
 Sir Astley P. Cooper, F.R.S.
 B. B. Cooper, Esq. F.R.S.
 W. Sands Cox, Esq. F.R.S.
 Sir P. Crampton, M.D. F.R.S.
 J. Green Crosse, Esq. F.R.S.
 T. Blizard Curling, Esq.
 John Dalrymple, Esq.
 John Birt Davies, M.D.
 P. T. Dieffenbach.
 J. C. Donnellan, M.D.
 Robert Druitt, Esq.
 James Eager, M.D.
 John Elliotson, M.D. F.R.S.
 William Fergusson, Esq.
 Valen. Flood, M.D. M.R.I.A.

P. H. Green, M.D.
 George Gulliver, Esq.
 Geo. J. Guthrie, Esq. F.R.S.
 Marshall Hall, M.D. F.R.S. L
 and E.
 R. Harrison, M.D. M.R.A.I.
 M. W. Hilles, Esq.
 T. Hodgkin, M.D.
 A. Jacob, M.D. M.R.I.A.
 G. Jewel, M.D.
 H. J. Johnson, Esq.
 T. Wharton Jones, Esq. F.R.S.
 T. King, M.D.
 T. Wilkinson King, Esq.
 J. Kirby, LL D.
 George B. Knowles, Esq.
 R. Knox, Esq. M.D. F.R.S.E.
 Robert Lee, M.D. F.R.S.
 W. J. Little, M.D.
 John Lizars, Esq. F.R.S.E.
 P. B. Lucas, Esq.
 John Macfarlane, M.D.
 J. F. Malgaigne.
 J. Malyn, Esq.
 H. Maunsell, M.D.
 Richard Middlemore, Esq.
 J. G. Millingen, M.D.
 Alexander Monro, M.D.
 John Morgan, Esq.
 Thomas Morton, Esq.

Sir J. Murray, M.D.
 James O'Beirne, M.D.
 T. J. Pettigrew, F.S.A. &
 W. H. Porter, Esq. M.R.I.
 Richard Quain, Esq.
 P. Rayer, M.D.
 John Reid, M.D.
 Michael Ryan, M.D.
 Frederick Ryland, Esq.
 John Scott, Esq.
 W. Sharpey, M.D. F.R.S.E.
 Samuel Smith, Esq.
 G. J. Sigmond, M.D. F.L.
 John South, Esq.
 Edward Stevens, M.D.
 Claudius Tarral, M.D.
 T. P. Teale, Esq. F.L.S.
 William Thomson, M.D.
 Benjamin Travers, Esq. F.I.
 Frederick Tyrrell, Esq.
 Alexander Üre, M.D.
 A. A. L. M. Velpeau, D.M.
 W. H. Walshe, M.D.
 James Wardrop, M.D. F.F.
 Alexander Watson, M.D.
 T. Spencer Wells, Esq.
 William Wickham, Esq.
 Robert Williams, Esq.
 R. Willis, M.D.

" Dr. Costello (editor of the Cyclopædia of Practical Surgery) early evinced his competency to supervise a branch of literature, by an article in his work, which required considerable ability in the selection and arrangement of its materials, and bears a high character among the essays with which it is associated. The names of his contributors need not be repeated here, as they have already obtained in advertisements ample notoriety; but we specially observe, that in this Cyclopædia are to be found, for the first time, the writings, in *English*, of Dieffenbach and Velpeau. * * * Upon the whole, the articles are distinguished by clearness and simplicity of arrangement, style, and fairly perfect the subjects which it was the task of the writers to discuss. To students, as well as active practitioners, the work promises to become a first-rate text-book, levelling a host of obstructions to a view of surgery, which a dozen or so years since perplexed their attempts to inspect the ground."—*Lancet*, Aug 26, 1841.

" The work itself has not disappointed the expectations of the profession. It is not made up of a series of dissertations, with here and there one by an able hand, shedding its brilliancy and light over a dull blaze of monotonous mediocrity—an oasis in the waste. There is a uniformity, a substance, a power and a tone throughout creditable not alone to the individual writers, but to the time and country in which we live. The Cyclopædia of Practical Surgery may not only challenge, but will advantageously sustain, comparison with any other similar work of other countries; and if we infer the extent and superiority of the education of the surgeons of this country, from the high character of the work before us, considering it as a book of reference prepared for them, we cannot but rejoice at the changes that have been brought about within the last quarter of a century. * The Cyclopædia of Practical Surgery, conducted to its conclusion in the spirit and style of the present volume cannot fail of the object which it seems to aim at above all others, and which is, to form a work of reference in the present state of surgery shall be fully and clearly expounded."—*Medico-Chirurgical Review*, July 1841.







**PLEASE DO NOT REMOVE
CARDS OR SLIPS FROM THIS POCKET**

UNIVERSITY OF TORONTO LIBRARY

 BioMed

