

TT
518
.C 75
1922

A
Complete
Course in
Dressmaking
in
Twelve Lessons



Lesson II
Aprons and
House Dresses

The fit, hang and making of attractive house dresses explained. Methods of cutting economically. Trimmings that are easy to make and a little chat that will help you to select and combine materials for a well turned out garment.

by

Isabel DeNyse Conover

A COMPLETE COURSE IN
DRESSMAKING

BY
ISABEL DENYSE CONOVER



LESSON II
HOW TO MAKE APRONS
AND HOUSE DRESSES

NEW YORK
EDWARD J. CLODE

LC 1922

TT 518
C 75
1922

COPYRIGHT, 1921, 1922, BY
EDWARD J. CLODE

Entered at Stationers' Hall



©C1A690902

23-727

PRINTED IN THE UNITED STATES OF AMERICA

JAN - 4 '23

2-1

LESSON II

HOW TO MAKE APRONS AND HOUSE DRESSES

Now that you have learned in Lesson I to stitch, make seams and hand sew, you will want to put this knowledge to practical use in making charming and dainty things for yourself and others.

Greater enjoyment and quicker progress will be made by selecting the more simple garments for the first steps. The making of an apron, the most simple of all, may be the forerunner of an infinite number of successful achievements in making pretty things.

However, do not feel that you are only learning how to make the aprons illustrated, but realize that these designs have been carefully selected and planned to demonstrate the different methods which can also be used in constructing patterns and making children's clothes, ladies' dresses, undergarments and negligees.

A COMPLETE COURSE IN DRESSMAKING

This practice in Lesson II will serve to train your eye in the selection of charming and becoming combinations of materials and colors as well as training in pattern making, planning the layout or cutting of the material. Also it will give skill to the hands in the various forms of sewing, including the folding of bias bands and applying of other finishing edges.

After this lesson is thoroughly understood you will be able to copy any apron you see. Many a tempting but expensive idea in some specialty shop may be carried home in the mind's eye, and with some delightful novelty goods from that mine of treasures, the remnant counter, a thing of beauty will be evolved at little actual cost.

There is an almost unlimited range of material for these captivating necessities, house dresses and aprons—from unbleached muslin through the calicos, percales, gingham, seersuckers, chambrays to the art prints, chintzes and sateens. Or for midsummer the always attractive dotted and crossbarred swiss, muslin and organdie make the most bewitching affairs. And after all, since the homekeeper wears aprons so much, they should add a distinctive charm to her appearance rather than just be dully useful.

APRONS AND HOUSE DRESSES

Much of the charm lies in the selection of the material, although the combinations of trimming may add greatly to the prettiness. The substantial gingham which wears so well has returned to popularity in all the cheeriness of the red, green and yellow checked with white. The checks which are used for the body of the garment, as well as for bias edges and bands, are considered in better style just now than the Scotch plaids, which must be selected with infinite care.

The checks lend themselves to the use of cross-stitching in the same or contrasting colors or black. Black always tends to bring out the value of other colors and for that reason it decorates almost everything at the present moment.

Aside from the checks, where embroidery or fancy stitches are to be used, a plain material is a wiser choice, and featherstitching or outlining in color will show up to far greater advantage. You will find many pretty fancy stitches described in Lesson IX.

Sateens and the art prints are more for afternoon use, to slip on when preparing afternoon tea, serving dinner or when there is a moment for the stocking mending whose lint will cling to the woolen frock or suit.

Indeed, the apron habit saves many brushings as well as spots and by its use the few minutes of waiting between things may be well employed without disarranging one's trig appearance.

There are styles of aprons appropriate for any and all occasions and make most enchanting and much appreciated gifts. Many a young bride in her new environment daily blesses the friends who gave her bungalow aprons for the morning, slip-on aprons for odd moments, big comfortable aprons to save the crisp house dress on baking days and the fascinating affairs to cover her lovely new frocks at tea or dinner hour. Especially is the apron acceptable with pockets which hold all the little things—buttons, thread, darning cotton and small scissors—so that one may sit quietly without the tiresome jumping up and down.

The children's aprons make such pretty particular gifts, especially when embroidered in gay flowers, darling bunnies or little chicks. At church fairs and bazaars the apron table is always one of the most successful. It affords an opportunity to display taste and ingenuity at little cost to the giver.

For the smart, simple house dresses there is

even a wider range of material. In addition to those already mentioned cotton crepes, galateas, seersuckers and other washable materials can be used most effectively. The same rules govern the choice of trimming and it is wise to remember that the smaller the article the brighter and more intense the color may be. Review combining colors in Lesson I and work out some color problems in house dresses. It is good practice.

The most simple designs are the most pleasing, depending on the choice of material and edge finishings, which are usually in contrast to the material. I am giving you in the following paragraphs some simple finishes for edges which are especially appropriate for aprons and house dresses. They are also the most practical manner of finishing wash dresses and the summer cottons for the children.

SIMPLE FINISHES FOR EDGES

The most simple edges are the narrow hem, binding, piping, facing an edge with tape, finishing an edge with woven banding and with rickrack braid.

Narrow Hem.—A narrow hem is one of the very easiest ways of finishing an edge. It is

used to finish the sides and strings of aprons, armholes of waist linings and sometimes for hemming collars and cuffs. It is practical for anything which requires finishing in a neat, flat, inconspicuous manner.

You will recall in Lesson I that I explained just how to turn a narrow hem with the sewing machine attachment and it may be helpful to you to read that description over again carefully.

If you are not using the attachment, first turn off the sixteenth of an inch along the edge,

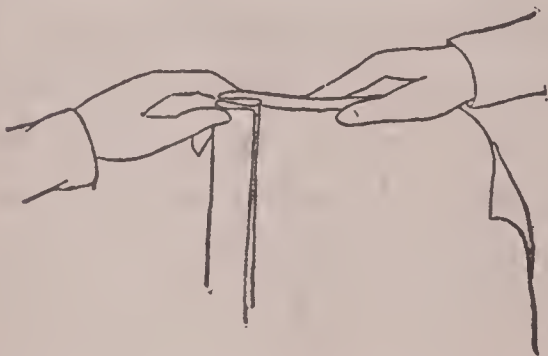

Fig. 1. *Folding the edge for a narrow hem*

creasing the material between the fingers as in Fig. 1, and then turn in an eighth of an inch. Press the edge with a hot iron. *A hem that is pressed is much easier to stitch than one that is*

roughly and irregularly creased. You cannot expect to have a neat finish if the edges are not neatly and accurately pressed before you stitch. Stitch the hem as in Fig. 2.

Cutting True Bias.—Fold the material diagonally, bringing the crosswise thread to a

APRONS AND HOUSE DRESSES

lengthwise thread. Then, cut along the diagonal line. (See Fig. 3.) Join the bias strips in a continuous piece as in Fig. 4.



Fig. 2. A narrow hem turned and stitched

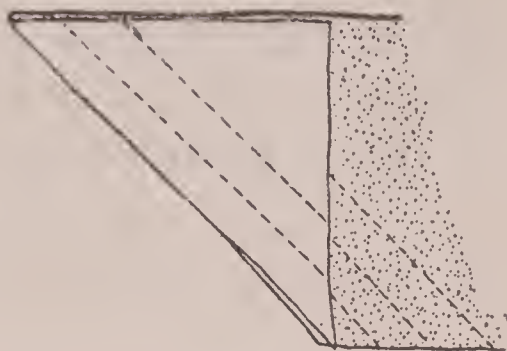

Fig. 3. The material folded and marked for bias strips for binding or piping

Cut off portion of seam which extends beyond strip as indicated by dotted lines.

Binding.—The use of bindings adds very much to an apron or house dress, as the contrasting material brings out the color and design of the garment and also emphasizes the lines. The contrasted binding of the long lines of an apron or house dress will bring out an effect of slimness, whereas binding all the crossing lines such as pockets, belts and hems at the lower edge and around the neck will serve to shorten the appearance of the wearer.

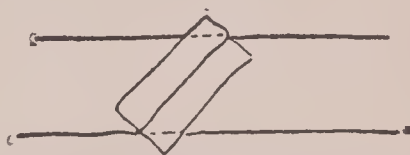

Fig. 4. Make an open seam in joining the bias folds

A COMPLETE COURSE IN DRESSMAKING

The binding to be effective should not only be of different color, design or material, but also of goods of a firm texture and yet not bulky. *It is easier to round off a corner than to turn at right angles and bind a square corner.* Binding is very quickly and neatly done with a binding attachment. (See Lesson I.)

To do binding by hand, as a dressmaker would say, and which means without an attachment, lay

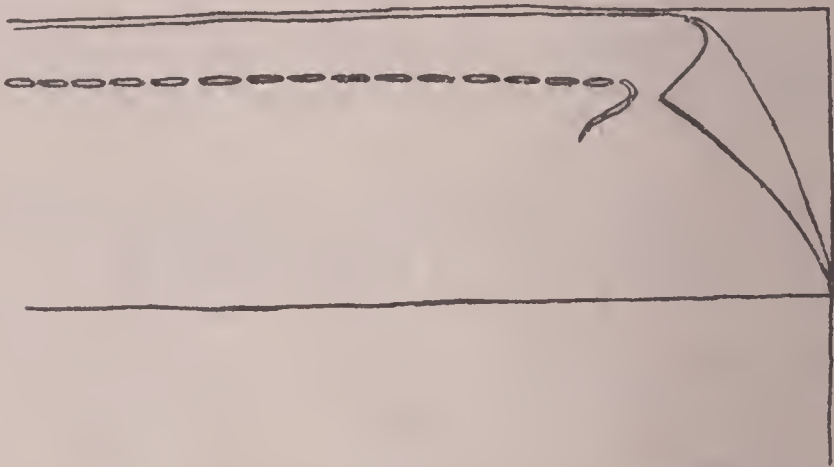

Fig. 5. *The first stitching in joining a bias binding to the edge*

the binding along the edge of the material with the right side of the binding next to the right side of the goods. (See Fig. 5.) Stitch along the edge, running the stitching one quarter of an inch from the edge.

Fold the binding onto the wrong side of the material. (See Fig. 6.) Turn under the free edge of the binding one-fourth of an inch and

APRONS AND HOUSE DRESSES

stitch the binding flat to the material. (See Fig. 7.)

If you turn the binding on the wrong side of the garment so that the edge comes below the edge of the fold on the right side of the garment, and then stitch from the right side of the garment just below the binding, the

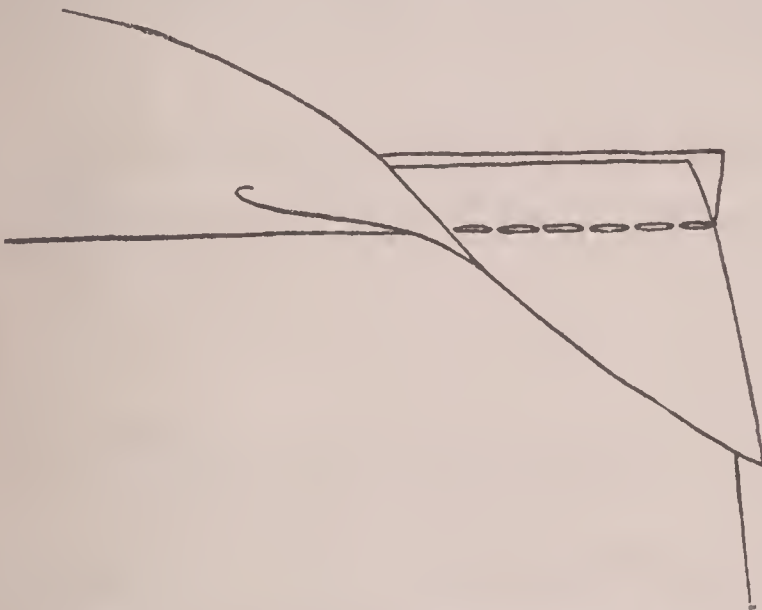

Fig. 6. The binding turned the first time

stitching will hardly show. (See Fig. 8.) If you want a very nice hand finish, fell the fold into place on the wrong side.

Edges which are to be bound should have the seam allowance cut off. Binding neither adds to nor takes away from the size of the garment.

Checked gingham makes a very delightful finish. An apron of barred white muslin can

be much enhanced by a binding of delicate blue and white check. The one-color chambrays, in the lovely gray blues, rose and other tones, are so attractive when edged with checks. White and even deeper shades of the same material are effective in the check. A touch of scarlet is sometimes desirable. A smart little percale of white dotted with dark

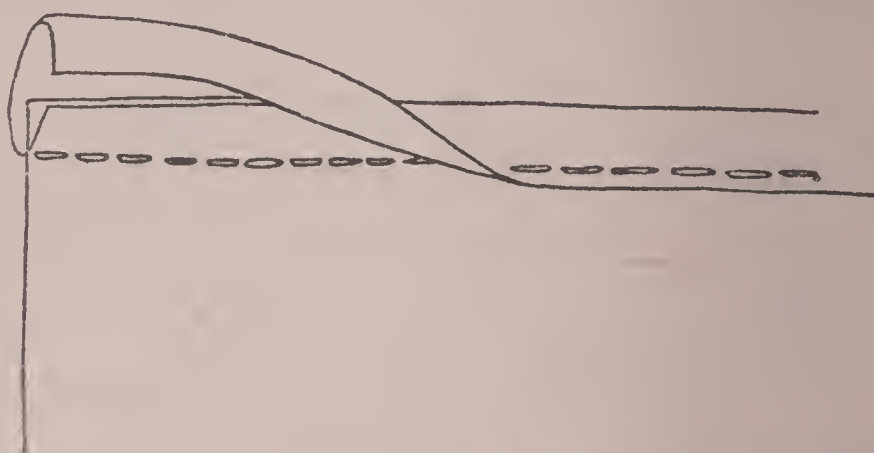

Fig. 7. The binding turned onto the wrong side and stitched

blue and bound with cherry makes a charming and unique combination.

Pipings.—Pipings are used in much the same places as binding. As a rule, they are much narrower and can also be used on woolen materials, as on cotton. They serve to brighten up garments which would be too dull and uninteresting if made all of one tone and material. Pipings are used not only for edges, but where the material joins together, such as

APRONS AND HOUSE DRESSES

waist and skirt yokes, deep bands on skirts and any place where it is desirable to emphasize the joining.

Pipings should be of firm material, which is easier to handle and which will retain its shape while stitching. They are cut on the bias in one and one-quarter inches width. As they are very narrow when finished they may be of a gay and vivid material. Brilliant

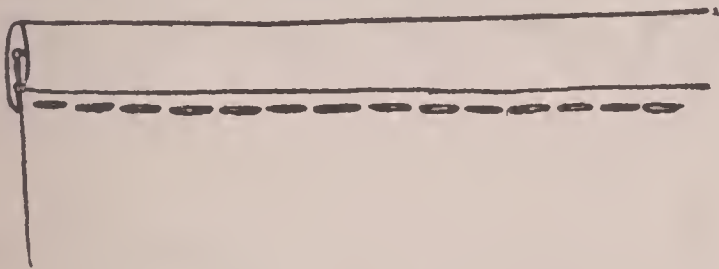

Fig. 8. If the stitching is placed just below the binding on the right side of the garment it will hardly show

red may pipe the edge of a blue chambray or striking green outline the edge of a gay figured chintz or cretonne with a colored background. Colored pipings may be used most effectively on muslins and organdies, especially the figured ones, and when edging an apron the color can be introduced in wider width on the ends of the strings.

If the edge of the garment is to be piped, fold over one edge of piping a quarter of an inch and press. Turn back the other edge of the

A COMPLETE COURSE IN DRESSMAKING

pipings an eighth of an inch and stitch near this edge. (See Fig. 9.) Turn under the edge

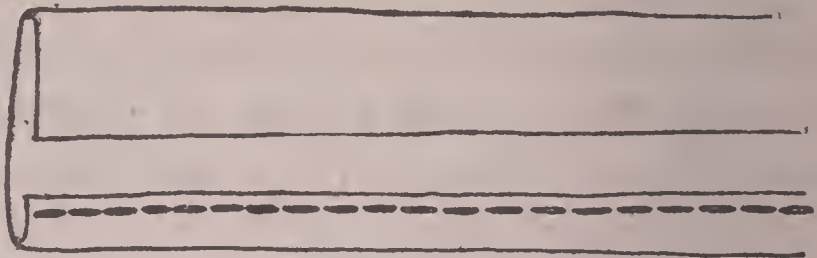

Fig. 9. The bias fold turned and stitch for a piping

to be piped a seam's width and press. Place the piping under this edge with the edge of

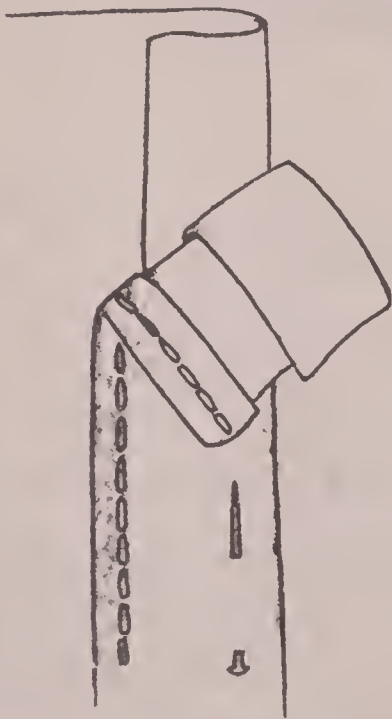

Fig. 10. The piping pinned in place

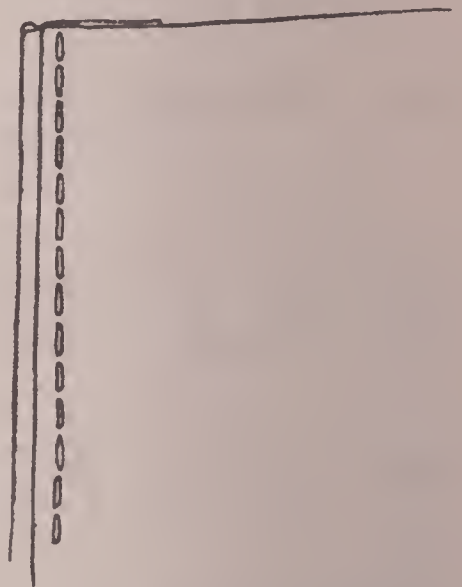

Fig. 11. As the piping looks on the right side of the garment when stitched in place

the piping extending one-eighth of an inch beyond the piece. (See Fig. 10.) Stitch from

the right side of the garment near the edge. Fig. 11 shows how the piping looks on the right side of the garment.

Facings.—Another way to introduce novelty and color into these delightful aprons and frocks is the use of facings in varying widths. These are often used to finish the neck and sleeves of house dresses. The width is entirely a matter of choice, but facings are usually much wider than bindings and pipings.

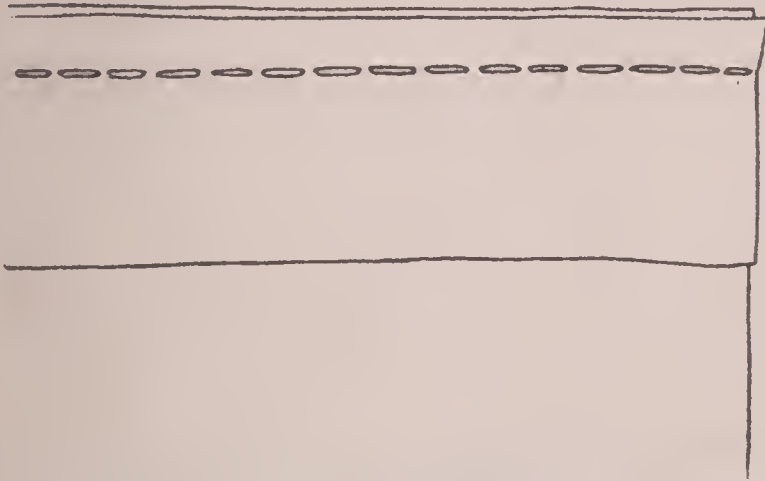

Fig. 12. The first stitching in facing an edge

Facings are used very often with only a small portion visible on the exterior and the wider portion beneath only revealed by the movements of the wearer. This is much employed on dark blue and black garments in the facing of lower hems, of the edge of the bell-shaped sleeve and the elongated panels at either side.

While a pretty width is one inch wide, which means cutting the material one and three-quarters wide, it may be much wider even for aprons. For instance, in an apron of muslin of the unbleached type with the creamy tone but somewhat finer texture, wide bands of flowered cretonne in lovely colors were so

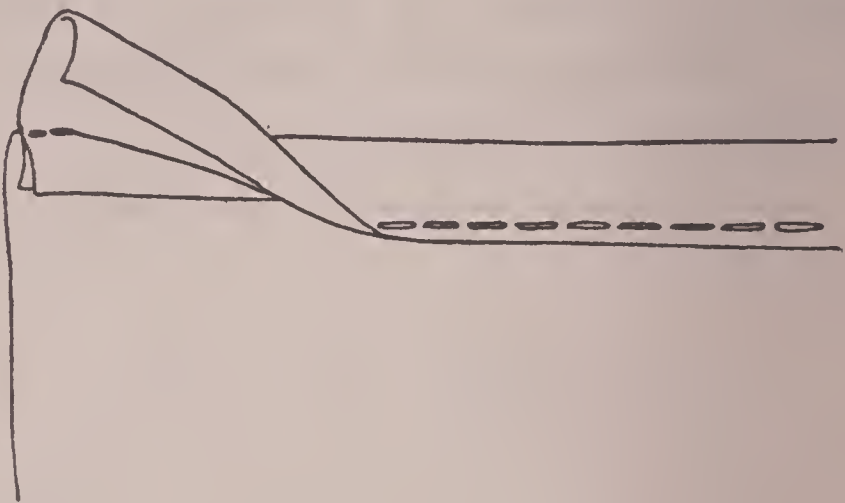

Fig. 13. The facing turned onto the wrong side of the garment and stitched in place

wide that the straps over the shoulders were entirely of the cretonne and only a little of the muslin showed above the band at the bottom.

To face an edge lay the facing on the wrong side of the goods along the edge as shown in Fig. 12. Turn it onto the right side and fold under the edge and stitch as in Fig. 13.

APRONS AND HOUSE DRESSES

Finishing the Edge with Tape.—As a change from the made edgings, cotton tape about three-quarters of an inch wide makes an inexpensive finish for a house dress, apron or child's frock.

This tape can be bought at the notion counter of any department store in white,

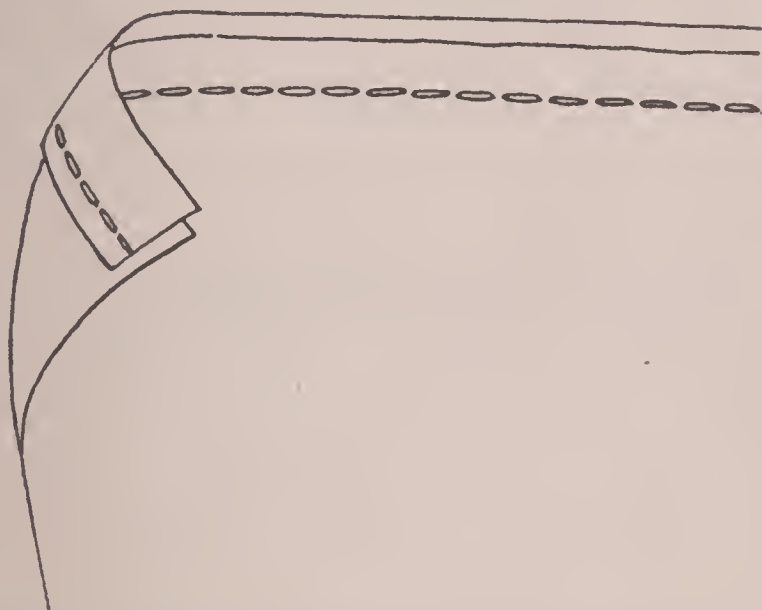

Fig. 14. Tape placed on the right side of the goods and stitched the first time

red and other colors, and is especially useful when the material of the article in making is not expensive enough to warrant the expenditure of much time. In fact, the cotton tape is one of the best "hurry up" edges you can use. You would naturally combine it with materials of firmer and heavier texture than the more dainty weaves.

Lay the tape on the right side of the garment along the edge, letting it extend a quarter of an inch beyond the edge. Stitch a seam's width back from the edge of the garment as shown in Fig. 14. Turn the tape onto the wrong side and stitch a second time from

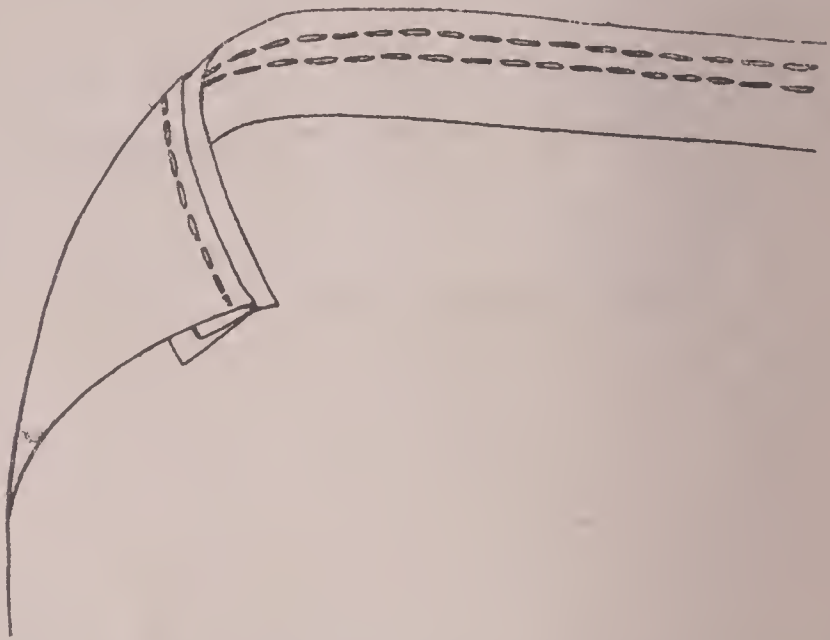

Fig. 15. The tape turned onto the wrong side of the goods and stitched the second time

the right side of the goods as shown in Fig. 15.

Finishing the Edge with Woven Bandings.—The woven bandings in white with floral or other designs in color or with a colored ground with contrasting motives are most charming and lend distinction to otherwise

APRONS AND HOUSE DRESSES

plain clothes. They are suitable for house dresses, simple tub frocks, little children's clothes, and even washable blouses and laundry bags, as well as the ever-present apron.

Here is a vast field for the display of exquisite taste which may result in a delicious rose design on a white ground edging with charm a delicate blue chambray or smart black and white appearing with green or rose

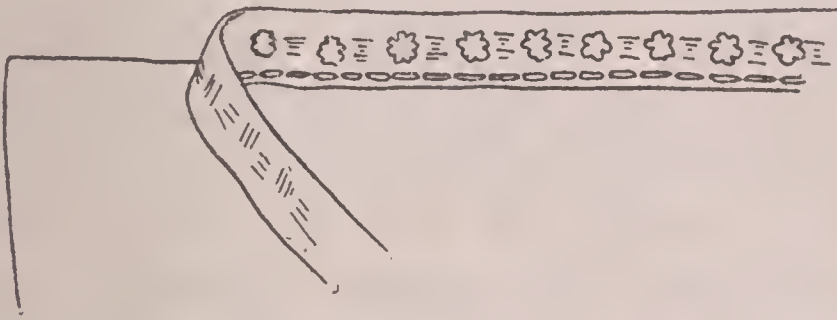

Fig. 16. Finishing an edge with embroidered banding

colored materials. Of course, a banding with a design is only suitable combined with a plain material or with one which has the design so subdued and interwoven with the background that it has a neutral all-over effect.

To finish the edge with woven banding, cut off the seam allowance at the edge except an

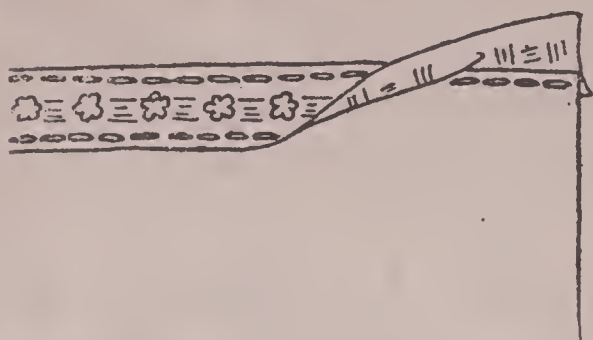

Fig. 17. The banding turned onto the right side and stitched the second time

eighth of an inch. Lay the banding on the wrong side of the garment, allowing the edge of the banding to lap about one-eighth of an inch over the edge of the garment and stitch as

shown in Fig. 16. Turn the banding onto the right side of the goods and stitch a second time as shown in Fig. 17.

Finishing the Edge with Rickrack Braid.—All the delightfully quaint old-fashioned finishings are coming into style again and one wonders where they are most charming—whether they appear prettiest on the wee clothes or on the grown-up house gowns and protecting aprons. Rickrack ranks with the prettiest pipings and bindings and also with the cotton tape for quickness of application. It is seen not only on the sleeves, necks, belts and pockets, but on fronts and backs—in fact, wherever a band of material has been applied.

Where the rickrack braid finishes an edge it is placed under the edge of the material with only half of it showing. (See Fig. 18.) To do

APRONS AND HOUSE DRESSES

this, place the braid on the right side of the goods near the edge and stitch through the center of the braid. (See Fig. 19.) Then turn it onto the wrong side, press the edge and stitch.



Fig. 18. *An edge finished with rickrack braid*



Fig. 19. *The braid placed for the first stitching*

General Directions for Cutting.—Lay the material on a flat surface. Smooth out any wrinkles. Don't cut just one piece at a time, as you may happen to need it for the sewing.

Always lay all the pattern pieces on the goods before cutting any one piece. It will save goods. The pieces often can be shifted around and arranged to fit into a small amount of goods. In planning to cut any garment, place the largest pattern pieces on the goods first and then fit in the smaller pieces.

As a general rule, center-front and center-back edges of the pattern are placed on the lengthwise of the goods and straight of the goods, which means parallel to the selvedge edges. Where the lower edges are straight

they are placed usually as nearly on a true crosswise as possible, which means at right angles to the selvedge edges of the material.

There are two ways of laying a pattern on the goods. The goods may be laid in a single thickness or folded double. When folded double, usually the selvedges are brought together and the material is creased through the center lengthwise; although there are cases where it is advantageous to fold it crosswise.

It may even happen that material can be saved by folding over only a third, a quarter or less on the lengthwise, leaving the rest in a single thickness.

In spreading out the material in a single thickness or in folding it double, keep the wrong side uppermost. It is by far the best plan, when possible, to lay the pattern on the wrong side of the goods. Then you can mark on the goods without danger of injuring the fabric, except in cases of very sheer materials.

Although it is possible to pin a tissue paper pattern to the goods and then cut the piece, it is better to weigh down any pattern and

mark around it. Use ordinary paper weights and mark with tailor's wax or chalk spoken of in Lesson I. Keep the wax or chalk shaved down to a thin edge. Be very sure to mark along the exact edge of the pattern and hold the wax or chalk as in Fig. 20.

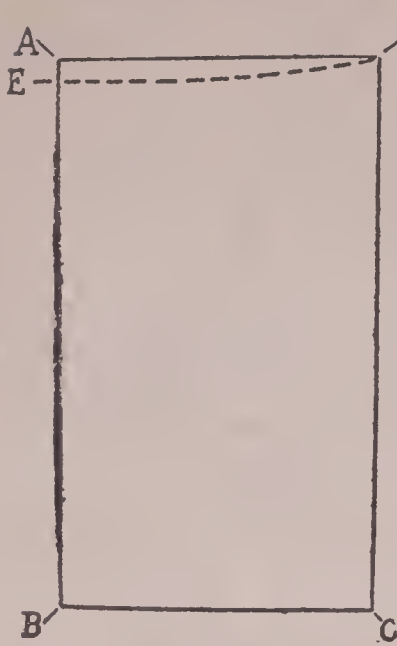

Fig. 20. Keep the wax or chalk thin on the edge and hold it firmly in marking around the pattern

In the dressmaking trade, when all the pattern pieces are laid on the goods, it is called a layout. Throughout these lessons you will find the process of laying the pattern on the goods spoken of as *laying out* the pattern and the pattern laid on the goods as *a layout*.

Making a Waistline Apron Pattern.—It is hardly necessary to make a pattern for a garment so simple as a waistline apron. However, a pattern proves a great convenience, if you are cutting more than one apron, as it saves figuring out the proportions each time. Making the pattern will give you excellent practice and will show you how to slope the waistline, which information you can use later many times in various ways.

To make the pattern draw a straight line similar to the line *AB* in Fig. 21, using your



yardstick or tailor's square. This line should measure twenty-seven inches. Draw the lines *AD* and *BC* at right angles to the *AB* line. Each of these lines should measure eighteen inches. Mark at point *E*, one inch below point *A* and reslope the waistline as indicated by the dotted lines.

Fig. 21. Diagram for waistline apron pattern

To slope the waistline, draw a line at right angles from point *E*, as dotted line marked *EF* in Fig. 22. Three inches out on this line

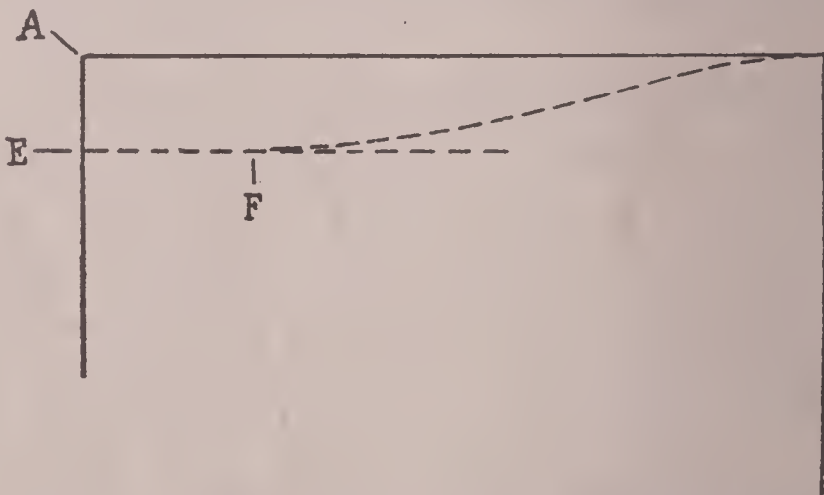

Fig. 22. Diagram for sloping the top of the apron

mark *F*. From the point of *F* blend a curve to the upper edge. This will give an even run to the waistline which will make

APRONS AND HOUSE DRESSES

the apron hang nicely. Line AB is the center front which is laid on the fold of the material.

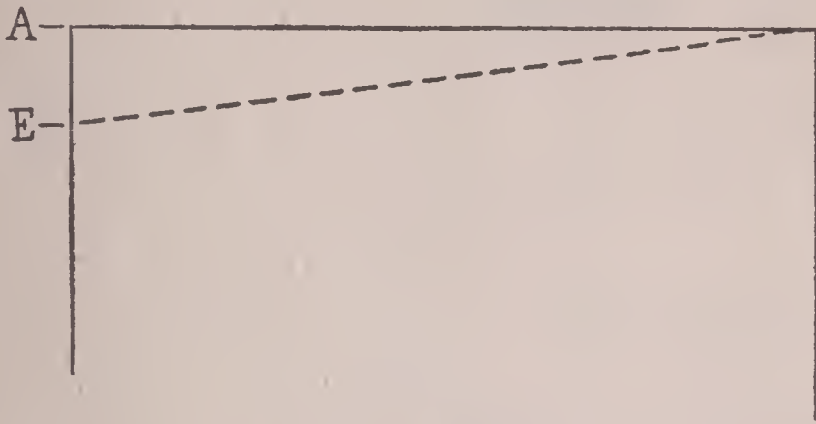

Fig. 23. A straight line at the top of an apron or skirt makes a poor fit

If this seems a bit of trouble to have a simple apron hang smoothly, look at the diagram in Fig. 23, where the straight line was



Fig. 24. If the line at the top of the apron pattern is straight, the material will V at the center front when cut

drawn from point E to the upper edge represented by D in Fig. 21. When the material is cut it will V down in front as in Fig. 24,

which will cause the apron to hike up in front when worn, as shown in Fig. 25.

To make a pattern for the waistband. (See Fig. 26.) *AB* represents the center front.

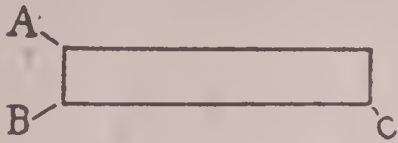

Fig. 26. The pattern for the waistband

Draw a straight line from *A* to *B* measuring two and three-quarter inches.

Then draw two lines from *A* and *B* measuring nine inches each at right angles

to the *AB* line. Join by line measuring two and three-quarter inches at right angles which corresponds to *AB* line. Look at line *C* on diagram.

To make a pattern for the strings, Fig. 27.— Draw a line from *A* to *B* measuring three inches. *AB* represents as before the center front. Draw two straight lines measuring

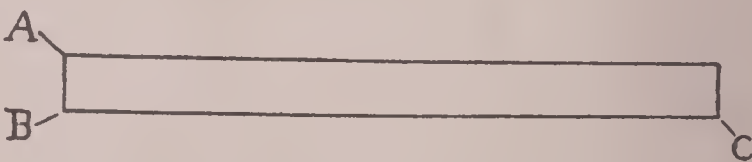

Fig. 27. The pattern for the string

twenty-four inches at right angles to *AB* line. Draw connecting line at right angles, measuring three inches and corresponding to *AB* line: line *C*, Fig. 27.

APRONS AND HOUSE DRESSES



Fig. 25. If the top of an apron is cut in an abrupt angle, the apron will hike when it is sewed to the band

To make a pattern for a pocket.—Draw the *ABCD* box, Fig. 28, as the first step, commencing with the line *AB* and then making the cross lines *AD* and *BC* and finishing with the *CD* line. Be sure that the lines are at right angles, otherwise the pocket will be askew. From *A* to *B* is eight inches and measure the same number of inches from *C* to *D*. The lines from *A* to *D* and from *B* to *C* measure five inches. Measure two inches above point *B* and mark *E*. Then, measure two inches above point *C* and mark *F*. (See Fig. 28.) Draw lines from the points *E* and *F* to the centerway point between *B* and *C*.

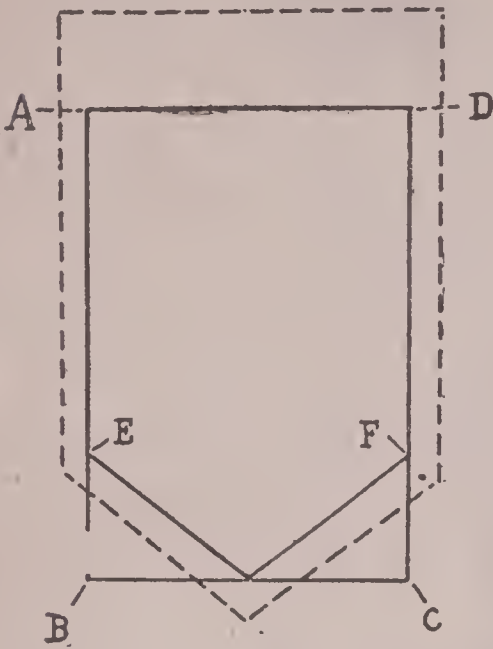

Fig. 28. Diagram for making pocket pattern

measure five inches. Measure two inches above point *B* and mark *E*. Then, measure two inches above point *C* and mark *F*. (See Fig. 28.) Draw lines from the points *E* and *F* to the centerway point between *B* and *C*.

Always make your patterns without seam allowance, as it is much easier to see the shape of the finished piece. The seam allowance is added afterwards as in the dotted lines in Fig. 28. These dotted lines can be put on with a two-wheel tracer or marked with a ruler.

APRONS AND HOUSE DRESSES

Allow an inch and three-eighths at the top of the pocket for a hem. The seam allowance is usually three-eighths of an inch. Carrying out this plan of adding the seam allowance after the pattern is made permits you to see the pocket in its finished shape and makes it easy to vary the size according to

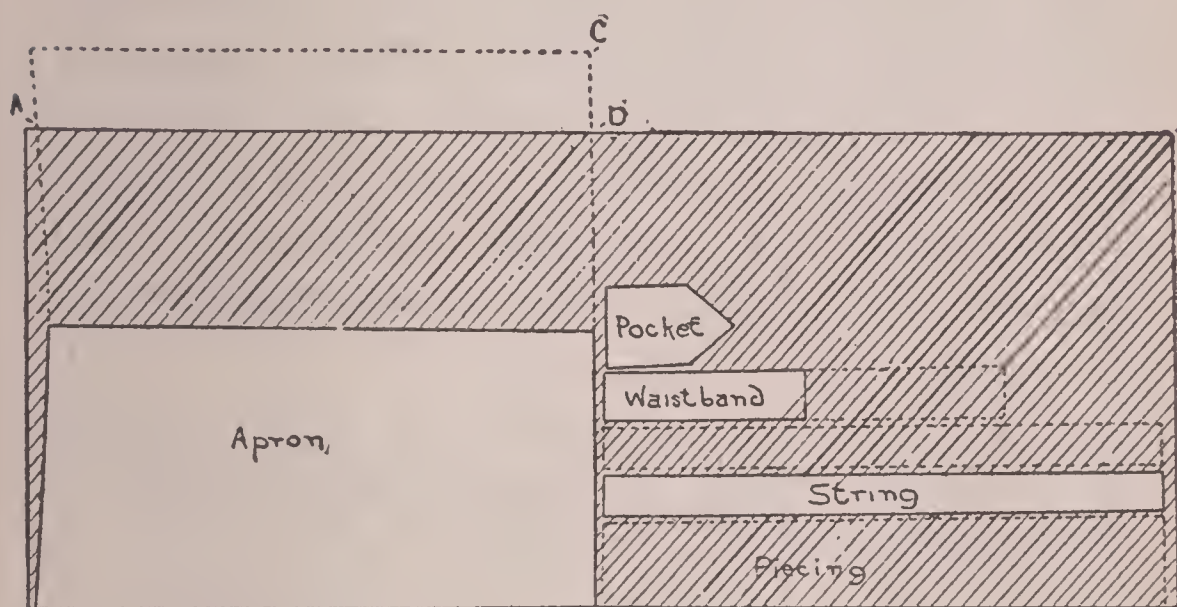

Fig. 29A. In laying a pattern on the goods, place the largest pieces on first and then fit in the small pieces

your taste. Frequently the novelty in the cut or trimming of the pocket is what adds the style to the apron.

Cutting a Plain Waistline Apron.—Diagram 29A shows the plain waistline apron pattern laid on a single thickness of the goods. As only one-half of a pattern is usually given, it is necessary when laying the pattern on a

single thickness of the goods, to turn over each piece and mark around it the second time.

In diagram 29A the solid lines indicate the first placing of the pattern and the dotted lines the position of the pieces when they are turned over. Diagram 29A also illustrates how to mark for a piecing. If your pattern extends beyond the edge of the material, as indicated by the dotted lines *ABCD*, Diagram 29A, mark where the selvedge edge comes on the pattern as line *EF*, Fig. 29B, and a second line three-fourths of an inch in from it as the line *GH*, Fig. 29B. The three-fourths of an

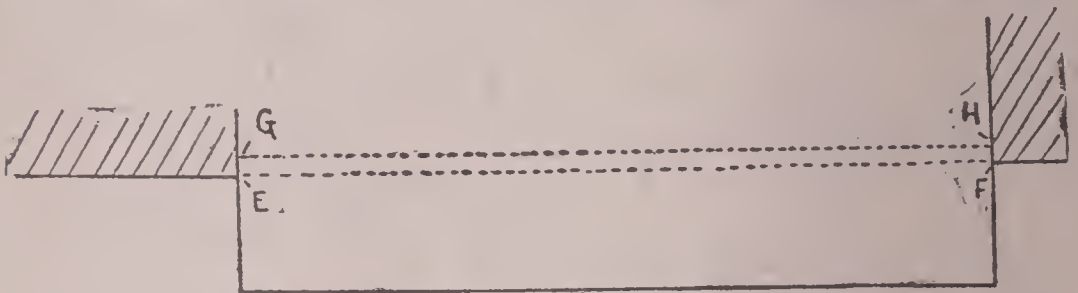

Fig. 29B. *The proper way to allow for piecing*

inch is for seams. Place this portion of the pattern on the goods. (See portion marked piecing in Diagram 29A.)

To Make a Plain Waistline Apron.—Join the piecing to the apron with a plain seam if the edges are selvedge. However, if either of the edges is raw, make a French seam. You will remember that the making of different seams was explained in Lesson I.

APRONS AND HOUSE DRESSES

The next step in finishing the apron is hemming the sides. Here is a place where you can bring your sewing machine attachment in play. A narrow hemmer will turn the edge, neatly and quickly. Lesson I tells all about using this attachment.

If you are not using an attachment, turn and stitch a narrow hem as described in the first part of this lesson.

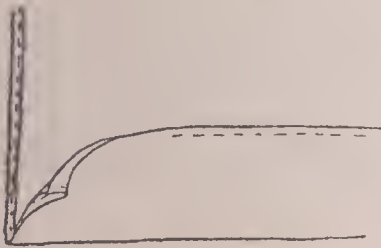

Fig. 30. Turning the hem at the bottom of the apron

At the bottom of the apron turn a three-inch hem. To form a hem of this type, fold under a seam's width, three-eighths of an inch on the lower edge and press the edge. Then, turn up three inches, using your ruler to measure. Press the hem. Pin it at intervals about three inches apart and stitch as in Fig. 30.

Determine the center front of the apron by folding it as shown in Fig. 31. Mark the center front by cutting a straight slash at the top one-fourth inch deep. *A slash of this description is better than a notch, for it will not fray.*

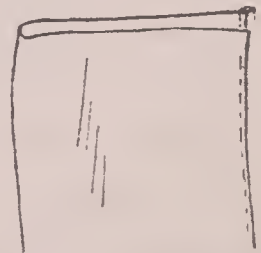

Fig. 31. To determine the center front fold the apron as shown above

Run gather threads across the top. To keep

the fullness equally distributed use two threads,



Fig. 32. *Running in a gather thread.*

starting the threads at the center front and running them to the sides of the apron. Use a double thread for each gathering and run it in with running stitches. (See Fig. 32.)

Use ample thread so that an end will hang down beyond the side of the apron and there will be no danger of it pulling out.

Determine the center front of the waistband by folding it crosswise. Cut one-fourth inch slashes in the top and bottom of waistband at the center front. Lay the waistband along the top of the apron, placing it on the wrong side of the apron. Keep the center fronts even and draw up the gather threads until the top of the apron is the desired size. Distribute the fullness evenly. The ends of the waistband should extend a seam's width beyond the sides of the apron to give room to finish

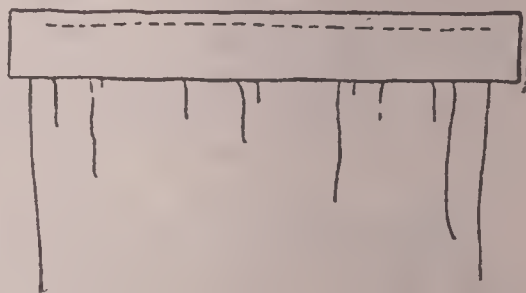

Fig. 33. *The first stitching in joining the waistband to the top of the apron*

APRONS AND HOUSE DRESSES

them. Stitch across the top of the apron. (See Fig. 33.)

Turn a narrow hem on the sides of the strings and wider hems at the bottoms. Lay the unfinished ends in pleats as in Fig. 34 and



Fig. 34. The string pleated and ready to attach



Fig. 35. The string stitched in place

stitch these ends to the ends of the waistband. (See Fig. 35.) Note that the strings extend only halfway across the waistband. Turn

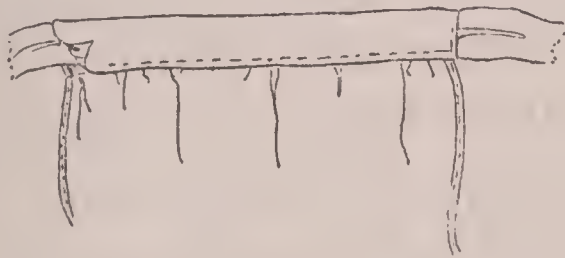

Fig. 36. The waistband folded and stitched the second time

back the free edges of the waistband a seam's width and press. Then, crease the waistband through the center and stitch down the sides

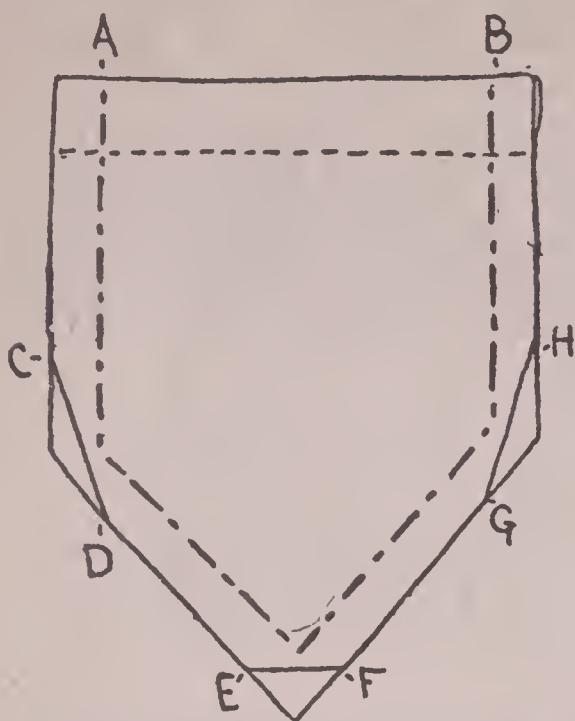

Fig. 37. Cutting off the corners of a pocket makes a neater finish when the seams are turned

and across the bottom as in Fig. 36.

Make a one-inch hem at top of pocket. To do away with unnecessary bulk, cut off the corners diagonally. But be sure not to cut off too much. The safest way is to mark the seam allowance and then cut to within one-

fourth of an inch of the finished corner. (See Fig. 37.) Dotted lines *AB* indicate seam allowances, and lines *CD*, *EF* and *GH* mark portions to be cut off. Turn under seams at sides and bottom and press. The Fig. 38 shows the proper way to turn seam at corner.

Pin the pocket in a convenient position. It should be high enough so the wearer's hand can be slipped in without leaning down. Stitch the pocket as shown in Fig. 39. The Fig. 40 shows the apron finished.

Making a Pattern for a Slip-on Apron.

—Make the box *ABCD* first (see Fig. 41),

APRONS AND HOUSE DRESSES

carefully drawing straight lines at right angles to each other and commencing with the *AB* line as the first one. From *A* to *C* measures seventy-two inches and the cross lines from *A* to *B* from *C* to *D* measure fourteen inches. Now measure seventy-two inches from *B* to

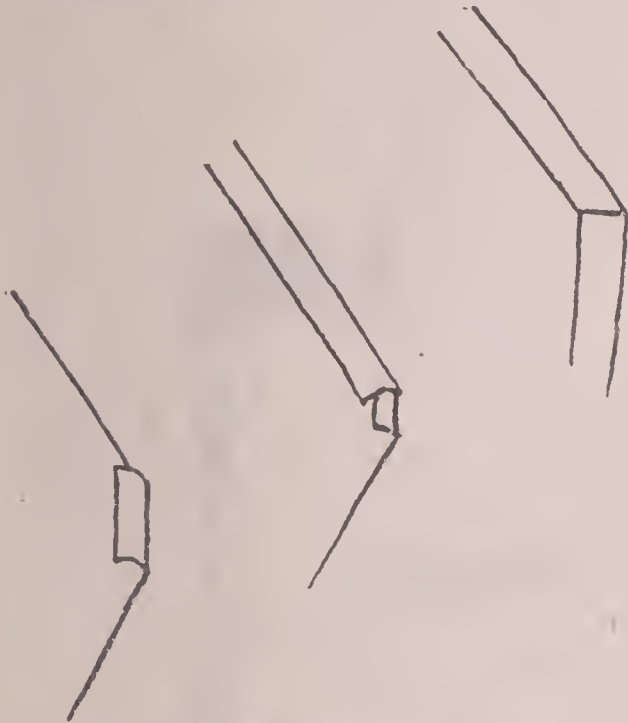

Fig. 38. Turning the seam at the corner of the pocket

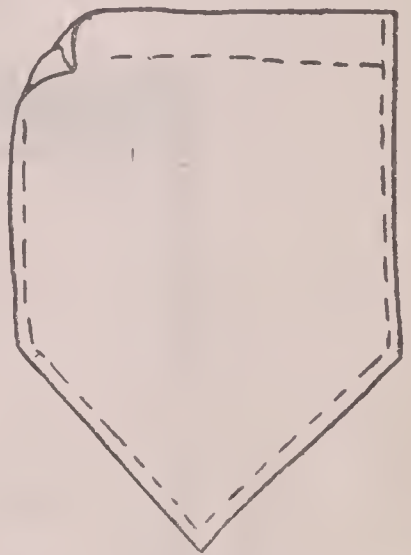

Fig. 39. The pocket stitched to the apron

D and the box is completed. Then draw line across the center and mark *E* and *F* which will give the center of the shoulders. (See Fig. 41.)

Next measure five inches from *C* on the cross line *CD* and mark *G*. Measure eleven inches upward from *D* on the *BD* line and mark *H*. Measure fourteen inches down-



Fig. 40. The waistline apron finished

ward from *F* on the *BD* line and mark *I*. This will locate the points on the front. Starting again at the *F* point measure fourteen inches upward and mark *J*. Measure eleven inches from the *B* point and mark *K*. Then measure five inches from *A* on the cross

APRONS AND HOUSE DRESSES

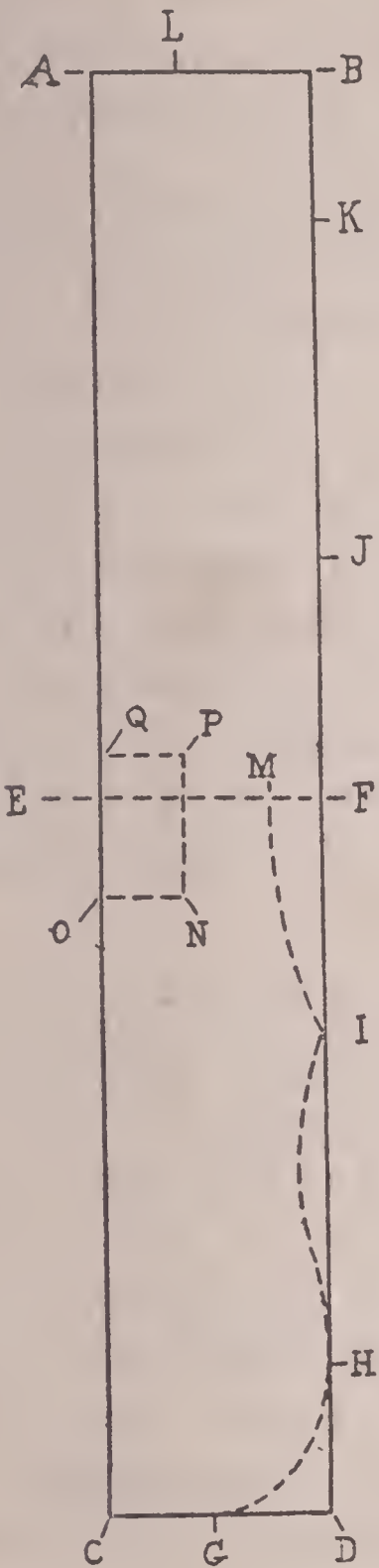

Fig. 41. Diagram for making a slip-on apron

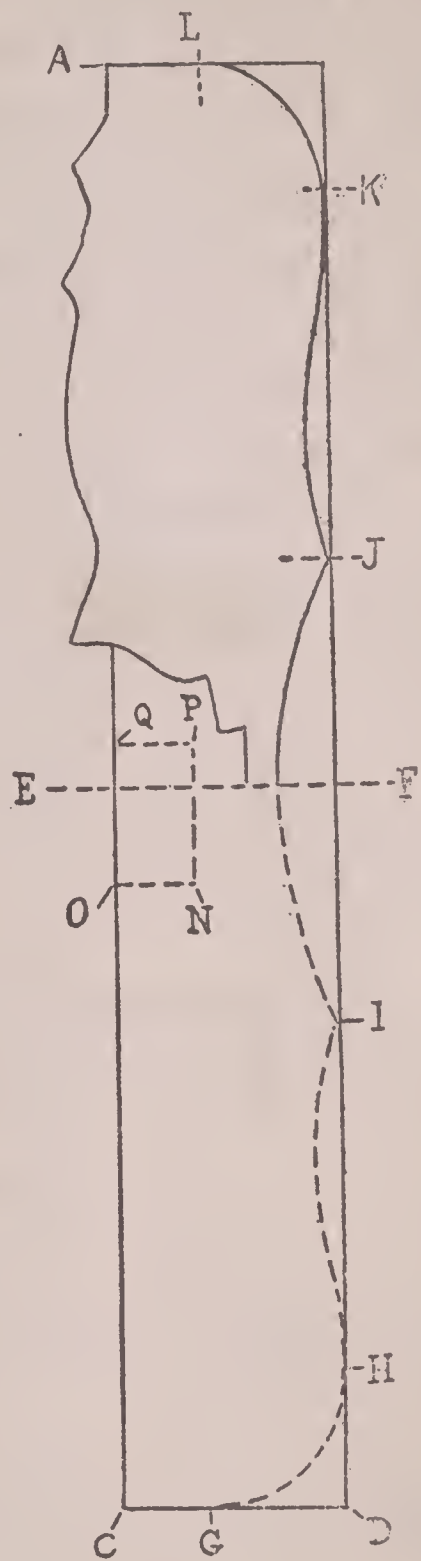

Fig. 43. The second step in making a slip-on apron pattern

line AB and mark V and you have marked the points on the back. Measure five inches from F on the center line FE and mark M .

To determine the depth of the low neck at the back measure three inches upward from point E on the AC line and mark Q . For the depth at the front measure seven inches downward on the AC line from point E and mark O . For the width of the neck measure three inches across from O on a line drawn at right angles to the AC line and mark the end N . Draw a similar line measuring three inches across from Q and at right angles to line AC and mark the end P . Then draw a connecting line from N to P . (See dotted lines in Fig. 41.)

Using the curved ruler draw in curves from point M to I , and from I curving in and out to H and rounding a curve from H to G following the dotted lines as shown in box in Fig. 41. This gives the curved front of the apron. To exactly duplicate the curves in the back put a piece of paper under the diagram and trace the outer edge with the tracing wheel.



Fig. 42. The proper way of holding a tracing wheel

APRONS AND HOUSE DRESSES

Fig. 42 will show you the correct position of the tracing wheel. Remove the piece of paper underneath and cut along its curved edge. Use this as a guide in marking the curves of the back edge. See Fig. 43.

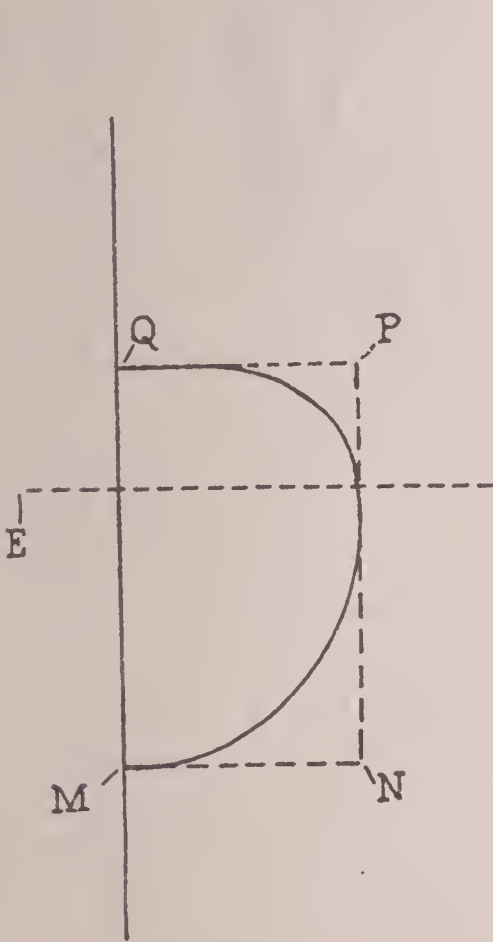

Fig. 44. Determining the neckline of the pattern

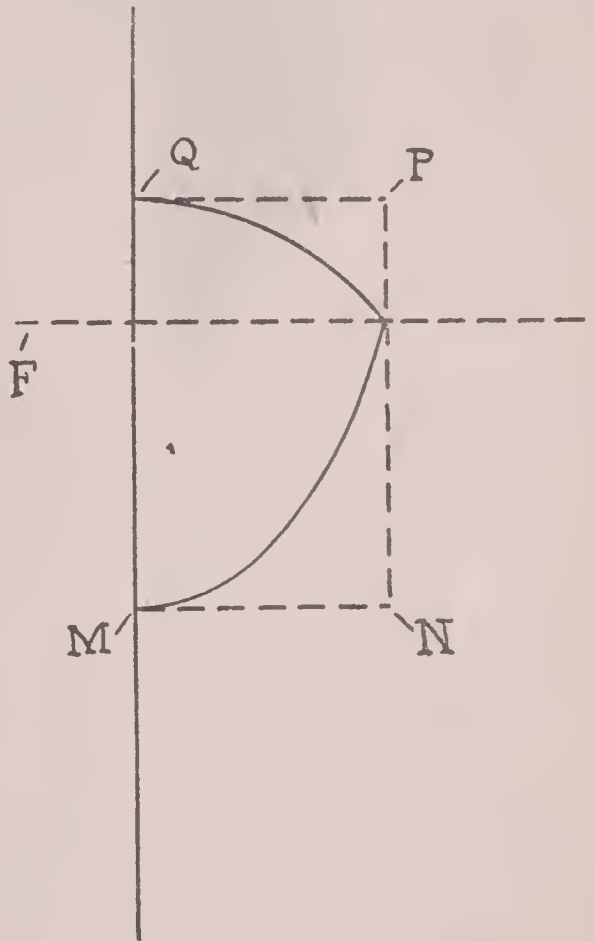

Fig. 45. An awkward curve on the pattern makes an unattractive edge on the garment

After the square lines are marked for the neck it is an easy matter to fill in the curved outline as shown in Fig. 44. In making this curved line, be sure that it is in a true contin-



Fig. 46. A neck that is intended to be oval ought not to have an abrupt angle at the shoulder

uous curve with no abrupt jogs at a different angle in any place. Fig. 44 shows the grace of a well-drawn curve for the neck while Fig. 45 shows a badly done line with an abrupt jog at the shoulders and a dip in the front. If the lines of Fig. 45 are followed the garment will

APRONS AND HOUSE DRESSES

have a homely and unbecoming neckline as shown in Fig. 46.

To make the pattern of the pocket which extends across the front, draw lines on the apron

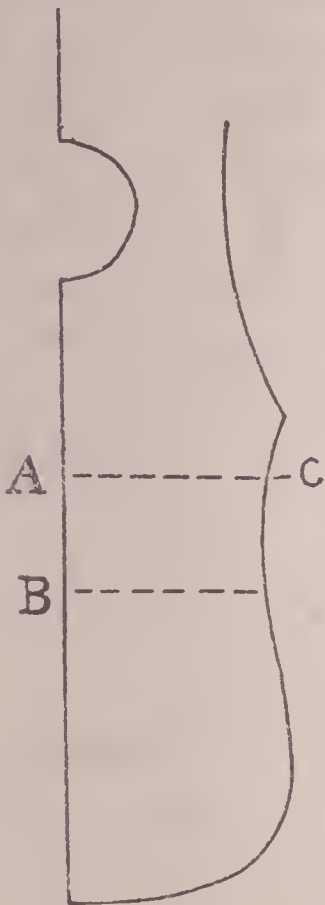

Fig. 47. Marking the position of the pocket on the pattern

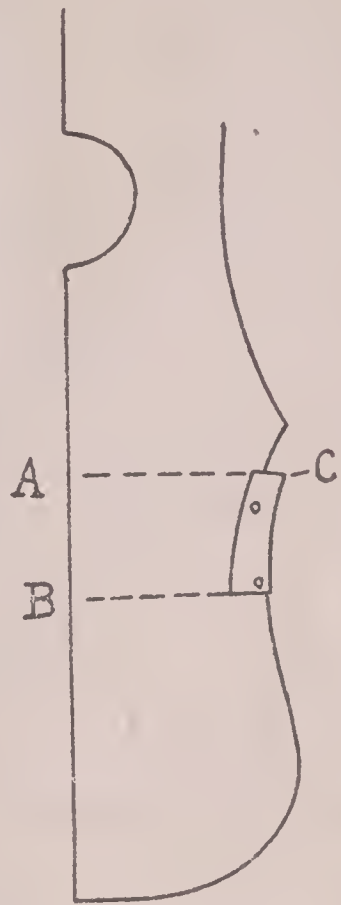

Fig. 48. Drafting the pocket pattern

just where you want to place the finished pocket, commencing with the line *AB* as in Fig. 47. Place the apron pattern on a larger piece of paper. As the pocket should stand away a little at the top from the apron so that

the hand can be slipped in easily, mark a point one-half inch beyond the end of the line marked *A* and mark this point *C*. (See Fig. 48.) Slip a small piece of paper under the apron pattern and trace along the curved edge between lines *A* and *B*. Remove this piece of paper and cut along the curved lines, so that this may be used as a guide in marking the edge of the pocket from line *B* to point *C*. The edge of the pocket must curve exactly the same as the side of the apron pattern, as it is to be sewn along this edge. Trace across the lines *A* and *B* and mark along the front edge. At outer edge mark along edge of cut-out piece from line *B* to point *C*. (See Fig. 48.)



Fig. 49. The slip-on apron pattern placed on the lengthwise fold of the goods

Cutting a Slip-on Apron.—The Fig. 49 shows the pattern placed on the material. In this case, the goods is folded lengthwise through the center and the center front and center back of the pattern are placed on the fold of the goods. As the two thicknesses are cut at one time, it is not necessary to turn the pattern over and mark around it the

APRONS AND HOUSE DRESSES



Fig. 50. A convenient work apron of black sateen trimmed with a binding of old rose sateen

second time, as was described in cutting the waistline apron.

In laying out a pattern it is often advisable to try it both on the single thickness and double

A COMPLETE COURSE IN DRESSMAKING

of the goods to see which way it will cut to the best advantage.

Mark and cut out the pieces as described in the General Cutting Directions in the first part of this lesson.

To Make the Slip-on Apron.—One of the easiest ways of finishing the neck and outer edges is by binding. In the case of the apron shown in Fig. 50, the neck, the outer edges and the top of the pocket are bound.

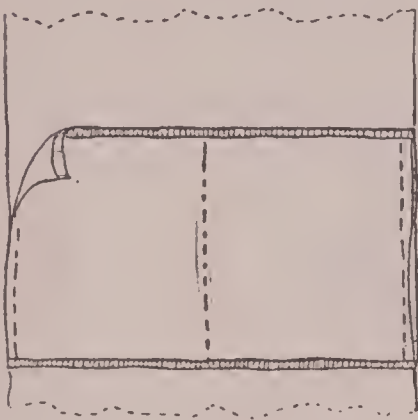

Fig. 51. Sewing the pocket to the apron

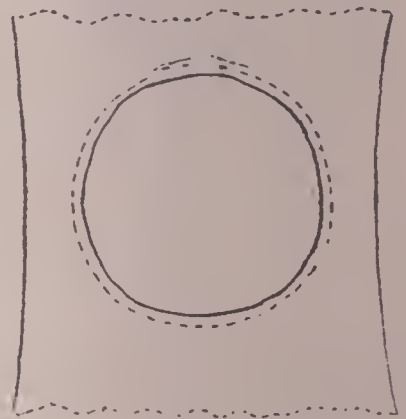

Fig. 52. Sew around the neck to prevent it from stretching

You cannot use straight binding on curved edges. It will pucker. See directions for binding edges in the first part of this lesson.

Bind the top of the pocket first. Turn under the lower edge of the pocket a seam's width and press. Then, place the pocket on the front of the apron, keeping the outer

APRONS AND HOUSE DRESSES

edges even. Baste it along the sides and stitch across the bottom and through center. (See Fig. 51.) A pocket of this type should always be a little larger at the top than the apron, so that it bulges away from the apron and gives room for putting in the hand comfortably.

Run a thread around the neck as in Fig. 52 to prevent stretching. Bind neck and outer edges of apron.

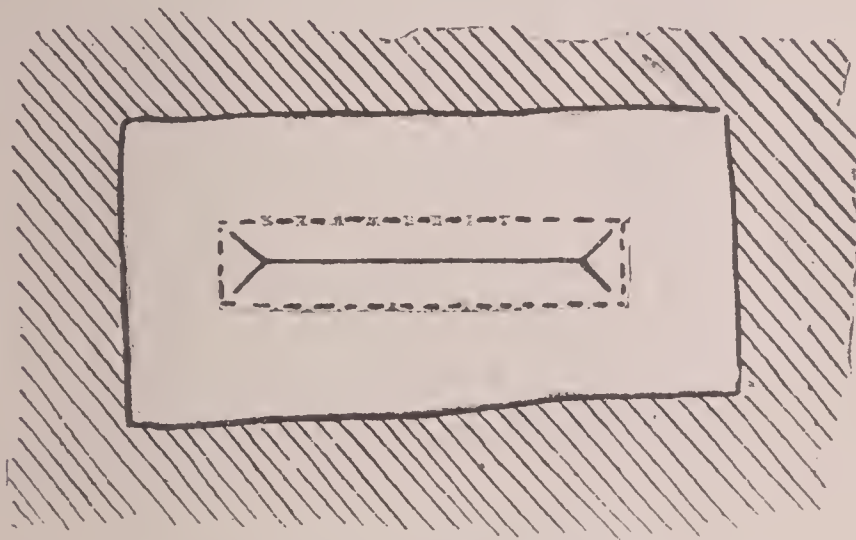

Fig. 53. A bound buttonhole that is finished with a single piece of material is stronger than one with two bindings

Make bound buttonholes in front of apron at underarm.

To make a bound buttonhole that is strong, face it with one piece of material. Mark where the buttonhole is to be placed on the right or face side of the material. Cover the

mark with a facing piece, cut to extend one-half inch beyond the mark at all points. Mark the buttonhole on the facing piece. Stitch either side of the mark, and square across the ends, running the stitching one-eighth of an inch from the mark at all points. Slash centerway between the stitchings to within one-eighth of an inch of the ends. From these points slash diagonally to the corners. (See

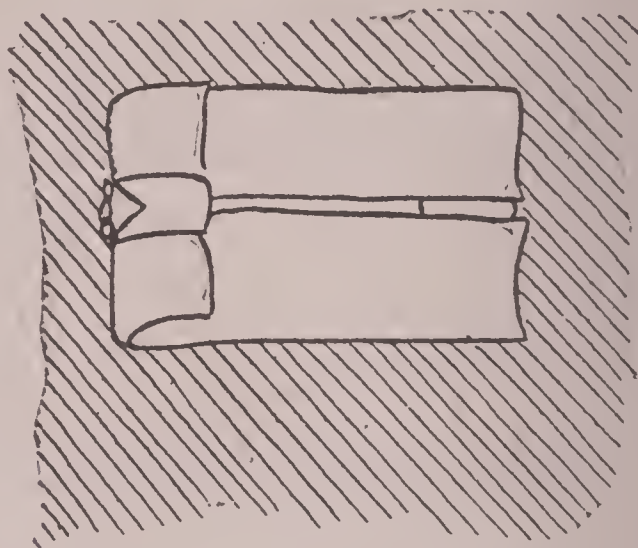

Fig. 54. The facing turned onto the wrong side of the buttonhole

Fig. 53.) Turn the facing through the slash onto the wrong side. At the ends of the buttonhole the facing will fall into two small pleats. Stitch across the ends of the buttonhole again, stitching the facing to the triangular portion which was formed by slashing diagonally to the corners. (See Fig. 54.)

APRONS AND HOUSE DRESSES

Turn under the raw edges of the facing, baste it in place and, working from the right side of the goods, stitch around the buttonhole again. (See Fig. 55.)

For basting use long and short running stitches. The Fig. 56 shows the most practical way of sewing the buttons to the back. Use a fine needle. After taking seven or eight stitches in each hole, bring the needle out between the button and goods. Wrap the thread around the button several times. Pass

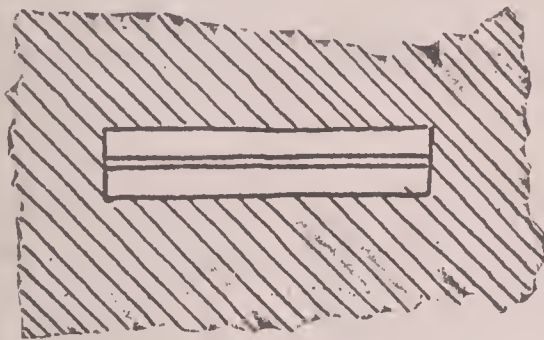

Fig. 55. The finished buttonhole as it looks on the right side of the garment

the needle through onto the wrong side of the goods and secure the thread with several over-and-over stitches.

Using a Block Pattern to Make a Bungalow Apron—Later on I shall tell you how to make a complete pattern, but every dressmaker or woman who sews ought to

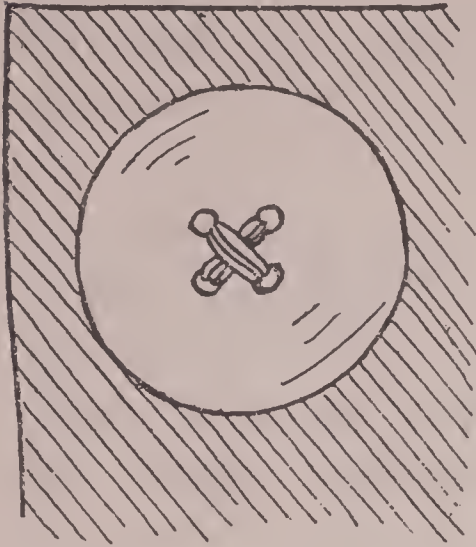

Fig. 56. A button sewed on with crossed stitches

and time-saving devices when she is sewing at home.

A block pattern is a plain waist pattern without hem or seam allowances at any point. It is cut in high round neck style to the base of the neck. Such a pattern can be used as a foundation in making various types of garments such as smocks and blouses, undergarments, chemise dresses, afternoon costumes, and even the most décolleté evening gown, as it is simply a matter of adjusting to the variations of the fashion to be copied.

The most exclusive establishments have block patterns in all of the standard sizes. One of the most successful importers of French

models revealed her secret by saying that she always carried her foundation linings which were made from the block patterns overseas to Paris, where the creations were built up on them. She had found many points of difference between the American and the French figure.

These block patterns are copied in the standard sizes on heavy paper which is stout enough to withstand much handling. If you have a plain well-fitting blouse it would serve as a pattern from which to copy your block pattern in heavy paper. You will find all the details for making a blouse pattern given further on in the course.

To use your blouse pattern as a block pattern in making an apron as shown in Fig. 57, draw a straight line as AB . Lay the waist pattern with the center front and the center back along this line, with the edges just touching at the shoulder. Draw a line at right angles to the line AB that will touch the point where the patterns meet at the shoulder and mark CD .

To determine the length of the kimono sleeve measure from the base of the neck along the top of the arm as in Fig. 58. Measure the same number of inches on the CD line, starting

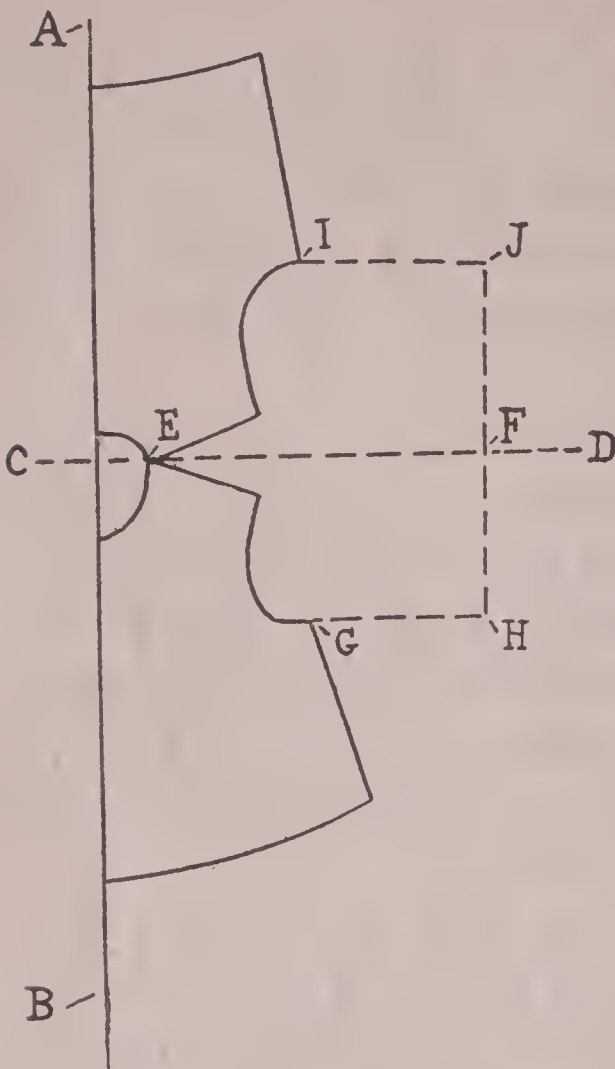

Fig. 57. Using a block waist pattern to draft a kimono-sleeved house dress

at the line *AB* and mark a point *F*. From this point draw lines at right angles and mark *J* and *H*. Draw lines at right angles from the end of the line *JH* that will touch the bottom of the armhole where the points are marked *G* and *I*. This gives you the outline of the kimono sleeve. (See Fig. 57.)

Determine how long you want the apron to be by measuring on the person for whom you are making it, starting at the base of the neck in front and carrying the measure down as far as necessary. Measure the same number of inches along the *AB* line, starting at the upper edge of the front of the waist pattern and mark point *B*. This will give

APRONS AND HOUSE DRESSES

you the length in front on the extended *AB* line. (See Fig. 59.)

To determine the width at the bottom draw a line at right angles to line *AB*, starting at point *B*. To find the end of the line divide the number of inches required for the bottom of the apron by four and measure this number of inches from point *B* and mark *K*. An apron of this type ought to measure sixty inches at the bottom for a woman with a thirty-six-inch bust measure. Add four inches to the width for each increase in size of the bust measure. If the skirt of this apron is to measure sixty inches, point *K* would be fifteen inches from point *B*. Draw a line from the underarm at point *G* to point *K*. Mark an inch

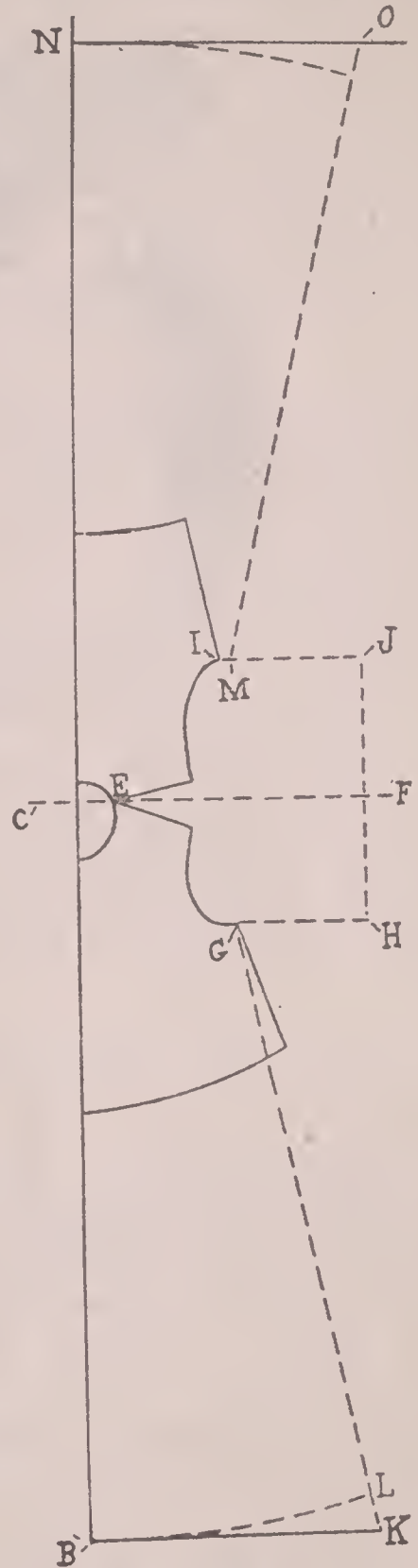

Fig. 59. Completing the house-dress pattern



Fig. 58. Measuring for the length of the sleeve

and a half above *K* a point with *L*. Curve the lower edge from *L* to about halfway between *B* and *K*. (See Fig. 59.)

Measure from the neck bone at the back to determine how long you want the apron at the center back. Measure the same number of inches on the *AB* line, starting from the upper edge of the back of the waist pattern

and extending the *AB* line as required and mark this point *N*.

Draw a line at right angles to line *AB*, starting at point *N*, which measures a quarter of the width of the lower edge of the apron and mark point *O*. (See Fig. 59.)

If the dress or apron is to be ironed flat, the front and back must be of the same width. Measure from point *H* to point *G* and measure the same number of inches on line *IJ*, starting from point *J* and mark a new point *M*. (See Fig. 59.) Draw a line from point *M* to point *O*. Measure from point *G* to point *L* and apply this measure on the line *MO*. From this point curve a line to the lower edge in the back midway between *O* and *N* as in Fig. 59.

Decide how low you want the neck in front and back and how wide, and draw dotted lines as 1, 2, 3, 4, in Fig. 60. To determine these measures it may be helpful if you refer to Fig. 41 and reread the paragraph on the subject under "Making a Slip-on Apron."

If a kimono sleeve is cut with an abrupt angle at the underarm it will rip out easily or tear the goods. Fill in the underarm in the pattern with a curve as shown by lines 5 and 6 in Fig. 60.

A COMPLETE COURSE IN DRESSMAKING

While a kimono sleeve is one of the easiest to make, there are little points to consider and observe which make it well fitting and grace-

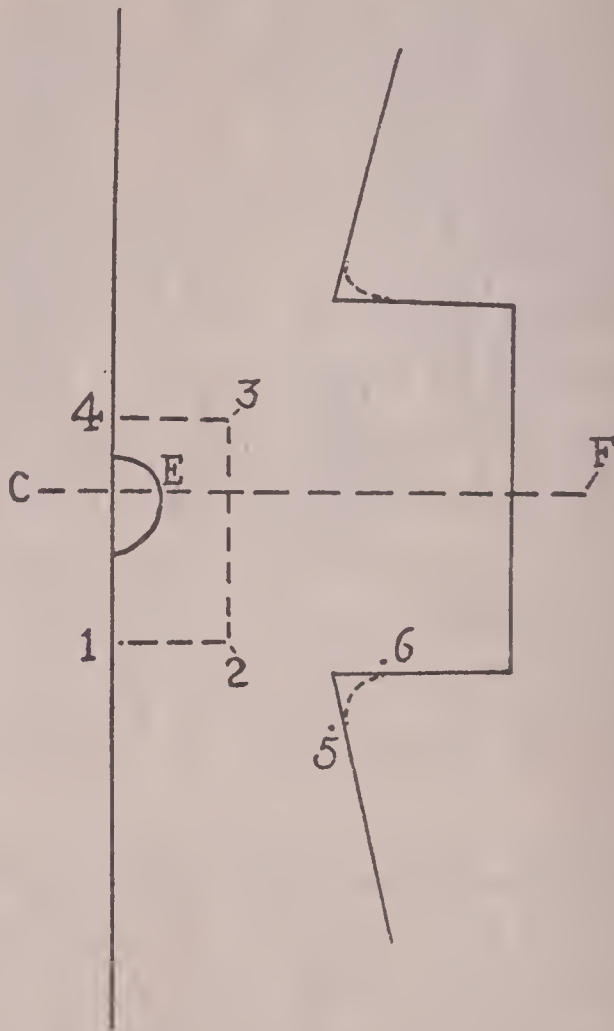

Fig. 60. Shaping the neck and underarm seams of the pattern

ful. This sleeve pattern just described makes a kimono sleeve which is cut straight out from the shoulder. The extra material at the top of the shoulder where the edges of the waist

APRONS AND HOUSE DRESSES



Fig. 61. When a kimono-sleeved pattern is made straight at the shoulder there is fullness which crushes in under the arm

pattern spread apart will crush down under the arm when the garment is on (see Fig. 61), and therefore is prettier when made of light-weight material rather than that which is bulky and thick. When the arm is put out



Fig. 62. The garment is smooth when the arm is straight out

straight the garment is smooth, which of course makes it very easy to iron and a comfortable garment to work in. (See Fig. 62.)

Giving the Kimono Sleeve a Better Fit.

—If you want a kimono sleeve which is some-

what fitted a seam can be made on the shoulder as in Fig. 63. For instance, after you have your foundation lines drawn in for the kimono sleeve shown in Fig. 57, mark points 1 and 2 an inch from point *F* on the outer edge of the sleeve as in Fig. 63. Draw lines from these points which will touch the neck edge of the waist at point *E*. Continue these lines beyond the outer edge of the sleeve. To give a good line to the bottom of the sleeve, the edge must be at

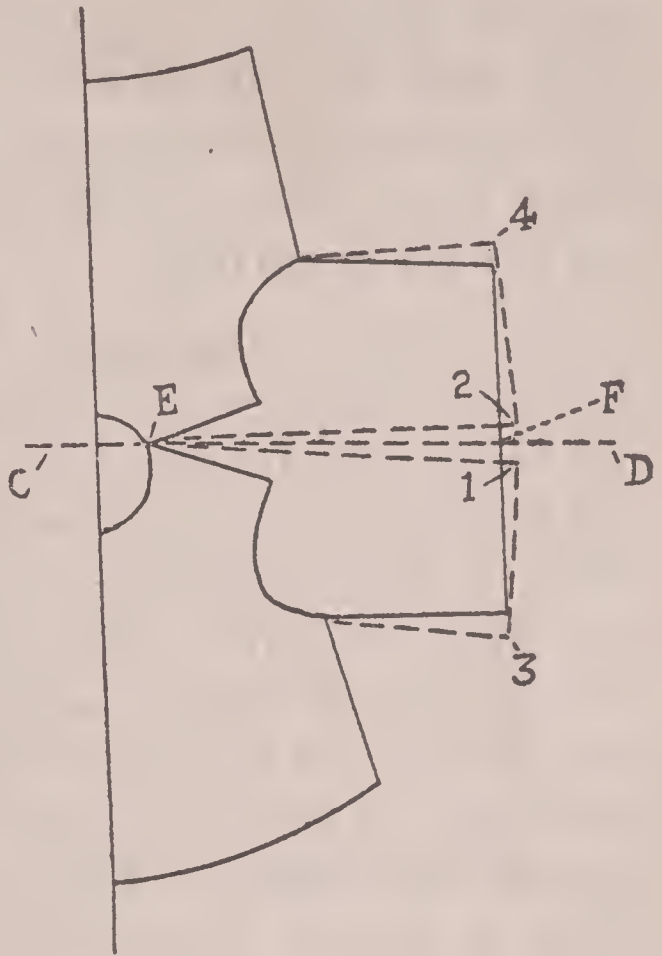

Fig. 63. Diagram for kimono-sleeved pattern having a seam on the shoulder

right angles to the shoulder seam. Therefore, draw a line at right angles to line 1-*E* which touches the lower corner of the sleeve. This gives you a new outline for the front of the sleeve. Reslope the outer edge of the back of

the sleeve in the same way. (See Fig. 63.) Draw the lower part of the dress or apron as described before. Lay the diagram of the front pattern on another piece of paper and make an allowance for all seams. Remove the paper and cut out the front pattern. Then, place another piece of paper under the diagram of the back pattern, allow for seams and cut out the back pattern.

One of the advantages of a seam on the shoulder of a kimono sleeve is that the back and front patterns need not be same measure, and this will be more becoming to the woman with the plump figure, as it will allow for more ease over the bust. This pattern is practical for all types of dresses and can be used as the foundation of an infinite variety of charming garments. Exactly the same principles can be applied in making children's clothes. *One point of caution is worthy of mention: if too much material is taken out of the sleeve at the top of the armhole the arm cannot be lifted easily, and when lifted will drag all the material up the side from the lower hem, which is most unattractive in appearance, and if it is of delicate texture will soon stretch out of shape.*

How to Make a Narrower Kimono Sleeve.—Place the waist pattern as described

APRONS AND HOUSE DRESSES

before on the *AB* line. Square the line at the center of the shoulder and also draw lines at right angles from line *AB* which will touch the lower edge of the armholes in front and back and mark 1, 2 and 3, 4. Square a line from the bottom of the armhole in front at point 2

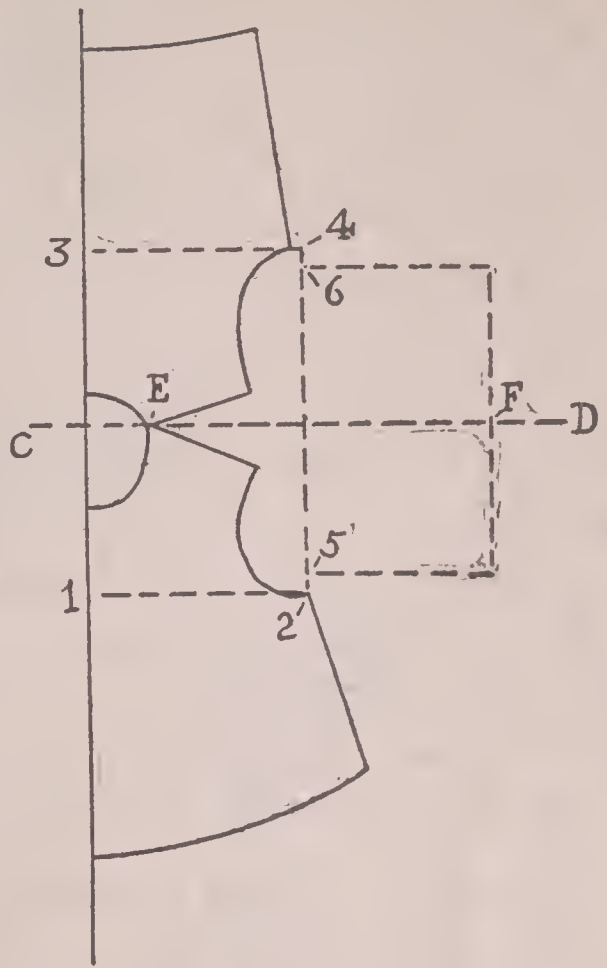

Fig. 64. It is possible to make the sleeve size of the pattern smaller.

to touch the line 3-4. Measure in from the outer edge on line 2-4 and mark points 5 and 6. Mark the depth of the sleeve at point *F* and starting at *F* draw lines at right angles to *CD* line. From this new line which is the outer edge of the sleeve draw lines at right angles to line 2-4, which will touch points 5 and 6. (See Fig. 64.) From points 5 and 6 draw lines to the edge of the garment as already described. This gives a

smaller sleeve. After you have these foundation lines you can add the seam at the shoulder and take out some of the fullness at the top of the shoulder as in Fig. 63.

To thoroughly master the subject you should make at least four or five of each diagram. It is an excellent idea to continue making the diagrams until you can successfully accomplish one of every kind without referring to the lesson. Once you thoroughly understand the art of these diagrams, you will find that the keynote to many successes lies within them and that you can copy any kimono-sleeved garment applying these principles.

How to Make a Bungalow Apron.—To make this protecting and smart little overgarment shown in Fig. 65, cut according to the general directions given in earlier part of this lesson and finish with French or open seams as described in Lesson I. A bias facing makes a pretty finish at the neck edge, so refer to bias facings under that heading in the first part of this lesson. This gives an opportunity to use the newly popular checked gingham or striped goods which have such a smart effect. The facing also decorates the pocket, makes the belt and edges the sleeves.

When you want to miter a corner which is

APRONS AND HOUSE DRESSES



Fig. 65. A kimono-sleeved house dress is easy to slip on and easy to iron

necessary in all square necks and other square openings or right-angle turns, study Fig. 66. This mitering is done by folding out a dart and basting it at the corner. When the facing is turned on the right side it appears as in

Fig. 67. Where the facing joins in the back make a bias seam as in Fig. 68.

Finish the lower edge of the skirt as the lower edge of the waistline apron was hemmed. The sash would be finished with a narrow hem

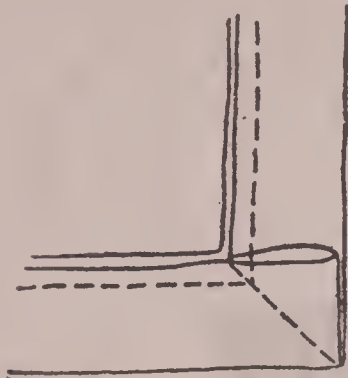

Fig. 66

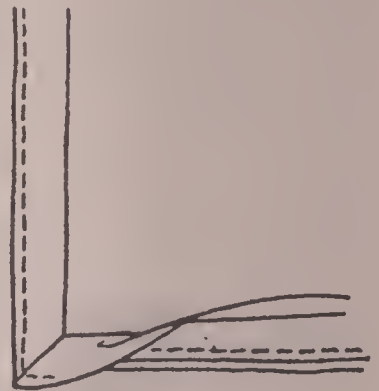

Fig. 67



Fig. 68

and the ends hemmed or faced with the decorative bias facing.

Using a Commercial Pattern.—It is important that you have a clear idea what you are going to make, before you start cutting or sewing. Read carefully the directions printed on the pattern envelope. Examine the pattern itself. Know what each piece is and why the perforations and notches are there before cutting.

APRONS AND HOUSE DRESSES

If the pattern is one you intend using over and over, it will pay you to duplicate it in stiff paper. Wrapping paper will do. Iron out all the wrinkles in the tissue paper pattern, using an iron that is warm, not hot. Then lay each piece of the tissue paper pattern on the wrapping paper. Weigh down the pieces with paper weights and trace around the edges with a tracing wheel, being very careful to follow exactly the outline of the tissue paper pattern.

After tracing around each pattern piece, remove the tissue paper pattern. Mark over the traced lines with a pencil, as a pencil line is much easier to follow in cutting than a traced line. Where the edge is a straight line, lay a ruler and draw the line with a pencil. In penciling over the curved edges, use your curved ruler and the traced lines as a guide. Use sharp shears to cut the new pattern. Cut just inside the marks; that is, cut the marks off. You will remember that the marks were placed just beyond the edge of the tissue paper pattern, and you want the new pattern to be the exact size of the old. A stiff paper pattern of this description is much easier to handle than a flimsy tissue paper one.

HOW TO STUDY

Again I want to remind you how to study, which is so important for you to gain the full benefit of these lessons. Read one subject at a time. Read it over carefully at least once more, perhaps several times. Then lay aside the book and review the subject in your mind to see if you understand it clearly. If there is anything which seems vague or puzzles you, look up that point and again review the subject without the book.

TEST QUESTIONS

Here are some test questions to enable you to see what progress you are making in your study. Go over them carefully and write out the answers to each one and then compare your written answers with the book to see if they are correct.

How much seam allowance do you plan when an edge is to be bound?

Is it necessary to finish an edge before putting on rickrack braid?

How do you make a waistline apron hang smoothly?

How do you allow for a piecing in laying the pattern on the goods?

How do you cut a pretty neckline?

How do you make a pocket stand away from the material?

What is the foundation of a block pattern?

How do you make a kimono sleeve smaller?

How do you find the length of an apron or dress in the front and back?

How do you know what width to allow for the bottom of skirt or apron?

All the detailed information in this Lesson II can be used over and over again in making garments of all kinds. The directions for edges and mitered corners, for the making of pockets, waistbands and strings, for finding the individual lengths of aprons and dresses and depths of the neckline in front and back, the sloping of the top of the aprons and hems, with the block patterns and kimono sleeves, are used in some way in almost every garment. And now that the secrets of the foundation pattern and use of blocks patterns are revealed to you and the main points of finishing edges, necks and hems, you are ready to see garments with a larger vision and a more understanding eye, so that articles which have seemed intricate and far beyond your skill in the shops and magazines will wear a very different air when you know how to copy them.

A COMPLETE COURSE IN DRESSMAKING

The following book, Lesson III, will be on the fascinating subject of undergarments, and you will readily see, as you study this lesson, how much of Lesson II applies on the new one. You will find that you can easily make your nightdresses and chemises from your block pattern, and the finishing edges will be used many times in making these dainty and individual garments.

LIBRARY OF CONGRESS



0 014 063 927 8

