



503861





75  
1.5m

Fig. 2.

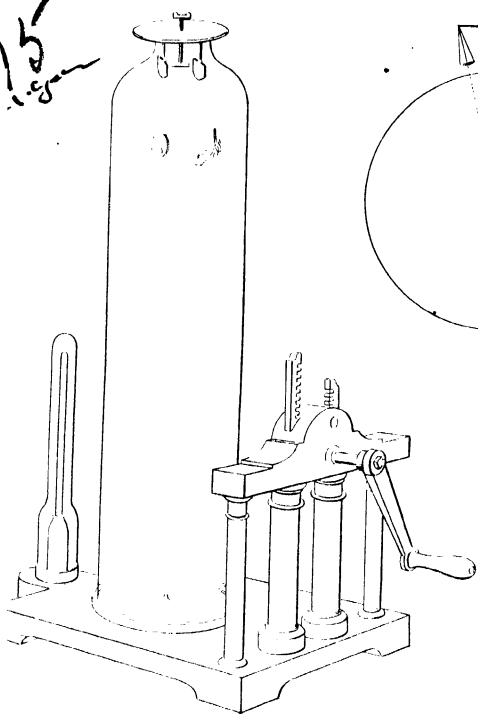


Fig. 1.

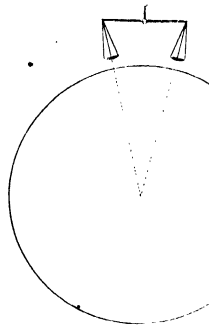


Fig. 3.

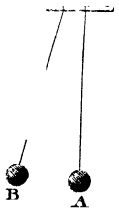


Fig. 4.

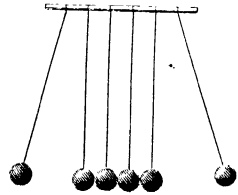
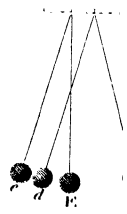


Fig. 5.



CONVERSATIONS  
ON  
NATURAL PHILOSOPHY

IN WHICH  
*The Elements of that Science*

ARE  
FAMILIARLY EXPLAINED,  
AND ADAPTED TO THE COMPREHENSION OF  
YOUNG PERSONS.

BY MRS. MARCET,  
AUTHOR OF CONVERSATIONS ON POLITICAL ECONOMY, ON CHEMISTRY,  
VEGETABLE PHYSIOLOGY, AND LAND AND WATER.

ILLUSTRATED WITH PLATES.

TWELFTH EDITION.

LONDON:  
LONGMAN, BROWN, GREEN, AND LONGMANS.  
1851.

LONDON:  
SPOTTISWOODES and SHAW,  
New-street-Square.

## P R E F A C E.

It was with great diffidence that the author, many years ago, first offered this little work to the public. The encouraging reception which the Conversations on Chemistry, and on Political Economy, had met with, induced her to venture on publishing a short course on Natural Philosophy; but not without considerable apprehensions for its success. Her ignorance of mathematics, and the imperfect knowledge of natural philosophy which that disadvantage necessarily implies, rendered her fully sensible of her incompetency to treat the subject in any other way than in the form of a familiar explanation of the first elements, for the use of very young pupils. It was the hope of having done this in a manner that might engage



their attention, which encouraged her to offer them these additional lessons ; and the success they have since met with has been her best reward.

They are intended, in the course of elementary science, to precede the Conversations on Chemistry ; and were in fact written previously to either of her former publications. Each succeeding edition has been carefully revised, and new discoveries introduced, by the author.

# CONTENTS.

## CONVERSATION I.

### ON GENERAL PROPERTIES OF BODIES.

	Page
INTRODUCTION.—General Properties of Bodies.—Im-	
penetrability.—Extension.—Figure.—Divisibility.—	
Inertia.—Attraction.—Attraction of Cohesion.—	
Density.—Rarity.—Heat.—Attraction of Gravita-	
tion - - - - -	1

## CONVERSATION II.

### ON THE ATTRACTION OF GRAVITY.

Attraction of Gravitation, continued.—Of Weight.—	
Of the Fall of Bodies.—Of the Resistance of the Air.	
—Of the Ascent of Light Bodies - - - - -	30

## CONVERSATION III.

### ON THE LAWS OF MOTION.

Of Motion.—Of the Inertia of Bodies.—Of Force to	
produce Motion.—Direction of Motion.—Velocity,	
absolute and relative.—Uniform Motion.—Retarded	

	Page
Motion.—Accelerated Motion.—Velocity of Falling Bodies.—Momentum.—Action and Re-action equal.—Elasticity of Bodies.—Porosity of Bodies.—Reflected Motion.—Angles of Incidence and Reflection	53

## CONVERSATION IV.

### ON COMPOUND MOTION.

Compound Motion, the Result of two opposite Forces.—Of Circular Motion, the Result of two Forces, one of which confines the Body to a fixed Point.—Centre of Motion, the Point at rest while the other Parts of the Body move round it.—Centre of Magnitude, the Middle 'of a Body.—Centripetal Force, that which confines a Body to a fixed central Point.—Centrifugal Force, that which impels a Body to fly from the Centre.—Fall of Bodies in a Parabola.—Centre of Gravity, the Centre of Weight, or Point about which the Parts balance each other	- - 84
--	--------

## CONVERSATION V.

### ON THE MECHANICAL POWERS.

Of the Power of Machines.—Of the Lever in general.—Of the Lever of the first Kind, having the Fulcrum between the Power and the Weight.—Of the Lever of the second Kind, having the Weight between the Power and the Fulcrum.—Of the Lever of the third Kind, having the Power between the Fulcrum and the Weight	- - - - 106
---	-------------

## CONVERSATION VI.

## ON THE MECHANICAL POWERS.

	Page
Of the Pulley.—Of the Wheel and Axle.—Of the Inclined Plane.—Of the Wedge.—Of the Screw	- 126

*Astronomy.*

## CONVERSATION VII.

## CAUSES OF THE EARTH'S ANNUAL MOTION.

Of the Planets, and their Motion.—Of the Diurnal Motion of the Earth and Planets	- 147
--	-------

## CONVERSATION VIII.

## ON THE PLANETS.

Of the Satellites or Moons.—Gravity diminishes as the Square of the Distance increases.—Of the Solar System.—Of Comets.—Of double Stars.—Constellations, Signs of the Zodiac.—Copernicus, Newton, &c.	- 168
---	-------

## CONVERSATION IX.

## ON THE EARTH.

Of the Terrestrial Globe.—Of the Figure of the Earth.—Of the Pendulum.—Of the Variation of the Seasons, and of the Length of Days and Nights.—Of the Causes of the Heat of Summer.—Of Solar, Sidereal, and Equal or Mean Time	- 204
---	-------

	Page
Motion.—Accelerated Motion.—Velocity of Falling Bodies.—Momentum.—Action and Re-action equal.—Elasticity of Bodies.—Porosity of Bodies.—Reflected Motion.—Angles of Incidence and Reflection	53

## CONVERSATION IV.

### ON COMPOUND MOTION.

Compound Motion, the Result of two opposite Forces.—Of Circular Motion, the Result of two Forces, one of which confines the Body to a fixed Point.—Centre of Motion, the Point at rest while the other Parts of the Body move round it.—Centre of Magnitude, the Middle of a Body.—Centripetal Force, that which confines a Body to a fixed central Point.—Centrifugal Force, that which impels a Body to fly from the Centre.—Fall of Bodies in a Parabola.—Centre of Gravity, the Centre of Weight, or Point about which the Parts balance each other	- - 84
---	--------

## CONVERSATION V.

### ON THE MECHANICAL POWERS.

Of the Power of Machines.—Of the Lever in general.—Of the Lever of the first Kind, having the Fulcrum between the Power and the Weight.—Of the Lever of the second Kind, having the Weight between the Power and the Fulcrum.—Of the Lever of the third Kind, having the Power between the Fulcrum and the Weight	- - - - 106
---	-------------

## CONVERSATION VI.

## ON THE MECHANICAL POWERS.

	Page
Of the Pulley.—Of the Wheel and Axle.—Of the Inclined Plane.—Of the Wedge.—Of the Screw	- 126

*Astronomy.*

## CONVERSATION VII.

## CAUSES OF THE EARTH'S ANNUAL MOTION.

Of the Planets, and their Motion.—Of the Diurnal Motion of the Earth and Planets	- 147
---	-------

## CONVERSATION VIII.

## ON THE PLANETS.

Of the Satellites or Moons.—Gravity diminishes as the Square of the Distance increases.—Of the Solar Sys- tem.—Of Comets.—Of double Stars.—Constellations, Signs of the Zodiac.—Copernicus, Newton, &c.	- 168
--	-------

## CONVERSATION IX.

## ON THE EARTH.

Of the Terrestrial Globe.—Of the Figure of the Earth. —Of the Pendulum.—Of the Variation of the Sea- sons, and of the Length of Days and Nights.—Of the Causes of the Heat of Summer.—Of Solar, Sidereal, and Equal or Mean Time	- 204
--	-------

## CONVERSATION X.

## ON THE MOON.

	Page
Of the Moon's Motion.—Phases of the Moon.—Eclipses of the Moon.—Eclipses of Jupiter's Moons.—Of the Latitude and Longitude.—Of the Transits of the Inferior Planets.—Of the Tides - - -	243

*Hydrostatics.*

## CONVERSATION XI.

## ON THE MECHANICAL PROPERTIES OF FLUIDS.

Definition of a Fluid.—Distinction between Fluids and Liquids.—Of Non-elastic Fluids, scarcely susceptible of Compression.—Of the Cohesion of Fluids.—Of their Gravitation.—Of their Equilibrium.—Of their Pressure.—Of Specific Gravity.—Of the Specific Gravity of Bodies heavier than Water.—Of those of the same Weight as Water.—Of those Lighter than Water.—Of the Specific Gravity of Fluids -	263
--	-----

## CONVERSATION XII.

## ON SPRINGS, FOUNTAINS, ETC.

Of the Ascent of Vapour and the Formation of Clouds.—Of the Formation and Fall of Rain, &c.—Of the Formation of Springs.—Of Rivers and Lakes.—Of Artesian Wells.—Of Fountains - - -	286
---	-----

*Pneumatics.*

## CONVERSATION XIII.

## ON THE MECHANICAL PROPERTIES OF AIR.

	Page
Of the Spring or Elasticity of the Air.—Of the Weight of the Air.—Experiments with the Air Pump.—Of the Barometer.—Mode of weighing Air.—Specific Gravity of Air.—Of Pumps.—Description of the Sucking Pump.—Description of the Forcing Pump	308

## CONVERSATION XIV.

## ON WIND AND SOUND.

Of Wind in general.—Of the Trade Wind.—Of the Periodical Trade Winds.—Of the Aërial Tides.—Of Sound in general.—Of Sonorous Bodies.—Of Musical Sounds.—Of Concord or Harmony, and Melody	329
--	-----

*Optics.*

## CONVERSATION XV.

## ON OPTICS.

Of Luminous, Transparent, and Opaque Bodies.—Of the Radiation of Light.—Of the Nature of Light.—Of Shadows.—Of the Reflection of Light.—Opaque Bodies seen only by reflected Light.—Vision explained.—Camera Obscura.—Image of Objects on the Retina.—Of the Perception to which it gives rise in the Mind	- - - - - 351
--	---------------



CONVERSATION XVI.

ON THE VISUAL ANGLE, AND THE REFLECTION OF  
MIRRORS.

	Page
Angle of Vision. — Reflection of Plain Mirrors. — Reflection of Convex Mirrors. — Reflection of Concave Mirrors	- 386

CONVERSATION XVII.

ON REFRACTION AND COLOURS.

Transmission of Light by Transparent Bodies. — Refraction. — Refraction of the Atmosphere. — Refraction of a Lens. — Refraction of the Prism. — Of the Colours of Rays of Light. — Of the Colours of Bodies. — Double Refraction and Polarization	- 415
---	-------

CONVERSATION XVIII.

ON THE STRUCTURE OF THE EYE, AND OPTICAL  
INSTRUMENTS.

Description of the Eye. — Of the Image on the Retina. — Refraction of the Humours of the Eye. — Of the Use of Spectacles. — Of the Single Microscope. — Of the Double Microscope. — Of the Solar Microscope. — Magic Lantern. — Refracting Telescope. — Reflecting Telescope	- 458
--	-------

**DIRECTIONS**  
**FOR**  
**PLACING THE ENGRAVINGS.**

Plate	I.	to face page	39
	II.	- -	81
	III.	- -	90
	IV.	- -	108
	V.	- -	126
	VI.	- -	149
	VII.	- -	172
	VIII.	- -	193
	IX.	- -	208
	X.	- -	230
	XI.	- -	239
	XII.	- -	247
	XIII.	- -	268
	XIV.	- -	297
	XV.	- -	353
	XVI.	- -	376
	XVII.	- -	387
	XVIII.	- -	403
	XIX.	- -	417
	XX.	- -	427
	XXI.	- -	459
	XXII.	- -	466
	XXIII.	- -	472



## CONVERSATION I.

### ON GENERAL PROPERTIES OF BODIES.

INTRODUCTION. — GENERAL PROPERTIES OF BODIES.  
IMPENETRABILITY. — EXTENSION. — FIGURE. — DIVI-  
SIBILITY. — INERTIA. — ATTRACTION. — ATTRACTION  
OF COHESION. — DENSITY. — RARITY. — HEAT. — AT-  
TRACTION OF GRAVITATION.

EMILY.

I MUST request your assistance, my dear Mrs. B., in a charge which I have lately undertaken: it is that of instructing my younger sister; a task which I find proves more difficult than I had at first imagined. I can teach her the common routine of children's lessons tolerably well; but she is such an inquisitive little creature, that she is not satisfied without an explanation of every difficulty that occurs to her, and frequently asks me questions which I am at a loss to answer. This morning, for instance, when I had explained to her that the world

was round like a ball, instead of being flat, as she had supposed, and that it was surrounded by the air, she asked me what supported it. I told her that it required no support; she then enquired why it did not fall as every thing else did. This, I confess, perplexed me; for I had myself been satisfied with learning that the world floated in the air, without considering how unnatural it was that so heavy a body, bearing the weight of so many things on its surface, should support itself.

MRS. B.

I make no doubt, my dear, but that I shall be able to explain this difficulty to you; but I believe that it would be almost impossible to render it intelligible to the comprehension of so young a child as your sister Sophia. You, who are now in your thirteenth year, may, I think, with great propriety, learn not only the cause of this particular fact, but acquire a general knowledge of the laws by which the natural world is governed.

EMILY.

Of all things, it is what I should most like to learn; but I was afraid it was too difficult a study, even at my age.

MRS. B.

Not when familiarly explained: if you have patience to attend, I will most willingly give you all the information in my power. You may, per-

haps, find the subject rather dry at first; but if I succeed in explaining the laws of nature, so as to make you understand them, I am sure it will give you not only instruction but amusement.

EMILY.

I make no doubt of it, Mrs. B.; and pray begin by explaining why the earth requires no support; for that is the point which just now most strongly excites my curiosity.

MRS. B.

My dear Emily, if I am to attempt to give you a general idea of the laws of nature, which is no less than to introduce you to a knowledge of the science of natural philosophy, it will be necessary for us to proceed with some degree of regularity. I do not wish to confine you to the systematic order of a scientific treatise: but if we were merely to examine every vague question that may chance to occur, our progress would be but very slow. Let us, therefore, begin by taking a short survey of the general properties of bodies, some of which must necessarily be explained before I can attempt to make you understand why the earth requires no support.

When I speak of *bodies*, I mean substances, of whatever nature, whether solid or fluid; and *matter* is the general term used to denote the substance of which the different bodies are composed. Thus

wood is the matter of which this table is made ; water is the matter with which this glass is filled, &c.

EMILY.

I am very glad you have explained the meaning of the word matter, as it has corrected an erroneous conception I had formed of it: I thought that it was applicable to solid bodies only.

MRS. B.

There are certain properties which appear to be common to all bodies, and are hence called the *essential properties* of bodies; these are *Impenetrability, Extension, Figure, Divisibility, Inertia, and Attraction*. These are called the *general properties* of bodies, as we do not suppose any body to exist without them.

By impenetrability, is meant the property which bodies have of occupying a certain space, so that, where one body is, another cannot be, without displacing the former; for two bodies cannot exist in the same place at the same time. A liquid may be more easily removed than a solid body; yet it is not the less substantial, since it is as impossible for a liquid and a solid to occupy the same space at the same time, as for two solid bodies to do so. For instance, if you put a spoon into a glass full of water, the water will flow over to make room for the spoon.

EMILY.

I understand this perfectly. Liquids are in reality as substantial or as impenetrable as solid bodies ; and they appear less so, only because they are more easily displaced.

MRS. B.

Air is a fluid differing in its nature from liquids, but no less impenetrable. If I endeavour to fill this phial by plunging it into this basin of water, the air, you see, rushes out of the phial in bubbles, in order to make way for the water ; for air and water cannot exist together in the same space, any more than two hard bodies ; and if I reverse this goblet, and plunge it perpendicularly into the water, so that the air will not be able to escape, the water will no longer fill the goblet.

EMILY.

But it rises a considerable way into it.

MRS. B.

Because the water compresses or squeezes the air into a small space in the upper part of the goblet ; but, as long as the air remains there, no other body can occupy the same place.

EMILY.

A difficulty has just occurred to me, with regard to the impenetrability of solid bodies ; if a nail be



driven into a piece of wood, it penetrates the wood, and both the wood and the nail occupy the same space that the wood alone did before.

MRS. B.

The nail penetrates between the particles of the wood, by forcing them to make way for it; for you know that not a single atom of wood can remain in the space which the nail occupies; and if the wood is not increased in size by the addition of the nail, it is because wood is a porous substance, like sponge, the particles of which may be compressed or squeezed closer together; and it is thus that they make way for the nail.

We may now proceed to the next general property of bodies, *extension*. A body which occupies a certain space must necessarily have extension; that is to say, *length*, *breadth*, and *depth*; these are called the dimensions of extension; can you form an idea of any body without them?

EMILY.

No; certainly I cannot; though these dimensions must, of course, vary extremely in different bodies. The length, breadth, and depth of a box, or of a thimble, are very different from those of a walking-stick, or of a hair.

But is not height also a dimension of extension?

MRS. B.

Height and depth are the same dimension, considered in different points of view: if you measure a body, or a space, from the top to the bottom, you call it depth; if from the bottom upwards, you call it height: thus the depth and height of a box are, in fact, the same thing.

EMILY.

Very true; a moment's consideration would have enabled me to discover that; and breadth and width are also the same dimension.

MRS. B.

Yes. The limits of extension constitute *figure* or shape. You conceive that a body having length, breadth, and depth, cannot be without form, either symmetrical or irregular?

Undoubtedly; and figure admits of an almost infinite variety.

MRS. B.

Nature has assigned regular forms to her productions in general. The natural form of mineral substances is that of crystals, of which there is a great variety. Many of them are very beautiful, and no less remarkable by their transparency or colour, than by the perfect regularity of their

forms, as may be seen in the various museums and collections of natural history. The vegetable and animal creations appear less symmetrical, but are still more diversified in figure than the mineral kingdom. Manufactured substances assume the various arbitrary forms which the art of man designs for them; and an infinite number of irregular figures are produced by fractures, and by the dismemberment of the parts of bodies.

EMILY.

Such as a piece of broken china, or glass.

MRS. B.

Or the fragments of mineral bodies, which are broken in being dug out of the earth, or decayed by the effect of torrents and other causes. The picturesque effect of rock scenery is in a great measure owing to accidental irregularities of this kind.

We may now proceed to *divisibility*; that is to say, a susceptibility of being divided into an indefinite number of parts. Take any small quantity of matter, a grain of sand, for instance, and cut it into two parts; these two parts might be again divided, had we instruments sufficiently fine for the purpose; and if, by means of pounding, grinding, and other similar methods, we carry this division to the greatest possible extent, and reduce the body to its finest imaginable particles, yet not one of the

particles will be destroyed, and the body will continue to exist, though in this altered state.

EMILY.

I have heard that a single pound of wool may be spun so fine as to extend to nearly 100 miles in length; this appears to me a very remarkable instance of the powers of divisibility.

MRS. B.

It is, certainly. The melting of a solid body in a liquid also affords a very striking example of the extreme divisibility of matter; when you sweeten a cup of tea, for instance, with what minuteness the sugar must be divided to be diffused throughout the whole of the liquid.

EMILY.

And if you pour a few drops of red wine into a glass of water, they immediately tinge the whole of the water, and must, therefore, be diffused throughout it.

MRS. B.

Exactly so; and the perfume of this lavender-water will be almost as instantaneously diffused throughout the room, if I take out the stopper.

EMILY.

But in this case it is only the perfume of the lavender, and not the water itself, that is diffused in the room.

MRS. B.

The odour or smell of a body is part of the body itself, and is produced by very minute particles or exhalations which escape from odoriferous bodies. It would be impossible that you should smell the lavender-water, if particles of it did not come in actual contact with your nose.

EMILY.

But when I smell a flower, I see no vapour rise from it; and yet I can perceive the smell at a considerable distance.

MRS. B.

You could, I assure you, no more smell a flower, the odoriferous particles of which did not touch the nose, than you could taste a fruit, the flavoured particles of which did not come in contact with the tongue.

EMILY.

That is wonderful indeed; the particles, then, which exhale from the flower, and from the lavender-water, are, I suppose, too small to be visible?

MRS. B.

Certainly: you may form some idea of their extreme minuteness, from the immense number which must have escaped in order to perfume the whole room; and yet there is no sensible diminution of the liquid in the phial.

EMILY.

But the quantity must really be diminished?

MRS. B.

Undoubtedly; and were you to leave the bottle open a sufficient length of time, the whole of the liquid would evaporate and disappear. But though so minutely subdivided as to be imperceptible to any of our senses, each particle would continue to exist; for it is not within the power of man to destroy a single particle of matter; nor is there any reason to suppose that in nature an atom is ever annihilated.

EMILY.

Yet, when a body is burnt to ashes, part of it, at least, appears to be effectually destroyed. Look how small is the residue of ashes beneath the grate, in comparison of the coals that have been consumed within it.

MRS. B.

That part of the coals which you would suppose to be destroyed evaporates in the form of smoke and vapour, whilst the remainder is reduced to ashes. A body, in burning, undergoes, no doubt, very remarkable changes: it is generally subdivided; its form and colour altered; its extension increased; but the various parts, into which it has been separated by combustion, continue in existence, and retain all the essential properties of bodies.

EMILY.

But that part of a burnt body which evaporates in smoke has no figure. Smoke, it is true, ascends in columns into the air, but it is soon so much diffused as to lose all form; it becomes, indeed, invisible.

MRS. B.

Invisible, I allow; but we must not imagine that what we no longer see no longer exists. Were every particle of matter that becomes invisible annihilated, the world itself would, in the course of time, be destroyed. The particles of smoke, when diffused in the air, continue still to be particles of matter, as well as when more closely united in the form of coals: they are really as substantial in the one state as in the other, and equally so when, by their extreme subdivision, they become invisible. No particle of matter is ever destroyed; this is a principle you must constantly remember. Every thing in nature decays and corrupts in the lapse of time. We die, and our bodies moulder to dust: but not a single atom of them is lost; they serve to nourish the earth, whence, while living, they drew their support.

Observe, that when you divide a body, its surface or exterior part is augmented. I cut this apple in two, and you see that in addition to the round surface, there are now two flat surfaces: divide the halves of the apple into quarters, and two more surfaces will be produced.

EMILY.

But each of these new ones is not so large as the original surface?

MRS. B.

No doubt; the surface of a body is never double'  $l_j$  one division, though it is always increased by it.

EMILY.

But if you split something flat in two, are not the surfaces doubled? Look, Mrs. B., when I open this portfolio, it is just twice as large as it was before.

MRS. B.

No; for it is not more than half as thick as when closed, and thickness is one of the dimensions of a body.

*Inertia*, the next essential property of bodies, is one which implies something more than mere passiveness, and expresses the resistance which inactive matter makes to a change of state. Bodies appear to be not only incapable of changing their actual state, whether it be of motion or of rest, but to be endowed with a *power of resisting* such a change. You know that it requires force to put a body which is at rest in motion; an exertion of strength is also requisite to stop a body which is already in motion. The resistance of the body



## 14      GENERAL PROPERTIES OF BODIES.

to a change of state, in either case, is called its *inertia*.

EMILY.

In playing at base-ball, I am obliged to use all my strength to give a rapid motion to the ball; and when I have to catch it, I am sure I feel the resistance it makes to being stopped. But if I did not catch it, it would soon fall to the ground, and stop of itself.

MRS. B.

Inert matter is as incapable of stopping, as it is of putting itself into motion. When the ball ceases to move, therefore, it must be stopped by some other cause or power; but as it is one with which you are yet unacquainted, we cannot at present investigate its effects.

EMILY.

Yet, Mrs. B., do we not see every thing stop of its own accord after a certain time?

MRS. B.

A little patience, and you will understand, that it is not of itself that a body stops, but something out of itself which stops a body in motion.

The last property which appears to be common to all bodies is *attraction*; under which general name may be included all the properties by which one mass of matter acts on another, so as to make

the latter approach or continue near the former. Bodies consist of infinitely small particles of matter, each of which possesses the power of attracting, or drawing towards it, and uniting with any other particle sufficiently near to be within the influence of its attraction. This power cannot be recognised in minute particles, except when they are in contact, or at least appear to be so; it then makes them stick or adhere together, and is hence called the *attraction of cohesion*. Without this power, solid bodies would fall in pieces, or rather crumble to atoms.

EMILY.

I am so much accustomed to see bodies firm and solid, that it never occurred to me that any power was requisite to unite the particles of which they are composed. But the attraction of cohesion does not, I suppose, exist in liquids; for the particles of liquids do not remain together so as to form a body, unless confined in a vessel?

MRS. B.

Their cohesion is too slight to enable them to keep together, when not confined in a vessel; yet it will do so for a short time; look, it is the attraction of cohesion which holds this drop of water suspended at the end of my finger, and keeps the minute watery particles of which it is composed united.

to a change of state, in either case, is called its *inertia*.

EMILY.

In playing at base-ball, I am obliged to use all my strength to give a rapid motion to the ball; and when I have to catch it, I am sure I feel the resistance it makes to being stopped. But if I did not catch it, it would soon fall to the ground, and stop of itself.

MRS. B.

Inert matter is as incapable of stopping, as it is of putting itself into motion. When the ball ceases to move, therefore, it must be stopped by some other cause or power; but as it is one with which you are yet unacquainted, we cannot at present investigate its effects.

EMILY.

Yet, Mrs. B., do we not see every thing stop of its own accord after a certain time?

MRS. B.

A little patience, and you will understand, that it is not of itself that a body stops, but something out of itself which stops a body in motion.

The last property which appears to be common to all bodies is *attraction*; under which general name may be included all the properties by which one mass of matter acts on another, so as to make

the latter approach or continue near the former. Bodies consist of infinitely small particles of matter, each of which possesses the power of attracting, or drawing towards it, and uniting with any other particle sufficiently near to be within the influence of its attraction. This power cannot be recognised in minute particles, except when they are in contact, or at least appear to be so; it then makes them stick or adhere together, and is hence called the *attraction of cohesion*. Without this power, solid bodies would fall in pieces, or rather crumble to atoms.

EMILY.

I am so much accustomed to see bodies firm and solid, that it never occurred to me that any power was requisite to unite the particles of which they are composed. But the attraction of cohesion does not, I suppose, exist in liquids; for the particles of liquids do not remain together so as to form a body, unless confined in a vessel?

MRS. B.

Their cohesion is too slight to enable them to keep together, when not confined in a vessel; yet it will do so for a short time; look, it is the attraction of cohesion which holds this drop of water suspended at the end of my finger, and keeps the minute watery particles of which it is composed united.

EMILY.

But, Mrs. B., since you say that inert matter is incapable either of moving or stopping of itself, the slightest cohesive attraction would be sufficient to keep the particles of water together, if nothing prevented it.

MRS. B.

Very well observed, Emily: there must therefore be something which prevents it, and what that is we shall presently see. As the power of attraction is stronger in proportion as the particles of bodies are more closely united, the cohesive attraction of solid bodies is much greater than that of fluids.

The thinner and lighter a fluid is, the less is the cohesive attraction of its particles, because they are further apart; indeed in elastic fluids, such as air, not only is there no cohesive attraction among the particles, but they actually have a tendency to repel each other.

EMILY.

It is fortunate the particles of air do not cohere, for it would be impossible to breathe air in a solid mass, or even in a liquid state. But, Mrs. B., you say the particles of air repel each other; if that be the case, I wonder we have any air to breathe: I should have thought it would have disappeared of itself in empty space.

MRS. B.

And so it would, were it not for the attraction of the earth which forces it to remain near it. But more of this hereafter, when we treat of the mechanical properties of air.

EMILY.

It is, I suppose, owing to the different degrees of attraction of different substances, that they are hard or soft; and that liquids are thick or thin?

MRS. B.

Yes; and this corresponds with what is called *density*; a term by which your meaning would be better expressed, as it denotes the degree of closeness and compactness of the particles of a body; thus you may say, both of solids and of liquids, that the stronger the cohesive attraction, the greater is the density of the body. In philosophical language, however, density is said to be that property of bodies by which they contain a certain quantity of matter, under a certain bulk or magnitude. *Rarity*, though opposed to density, as it denotes the thinness and subtlety of bodies, will admit of the same definition; for it implies merely a diminution of density: thus you would say that mercury or quicksilver was a very dense fluid; ether a very rare one, &c.

EMILY.

And water or milk, fluids of moderate density. But how are we to judge of the quantity of matter contained in a certain bulk?

MRS. B.

By the weight: under the same bulk bodies are said to be dense in proportion as they are heavy.

EMILY.

Then we may say that metals are dense bodies, wood comparatively a rare one, &c. But, Mrs. B., when the particles of a body are so near as to attract each other, the effect of this power must increase as they are brought by it closer together; so that one would suppose that the body would gradually augment in density, till it was impossible for its particles to be more closely united. Now, we know that this is not the case; for soft bodies, such as cork, sponge, or butter, never become, in consequence of the increasing attraction of their particles, as hard as iron.

MRS. B.

In such bodies as cork and sponge, the particles which come in contact are so few as to produce but a slight degree of cohesion: they are porous bodies, which, owing to the peculiar arrangement of their particles, abound with interstices which separate

the particles; and these are filled with air, the spring or elasticity of which prevents the closer union of the parts. But there is another fluid much more subtle than air, which pervades all bodies; this is *heat*. Heat insinuates itself more or less between the particles of bodies, and forces them asunder; you may therefore consider heat, and the attraction of cohesion, as constantly acting in opposition to each other.

EMILY.

The one endeavouring to rend a body to pieces, the other to keep its parts firmly united.

MRS. B.

And it is this struggle between the contending forces of heat and attraction, which prevents the extreme degree of density which would result from the sole influence of the attraction of cohesion.

EMILY.

The more a body is heated, then, the more its particles will be separated.

MRS. B.

Certainly. We find that bodies generally swell or dilate by heat: this effect is very sensible in butter, for instance, which expands by the application of heat, till at length the attraction of cohesion



is so far diminished that the particles separate, and the butter becomes liquid. A similar effect is produced by heat on metals, and on all bodies susceptible of being melted. Liquids, you know, are made to boil by the application of heat; the attraction of cohesion, then, yields entirely to the expansive power: the particles are totally separated, and converted into steam or vapour. But the agency of heat is in no body more sensible than in air, which dilates and contracts by its increase or diminution in a very remarkable degree.

EMILY.

The effects of heat appear to be one of the most interesting parts of natural philosophy.

MRS. B.

That is true: but heat is so intimately connected with chemistry, that you must allow me to defer the investigation of its properties till you become acquainted with that science.\*

To return to its antagonist, the attraction of cohesion; it is this power which restores to vapour its liquid form, which unites it into drops when it falls to the earth in a shower of rain, which gathers the dew into brilliant gems on the blades of grass.

\* See Conversations on Chemistry.

EMILY.

And I have often observed that, after a shower, the water collects into large drops on the leaves of plants; but I cannot say that I perfectly understand how the attraction of cohesion produces this effect.

MRS. B.

Rain does not descend from the clouds at first in the form of drops, but in that of mist or vapour, which is composed of very small watery particles; these, in their descent, mutually attract each other, and those that are sufficiently near in consequence unite and form a drop, and thus the mist is transformed into a shower. The dew also was originally in a state of vapour, but is, by the mutual attraction of the particles, formed into small globules on the blades of grass; in a similar manner the rain upon the leaf collects into large drops, which, when they become too heavy for the leaf to support, fall to the ground.

EMILY.

Then it was the weight of the drop of water hanging at the end of your finger which at last made it fall; but what is weight?

MRS. B.

We are not yet come to that property of matter, and we must proceed by degrees, and with some

degree of method, or you will acquire a confused mass of ideas, which will be of little use to you.

EMILY.

*That is very true; for I almost feel bewildered already, but it is with surprise and admiration at the number of new ideas I have acquired.*

MRS. B.

Every step that you advance in the pursuit of natural science, will fill your mind with admiration and gratitude towards its Divine Author. In the study of natural philosophy, we must consider ourselves as reading the book of nature, in which the bountiful goodness and wisdom of God is revealed to all mankind: no study, then, can tend more to purify the heart, and raise it to religious contemplation of the Divine perfections.

Among the wonderful phenomena of nature, I must not omit to point out to you a curious effect of the attraction of cohesion. It enables liquids to rise above their level in capillary tubes: these are tubes the bores of which are so extremely small that liquids ascend within them from the cohesive attraction between the particles of the liquid and the interior surface of the tube. Do you perceive the water rising above its level in this small glass tube which I have immersed in a goblet full of water?

EMILY.

Oh, yes; I see it slowly creeping up the tube, but now it is stationary. Will it rise no higher?

MRS. B.

No; because the cohesive attraction between the water and the internal surface of the tube is now balanced by the weight of the water within it. If the bore of the tube were narrower, the water would rise higher; and if you immerse several tubes of bores of different sizes, you will see it rise to different heights in each of them. In making this experiment you should colour the water with a little red wine, in order to render the effect more obvious.

All porous substances, such as sponge, bread, linen, &c., may be considered as collections of capillary tubes: if you dip one end of a lump of sugar into water, the water will rise in it, and wet it considerably above the surface of that into which you dip it.

EMILY.

In making tea I have often observed that effect, without being able to account for it.

MRS. B.

Now that you are acquainted with the attraction of cohesion, I must endeavour to explain to you that of *Gravitation*. Like the attraction of

cohesion, it results from the attractive force of the minute particles of matter of which bodies are composed ; but it is a force acting at considerable distances, and is only perceptible in its effects when many particles of matter are combined together in one body. It acts, therefore, on the largest bodies, and at immense distances, as well as small ones.

EMILY.

You astonish me ; surely you do not mean to say, that large bodies attract each other ?

MRS. B.

Indeed I do ; let us take, for example, one of the largest bodies in nature, and observe whether it does not attract other bodies. What is it that occasions the fall of this book, when I no longer support it ?

EMILY.

Can it be the attraction of the earth ? I thought that all bodies had a natural tendency to fall.

MRS. B.

They have a natural tendency to fall, it is true ; but that tendency is produced entirely by the attraction of the earth : the earth, being so much larger than any body on its surface, forces every body, which is not supported, to fall upon it.

EMILY.

If the tendency which bodies have to fall results from the earth's attractive power, the earth itself can have no such tendency, since it cannot attract itself, and, therefore, it requires no support to prevent it from falling. This, then, is the answer to Sophia's question. Yet the idea that bodies do not fall of their own accord, but that they are drawn towards the earth by its attraction, is so new and strange to me, that I know not how to reconcile myself to it.

MRS. B.

When you are accustomed to consider the fall of bodies as depending on this cause, it will appear to you as natural, and surely much more satisfactory, than if the cause of their tendency to fall were totally unknown. Thus you understand, that all matter is attractive, from the smallest particle to the largest mass; and that bodies attract each other with a force proportioned to the quantity of matter they contain.

EMILY.

I do not perceive any difference between the attraction of cohesion and that of gravitation; is it not because every particle of matter is endowed with an attractive power, that large bodies, consisting of a great number of particles, are so strongly attractive?

MRS. B.

True. There is, however, this difference between the attraction of particles, and that of masses, that the former is stronger than the latter, in proportion to the quantity of matter. Of this you have an instance in the attraction of capillary tubes, in which liquids ascend by the attraction of cohesion, in opposition to that of gravity. It is on this account that it is necessary that the bore of the tube should be extremely small ; for if the column of water within the tube is not very minute, the attraction would not be able either to raise or support its weight, in opposition to that of gravity.

You may observe, also, that all solid bodies are enabled by the force of the cohesive attraction of their particles to resist that of gravity, which would otherwise disunite them, and bring them to a level with the ground, as it does in the case of liquids, the cohesive attraction of which is not sufficient to enable them to resist the power of gravity.

EMILY.

And some solid bodies appear to be of this nature, as sand and powder, for instance: is there 'no attraction of cohesion between their particles?

MRS. B.

Every grain of powder or sand is composed of a great number of minute particles, firmly united by the attraction of cohesion ; but amongst the

separate grains there is no sensible attraction, because they are not in sufficiently close contact.

EMILY.

Yet they actually touch each other.

MRS. B.

The surface of bodies is in general so rough and uneven, that, when in actual contact, they touch each other only by a few points. Thus, if I lay upon the table this book, the binding of which appears perfectly smooth, yet so few of the particles of its under surface come in contact with the table that no sensible degree of cohesive attraction takes place; for you see that it does not stick or cohere to the table, and I find no difficulty in lifting it off. It is only when surfaces perfectly flat and well polished are placed in contact, that the particles approach in sufficient number, and closely enough to produce a sensible degree of cohesive attraction. Here are two hemispheres of polished metal; I press their flat surfaces together, having previously interposed a few drops of oil to fill up every little porous vacancy. Now, try to separate them.

EMILY.

It requires an effort beyond my strength, though there are handles for the purpose of pulling them asunder. Is the firm adhesion of the two hemispheres merely owing to the attraction of cohesion?



MRS. B.

To no other cause; nor is there any force more powerful, since it is by this that the particles of the harder bodies are held together. It would require a weight of several pounds to separate these hemispheres.

EMILY.

In making a kaleidoscope, I recollect that the two plates of glass which were to serve as mirrors stuck so fast together, that I imagined some of the gum I had been using had by chance been interposed between them; but now I make no doubt that it was their own natural cohesive attraction which produced this effect.

MRS. B.

Very probably; for plate glass has an extremely smooth flat surface, admitting of the contact of a great number of particles between two plates laid one over the other.

EMILY.

But, Mrs. B., the cohesive attraction of some bodies is much greater than that of others; thus glue, gum, and paste cohere with singular tenacity.

MRS. B.

This is owing to the peculiar chemical properties of those bodies, independently of their cohesive attraction.

There are some other kinds or modifications of attraction peculiar to certain bodies; such as that of magnetism, and of electricity; but we shall confine our attention merely to the attraction of cohesion and of gravity. The examination of the latter we shall resume at our next meeting.

## CONVERSATION II.

## ON THE ATTRACTION OF GRAVITY.

ATTRACTION OF GRAVITATION CONTINUED. — OF WEIGHT. — OF THE FALL OF BODIES. — OF THE RESISTANCE OF THE AIR. — OF THE ASCENT OF LIGHT BODIES.

EMILY.

I HAVE related to my sister Caroline all that you have taught me of natural philosophy, and she has been so much delighted by it, that she hopes you will have the goodness to admit her to your lessons.

MRS. B.

Very willingly : but I did not think you had any taste for studies of this nature, Caroline ?

CAROLINE.

I confess, Mrs. B., that hitherto I had formed no very agreeable idea, either of philosophy, or

philosophers; but what Emily has told me has excited my curiosity so much, that I shall be highly pleased if you will allow me to become one of your pupils.

MRS. B.

I fear that I shall not find you so tractable a scholar as Emily; I know that you are much prejudiced in favour of your own opinions.

CAROLINE.

Then you will have the greater merit in reforming them, Mrs. B.; and after all the wonders that Emily has related to me, I think I stand but little chance against you and your attractions.

MRS. B.

You will, I doubt not, advance a number of objections; but these I shall willingly admit, as they will be a means of elucidating the subject. Emily, do you recollect the names of the general properties of bodies?

EMILY.

I think so. Impenetrability, extension, figure, divisibility, inertia, and attraction.

MRS. B.

Very well. You must remember that these are properties common to all bodies, and of which they cannot be deprived: all other properties of bodies

are called accidental, because they depend on the relation or connection of one body to another.

CAROLINE.

Yet, surely, Mrs. B., there are other properties which are essential to bodies, besides those you have enumerated. Colour and weight, for instance, are common to all bodies, and do not arise from their connection with each other, but exist in the bodies themselves; these, therefore, cannot be accidental qualities?

MRS. B.

I beg your pardon; these properties do not exist in bodies independently of their connection with other bodies.

CAROLINE.

What! have bodies no weight? Does not this table weigh heavier than this book; and if one thing weighs heavier than another, must there not be such a thing as weight?

MRS. B.

No doubt: but this property does not appear to be essential to bodies; it depends upon their connection with each other. Weight is an effect of the power of attraction, without which the table and the book would have no weight whatever.

EMILY.

I think I understand you: is it not the attraction of gravity which makes bodies heavy?

MRS. B.

You are right. I told you that the attraction of gravity was proportioned to the quantity of matter which bodies contained: now the earth consisting of a much greater quantity of matter than any body upon its surface, the force of its attraction must necessarily be greatest, and must draw every thing towards it; in consequence of which, bodies that are unsupported fall to the ground, whilst those that are supported press upon the object which prevents their fall, with a weight equal to the force with which they gravitate towards the earth.

EMILY.

This, then, was the cause which made the drop of water fall from your finger to the ground; for the same cause, which occasions the fall of bodies, produces also their weight.

CAROLINE.

It was very dull in me not to understand this before, as it is the natural and necessary consequence of attraction; but the idea that bodies were not really heavy of themselves, appeared to be quite incomprehensible. But, Mrs. B., if attraction is a property essential to matter, weight must be so likewise; for how can one exist without the other?

MRS. B.

Suppose that there were but one body existing in universal space, what would its weight be?

CAROLINE.

That would depend upon its size ; or, more accurately speaking, upon the quantity of matter it contained.

EMILY.

No, no ; the body would have no weight, whatever were its size ; because nothing would attract it. Am I not right, Mrs. B. ?

MRS. B.

You are. You must allow, therefore, that it would be possible for attraction to exist without weight ; for each of the particles of which the body was composed would possess the power of attraction : but they could exert it only amongst themselves ; the whole mass having nothing to attract, or to be attracted by, would have no weight.

CAROLINE.

I am now well satisfied that weight is not essential to the existence of bodies ; but what have you to object to colours, Mrs. B. ? You will not, I think, deny that they really exist in the bodies themselves ?

MRS. B.

When we come to treat of the subject of colours, I trust that I shall be able to convince you that these are likewise accidental qualities, quite distinct from the bodies to which they appear to belong.

CAROLINE.

Oh! do pray explain it to us now, I am so very curious to know how that it is possible.

MRS. B.

Unless we proceed with some degree of order and method, you will in the end find yourself but little the wiser for all you learn. Let us, therefore, go on regularly, and make ourselves well acquainted with the general properties of bodies, before we proceed farther.

EMILY.

To return, then, to attraction, (which appears to me by far the most interesting of them, since it belongs equally to all kinds of matter,) it must be mutual between two bodies: and if so, when a stone falls to the earth, the earth should rise part of the way to meet the stone?

MRS. B.

Certainly; but you must recollect that the force of attraction is proportioned to the quantity of matter which bodies contain; and if you consider the difference there is in that respect between a stone and the earth, you will not be surprised that you do not perceive the earth rise to meet the stone: for though it is true that a mutual attraction takes place between the earth and the stone, that of the latter is so very small in comparison to that of the former, as to render its effect insensible.



EMILY.

But since attraction is proportioned to the quantity of matter which bodies contain, why do not the hills attract the houses and churches towards them?

CAROLINE.

Heavens, Emily, what an idea! How can the houses and churches be moved, when they are so firmly fixed in the ground?

MRS. B.

Emily's question is not absurd, and your answer, Caroline, is perfectly just; but can you tell us why the houses and churches are so firmly fixed in the ground?

CAROLINE.

I am afraid I have answered right by mere chance; for I begin to suspect that bricklayers and carpenters could give but little stability to their buildings, without the aid of attraction.

MRS. B.

It is certainly the cohesive attraction between the bricks and the mortar which enables them to build walls; and these, in their turn, are so strongly attracted by the earth as to resist every other impulse; otherwise they would necessarily move towards the hills and the mountains; but the lesser force must yield to the greater. There are, however, some circumstances in which the attraction

of a large body has sensibly counteracted that of the earth. If, whilst standing on the declivity of a mountain, you hold a plumb-line in your hand, the weight will not fall perpendicular to the earth, but incline a little towards the mountain; and this is owing to the lateral, or sideways attraction of the mountain, interfering with the perpendicular attraction of the whole earth.

EMILY.

But the size of a mountain is very trifling, compared to that of the whole earth?

MRS. B.

Attraction, you must recollect, diminishes with distance; and in the example of the plumb-line, the weight suspended is considerably nearer to the mountain than to the centre of the earth. Besides, the inclination of the plumb-line towards the mountain is very small; so small that it is not sensible to the eye without the help of instruments contrived for the purpose.

CAROLINE.

Pray, Mrs. B., do the two scales of a balance hang parallel to each other?

MRS. B.

You mean, I suppose, in other words, to inquire whether two lines which are perpendicular to the earth are parallel to each other? I believe I guess

the reason of your question ; but I wish you would endeavour to answer it without my assistance.

CAROLINE.

I was thinking that such lines must both tend by gravity to the same point, the centre of the earth : now, lines tending to the same point cannot be parallel, as parallel lines are always at an equal distance from each other, and would never meet.

MRS. B.

Very well explained. You see now the use of your knowledge of parallel lines : had you been ignorant of their properties, you could not have drawn such a conclusion. This may enable you to form an idea of the great advantage to be derived even from a slight knowledge of geometry, in the study of natural philosophy : and if, after I have made you acquainted with the first elements, you should be tempted to pursue the study, I would advise you to prepare yourselves by acquiring some knowledge of geometry. This science would teach you that lines which fall perpendicularly to the surface of a sphere cannot be parallel, because, if prolonged, they would all meet at the centre of the sphere : while lines which fall perpendicularly to a plane or flat surface are always parallel, because if prolonged they would never meet.

EMILY.

And yet a pair of scales, hanging perpendicularly to the earth, appear parallel?

MRS. B.

Because the sphere is so large, and the scales consequently converge so little, that their inclination is not perceptible to our senses: if we could construct a pair of scales whose beam would extend several degrees, their convergence would be very obvious; but as this cannot be accomplished, let us draw a small figure of the earth, and then we may make a pair of scales of the proportion we please. (Plate I. fig. 1.)

CAROLINE.

This figure renders it very clear: then two bodies cannot fall to the earth in parallel lines?

MRS. B.

Never; for they both tend towards the centre of the earth, and therefore must converge, but so very slightly, that, like the hanging of the scales, they appear to fall in parallel lines.

CAROLINE.

The reason that a heavy body falls quicker than a light one, is, I suppose, because the earth attracts it more strongly?

MRS. B.

The earth, it is true, attracts a heavy body more than a light one; but that would not make the one fall quicker than the other.

CAROLINE.

Yet, since it is attraction that occasions the fall of bodies, surely the more a body is attracted the more rapidly it will fall. Besides, experience proves it to be so. Do we not every day see heavy bodies fall quickly, and light bodies slowly?

EMILY.

It strikes me, as it does Caroline, that as attraction is proportioned to the quantity of matter, the earth must necessarily attract a body which contains a great quantity more strongly, and therefore bring it to the ground sooner, than one consisting of a smaller quantity.

MRS. B.

You must consider, that if heavy bodies are attracted more strongly than light ones, they require more attraction to make them fall. Remember that bodies have no natural tendency to fall, any more than to rise, or to move laterally, and that they will not fall unless impelled by some force; now this force must be proportioned to the quantity of matter it has to move. A body consisting of 1000 particles of matter, for instance, requires ten times

as much attraction to bring it to the ground in the same space of time as a body consisting of only 100 of the same particles.

CAROLINE.

I do not understand that ; for it seems to me, that the heavier a body is, the more easily and readily it falls.

EMILY.

I think I now comprehend it ; let me try if I can explain it to Caroline. Suppose that I draw towards me two bodies, the one of 100 lbs., the other of 1000 lbs. weight, must I not exert ten times as much strength to draw the heavier one to me, in the same space of time, as is required for the lighter one ? And if the earth draws a body of 1000 lbs. weight to it in the same space of time that it draws a body of 100 lbs., does it not follow that it attracts the heavier body with ten times the force that it does the lighter one ?

CAROLINE.

I comprehend your reasoning perfectly : but if it were so, the body of 1000 lbs. weight and that of 100 lbs. would fall with the same rapidity ; and the consequence would be, that all bodies, whether light or heavy, being at an equal distance from the ground, would fall to it in the same space of time. Now it is very evident that this conclusion is absurd ; experience every instant contradicts it :

observe how much sooner this book reaches the floor than this sheet of paper, when I let them drop together.

EMILY.

That is an objection I cannot answer. I must refer it to you, Mrs. B.

MRS. B.

I trust that we shall not find it insurmountable. It is true that, according to the laws of attraction, all bodies at an equal distance from the earth should fall to it in the same space of time; and this would actually take place if no obstacle intervened to impede their fall. But bodies fall through the air, and it is the resistance of the air which makes bodies of different densities fall with different degrees of velocity.

EMILY.

True: they must all force their way through the air, and dense heavy bodies overcome this obstacle more easily than rarer and lighter ones.

CAROLINE.

But the resistance which air opposes to the fall of bodies must be proportioned to their size, not to their weight; for the air being inert, cannot exert a greater force to support the weight of a cannon ball, than it does to support the weight of a ball of leather of the same size; and since without

air the two balls would fall to the ground in the same space of time, I should have supposed that, receiving each an equal support from the air, their fall would have been equally retarded, and that they would have reached the ground together.

MRS. B.

No; that would happen if the air offered a resistance to the two balls proportioned to their weight, instead of to their size; for the cannon ball contains perhaps 100 times more matter than the leathern ball, and consequently would require 100 times more resistance to impede its fall equally.

CAROLINE.

O yes; every particle of matter of the cannon ball should receive the same support from the air which the particles of the leathern ball receive, in order to retard their descent equally, and make the heavy ball fall as slowly as the light one.

EMILY.

The larger the surface of a body, then, the more air it covers, and the greater is the resistance it meets with from it.

MRS. B.

Certainly. Observe the manner in which this sheet of paper falls: it floats awhile in the air, and then gently descends to the ground. I will roll the same piece of paper up into a ball: it offers now



but a small surface to the air, and encounters therefore but little resistance: see how much more rapidly it falls.

The heaviest bodies may be made to float awhile in the air, by making the extent of their surface counterbalance their weight. Here is some gold, one of the most dense bodies we are acquainted with: but it has been beaten into a very thin leaf, and offers so great an extent of surface in proportion to its weight, that its fall, you see, is still more retarded by the resistance of the air than that of the sheet of paper.

CAROLINE.

That is very curious; and it is, I suppose, upon the same principle that iron boats may be made to float on water?

MRS. B.

Certainly. When bodies have but little bulk in proportion to their weight, the resistance of the air has but a very trifling effect; and stones of different sizes, let fall from the top of a house, will all reach the ground nearly at the same time.

EMILY.

But, Mrs. B., if the air is a real body, is it not also subjected to the laws of gravity?

MRS. B.

Undoubtedly.

EMILY.

Then why does it not, like all other bodies, fall to the ground?

MRS. B.

The fact is, that it actually does, since the lower stratum of the atmosphere is really in contact with the earth; but the strata above do not fall, because they are supported: the particles of air which are nearest to the ground support those that are above, just as the water at the bottom of a basin supports that which is at the surface.

The only difference is, that air is an *elastic fluid*, a species of bodies, the peculiar property of which is to resume, after compression, their original dimensions; and you must consider the air of which the atmosphere is composed as existing in a state of compression; for its particles, being drawn towards the earth by gravity, are brought closer together than they would otherwise be; but the spring or elasticity of the air, by which it endeavours to resist compression, gives it a constant tendency to expand.

EMILY.

The air then is, I suppose, thicker, or I should rather say more dense, near the surface of the earth, than in the higher regions of the atmosphere; for that part of the air which is nearest to the surface of the earth must be most strongly attracted.

MRS. B.

The diminution of the force of the gravity, at so small a distance as that to which the atmosphere extends (compared with the size of the earth), is so inconsiderable as to be scarcely sensible; but the weight of the upper parts of the atmosphere resting on those beneath, renders the air near the surface of the earth much more dense than in the upper regions. The pressure of the atmosphere has been compared to that of a pile of fleeces of wool, in which the lower fleeces are pressed together by the weight of those above: these lie light and loose, in proportion as they approach the uppermost fleece, which receives no external pressure, and is confined merely by the force of its own gravity.

CAROLINE.

It has just occurred to me that there are some bodies which do not gravitate towards the earth. Smoke and steam, for instance, rise, instead of falling.

MRS. B.

It is still gravity which produces their ascent; at least, were that power destroyed, these bodies would not rise.

CAROLINE.

Then you must allow, Mrs. B., that gravity is very inconsistent in its operations.

MRS. B.

There is no difficulty in reconciling this apparent inconsistency of effect. The air near the earth is heavier than smoke, steam, or other vapours; it consequently not only supports these light bodies, but forces them to rise, till they reach a part of the atmosphere, the weight of which is not greater than their own, and there they remain stationary. Look at this basin of water; why does the piece of cork which I throw into it float on the surface?

EMILY.

Because, being lighter than the water, it is supported by it.

MRS. B.

And now that I pour more water into the basin, why does the cork rise?

EMILY.

The water, being heavier than the cork, sinks beneath it, and obliges it to rise.

MRS. B.

In a similar manner are smoke and vapour forced upwards by the air; but these bodies do not, like the cork, ascend to the surface of the fluid, because, as we observed before, the air being thinner and lighter, as it is more distant from the earth, vapours rise only till they attain a region of air of their own density. Smoke, indeed, ascends but a very little

way: it consists of minute particles of fuel carried up by a current of heated air from the fire below. Heat, you recollect, causes all bodies to expand; it consequently rarifies air, and renders it lighter than the colder air of the atmosphere; the heated air from the fire carries up with it vapour and small particles of the combustible materials which are burning in the fire. When this current of hot air is cooled by mixing with that of the atmosphere, the minute particles of coal or other combustibles fall; and it is this which produces the small black flakes which render the air and every thing in contact with it, in London, so dirty.

CAROLINE.

You must, however, allow me to make one more objection to the universal gravity of bodies; it is the ascent of air-balloons, the materials of which are undoubtedly heavier than air; how, therefore, can they be supported by it?

MRS. B.

I admit that the materials of which balloons are made are heavier than the air; but the air with which they are filled is an elastic fluid, of a different nature from the atmospheric air, and considerably lighter; so that, on the whole, the balloon is lighter than an equal bulk of the air which it displaces, and consequently will rise, on the same principle as smoke and vapour. Now, Emily, let me hear

if you can explain how the gravity of bodies is modified by the effect of the air?

EMILY.

The air forces bodies which are lighter than itself to ascend; those that are of an equal weight will remain stationary in it; and those that are heavier will descend through it: but the air will have some effect on these last; for if they are not much heavier, they will with difficulty overcome the resistance they meet with in passing through it, they will be borne up by it, and their fall will be more or less retarded.

MRS. B.

Very well. Observe how slowly this light feather falls to the ground, while a heavier body, like this marble, overcomes the resistance which the air makes to its descent much more easily, and its fall is proportionally more rapid. I now throw a pebble into this tub of water; it does not reach the bottom so soon as if there were no water in the tub, because it meets with resistance from the water. Suppose that we could empty the tub, not only of water, but of air also, the pebble would then fall quicker still, as it would in that case meet with no resistance at all to counteract its gravity.

Thus you see that it is not the different degrees of gravity, but the resistance of the air, which prevents bodies of different weight from falling with equal velocities. If the air did not bear up

the feather, it would reach the ground as soon as the marble.

Here is a dollar and a piece of writing-paper of exactly the same dimensions. I let them fall at the same instant: you see how much sooner the dollar reaches the ground than the paper; but if I place the paper upon the dollar, so closely that no air shall intervene, what will be the consequence?

CAROLINE.

The paper can no longer meet with resistance from the air, it is true; but it will be supported by the dollar?

EMILY.

If it has no other support it will fall as rapidly as the dollar. Let us see if it is not so, Mrs. B.? — Precisely; this is a charming experiment, it is at once so simple and so conclusive.

CAROLINE.

Yet I do not feel quite satisfied. I wish there were any place void of air, in which the experiment could be made.

MRS. B.

If that proof will satisfy your doubts, I can give it you. Here is a machine called an *air-pump* (Pl. I. fig. 2.), by means of which the air may be expelled from any close vessel which is placed over this opening, through which the air is pumped out.

Glasses of various shapes, usually called *receivers*, are employed for this purpose. We shall now exhaust, that is, pump out the air from this tall receiver which is placed over the opening, and we shall find that bodies, of whatever weight or size, within it, will fall from the top to the bottom in the same space of time.

CAROLINE.

Oh, I shall be delighted with this experiment! What a curious machine! How can you put the two bodies of different weight within the glass, without admitting the air?

MRS. B.

A sovereign and a feather are already placed there for the purpose of the experiment; here is, you see, a contrivance to fasten them in the upper part of the glass. As soon as the air is pumped out, I shall turn this little screw, by which means the brass plates which support them will be inclined, and the two bodies will fall. — Now, I believe, I have pretty well exhausted the air.

CAROLINE.

Pray, let me turn the screw. — I declare, they both reached the bottom at the same instant. Did you see, Emily, the feather appeared as heavy as the sovereign?



EMILY.

Exactly; and fell just as quickly. How wonderful this is! What a number of entertaining experiments might be made with this machine!

MRS. B.

No doubt there are a great variety; but we shall reserve them to elucidate the subjects to which they relate. If I had not explained to you why the sovereign and the feather fell with equal velocity, you would not have been so well pleased with the experiment.

EMILY.

I should have been as much surprised, but not so much interested; besides, experiments help to imprint on the memory the facts they are intended to illustrate; it will be better, therefore, for us to restrain our curiosity, and wait for other experiments in their proper places.

CAROLINE.

Pray, by what means is the air exhausted in this receiver?

MRS. B.

You must learn something of mechanics in order to understand the construction of a pump. At our next meeting, I shall endeavour to make you acquainted with the laws of motion, which will be an introduction to that subject.

## CONVERSATION III.

## ON THE LAWS OF MOTION.

OF MOTION. — OF THE INERTIA OF BODIES. — OF FORCE TO PRODUCE MOTION. — DIRECTION OF MOTION. — VELOCITY, ABSOLUTE AND RELATIVE. — UNIFORM MOTION. — RETARDED MOTION. — ACCELERATED MOTION. — VELOCITY OF FALLING BODIES. — MOMENTUM. — ACTION AND RE-ACTION EQUAL. — ELASTICITY OF BODIES. — POROSITY OF BODIES. — REFLECTED MOTION. — ANGLES OF INCIDENCE AND REFLECTION.

MRS. B.

THE science of mechanics is founded on the laws of motion ; it will therefore be necessary to make you acquainted with these laws before we examine the mechanical powers. Tell me, Caroline, what do you understand by the word motion.

CAROLINE.

I think I understand it perfectly, though I am at a loss to describe it. Motion is the act of moving

about, going from one place to another ; it is the contrary of remaining at rest.

MRS. B.

Very well. Motion, then, consists in a change of place. A body is in motion whenever it is changing its situation with regard to a fixed point.

Now, since we have observed that one of the general properties of bodies is Inertia, that is, passiveness either with regard to motion or rest, it follows that a body cannot move without being put into motion. The power which puts a body into motion is called *force*: thus, the stroke of the hammer is the force which drives the nail ; the pulling of the horse, that which draws the carriage, &c. Force, then, is the cause which produces motion.

EMILY.

And may we not say that gravitation is the force which occasions the fall of bodies ?

MRS. B.

Undoubtedly. I have given you the most familiar illustrations in order to render the explanation clear ; but since you seek for more scientific examples, you may say that cohesion is the force which binds the particles of bodies together, and heat the force which drives them asunder.

The motion of a body acted upon by a single

force is always in a straight line, in the direction in which it received the impulse.

CAROLINE.

That is very natural. The degree of quickness with which it moves must, I suppose, also depend upon the degree of force with which it is impelled?

MRS. B.

Yes; the rate at which a body moves, or the length of time which it takes to go from one place to another, is called its velocity; and one of the laws of motion is, that the velocity of the moving body is proportioned to the force by which it is put in motion.

CAROLINE.

Nothing more simple; if I strike a ball hard, it will go a great way; if gently, it will go only a little way.

MRS. B.

We must distinguish between absolute and relative velocity.

The velocity of a body is called *absolute*, if we consider the motion of the body in space, without any reference to that of other bodies. When, for instance, a horse goes fifty miles in ten hours, his velocity is five miles an hour.

The velocity of a body is termed *relative*, when compared with that of another body which is itself in motion, taking into consideration the difference

only of these two velocities. Thus, a man sailing in a ship may remain at rest relatively to the vessel, though he partakes of its absolute motion ; but if he walk the deck in the same direction as that in which the ship is sailing, his absolute motion will be increased by the rate at which he moves along it, and his relative motion will be the difference between his own absolute motion and that of the ship.

EMILY.

Let me see if I understand it. — The relative velocity of a body is the degree of rapidity of its motion compared with that of another body ; thus, if one ship sail three times as far as another ship in the same space of time, the velocity of the former is equal to three times that of the latter.

MRS. B.

So if two carriages go along the same road in the same direction, their relative velocity will be the difference of their absolute velocities ; if in opposite directions, the sum : if they start from the same point along two roads, making an angle with each other, their relative motion will be measured by their distance in a straight line from each other after a given time, and the direction of this relative motion will be the direction of that line.

The general rule may be expressed thus : the absolute velocity of a body is measured by the space over which it moves, divided by the time which it

employs in that motion: now, if you travel one hundred miles in twenty hours, what is your velocity in each hour?

EMILY.

I must divide the space, which is one hundred miles, by the time, which is twenty hours, and the answer will be five miles an hour. Then, Mrs. B., may we not reverse this rule, and say, that the time is equal to the space divided by the velocity; since the space, one hundred miles, divided by the velocity, five miles, gives twenty hours for the time?

MRS. B.

Certainly; and we may say also, that space is equal to the velocity multiplied by the time. Can you tell me, Caroline, how many miles you will have travelled, if your velocity is three miles an hour, and you travel six hours?

CAROLINE.

Eighteen miles: for the product of 3 multiplied by 6 is 18.

MRS. B.

I suppose that you understand what is meant by the terms *uniform*, *accelerated*, and *retarded* motion.

EMILY.

I conceive uniform motion to be that of a body whose motion is regular, and at an equal rate throughout; for instance, a horse that goes an equal

number of miles every hour. But the hand of a watch is a much better example, as its motion is so regular as to indicate the time.

MRS. B.

You have a right idea of uniform motion ; but it would be more correctly expressed by saying, that the motion of a body is uniform when it passes over equal spaces in equal times ; uniform motion is produced by a force having acted on a body once, and having ceased to act ; as, for instance, the stroke of a bat on a cricket-ball.

CAROLINE.

But the motion of a cricket-ball is not uniform ; its velocity gradually diminishes till it falls to the ground.

MRS. B.

Recollect that the cricket-ball has no more power to stop than to put itself in motion ; if it fall, therefore, it must be stopped by some force superior to that by which it was projected, and which destroys its motion.

CAROLINE.

And it is, no doubt, the force of gravity which counteracts and destroys that of projection ; but if there were no such power as gravity, would the cricket-ball never stop ?

MRS. B.

If neither gravity nor any other force, such as the resistance of the air, opposed its motion, the cricket-ball, or even a stone thrown by the hand, would proceed onwards, in a right line, and with an uniform velocity, for ever.

CAROLINE.

You astonish me! I thought that it was impossible to produce perpetual motion?

MRS. B.

Perpetual motion cannot be produced by human power, because gravity ultimately destroys all motion which human powers can produce.

EMILY.

But independently of the force of gravity, I cannot conceive that the little motion I am capable of giving to a stone would put it in motion for ever.

MRS. B.

The quantity of motion you communicated to the stone would not influence its duration. If you threw it with little force, it would move slowly; for its velocity, you must remember, will be proportional to the force with which it is projected; but if there be nothing to obstruct its passage, it will continue to move with the same velocity and in the same direction, as when you first projected it.



CAROLINE.

This appears to me quite incomprehensible ; we do not meet with a single instance of it in nature.

MRS. B.

I beg your pardon. When you come to study the motion of the celestial bodies, you will find that nature abounds with examples of perpetual motion ; and that it conduces as much to the harmony of the system of the universe, as the prevalence of it would to the destruction of all comfort on our globe. The wisdom of Providence has therefore ordained insurmountable obstacles to perpetual motion here below ; and though these obstacles often compel us to contend with great difficulties, yet the result is that order, regularity, and repose, so essential to the general preservation of all the various beings of which this world is composed.

Now, can you tell me what is *retarded motion* ?

CAROLINE.

Retarded motion is that of a body which moves every moment slower and slower. Thus, when I am tired with walking fast, I slacken my pace ; or when a stone is thrown upwards, its velocity is gradually diminished by the power of gravity.

MRS. B.

Retarded motion is produced by some force acting upon the body in a direction opposite to that

which first put it in motion. You who are an animated being, endowed with power and will, may slacken your pace, and stop to rest when you are tired; but inert matter is incapable of any feeling of fatigue, can never slacken its pace, and never stop, unless retarded or arrested in its course by some opposing force; and as mechanics treat of the laws of inert bodies, I prefer your illustration of the stone retarded in its ascent. Now, Emily, it is your turn; what is *accelerated motion*?

EMILY.

Accelerated motion, I suppose, takes place when the velocity of a body is increased. If you had not objected to our giving such active bodies as ourselves for examples, I should say that my motion is accelerated if I change my pace from walking to running. I cannot think of any instance of accelerated motion in inanimate bodies. All motion of inert matter seems to be retarded by gravity.

MRS. B.

Not in all cases; for the power of gravitation often produces accelerated motion — in falling bodies, for instance.

EMILY.

True; a stone falling from a height moves with a regularly accelerated motion; no doubt because the nearer it approaches the earth, the more it is attracted by it.

MRS. B.

You have mistaken the cause of its acceleration of motion. For though it is true that the force of gravity increases as a body approaches the earth, the difference is so trifling at any small distance from its surface as to be imperceptible.

Accelerated motion is produced, when the force which put a body in motion continues to act upon it during its motion, so that its velocity is continually increased. When a stone falls from a height, the impulse which it receives from gravity during the first instant of its fall, would be sufficient to bring it to the ground with a uniform velocity: for, as we have observed, a body having been once acted upon by a force, will continue to move with a uniform velocity. But the stone is not acted upon by gravity merely at the first instant of its fall; this power continues to impel it during the whole of its descent, and it is this continued impulse which accelerates its motion.

EMILY.

I do not quite understand that.

MRS. B.

Let us suppose that the instant after you have let fall a stone from a high tower, the force of gravity were annihilated, the body would nevertheless descend: for it would have received a first impulse from gravity, and a body once put in motion will not stop unless some obstacle impede its course.

In this case its velocity would be uniform; for though there would be no obstacle to obstruct its descent, there would be no force to accelerate it.

EMILY.

That is very clear.

MRS. B.

If, then, instead of being annihilated, the force of gravity continue to act on the stone during the whole of its descent, it will not be difficult to understand that its motion will become accelerated. Let us suppose that the impulse given by gravity to the stone during the first instant of its descent be equal to one; the next instant we shall find that an additional impulse gives the stone an additional velocity equal to one; so that the accumulated velocity is now equal to two; the following instant another impulse increases the velocity to three, and so on till the stone reaches the ground.

CAROLINE.

Now I understand it. The effects of preceding impulses must be added to the subsequent velocities.

MRS. B.

Yes. The spaces described in a given time follow a law slightly different. For it has been ascertained, both by experiment and calculations, which it would be too difficult for us to enter into, that heavy bodies descending from a height by the force

of gravity, fall sixteen feet in the first second of time, three times that distance in the next, five times in the third second, seven times in the fourth, and so on, regularly increasing their velocities as well as the spaces described, according to the number of seconds during which the body has been falling.

EMILY.

Then the height of a mountain, or the depth of a well, might be measured by observing the length of time which a stone takes in falling from the top to the bottom?

CAROLINE.

I recollect the depth of the well of Carisbrook Castle being shown by that means: the guide throws a pebble into the well, and four seconds elapse before it reaches the bottom, which proves that the well is above 300 feet deep.

EMILY.

If you throw a stone perpendicularly upwards, is it not the same length of time ascending that it is descending?

MRS. B.

Exactly. In ascending, the velocity is diminished by the force of gravity; in descending, it is accelerated by it.

CAROLINE.

I should then have imagined that it would have fallen quicker than it rose ?

MRS. B.

You must recollect that the force with which it is projected must be taken into the account ; and that this force is overcome and destroyed by gravity before the body falls.

CAROLINE.

But the force of projection given to a stone, in throwing it upwards, cannot always be equal to the force of gravity in bringing it down again ; for the force of gravity is always the same, whilst the degree of impulse given to the stone varies. I may throw it up gently, or with violence.

MRS. B.

If you throw it gently, it will not rise high, and gravity will soon bring it down again : if you throw it with violence, it will rise much higher, and gravity will be longer in bringing it back to the ground.

Suppose that you throw it with a force which will make it rise only sixteen feet ; in that case, you know, it will fall in one second of time.

Now it is proved by experiment, that an impulse requisite to project a body sixteen feet upwards, will make it ascend that height in one

second ; here, then, the times of the ascent and descent are equal. But supposing it be required to throw a stone twice that height, the force must be proportionally greater.

You see, then, that the impulse of projection in throwing a body upwards is equal to the force exerted by gravity during its descent : and it is the greater or less distance to which the body rises, that makes these two forces balance each other ; for it gives more time to the force of gravitation, during which to act.

I must now explain to you what is meant by the *momentum* of bodies. It is the force, or power, with which a body in motion strikes against another body, so as to set the latter in motion. The momentum of a body is composed of its weight multiplied by its velocity.

CAROLINE.

The quicker a body moves, the greater, no doubt, must be the force with which it would strike against another body.

EMILY.

Therefore a small light body may have a greater momentum than a large heavy one, provided its velocity be sufficiently great. For instance, the momentum of an arrow shot from a bow must be greater than that of a stone thrown by the hand.

## CAROLINE.

We know also by experience, that the heavier a body is, the greater is its force, if it act in other respects under the same circumstances. It is, therefore, not difficult to comprehend that the whole power or momentum of a body must be composed of these two properties. But I do not understand why they should be *multiplied*, the one by the other. I should have supposed that these quantities should have been *added* together.

## MRS. B.

It is found by experiment, that if the weight of a body be represented by the number 3, and its velocity also by 3, its momentum will be represented by 9; not 6, as would be the case were these figures added, instead of being multiplied together. The same conclusion may very easily be deduced by reasoning. If two bodies, one of 1 lb. weight, the other of 2 lbs., have the same velocity, the moving force of the second body is double that of the first. If a third body, of 2 lbs. also, move with three times the velocity of the second, its momentum (the weight being in this case equal) is three times that of the second. But the momentum, or moving force, of the second is twice that of the first; therefore the momentum of the third is three times this quantity, or six times that of the first. By thus



dividing the process, and looking first to the effect of a change of velocity, and afterwards to that of a change of weight, it becomes evident that these effects are to be *multiplied* together. I recommend you to be careful in remembering the definition of the momentum of bodies, as it is one of the most important points in mechanics: you will find that it is from opposing motion to matter that machines derive their powers.\*

The *re-action* of bodies is the next law of motion which I must explain to you. When a body in motion strikes against another body, it meets with resistance from it; the resistance of the body at rest will be equal to the blow struck by the body in motion; or, to express myself in philosophical language, *action* and *re-action* will be equal, and in opposite directions.

CAROLINE.

Do you mean to say that the action of the body which strikes is returned with equal force by the body which receives the blow?

\* In comparing together the momenta of different bodies, we must be attentive to measure their weights and velocities by the same denomination of weights and of spaces, otherwise the results would not agree. Thus, if we estimate the weight of one body in ounces, we must estimate the weight of the rest also in ounces, and not in pounds; and in computing the velocities, in like manner we should adhere to the same standard of measure, both of space and of time; as, for instance, the number of feet in one second, or of miles in one hour.

MRS. B.

Exactly so.

CAROLINE.

But if a man strike another on the face with his fist, he surely does not receive as much pain by the re-action, as he inflicts by the blow?

MRS. B.

No; but this is simply owing to the knuckles having much less feeling than the face.

Here are two ivory balls suspended by threads (Plate I. fig. 3.); draw one of them, A, a little on one side, — now let it go; — it strikes, you see, against the other ball, B, and drives it off, to a distance equal to that through which the first ball fell; but the motion of A is stopped, because, when it struck B, it received in return a blow equal to that which it gave, and its motion was consequently destroyed.

EMILY.

I should have supposed that the motion of the ball A was destroyed because it had communicated all its motion to B.

MRS. B.

It is perfectly true, that when one body strikes against another, the quantity of motion communicated to the second body is lost by the first; but this loss proceeds from the re-action of the body which is struck.

Here are six ivory balls hanging in a row (fig. 4.); draw the first out of the perpendicular, and let it fall against the second. None of the balls appear to move, you see, except the last, which flies off as far as the first ball fell. Can you explain this?

CAROLINE.

I believe so. When the first ball struck the second, it received a blow in return, which destroyed its motion. The second ball, though it did not appear to move, must have struck against the third, the re-action of which set it at rest; the action of the third ball must have been destroyed by the re-action of the fourth, and so on, till motion was communicated to the last ball, which, not being re-acted upon, flew off.

MRS. B.

Very well explained. Observe, that it is only when bodies are elastic, as these ivory balls are, that this effect takes place. I will show you the difference with these two balls of clay (fig. 5.), which are not elastic. When you raise one of these, D, out of the perpendicular, and let it fall against the other, E, the action and re-action not being augmented by the force of elasticity, is insufficient to destroy the motion of the former; only part of the motion of D will be communicated to E, and the two balls will move on

together to *d* and *e*, which are less distant from the vertical line than the ball *D* was before it fell.

Observe how useful re-action is in nature. Birds, in flying, strike the air with their wings, and it is the re-action of the air which enables them to rise, or advance forwards; re-action being always in a contrary direction to action.

CAROLINE.

I thought that birds might be lighter than the air, when their wings were expanded, and by that means enabled to fly.

MRS. B.

When their wings are spread, they are better supported by the air, as they cover a greater extent of surface; but they are still too heavy to remain in that situation without continually flapping their wings, as you may have noticed when birds hover over their nests. The force with which their wings strike against the air must equal the weight of their bodies, in order that the re-action of the air may be able to support that weight; the bird will then remain stationary. If the stroke of the wings be greater than is required merely to support the bird, the re-action of the air will make it rise; if it be less, it will gently descend: and you may have observed the lark, sometimes remaining with its wings extended, but motionless; in this state it drops rapidly into its nest.

CAROLINE.

What a beautiful effect this is of the law of re-action ! But if flying be merely a mechanical operation, Mrs. B., why should we not, like Prince Rasselas, construct wings adapted to the size of our bodies, fasten them to our shoulders, move them with our arms, and soar into the air ?

MRS. B.

Such an experiment has been repeatedly attempted, but never with success ; and it is now considered as totally impracticable. The muscular power of birds is greater in proportion to their weight than that of man ; were we, therefore, furnished with wings sufficiently large to enable us to fly, we should not have strength to put them in motion.

CAROLINE.

But, Mrs. B., a bird in flying moves its wings both backwards and forwards, and must, therefore, strike the air alternately in two opposite directions. It appears to me, therefore, that there would also be two re-actions in opposite directions, which would counteract each other, and prevent the bird from proceeding.

MRS. B.

Let us suppose the bird to fly upwards. It is true that it is only the downward stroke of his wings which can make him rise ; and that when he elevates his wings they strike against the air above

him, the re-action of which would make him descend. In order to prevent this, the bird folds in his wings when he raises them ; whilst he again expands them and spreads out the feathers when he gives the downward stroke which is to make him rise.

CAROLINE.

And in whatever direction he flies, then, he expands his wings when he gives the stroke the re-action of which is to impel him onward, and contracts them when in the opposite direction. And the swimming of fishes, is, I imagine, on the same principle.

MRS. B.

Yes, the fins of fishes are expanded and contracted in a similar manner ; and a man in swimming strikes his hands out to produce the re-action which impels him forward, and turns them edgewise to lessen the effect of the contrary re-action. In rowing, the oars you know are lifted out of the water after every stroke, so as completely to prevent any re-action in a backward direction ; and even in moving them through the air, they are turned edgewise, or feathered, as it is called, from its resemblance to the action of the feathers of a bird in flying.

EMILY.

Pray what bodies are elastic besides those you have mentioned ?

MRS. B.

In speaking of the air, I think we defined elasticity to be a property, by means of which bodies that are compressed return to their former state. If I bend this cane, as soon as I leave it at liberty it recovers its former position ; if I press my finger upon your arm, as soon as I remove it, the flesh, by virtue of its elasticity, rises and destroys the impression. Of all bodies the air is the most eminent for this property, and it has hence obtained the name of elastic fluid. Hard bodies are in the next degree elastic : if two ivory or metallic balls be struck together, the parts at which they touch will be flattened ; but their elasticity will make them instantaneously resume their former shape.

CAROLINE.

But when two ivory balls strike against each other, as they constantly do on a billiard table, no mark or impression is made by the stroke.

MRS. B.

I beg your pardon ; but you cannot perceive any mark, because their elasticity instantly destroys all trace of it. If, however, a very small spot of ink be placed on one of the balls at the point of contact, it will be found to have spread, and will thus show that there has been compression.

Soft bodies, which easily retain impressions,

such as clay, wax, tallow, butter, &c., have very little elasticity. Liquids, which are but very slightly compressible, may also be reckoned among the least elastic bodies.

EMILY.

If sealing-wax were elastic, instead of retaining the impression of a seal, it would resume a smooth surface as soon as the weight of the seal was removed. But, pray, what is it that produces the elasticity of bodies?

MRS. B.

There is great diversity of opinion upon that point, and I cannot pretend to decide which approaches nearest to the truth. Elasticity implies susceptibility of compression, and the susceptibility of compression depends upon the porosity of bodies; for were there no pores or spaces between the particles of matter of which a body is composed, it could not be compressed.

CAROLINE.

That is to say, that if the particles of bodies were as close together as possible, they could not be squeezed closer.

EMILY.

Bodies, then, whose particles are most distant from each other must be most susceptible of compression, and, consequently, most elastic; and this,



you say, is the case with air, which is, perhaps, the least dense of all bodies ?

MRS. B.

You will not in general find this rule hold good : for liquids have scarcely any elasticity, whilst hard bodies are eminent for this property ; though the latter are certainly of much greater density than the former. Elasticity implies, therefore, not only a susceptibility of compression, but depends upon the power of resuming its former state after compression.

CAROLINE.

But surely there can be no pores in ivory and metals, Mrs. B. ; how, then, can they be susceptible of compression.

MRS. B.

The pores of such bodies are invisible to the naked eye, but you must not thence conclude that they have none. It is, on the contrary, well ascertained that gold, one of the most dense of all bodies, is extremely porous, and that its pores are sufficiently large to admit water, under great pressure, to pass through them.

EMILY.

If water can pass through gold, there must certainly be pores or interstices which afford it a passage ; and if gold is porous, what must other bodies be, which are so much less dense than gold !

MRS. B.

The chief difference in this respect is, I believe, that the pores in some bodies are larger than in others. In cork, sponge, and bread, they form considerable cavities: in wood and stone, when not polished, they are generally perceptible to the naked eye: whilst in ivory, metals, and all varnished and polished bodies, they cannot be discerned. To give you an idea of the extreme porosity of bodies, Sir Isaac Newton conjectured that if the earth were so compressed as to be absolutely without pores, its dimensions might possibly not be more than a cubic inch.

CAROLINE.

What an idea! Were we not indebted to Sir Isaac Newton for the theory of attraction, I should be tempted to laugh at him for such a supposition. What insignificant little creatures we should be!

MRS. B.

If our consequence arose from the size of our bodies, we should indeed be but pigmies; but remember that the mind of Newton was not circumscribed by the dimensions of its material covering.

EMILY.

It is, however, fortunate that heat keeps the pores of matter open and distended, and prevents

the attraction of cohesion from squeezing us into a nutshell.

MRS. B.

Let us now return to the subject of re-action, on which we have some further observations to make. It is re-action being contrary to action which produces *reflected motion*. If you throw a ball against the wall, it rebounds: this return of the ball is owing to the re-action of the wall against which it struck, and is called *reflected motion*.

EMILY.

And I now understand why balls filled with air rebound better than those which are stuffed with bran or wool: the elasticity of the air re-acts after compression, so that the action and re-action are increased.

CAROLINE.

I have observed that when I throw a ball straight against the wall, it returns straight to my hand; but if I throw it obliquely upwards, it rebounds still higher, and I catch it when it falls.

MRS. B.

You should not say straight, but perpendicularly against the wall: for straight is a general term for lines in all directions which are neither curved nor bent, and is, therefore, equally applicable to oblique or perpendicular lines.

CAROLINE.

I thought that perpendicular meant either directly upwards or downwards.

MRS. B.

In those directions, lines are perpendicular to the earth. A perpendicular line has always a reference to something towards which it is perpendicular; that is to say, that it inclines neither to the one side nor the other, but makes an equal angle on either side. Do you understand what an angle is?

CAROLINE.

Yes, I believe so: it is two straight lines meeting in a point.

MRS. B.

Well, then, let the line *AB* (Plate II. fig. 1.) represent the floor of the room, and the line *CD* the direction in which you throw a ball against it: the line *CD*, you will observe, forms two angles with the line *AB*, and those two angles are equal.

EMILY.

How can the angles be equal, while the lines which compose them are of unequal length?

MRS. B.

An angle is not measured by the length of the lines, but by their opening.

EMILY.

Yet the longer the lines are, the greater is the opening between them.

MRS. B.

Take a pair of compasses, and draw a circle over these angles, making the angular point the centre.

EMILY.

To what extent must I open the compasses?

MRS. B.

You may draw the circle what size you please, provided that it cuts both the lines of the angle we are to measure. All circles, of whatever dimensions, are supposed to be divided into 360 equal parts, called degrees; the opening of an angle being therefore a portion of a circle, must contain a certain number of degrees; the larger the angle the greater the number of degrees; and two angles are said to be equal when they contain an equal number of degrees.

EMILY.

Now I understand it. As the dimensions of an angle depend upon the number of degrees contained between its lines, it is the opening, and not the length of its lines, which determines the size of the angle.



Fig. 1.

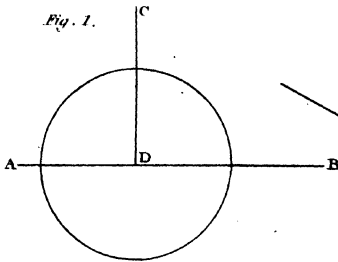


Fig. 2.

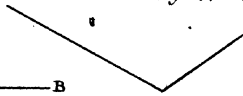


Fig. 4.

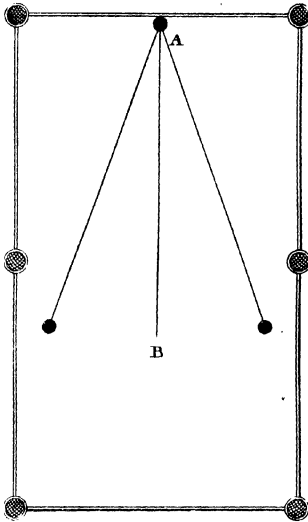


Fig. 3.

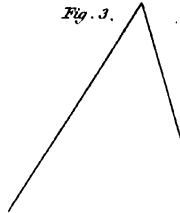


Fig. 5.

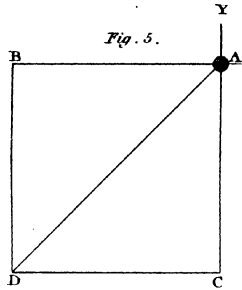


Fig. 6.

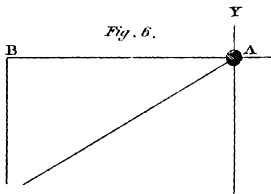
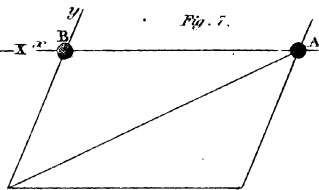


Fig. 7.



MRS. H.

Very well. Since you have a clear idea of the dimensions of angles, can you tell me how many degrees are contained in the two angles formed by one line falling perpendicularly on another, as in the figure I have just drawn?

EMILY.

You must allow me to put one foot of the compasses at the point of the angles, and draw a circle round them, and then I think I shall be able to answer your question: the two angles are together just equal to half a circle; they contain, therefore, 90 degrees each; 90 being a quarter of 360.

MRS. B.

An angle of 90 degrees is called a right angle; and when one line is perpendicular to another, it forms, you see (Plate II. fig. 1.), a right angle on either side. Angles containing more than 90 degrees are called obtuse angles (fig. 2.); and those containing less than 90 degrees are called acute angles (fig. 3.).

CAROLINE.

The angles of this square table are right angles, but those of the octagon table are obtuse angles; and the angles of sharp-pointed instruments are acute angles.



MRS. B.

Very well. To return now to your observation, that if a ball be thrown obliquely against the wall, it will not rebound in the same direction; — tell me, have you ever played at billiards?

CAROLINE.

Yes, frequently; and I have observed that when I push the ball perpendicularly against the cushion, it returns in the same direction; but when I send it obliquely to the cushion, it rebounds obliquely on the opposite side; the ball in this latter case describes an angle, the point of which is at the cushion. I have observed, also, that the more obliquely the ball is struck against the cushion, the more obliquely it rebounds on the opposite side, so that a billiard player can calculate with great accuracy in which direction it will return.

MRS. B.

Very well. This figure (fig. 4. Plate II.) represents a billiard table: now, if a line, A B, be drawn perpendicular to the cushion from the point where the ball A strikes, it will divide the angle which the ball describes into two parts, or two angles; the one will show the obliquity of the direction of the ball in its passage towards the cushion, the other its obliquity in its passage back from the cushion. The first is called *the angle of incidence*, the other *the angle of reflection*, and these angles are always equal.

CAROLINE.

I have observed that when I throw a ball obliquely against the wall, it rebounds in an opposite oblique direction, forming equal angles of incidence and of reflection.

MRS. B.

Certainly ; and you will find that the more obliquely you throw the ball, the more obliquely it will rebound.

We must now conclude ; but I shall have some further observations to make upon the laws of motion at our next meeting. .

## CONVERSATION IV.

## ON COMPOUND MOTION.

COMPOUND MOTION, THE RESULT OF TWO OPPOSITE FORCES. — OF CIRCULAR MOTION, THE RESULT OF TWO FORCES, ONE OF WHICH CONFINES THE BODY TO A FIXED POINT. — CENTRE OF MOTION, THE POINT AT REST WHILE THE OTHER PARTS OF THE BODY MOVE ROUND IT. — CENTRE OF MAGNITUDE, THE MIDDLE OF A BODY. — CENTRIPETAL FORCE, THAT WHICH CONFINES A BODY TO A FIXED CENTRAL POINT. — CENTRIFUGAL FORCE, THAT WHICH IMPELS A BODY TO FLY FROM THE CENTRE. — FALL OF BODIES IN A PARABOLA. — CENTRE OF GRAVITY, THE CENTRE OF WEIGHT, OR POINT ABOUT WHICH THE PARTS BALANCE EACH OTHER.

MRS. B.

I MUST now explain to you the nature of compound motion. Let us suppose a body to be struck by two equal forces in opposite directions, how will it move?

EMILY.

If the directions of the forces are in exact opposition to each other, I suppose the body will not move at all.

MRS. B.

You are perfectly right. But if the forces, instead of acting in opposition to the body, strike it in two directions inclined to each other at an angle of 90 degrees,—if, for instance, the ball A (fig. 5. Plate II.) be struck by equal forces at X and at Y,—will it not move?

EMILY.

The force at X would send it towards B, and the force at Y towards C; and since these forces are equal, I do not know how the body can obey one impulse rather than the other; and yet I think the ball would move, because, as the two forces do not act in direct opposition, they cannot entirely destroy the effect of each other.

MRS. B.

Very true. The ball will, therefore, follow the direction of neither of the forces, but will move in a line between them, and will reach D in the same space of time that the force at X would have sent it to B, and the force at Y would have sent it to C. Now, if you draw two lines from D to join B and C, you will form a square, and the oblique line which the body describes is called the diagonal of the square.

CAROLINE.

That is very clear; but supposing the two forces to be unequal, that the force at X, for instance, be twice as great as the force at Y?

MRS. B.

Then the force at X would drive the ball twice as far as the force at Y: consequently you must draw the line AB (fig. 6.) twice as long as the line AC: the body will in this case move to D; and if you draw lines from that point to B and C, you will find that the ball has moved in the diagonal of a rectangle.

EMILY.

Allow me to put another case. Suppose the two forces to be unequal, but not to act on the ball in the direction of a right angle, but in that of an acute angle, what will be the result?

MRS. B.

Prolong the lines in the directions of the two forces, and you will soon discover which way the ball will be impelled; it will move from A to D, in the diagonal of a parallelogram (fig. 7.). Forces acting in the direction of lines forming an obtuse angle, will also produce motion in the diagonal of a parallelogram. For instance, if the body set out from B, instead of A, and were impelled by the forces at X and at Y, it would move in the dotted diagonal BC.

We may now proceed to circular motion : this is the result of the action of two forces on a body, by one of which it is projected forward in a right line, whilst by the other it is directed towards a fixed point. For instance, when I whirl this ball, which is fastened to my hand with a string, the ball moves in a circular direction ; because it is acted on by two forces, — that which I give it, which represents the force of projection, and that of the string, which confines it to my hand. If during its motion you were suddenly to cut the string, the ball would fly off in a straight line : being released from confinement to the fixed point, it would be acted on but by one force ; and motion produced by one force, you know, is always in a right line.

CAROLINE.

This is a little more difficult to comprehend than compound motion in straight lines.

MRS. B. -

You have seen a mop trundled, and have observed, that the threads which compose the head of the mop fly from the centre ; but being confined to it at one end, they cannot part from it ; whilst the water they contain, being unconfined, is thrown off in straight lines.

EMILY.

In the same way, the flyers of a windmill, when put in motion by the wind, would be driven

straight forward in a right line, were they not confined to a fixed point, round which they are compelled to move.

MRS. B.

Very well. And observe, that the point to which the motion of a small body, such as the ball with the string, is confined, becomes the centre of its motion; for it may be considered as moving in the same plane, or the same level surface. But when a body is not of a size or shape to allow of our considering every part of it as moving in the same plane, it in reality revolves round a line, which is called the *axis of motion*. In a top, for instance, when spinning on its point, the axis is the line which passes through the middle of it, perpendicularly to the floor.

CAROLINE.

The axle of the flyers of the windmill is then the axis of its motion. But is the centre of motion always in the middle of a body?

MRS. B.

No, not always. The middle point of a body is called its centre of magnitude; that is, the centre of its mass or bulk. Bodies have also another centre, called the centre of gravity, which I shall explain to you; but at present, we must confine ourselves to the axis of motion. This line, you must observe, remains at rest, whilst all the other parts of the body move around it; when you spin

a top, for instance, the axis is stationary, whilst every other part is in motion round it.

CAROLINE.

But a top generally has a motion forwards, besides its spinning motion; and then no point within it can be at rest.

MRS. B.

What I say of the axis of motion relates only to circular motion; that is, to motion round a line, and not to that which a body may have at the same time in any other direction. There is one circumstance in circular motion which you must carefully attend to: it is, that the further any part of a body is from the axis of motion, the greater is its velocity; as you approach that line, the velocity of the parts gradually diminishes till you reach the axis of motion, which is perfectly at rest.

CAROLINE.

But if every part of the same body did not move with the same velocity, that part which moved quickest must be separated from the rest of the body, and leave it behind.

MRS. B.

You perplex yourself by confounding the idea of circular motion with that of motion in a right line. You must think only of the motion of a body round a fixed line; and you will find that if the parts farthest from the centre had not the



greatest velocity, those parts would not be able to keep up with the rest of the body, and would be left behind. Do not the extremities of the vanes of a windmill move over a much greater space than the parts nearest the axis of motion? (Plate III. fig. 1.) The three dotted circles describe the paths in which three different parts of the vanes move; and, though the circles are of different dimensions, the vanes describe each of them in the same space of time.

CAROLINE.

Certainly they do; and I now only wonder, that we neither of us ever made the observation before: and the same effect must take place in a solid body, like the top in spinning: the most bulging part of the surface must move with the greatest rapidity.

MRS. B.

The force which confines a body to a centre round which it moves, is called the *centripetal* force; and that force which impels a body to fly from the centre, is called the *centrifugal* force: in circular motion, these two forces constantly balance each other; otherwise the revolving body would either approach the centre, or recede from it, according as the one or other prevailed.

CAROLINE.

When I see any body moving in a circle, I shall remember that it is acted on by two forces.

Fig. 1.

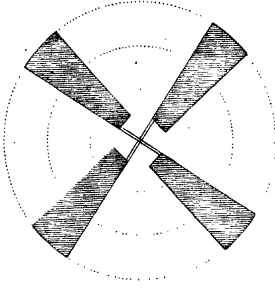


Fig. 2.

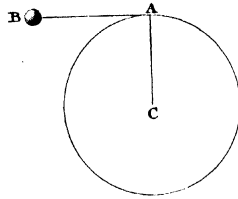


Fig. 5.

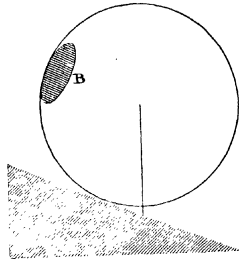


Fig. 3.

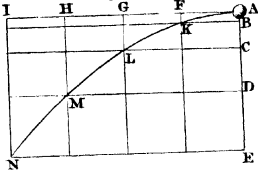


Fig. 7.

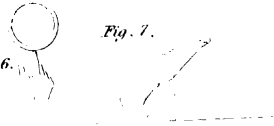


Fig. 4.

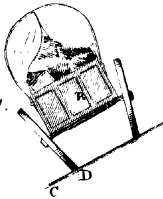


Fig. 6.

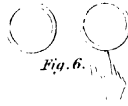


Fig. 8.



Fig. 9.

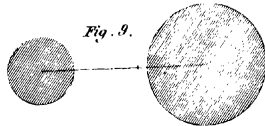
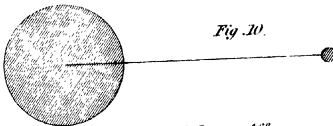


Fig. 10.





MRS. B.

Motion, either in a circle, an ellipsis, or any other curved line, must be the result of the action of two forces; for you know, that the impulse of a single force always produces motion in a right line.

EMILY.

And if any cause should destroy the centripetal force, the centrifugal force would alone impel the body, and it would, I suppose, fly off in a straight line from the centre to which it had been confined.

MRS. B.

It would not fly off in a right line from the centre; but in a right line in the direction in which it was moving at the instant of its release. If a stone whirled round in a sling gets loose at the point A (Plate III. fig. 2.), it flies off in the direction AB: this line is called a *tangent*; it touches the circumference of the circle, and forms a right angle with a line drawn from that point of the circumference to the centre of the circle C: this force would, therefore, with more propriety, be called the tangential than the centrifugal force. Or, rather, the inertia of the body, which inclines it to move in the direction of the tangent, is the tangential force. But motion in the direction of the tangent would remove the body farther from the centre: a tendency, therefore, to such motion, is a tendency to leave the centre; and that part of its force which

tends to produce motion thus, away from the centre, is called the centrifugal force.

EMILY.

You say that motion in a curved line is owing to two forces acting upon a body : but when I throw this ball in a horizontal direction, it describes a curved line in falling ; and yet it is only acted upon by the force of projection : there is no centripetal force to confine it, or produce compound motion.

MRS. B.

A ball thus thrown is acted upon by no less than three forces : the force of projection, which you communicate to it ; the resistance of the air through which it passes ; and the force of gravity, which finally brings it to the ground. The power of gravity, and the resistance of the air being always greater than any force of projection we can give a body, the latter is gradually overcome, and the body brought to the ground ; but the stronger the projectile force, the longer will these powers be in subduing it, and the further the body will go before it falls.

CAROLINE.

A shot fired from a cannon, for instance, goes much further than a stone thrown by the hand.

MRS. B.

Bodies thus projected, you observed, described a curved line in their descent : can you account for that ?

CAROLINE.

No ; I do not understand why it should not fall in the diagonal of a square.

MRS. B.

If the two forces which act upon the ball both produced uniform motion, it would move in the diagonal of a parallelogram ; but the force of projection alone is uniform, that of gravity is accelerated ; and it is this acceleration which brings the ball sooner to the ground, and makes it fall in a curved instead of a straight line. To understand this more fully, you must consult the diagram. (Plate III. fig. 3.)

If a ball at A be projected, in a horizontal direction, with a force capable of carrying it to F' (which we will suppose to be 64 feet) in a second, then, if it were not acted upon by gravity, it would proceed from F to G, another 64 feet, in the next second, and the same distance G H, in a third, and H I, in a fourth second. Now if the ball, when at A, be allowed to fall, by the force of gravity alone, from A towards E, it will fall 16 feet to B during the first second\* ; then three times as much, or 48 feet, the next second ; and five times as much, or 80 feet, in the third second ; and seven times as much, or 112 feet, in the fourth second.

Then, in order to find the line in which the ball will move, by the united forces of projection and gravity, we must draw a line BK, parallel to the

\* See page 62.

horizontal line  $AF$ , and 16 feet below it: then another line,  $CL$ , also parallel, at the distance of 48 feet more; then another line,  $DM$ , 80 feet farther; then another,  $EN$ , 112 feet farther.

Now, at the end of the first second, the ball will be at  $K$ , at the same distance from  $B$  as  $F$  is from  $A$ ; at the end of the next second it will be at  $L$ , the same distance from  $C$  that  $G$  is from  $A$ ; at the end of the third second it will be at  $M$ ; and at the end of the fourth second at  $N$ ; and thus you see the curved line  $AKLMN$  is described in its fall.

I have not taken notice of the resistance of the air, which complicates these results in practice. The principles of its operation may easily be understood from the mode in which the other forces act; but the degree and manner in which it modifies their effects cannot be shown without much difficulty and intricacy of explanation.

#### EMILY.

It is plain, however, that the resistance of the air diminishes with the velocity of the ball, for the particles of the air must re-act on the ball in proportion to the stroke they receive from it; so that, if you double the force of projection, you, at the same time, double the resistance of the air.

#### MRS. B.

Nor is this all: for you must observe, that in doubling the velocity of the ball, you make it pass

through twice the quantity of air in the same time ; let us say a minute, for example ; and since it receives twice the resistance from each particle, the whole of the resistance must be four times as great as in the first instance.

CAROLINE.

Very true ; and if you give the ball three times the velocity, it will pass through three times the quantity of air ; will strike each particle with three times the force, and receive three times the re-action : which summed up will make nine times the resistance : is it not so ?

MRS. B.

Yes ; but a shorter mode of calculating the resistance is to multiply the velocity by itself : thus, if the velocity be three, multiply it by three, and the product will be nine. The product of a number multiplied by itself is called its square : thus, you see, “ the resistance of the air increases as the square of the velocity.”

It is owing to the resistance of the air increasing so much more rapidly than the velocity of a falling body, that all bodies falling from a great height attain a uniform velocity before they reach the earth.

CAROLINE.

I am glad to hear that, Mrs. B. ; otherwise, after what you have told us about the accelerated



motion of falling bodies, I should hardly have dared face a hail-storm ; but now I see why the hail-stones fall so much less rapidly, and do so much less mischief than I should have expected.

Look, Emily, as I throw this ball directly upwards, how the resistance of the air and gravity conquers projection. Now I will throw it upwards obliquely. See, the force of projection enables it, for an instant, to act in opposition to that of gravity ; but it is soon brought down again.

MRS. B.

The curved line which a ball describes in falling is (if the resistance of the air be not taken into account) called in geometry a parabola. But when the ball is thrown perpendicularly upwards, it will descend perpendicularly ; because the force of projection, and that of gravity, are in the same line of direction.

We have noticed the centres of magnitude and of motion ; but I have not yet explained to you what is meant by the centre of gravity. It is that point about which all the parts of a body exactly balance each other ; if, therefore, that point be supported, the body will not fall. Do you understand this ?

EMILY.

I think so. If the parts round about this point have an equal tendency to fall, they will be in

equilibrium : and as long as this point is supported, the body cannot fall.

MRS. B.

Caroline, what would be the effect, were any other point of the body alone supported?

CAROLINE.

The surrounding parts no longer balancing each other, the body, I suppose, would fall on the side at which the parts are heaviest.

MRS. B.

Infallibly ; whenever the centre of gravity is unsupported, the body must fall. This sometimes happens with an overloaded waggon winding up a steep hill, one side of the road being more elevated than the other : suppose it to slope as described in this figure (Plate III. fig. 4.) ; let us say, that the centre of gravity of this loaded waggon is at the point A. Now your eye will tell you, that a waggon thus situated will overset ; the reason of which is, that the centre of gravity, A, is not supported ; for if you draw a perpendicular line from it to the ground at C, it does not fall under the waggon within the wheels, and is, therefore, not supported by them.

A perpendicular line thus drawn from the centre of gravity to the earth is called the line of direction.

CAROLINE.

I understand that perfectly: but what is the meaning of the other point, B?

MRS. B.

Let us imagine the upper part of the load to be taken off; the centre of gravity will then change its situation, and descend to B, as that will now be the point about which the parts of the less heavily laden waggon will balance each other. Will the waggon now be upset?

CAROLINE.

No; because a perpendicular line from that point falls within the wheels at D, and is supported by them; and when the centre of gravity is supported, the body will not fall.

EMILY.

Yet I should not much like to pass a waggon in that situation; for, as you see, the point D is but just within the left wheel. If the right wheel were merely raised, by passing over a stone, the point D would be thrown on the outside of the left wheel, and the waggon would upset.

CAROLINE.

A waggon, or any carriage whatever, will then be most firmly supported, when the centre of gra-

vity falls exactly between the wheels; and that is the case in a level road.

MRS. B.

You have heard how dangerous it is, when a boat is in any risk of being upset, for the passengers to rise suddenly; this is owing to their raising the centre of gravity, and thus increasing the chance of throwing it out of the line of direction.

When you stand upright the centre of gravity of your body is supported by the feet. If you lean on one side, you will find that you no longer stand firm. A rope-dancer performs all his feats of agility, by dexterously supporting his centre of gravity; whenever he finds himself in danger of losing his balance, he shifts the heavy pole, which he holds in his hands, in order to throw the weight towards the side that is deficient, and thus, by changing the situation of the centre of gravity, restores his equilibrium.

CAROLINE.

When a stick is poised on the tip of the finger, is it not by supporting its centre of gravity?

MRS. B.

Yes; and it is for want of this support, that spherical bodies roll down a slope. A sphere

being perfectly round, can touch the slope but by a single point, and that point cannot be perpendicularly under the centre of gravity, and therefore cannot be supported, as you will perceive by examining this figure. (Plate III. fig. 5.)

EMILY.

So it appears. Yet I have seen a cylinder of wood roll up a slope; how is that contrived?

MRS. B.

It is done by plugging one side of the cylinder with lead, as at B (Plate III. fig. 5.); the body being no longer of an uniform density, the centre of gravity is removed from the middle of the body to some point in the lead, as that substance is much heavier than wood. Now you may observe, that in order that the cylinder may roll down the plane, as it is here situated, the centre of gravity must rise, which is impossible. The centre of gravity must always descend in moving, and will descend by the nearest and readiest means, which will be by forcing the cylinder up the slope, until the centre of gravity is supported, and then it stops.

CAROLINE.

The centre of gravity, therefore, is not always in the middle of a body?

MRS. B.

No: that point we have called the centre of magnitude. When the body is of an uniform density, the centre of gravity is in the same point; but when one part of the body is composed of heavier material; than another part, the centre of gravity, being the centre of the weight of the body, can no longer correspond with the centre of magnitude. Thus you see the centre of gravity of this cylinder plugged with lead cannot be in the same spot as the centre of magnitude. The centre of gravity is sometimes so situated as not to be within the body, but in empty space.

CAROLINE.

I thought that the centre of gravity was always the heaviest part of a body, and the heaviest part cannot be in empty space.

MRS. B.

Your idea of the centre of gravity was incorrect; we defined it to be that point about which all the parts of a body balance each other; you must consider it as an abstract point, since there are cases in which it may be situated at some distance from the body. Where, for instance, is the centre of gravity of a ring?

CAROLINE.

True; it must be in the centre of the space which the ring encircles. But, Mrs. B., if you support that point without touching the ring, you will not prevent it from falling.

MRS. B.

That point cannot be supported unless you hold the ring so that the line of direction will fall within the base of the support, which will be the case either if you poise the ring on the tip of your finger, or if you suspend it by a string, as in fig. 6.

If a body be suspended by that point in which the centre of gravity is situated, it will remain at rest in any position indifferently — but if it be suspended by any other point, it can rest only in two positions: can you tell me which these will be?

EMILY.

The body will rest only when the centre of gravity is either exactly above or below the point of suspension, so that the point of suspension shall be in the line of direction.

MRS. B.

Very well; hang up this piece of pasteboard on the nail, against the wall, by a loop at one of its corners; and now that it is at rest, and consequently we know that the centre of gravity is

directly below the point of suspension, draw a perpendicular line from that point to the ground, and it will pass through the centre of gravity.

EMILY.

Yes, but we shall not know in what part of the line it is situated.

MRS. B.

In order to ascertain that, you must hang up the pasteboard by some other part, and draw another perpendicular from the new point of suspension to the ground.

EMILY.

Ah, now I see how it is: the centre of gravity of the pasteboard must be situated in both these lines; and as there is but one point in which they meet and cross each other, in that point must be the centre of gravity. This is an excellent mode discovering the centre of gravity of bodies.

MRS. B.

But observe, that it is calculated only for bodies of no considerable thickness.

EMILY.

Bodies that consist but of one kind of substance, as wood, stone, or lead, and whose densities are consequently uniform, must stand more firmly, and be more difficult to overset, than bodies composed



of a variety of substances, of different densities, which may throw the centre of gravity on one side.

MRS. B.

True; but if, without throwing the centre of gravity on one side, the heaviest materials were in the lower part of the body, it would stand more firmly for not being homogeneous. But there is another circumstance which more materially affects the firmness of their position; and that is their form. Bodies that have a narrow base, are easily upset; for if they are the least inclined, their centre is no longer supported, as you may perceive in fig. 7.

CAROLINE.

I have often observed with what difficulty a person carries a single pail of water; it is owing, I suppose, to the centre of gravity being thrown on one side, and the opposite arm is stretched out to endeavour to bring it back to its original situation. But a pail hanging on each arm is carried without difficulty, because they balance each other, and the centre of gravity remains supported by the feet.

MRS. B.

Very well. I have but one more remark to make on the centre of gravity, which is, that when two bodies are fastened together by a line, string, chain, or any power whatever, they are to

be considered as forming but one body. If the two bodies be of equal weight, the centre of gravity will be in the middle of the line which unites them (fig. 8.); but if one be heavier than the other, the centre of gravity will be proportionally nearer the heavy body than the light one. (Fig. 9.) If you were to carry a rod or pole with an equal weight fastened at each end of it, you would hold it in the middle of the rod, in order that the weights should balance each other; whilst, if it had unequal weights at each end, you would hold it nearest the greater weight, to make them balance each other.

EMILY.

And in both cases we should support the centre of gravity; and if one weight be very considerably larger than the other, the centre of gravity will be thrown out of the rod into the heaviest weight. (Fig. 10.)

MRS. B.

Undoubtedly.

## CONVERSATION V.

## ON THE MECHANICAL POWERS.

OF THE POWER OF MACHINES.—OF THE LEVER IN GENERAL. — OF THE LEVER OF THE FIRST KIND, HAVING THE FULCRUM BETWEEN THE POWER AND THE WEIGHT. — OF THE LEVER OF THE SECOND KIND, HAVING THE WEIGHT BETWEEN THE POWER AND THE FULCRUM. — OF THE LEVER OF THE THIRD KIND, HAVING THE POWER BETWEEN THE FULCRUM AND THE WEIGHT.

MRS. B.

WE may now proceed to examine the mechanical powers. They are six in number, one or more of which enters into the composition of every machine. The *lever*, the *pulley*, the *wheel* and *axle*, the *inclined plane*, the *wedge*, and the *screw*.

In order to understand the power of a machine, there are four things to be considered. 1st, The power that acts: this consists in the efforts of men or horses, of weights, springs, steam, &c.

2dly, The resistance which is to be overcome by the power; this is generally a weight to be moved. The power must always be superior to the resistance, otherwise the machine could not be put in motion.

CAROLINE.

If, for instance, the resistance of a carriage was equal to the strength of the horses employed to draw it, they would not be able to make it move.

MRS. B.

3dly, We are to consider the centre of motion, or, as it is termed in mechanics, the *fulcrum*, which means a prop; this, you may recollect, is the point about which all the parts of the body move. And, lastly, the respective velocities of the power, and of the resistance.

EMILY.

That must depend upon their respective distances from the axis of motion; as we observed in the motion of the vanes of the windmill.

MRS. B.

We shall now examine the power of the lever. The lever is an inflexible rod or beam, that is to say, one which will not bend in any direction. For instance, the steel rod to which these scales

are suspended is a lever, and the point by which it is suspended is the prop or fulcrum, which also is the centre of motion; now can you tell me why the two scales are in equilibrium?

CAROLINE.

Being both empty, and of the same weight, they balance each other.

EMILY.

Or, more correctly speaking, because the centre of gravity common to both is supported.

MRS. B.

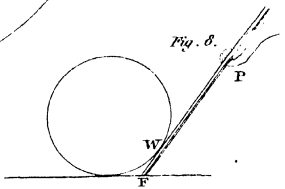
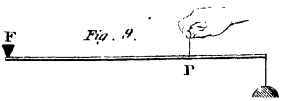
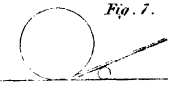
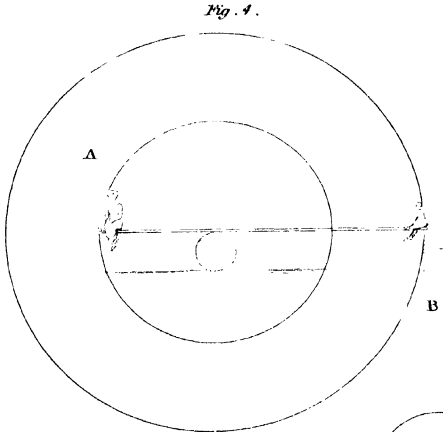
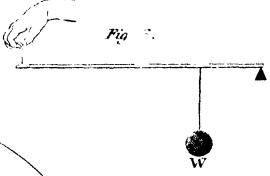
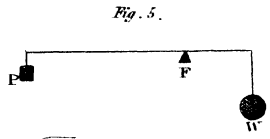
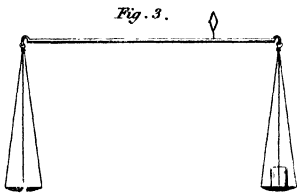
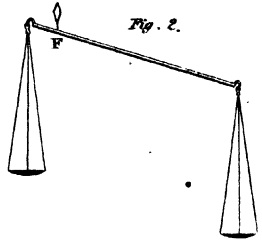
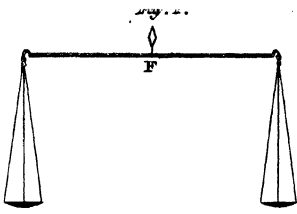
Whereabouts do you suppose the centre of gravity of this pair of scales to be? (Plate IV. fig. 1.)

EMILY.

You have told us that, when two bodies of equal weight were fastened together, the centre of gravity was in the middle of the line that connected them; the centre of gravity of the scales must therefore be in the fulcrum  $F$  of the lever which unites the two scales.

MRS. B.

You must recollect, that if a body be suspended by that point in which the centre of gravity is situated, it will remain at rest in any position indifferently; and that you see is not the case with this pair of scales, for when I hold them inclined, they instantly regain their equilibrium; the reason





of this is, that the centre of suspension, instead of exactly coinciding with that of gravity, is a little above it; if, therefore, the equilibrium of the scales be disturbed, the centre of gravity is forced to rise, and the instant it is restored to liberty, it descends and resumes its situation immediately below the point of suspension, when the equilibrium is restored. It is this property which renders the balance so accurate an instrument for weighing goods.

CAROLINE.

But if the scales contained different weights, the centre of gravity would be removed towards that scale which contained the heaviest weight; and since that point could no longer be supported, the heavy scale would descend.

MRS. B.

True; but tell me can you imagine any mode by which bodies of different weights can be made to balance each other, either in a pair of scales, or simply suspended to the extremities of the lever? for the scales or basins are not an essential part of the machine; they have no mechanical power, and are used merely for the convenience of containing the substance to be weighed.

CAROLINE.

What! make a light body balance a heavy one? I cannot conceive that possible.



MRS. B.

The fulcrum of this pair of scales (fig. 2.) is moveable, you see; I can take it off the prop, and fasten it on again in another part; this point is now become the fulcrum, but it is no longer in the centre of the lever.

CAROLINE.

And the balance is no longer true; for that which hangs on the longest side of the lever descends.

MRS. B.

The two parts of the lever divided by the fulcrum are called its arms; you should therefore say the longest arm, not the longest side of the lever. These arms are likewise frequently distinguished by the appellations of the acting and the resisting part of the lever.

Your observation is true, that the balance is now destroyed; but it will answer the purpose of enabling you to comprehend the power of a lever, the fulcrum of which is not in the centre.

EMILY.

This would be an excellent contrivance for those who cheat in the weight of their goods. By making the fulcrum a little on one side, and placing the goods in the scale which is suspended to the longest arm of the lever, they would appear to weigh more than they do in reality.

MRS. B.

You do not consider how easily the fraud would be detected; for, on the scales being emptied, they would not hang in equilibrium.

EMILY.

True; I did not think of that circumstance. But I do not understand why the longest arm of the lever should not be in equilibrium with the other.

CAROLINE.

It is because it is heavier than the shortest arm; the centre of gravity, therefore, is no longer supported.

MRS. B.

You are right; it is no longer directly below the point of suspension: but if we can contrive to bring the centre of gravity directly below that point as it is now situated, the scales must again balance each other; for you recollect that the centre of gravity is that point about which every part of the body is in equilibrium.

EMILY.

It has just occurred to me how this may be accomplished: let us place a great weight into the scale suspended to the shortest arm of the lever, a smaller one into that suspended to the longest arm. Yes, I have discovered it—look, Mrs. B.,

the scale on the shortest arm will carry 2 lbs., and that on the longest arm only one, to restore the balance. (Fig. 3.)

MRS. B.

You see, therefore, that it is not impracticable, as you imagined, to make a heavy body balance a light one; and this is, in fact, the means by which you thought an imposition in the weight of goods might be effected, as a weight of ten or twelve ounces might thus be made to balance a pound of goods.

EMILY.

Since a weight increases in power in proportion to its distance from the fulcrum, I should think that a balance might be contrived in which a single pound weight would answer the purpose of weighing any quantity of goods, simply by moving it along the lever; for in proportion as it receded from the fulcrum, it would balance 5, 10, 20, or perhaps even 100 lbs., were the lever sufficiently long.

MRS. B.

This ingenious idea, my dear Emily, has, I am sorry to say, occurred to others before you: but you will be consoled for not having the credit of the invention, by learning to what a degree of perfection the instrument you have imagined has already been brought. It is called a steel-yard;

and I have no doubt but that the housekeeper can supply us with one, as it is very commonly used for the purpose of weighing meat.

This hook by which the instrument is suspended forms the fulcrum: it is two inches distant from the basin which is to contain the articles to be weighed, while the opposite arm of the lever extends two feet: a small weight is suspended to it, and the graduations on the lever indicate the different powers of this weight according to the situation which it occupies on the long arm of the lever; when pushed to the extremity, a weight of 5 lbs. is, you see, equivalent to 60 lbs.

EMILY.

And yet it does not appear to weigh above a few ounces. But what is the meaning of this second hook, Mrs. B., which divides the lever with less inequality?

MRS. B.

This hook forms a second fulcrum corresponding with another scale of graduation. The steelyard, when suspended by this hook, is used for weighing smaller quantities of goods, and the same weight, when hung at the extremity, is equal only to 20 lbs.

Let us now return to the balance (fig. 2.), and we shall take off the basins suspended to the lever, in order to consider the lever simply; and in this

state you see that the fulcrum is no longer the line of direction of the centre of gravity; but it is, and must ever be, the centre of motion, as it is the only point which remains at rest, while the other parts move about it.

CAROLINE.

It now resembles the two opposite vanes of a windmill, and the fulcrum the point round which they move.

MRS. B.

In describing the motion of those vanes, you may recollect our observing that the farther a body is from the axis of motion, the greater is its velocity.

CAROLINE.

That I remember, and understood perfectly.

MRS. B.

You comprehend, then, that the extremity of the longest arm of a lever must move with greater velocity than that of the shortest arm?

EMILY.

No doubt; because it is farthest from the centre of motion. And pray, Mrs. B., when my brothers play at riding on a plank, is not the plank a kind of lever?

MRS. B.

Certainly; the log of wood on which the plank rests is the fulcrum, and those who ride repre-

sent the power and the resistance at each end of the lever. And have you not observed, that when those who ride are of equal weight, the plank must be supported in the middle to make the two arms equal? whilst, if they differ in weight, the plank must be drawn a little further over the prop to make the arms unequal, and the lightest person who represents the resistance, must be placed at the extremity of the longest arm.

CAROLINE.

That is always the case when I ride on a plank with my youngest brother. I have observed also that the lighter person has the best ride, as he moves both further and quicker; and I now understand that it is because he is more distant from the centre of motion.

MRS. B.

The greater velocity with which your little brother moves, renders his momentum equal to yours.

CAROLINE.

Yes; I have the most gravity, he the greatest velocity; so that upon the whole our momentums are equal.—But you said, Mrs. B., that the power should be greater than the resistance, in order to put the machine in motion; how then can the plank move, if the momentums of the persons who ride are equal?

MRS. B.

Because each person at his descent touches the ground with his feet ; and the support he receives from it diminishes his momentum, and enables the opposite rider to raise him. Thus each rider alternately represents the power and the weight, and the two arms alternately perform the function of the acting and the resisting part of the lever.

Did you ever observe that a lever describes the arc of a circle in its motion ?

EMILY.

No ; it appears to me to rise and descend perpendicularly ; at least I always thought so.

MRS. B.

I believe I must make a sketch of you and your brother riding on a plank, in order to convince you of your error. (Pl. IV. fig. 4.) You may now observe that a lever can move only round the fulcrum, since that is the centre of motion. It would be impossible for you to rise perpendicularly to the point A, or for your brother to descend in a straight line to the point B : you each describe arcs of your respective circles. This drawing shows you also how much superior his velocity must be to yours ; for if you could swing quite round, you would each complete your respective circles in the same time.

CAROLINE.

My brother's circle being much the largest, he must undoubtedly move the quickest.

MRS. B.

Now tell me, do you think that your brother could raise you as easily without the aid of a lever?

CAROLINE.

Oh, no; he could not lift me off the ground.

MRS. B.

Then I think you require no further proof of the power of a lever, since you see what it enables your brother to perform.

CAROLINE.

I now understand what you meant by saying, that, in mechanics, motion was opposed to matter; for it is my brother's velocity which counterbalances my weight.

MRS. B.

You may easily imagine what enormous weights may be raised by levers of this description; for the longer the acting part of the lever in comparison to the resisting part, the greater is the effect produced by it; because the greater is the velocity of the power compared to that of the weight. Have you never seen your brother roll over a heavy snow-ball (fig. 6.) by thrusting the end of a strong



stick beneath the ball, and resting it against a log of wood, or any object which can give it support, near the end in contact with the snow-ball? The stick, in this case, is a lever; the support, the prop or fulcrum; and the nearer the latter is to the resistance, the more easily will the power of your brother be able to move it.

There are three different kinds of levers; in the first, the fulcrum is between the power and the weight.

CAROLINE.

This kind then comprehends the several levers you have described.

MRS. B.

Yes. When, in levers of the first kind, the fulcrum is equally between the power and the weight, as in the balance, the power must be greater than the weight, in order to move it; for nothing can in this case be gained by velocity. The two arms of the lever being equal, the velocity of their extremities must be so likewise. The balance is, therefore, of no assistance as a mechanical power, but it is extremely useful to estimate the respective weight of bodies.

But when (fig. 5.) the fulcrum  $F$  of a lever is not equally distant from the power and the weight, and that the power  $P$  acts at the extremity of the longest arm, it may be less than the weight  $W$ , its

deficiency being compensated by its superior velocity; as we observed in the *see-saw*.

EMILY.

Then, when we want to raise a great weight, we must fasten it to the shortest arm of a lever, and apply our strength to the longest arm.

MRS. B.

If the case will admit of your putting the end of the lever under the weight, no fastening will be required; as you will perceive by stirring the fire.

EMILY.

Oh, yes; the poker is a lever of the first kind: the point where it rests against the bars of the grate, whilst I am stirring the fire, is the fulcrum; the short arm, or resisting part of the lever, is employed in lifting the weight, which is the coals; and my hand is the power applied to the longest arm, or acting part of the lever.

MRS. B.

Let me hear, Caroline, whether you can equally well explain this instrument, which is composed of two levers, united in one common fulcrum.

CAROLINE.

A pair of scissors!

MRS. B.

You are surprised ; but if you examine their construction, you will discover that it is the power of the lever that assists us in cutting with scissors.

CAROLINE.

Yes ; I now perceive that the point at which the two levers are screwed together, is the fulcrum ; the handles, to which the power of the fingers is applied, are the extremities of the acting part of the levers, and the cutting parts of the scissors are the resisting parts of the levers ; therefore, the longer the handles, and the shorter the points of the scissors, the more easily will they cut.

EMILY.

That I have often observed ; for when I cut pasteboard or any hard substance, I always make use of that part of the scissors nearest the screw or rivet, and I now understand why it increases the power of cutting : but I confess that I never should have discovered scissors to have been double levers. And, pray, are not snuffers levers of a similar description ?

MRS. B.

Yes, and most kinds of pincers ; the great power of which consists in the resisting part of the lever being very short in comparison of the acting part.

CAROLINE.

And of what nature are the two other kinds of levers?

MRS. B.

In levers of the second kind, the weight, instead of being at one end, is situated between the power and the fulcrum. (Fig. 6.)

CAROLINE.

The weight and the fulcrum have here changed places; and what advantage is gained by this kind of lever?

MRS. B.

In moving it, the velocity of the power must necessarily be greater than that of the weight, as it is more distant from the centre of motion. You have perhaps seen your brother move a snow-ball by means of a lever of the second order, as well as by one of the first.

CAROLINE.

Oh, yes. (Fig. 8.) The end of the stick, which he thrusts under the ball, rests on the ground, which becomes the fulcrum: the ball is the weight to be moved, and the power his hands applied to the other end of the lever. In this instance there is an immense difference in the length of the arms of the lever; for the weight is almost close to the fulcrum.

MRS. B.

And the advantage gained is proportioned to this difference. Fishermen's boats are by levers of this description raised from the ground to be launched into the sea, by means of slippery pieces of board, which are thrust under the keel. The most common example that we have of levers of the second kind is in the doors of our apartments.

EMILY.

The hinges represent the fulcrum, our hands the power applied to the other end of the lever; but where is the weight to be moved?

MRS. B.

The door is the weight, and it consequently occupies the whole of the space between the power and the fulcrum. The whole weight of the door may be regarded as collected into its centre of gravity; that is to say, the resistance of the door is the same that would be offered by a force equal to the weight of the door, and passing through its centre of gravity. Another very common instance is found in an oar; the blade is kept in the same place by the resistance of the water, and becomes the fulcrum; the resistance is applied where the oar passes over the side of the boat, and the hands at the handle are the power. Nutcrackers are also double levers of this kind: the hinge is the

fulcrum, the nut the resistance, and the hands the power.

In levers of the third kind (fig. 8.), the fulcrum is also at one of the extremities, the weight or resistance at the other, and it is now the power which is applied between the fulcrum and the resistance.

#### EMILY.

The fulcrum, the weight, and the power, then, each in their turn, occupy some part of the middle of the lever between its extremities. But in this third kind of lever, the weight being farther from the centre of motion than the power, the difficulty of raising it is increased instead of diminished.

#### MRS. B.

Levers of this kind are used only when the object is to produce great velocity. In general, the object in mechanics is to gain force by exchanging it for time; but it is, on the contrary, sometimes desirable to produce great velocity by an expenditure of force. The common turning lathe affords an example of a lever of the third kind, employed in gaining time or velocity at the expense of force. A man in raising a ladder perpendicularly against a wall cannot place his hands on the upper part of the ladder; the power, therefore, is necessarily much nearer the fulcrum than the weight.

CAROLINE.

True; the hands are the power, the ground the fulcrum, and the upper part of the ladder the weight.

MRS. B.

Yes; as in the case of the door, the weight may be considered as collected in the centre of gravity of the ladder, about half way up it, and consequently beyond the point where the hands are applied. Nature employs this kind of lever in the structure of the human frame. In lifting a weight with the hand, the lower part of the arm becomes a lever of the third kind; the elbow is the fulcrum; the muscles which move the arm, the power; and as these are nearer to the elbow than the hand, it is necessary that their power should exceed the weight to be raised.

EMILY.

Is it not surprising that nature should have furnished us with such disadvantageous levers?

MRS. B.

The disadvantage in respect to power is more than compensated by the convenience resulting from this structure of the arm. It is of more consequence that we should be able to move our limbs nimbly, than that we should be able to overcome great resistance with them, as it is comparatively

seldom that we meet with great obstacles, and when we do, they can be overcome by art. Besides the Creator has endowed the muscular fibres with prodigious strength, so that, upon the whole, this kind of lever is best adapted to enable the arm to perform its various functions.

We have dwelt so long on the lever, that we must reserve the examination of the other mechanical powers to our next interview.



## CONVERSATION VI.

## ON THE MECHANICAL POWERS.

OF THE PULLEY. — OF THE WHEEL AND AXLE. —  
 OF THE INCLINED PLANE. — OF THE WEDGE. — OF  
 THE SCREW.

MRS. B.

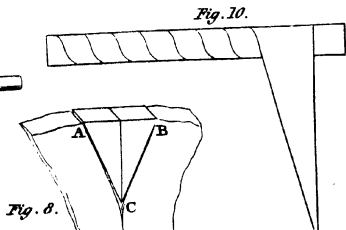
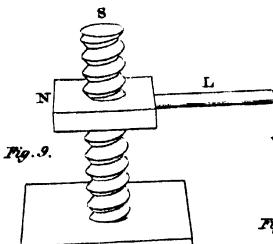
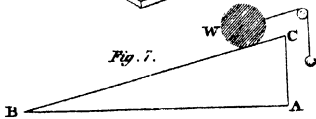
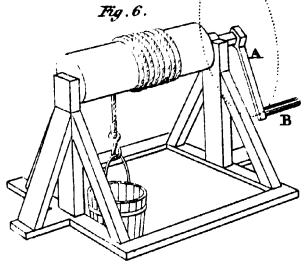
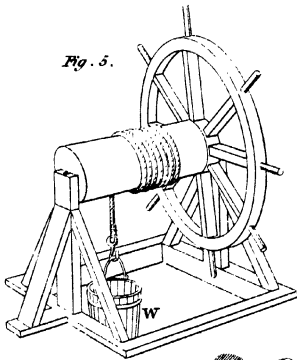
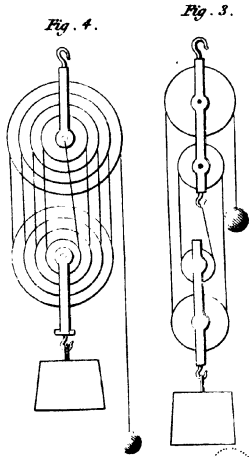
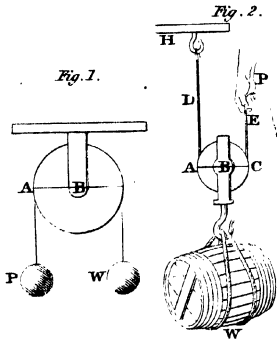
THE pulley is the second mechanical power we are to examine. You both, I suppose, have seen a pulley?

CAROLINE.

Yes, frequently: it is a circular and flat piece of wood or metal with a string running in a groove round it; by means of which, a weight may be pulled up. Thus pulleys are used for drawing up curtains, and sails of ships.

MRS. B.

Yes; but in these instances the pulleys are fixed, and do not increase the power to raise the weights, as you will perceive by this figure. (Plate V. fig. 1.) If P represents the power employed to raise the





weight  $W$ , the power must be greater than the weight in order to move it.

EMILY.

But since a fixed pulley affords us no mechanical aid, why is it used?

MRS. B.

Though it does not increase our power, it is frequently used for altering its direction. A single pulley enables us to draw *up* a curtain, by drawing *down* the string connected with it; and we should be much at a loss to accomplish this simple operation without its assistance.

CAROLINE.

There would certainly be some difficulty in ascending to the head of the curtain, in order to draw it up. Indeed, I now recollect having seen workmen raise small weights by this means, which seemed to answer a very useful purpose.

MRS. B.

The next figure represents a pulley which is not fixed (fig. 2.), and thus situated you will perceive that it affords mechanical assistance. Do you not think that the hand which sustains the cask by means of the cord  $DE$ , going over the moveable pulley, does it more easily than if it held the cask suspended to a cord without a pulley?

CAROLINE.

Yes; because the fixed hook H, to which one end of the cord is fastened, sustains one half of the weight; the hand, therefore, has only the other half to sustain.

MRS. B.

Very well; and the hook will afford the same assistance in raising the weight as in sustaining it: if the hand has but one half the weight to sustain, it will also have only one half the weight to raise; but observe, that, in raising it, the velocity of the hand must be double that of the cask; for in order to raise it one inch, the hand must draw the two strings (or rather the two parts into which the same string is divided, D and E) one inch each; the whole string is therefore shortened two inches, while the weight is raised only one.

EMILY.

That I understand. If P drew the string but one inch, the weight would be raised only half an inch, because it would shorten the string D and E half an inch each, and consequently the pulley with the weight attached to it could be raised only half an inch.

CAROLINE.

I am ashamed of my stupidity; but I confess that I do not understand this. It appears to me

that the weight would be raised as much as the string is shortened by the power.

MRS. B.

I will endeavour to explain it more clearly. I fasten this string to a chair, and draw it towards me: I have now shortened the string, by the act of drawing it, one yard.

CAROLINE.

And the chair, as I supposed, has advanced one yard.

MRS. B.

This exemplifies the nature of a single fixed pulley only. Now unfasten the string, and replace the chair where it stood before. In order to represent the moveable pulley, we must draw the chair forwards by putting the string round it; one end of the string may be fastened to the leg of the table (which will represent the fixed hook H), and I shall draw the chair by the other end of the string. I have again shortened the string one yard; how much has the chair advanced?

CAROLINE.

Only half a yard; I now understand it. The chair represents the weight to which the moveable pulley is attached; and it is very clear that the weight can be drawn only half the length the string

is drawn. I believe the circumstance that perplexed me was, that I did not observe the difference which results from the weight being attached to the pulley, instead of being fastened to the string, as is the case in the fixed pulley.

EMILY.

But a moveable pulley seems, in one respect, to increase rather than diminish the difficulty of raising weights, since you must draw the string double the length that you raise the weight; whilst with a fixed pulley, or without any pulley, the weight is raised as much as the string is shortened.

MRS. B.

The advantage of a moveable pulley consists in dividing the difficulty. We must draw, it is true, twice the length of the string; but then only half the strength is required that would be necessary to raise the weight without such assistance.

EMILY.

So that the difficulty is overcome in the same manner as it would be by dividing the weight into two equal parts, and raising them successively.

MRS. B.

Exactly. Since the velocity of the power is double that of the weight, the power need not be

more than half the weight to make their momentums equal.

CAROLINE.

Pulleys act, then, on the same principle as the lever, the deficiency of strength of the power being compensated by its superior velocity.

MRS. B.

Yes; and you will find that all mechanical power is founded on the same principle. The pulley may be explained on the principle of the lever. In the single fixed pulley (fig. 1.) the line AC may be considered as a lever, and B the fulcrum; then the two arms, AB and BC, being equal, the lever will afford no aid as a mechanical power; since the power must be equal to the weight in order to balance it, and superior to the weight in order to raise it.

EMILY.

But how can the moveable pulley, which does afford mechanical aid, be analogous to a lever of unequal arms? for one side of the pulley cannot be made wider than the other.

MRS. B.

No: in the moveable pulley (fig. 2.) you must consider the point A, in which the cord first touches the pulley, as the centre of motion; AB, or half



the diameter of the pulley, as the shortest arm, and A C, or the whole diameter, as the longest arm.

EMILY.

But may it not be objected to pulleys that a longer time is required to raise a weight by their aid than without it? for what is gained in power is lost in time.

MRS. B.

That, my dear, is the fundamental law in mechanics. It is the case with the lever as well as the pulley; and you will find it to be so with all the other mechanical powers.

CAROLINE.

I do not see any advantage in the mechanical powers, then, if what we gain by them one way is lost another.

MRS. B.

Since we are incapable of increasing our natural strength, is not that science of wonderful utility which enables us to reduce the resistance or weight of any body to the level of our strength? This we accomplish by dividing the resistance of a body into parts which we can successively overcome. It is true, as you observe, that it requires a sacrifice of time to attain this end; but you must be sensible how very advantageously it is exchanged for power: the utmost exertion we can make adds but little to

our natural strength, whilst we have a much more unlimited command over time.

You can now understand that, the greater the number of pulleys connected by a string, the more easily the weight is raised, as the difficulty is divided amongst the number of strings, or, rather, of parts into which the string is divided by the pulleys. Several pulleys thus connected form what is called a system or tackle of pulleys. (Fig. 3.) You may have seen them suspended from cranes to raise goods into warehouses, and in ships to draw up the sails. In shipping, both the advantages of an increase of power and a change of direction, by means of pulleys, are united: for the sails are raised up the masts by the sailors on deck from the change of direction which the pulley effects: and the labour is facilitated by the mechanical power of a combination of pulleys.

EMILY.

But the pulleys on shipboard do not appear to me to be united in the manner you have shown us.

MRS. B.

They are, I believe, more frequently connected as described in fig. 4., both for nautical and a variety of other purposes; but, in whatever manner pulleys are connected by a single string, the mechanical power is in its principle the same.

The third mechanical power is the wheel and axle. Let us suppose (Plate V. fig. 5.) the weight *W* to be a bucket of water in a well, which we raised by winding the rope to which it is attached round the axle: if this be done without a wheel to turn the axle, no mechanical assistance is received. The axle without a wheel is as impotent as a single fixed pulley, or a lever whose fulcrum is in the centre; but add the wheel to the axle, and you will immediately find the bucket is raised with much less difficulty. The axle acts the part of the shorter arm of the lever, the wheel that of the longer arm. The velocity of the circumference of the wheel is as much greater than that of the axle as it is further from the centre of motion; for the wheel describes a large circle in the same space of time that the axle describes a small one; therefore the power is increased in the same proportion as the circumference of the wheel is greater than that of the axle. If the velocity of the wheel were twelve times greater than that of the axle, a power nearly twelve times less than the weight of the bucket would be able to raise it.

## CAROLINE.

In raising water, there is commonly, I believe, instead of a wheel attached to the axle, only a crooked handle, which answers the purpose of winding the rope round the axle, and thus raising the bucket.

MRS. B.

In this manner (fig. 6.). Now, if you observe the dotted circle which the handle describes in winding up the rope, you will perceive that the branch of the handle A, which is united to the axle, represents the spoke of a wheel, and answers the purpose of an entire wheel: the other branch, B, affords no mechanical aid, merely serving as a handle to turn the wheel.

Wheels are a very essential part of most machines. They are employed in various ways: but when fixed to the axle, their mechanical power is always the same; that is, in proportion as the circumference of the wheel exceeds that of the axle, so much will the energy of the power be increased.

CAROLINE.

Then the larger the wheel the greater must be its effect.

MRS. B.

Certainly. If you have ever seen any considerable mills or manufactures, you must have admired the immense wheel the revolution of which puts the whole of the machinery into motion; and, though so great an effect is produced by it, a horse or two has sufficient power to turn it. Sometimes a stream of water is used for that purpose: but of late years a steam-engine has been found both the

most powerful and the most convenient mode of turning the wheel.

CAROLINE.

Do not the vanes of a windmill represent a wheel, Mrs. B. ?

MRS. B.

Yes; and in this instance we have the advantage of a gratuitous force, the wind, to turn the wheel. One of the great benefits resulting from the use of machinery is, that it gives us a sort of empire over the powers of nature, and enables us to make them perform that labour which would otherwise fall to the lot of man. When a current of wind, a stream of water, or the expansive force of steam, performs our task, we have only to superintend and regulate their operations.

The fourth mechanical power is the inclined plane. This is nothing more than a slope, or declivity, frequently used to facilitate the drawing up of weights. It is not difficult to understand that a weight may with much greater ease be drawn up a slope than it can be raised the same height perpendicularly. But in this, as well as the other mechanical powers, the facility is purchased by a loss of time (fig. 7.); for the weight, instead of moving directly from A to C, must move from B to C; and, as the length of the plane is to its height, so much is the resistance of the weight

diminished. Thus, if a pulley be fixed at F, and a string fixed to the weight W were connected with another weight P, then, if P bear the same proportion to W that the line BC does to the line CA, the two weights will balance each other; a considerable portion of the weight W being supported by the plane BC, and only the residue by the power P.

EMILY.

Yes; for the resistance, instead of being confined to the short line AC, is spread over the long line BC.

MRS. B.

The wedge, which is the next mechanical power, is composed of two inclined planes (fig. 8.): you may have seen woodcutters use it to cleave wood. The resistance consists in the cohesive attraction of the wood, or any other body which the wedge is employed to separate; and the advantage gained by this power is in the proportion of half its width to its length; for, while the wedge forces asunder the coherent particles of the wood to A and B, it penetrates downwards as far as C. The wedge, however, acts principally by being struck, and not by mere pressure: the proportion which I have stated to you is that which expresses its power when acting by pressure only.

EMILY.

The wedge, then, is rather a compound than a distinct mechanical power, since it is composed of two inclined planes.

MRS. B.

It is so. All cutting instruments are constructed upon the principle of the inclined plane or the wedge. Those that have but one edge sloped, like the chisel, may be referred to the inclined plane; whilst the axe, the hatchet, and the knife (when used to chop or split asunder) act on the principle of the wedge.

CAROLINE.

But a knife cuts best when it is drawn across the substance it is to divide. We use it thus in cutting meat; we do not chop it to pieces.

MRS. B.

The reason of this is that the edge of a knife is really a very fine saw, and therefore acts best when used like that instrument.

The screw, which is the last mechanical power, is more complicated than the others. You will see by this figure (fig. 9.) that it is composed of two parts, the screw and the nut. The screw S is a cylinder, with a spiral protuberance coiled round it, called the thread: the nut N is perforated to contain the screw; and the inside of

the nut has a spiral groove, made to fit the spiral thread of the screw.

CAROLINE.

It is just like this little box, the lid of which screws on the box as you have described. But what is this handle which projects from the nut?

MRS. B.

It is a lever attached to the nut, without which the screw is never used as a mechanical power. The nut with a lever, L, attached to it, is commonly called a winch. The power of the screw, complicated as it appears, is referable to one of the most simple of the mechanical powers: which of them do you think it is?

CAROLINE.

In appearance it most resembles the wheel and axle.

MRS. B.

The lever, it is true, has the effect of a wheel, as it is the means by which you wind the nut round; but the lever is not considered as composing a part of the screw, though it is true that it is necessarily attached to it. But observe, that the lever, considered as a wheel, is not fastened to the axle or screw, but moves round it; and in so doing the nut either rises or descends, according to the way in which you turn it.



EMILY.

The spiral thread of the screw resembles, I think, an inclined plane. It is a sort of slope, by means of which the nut ascends more easily than it would do if raised perpendicularly; and it serves to support it when at rest.

MRS. B.

Very well. If you cut a slip of paper in the form of an inclined plane, and wind it round your pencil, which will represent the cylinder, you will find that it makes a spiral line, corresponding to the spiral protuberance of the screw. (Fig. 10.)

EMILY.

Very true: the nut then ascends an inclined plane, but ascends it in a spiral instead of a straight line. The closer the thread of the screw, the more easy the ascent; it is like having shallow instead of steep steps to ascend.

MRS. B.

Yes, excepting that the nut takes no steps: it gradually winds up or down. Then observe that, the closer the threads of the screw, the greater the number of revolutions the winch must make; so that we return to the old principle—what is saved in power is lost in time.

EMILY.

Cannot the power of the screw be increased also, by lengthening the lever attached to the nut ?

MRS. B.

Certainly. The screw, with the addition of the lever, forms a very powerful machine, employed either for compression or to raise heavy weights. It is used by bookbinders, to press the leaves of books together. It is used also in cider and wine presses, in coining, and for a variety of other purposes.

All machines are composed of one or more of these six mechanical powers we have examined. I have another remark to make to you relative to them, which is, that friction considerably diminishes their force : allowance must, therefore, always be made for it in the construction of machinery.

CAROLINE.

By friction, do you mean one part of the machine rubbing against another part contiguous to it ?

MRS. B.

Yes. Friction is the resistance which bodies meet with in rubbing against each other. There is no such thing as perfect smoothness or evenness in nature. Polished metals, though they wear that

appearance more than any other bodies, are far from really possessing it; and their inequalities may frequently be perceived through a good magnifying glass. When, therefore, the surfaces of two bodies come into contact, the prominent parts of the one will often fall into the hollow parts of the other, and occasion more or less resistance to motion.

CAROLINE.

But if a machine be made of polished metal, as a watch, for instance, the friction must be very trifling.

MRS. B.

In proportion as the surfaces of bodies are well polished, the friction is doubtless diminished; but it is always considerable, and it is usually computed to destroy one third of the power of a machine. Oil or grease is used to lessen friction: it acts as a polish, by filling up the cavities of the rubbing surfaces, and thus making them slide more easily over each other.

CAROLINE.

Is it for this reason that wheels are greased, and the locks and hinges of doors oiled?

MRS. B.

Yes. In these instances the contact of the rubbing surfaces is so close, and the rubbing so

continual, that, notwithstanding their being polished and oiled, a considerable degree of friction is produced.

There are two kinds of friction; the one occasioned by the sliding of the flat surface of a body, the other by the rolling of a circular body. The friction resulting from the first is much the most considerable; for great force is required to enable the sliding body to overcome the resistance which the asperities of the surfaces in contact oppose to its motion, and it must be either lifted over or break through them; whilst, in the other kind, the friction is transferred to a smaller surface; the rough parts roll over each other with comparative facility: hence it is that wheels are often used for the sole purpose of diminishing the resistance of friction.

EMILY.

This is one of the advantages of carriage-wheels, is it not?

MRS. B.

Yes; and the larger the circumference of the wheel, the more readily it can overcome any considerable obstacle, such as stones or inequalities in the road. When, in descending a steep hill, we fasten one of the wheels, we decrease the velocity of the carriage by increasing the friction.

CAROLINE.

That is to say, by converting the rolling friction into the dragging friction. And when you had castors put to the legs of the table, in order to move it more easily, you changed the dragging into the rolling friction.

But pray, Mrs. B., what is the use of the great fly-wheel which is frequently attached to steam-engines and other large machines, but yet, I am told, does not compose a part of the machine itself?

MRS. B.

By adding a fly-wheel to a machine, you load it with a heavy weight, which impedes its free uncontrolled motion.

CAROLINE.

A curious mode, truly, of improving the power of machinery!

MRS. B.

This, nevertheless, does improve machinery, though it cannot be said to increase its power.

The motion of a machine is always more or less variable, owing to the irregularity both of the power which works it, and of the resistance which it has to overcome. Whether the power consists in wind, water, steam, or the strength of animals, it cannot be made to act with perfect regularity,

nor can the work which the machine has to perform be always uniform.

EMILY.

I recollect that when fresh fuel is added to the fire of a steam-boat, the steam acts with increased violence, and during a few minutes the velocity of the boat is considerably accelerated: this is the more striking, because, previously to the fire being recruited, the motion of the boat had been slackened, owing to the want of fuel.

MRS. B.

Uniformity of motion in a steam-boat is not required; but in manufactures, and in most cases in which machinery is employed, uniformity of action is essentially requisite, both in order to prevent injury to the machine, and imperfection in the work performed. A fly-wheel, which is a large heavy wheel attached to the axis of one of the principal wheels of the machinery, answers this purpose, by regulating the action of the machine; by its weight it diminishes the effect of increased action, and by its *inertia* it carries on the machine with uniform velocity when the power transiently slackens; thus, by either checking or impelling the action of the machine, it regulates its motion so as to render it tolerably uniform.

There is another circumstance which we have

already noticed, as diminishing the motion of bodies, and which greatly affects the power of machines. This is the resistance of the medium in which a machine is worked. All fluids, whether of the nature of air or of water, are called mediums, and their resistance is generally proportioned to their density; for the more matter a body contains the greater the resistance it will oppose to the motion of another body striking against it.

EMILY.

It would then be much more difficult to work a machine under water than in the air?

MRS. B.

Certainly; if a machine could be worked in a vacuum, and without friction, it would be perfect; but this is unattainable. A considerable reduction of power must, therefore, be allowed for the resistance of the air.

We shall here conclude our observations on the mechanical powers. At our next meeting I shall endeavour to give an explanation of the motion of the heavenly bodies.

## CONVERSATION VII.

CAUSES OF THE EARTH'S ANNUAL  
MOTION.

OF THE PLANETS AND THEIR MOTION.—OF THE  
DIURNAL MOTION OF THE EARTH AND PLANETS.

CAROLINE.

OH! Mrs. B., I have discovered such a powerful objection to your theory of attraction, that I doubt whether even your conjuror, Newton, with his magic wand of attraction, will be able to dispel it.

MRS. B.

I see that you are quite elated with the spirit of opposition; but tell me, what is this weighty objection?

CAROLINE.

You say that bodies attract in proportion to the quantity of matter they contain; now, we all know



the sun to be much larger than the earth ; why, therefore, does it not attract the earth ? You will not, I suppose, pretend to say that we are falling towards the sun ?

EMILY.

However plausible your objection appears, Caroline, I think you place too much reliance upon it. When any one has given such convincing proofs of sagacity and wisdom as Sir Isaac Newton, when we find that his opinions are universally received and adopted, is it to be expected that any objection we can advance should overturn them ?

CAROLINE.

Yet I confess that I am not inclined to yield implicit faith even to opinions of the great Newton. For what purpose are we endowed with reason, if we are denied the privilege of making use of it, by judging for ourselves ?

MRS. B.

It is reason itself which teaches us, that when we, novices in science, start objections to theories established by men of acknowledged wisdom, we should be distrustful rather of our own than of their opinion. I am far from wishing to lay the least restraint on your questions. You cannot be better convinced of the truth of a system, than by finding that it resists all your attacks ; but I would advise



Fig. 1.

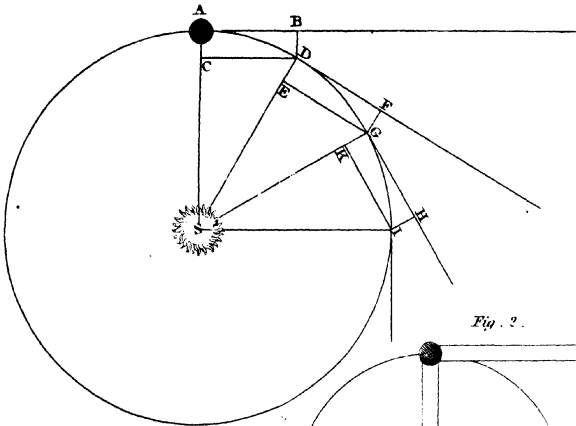


Fig. 2.

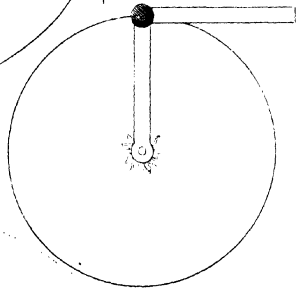


Fig. 3.

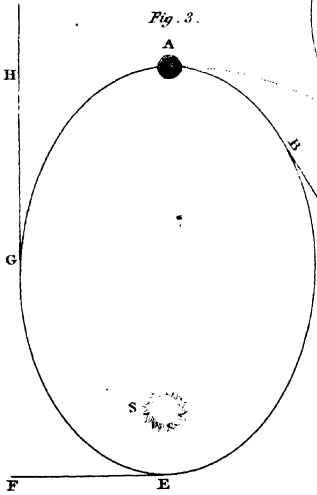
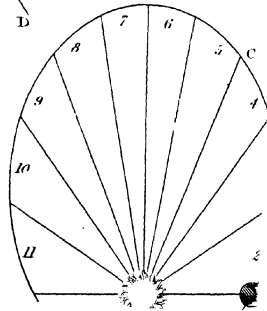


Fig. 4.



you not to advance your objections with so much confidence, in order that the discovery of their fallacy may be attended with less mortification. In answer to that you have just proposed, I can only say, that the earth really is attracted by the sun.

CAROLINE.

Take care, at least, that we are not consumed by it, M<sup>rs</sup>. B.

MRS. B.

We are in no danger. But our magician Newton, as you call him, cannot extricate himself from this difficulty without the aid of some calculistical figures, which I must draw for him.

Let us suppose the earth at its creation to have been projected forwards into universal space. We know, that if no obstacle impeded its course it would proceed in the same direction, and with a uniform velocity, for ever. In fig. 1. plate VI. A represents the earth, and S the sun. We shall suppose the earth to be arrived at the point in which it is represented in the figure, having a velocity which would carry it on to B in the space of one month; whilst the sun's attraction would bring it to C in the same space of time. You will perceive by the figure that the two forces of projection and attraction do not act in opposition, but perpendicularly, or at a right angle to each other. Can you tell me, now, how the earth will move?

EMILY.

I recollect your teaching us, that a body acted upon by two forces perpendicular to each other would move in the diagonal of a parallelogram: if, therefore, I complete the parallelogram by drawing the lines CD, BD, the earth will move in the diagonal AD.

MRS. B.

A ball struck by two forces acting perpendicularly to each other, it is true, moves in the diagonal of a parallelogram. But you must observe that the force of attraction is continually acting upon our terrestrial ball, and producing an incessant deviation from its course in a right line, which converts it into that of a curved line; every point of which may be considered as constituting the diagonal of an infinitely small parallelogram.

Let us detain the earth a moment at the point D, and consider how it will be affected by the combined action of the two forces in its new situation. It still retains its tendency to fly off in a straight line; but a straight line would now carry it away to F, whilst the sun would attract it in the direction DS; how, then, will it proceed?

EMILY.

It will go on in a curved line in a direction between that of the two forces.

MRS. B.

In order to know exactly what course the earth will follow, draw another parallelogram similar to the first, in which the line  $D F$  describes the force of projection, and the line  $D S$  that of attraction; and you will find that the earth will proceed in the curved line  $D G$ .

CAROLINE.

Pray allow me to draw a parallelogram, Mrs. B. Let me consider in what direction will the force of projection now impel the earth?

MRS. B.

First draw a line from the earth to the sun, representing the force of attraction; then describe the force of projection at a right angle to it.

CAROLINE.

The earth will then move in the curve  $G I$ , of the parallelogram  $G H I K$ .

MRS. B.

You recollect that a body acted upon by two forces moves through a diagonal in the same time that it would have moved through one of the sides of the parallelogram, were it acted upon by one force only. The earth has passed through the diagonals of these three parallelograms in the space of three months, and has performed one

quarter of a circle: and on the same principle it will go on till it has completed the whole of the circle. It will then recommence a course which it has pursued ever since it first issued from the hand of its Creator, and which there is every reason to suppose it will continue to follow as long as it remains in existence.

EMILY.

What a grand and beautiful effect, resulting from so simple a cause!

CAROLINE.

It affords an example, on a magnificent scale, of the circular motion which you taught us in mechanics. The attraction of the sun is the centripetal force, which confines the earth to a centre; and the impulse of projection is the force which impels the earth to quit the sun, and fly off in a tangent, and which, therefore, by the inertia of the body, produces the centrifugal force.

MRS. B.

Exactly so. A simple mode of illustrating the effect of these combined forces on the earth is to cut a slip of card in the form of a right angle (fig. 2. plate VI.), to describe a small circle at the angular point representing the earth, and to fasten the extremity of one of the legs of the angle to a fixed point, which we shall consider as the sun. Thus situated, the lines forming the angle will

represent both the forces which act upon the earth; and if you draw it round the fixed point, you will see how the direction of the force which opposes the centripetal force varies, constantly forming a tangent to the circle in which the earth moves, as it is constantly at a right angle with the centripetal force.

EMILY.

The earth, then, gravitates towards the sun without the slightest danger either of approaching nearer or receding farther from it. How admirably this is contrived! If the two forces which produce this circular motion had not been so accurately adjusted, the one would ultimately have prevailed over the other, and we should either have approached so near the sun as to have been burnt, or have receded so far from it as to have been frozen.

MRS. B.

What will you say, my dear, when I tell you, that these two forces are not, in fact, so proportioned as to produce circular motion in the earth, and that the earth's orbit, or the path which it describes round the sun, is not a circle?

CAROLINE.

You must explain to us, at least, in what manner we avoid the threatened destruction.



MRS. B.

Let us suppose that when the earth is at A (fig. 3.), its projectile force does not give it a velocity sufficient to counterbalance that of gravity, so as to enable these powers conjointly to carry it round the sun in a circle; the earth, instead of describing the line AC, as in the former figure, will approach nearer the sun in the line AB.

CAROLINE.

Under these circumstances, I see not what is to prevent our approaching nearer and nearer the sun till we fall into it; for its attraction increases as we advance towards it, and produces an accelerated velocity in the earth which augments the danger.

MRS. B.

And there is yet another danger, of which you are not aware. Observe, that as the earth approaches the sun, the direction of its projectile force is no longer perpendicular to that of attraction, but inclines more nearly to it. When the earth reaches that part of its orbit at B, the force of projection would carry it to D, which brings it nearer instead of bearing it a way from the sun.

EMILY.

If, then, we are driven by one power and drawn by the other towards this centre of destruction, how is it possible for us to escape?

MRS. B.

A little patience, and you will find that we are not without resource. The earth continues approaching the sun with an accelerated motion, till it reaches the point E: in what direction will the projectile force now impel it?

EMILY.

In the direction E F. Here, then, the two forces act perpendicularly to each other, and the earth is situated just as it was in the preceding figure; therefore, from this point, it should revolve round the sun in a circle.

MRS. B.

No; all the circumstances do not agree. You must recollect that, in motion round a centre, the centrifugal force increases with the velocity of the body; or, in other words, the quicker it moves the stronger is its tendency to fly off in a right line. When the earth, therefore, arrives at E, its accelerated motion will have so far increased its velocity, and consequently its centrifugal force, that the latter will prevail over the force of attraction, and drag the earth away from the sun till it reaches G.

CAROLINE.

It is thus, then, that we escape from the dangerous vicinity of the sun; and in proportion as we recede from it, the force of its attraction, and,

consequently, the velocity of the earth's motion, diminish.

MRS. B.

Yes. From G the direction of projection is towards H, that of attraction towards S; and the earth proceeds between them with a retarded motion, till it has completed its revolution. Thus you see that the earth travels round the sun, not in a circle, but in an ellipsis, of which the sun occupies one of the *foci*; and that in its course the earth alternately approaches and recedes from it, without any danger of being either swallowed up or of being entirely carried away from it.

CAROLINE.

And I observe, that what I apprehended to be a dangerous irregularity, is the means by which the most perfect order and harmony are produced.

MRS. B.

In fig. 3. I have not entered into all the details which are delineated in fig. 1.; but as I hope you now understand the laws which govern the earth in its revolution about the sun, I trust that you will be able to draw a series of parallelograms in fig. 3. on the principle of those in fig. 1.; and you will perceive that the power of attraction increases its influence and becomes superior to that of projection, in proportion as the earth approaches the

sun from A to E; whilst the force of attraction diminishes, and that of projection acquires the ascendancy, as the earth recedes from the sun, in returning from E to A.

## EMILY.

The earth travels, then, at a very unequal rate; its velocity being accelerated as it approaches the sun, and retarded as it recedes from it.

## MRS. B.

It is mathematically demonstrable, that when a body moves round a point towards which it is attracted, the areas included between the line it describes, and the lines joining its place at different instants to the attracting point, are equal in equal times. The whole of the space contained within the earth's orbit is, in fig. 4., divided into a number of areas, or spaces, 1, 2, 3, 4, &c., all of which are of equal dimensions, though of very different forms; some of them, you see, are long and narrow, others broad and short; but they each of them contain an equal quantity of space. An imaginary line drawn from the centre of the earth to that of the sun, and keeping pace with the earth in its revolution, passes over equal areas in equal times; that is to say, if it is a month going from A to B, it will be a month going from B to C, and another from C to E, and so on.

CAROLINE.

What long journeys the earth has to perform in the course of a month, in one part of our orbit, and how short they are in the other part !

MRS. B.

The inequality is not so considerable as it appears in this figure ; for the earth's orbit is not so eccentric as it is there described ; and, in reality, differs but little from a circle. That part of the earth's orbit nearest the sun is called its *perihelion* ; that part most distant from the sun its *aphelion* ; and the earth is about three millions of miles nearer the sun at its perihelion than at its aphelion.

EMILY.

I think I can trace a consequence from these different situations of the earth : is it not summer when the earth is in that part of its orbit nearest the sun, and winter when it is most distant from it ?

MRS. B.

On the contrary, during the height of our summer, the earth is in that part of its orbit which is most distant from the sun, and it is during the severity of winter that it approaches nearest to it.

EMILY.

That is very extraordinary ; and how, then, do you account for the heat being greatest when we are most distant from the sun ?

MRS. B.

The difference of the earth's distance from the sun in summer and winter, when compared with its total distance from the sun, is but inconsiderable. The earth, it is true, is above three millions of miles nearer the sun in winter than in summer; but that distance, however great it at first appears, sinks into insignificance in comparison of 95 millions of miles, which is our mean distance from the sun. The change of temperature, arising from this difference, would in itself scarcely be sensible. It is, however, completely overpowered by other causes, which produce the variations of the seasons; but these I shall defer explaining, till we have made some further observations on the heavenly bodies.

CAROLINE.

And should not the sun appear smaller in summer, when it is so much farther from us?

MRS. B.

It actually does, when accurately measured; but the apparent difference in size is, I believe, not perceptible to the naked eye.

EMILY.

Then, since the earth moves with greatest velocity in that part of its orbit nearest the sun, it must

have completed its journey through one half of its orbit in a shorter time than through the other half.

MRS. B.

Yes. It is about seven days longer performing our summer-half of its orbit than the winter-half.

The revolutions of all the planets round the sun are the result of the same causes, and are performed in the same manner as that of the earth.

EMILY.

Pray, what are the planets?

MRS. B.

They are those celestial bodies which revolve like our earth about the sun. They are supposed to resemble the earth also in many other respects; and we are led by analogy to consider them as inhabited worlds.

CAROLINE.

I have heard so; but such an opinion appears to me too great a stretch of the imagination.

MRS. B.

Astronomers have proved that several of these bodies are larger than the earth; it is only their immense distance which renders their apparent dimensions so small. Now, if we consider them as

enormous globes, instead of small twinkling spots, we are naturally led to suppose, that the Almighty has not created them merely for the purpose of giving us a little light in the night, as it was formerly imagined. and that it is more consistent with our ideas of the Divine wisdom and beneficence, to suppose that these celestial bodies should be created for the habitation of beings, who are, like us, blessed by His providence. Both in a moral as well as a physical point of view, it appears to me more rational to consider the planets as worlds revolving round the sun; and the fixed stars as other suns, each of them attended by their respective system of planets, to which they impart their influence. We have brought our telescopes to such a degree of perfection, that, from the appearances which the moon exhibits when seen through them, we have very good reason to conclude that it is a habitable globe: for though it is true that we cannot discern its towns and people, we can plainly perceive its mountains and valleys; and some astronomers have gone so far as to imagine they discovered volcanoes.

EMILY.

If the fixed stars are suns with planets revolving round them, why should we not see those planets as well as their suns?



MRS. B.

In the first place, we conclude that the planets of other systems (like those of our own) are much smaller than the suns which give them light; therefore, at so great a distance as to make the suns appear like fixed stars, the planets would be quite invisible. Secondly, the light of the planets, being only reflected light, is much more feeble than that of the fixed stars. There is exactly the same difference as between the light of the sun and that of the moon; the first being a fixed star, the second a planet.

EMILY.

But if the planets are worlds like our earth, they are dark bodies; and, instead of shining by night, we should see them only by daylight. And why do we not see the fixed stars also by daylight?

MRS. B.

Both for the same reason; — their light is so faint, compared to that of our sun, that it is entirely effaced by it.

CAROLINE.

But is not the light emitted by the fixed stars as strong as that of our sun, at an equal distance?

MRS. B.

Yes; but being so much more remote, it is diffused over a greater space, and is consequently proportionally weakened.

CAROLINE.

True; I can see much better by the light of a candle that is near me, than by that of one at a great distance. But I do not understand what it is that makes the planets shine.

MRS. B.

What is it that makes that weathercock on the church-steeple shine?

CAROLINE.

The sun. But if it was the sun which made the planets shine, we should see them in the daytime, when the sun shone upon them, as we do the weathercock; or if the faintness of their light prevented our seeing them in the day, we should not see them at all, for the sun cannot shine upon them in the night.

MRS. B.

There you are in error. But, in order to explain this to you, I must first make you acquainted with the various motions of the planets.

You know, that, according to the laws of attraction, the planets belonging to our system all

gravitate towards the sun; and that this force, combined with that of projection, will occasion their revolution round the sun, in orbits more or less elliptical, according to the proportion which these two forces bear to each other.

But the planets have also another motion; they revolve upon their axes. The axis of a planet is an imaginary line which passes through its centre, and on which it turns; and it is this motion which produces day and night. With that side of the planet facing the sun, it is day; and with the opposite side, which remains in darkness, it is night. Our earth, which we consider as a planet, is 24 hours in performing one revolution on its axis; in that period of time, therefore, we have a day and a night. Hence this revolution is called the earth's diurnal or daily motion; and it is this revolution of the earth from west to east which produces an apparent motion of the sun, moon, and stars, in a contrary direction.

Let us now suppose ourselves to be beings independent of any planets, travelling in the skies, and looking upon the earth in the same point of view as upon the other planets.

#### CAROLINE.

It is not flattering to us, its inhabitants, to see it make so insignificant an appearance.

MRS. B.

To those who are accustomed to contemplate it in this point of view, it never appears more glorious. We are taught by science to distrust appearances; and instead of considering the stars as brilliant specks, we look upon them either as suns or habitable worlds, and we contemplate the whole together as forming one vast and magnificent system, worthy of the Divine hand by which it was created.

EMILY.

I can scarcely conceive the idea of this immensity of creation; it seems too sublime for our imagination;—and to think that the goodness of Providence extends over millions of worlds throughout a boundless universe—Ah! Mrs. B., it is we only who become trifling and insignificant beings in so magnificent a creation!

MRS. B.

This idea should teach us humility, but without producing despondency. The same Almighty hand which guides these countless worlds in their undeviating course, conducts with equal perfection the blood as it circulates through the veins of a fly, and opens the eye of the insect to behold His wonders. Notwithstanding this immense scale of creation, therefore, we need not fear to be disregarded or forgotten.

But to return to our station in the skies. We were, if you recollect, viewing the earth at a great distance, in appearance a little star, one side illuminated by the sun, the other in obscurity. But would you believe it, Caroline,—many of the inhabitants of this little star imagine that when that part which they inhabit is turned from the sun, darkness prevails throughout the universe, merely because it is night with them; whilst, in reality, the sun never ceases to shine upon the one or the other side of every planet? When, therefore, these little ignorant beings look around them during their night, and behold all the stars shining, they cannot imagine why the planets, which are dark bodies, should look so brilliant, concluding that since the sun does not shine on themselves, the whole universe must be in darkness.

CAROLINE.

I confess that I was one of these ignorant people; but I am now very sensible of the absurdity of such an idea. To the inhabitants of the other planets, then, we must appear as a little star?

MRS. B.

Yes, to those which revolve round our sun; for since those which may belong to other systems (and whose existence is only hypothetical) are invisible

to us, it is probable that we also are invisible to them.

EMILY.

But they may see our sun as we do theirs, in appearance a fixed star ?

MRS. B.

No doubt; if the beings who inhabit those planets are endowed with senses similar to ours. By the same rule we must appear as a moon to the inhabitants of our moon; but on a larger scale, as the surface of the earth is about thirteen times as large as that of the moon.

EMILY.

The moon, Mrs. B., appears to move in a different direction, and in a different manner, from the stars.

MRS. B.

I shall defer the explanation of the motion of the moon till our next interview, as it would prolong our present lesson too much.

## CONVERSATION VIII.

## ON THE PLANETS.

OF THE SATELLITES OR MOONS. — GRAVITY DIMINISHES AS THE SQUARE OF THE DISTANCE INCREASES. — OF THE SOLAR SYSTEM. — OF COMETS. — OF DOUBLE STARS. — CONSTELLATIONS, SIGNS OF THE ZODIAC. — COPERNICUS, NEWTON, ETC.

MRS. B.

THE planets are distinguished into primary and secondary. Those which revolve immediately about the sun are called primary. Many of these are attended in their course by smaller planets, which revolve round them: these are called secondary planets, satellites, or moons. Such is our moon, which accompanies the earth, and is carried with it round the sun.

EMILY.

How, then, can you reconcile the motion of the secondary planets to the laws of gravitation; for the sun is much larger than any of the primary planets; and is not the power of gravity proportional to the quantity of matter?

CAROLINE.

Perhaps the sun, though much larger, may be less dense than the planets. Fire, you know, is very light, and it may contain but little matter, though of great magnitude.

MRS. B.

We do not know of what kind of matter the sun is made; but we may be certain that, since it is the general centre of attraction of our system of planets, it must be the body which contains the greatest quantity of matter in that system.

You must recollect that the force of attraction is not only proportional to the quantity of matter, but to the degree of proximity of the attractive body: this power is weakened by being diffused, and diminishes as the squares of the distances increase. The square (you know) is the product of a number multiplied by itself; so that a planet situated at twice the distance at which we are from the sun would gravitate four times less than we do; for the product of two multiplied by itself is four.



CAROLINE.

Then the more distant planets move slower in their orbits ; for their projectile force must be proportioned to that of attraction. But I do not see how this accounts for the motion of the secondary round the primary planets, in preference to the sun.

EMILY.

Is it not because the vicinity of the primary planets renders their attraction stronger than that of the sun ?

MRS. B.

Exactly so. But since the attraction between bodies is mutual, the primary planets are also attracted by the satellites, which revolve round them. The moon attracts the earth as well as the earth the moon ; but as the latter is the smaller body, her attraction is proportionally less : therefore neither the earth revolves round the moon, nor the moon round the earth ; but they both revolve round a point, which is their common centre of gravity, and which is as much nearer the earth than the moon as the gravity of the former exceeds that of the latter.

EMILY.

Yes ; I recollect your saying, that if two bodies were fastened together by a wire or bar, their common centre of gravity would be in the middle of

the bar, provided the bodies were of equal weight, and if they differed in weight it would be nearer the larger body. Attraction is the tie which unites the earth and moon; if, then, these bodies had no projectile force which prevented their mutual attraction from bringing them together, they would meet at their common centre of gravity.

## CAROLINE.

The earth, then, has a great variety of motions; it revolves round the sun upon its axis, and round the point towards which the moon attracts it.

## MRS. B.

Just so; and this is the case with every planet which is attended by satellites. The complicated effect of this variety of motions produces certain irregularities, which, however, it is not necessary to notice at present.

The planets act on the sun in the same manner as they are themselves acted on by their satellites; for attraction, you must remember, is always mutual; but the gravity of the planets (even when taken collectively) is so trifling compared with that of the sun, that they do not cause the latter to move so much as one half of its diameter. The planets do not, therefore, revolve round the centre of the sun, but round a point at a small distance from its centre, about which the sun also revolves.

EMILY.

I thought the sun had no motion ; that it was the only body which stood still whilst all the planets revolved round it.

MRS. B.

You were mistaken ; for, besides that which I have just mentioned, which is indeed very inconsiderable, he revolves on his axis. This motion is ascertained by observing certain spots, which disappear and re-appear regularly at stated times.

CAROLINE.

A planet has frequently been pointed out to me in the heavens ; but I could not perceive that its motion differed from the apparent motion of the fixed stars.

MRS. B.

The great distance of the planets renders their motion apparently so slow, that the eye is not sensible of their progress, unless we watch them for some considerable length of time ; in different seasons they appear in different parts of the heavens. The most accurate idea I can give you of the situation and motion of the planets will be by the examination of this diagram (Plate VII. fig. 1.), representing the solar system, in which our planets with their orbits are delineated.



cannot exist there but in a state of vapour, and metals would be liquefied.

CAROLINE.

Oh, what a dreadful climate !

MRS. B.

Though we could not live there, it may be perfectly adapted to other beings destined to inhabit it.

Venus, the next in the order of planets, is 68 millions of miles from the sun : she revolves about her axis in 23 hours and 21 minutes, and goes round the sun in 244 days 17 hours. The orbit of Venus is also contained within ours : during nearly one half of her course, we see her before sunrise, when she is called the morning-star ; in the corresponding part of her orbit, on the other side, she rises later than the sun.

CAROLINE.

In that case, we cannot see her, for she must rise in the daytime.

MRS. B.

True ; but when she rises later than the sun she also sets later ; so that we perceive her approaching the horizon after sunset : she is then called Hesperus, or the evening-star. Do you recollect those beautiful lines of Milton ? —

Now came still Evening on, and Twilight gray  
Had in her sober livery all things clad ;  
Silence accompanied : for beast and bird,  
They to their grassy couch, these to their nests  
Were slunk, all but the wakeful nightingale ;  
She all night long her amorous descant sung ;  
Silence was pleased : now glow'd the firmament  
With living sapphires : Hesperus, that led  
The starry host, rode brightest, till the moon,  
Rising in clouded majesty, at length,  
Apparent queen, unveil'd her peerless light,  
And o'er the dark her silver mantle threw.

The planet next to Venus is the earth, of which we shall soon speak at full length. At present I shall only observe, that we are 95 millions of miles distant from the sun ; that we perform our diurnal motion in 24 hours, and our annual revolution in 365 days 5 hours and 49 minutes ; and are attended in our course by a single moon.

Then follows Mars. He can never come between us and the sun, like Mercury and Venus ; his motion is, however, very perceptible, as he may be traced to different situations in the heavens : his distance from the sun is 144 millions of miles ; he turns on his axis in 24 hours and 39 minutes ; and he performs his annual revolution in about 687 of our days ; his diameter is 4120 miles. Then follow five very small planets, Juno, Ceres, Pallas, Vesta, and Astrea, which have been more recently discovered, and whose dimensions

and distances from the sun have not been very accurately ascertained.

Jupiter is next in order ; this is the largest of all the planets. Its mass is greater than that of all the other planets put together.

CAROLINE.

By mass, do you mean its size ?

MRS. B.

No ; I mean its weight or gravity, which depends on the quantity of matter it contains. Now, two planets may differ considerably in size, and yet contain the same quantity of matter, and therefore have the same mass.

EMILY.

Certainly, if one of the planets is more dense than the other, its size will be smaller.

MRS. B.

Jupiter is about 490 millions of miles distant from the sun, and completes his annual period in nearly twelve of our years. He revolves on his axis in about ten hours. He is above 1200 times as large as our earth ; his diameter being 86,000 miles. The respective proportions of the planets cannot, therefore, you see, be conveniently delineated in a diagram. He is attended by four moons.

The next planet is Saturn, whose distance from the sun is about 900 millions of miles: his diurnal rotation is performed in ten hours and a quarter; his annual revolution in nearly 30 of our years. His diameter is 79,000 miles. This planet is surrounded by a luminous ring, the nature of which astronomers are much at a loss to conjecture: he has seven moons.

The next planet we observe is Uranus: it was discovered by Sir William Herschel in 1781. Its distance is 1822 millions of miles from the sun; which is nearly 20 times that of the earth. Its revolution on its axis has not yet been ascertained; it is about 84 of our years performing a revolution of its orbit. Its diameter is above four times, and its density one quarter, that of the earth.

#### EMILY.

When you reckon the distance of a planet from the sun, do you take its furthest or its nearest distance? for as the orbit of a planet is oval or elliptical, its distance from the sun must vary in different parts of its orbit.

#### MRS. B.

Astronomers always take a medium between the furthest and nearest distance, which is called the mean distance.

Astronomers on making observations on Uranus, found that it was subject to irregularities in its



motion, for which they were quite at a loss to account.

EMILY.

Uranus is at such an immense distance from the sun, that it may, perhaps, not be influenced by its gravity in the same regular manner as the other planets are.

MRS. B.

Distance diminishes the power of gravity, but does not affect the regularity of its influence.

CAROLINE.

May not Uranus be attended by a large moon, or, perhaps, several moons, which, in their revolutions round it, attract it in different directions, and thus produce the irregularities you speak of? and these moons, however large, might be invisible to us from their great distance.

MRS. B.

No; that is not the case, for Uranus has four moons, which are visible to us, and are too small to account for these irregularities or perturbations of the planet.

CAROLINE.

Then I must suggest another cause: may not these irregularities be owing to the influences of Saturn and Jupiter? These planets are next neighbours to Uranus, and being so large, might very likely interfere with the gravitating power of the sun, which is at so great a distance.

MRS. B.

They actually do so; but their influence has been calculated, and found to be quite incompetent to account for the perturbations of Uranus.

CAROLINE.

Well, then, Mrs. B., we must give up guessing, and hope that astronomers, who search for discoveries on some better grounds, have been able to find out this unknown cause.

MRS. B.

Not without great difficulty, I can assure you. For many years these irregularities rendered every attempt to calculate tables of the movements of Uranus abortive. At length a French mathematician, M. Le Verrier, having, in consequence of his researches, come to the conclusion that these perturbations must be caused by some unknown planet, whose gravity acted on Uranus, undertook a series of researches with the view to ascertain in what spot this body would be situated, and what should be its size and its density in order to produce such an effect.

EMILY.

I do not understand mathematics, it is true, Mrs. B., but I cannot conceive how any calculations can lead to such a discovery.

MRS. B.

You must not expect me to explain to you the

nature of M. le Verrier's calculations, for I am as ignorant of mathematics as you are; I can only give you the results; but in order to make them more intelligible, I will tell you in what manner a new planet is sought for. The light of a fixed star is bright and sparkling, that of a planet is feebler, but more steady.

CAROLINE.

That is very natural, the fixed star shining by its own light, the planet by reflected light.

MRS. B.

The outline of a planet when seen through a telescope is delineated, and presents to the eye a round figure called a disk.

CAROLINE.

And have not fixed stars disks also, Mrs. B.? I am sure I have seen fixed stars which to the naked eye seemed larger than the small planets.

MRS. B.

The only fixed star which has a disk visible to us is our sun: we see its face plainly, provided its brilliancy be subdued by a darkened glass or a London fog: all the other fixed stars are so distant, that we see them only as luminous spots, or points. It is true that the fixed stars of great magnitude appear to have a disk to the naked eye; but this is an illusion arising from the imperfection of our vision, producing a sort of glare around them, which may be mistaken for a disk.

When seen through a telescope, which in a great measure corrects this imperfection of our sight, the apparent size of the fixed stars is diminished, and you see them as sparkling luminous points without any disk or dimensions.

CAROLINE.

A telescope diminish the size of an object, that is strange indeed!

MRS. B.

If you draw a vertical line across the field of the telescope and direct it towards a fixed star, so that the star shall be to the east of the line, from the diurnal motion of the heavens westward it must cross that line; and it will do this instantaneously; whilst a planet submitted to a similar observation will take some seconds to do so; thus showing that to our sight a planet appears through a telescope much larger than a fixed star.

EMILY.

But if the fixed stars look merely like luminous points, they must appear all of the same size: how, then, are their different magnitudes to be ascertained?

MRS. B.

By their different degrees of brightness. A telescope, while it diminishes the apparent size of the star, augments its brilliancy; and, if one of great power be used, the light of the star will

be visible before the star itself comes within the field of the telescope.

EMILY.

But may not the brightness of a fixed star depend on its distance as well as its size? The nearer the star is the brighter it will appear.

MRS. B.

Your observation is very just, but we have no means of distinguishing the difference: the brighter a star is, the larger it appears to the naked eye, and astronomers class their magnitude according to that appearance.

Now all the stars which are visible in the heavens are delineated on maps, with which astronomers are as familiarly acquainted as you are with a map of geography. If, then, in taking a survey of the stars, an astronomer cannot find one which is marked down in the map, he naturally infers that the star which is missing is a planet, which has been mistaken for a fixed star, and that it has proceeded onward in its orbit to some other part of the heavens.

When, on the contrary, a star is discovered which is not noted down in the map, we are led to suppose that it must be a planet to us unknown, travelling in its orbit round the sun, and for the first time come under our observation.

CAROLINE.

All this is very intelligible; but I do not see

how it applies to an unknown planet, which has neither appeared nor disappeared.

MRS. B.

I am only giving you a little general information to lead us to M. Le Verrier's researches. By a series of observations and calculations on the various perturbations of Uranus, he ascertained not only the mass of the unknown planet and its distance from the sun, but was enabled to point out the spot in the heavens in which it must be situated in order to produce these perturbations; and so fully was he impressed with the truth of his calculations, that he wrote to communicate the results to astronomers of different countries, and in one of his letters he uses this remarkable phrase:— "Look at the spot which I have indicated, and you will see the planet well." Dr. Galle, one of the astronomers of the observatory of Berlin, the very same day that he received this information, actually saw the planet in the spot which Le Verrier had pointed out.

EMILY.

How wonderful! I never could have imagined that mere mathematical calculations could have had such interesting results. And what are the dimensions of this new planet and its distance from the sun?

MRS. B.

Its mass is the  $\frac{1}{3000}$ th part of that of the sun, its distance from it above 3400 millions of miles, and it revolves round it in 217 years. Its revolution on its axis is not yet known.

CAROLINE.

But how was the star Dr. Galle saw known to be a planet?

MRS. B.

First, because it was not marked down in the map; next because it had a disk; and finally, because it was observed to have a progressive motion in its orbit.

CAROLINE.

Dr. Galle was fortunate in being the first to see the planet; but the whole of the merit of its discovery belongs to M. Le Verrier. And pray what name does this new planet bear?

MRS. B.

I believe that point is not yet determined. M. le Verrier wished it to be called Neptune, whilst M. Arago, the astronomer royal of Paris, thought that it should be called after its discoverer, Le Verrier. But whether the planet bear his name or not, his glory, as its discoverer, will be perpetuated through the most distant ages.

EMILY.

I wonder that M. Le Verrier did not himself seek out the planet of whose existence and situation he was so fully convinced?

MRS. B.

M. Le Verrier is a mathematician, not an astronomer, and, as M. Arago very justly observes, it was unnecessary for him to use a telescope, he had found the planet at the end of his pen. His business was to point out to astronomers the spot in which they would find the star which was to verify his predictions. Dr. Galle, who was the first to see it, candidly allows that he possessed an advantage over other astronomers in making use of a new map, which had been recently published at Berlin, and was not yet known in other countries.

CAROLINE.

Well, I wish I could take a flight into one of these planets and see what they were like. I do not think I should venture to go so far as Uranus or the new planet, but I should like to pay a visit to Jupiter or Saturn; it would be so pleasant to be lighted up by so many moons.

MRS. B.

I do not think you would be tempted to remain there long. Consider what extreme cold must prevail in a planet situated, as Saturn is, at nearly ten times the distance at which we are from the sun. Then his numerous moons are far from making so splendid an appearance as ours; for they can reflect only the light which they receive



from the sun; and both light and heat decrease in the same ratio or proportion to the distances as gravity. Can you tell me, now, how much more light we enjoy than Saturn?

CAROLINE.

The square of ten is a hundred; therefore Saturn has a hundred times less; — or, to answer your question exactly, we have a hundred times more light and heat than Saturn: — this certainly does not increase my wish to become one of the poor wretches who inhabit that planet.

MRS. B.

By the same rule the light of the new planet compared to that of the earth is not more than as 3 to 1000. But may not the inhabitants of Mercury, with equal plausibility, pity us, for the insupportable darkness and coldness of our situation; and those of Jupiter and Saturn for our intolerable heat? The Almighty Power which created these planets, and placed them in their several orbits, has no doubt peopled them with beings whose bodies are adapted to the various temperatures and elements in which they are situated. If we judge from the analogy of our own earth, or from that of the great and universal beneficence of Providence, we must conclude this to be the case.

CAROLINE.

Are not comets also supposed to be planets?

MRS. B.

Yes, they are ; for, by the re-appearance of some of them at stated times, they are known to revolve round the sun, but in orbits so extremely eccentric, and running to such a distance from the sun, that they disappear for a great number of years. If they are inhabited, it must be by a species of beings very different, not only from the inhabitants of this, but from those of any of the other planets, as they must experience the greatest vicissitudes of heat and cold ; their heat in that part of their orbit nearest the sun is computed to be greater than that of red-hot iron. In this part of its orbit the comet emits a luminous vapour called the tail, which it gradually loses as it recedes from the sun ; and the comet itself totally disappears from our sight in the more distant parts of its orbit, which extends considerably beyond that of the furthest planet.

The number of comets belonging to our system that are known by their regular re-appearance is very small ; but no less than a hundred and forty comets have appeared during the last century within the earth's orbit that have not been seen again ; it is therefore impossible to conjecture what number may belong to our system ; and some astronomers have been led to think that it may extend to several thousand.

CAROLINE.

Is it possible? They must be almost as numerous, then, as the fixed stars.

MRS. B.

Oh no! the number of stars is incomparably greater. Sir William Herschel, by counting the stars in a single field of his telescope, computed that 50,000 passed under his review, in a zone two degrees in breadth, during a single hour's observation; and this space is only equal to  $\frac{1}{1373}$ th part of the whole heavens. So that the real number of stars actually visible through telescopes may be considered as incalculable.

EMILY.

And when one reflects that these stars are probably each of them attended by a system of planets, the idea is almost overpowering to the imagination.

CAROLINE.

I have heard that many of the fixed stars consist of two stars, so close together that, to the naked eye, they appear like one.

MRS. B.

That is true: these are called double stars, and yet, when seen through a powerful telescope, are evidently composed of two separate stars. Sir William Herschel discovered about five hundred of them; but the improvements in the construc-

tion of telescopes since his time have enabled astronomers to increase this number to between three and four thousand.

CAROLINE.

But is it not possible that these stars, which appear single to the naked eye, may seem to be double from some imperfection of the telescope through which they are seen?

MRS. B.

The naked eye is more likely to make a mistake than when assisted by the telescope. The separation is not only perfectly distinct, but by recent observations it has been discovered that, in many cases, the smaller revolves round the larger star.

CAROLINE.

Just as the planets revolve round the sun: but then is the smaller star a planet?

MRS. B.

It cannot be a dark body like our planets; for in that case we should not be able to see it at so great a distance. In all probability both the stars are suns, the smaller impelled by the force of gravity to revolve round the larger.

EMILY.

It is difficult to conceive for what purpose one sun should revolve round another: it cannot be to give or receive light and heat, for they have each of them abundance of that already.

MRS. B.

We cannot fathom the designs of the Creator of these countless suns : but as far as we can judge from analogy, and from the beneficence displayed throughout His works, we may suppose that each of these suns is attended by a system of planets similar to our own.

CAROLINE.

But, Mrs. B., the double stars must be so close to each other that there can be no room for any planets to move between them.

MRS. B.

The apparent vicinity of the double stars is owing to their immense distance from us ; and it is probable that they are many thousands of millions of miles asunder ; and in that case there is ample space for planets to revolve round each of them.

EMILY.

How wonderful ! Then, perhaps, our sun, bearing our earth and all the other planets along with it, may be revolving round some larger and more powerful sun !

CAROLINE.

With what impatience and anxiety astronomers must have watched the motion of the double stars, to discover whether one of them really revolved about the other !

MRS. B.

The fact was suspected soon after the discovery of the double stars; and the idea gained strength as soon as it was observed that the relative situation of the stars varied, and, consequently, that one of them, at least, must move; but it is not very long since their revolution has been fully proved by two of these stars having actually described their entire orbit since their first discovery by Sir William Herschel. One of them, belonging to the Great Bear, was ascertained to be double in the year 1782; and, the period of its rotation being calculated at fifty-eight years, it completed its revolution in 1840.

CAROLINE.

But how could astronomers calculate the time a star would take to complete its orbit before it had made one revolution?

MRS. B.

By founding their calculations on the laws of gravity, namely, that two bodies attract each other in the inverse ratio of the square of their distance, and the actual position of the stars was found perfectly to coincide with those calculations. This has been done also with regard to the planets Uranus and Le Verrier; the former, revolving round the sun in 84 of our years, has not completed a revolution since its discovery in the year 1781; and Le Verrier's planet was ascertained to per-

form its annual revolution in 217 years, as soon as it was discovered by Le Verrier's calculations, and even before it was actually seen.

EMILY.

Then, it appears that the fixed stars are not immoveable, as their name would imply?

MRS. B.

No: they would be more properly distinguished from the planets by being called luminous stars, as they emit their own light, while the planets shine by the light reflected upon them. Now that you have in some measure familiarised yourselves to the idea of double stars, I may farther tell you, that the improvement of our telescopes has enabled us to become of late years so much better acquainted with the fixed stars, that we have discovered that what appeared to us double stars, frequently consisted of groups of three or four stars, revolving round one common centre.

On this basis, M. Mœdler has founded the theory of a *central sun*, round which he supposes that all the stars of the universe, with their attendant planets, revolve. This would agree with the universality of gravity; but, on the other hand, a centre implies a circumference which would seem to form a boundary, and this is inconsistent with the notion of infinite space.

EMILY.

And yet it agrees so well with the groups of stars revolving round one common centre.





Fig. 1.

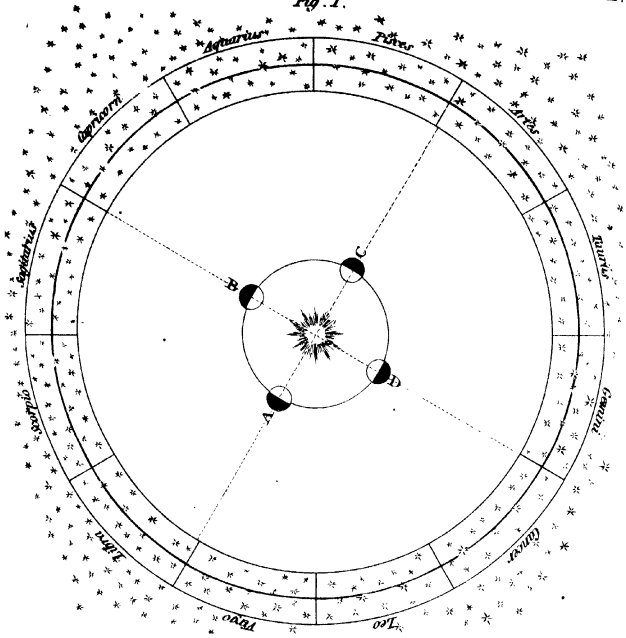
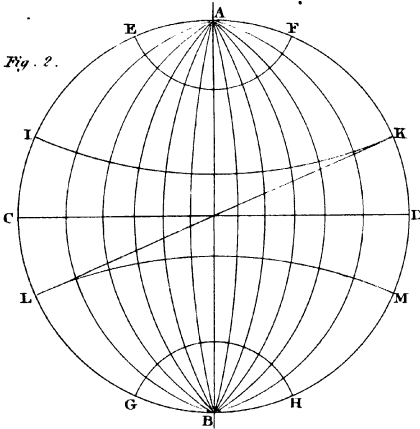


Fig. 2.



MRS. B.

It is very possible, but our present knowledge in sidereal astronomy does not justify any such conclusion.

EMILY.

Pray, Mrs. B., what are the constellations?

MRS. B.

They consist of these fixed or luminous stars, which the ancients, in order to recognise, formed into groups, and to which they gave the names of the figures which you find delineated on the celestial globe. In order to show their proper situations in the heavens, they should be painted on the internal surface of a hollow sphere, from the centre of which you should view them: you would then behold them as they appear to be situated in the heavens. The twelve constellations, called the Signs of the Zodiac, are those which are so situated that the earth in its annual revolution passes directly between them and the sun. Their names are, Aries, Taurus, Gemini, Cancer, Leo, Virgo, Libra, Scorpio, Sagittarius, Capricornus, Aquarius, Pisces; the whole occupying a complete circle, or broad belt, in the heavens, called the Zodiac. (Plate VIII. fig. 1.) Hence, a right line drawn from the earth, and passing through the sun, would reach one of these constellations, and the sun is said to be in that constellation at

which the line terminates. Thus, when the earth is at A, the sun would appear to be in the constellation or sign Aries; when the earth is at B, the sun would appear in Cancer; when the earth is at C, the sun would be in Libra; and when the earth is at D, the sun would be in Capricorn. This circle, in which the sun thus appears to move, and which passes through the middle of the zodiac, is called the Ecliptic.

CAROLINE.

But many of the stars in these constellations appear to be beyond the zodiac.

MRS. B.

I have already observed that we have no means of ascertaining the distance of the fixed stars. When, therefore, they are said to be in the zodiac, it is merely implied that they are situated in that direction, and that they shine upon us through that portion of the heavens which we call the zodiac.

CAROLINE.

It is difficult to conceive that those large bright stars, which are called stars of the first magnitude, are not nearer to us than those small ones which we can scarcely discern?

MRS. B.

It may be so; or the difference of size and brilliancy of the stars may proceed from their difference of dimension: this is a point which

astronomers are not enabled to determine. Considering them as suns, I see no reason why different suns should not vary in dimensions as well as the planets belonging to them.

EMILY.

What a wonderful and beautiful system this is! and how astonishing to think that every fixed star may probably be attended by a similar train of planets!

CAROLINE.

You will accuse me of being very incredulous; but I cannot help still entertaining some doubts, and fearing that there may be more beauty than truth in this system: there does not appear to me to be sufficient evidence to prove it. It seems so plain and obvious that the earth is motionless, and that the sun and stars revolve round it. Your solar system, you must allow, is directly in opposition to the evidence of our senses.

MRS. B.

Our senses, or, at least, the inferences we draw from them, so often mislead us, that we should not place implicit reliance upon them.

CAROLINE.

On what, then, can we rely; for do we not receive all our ideas through the medium of our senses?

MRS. B.

It is true that they are our primary source of knowledge; but the mind has the power of reflecting, judging, and deciding upon the ideas received by the organs of sense. This faculty, which we call reason, has frequently proved to us that our senses are apt to deceive us. If you have ever sailed on the water with a very steady breeze, you must have seen the houses, trees, and every object move while you were sailing.

CAROLINE.

I remember thinking so, when I was very young; but I now know that their motion is only apparent. It is true that my reason, in this case, corrects the error of my first impression.

MRS. B.

It teaches you that the apparent motion of the objects on shore proceeds from your being yourself moving, and that you are not sensible of your own motion, because you meet with no resistance. It is only when some obstacle impedes our motion that we are conscious of moving; and were you to close your eyes, while sailing on calm water with a steady wind, you would not perceive that you moved; for you could not feel it, (unless, indeed, from the increased or diminished resistance of the air), and you could see it only by observing the change of place of the objects on shore. So it is

with the motion of the earth: every thing on its surface, and the air which surrounds it, accompanies it in its revolution; it meets with no resistance; therefore, like the crew of a vessel sailing with a fair wind, in a calm sea, we are insensible of our motion.

CAROLINE.

But the principal reason why the crew of a vessel in a calm sea do not perceive their motion is because they move exceedingly slowly, while the earth, you say, revolves with great velocity.

MRS. B.

It is not because they move slowly, but because they move steadily, and meet with no irregular resistances, that the crew of a vessel do not perceive their motion; for they would be equally insensible to it with the strongest wind, provided that it did not agitate the water: but this condition, you know, is not possible; for the wind will always produce waves, which offer more or less resistance to the vessel, and then the motion becomes sensible, because it is unequal.

CAROLINE.

But, granting this, the crew of a vessel have a proof of their motion, though insensible, which the inhabitants of the earth cannot have,—the apparent motion of the objects on shore.

MRS. B.

Have we not a similar proof of the earth's motion in the apparent motion of the sun and stars? Imagine the earth to be sailing round its axis, and successively passing by every star, which, like the objects on land, we suppose to be moving instead of ourselves. I have heard it observed by an aërial traveller in a balloon, that the earth seems to sink beneath the balloon, instead of the balloon appearing to rise above the earth.

It is a law which we discover throughout nature, and worthy of its great Author, that all its purposes are accomplished by the most simple means; and what reason have we to suppose this law infringed, in order that our earth may remain at rest while the sun and stars move around us? Their regular motions, which are explained by the laws of attraction, on the first supposition, would be unintelligible on the last, and the order and harmony of the universe be destroyed. Think what an immense circuit the sun and stars would make daily, were their apparent motions real. We know many of them to be bodies more considerable than our earth; for our eyes vainly endeavour to persuade us that they are little brilliants sparkling in the heavens, while science teaches us that they are immense spheres, whose apparent dimensions are diminished by distance. If the heavenly bodies revolved round our earth in twenty-

four hours, the centrifugal force implied in so rapid a motion would be quite destructive, and no power can be assigned which would be sufficient to balance it; grindstones, driven by machinery in manufactories, have been known to fly in pieces from their great velocity. Why, then, should these enormous globes daily traverse such a prodigious space merely to prevent the necessity of our earth's revolving on its axis?

CAROLINE.

I think I must now be convinced. But you will, I hope, allow me a little time to familiarise myself to an idea so different from that which I have been accustomed to entertain. And pray, at what rate do we move?

MRS. B.

The motion produced by the revolution of the earth on its axis is about eleven miles a minute to an inhabitant of London.

EMILY.

But does not every part of the earth move with the same velocity?

MRS. B.

A moment's reflection would convince you of the contrary. A person at the equator must move quicker than one situated near the poles, since they both perform a revolution in twenty-four hours.



EMILY.

True: the equator is farthest from the axis of motion. But in the earth's revolution round the sun every part must move with equal velocity.

MRS. B.

Yes; about a thousand miles a minute.

CAROLINE.

How astonishing!—and that it should be possible for us to be insensible to such a rapid motion.

You would not tell me this sooner, Mrs. B., for fear of increasing my incredulity.

Before the time of Newton, was not the earth supposed to be in the centre of the system, and the sun, moon, and stars, to revolve round it?

MRS. B.

This was the system of Ptolemy in ancient times; but as long ago as the beginning of the sixteenth century it was discarded, and the solar system, such as I have shown you, was established by the celebrated astronomer Copernicus, and is hence called the Copernican system. But the theory of gravitation, the source from which this beautiful and harmonious arrangement flows, we owe to the powerful genius of Newton, who lived at a much later period.

## EMILY.

It appears, indeed, far less difficult to trace by observation the motion of the planets, than to divine by what power they are impelled and guided. I wonder how the idea of gravitation could first have occurred to Sir Isaac Newton.

## MRS. B.

It is said to have been occasioned by a circumstance from which one should little have expected so grand a theory to have arisen. During the prevalence of the plague in the year 1665, Newton retired into the country to avoid the contagion: when sitting one day in his orchard, he observed an apple fall from a tree, which led to a train of thought whence this theory of universal gravitation was ultimately developed. His first reflection, I believe, was whether the apple would fall to the earth if removed to a great distance from it; and then how far it would require to be removed from the earth, before it would cease to be attracted:—would it retain its tendency to fall at the distance of a thousand miles, or ten thousand, or at the distance of the moon? And here the idea occurred to him, that it was not impossible that the moon herself might have a similar tendency, and gravitate to the earth just like the bodies on or near its surface; and that this gravitation might possibly be the power which

balanced the centrifugal force implied in her motion in her orbit. It was then natural to extend this idea to the other planets, and consider them as gravitating towards the sun, in the same manner as the moon gravitates towards the earth. He followed up this interesting hypothesis by a series of calculations and demonstrations, unparalleled for their originality, and for the industry and judgment with which they were conducted, until he established the stupendous doctrine of universal gravitation.

CAROLINE.

Who would ever have imagined that the simple circumstance of the fall of an apple would have led to such magnificent results?

MRS. B.

It is the mark of superior genius to find matter for observation and research in circumstances which, to the ordinary mind, appear trivial, because they are common, and with which they are satisfied, because they are natural, without reflecting that nature is our grand field of observation; that within it is contained our whole store of knowledge; in a word, that to study the works of nature is to learn to appreciate and admire the wisdom of God. Thus the fall of an apple led to the discovery of the laws upon which the Copernican system is founded; and whatever credit this

system had obtained before, it now rests upon a basis from which it cannot be shaken.

EMILY.

This was a most fortunate apple, and more worthy to be commemorated than all those which have been recorded by the poets. The apple of discord for which the goddesses contended; the golden apples by which Atalanta lost the race; nay, even the apple which William Tell shot from the head of his son, cannot be compared to the apple of Newton!

## CONVERSATION IX.

## ON THE EARTH.

OF THE TERRESTRIAL GLOBE.—OF THE FIGURE OF THE EARTH.—OF THE PENDULUM.—OF THE VARIATION OF THE SEASONS, AND OF THE LENGTH OF DAYS AND NIGHTS.—OF THE CAUSES OF THE HEAT OF SUMMER.—OF SOLAR, SIDEREAL, AND EQUAL, OR MEAN TIME.

MRS. B.

As the earth is the planet in which we are the most particularly interested, it is my intention, this morning, to explain to you the effects resulting from its annual and diurnal motions; but for this purpose it will be necessary to make you acquainted with the terrestrial globe. You have not, either of you I conclude, learnt the use of the globes?

CAROLINE.

No. I once indeed learnt by heart the names of the lines marked on the globe; but as I was

informed they were only imaginary divisions, they did not appear to me worthy of much attention, and were soon forgotten.

MRS. B.

You supposed, then, that astronomers have been at the trouble of inventing a number of lines to little purpose. It will be impossible for me to explain to you the particular effects of the earth's motion, without your having acquired a knowledge of these lines. In Plate VIII. fig. 2. you will find them all delineated; and you must learn them perfectly, if you wish to make any proficiency in astronomy.

CAROLINE.

I was taught them at so early an age that I could not understand their meaning; and I have often heard you say, that the only use of words was to convey ideas.

MRS. B.

The names of these lines would have conveyed ideas of the figures they were designed to express, though the use of these figures might at that time have been too difficult for you to understand. Childhood is the season when impressions on the memory are most strongly and most easily made; it is the period at which a large stock of ideas should be treasured up, the application of which we may learn when the understanding is more

developed. It is, I think, a very mistaken notion that children should be taught such things only as they can perfectly understand. Had you been early made acquainted with the terms which relate to figure and motion, how much it would have facilitated your progress in natural philosophy. I have been obliged to confine myself to the most common and familiar expressions, in explaining the laws of nature, though I am convinced that appropriate and scientific terms would have conveyed more precise and accurate ideas ; but I was afraid of not being understood.

EMILY.

You may depend upon our learning the names of these lines thoroughly, Mrs. B. But before we commit them to memory, will you have the goodness to explain them to us ?

MRS. B.

Most willingly. This globe, or sphere, represents the earth ; the line which passes through its centre, and on which it turns, is called its axis ; and the two extremities of the axis, A and B, are the poles, distinguished by the names of the north and the south pole. The circle CD, which divides the globe into two equal parts between the poles, is called the equator, or equinoctial line, because it divides the globe into two equal parts ; that part of the globe to the north of the equator bears

the name of the northern hemisphere; that part to the south of the equator, the southern hemisphere. The small circle EF, which surrounds the north pole, is called the arctic circle; that, GH, which surrounds the south pole, the antarctic circle. There are two intermediate circles between the polar circles and the equator; that to the north, IK, called the tropic of Cancer; that to the south LM, called the tropic of Capricorn. Lastly this circle, LK, which divides the globe into two equal parts, crossing the equator, and extending northward as far as the tropic of Cancer, and southward as far as the tropic of Capricorn, is distinguished by the name of the ecliptic. The delineation of the ecliptic on the terrestrial globe is not without danger of conveying false ideas; for the ecliptic (as I have before said) is an imaginary circle in the heavens, passing through the middle of the zodiac, and situated in the plane of the earth's orbit.

CAROLINE.

I do not understand the meaning of the plane of the earth's orbit.

MRS. B.

A plane, or plain, is an even level surface. Let us suppose a smooth thin solid plane cutting the sun through the centre, extending out as far as the fixed stars, and terminating in a circle, which passes through the middle of the zodiac. In this plane the



earth would move in its revolution round the sun; it is therefore called the plane of the earth's orbit, and the circle in which this plane cuts the signs of the zodiac is the ecliptic. Let the fig. 1. Plate IX. represent such a plane, S the sun, E the earth with its orbit, and ABCD the ecliptic passing through the middle of the zodiac.

EMILY.

If the ecliptic relates only to the heavens, why is it described upon the terrestrial globe?

MRS. B.

It is convenient for the demonstration of a variety of problems in the use of the globes; and besides, the obliquity of this circle to the equator is rendered more conspicuous by its being described on the same globe; and the obliquity of the ecliptic shows the inclination of the earth's axis to the plane of its orbit. But to return to fig. 2. Plate VIII.

The spaces between the several parallel circles on the terrestrial globe are called zones; that which is comprehended between the tropics is distinguished by the name of the torrid zone; the spaces which extend from the tropics to the polar circles, the north and south temperate zones; and the spaces contained within the polar circles, the frigid zones.

The several lines which, you observe, are drawn from one pole to the other, cutting the equator at

Fig. 1.

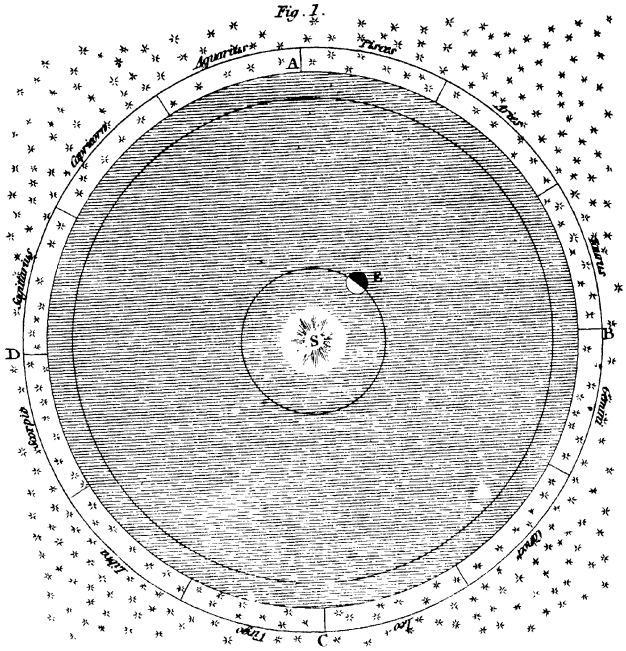
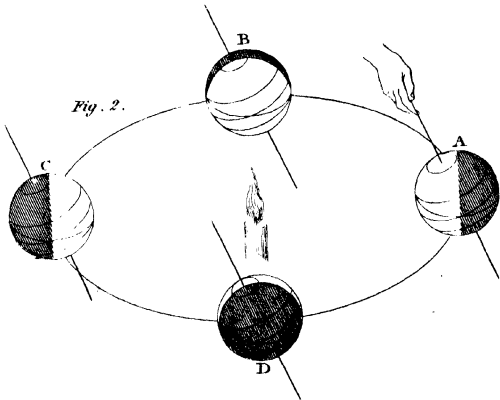


Fig. 2.





right angles, are called meridians. When any one of these meridians is exactly opposite the sun, it is mid-day, or twelve o'clock in the day, with all the places situated on that meridian; and, with the places situated on the opposite meridian, it is consequently midnight.

EMILY.

To places situated equally distant from these two meridians, it must then be six o'clock.

MRS. B.

Yes. If they are to the east of the sun's meridian, it is six o'clock in the afternoon, because the sun will have previously passed over them; if to the west, it is six o'clock in the morning, and the sun will be proceeding towards that meridian.

Those circles which divide the globe into two equal parts, such as the equator and the ecliptic, are called greater circles; to distinguish them from those which divide it into two unequal parts, as the tropics and polar circles, which are called lesser circles. All circles are divided into 360 equal parts, called degrees, and these degrees into 60 equal parts, called minutes. The diameter of a circle is a right line drawn across it, and passing through the centre; the diameter is equal to a little less than one third of the circumference. Can you tell me how many degrees it contains?

CAROLINE.

It must be something less than one third of 360 degrees or nearly 120 degrees, or, more accurately, about 115 degrees of the circle itself.

MRS. B.

Right: now, Emily, you may tell me exactly how many degrees are contained in a meridian.

EMILY.

A meridian, reaching from one pole to the other, is half a circle, and must therefore contain 180 degrees.

MRS. B.

Very well; and what number of degrees are there from the equator to the poles?

CAROLINE.

The equator being equally distant from either pole, that distance must be half of a meridian, or a quarter of the circumference of the circle, and contain 90 degrees.

MRS. B.

Besides the usual division of circles into degrees, the ecliptic is divided into twelve equal parts, called signs, which bear the name of the constellations through which this circle passes in the heavens. The degrees measured on the meridians from north to south, or south to north, are called

degrees of latitude; those measured from east to west on the equator, or any of the lesser circles parallel to it, are degrees of longitude; these lesser circles are called parallels of latitude, because being every where at the same distance from the equator, the latitude of every point contained in any one of them is the same.

EMILY.

The degrees of longitude must, then, vary in length according to the dimensions of the circle on which they are reckoned; those, for instance, at the polar circles will be considerably smaller than those of the equator?

MRS. B.

Certainly; since the degrees of circles of different dimensions do not vary in number, they must necessarily vary in length. The degrees of latitude, you may observe, never vary in length, the meridians on which they are reckoned being all of the same dimensions.

EMILY.

And of what length is a degree of latitude?

MRS. B.

Sixty geographical miles, which is equal to  $69\frac{1}{2}$  English statute miles.

EMILY.

The degrees of longitude at the equator must, then, be of the same dimensions as those of latitude?

MRS. B.

They would, were the earth a perfect sphere; but its form is not exactly spherical, being somewhat protuberant about the equator, and flattened towards the poles, resembling the form of an orange. This form proceeds from the superior action of the centrifugal power at the equator.

CAROLINE.

I thought I had understood the centrifugal force perfectly, but I do not comprehend its effect in this instance.

MRS. B.

You know that the revolution of the earth on its axis must give every particle a tendency to fly off from the centre, that this tendency is stronger or weaker in proportion to the velocity with which the particle moves; now a particle situated near one of the polar circles makes one rotation in the same space of time as a particle at the equator; the latter, therefore, having a much larger circle to describe, travels proportionally faster, consequently, the centrifugal force is much stronger at the equator than at the polar circles: it gradually

decreases as you leave the equator and approach the poles, where, as there is no rotatory motion, it entirely ceases. Supposing, therefore, the earth to have been originally in a fluid state, the particles in the torrid zone would recede much farther from the centre than those in the frigid zone; thus the polar regions would become flattened, and those about the equator elevated.

CAROLINE.

I did not consider that the particles in the neighbourhood of the equator move with greater velocity than those about the poles; this was the reason I could not understand you.

MRS. B.

You must be careful to remember, that those parts of a body which are farthest from the centre of motion move with the greatest velocity; the axis of the earth is the centre of its diurnal motion, and the equatorial regions the parts most distant from the axis.

CAROLINE.

My head, then, moves faster than my feet; and upon the summit of a mountain we are carried round quicker than in a valley?

MRS. B.

Certainly. Your head is more distant from the centre of motion than your feet; the mountain-top



than the valley: and the more distant any part of a body is from the centre of motion, the larger is the circle it will describe, and the greater, therefore, must be its velocity.

CAROLINE.

And is there no danger of the inhabitants of the equatorial regions being carried off in a tangent by the centrifugal force?

MRS. B.

No; fortunately the force of gravity preponderates very considerably; even at the equator it is 288 times greater than the centrifugal force.

EMILY.

I have been reflecting that if the earth be not a perfect circle——

MRS. B.

A sphere you mean, my dear. A circle is a round line, every part of which is equally distant from the centre; a sphere or globe is a round body, the surface of which is every where equally distant from the centre.

EMILY.

If, then, the earth be not a perfect sphere, but prominent at the equator, and depressed at the poles, would not a body weigh heavier at the equator than at the poles? For the earth being

thicker at the equator, the attraction of gravity perpendicularly downwards must be stronger.

MRS. B.

Your reasoning has some plausibility, but I am sorry to be obliged to add, that it is quite erroneous: for the nearer any part of the surface of a body is to the centre of attraction, the more strongly it is attracted. In regard to its effects, you might consider the power of gravity as that of a magnet placed at the centre of attraction.

EMILY.

But were you to penetrate deep into the earth, would gravity increase as you approached the centre?

MRS. B.

Certainly not; I am referring only to any situation on the surface of the earth. Were you to penetrate into the interior, the attraction of the parts above you would counteract that of the parts beneath you, and consequently diminish the power of gravity, in proportion as you approached the centre; and if you reached that point, being equally attracted by the parts all around you, gravity would cease, and you would be without weight.

EMILY.

Bodies, then, should weigh less at the equator than at the poles, since they are more distant from

the centre of gravity in the former than in the latter situation.

MRS. B.

And this is really the case ; but the difference of weight would be very trifling, were it not augmented by another circumstance.

CAROLINE.

And what is this circumstance which seems to disturb the laws of nature ?

MRS. B.

One that you are well acquainted with, as conducing more to the preservation than the destruction of order,—the centrifugal force. This we have just observed to be stronger at the equator ; and as it tends to drive bodies from the centre, it is necessarily opposed to, and must lessen, the power of gravity, which attracts them towards the centre. We accordingly find that bodies weigh lightest at the equator, where the centrifugal force is greatest ; and heaviest at the poles, where this power is least.

CAROLINE.

Has the experiment been made in these different situations ?

MRS. B.

Philosophers have travelled both to the equator and to Lapland for this purpose. The severity of

the climate, and obstruction of the ice, has hitherto rendered every attempt to reach the pole abortive ; but the difference of weight of a body at the equator and in Lapland is very perceptible.

CAROLINE.

Yet I do not comprehend how the difference of weight could be ascertained ; for if the body under trial decreased in weight, the weight which was opposed to it in the opposite scale must have diminished in the same proportion. For instance, if a pound of sugar did not weigh so heavy at the equator as at the poles, the leaden pound which served to weigh it would not be so heavy either ; therefore they would still balance each other, and the different force of gravity could not be ascertained by this means.

MRS. B.

Your observation is perfectly just : the difference of gravity of bodies situated at the poles and at the equator cannot be ascertained by weighing them ; a pendulum was therefore used for that purpose.

CAROLINE.

What, the pendulum of a clock ? how could that answer the purpose ?

MRS. B.

A pendulum consists of a line, or rod, to one end of which a weight is attached, and it is sus-

pended by the other to a fixed point, about which it is made to vibrate. When not put in motion, a pendulum, like a plumb line, hangs perpendicular to the general surface of the earth, by which it is attracted; but, if you raise a pendulum on one side, gravity will bring it back to its perpendicular position. It will, however, not remain stationary there; for the velocity it has received during its descent will impel it onwards, and it will rise on the opposite side to an equal height; from thence it is brought back by gravity, and again driven onwards by the impulse of its velocity.

CAROLINE.

If so, the motion of a pendulum would be perpetual; and I thought you said, that there was no perpetual motion on the earth.

MRS. B.

The motion of a pendulum is opposed by the resistance of the air in which it vibrates, and by the friction of the part by which it is suspended; were it possible to remove these obstacles, its motion would be perpetual, and its vibrations perfectly regular; being of equal distances, and performed in equal times.

EMILY.

That is the natural result of the uniformity of the power which produces these vibrations; for the

force of gravity being always the same, the velocity of the pendulum must be uniform.

CAROLINE.

No, Emily, you are mistaken ; the cause is not always uniform, and therefore the effect will not be so either. I have discovered it, Mrs. B. ; since the force of gravity is less at the equator than at the poles, the vibrations of the pendulum will be slower at the equator than at the poles.

MRS. B.

You are perfectly right, Caroline. It was thus that the difference of gravity was discovered, and the true figure of the earth ascertained ; for after having made due allowance for the effect of the centrifugal force, gravity was still found to be greater in the polar than in the equatorial regions, owing to the spheroidal figure of the earth.

EMILY.

But how do they contrive to regulate their time in the equatorial and polar regions ? for, since in this part of the earth the pendulum of a clock vibrates exactly once in a second, if it vibrates faster at the poles and slower at the equator, the inhabitants must regulate their clocks in a different manner from ours.

MRS. B.

The only alteration required is to lengthen the pendulum in one case, and to shorten it in the other; for the velocity of the vibrations of a pendulum depends on its length; and when it is said that a pendulum at the pole vibrates quicker than one at the equator, it is supposing them both to be of the same length. A pendulum which vibrates a second in this latitude is rather more than 39 inches in length. In order to vibrate at the equator, in the same space of time, it must be shortened by a few lines; and at the poles it must be proportionally lengthened.

I shall now, I think, be able to explain to you the variation of the seasons, and the difference of the length of the days and nights in those seasons; both effects resulting from the same cause.

In moving round the sun, the axis of the earth is not perpendicular to the plane of its orbit. Supposing this round table to represent the plane of the earth's orbit, and this little globe, which has a wire passing through it, representing the axis and poles, to be the earth; in moving round the table, the wire is not perpendicular to it, but oblique.

EMILY.

Yes; I understand the earth does not go round the sun in an upright position; its axis is slanting or oblique.

MRS. B.

All the lines, which you learnt in your last lesson, are delineated on this little globe. You must consider the ecliptic as representing the plane of the earth's orbit; and the equator, which crosses the ecliptic in two places, shows the degree of obliquity of the axis of the earth in that orbit, which is exactly  $23\frac{1}{2}$  degrees. The points in which the ecliptic cuts or intersects the equator are called nodes.

But I believe I shall make this clearer to you by revolving the little globe round a candle, which may represent the sun. (Plate IX. fig. 2.)

As I now hold it, at A, you see it situated as it is in the midst of summer, or what is called the summer solstice, which is on the 21st of June.

EMILY.

You hold the wire awry, I suppose, in order to show that the axis of the earth is not upright?

MRS. B.

Yes; in summer, the north pole is inclined towards the sun. In this season, therefore, the northern hemisphere enjoys much more of his rays than the southern. The sun, you see, now shines over the whole of the north frigid zone; and notwithstanding the earth's diurnal revolution, which I imitate by twirling the ball on the wire, it will continue to shine upon it as long as it remains in



this situation, whilst the south frigid zone is at the same time completely in obscurity.

CAROLINE.

That is very strange. I never before heard that there was constant day or constant night in any part of the world? How much happier the inhabitants of the north frigid zone must be than those of the southern; the first enjoy uninterrupted day, while the last are involved in perpetual darkness.

MRS. B.

You judge with too much precipitation. Examine a little farther, and you will find that the two frigid zones share an equal fate.

We shall now make the earth set off from its position in the summer solstice, and carry it round the sun; observe that the pole is always inclined in the same direction, and points to the same spot in the heavens. There is a fixed star situated near that spot, which is hence called the North Polar star. Now let us stop the earth at B, and examine it in its present situation: it has travelled through one quarter of its orbit, and is arrived at that point at which the ecliptic cuts or crosses the equator, and which is called the autumnal equinox.

EMILY.

That is, then, one of the nodes. The sun now shines from one pole to the other, as it would con-

stantly do, were the axis of the earth perpendicular to its orbit.

MRS. B.

Yes; because the inclination of the axis is now neither towards the sun nor in the contrary direction; at this period of the year, therefore, the days and nights are equal in every part of the earth. But the next step she takes in her orbit, you see, involves the north pole in darkness, whilst it illumines that of the south. This change was gradually preparing as I moved the earth from summer to autumn: the arctic circle, which was at first entirely illumined, began to have short nights, which increased as the earth approached the autumnal equinox; and the instant it passes that point, the long night of the north pole commences, and the south pole begins to enjoy the light of the sun. We shall now make the earth proceed in its orbit, and you may observe that, as it advances, the days shorten, and the nights lengthen, throughout the northern hemisphere until it arrives at the winter solstice, on the 21st of December, when the north frigid zone is entirely in darkness, and the southern enjoys uninterrupted daylight. Exactly half of the equator, you should observe, is enlightened in every position, and, consequently, the day is there always equal to the night.

CAROLINE.

Then, after all, the sun, which I thought so partial, confers his favours equally on all.

MRS. B.

Not entirely. The inhabitants of the torrid zone have much more heat than we have, as the sun's rays fall perpendicularly on them while they shine obliquely on the temperate, and almost horizontally on the frigid zones; for during their long day the sun moves round at no great elevation above their horizon without either rising or setting; the only observable difference is, that it is more elevated by a few degrees at mid-day than at midnight: but at the poles themselves the sun travels round in the course of four-and-twenty hours nearly at the same elevation from the horizon, rising every day a very little higher from the vernal equinox till midsummer, and declining after that period till the autumnal equinox, when their long night begins.

EMILY.

Then to a person situated in the temperate zone, as we are in England, the sun's rays will shine neither so obliquely as at the poles, nor so vertically as at the equator; and will fall upon him more obliquely in autumn and winter than in summer.

## CAROLINE.

And, therefore, the inhabitants of the earth between the polar circles and the equator will not have merely one day and one night in the year, as at the poles, nor will they have equal days and equal nights, as at the equator; but their days and nights will vary in length at different times of the year, according to the inclination of their respective poles towards or from the sun, and the difference will be greater in proportion to their distance from the equator.

## MRS. B.

We shall now follow the earth through the other half of her orbit; and you will observe that exactly the same effect takes place in the southern hemisphere, as what we have just remarked in the northern. Day commences at the south pole when night sets in at the north pole; and in every other part of the southern hemisphere the days are longer than the nights; while, on the contrary, our nights are longer than our days. When the earth arrives at the vernal equinox, D, where the ecliptic again cuts the equator, on the 22d of March, she is situated, with respect to the sun, exactly in the same position as in the autumnal equinox; and the only difference with respect to the earth is, that it is now autumn in the southern hemisphere, whilst it is spring with us.

CAROLINE.

Then the days and nights are again every where equal?

MRS. B.

Yes; for that half of the globe which is enlightened extends exactly from one pole to the other; the day breaks to the north pole, and the sun sets to the south pole; but in every other part of the globe the day and night is of twelve hours length; hence the word equinox, which is derived from the Latin, meaning equal night.

EMILY.

I should have thought that on the day of the equinox, just before the sun sets to one pole and rises to the other, it would be seen from either pole at the same time.

MRS. B.

You are quite right: at the equinox it is day both at the north and south pole; but only one half of the sun is seen at either, the other half being hid by the horizon.

CAROLINE

And for how long does this mutual *half-day* last?

MRS. B.

It takes nearly three of our days for the sun to rise or set at the poles. About 30 hours, or rather

more, before the exact time of the autumnal equinox, the upper edge or limb of the sun begins to be visible at the south pole, and it is there seen constantly travelling round the horizon, and rising gradually higher and higher, till, at the end of about 60 hours, after revolving nearly  $2\frac{1}{2}$  times round the horizon, the whole of its orb is visible.

At the same moment that the edge of the sun's disk becomes visible at the south pole, the same edge which appears as the lower limb at the north pole begins to dip below the horizon; but the sun still continues visible, travelling round the horizon, more and more of it being hid, till, at the end of 60 hours, it totally disappears, just at the same moment when it is fully seen at the south pole.

As the earth proceeds towards summer, the days lengthen in the northern hemisphere, and shorten in the southern, till the earth reaches our summer solstice, when the north frigid zone is entirely illumined, and the southern is in complete darkness; and we have now brought the earth again to the spot whence we first accompanied her.

#### EMILY.

This is, indeed, a most satisfactory explanation of the seasons; and the more I learn, the more I admire the simplicity of means by which such wonderful effects are produced.

MRS. B.

I know not which is most worthy of our admiration, the cause or the effect of the earth's revolution round the sun. The mind can find no object of contemplation more sublime than the course of this magnificent globe, impelled by the combined powers of projection and attraction to roll in one invariable course round the source of light and heat; and what can be more delightful than the beneficent effects of this vivifying power on its attendant planet? It is at once the grand principle which animates and fecundates nature.

EMILY.

There is one circumstance in which this little ivory globe appears to me to differ from the earth; it is not quite dark on that side of it which is turned from the candle, as is the case with the earth when neither moon nor stars are visible.

MRS. B.

It is owing to the light of the candle being reflected by the walls of the room on every part of this little globe, consequently that side of it on which the candle does not directly shine is not in total darkness. Now the skies have no walls to reflect the sun's light on that side of our earth which is in darkness.

CAROLINE.

I beg your pardon, Mrs. B.; I think that the moon and stars answer the purpose of walls in reflecting the sun's light to us in the night.

MRS. B.

Very well, Caroline, that is to say, the moon and planets: for the fixed stars, you know, shine by their own light.

EMILY.

You say, that the superior heat of the equatorial parts of the earth arises from the rays falling perpendicularly on those regions, whilst they fall obliquely on these more northern regions; now, I do not understand why perpendicular rays should afford more heat than oblique rays.

CAROLINE.

You need only hold your hand perpendicularly over the candle, and then hold it sideways obliquely, to be sensible of the difference.

EMILY.

I do not doubt the fact, but I wish to have it explained.

MRS. B.

You are quite right. If Caroline had not been satisfied with ascertaining the fact, without understanding it, she would not have brought forward



the candle as an illustration. The reason why you feel so much more heat if you hold your hand perpendicularly over the candle, than if you hold it sideways, is because a stream of heated vapour constantly ascends from the candle, or any other burning body, which being lighter than the air of the room, does not spread laterally, but rises perpendicularly; and this led you to suppose that the rays were hotter in the latter direction. Had you reflected, you would have discovered that rays issuing from the candle sideways are no less perpendicular to your hand when held opposite to them, than the rays which ascend when your hand is held over them.

The sun's rays afford less heat when in an oblique direction than when perpendicular, because fewer of them fall upon an equal portion of the earth. This will be understood better by referring to Plate X. fig. 1., which represents two equal portions of the sun's rays, shining upon different parts of the earth. Here it is evident, that the same quantity of rays fall on the space AB as fall on the space BC; and as AB is less than BC, the heat and light will be much stronger in the former than in the latter: AB, you see, represents the equatorial regions, where the sun shines perpendicularly; and BC, the temperate and frozen climates, where his rays fall more obliquely.

Fig. 1.

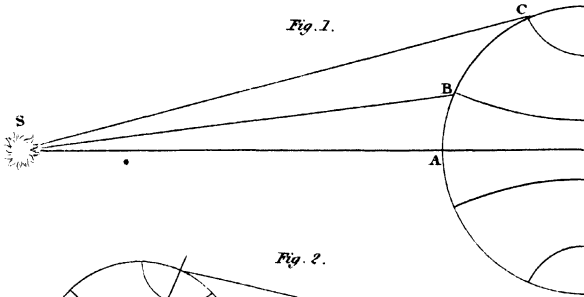


Fig. 2.

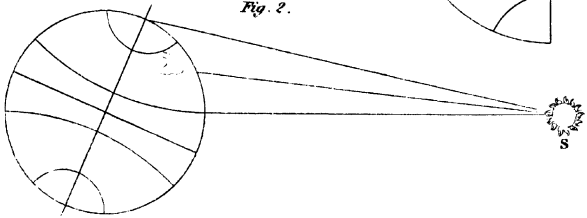


Fig. 3.

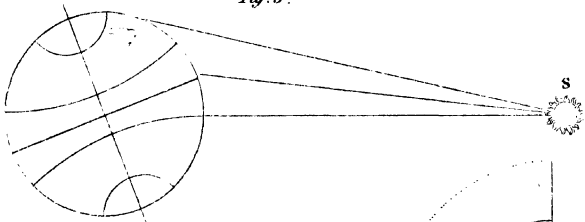
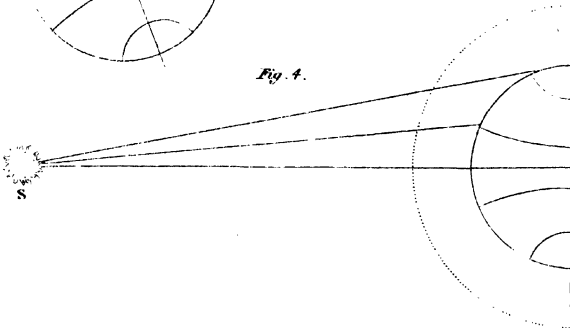


Fig. 4.





## EMILY.

This accounts not only for the greater heat of the equatorial regions, but for the greater heat of summer; as the sun shines less obliquely in summer than in winter.

## MRS. B.

This you will see exemplified in figure 2., in which the earth is represented as it is situated on the 21st of June, and England receives less oblique, and consequently a greater number of rays, than at any other season: and figure 3. shows the situation of England on the 21st of December, when the rays of the sun fall most obliquely upon her. But there is also another reason why oblique rays give less heat than perpendicular rays; which is, that they have a greater portion of the atmosphere to traverse; and though it is true that the atmosphere is itself a transparent body, still it absorbs some portion of the sun's rays; and besides, it is always loaded, more or less, with dense and foggy vapour, which absorb still more; therefore, the greater the quantity of atmosphere the sun's rays have to pass through, in their way to the earth, the fewer of them will reach it. This will be better understood by referring to figure 4. The dotted line round the earth describes the extent of the atmosphere, and the lines which proceed from the sun to the earth, the passage of two

equal portions of the sun's rays to the equatorial and polar regions; the latter you see, from its greater obliquity, passes through a greater extent of atmosphere.

CAROLINE.

And this, no doubt, is the reason why the sun in the morning and the evening gives so much less heat than at mid-day.

MRS. B.

The diminution of heat, morning and evening, is certainly owing to the greater obliquity of the sun's rays; and as such they are affected by both the causes which I have just explained to you; the loss they experience in passing through a foggy atmosphere is, perhaps, more particularly applicable to them, as mists and vapours are very prevalent about the time of sunrise and sunset.

EMILY.

With so many deductions from the sun's light, I wonder we are not reduced to twilight.

MRS. B.

At sunrise and sunset, when his rays are horizontal, and therefore pass through the greatest quantity of atmosphere, the light is diminished no less than 1300 times, merely by the absorbing power of the atmosphere.

CAROLINE.

No wonder, then, that we can look at the sun morning and evening, without suffering from his light. But I should like to know how many more rays fall upon me at mid-day than at sunrise or sunset.

MRS. B.

I cannot answer that question precisely; but I know that if you were situated at those parts of the earth where the sun's rays are vertical, out of 10,000 rays which dart from the sun, 8123 would reach you; while, if you were situated so that the rays would fall obliquely on you at an angle of  $15^{\circ}$ , only 7024 would reach you, and only five rays, out of the 10,000, if they passed horizontally.

EMILY.

What a prodigious quantity of light must then be absorbed by the atmosphere; and for what purpose?

CAROLINE.

Perhaps it may be changed into heat; and then it would be of great use in warming the atmosphere. Light is so invariably accompanied by heat, that it appears to me a very reasonable supposition.

MRS. B.

Such a conjecture has been made, but there appear to be insurmountable objections to it. For

instance, the most brilliant rays are the least hot ; but what little I can tell you of the nature of light must be reserved till we treat of optics. To return to our subject, I must inform you, that the diminished obliquity of the sun's rays is not the sole cause of the heat of summer ; the length of the days greatly conduces to it ; for the longer the sun is above the horizon, the more heat he will communicate to the earth.

CAROLINE.

Both the longest days, and the most perpendicular rays, are on the 21st of June, and yet the greatest heat prevails in July and August.

MRS. B.

Those parts of the earth which are once heated retain the heat for a considerable length of time ; and the additional quantity they receive occasions an elevation of temperature, although the days begin to shorten, and the sun's rays to fall more obliquely. For the same reason we have generally more heat at two o'clock in the afternoon than at twelve, when the sun is on the meridian.

EMILY.

And pray, have the other planets the same vicissitudes of seasons as the earth ?

MRS. B.

They vary according as their axes deviate more or less from the perpendicular to the plane of their orbits. The axis of Jupiter is nearly perpendicular to the plane of his orbit; those of Mars and of Saturn are each inclined at angles of about sixty degrees; whilst the axis of Venus is believed to be elevated only fifteen or twenty degrees above her orbit; the vicissitudes of her seasons must therefore be considerably greater than ours. For further particulars respecting the planets, I shall refer you to Bonnycastle's Introduction to Astronomy.

I have but one more observation to make to you relative to the earth's motion; which is, that although there are but 365 days and nights in the year, she performs 366 complete revolutions on her axis during that time.

CAROLINE.

How is that possible? for every complete revolution must bring the same place back to the sun. It is now just twelve o'clock; the sun is therefore on our meridian; in twenty-four hours, will it not be returned to our meridian again? and will not the earth have made a complete rotation on its axis?

MRS. B.

If the earth had no progressive motion in its orbit whilst it revolves on its axis, this would



be the case; but as it advances almost a degree westwards in its orbit, in the same time that it completes a revolution eastward on its axis, it must revolve nearly one degree more in order to bring the same meridian back to the sun.

CAROLINE.

Oh, yes! it will require as much more of a second revolution to bring the same meridian back to the sun as is equal to the space the earth has advanced in her orbit, that is, nearly a degree; this difference is, however, very trifling.

MRS. B.

These small daily portions of rotation are each equal to the three hundred and sixty-fifth part of a circle, which at the end of the year amounts to one complete rotation.

EMILY.

That is extremely curious. If the earth, then, had no other than its diurnal motion, we should have 366 days in the year.

MRS. B.

We should have 366 days in the same period of time that we now have 365; but if we did not revolve round the sun, we should have no natural means of computing years.

You will be surprised to hear, that, if time be

calculated by the stars instead of the sun, the irregularity which we have just noticed does not occur, and that one complete rotation of the earth on its axis brings the same meridian back to any fixed stars.

EMILY.

That seems quite unaccountable; for the earth advances in her orbit with regard to the fixed stars the same as with regard to the sun.

MRS. B.

True: but then the distance of the fixed stars is so immense, that our solar system is in comparison to it but a spot, and the whole extent of the earth's orbit but a point; therefore, whether the earth remained stationary, or whether it revolved in its orbit during its rotation on its axis, no sensible difference would be produced with regard to the fixed stars. One complete revolution brings the same meridian back to the same fixed star; hence the fixed stars appear to go round the earth in a shorter time than the sun by three minutes fifty-six seconds of time.

CAROLINE.

These three minutes fifty-six seconds is the time which the earth takes to perform the additional three hundred and sixty-fifth part of the circle, in order to bring the same meridian back to the sun.

MRS. B.

Precisely. Hence the stars gain every day three minutes fifty-six seconds on the sun, which makes them rise that portion of time earlier every day.

When time is calculated by the stars, it is called sidereal time; when by the sun, solar or apparent time.

CAROLINE.

Then a sidereal day is three minutes fifty-six seconds shorter than a solar day of twenty-four hours.

MRS. B.

I must also explain to you what is meant by a sidereal year.

The common year, called the solar or tropical year, containing 365 days, five hours, forty-eight minutes, and fifty-two seconds, is measured from the time the sun sets out from one of the equinoxes, or solstices, till it returns to the same again; but this year is completed before the earth has finished one entire revolution in its orbit.

EMILY.

I thought that the earth performed one complete revolution in its orbit every year; what is the reason of this variation?

MRS. B.

It is owing to the spheroidal figure of the earth. The elevation about the equator produces much



Fig. 1.

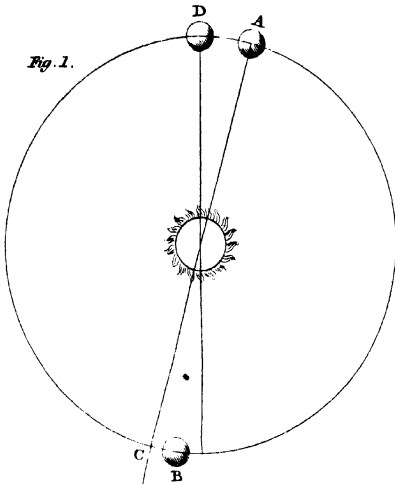
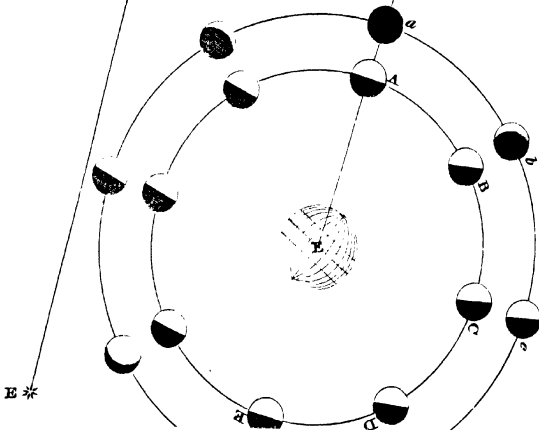


Fig. 2.



the same effect as if a similar mass of matter, collected in the form of a moon, revolved round the equator. When this moon acted on the earth in conjunction with, or in opposition to the sun, variations in the earth's motion would be occasioned; and these variations produce what is called the precession of the equinoxes.

EMILY.

What does that mean? I thought the equinoctial points, or nodes, were fixed points in the heavens, in which the equator cuts the ecliptic.

MRS. B.

These points are not quite fixed, but have an apparently retrograde motion; that is to say, instead of being every revolution in the same place, they move backwards. Thus if the vernal equinox be at A (fig. 1. plate XI.), the autumnal one will be at B, instead of C, and the following vernal equinox at D, instead of at A, as would be the case if the equinoxes were stationary at opposite points of the earth's orbit.

CAROLINE.

So that, though the earth takes half a year to move from one equinox to the other, it has not travelled through half its orbit.

MRS. B.

And, consequently, when it returns again to the first equinox, it has not completed the whole of its orbit. In order to ascertain when the earth has performed an entire revolution in its orbit, we must observe when the sun returns in conjunction with any fixed star; and this is called a sidereal year. Supposing a fixed star situated at E (fig. 1. plate XI.), the sun would not appear in conjunction with it till the earth had returned to A, when it would have completed its orbit.

EMILY.

And how much longer is the sidereal than the solar year?

MRS. B.

Only twenty minutes; so that the variation of the equinoctial points is very inconsiderable. I have given them a greater extent in the figure, in order to render them sensible.

In regard to time, I must farther add, that the earth's diurnal motion, on an inclined axis, together with its annual revolution in an elliptic orbit, occasions so much complication in its motion as to produce many irregularities; therefore true equal time cannot be measured by the sun. A clock, which was always perfectly correct, would in some parts of the year be before the sun, and in other parts after it. There are but four periods

in which the sun and a perfect clock would agree, which are the 15th of April, the 16th of June, the 31st of August, and the 24th of December.

EMILY.

And is there any considerable difference between solar time and true time?

MRS. B.

The greatest difference amounts to between fifteen and sixteen minutes. Tables of equation are constructed for the purpose of pointing out and correcting these differences between solar time and equal or mean time, which is the denomination given by astronomers to true time.

CAROLINE.

So, then, the old planets are subject to irregularities in their motions, as well as the new one.

MRS. B.

Undoubtedly; since the law of gravitation is universal, the several planets and their satellites mutually influence and disturb the regularity of each other's motions. We have already observed this in Jupiter and Saturn, and it is supposed that the attraction of the new planet may hereafter be traced as far as Saturn.



CAROLINE.

I know not whether most to wonder at, or admire the science of astronomy, which is able to unravel such a complication of causes and effects.

MRS. B.

What we ought most to admire, is the simple principle upon which so complicated, and yet so harmonious, a system is founded. Nor can we be ever sufficiently grateful to its bounteous Author for giving us understanding to comprehend these mysteries: without such knowledge we should never have been able to explore our own little planet; and if we cannot read the stars as astrologers formerly did, we study them now to a much better purpose. But you will understand this better as we proceed.

## CONVERSATION X.

## ON THE MOON.

OF THE MOON'S MOTION.—PHASES OF THE MOON.—  
 ECLIPSES OF THE MOON.—ECLIPSES OF JUPITER'S  
 MOONS.—OF THE LATITUDE AND LONGITUDE.—  
 OF THE TRANSITS OF THE INFERIOR PLANETS.—OF  
 THE TIDES.

MRS. B.

WE shall to-day confine our attention to the moon, which offers many interesting phenomena.

The moon revolves round the earth in the space of twenty-seven days eight hours, in an orbit nearly coinciding with the plane of the earth's orbit, and accompanies us in our revolution round the sun.

EMILY.

Her motion, then, must be rather of a complicated nature; for as the earth is not stationary, but advances in her orbit whilst the moon goes

round her, the moon must proceed in a sort of progressive circle.

MRS. B.

That is true; and there are also other circumstances which interfere with the simplicity and regularity of the moon's motion, but which are too intricate for you to understand at present.

The moon always presents the same face to us, by which it is evident that she turns but once upon her axis, while she performs a revolution round the earth; so that the inhabitants of the moon have but one day and one night in the course of a lunar month.

CAROLINE.

We afford them, however, the advantage of a magnificent moon to enlighten their long nights.

MRS. B.

That advantage is but partial; for since we always see the same hemisphere of the moon, the inhabitants of that hemisphere alone can perceive us.

CAROLINE.

One half of the moon, then, enjoys our light every night, while the other half has constantly nights of darkness. If there are any astronomers in those regions, they would doubtless be tempted to visit the other hemisphere in order to behold so grand a luminary as we must appear to them.

But, pray, do they see the earth under all the changes which the moon exhibits to us?

MRS. B.

Exactly so. These changes are called the phases of the moon, and require some explanation. In fig. 2. plate XI. let us suppose that S represents the sun, E the earth, and A, B, C, D, the moon in different parts of her orbit. When the moon is at A, her dark side being turned towards the earth, we shall not see her, as at *a*; but her disappearance is of very short duration, and as she advances in her orbit we perceive her under the form of a new moon: when she has gone through one sixth of her orbit at B, one quarter of her enlightened hemisphere will be turned towards the earth, and she will then appear horned, as at *b*; when she has performed one quarter of her orbit, she shows us one half of her enlightened side, as at *c*: at *d* she is said to be gibbous, and at *e* the whole of the enlightened side appears to us, and the moon is at full. As she proceeds in her orbit she becomes again gibbous, and her enlightened hemisphere turns gradually away from us till she completes her orbit and disappears, and then again resumes her form of a new moon.

When the moon is at full, she is said to be in opposition; when a new moon, to be in conjunction, with the sun. At each of these times, the sun,

the moon, and the earth are in the same right line ; but, in the first case, the earth is between the sun and the moon ; in the second the moon is between the sun and the earth.

EMILY.

Are not the eclipses produced by the moon passing between the sun and the earth ?

MRS. B.

Yes. When the moon passes between the sun and the earth she intercepts his rays, or, in other words, casts a shadow on the earth ; then the sun is eclipsed, and the daylight gives place to darkness, while the moon's shadow is passing over us.

When, on the contrary, the earth is between the sun and the moon, it is we who intercept the sun's rays, and cast a shadow on the moon: the moon is then darkened ; she disappears from our view, and is eclipsed.

EMILY.

But as the moon goes round the earth every month, she must be once during that time between the earth and the sun, and the earth must likewise be once between the sun and the moon ; and yet we have not a solar and a lunar eclipse every month !

MRS. B.

The planes of the orbits of the earth and moon do not exactly coincide, but cross or intersect each



Fig. 1.

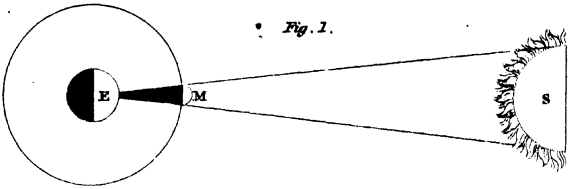


Fig. 2.

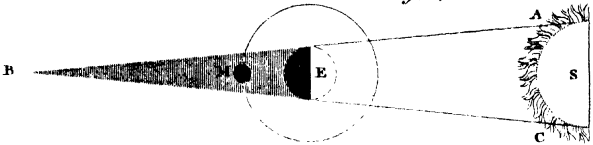


Fig. 3.

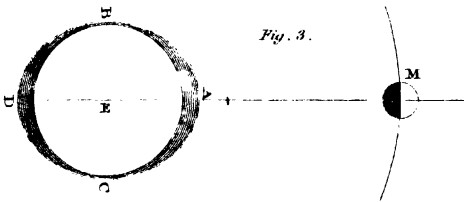


Fig. 4.

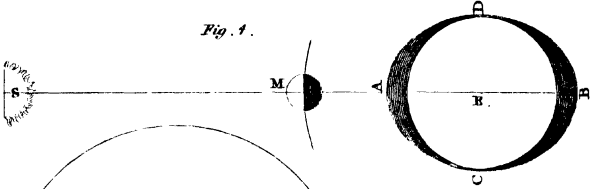
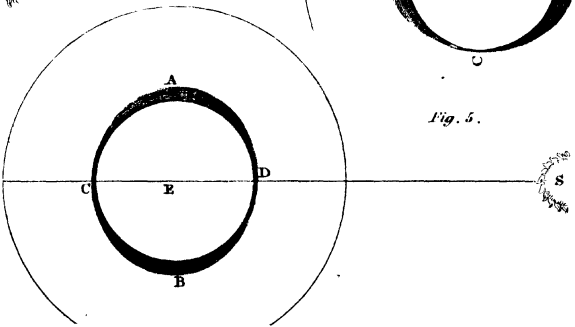


Fig. 5.



other; and the moon generally passes ~~either on one~~ <sup>either on one</sup> side or the other when she is in conjunction with or in opposition to the sun, and therefore does not intercept the sun's rays, or produce an eclipse; for this can take place only when the earth and moon are in conjunction near that part of their orbits which cross each other (called the nodes of their orbits), because it is then only that they are both in the same plane, and in a right line with the sun.

EMILY.

And a partial eclipse takes place, I suppose, when the moon, in passing by the earth, is not sufficiently on one side or the other of the earth's shadow entirely to escape it.

MRS. B.

Yes: one edge of her disk then dips into the shadow, and is eclipsed. When the eclipse happens precisely at the nodes, they are not only total but last for some length of time.

When the sun is eclipsed, the total darkness is confined to one particular part of the earth, evidently showing that the moon is smaller than the earth, since she cannot entirely skreen it from the sun. In fig. 1. pl. XII. you will find a solar eclipse exhibited: S is the sun, M the Moon, and E the earth; in this case the moon's shadow, you see, is not large enough to cover the earth. The lunar



eclipses, on the contrary, are visible from every part of the earth, where the moon is above the horizon.

In fig. 2. S represents the sun, which pours forth rays of light in straight lines in every direction; E is the earth, and M the moon. Now a ray of light coming from one extremity of the sun's disk in the direction A B, will meet another coming from the opposite extremity in the direction C B; the shadow of the earth cannot, therefore, extend beyond B. As the sun is larger than the earth, the shadow of the latter is conical, or the figure of a sugar-loaf; it gradually diminishes, and is much smaller than the earth where the moon passes through it, and yet we find the moon to be not only totally eclipsed, but some length of time in darkness. The length of the eclipse depends on the respective situations, distances, and magnitudes of the sun, earth, and moon. The diameter of the moon is about  $\frac{3}{11}$  of that of the earth; or the whole bulk of the earth about 49 times that of the moon.

EMILY.

When the moon eclipses the sun to us, we must be eclipsed to the moon.

MRS. B.

Certainly: for if the moon intercept the sun's rays, and cast a shadow on us, we must necessarily disappear to the moon, but only partially;

only a black spot will appear to pass over the earth, as in fig. 1.

CAROLINE.

There must be a great number of eclipses in the distant planets, which have so many moons.

MRS. B.

Yes: few days elapse without an eclipse taking place; for among the number of satellites, one or other of them are continually passing between their planet and the sun. Astronomers are so well acquainted with the motion of the planets and their satellites, that they have calculated not only the eclipses of our moon, but those of Jupiter, with such perfect accuracy, that it has afforded a means of ascertaining the longitude.

CAROLINE.

But is it not very easy to find both the latitude and longitude of any place by a map or globe?

MRS. B.

If you know where you are situated, there is no difficulty in ascertaining the latitude or longitude of the place by referring to a map; but the question is to find out your situation when you do not know where you are: for instance, supposing that you had been a length of time at sea, interrupted in your course by storms, a map would afford you very little assistance in discovering where you were.

CAROLINE.

Under such circumstances, I confess I should be equally at a loss to discover either latitude or longitude.

MRS. B.

The latitude may be easily found by taking the altitude of the pole ; that is to say, observing the number of degrees that it is elevated above the horizon, for the pole appears more elevated as we approach it, and less as we recede from it.

CAROLINE.

But, unless you can see the pole, how can you take its altitude ?

MRS. B.

The north pole points constantly towards one particular part of the heavens near which a star is situated, called the Polar Star : this star is visible on clear nights from every part of the northern hemisphere ; the altitude of the polar star is therefore nearly the same number of degrees as that of the pole. The latitude may be more accurately determined by observations made on the sun or any of the fixed stars ; the situation therefore of a vessel at sea, with regard to north and south, is easily ascertained. The difficulty is respecting east and west, that is to say, its longitude. As there are no eastern and western poles from which we can reckon our distance, some particular spot must be

fixed upon for that purpose. The English reckon from the meridian of Greenwich, where the Royal Observatory is situated: in French maps you will find that the longitude is reckoned from Paris.

The rotation of the earth on its axis in 24 hours, from west to east, occasions, you know, an apparent motion of the sun and stars in the contrary direction, and the sun appears to go round the earth in the space of 24 hours, passing over fifteen degrees, or a twenty-fourth part of the earth's circumference, every hour; therefore when it is twelve o'clock in London, it is one o'clock in any place situated fifteen degrees to the east of London, as the sun must have passed the meridian of that place an hour before he reaches that of London. For the same reason it is eleven o'clock at any place situated fifteen degrees to the west of London, as the sun will not come to that meridian till an hour later.

If, then, the captain of a vessel at sea could know precisely what was the hour at London, he could, by looking at his watch, and comparing it with the hour of the spot in which he was, ascertain the longitude.

EMILY.

But if he had not altered his watch since he sailed from London, it would indicate the hour in London, not that of the spot in which he was situated?

MRS. B.

True; but in order to know the hour of day of the spot in which he is, the captain of a vessel regulates his watch by the sun when it reaches the meridian.

EMILY.

Then if he had two watches, he might keep one regulated daily, and leave the other unaltered. The former would indicate the hour of the place in which he was situated, and the latter the hour of London; and by comparing them together, he would be able to calculate his longitude.

MRS. B.

You have discovered, Emily, a mode of finding the longitude, which I have the pleasure to tell you is universally adopted. Watches of a superior construction, called chronometers, or time-keepers, are used for this purpose; but the best watches are liable to imperfection, and should the time-keeper go too fast, or too slow, there would be no means of ascertaining the error; implicit reliance cannot consequently be placed upon them.

Recourse is therefore had to the eclipses of Jupiter's satellites. A table is made of the precise time at which the several moons are eclipsed to a spectator at London. When they appear eclipsed to a spectator in any other spot, he may,

by consulting the table, know what is the hour at London; for the eclipse is visible at the same moment from whatever place on the earth it is seen. He has then only to look at the watch which points out the hour of the place in which he is, and by observing the difference of time there, and at London, he may immediately determine his longitude.

Let us suppose a certain moon of Jupiter to be always eclipsed at six o'clock in the evening; and that a man at sea consults his watch, and finds that it is ten o'clock at night, where he is situated, at the moment the eclipse takes place; what will be his longitude?

EMILY.

That is four hours later than in London: the sun moves over 15 degrees an hour, and four times fifteen make 60; he would, therefore, be sixty degrees east of London, for the sun must have passed his meridian before it reaches that of London.

MRS. B.

For this reason, the hour is always later than in London when the place is east longitude, and earlier when it is west longitude. Thus the longitude can be ascertained whenever the eclipses of Jupiter's moons are visible.

## CAROLINE.

The longitude, then, shows you on what meridian you are situated, and the latitude on what part of that meridian.

## MRS. B.

Precisely so ; but it is not only the secondary planets which produce eclipses, for the primary planets near the sun eclipse him to those at a greater distance when they come in conjunction in the nodes of their orbits ; but as the primary planets are much longer in performing their course round the sun, than the satellites in going round their primary planets, these eclipses very seldom occur.

Mercury and Venus have, however, passed in a right line between the earth and the sun, but being at so great a distance, their shadows did not extend so far as the earth. No darkness was therefore produced on any part of our globe ; but the planet appeared like a small black spot, passing across the sun's disk : this is called a transit of the planet.

It was by the last transit of Venus that astronomers were enabled to calculate with some degree of accuracy the distance of the earth from the sun, and the dimensions of the latter.

## EMILY.

I have heard that the tides are affected by the moon, but I cannot conceive what influence it can have on them.

MRS. B.

They are produced by the attraction of the moon.

CAROLINE.

Oh, yes; I guess how it is: the cohesion of fluids being much less than that of solid bodies, the ocean more easily yields to the moon's attraction, so that it is drawn up below the moon, and rises on the adjacent shores, making it high water.

EMILY.

And I think I can explain the ebbing of the tide. The sea, in rising up below the moon, must draw the waters from the opposite side of the globe, and make it low water there.

MRS. B.

You seem to be so perfectly satisfied with your explanations, that I regret being obliged to say they are not correct.

It is true, that the attraction of the moon is the original cause of the tides, but they are not produced in the manner you describe.

In order to render the question more simple, let us suppose the earth to be every where covered by the ocean as represented (fig. 3. Plate XII.). M is the moon, ABCD the earth. Now, the



waters on the surface of the earth about A being more strongly attracted than in any other part, will . . . . .

CAROLINE.

Will rise towards the moon in a protuberance, as described in fig. 3. Forgive me for interrupting you, Mrs B., but that is just what I supposed to be the case.

MRS. B.

I must again repeat that you are mistaken; for the attraction of the moon is so small compared to that of the earth, that it will not be able to raise the waters even a single inch.

I will endeavour to explain it to you.

I have already told you, that when bodies attract each other, they attract more strongly in proportion as they are nearer. Consequently the moon, although not able to overcome the attraction of the earth, so as to raise the water at A, will draw it more forcibly than it does the earth at E, because it is nearer to A; and it will draw the earth at E more forcibly than the water at D, because it is nearer to E than to D. Now, the effect of this difference of attraction is, not to alter the form of the waters at A and at D, but merely to weaken the tendency of A towards E, and also the tendency of D towards E.

CAROLINE.

Then if the tendency of the waters both at A and at D towards E is diminished, they must have less gravity than they had before; and if that be the case, must become lighter whilst the moon is thus acting upon them and upon the earth.

MRS. B.

You are quite right. But what will be the effect of the moon's action on the waters at B and C?

EMILY.

I suppose they will become lighter too?

MRS. B.

Not so. For you must observe that the waters at B and C, being at the same distance from the moon as E, they are all equally attracted by the moon; and the attraction of the earth at E, on the waters at B and C, is not thereby disturbed.

EMILY.

Then the waters at B and C would not be altered in their gravity towards E, and would remain of the same weight as before.

CAROLINE.

How can that be? For then the waters at B and C would be comparatively heavier than the

waters at A and D, which is impossible, for water is water, and the moon cannot alter its nature.

MRS. B.

No, but most assuredly it alters the comparative weights; and the consequence is, that the water at B and C presses the lighter water, so as to make it bulge into a protuberance at A and D, and thus makes it rise there, or, in other words, causes a tide.

CAROLINE.

Then, in fact, it is not the moon's attraction that draws the water into a protuberance, but the pressure of the waters at B and C.

MRS. B.

Exactly so. The moon's attraction causes the water immediately below the moon, and also that on the opposite side of the earth, to become lighter, and the water at B and C, whose gravity remains the same as before, presses the lighter water to such a height as will bring them all to an equilibrium.

CAROLINE.

Then if there were two moons, one acting in the direction M A D, and another in the direction B E C, there would be no tide.

MRS. B.

Just so, if the second moon was of the same size and at the same distance. Now, although there is no second moon, there is the sun, which, though much larger than the moon, is so much farther off, that it has not the same power to produce a tide; but it produces a great effect, notwithstanding, according as it co-operates with, or counteracts, the power of the moon.

EMILY.

I do not quite understand that.

MRS. B.

The moon is a month in going round the earth; twice during that time, therefore, at full and at change, she is in the same direction as the sun; both then act in conjunction on the earth, and produce very great tides, called spring-tides, as described in fig. 4. at A and B: but when the moon is at the intermediate parts of her orbit, the sun, instead of affording assistance, weakens her power by acting in opposition to it; and smaller tides are produced, called neap-tides, as represented in fig. 5.

EMILY.

I have often observed the difference of these tides when I have been at the sea-side.

But since attraction is mutual between the moon

and the earth, we must produce tides in the moon ; and these must be more considerable in proportion as our planet is larger. And yet the moon does not appear of an oval form.

MRS. B.

You must recollect that, in order to render the explanation of the tides clearer, we supposed the whole surface of the earth to be covered with the ocean ; but that is not really the case, either with the earth or the moon, and the land which intersects the water destroys the regularity of the effect.

CAROLINE.

True. We may, however, be certain that whenever it is high water the moon is immediately over our heads.

MRS. B.

Not so, either ; since you have just learnt that a similar effect is produced on that part of the globe immediately beneath the moon, and on that part most distant from it, and it cannot be over the heads of the inhabitants of both those situations at the same time. Besides, as the orbit of the moon is very nearly parallel to that of the earth, she is never vertical but to the inhabitants of the torrid zone ; in that climate, therefore, the tides are greatest, and they diminish as you recede from it and approach the poles.

CAROLINE.

In the torrid zone, then, I hope you will grant that the moon is immediately over, or opposite to, the spots where it is high water.

MRS. B.

I cannot even admit that; for the ocean naturally partaking of the earth's motion, in its rotation from west to east, the moon, in forming a tide, has to contend against the eastern motion of the waves. All matter, you know, by its inertia, offers some resistance to a change of state; the waters, therefore, do not readily yield to the attraction of the moon, and the effect of her influence is not complete till three hours after she has passed the meridian where it is full tide.

EMILY.

Pray what is the reason that the tide is three quarters of an hour later every day?

MRS. B.

Because it is twenty-four hours and three quarters before the same meridian on our globe returns beneath the moon. The earth revolves on its axis in about twenty-four hours: if the moon were stationary, therefore, the same part of our globe would, every twenty-four hours, return beneath the moon; but as, during our daily revo-

lution, the moon advances in her orbit, the earth must make more than a complete rotation in order to bring the same meridian opposite to the moon, we are three quarters of an hour in overtaking her. The tides, therefore, are retarded for the same reason that the moon rises later by three quarters of an hour every day.

We have now, I think, concluded the observations I had to make to you on the subject of astronomy. At our next interview, I shall attempt to explain to you the elements of hydrostatics.

## CONVERSATION XI.

ON THE MECHANICAL PROPERTIES OF  
FLUIDS.

DEFINITION OF A FLUID. — DISTINCTION BETWEEN  
FLUIDS AND LIQUIDS. — OF NON-ELASTIC FLUIDS,  
SCARCELY SUSCEPTIBLE OF COMPRESSION. — OF THE  
COHESION OF FLUIDS. — OF THEIR GRAVITATION. —  
OF THEIR EQUILIBRIUM. — OF THEIR PRESSURE. —  
OF SPECIFIC GRAVITY. — OF THE SPECIFIC GRAVITY  
OF BODIES HEAVIER THAN WATER. — OF THOSE OF  
THE SAME WEIGHT AS WATER. — OF THOSE LIGHTER  
THAN WATER. — OF THE SPECIFIC GRAVITY OF  
FLUIDS.

MRS. B.

WE have hitherto confined our attention to the  
mechanical properties of solid bodies, which have  
been illustrated, and, I hope, thoroughly impressed  
upon your memory, by the conversation we have  
subsequently had on astronomy. It will now be  
necessary for me to give you some account of the



mechanical properties of fluids, a science which is called hydrostatics. A fluid is a substance which yields to the slightest pressure. If you dip your hand into a basin of water, you are scarcely sensible of meeting with any resistance.

EMILY.

The attraction of cohesion, you have told us, is less powerful in fluids than in solids.

MRS. B.

Fluids, generally speaking, are bodies of less density than solids. From the slight cohesion of their particles, and the facility with which these slide over each other, it is conjectured that they must be small, smooth, and globular;—smooth, because there appears to be little or no friction among them; and globular because touching each other but by a point would account for the slightness of their cohesion.

CAROLINE.

Pray, what is the distinction between a fluid and a liquid?

MRS. B.

Liquids designate only one class of fluids. There is another class distinguished by the name of elastic fluids, or gases, which comprehends the air of the atmosphere, and all the various kinds of

air with which you will become acquainted when you study chemistry. Their mechanical properties we shall examine at our next meeting, and confine our attention this morning to those of liquids, or non-elastic fluids.

Water, and liquids in general, are little susceptible of being compressed or squeezed into a smaller space than that which they naturally occupy. This is supposed to be owing to the extreme minuteness of their particles, which, rather than submit to compression, force their way through the pores of the substance which confines them; as was shown by a celebrated experiment made at Florence many years ago. A hollow globe of gold was filled with water, and on its being submitted to great pressure, the water was seen to exude through the pores of the gold, which it covered with a fine dew. But more recent experiments, in which water has been confined in strong iron tubes, provè that it is susceptible of compression.

EMILY.

Are liquids porous like solid bodies?

MRS. B.

Yes. If the form of their particles is spherical there must necessarily be interstices between them, but they are too minute to be discovered by the most powerful microscope. The existence of pores

in liquids can be ascertained by dissolving solid bodies in them. If you melt some salt in a glass-full of water, the water will not overflow, because the particles of salt will lodge themselves in the pores of the liquid, so that the salt and water together will not occupy more space than the water did alone. It is true that if you attempt to melt more salt than can find room within these pores, the remainder will subside at the bottom, and occupying a space which the water filled before, oblige the latter to overflow.

Spirit of wine may also be poured into water without adding to the bulk, as the spirit will introduce itself into the pores of the water. But we must not infringe on the province of chemistry: we must confine ourselves to the mechanical properties of fluids.

Fluids show the effects of gravitation in a more perfect manner than solid bodies; for the strong cohesive attraction of the particles of the latter in some measure counteracts the effect of gravity. In this table, for instance, the cohesion of the particles of wood enables four slender legs to support a considerable weight. Were the cohesion so far destroyed as to convert the wood into a fluid, no support could be afforded by the legs; for, the particles no longer cohering together, each would press separately and independently, and would be brought to a level with the surface of the earth.

EMILY.

This deficiency of cohesion, then, is the reason why fluids can never be formed into figures, or maintained in heaps; for though it is true the wind raises water into waves, they are immediately afterwards destroyed by gravity, and water always finds its level.

MRS. B.

This level, or equilibrium of fluids, is the natural result of their particles gravitating independently of each other; for when any particle of a fluid accidentally finds itself elevated above the rest, it is attracted down to the level of the surface of the fluid, and the readiness with which fluids yield to the slightest pressure will enable the particle by its weight to penetrate the surface of the fluid and mix with it.

CAROLINE.

But I have seen a drop of oil float on the surface of water without mixing with it.

MRS. B.

Because oil is a liquid lighter than water, and fluids of unequal densities do not preserve the same level. If you were to pour water over it, the oil would rise to the surface, being forced up by the superior gravity of the water.

EMILY.

Just as the tides are forced up by the pressure of the heavier water.

MRS. B.

Exactly so. Here is an instrument called a water-level (Plate XIII. fig. 1.), which is constructed upon the principle of the equilibrium of fluids. It consists of a short tube, A B, closed at both ends, and containing water and a bubble of air: when the tube is not perfectly horizontal, the water runs to the lower end, which makes the bubble of air rise to the upper end, and it remains in the centre only when the tube does not incline either way. It is by instruments of this kind that the level of any situation is ascertained.

Solid bodies may, therefore, be considered as gravitating in masses; for the strong cohesion of their particles makes them weigh all together, while every particle of a fluid gravitates independently of each other. Hence the resistance of a fluid is considerably less than that of a solid body; for the resistance of the particles acting separately, they are more easily overcome.

EMILY.

A body of water, in falling, does certainly less injury than a solid body of the same weight.

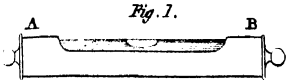


Fig. 3.



Fig. 4.

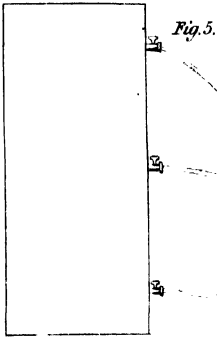
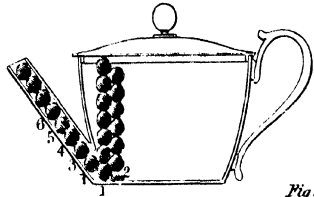


Fig. 2.



Fig. 6.

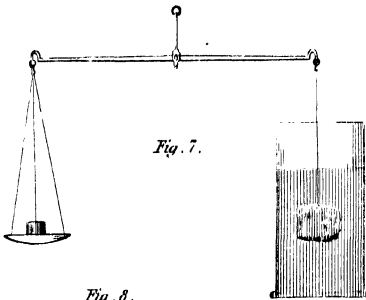


Fig. 8.

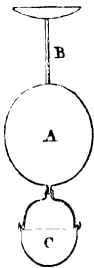


Fig. 9.



MRS. B.

The particles of fluids acting thus independently, press against each other in every direction, not only downwards but upwards, and laterally or sideways; and in consequence of this equality of pressure, every particle remains at rest in the fluid. If you agitate the fluid you disturb this equality of pressure, and the fluid will not rest till its equilibrium is restored.

CAROLINE.

The pressure downwards is very natural: it is the effect of gravity, one particle weighing upon another presses on it; but the pressure sideways, and particularly the pressure upwards, I cannot understand.

MRS. B.

Were the particles of fluids arranged in regular columns, thus (fig. 2.), there would be no lateral pressure, for when one particle is perpendicularly above the other, it can only press it downwards; but as it continually happens that one particle presses between two others beneath it (fig. 3.), the lower ones must suffer a lateral pressure.

EMILY.

As a wedge driven into a piece of wood separates the parts laterally.

MRS. B.

If there were no lateral pressure, water would



not flow from an opening on the side of a vessel. Sand will not run out of such an opening, because there is scarcely any lateral pressure among its particles.

EMILY.

When water runs out of the side of a vessel, is it not owing to the weight of the water above the opening?

MRS. B.

Yes. The lateral pressure proceeds entirely from the pressure downwards, or the weight of the liquid above; and, consequently, the lower the orifice is made in the vessel, the greater will be the velocity of the water rushing out of it. Here is a vessel of water (fig. 5.) with three stop-cocks at different heights; we shall open them, and you will see with what different degrees of velocity the water issues from them. Do you understand this, Caroline?

CAROLINE.

Oh yes. The water from the upper spout, receiving but a slight pressure, on account of its vicinity to the surface, flows but gently; the second cock having a greater weight above it, the water is forced out with greater velocity; whilst the lowest cock, being near the bottom of the vessel, receives the pressure of almost the whole body of water, and rushes out with the greatest impetuosity.

MRS. B.

Very well; and you must observe, that as the lateral pressure is entirely owing to the pressure downwards, it is not affected by the horizontal dimensions of the vessel which contains the water, but merely by its depth; for as every particle acts independently of the rest, it is only the column of particles immediately above the orifice that can weigh upon and press out the water.

EMILY.

The breadth and width of the vessel, then, can be of no consequence in this respect. The lateral pressure on one side, in a cubical vessel, is, I suppose, not so great as the pressure downwards.

MRS. B.

No. In a cubical vessel, the pressure downwards will be double the lateral pressure on one side; for every particle at the bottom of the vessel is pressed upon by a column of the whole depth of the fluid, whilst the lateral pressure diminishes from the bottom upwards to the surface, where the particles have no pressure.

CAROLINE.

And from whence proceeds the pressure of fluids upwards? That seems to me the most unaccountable, as it is in direct opposition to gravity.

MRS. B.

And yet it is a consequence of gravity, that is, of the pressure downwards. When, for example, you pour water into a tea-pot, the water rises in the spout to a level with the water in the pot. The particles of water at the bottom of the pot are pressed upon by the particles above them; to this pressure they will yield, if there is any mode of making way for the superior particles, and as they cannot descend, they will change their direction and rise in the spout.

Suppose the tea-pot to be filled with columns of particles of water similar to that described in fig. 4.; the particle 1 at the bottom will be pressed laterally by the particle 2, and by this pressure be forced into the spout, where meeting with the particle 3, it presses it upwards, and this pressure will be continued, from 3 to 4, from 4 to 5, and so on, till the water in the spout has risen to a level with that in the pot.

EMILY.

If it were not for this pressure upwards, forcing the water to rise in the spout, the equilibrium of the fluid would be destroyed.

CAROLINE.

True: but then a tea-pot is wide and large, and the weight of so great a body of water as the pot will contain may easily force up and support so

small a quantity as will fill the spout. But would the same effect be produced if the spout and the pot were of equal dimensions?

MRS. B.

Undoubtedly it would. You may even reverse the experiment, by pouring water into the spout, and you will find that the water will rise in the pot to a level with that in the spout; for the pressure of the small quantity of water in the spout will force up and support the larger quantity in the pot. In the pressure upwards, as well as that laterally, you see that the force results entirely from the height, and is quite independent of the horizontal dimensions of the fluid.

As a tea-pot is not transparent, let us try the experiment by filling this large glass goblet by means of this narrow tube (fig. 6.).

CAROLINE.

Look, Emily, as Mrs. B. fills it, how the water rises in the goblet, to maintain an equilibrium with that in the tube.

Now, Mrs. B., will you let me fill the tube by pouring water into the goblet?

MRS. B.

That is impossible. However, you may try the experiment, and I doubt not but that you will be able to account for its failure.

CAROLINE.

It is very singular, that if so small a column of water as is contained in the tube can force up and support the whole contents of the goblet, the weight of all the water in the goblet should not be able to force up the small quantity required to fill the tube. — Oh, I see now the reason: the water in the goblet cannot force that in the tube above its level; and as the end of the tube is considerably higher than the goblet, it can never be filled by pouring water into the goblet.

MRS. B.

And if you continue to pour water into the goblet when it is full, the water will run over, instead of rising in the tube above the level.

But if you pour two fluids of different densities into the goblet and the tube, oil, for instance, into the tube, and water into the goblet, the level will no longer be preserved; for the pressure of the heavier fluid will force up the lighter.

EMILY.

The oil will rise, I suppose, till its weight shall balance that of the water.

MRS. B.

Yes, for the two fluids will then be in equilibrium; so that the level of the two fluids is de-

stroyed in order to preserve their equilibrium. But observe that it is the height or depth of the fluids that are alone to be considered, the lateral dimensions of the vessels producing no effect.

I shall now explain to you the meaning of the *specific gravity* of bodies.

CAROLINE.

What! is there another species of gravity with which we are not yet acquainted?

MRS. B.

No. The specific gravity of a body means simply its weight compared with that of another body of the same size. When we say that substances, such as lead and stones, are heavy, and that others, such as paper and feathers, are light, we speak comparatively; that is to say, that the first are heavy, and the latter light, in comparison with the generality of the substances in nature. Would you call wood and chalk light or heavy bodies?

CAROLINE.

Some kinds of wood are heavy certainly, as oak and mahogany; others are light, as deal and box.

EMILY.

I think I should call wood in general a heavy body; for deal and box are light only in comparison to wood of a heavier description. I am at

a loss to determine whether chalk should be ranked as a heavy or a light body : I should be inclined to say the former, if it were not that it is lighter than most other minerals. I perceive that we have but vague notions of light and heavy. I wish there was some standard of comparison, to which we could refer the weight of all other bodies.

MRS. B.

The necessity of such a standard has been so much felt, that a body has been fixed upon for this purpose. What substance do you think would be best calculated to answer this end ?

CAROLINE.

It must be one generally known and easily obtained ; lead or iron, for instance.

MRS. B.

All the metals expand by heat, and condense by cold. A piece of lead, let us say a cubic inch, for instance, would have less specific gravity in summer than in winter ; for it would be more dense in the latter season.

CAROLINE.

But, Mrs. B., if you compare the weight of equal quantities of different bodies, they will all be alike. You know the old saying, that a pound of feathers is as heavy as a pound of lead !

MRS. B.

When, therefore, we compare the weight of different kinds of bodies, it would be absurd to take quantities of equal *weight*: we must take quantities of equal *bulk*; pints or quarts, not ounces or pounds.

CAROLINE.

Very true: it is true, it would be as absurd to compare bodies of the same size in order to ascertain which was largest, as to compare bodies of the same weight in order to discover which was heaviest.

MRS. B.

In estimating the specific gravity of bodies, therefore, we must compare equal bulks, and we shall find that their specific gravity will be proportional to their weights. The body which has been adopted as a standard of reference is distilled water.

EMILY.

I am surprised that a fluid should have been chosen for this purpose, as it must necessarily be contained in some vessel, and the weight of the vessel will require to be deducted.

MRS. B.

In order to learn the specific gravity of a solid body, it is not necessary to put a certain measure



of it in one scale, and an equal measure of water into the other scale; but simply to weigh the body under trial in water. If you weigh a piece of gold in a glass of water, will not the gold displace just as much water as is equal to its own bulk?

CAROLINE.

Certainly, where one body is, another cannot be at the same time; so that a sufficient quantity of water must be removed, in order to make way for the gold.

MRS. B.

Yes; a cubic inch of water to make room for a cubic inch of gold. Remember that the bulk alone is to be considered, the weight has nothing to do with the quantity of water displaced; for a cubic inch of gold does not occupy more space, and therefore will not displace more water, than a cubic inch of ivory, or any other substance that will sink in water.

Well, you will perhaps be surprised to hear that the gold will weigh less in water than it did out of it.

EMILY.

And for what reason?

MRS. B.

On account of the upward pressure of the particles of water, which in some measure supports the

gold, and by so doing diminishes its weight. If the body under trial were of the same weight as the water, it would be wholly supported by it, just as the water which it displaces was supported previous to its making way for the solid body. If the body is heavier than the water, it cannot be wholly supported by it; but the water will offer some resistance to its descent.

CAROLINE.

In bathing, one is very sensible how much the water supports one; I feel so light in the sea, that I almost fancy I could float on its surface if it were quite smooth.

EMILY.

And the resistance which water offers to the descent of heavy bodies immersed in it (since it proceeds from the upward pressure of the particles beneath), must in all cases, I suppose, be the same?

MRS. B.

Yes. The resistance of the fluid is proportional to the bulk, and not to the weight, of the body immersed in it; all bodies of the same size, therefore, lose the same quantity of their weight in water. Can you form any idea what this loss will be?

EMILY.

I should think it would be equal to the weight of the water displaced; for, since that portion of

the water was supported before the immersion of the solid body, an equal weight of the solid body will be supported.

MRS. B.

You are perfectly right. A body weighed in water loses just as much of its weight as is equal to that of the water it displaces; so that if you were to put the water displaced into the scale to which the body is suspended, it would restore the balance.

You must observe, that when you weigh a body in water, in order to ascertain its specific gravity, you must not sink the basin of the balance in the water; but either suspend the body to a hook at the bottom of the basin, or else take off the basin, and suspend it to the arm of the balance. (Fig. 7.) Now, suppose that a cubic inch of gold weighed 19 ounces out of water, and lost one ounce by being weighed in water, what would be its specific gravity?

CAROLINE.

The cubic inch of water it displaced must weigh that one ounce; and as a cubic inch of gold weighs 19 ounces, gold is 19 times as heavy as water.

EMILY.

I recollect having seen a table of the comparative weights of bodies, in which gold appeared to me

to be estimated at 19 thousand times the weight of water.

MRS. B.

You misunderstand the meaning of the table. In the estimation you allude to, the weight of water was reckoned at 1000. You must observe that the weight of a substance when not compared to that of any other is perfectly arbitrary; and when water is adopted as a standard, we may denominate its weight by any number we please; but then the weight of all bodies tried by this standard must be signified by proportional numbers.

CAROLINE.

We may call the weight of water, for example, 1, and then that of gold would be 19; or, if we chose to call the weight of water 1000, that of gold would be 19,000. In short, the specific gravity means how much more a body weighs than an equal bulk of water.

MRS. B.

It is rather the weight of a body compared with that of water; for the specific gravity of many substances is less than that of water.

CAROLINE.

Then you cannot ascertain the specific gravity of such substances in the same manner as that of

gold; for a body that is lighter than water will float on the surface without displacing any water.

MRS. B.

If a body were absolutely light, it is true that it would not displace a drop of water; but the bodies we are treating of have all some weight, however small; and will therefore displace some quantity of water. A body lighter than water will not sink to a level with the surface of the water, and therefore will not displace so much water as is equal to its bulk; but it will displace as much as is equal to its weight. A ship, you must have observed, sinks to some depth in water; and the heavier it is laden the deeper it sinks, as it always displaces a quantity of water equal to its weight.

CAROLINE.

But you said just now, that in the immersion of gold, the bulk, and not the weight of body, was to be considered.

MRS. B.

That is the case with all substances which are heavier than water; but since those which are lighter do not displace so much as their own bulk, the quantity they displace is not a test of their specific gravity.

In order to obtain the specific gravity of a body which is lighter than water, you must attach to it

a heavy one, whose specific gravity is known, and immerse them together; the specific gravity of the lighter body may then be easily calculated.

EMILY.

But are there not some bodies which have exactly the same specific gravity as water?

MRS. B.

Undoubtedly; and such bodies will remain at rest in whatever situation they are placed in water. Here is a piece of wood which, by being impregnated with a little sand, is rendered precisely of the weight of an equal bulk of water: in whatever part of this vessel of water you place it, you will find that it will remain stationary.

CAROLINE.

I shall first put it at the bottom: from thence, of course, it cannot rise, because it is not lighter than water. Now I shall place it in the middle of the vessel; it neither rises nor sinks, because it is neither lighter nor heavier than the water. Now I will lay it on the surface of the water; but there it sinks a little; — what is the reason of that, Mrs. B.?

MRS. B.

Since it is not lighter than the water, it cannot float upon its surface; since it is not heavier than

water, it cannot sink below its surface: it will sink, therefore, only till the upper surface of both bodies are on a level. If you poured a few drops of water into the vessel (so gently as not to increase their momentum by giving them velocity), they would mix with the water at the surface, and not sink lower.

CAROLINE.

This must, no doubt, be the reason why, in drawing up a bucket of water out of a well, the bucket feels so much heavier when it rises above the surface of the water in the well; for whilst you raise it in the water, the water within the bucket being of the same specific gravity as the water on the outside, will be wholly supported by the upward pressure of the water beneath the bucket, and consequently very little force will be required to raise it; but as soon as the bucket rises to the surface of the well, you immediately perceive the increase of weight.

EMILY.

And how do you ascertain the specific gravity of fluids?

MRS. B.

By means of an instrument called an hydrometer, which I will show you. It consists of a thin glass ball A (Plate XIII. fig. 8.), with a graduated tube B, and the specific gravity of the liquid is

estimated by the depth to which the instrument sinks in it; for the less the specific gravity of the fluid, the farther will the instrument sink in it. There is a smaller ball, C, attached to the instrument below, which contains a little mercury; but this is merely for the purpose of equipoising the instrument, that it may remain upright in the liquid under trial.

I must now take leave of you; but there remain yet many observations to be made on fluids: we shall, therefore, resume this subject at our next interview.



## CONVERSATION XII.

---

### ON SPRINGS, FOUNTAINS, &c.

OF THE ASCENT OF VAPOUR AND THE FORMATION OF CLOUDS. — OF THE FORMATION AND FALL OF RAIN, ETC. — OF THE FORMATION OF SPRINGS. — OF RIVERS AND LAKES. — OF ARTESIAN WELLS. — OF FOUNTAINS.

CAROLINE.

THERE is a question I am very desirous of asking you respecting fluids, Mrs. B., which has often perplexed me. What is the reason that the great quantity of rain which falls upon the earth and sinks into it does not, in the course of time, injure its solidity? The sun and the wind, I know, dry the surface; but they can have no effect on the interior parts, where there must be a prodigious accumulation of moisture.

MRS. B.

Do you not know that, in the course of time, all the water which sinks into the ground rises out of

it again? It is the same water which successively forms seas, rivers, springs, clouds, rain, and sometimes hail, snow, and ice. If you will take the trouble of following it through these various changes, you will understand why the earth is not yet drowned by the quantity of water which has fallen upon it since its creation; and you will even be convinced, that it does not contain a single drop more water now, than it did at that period.

Let us consider how the clouds were originally formed. When the first rays of the sun warmed the surface of the earth, the heat, by separating the particles of water, rendered them lighter than the air. This, you know, is the case with steam or vapour. What then ensues?

CAROLINE.

When lighter than the air it will naturally rise. And now I recollect your telling us in a preceding lesson, that the heat of the sun transformed the particles of water into vapour, in consequence of which it ascended into the atmosphere, where it formed clouds.

MRS. B.

But we must observe that when this watery vapour is exhaled it is dissolved by the air; that is, subdivided into such minute particles as to be invisible.

CAROLINE.

How, then, does it form clouds?

MRS. B.

Suppose the weather to grow colder, the diminution of temperature condenses the invisible vapour contained in the atmosphere, and it appears under the form either of mists or of clouds.

CAROLINE.

Then clouds should be formed every evening from the loss of the sun's heat?

MRS. B.

That is sometimes the case, but mists are more frequently the result. How often in the evening you see mists following the course of a river or of a damp valley!

EMILY.

Mists are then formed in the air? I thought, they arose from the ground.

MRS. B.

No; they do not rise in the form of mists, but in that of invisible vapour, during the heat of the day, and are condensed into mists by the coolness of the evening.

When vapour becomes visible it is composed of extremely small vesicles filled with air, so that

mists and clouds consist of globules of air enclosed in a thin film of water. The consequence is, that when heat dilates the air within these globules, the clouds become lighter, and rise: when, on the contrary, cold condenses it, they descend.

CAROLINE.

I have observed that the clouds often appear lower after sunset; and in winter we have much more cloudy weather than in summer.

EMILY.

Yet in winter, the sun, having less power, can raise less vapour during the day; I should have thought, therefore, that there would have been less moisture in the atmosphere to form clouds.

CAROLINE.

Oh, Emily! can you doubt there being more moisture in the air in winter than in summer?

MRS. B.

Emily is right in supposing that the sun pumps up much less water, from the earth, in winter, and consequently that the air contains much less vapour; but that vapour being condensed by the cold, produces more moisture than in summer.

CAROLINE.

Then the air, I suppose, never is so wet as in the dog-days, when it appears perfectly dry?

MRS. B.

It never contains so much water as at that season; but as the water is completely dissolved by the high temperature of the air, there exists neither wet, moisture, nor dampness of any kind.

EMILY.

And to what height do the clouds rise?

MRS. B.

The clouds, you know, are supported by the atmosphere; their elevation, therefore, depends not so much on their absolute weight, as on their specific gravity, or their weight relatively to that of the atmosphere; and as the latter diminishes in density in proportion to its distance from the earth, the clouds will rise until they reach a region of air of their own specific gravity, and there they will remain stationary until some change of temperature, either in the atmosphere or in the cloud, disturbs this equilibrium. The greatest height the clouds are known to have attained is 10,000 feet. Beyond that distance from the earth, the atmosphere is too light to support them, and they either descend to a lower region, or fall to the ground in the form of rain, snow, or hail.

CAROLINE.

They do fall to the ground, certainly, when it rains; but, according to your theory, I should have imagined, that when the clouds became too heavy for the region of air in which they were situated to support them, they would descend till they reached a stratum of air of their own weight, and not fall to the earth; for as clouds are formed of vapour, they cannot be so heavy as the lowest regions of the atmosphere, otherwise the vapour would not have risen.

MRS. B.

The fall of rain is produced by a sudden condensation of the cloud, so as to bring the vesicles of which it is formed within the sphere of each other's attraction, and unite them in the form of drops of water. The vapour thus transformed into a shower is heavier than any part of the atmosphere, and consequently descends to the earth.

CAROLINE.

And when the cloud falls in the form of snow, the watery vesicles, I suppose, are frozen?

MRS. B.

Yes; and coming into contact during their descent, several of them unite, and form crystals, which, when the air is still, are perfectly regular,

of the shape of a star having six rays: but if the air be agitated by wind, their crystallisation is disturbed, and they congregate into flakes of various forms and sizes.

CAROLINE.

How wonderfully curious!

MRS. B.

It is impossible to consider any part of nature attentively, without being struck with admiration at the wisdom displayed; and I hope you will never contemplate these wonders without feeling your heart glow with admiration and gratitude towards their bounteous Author. Observe, that if the waters were never drawn out of the earth, all vegetation would be destroyed by the excess of moisture; if, on the other hand, the plants were not nourished and refreshed by occasional showers, the drought would be equally fatal to them. If the clouds constantly remained in a state of vapour, they might, as you remarked, descend into a heavier stratum of the atmosphere, but could never fall to the ground; or were the power of attraction more than sufficient to convert the vapour into drops, it would transform the cloud into a mass of water, which, instead of nourishing, would destroy the produce of the earth.

Water, then, ascends in the form of vapour, and descends in that of rain, snow, or hail, all of which

ultimately become water. Some of this falls into the various bodies of water on the surface of the globe, the remainder upon the land. Of the latter, part re-ascends in the form of vapour, part is absorbed by the roots of vegetables, and part descends into the bowels of the earth, where it forms springs.

EMILY.

Is rain and spring water, then, the same?

MRS. B.

Originally they were. The only difference between rain and spring water consists in the foreign particles which the latter meets with and dissolves, in its passage through the various soils it traverses.

CAROLINE.

Yet spring water is more pleasant to the taste, appears more transparent, and, I should have supposed, would have been more pure than rain water.

MRS. B.

No. Excepting distilled water, rain water is the most pure we can obtain; and it is its purity which renders it insipid, whilst the various salts and different ingredients, dissolved in spring water, give it a species of flavour, without in any degree affecting its transparency; and the filtration it undergoes through gravel and sand in the bowels



of the earth cleanses it from all foreign matter which it has not the power to dissolving.

When rain falls on the surface of the earth, it continues making its way downwards through the pores and crevices in the ground. Several drops meet in their subterraneous passage, unite, and form a little rivulet: this, in its progress, joins other rivulets of a similar description, and they pursue their course together in the interior of the earth, till they are stopped by some substance which they cannot penetrate.

CAROLINE.

Yet you said that water could penetrate even the pores of gold, and they cannot meet with a substance more dense.

MRS. B.

Water penetrates the pores of gold only when under a strong compressive force, as in the Florentine experiment; now in its passage towards the centre of the earth, it is acted upon by no other power than gravity, which is not sufficient to make it force its way even through a stratum of clay. This species of earth, though not remarkably dense, being of great tenacity, will not admit the particles of water to pass. When water encounters any substance of this nature, therefore, its progress is stopped, and the pressure of the accumulating waters forms a bed, or reservoir, a

sort of pond underground. This will be more clearly explained by fig. 9. Plate XIII., which represents a section, or the interior of a hill or mountain. A is a body of water such as I have described, which, when filled up as high as B, (by the continual accession of waters it receives from the ducts or rivulets, *a, a, a, a,*) finds a passage out of the cavity; and, impelled by gravity, it runs on, till it makes its way out of the ground at the side of the hill, and there forms a spring, C.

CAROLINE.

Gravity impels downwards towards the centre of the earth; and the spring in this figure runs in an horizontal direction.

MRS. B.

Not entirely. There is some declivity from the reservoir to the spot where the water issues out of the ground; and gravity, you know, will bring bodies down an inclined plane, as well as in a perpendicular direction.

CAROLINE.

But though the spring may descend, on first issuing, it must afterwards rise to reach the surface of the earth; and that is in direct opposition to gravity.

MRS. B.

A spring can never rise above the level of the reservoir whence it issues; it must, therefore, find

a passage to some part of the surface of the earth that is lower or nearer the centre than the reservoir. It is true that, in this figure, the spring in its passage from B to C rises occasionally; but this, I think, with a little reflection, you will be able to account for.

EMILY.

Oh, yes. It is owing to the pressure of fluids upwards: the water rises in the duct upon the same principle as it rises in the spout of a tea-pot; that is to say, in order to preserve an equilibrium with the water in the reservoir. Now, I think I understand the nature of springs: the water will flow through a duct, whether ascending or descending, provided that it never rise higher than the reservoir.

MRS. B.

Water may thus be conveyed to every part of a town, and to the upper stories of the houses, if it be originally brought from a height superior to any to which it is carried. Have you never observed, when the pavement of the streets has been mending, the pipes which serve as ducts for the conveyance of the water through the town?

EMILY.

Yes, frequently: and I have remarked that when any of these pipes have been opened, the water rushes upwards from them with great velocity, which must proceed from the pressure of the water in the reservoir forcing it out.



Fig. 2.

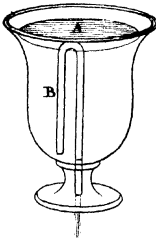


Fig. 1.

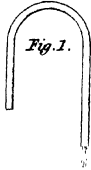


Fig. 3.

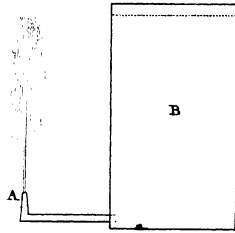


Fig. 4.



Fig. 5.

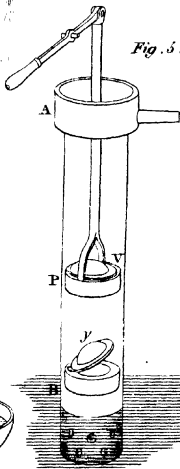


Fig. 6.

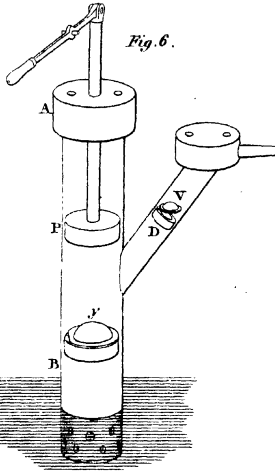


Fig. 7.

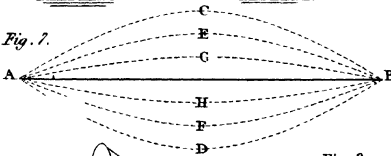
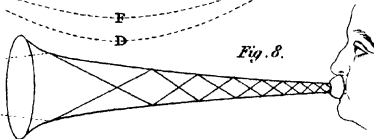


Fig. 8.



CAROLINE.

I recollect having once seen a very curious glass, called Tantalus's cup. It consists of a goblet, containing a small figure of a man, and whatever quantity of water you pour into the goblet, it never rises higher than the breast of the figure. Do you know how that is contrived ?

MRS. B.

It is by means of a siphon, or bent tube, which is concealed in the body of the figure. But it is necessary that I should explain to you the principle of the siphon.

A siphon is simply a bended tube: if its two legs be of equal length and filled with liquid, though turned downwards, and if it be held perfectly level (fig. 1. Plate XIV.), the liquid will not run out, but remain suspended in the tube.—Can you account for this ?

CAROLINE.

It appears very extraordinary !—let me see :—the tube being full there is no pressure of the atmosphere above the liquid, but there will be a pressure from below upwards upon the open ends of the tube : can this be sufficient to counterbalance the pressure of the water downwards ?

MRS. B.

Yes, provided the pressure of the liquid be equal in both legs ; but if you give the smallest inclination to the siphon, so as to destroy the equilibrium

of the water, it will immediately flow from the lower leg. Siphons are commonly used to draw off liquids from casks or other vessels which cannot be easily moved. For this purpose the legs are made of unequal lengths, in order to render the pressure of the liquid unequal; the shorter leg is immersed in the cask, and the liquor flows out through the longer.

EMILY.

But how is the liquor made to rise in the shorter leg and pass over the bended part of the tube, which is higher than the level of the liquor in the cask?

MRS. B.

There are two modes of doing this: one is, after immersing the shorter leg in the liquor to be drawn off, to suck out the air of the tube from the orifice of the longer leg; then the liquor in the cask, which is exposed to the pressure of the atmosphere, will be forced, by it, into the tube which is relieved from pressure: as long as the tube continues full, no air can gain admittance; the liquor will therefore flow on till the cask is emptied.

The other mode is, to fill the siphon with the liquor; then, stopping the two ends with the fingers, immerse the shorter leg in the vessel, and the same effect will follow. In either case the water in the highest part of the siphon must not be more than

32 feet above the reservoir ; for the pressure of the atmosphere will not support a greater height of water.

In the goblet called Tantalus's cup, the siphon rises through one of the legs of the figure as high as the breast, and there turning, descends through the other leg, and from thence through the foot of the goblet, where the water runs out (fig. 2. Plate XIV.). When you pour water into the glass A, it must rise in the siphon, B, in proportion as it rises in the glass ; and when the glass is filled to a level with the upper part of the siphon, the water will run out through the other leg of the figure, and will continue running out, as fast as you pour it in : therefore the glass can never fill any higher.

EMILY.

I think the new well that has been dug at our country-house must be of that nature. We had little water, and my father had been at considerable expense to dig a well : after penetrating to a great depth before water could be found, a spring was at length discovered, but the water rose only a few feet above the bottom of the well ; and sometimes it is quite dry.

MRS. B.

This has, however, no analogy to Tantalus's cup, but is owing to the very elevated situation of your country-house.



EMILY.

I believe I guess the reason. There cannot be a reservoir of water near the summit of a hill; as in such a situation there will not be a sufficient number of rivulets formed to supply one, and without a reservoir there can be no spring. In such situations, therefore, it is necessary to dig very deep, in order to meet with a spring; and when we give it vent, it can rise only as high as the reservoir from whence it flows, which will be but little, as the reservoir must be situated at some considerable depth below the summit of the hill.

CAROLINE.

Your explanation appears very clear and satisfactory; but you must allow me to contradict it from experience. At the very top of a hill near our country-house there is a large pond; and, according to your theory, it would be impossible there should be springs in such a situation to supply it with water. Then, you know that I have crossed the Alps; and I can assure you that there is a fine lake on the summit of Mount Cenis, the highest mountain we passed over.

MRS. B.

Were there a lake on the summit of Mount Blanc, which is the highest of the Alps, it would indeed be wonderful; but that on Mount Cenis is not at all contradictory to our theory of springs: for this mountain is surrounded by others, much

more elevated, and the springs which feed the lake must descend from reservoirs of water formed in those mountains. This must also be the case with the pond on the top of the hill: there is doubtless some more considerable hill in the neighbourhood, which supplies it with water.

EMILY.

I comprehend perfectly why the water in our well never rises high; but I do not understand why it should occasionally be dry.

MRS. B.

Because the reservoir from which it flows, being in an elevated situation, is but scantily supplied with water; after a long drought, therefore, it may be drained, and the spring dry, till the reservoir be replenished by fresh rains. It is not uncommon to see springs flow with great violence in wet weather, and at other times be perfectly dry. There are some springs which flow very plentifully for a season, then suddenly stop, and are dry for another period, and again re-commence with the same abundance as before. These periodical springs act upon the principle of the siphon: the reservoir of water which supplies the spring you must consider as the vessel of liquor to be drawn off, and the duct to be the siphon, having its shorter leg opening in the reservoir, and its longer at the surface of the earth whence the spring flows.

EMILY.

But how does the water first rise in the siphon; for the operation cannot be begun by either of the artificial modes of sucking out the air, or of filling the duct with water?

MRS. B.

True; therefore the spring will not begin to flow till the water in the reservoir has risen above the level of the highest part of the siphon: it will then commence flowing upon the principle of the equilibrium of fluids: but it will continue upon the principle of the siphon; for, instead of ceasing as soon as the equilibrium is restored, it will continue flowing as long as the opening of the duct is in contact with the water in the reservoir.

Springs which do not constantly flow are called intermitting, and are occasioned by the reservoir being imperfectly supplied. Independently of the situation, this is always the case when the duct or ducts which convey the water into the reservoir are smaller than those which carry it off.

CAROLINE.

If it runs out faster than it runs in, the reservoir will of course sometimes be empty. And do not rivers also derive their source from springs?

MRS. B.

Yes; they generally take their source in mountainous countries, where springs are most abundant.

CAROLINE.

I understood you, that springs were more rare in elevated situations.

MRS. B.

You do not consider that mountainous countries abound equally with high and low situations. Reservoirs of water, which are formed in the bosom of mountains, generally find a vent either on their declivity, or in the valley beneath; while subterraneous reservoirs formed in a plain seldom find a passage to the surface of the earth, but remain concealed, unless discovered by digging a well. When a spring once issues at the surface of the earth, it continues its course externally, seeking always a lower ground; for it can no longer rise.

EMILY.

Then what is the consequence, if the spring, or I should now rather call it the rivulet, runs into a situation which is surrounded by a higher ground?

MRS. B.

Its course is stopped, the water accumulates, and it forms a pool, pond, or lake, according to the dimensions of the body of water. The Lake of Geneva, in all probability, owes its origin to the Rhone, which passes through it; if, when this river first entered the valley, which now forms the bed of the Lake, it found itself surrounded by higher grounds, its waters would there accumulate

till they rose to a level with that part of the valley where the Rhone now continues its course beyond the Lake, and from whence it flows through valleys, occasionally forming other small lakes, till it reaches the sea.

There is another species of spring or well which I must not omit to mention. This is called the *Artesian well*, from this peculiar mode of raising water having first been resorted to in Artois. If the earth be pierced with a bore a few inches in diameter, till it reaches a spring, the water will frequently rise to the surface. In order to prevent its being drained off or rendered muddy by the adjacent soil, a tube is let down which exactly fills the bore, and through this the water rises pure to the surface.

EMILY.

The water, of course, must originally have proceeded from a reservoir higher than the surface to which it rises.

MRS. B.

Undoubtedly. It flows upon the same principle as other springs. There is one at Fulham of the depth of 300 feet, which furnishes from sixty to eighty gallons of water a minute, and another at Merton, in Surrey, which gives 200 gallons a minute. One of the deepest of these wells is in the neighbourhood of Geneva, where the earth has been perforated to the depth of 720 feet: no water

was found; but as an experiment to ascertain the temperature of the lower strata of earth, it proved highly useful. From a careful examination of the mud brought up by the bore, it was ascertained that the temperature increased uniformly with the depth, at the rate of about  $1^{\circ}$  of Fahrenheit every 52 feet. This result was confirmed soon after by M. Arago's experiments on the temperature of the celebrated *puits de Grenelle* at Paris, made at the suggestion of that celebrated French philosopher. Convinced that water would at last be found he determined to go on with the well as long as any hope remained. It was only at the depth of 1500 feet that water made its appearance, and spouted up to a considerable height. It proved to be nearly tepid, at the temperature of about  $84^{\circ}$ .

## CAROLINE.

Then if they had gone on boring much deeper, they might have discovered a spring of boiling water.

## MRS. B.

It must have been very much deeper, indeed, to have reached the temperature of boiling water. This regular increase of temperature in the internal parts of the earth has led some philosophers to imagine that the centre may consist of an ocean of liquid fire enclosed in a covering of solid matter.

CAROLINE.

You alarm me, Mrs. B.! No wonder there should be so many earthquakes and volcanos.

MRS. B.

These phenomena proceed from causes no deeper than the exterior crust of the earth, which must be of considerable thickness, since it prevents us, who inhabit the surface, from feeling any great increase of temperature; for this central heat is very trifling compared to what we receive from the sun. But to return to the springs. A fountain acts upon the principle of a spring; it is conducted perpendicularly upwards by the spout or ajutage, A, through which it flows; and it will rise nearly as high as the reservoir, B, from whence it proceeds. (Plate XIV. fig. 3.)

CAROLINE.

Why not quite as high?

MRS. B.

Because it meets with resistance from the air in its ascent; and its motion is impeded by friction against the spout, whence it rushes out.

EMILY.

But if the tube through which the water rises be smooth, can there be any friction, especially with a fluid, whose particles yield to the slightest impression?

MRS. B.

Friction, as we observed in a former lesson, may be diminished by polishing, but can never be entirely destroyed; and though fluids are less susceptible of friction than solid bodies, they are still affected by it. Another reason why a fountain will not rise so high as its reservoir is, that as all the particles of water spout from the tube with an equal velocity, and as the pressure of the air upon the exterior particles must diminish their velocity, they will in some degree strike against the under parts, and force them sideways, spreading the column into a head, and rendering it both wider and shorter than it otherwise would be. Besides this, the resistance of the air prevents even the first particles projected from the tube from rising to the height of the water in the reservoir. Were there no such resistance, it would ascend to that height, and no higher; of course, being resisted, the elevation to which it rises is diminished. On both accounts, therefore, the height of such a fountain falls very considerably short of the height of the water in the reservoir.

At our next meeting we shall examine the mechanical properties of the air; which, being an elastic fluid, differs in many respects from liquids.



## CONVERSATION XIII.

ON THE MECHANICAL PROPERTIES  
OF AIR.

OF THE SPRING OR ELASTICITY OF THE AIR. — OF  
THE WEIGHT OF THE AIR. — EXPERIMENTS WITH  
THE AIR-PUMP. — OF THE BAROMETER. — MODE OF  
WEIGHING AIR. — SPECIFIC GRAVITY OF AIR. — OF  
PUMPS. — DESCRIPTION OF THE SUCKING PUMP. —  
DESCRIPTION OF THE FORCING PUMP.

MRS. B.

AT our last meeting we examined the properties of fluids in general, and more particularly of such fluids as are called liquids.

There is another class of fluids, distinguished by the name of *aëriform* or *elastic fluids*, the principal of which is the air we breathe, which surrounds the earth, and is called the atmosphere.

EMILY.

There are, then, other kinds of air besides the atmosphere?

MRS. B.

Yes, a great variety; but they differ only in their chemical, and not in their mechanical, properties; and as it is the latter we are to examine, we shall not at present inquire into their composition, but confine our attention to the mechanical properties of elastic fluids in general.



CAROLINE.

Whence arises the difference between liquids and elastic fluids?

MRS. B.

There is no attraction of cohesion between the particles of elastic fluids; so that the expansive power of heat has no adversary to contend with but gravity; any increase of temperature, therefore, expands elastic fluids prodigiously, and a diminution proportionally condenses them.

The most essential point in which air differs from other fluids is by its spring or elasticity; that is to say, its power of increasing or diminishing in bulk, according as it is more or less compressed; a power of which, I have informed you, liquids are but little susceptible.

EMILY.

I think I understand the elasticity of the air very well from what you formerly said of it \*; but what perplexes me is, its having gravity. If it is heavy, and we are surrounded by it, why do we not feel its weight?

CAROLINE.

It must be impossible to be sensible of the weight of such infinitely small particles as those of which the air is composed: particles which are too small to be seen must be too light to be felt.

MRS. B.

You are mistaken, my dear; the air is much heavier than you imagine. It is true that the particles which compose it are small; but, then, reflect on their quantity. The atmosphere is thought to extend to about the distance of 45 miles from the earth; and its gravity is such, that a man of middling stature is computed (when the air is heaviest) to sustain the weight of about 14 tons.

CAROLINE.

Is it possible? I should have thought such a weight would have crushed any one to atoms.

\* See page 45.

MRS. B.

That would indeed be the case, were it not that air is also contained within our bodies, the spring and elasticity of which counterbalance the weight of the external air, and render us less sensible of its pressure. Besides, the equality of pressure on every part of the body enables us to support it; thus diffused, we can bear even a much greater weight, without any considerable inconvenience. In bathing we support the weight and pressure of the water, in addition to that of the atmosphere; but because this pressure is equally distributed over the body, we are scarcely sensible of it; whilst if your shoulders, your head, or any particular part of your frame were loaded with the additional weight of a hundred pounds, you would sink under the fatigue.

CAROLINE.

But if it were possible to relieve me from the weight of the atmosphere, should I not feel more light and agile?

MRS. B.

On the contrary, the air within you, meeting with no external pressure to restrain its elasticity, would distend your body, and at length, bursting the parts which confine it, put a period to your existence.

CAROLINE.

This weight of the atmosphere, then, which I was so apprehensive would crush me, is, in reality, essential to my preservation.

EMILY.

I once saw a person cupped, and was told that the swelling of the part under the cup was produced by taking away from that part the pressure of the atmosphere; but I could not understand how this pressure produced such an effect.

MRS. B.

The air-pump affords us the means of making a great variety of interesting experiments on the weight and pressure of the air; some of them you have already seen. Do you not recollect, that in a vacuum produced within the air-pump, substances of various weights fell to the bottom in the same time; why does not this happen in the atmosphere?

CAROLINE.

I remember you told us it was owing to the resistance which light bodies meet with from the air during their fall.

MRS. B.

Or, in other words, to the support which they receive from the air, and which prolongs the time of their fall. Now, if the air were destitute

of weight, how could it support other bodies, or retard their fall?

I will show you some other experiments, which illustrate, in a striking manner, both the weight and elasticity of air. I shall tie a piece of bladder over this glass receiver, which, you will observe, is open at the top as well as below.

CAROLINE.

Why do you wet the bladder first?

MRS. B.

It expands by wetting, and contracts in drying ; it is also more soft and pliable when wet, so that I can make it fit better ; and when dry it will be tighter. We must hold it to the fire in order to dry ; but not too near, lest it should burst by sudden contraction. Let us now fix it on the air-pump, and exhaust the air from underneath it ;— you will not be alarmed if you hear a noise.

EMILY.

It was as loud as the report of a gun, and the bladder is burst ! Pray explain what part the air acts in this experiment.

MRS. B.

It burst the bladder by its weight, when I had taken away the air from the under surface ; so that

there was no longer any re-action to counterbalance the pressure of the atmosphere on the bladder. You observed how it was pressed inwards by the weight of the external air, in proportion as I exhausted the receiver; and before a complete vacuum was formed, the bladder, unable to sustain the violence of the pressure, burst with the explosion you have just heard.

I shall now show you an experiment, which proves the expansion of the air, contained within a body when it is relieved from the pressure of the external air. You would not imagine that there was any air contained within this shrivelled apple, by its appearance; but take notice of it when placed within a receiver, from which I shall exhaust the air.

CAROLINE.

How strange! it grows quite plump, and looks like a fresh-gathered apple.

MRS. B.

But as soon as I let the air again into the receiver, the apple, you see, returns to its shrivelled state. When I took away the pressure of the atmosphere, the air within the apple expanded and swelled it out: but the instant the atmospherical air was restored, the expansion of the internal air was checked and repressed, and the apple shrunk to its former dimensions.

You may make a similar experiment with this little bladder, which you see is perfectly flaccid, and appears to contain no air: in this state, I shall tie up the neck of the bladder, so that whatever air remains within it may not escape, and then place it under the receiver. Now observe, as I exhaust the receiver, how the bladder distends; from whence does this proceed?

CAROLINE.

From the great dilatation of the small quantity of air which was enclosed within the bladder when you tied it up; but as soon as you let the air into the receiver, that which the bladder contains condenses and shrinks into a small compass within the folds of the bladder.

MRS. B.

Very well, if you place two bodies so closely together that there is absolutely no air between them to counterbalance by its elasticity the pressure of the air on their outer surfaces, that whole pressure resists their separation. By such means you may raise a stone by a piece of leather sufficiently moistened to be capable of being closely pressed to it, to which a string is affixed; on raising the string, you perceive that the stone remains so closely united to the leather, as to appear to be part of it.



EMILY.

These experiments are extremely amusing, and they afford clear proofs both of the weight and elasticity of the air; but I should like to know exactly how much the air weighs.

MRS. B.

A column of air reaching to the top of the atmosphere, and whose base is a square inch, weighs 15 lbs. when the air is heaviest; therefore every square inch of our bodies sustains a weight of 15 lbs.; and if you wish to know the weight of the whole of the atmosphere, you must reckon the number of square inches on the surface of the globe, and multiply them by 15.

EMILY.

But are there no means of ascertaining the weight of a small quantity of air?

MRS. B.

Nothing more easy. I shall exhaust the air from this little bottle by means of the air pump; and having emptied the bottle of air, or having, in other words, produced a vacuum within it, I secure it by turning this screw adapted to its neck: we may now find the exact weight of this bottle, by putting it into one of the scales of the balance. It weighs, you see, just two ounces; but when I turn the screw so as to admit the air into the bottle, the scale in which the bottle is placed preponderates.

CAROLINE.

No doubt, the bottle filled with air is heavier than the bottle void of air; and the additional weight required to bring the scales again to a balance, must be exactly that of the air which the bottle now contains.

MRS. B.

That weight, you see, is almost two grains. The dimensions of this bottle are six cubic inches. Six cubic inches of air, therefore, at the temperature of this room, weigh nearly 2 grains.

CAROLINE.

Why do you observe the temperature of the room, in estimating the weight of the air?

MRS. B.

Because heat expands, and rarefies air, rendering it lighter; therefore the warmer the air is in which you weigh any thing, the lighter it will be.

If you should now be desirous of knowing the specific gravity of this air, we need only fill the same bottle with water, and thus obtain the weight of an equal quantity of water—which, you see, is 1515 grs.; now, by comparing the weight of water to that of air, we find it to be in the proportion of about 800 to 1.

I will show you another instance of the weight of the atmosphere, which I think will please you; you know what a barometer is?

CAROLINE.

It is an instrument which indicates the state of the weather, by means of a tube of quicksilver; but how, I cannot exactly say.

MRS. B.

It is by showing the weight of the atmosphere. The barometer is an instrument extremely simple in its construction: in order that you may understand it, I will show you how it is made. I first fill a glass tube, AB (fig. 4. Plate XIV.), about three feet in length, and open only at one end, with mercury; then stopping the open end with my finger, I immerse it in a cup, C, containing a little mercury.

EMILY.

Part of the mercury which was in the tube, I observe, runs down into the cup: but why does not the whole of it subside in the cup; for it is contrary to the law of the equilibrium of fluids that the mercury in the tube should not descend to a level with that in the cup?

MRS. B.

The mercury that has fallen from the tube into the cup has left a vacant space in the upper part of the tube, to which the air cannot gain access. This space is therefore a perfect vacuum; and consequently the mercury in the tube is relieved from the pressure of the atmosphere, whilst that in the cup remains exposed to it.

CAROLINE.

Oh, now I understand it: the pressure of the air on the mercury in the cup forces it to rise in the tube, where it sustains no pressure.

EMILY.

Or, rather, supports the mercury in the tube, and prevents it from falling.

MRS. B.

That comes to the same thing; for the power which can support mercury in a vacuum would also make it ascend when it met with a vacuum.

Thus you see that the equilibrium of the mercury is destroyed only to preserve the general equilibrium of fluids.

CAROLINE.

But this simple apparatus is, in appearance, very unlike a barometer.

MRS. B.

It is all that is essential to a barometer. The tube and the cup or vase are fixed on a board, for the convenience of suspending it: the board is graduated for the purpose of ascertaining the height at which the mercury stands in the tube; and the small moveable metal plate serves to show that height with greater accuracy.

EMILY.

And at what height will the weight of the atmosphere sustain the mercury?

MRS. B.

About  $29\frac{1}{2}$  inches, as you will see by this barometer; but the exact height depends upon the weight of the atmosphere, which varies much according to the state of the weather. The greater the pressure of the air on the mercury in the cup, the higher it will ascend in the tube. Now, can you tell me whether the air is heavier in wet or dry weather?

CAROLINE.

Without a moment's reflection, the air must be heaviest in wet weather. It is so depressing, and makes one feel so heavy; while in fine weather I feel as light as a feather, and as brisk as a bee.

MRS. B.

Would it not have been better to have answered with a moment's reflection, Caroline? It would have convinced you, that the air must be heaviest in dry weather; for it is then that the mercury is found to rise in the tube, and, consequently, the mercury in the cup must be most pressed by the air; and you know, that we estimate the dryness and fairness of the weather by the height of the mercury in the barometer.

CAROLINE.

Why, then, does the air feel so heavy in bad weather?

MRS. B.

Because it is less salubrious when impregnated with damp. The lungs, under these circumstances, do not play so freely, nor does the blood circulate so well: thus obstructions are frequently occasioned in the smaller vessels, from which arise colds, asthmas, agues, fevers, &c.

EMILY.

Since the atmosphere diminishes in density in the upper regions, the air must be more rare upon a hill than in a plain;—does the barometer indicate this difference?

MRS. B.

Certainly. The hills in this country are not sufficiently elevated to produce any very considerable effect on the barometer; but this instrument is so exact in its indications, that it is used for the purpose of measuring the heights of mountains and of estimating the elevation of balloons.

EMILY.

And is no inconvenience experienced from the thinness of the air in such elevated situations?

MRS. B.

Oh, yes; frequently. It is sometimes oppressive from being insufficient for respiration; and the expansion which takes place in the more dense air contained within the body is often painful; it occasions distension, and sometimes causes the bursting of the smaller blood-vessels in the nose and ears. Besides, in such situations, you are more exposed both to heat and cold; for though the atmosphere is itself transparent, its lower regions abound with vapours and exhalations from the earth, which float in it, and act in some degree as a covering, which preserves us equally from the intensity of the sun's rays, and from the severity of the cold.

CAROLINE.

Pray, Mrs. B., is not the thermometer constructed on the same principles as the barometer?

MRS. B.

Not at all. The rise and fall of the fluid in the thermometer is occasioned by the expansive power of heat, and the condensation produced by cold; the air has no access to it. An explanation of it would, therefore, be irrelevant to our present subject.

EMILY.

I have been reflecting that, since it is the weight of the atmosphere which supports the mercury in

the tube of a barometer, it would support a column of any other fluid in the same manner.

MRS. B.

Certainly. But as mercury is the heaviest of all fluids, it will support a higher column of any other fluid; for two fluids are in equilibrium, when their heights vary inversely as their densities; as, for instance, if a cubic foot of one fluid weigh twice as much as a cubic foot of the other, a column of the first ten feet in height will weigh as much as a column of the other twenty feet in height. We find the weight of the atmosphere is equal to sustaining a column of water, for instance, of no less than 32 feet above its level.

CAROLINE.

The weight of the atmosphere is, then, as great as that of a body of water surrounding the globe of the depth of 32 feet.

MRS. B.

Precisely; for a column of air of the height of the atmosphere is equal to a column of water of 32 feet, or one of mercury of 28 inches, each having the same base.

The common pump is constructed on this principle. By the act of pumping, the pressure of the atmosphere is taken off the water, which, in consequence, rises.



The body of a pump consists of a large tube or pipe, whose lower end is immersed in the water which it is designed to raise. A kind of stopper called a piston is fitted to this tube, and is made to slide up and down it by means of a metallic rod fastened to the centre of the piston.

EMILY.

Is it not similar to the syringe, or squirt, with which you first draw in and then force out water?

MRS. B.

It is; but you know that we do not wish to force the water out of the pump at the same end of the pipe at which we draw it in. The intention of a pump is to raise water from a spring or well; the pipe is, therefore, placed perpendicularly over the water, which enters it at the lower extremity, and it issues at a horizontal spout towards the upper part of the pump. The pump, therefore, is rather a more complicated piece of machinery than the syringe.

Its various parts are delineated in this figure (fig. 5. Plate XIV.): A B is the pipe or body of the pump; P the piston; V a valve, or little door, in the piston, which, opening upwards, admits the water to rise through it, but prevents its returning; and Y a similar valve in the body of the pump.

When the pump is in a state of inaction, the

two valves are closed by their own weight; but when, by drawing down the handle of the pump, the piston ascends, it raises a column of air which rested upon it, and produces a vacuum between the piston and the lower valve, Y; the air beneath this valve, which is immediately over the surface of the water, consequently expands, and forces its way through it; the water then, relieved from the pressure of the air, ascends into the pump. A few strokes of the handle totally exclude the air from the body of the pump, and fill it with water which having passed through both the valves, flows out at the spout.

CAROLINE.

I understand this perfectly. When the piston is raised, the air and the water successively rise in the pump; for the same reason that the mercury rises in the barometer.

EMILY.

I thought that water was drawn up into a pump by suction, in the same manner as water may be sucked through a straw.

MRS. B.

It is so, into the body of the pump; for the power of suction is no other than that of producing a vacuum over one part of the liquid, into which vacuum the liquid is forced by the pressure of the

atmosphere on another part. The action of sucking through a straw consists in drawing in and confining the breath, so as to produce a vacuum in the mouth; in consequence of which, the air within the straw rushes into the mouth, and is followed by the liquid, into which the lower end of the straw is immersed. The principle you see, is the same; and the only difference consists in the mode of producing a vacuum. In suction, the muscular powers answer the purpose of the piston and valves.

EMILY.

Water cannot, then, be raised by a pump above 32 feet, for the pressure of the atmosphere will not sustain a column of water above that height.

MRS. B.

I beg your pardon. It is true that there must never be so great a distance as 32 feet from the level of the water in the well to the valve in the piston, otherwise the water would not rise through the valve; but when once the water has passed that opening it is no longer the pressure of air on the reservoir which makes it ascend; it is raised by lifting it up, as you would raise it in a bucket, of which the piston formed the bottom. This common pump is, therefore, called the sucking and lifting pump, as it is constructed on both these principles. There is another sort of pump, called

the forcing pump; it consists of a forcing power added to the sucking part of the pump. This additional power is exactly on the principle of the syringe: by raising the piston, you draw the water into the pump; and by making it descend, you force the water out.

CAROLINE.

But the water must be forced out at the upper part of the pump; and I cannot conceive how that can be done by making the piston descend.

MRS. B.

Figure 6. Plate XIV. will explain the difficulty. The large pipe, AB, represents the sucking part of the pump, which differs from the lifting pump only in its piston, P, being unfurnished with a valve, in consequence of which the water cannot rise above it. When, therefore, the piston descends, it shuts the valve, Y, and forces the water (which has no other vent) into the pipe, D; this is likewise furnished with a valve, V, which, opening outwards, admits the water, but prevents its return.

The water is thus first raised in the pump, and then forced into the pipe, by the alternate ascending and descending motion of the piston, after a few strokes of the handle to fill the pipe, from whence the water issues at the spout.

It is now time to conclude our lesson. When

next we meet, I shall give you some account of wind, and of sound, which will terminate our observations on elastic fluids.

CAROLINE.

And I shall run into the garden, to have the pleasure of pumping, now that I understand the construction of a pump.

MRS. B.

Then to-morrow, I hope, you will be able to tell me, whether it is a forcing or a common lifting pump.

## CONVERSATION XIV.

## ON WIND AND SOUND.

OF WIND IN GENERAL.—OF THE TRADE-WIND.—OF THE PERIODICAL TRADE-WINDS.—OF THE AËRIAL TIDES.—OF SOUND IN GENERAL.—OF SONOROUS BODIES.—OF MUSICAL SOUNDS.—OF CONCORD OR HARMONY, AND MELODY.

MRS. B.

WELL, Caroline, have you ascertained what kind of pump you have in your garden?

CAROLINE.

I think it must be merely a lifting pump, because no more force is required to raise the handle than is necessary to lift its weight; and in a forcing pump, by raising the handle, you force the water into the smaller pipe, and the resistance which the water offers must require an exertion of strength to overcome it.

MRS. B.

I make no doubt you are right; for lifting pumps, being simple in their construction, are by far the most common.

I have promised to-day to give you some account of the nature of wind. Wind is nothing more than the motion of a stream or current of air, which may be produced by a variety of chemical and meteorological causes; but the most common cause is a partial change of temperature in the atmosphere; for when any one part is more heated than the rest, that part is rarefied; the equilibrium is destroyed, and the air in consequence rises. When this happens, there necessarily follows a motion of the surrounding air towards that part, in order to restore it; this spot, therefore, receives wind from every quarter. Those who live to the north of it experience a north wind; those to the south, a south wind:—do you comprehend this?

CAROLINE.

Perfectly. But what sort of weather must those people have, who live on the spot where these winds meet and interfere?

MRS. B.

In temperate climates this produces no disagreeable effects; but in hot climates it is frequently attended with very serious consequences.

They have turbulent and boisterous weather, whirlwinds, hurricanes, rain, lightning, thunder, &c. This stormy weather occurs most frequently in the torrid zone, where the heat is greatest; the air being more rarefied there than in any other part of the globe, is lighter, and, consequently, ascends; whilst the air about the polar regions is continually flowing from the poles, to restore the equilibrium.

## CAROLINE.

Then, this motion of the air should produce a regular and constant north wind to the inhabitants of the northern hemisphere, and a south wind to those of the southern hemisphere, and continual storms at the equator, where these two adverse winds would meet.

## MRS. B.

These winds do not meet without previously changing their direction. The atmosphere, you know, accompanies the earth in its diurnal motion; it travels, therefore, with greater or less velocity as it is nearer the equator, or more distant from it. The air, therefore, flowing from the north or south to restore the atmospherical equilibrium at the equator, and not having acquired the velocity of the equatorial regions, cannot keep pace with the earth, which, travelling faster, passes through it; and as the earth moves from west to east, its



motion through the air produces a regular east wind at the equator.

CAROLINE.

But I wonder how you will reconcile these contrary winds, Mrs. B. You first led me to suppose there was a constant struggle between opposite winds at the equator, producing storm and tempest; but now I hear of one regular invariable wind, which must naturally be attended by calm weather.

EMILY.

I think I understand it. Do not the winds from the north and south combine with the easterly wind about the equator, and form what are called the trade-winds?

MRS. B.

Just so. The composition of the two winds north and east produces a constant north-east wind; and that of the two winds south and east produces a regular south-east wind. These winds extend to about thirty degrees on each side of the equator, the regions farther distant from it experiencing only their respective north and south winds.

CAROLINE.

But, Mrs. B., if the air is constantly flowing from the poles to the torrid zone, there must be a deficiency of air in the polar regions?

MRS. B.

No; because the light air about the equator, which expands and rises into the upper regions of the atmosphere, ultimately flows from thence back to the poles, to restore the equilibrium. If it were not for this resource, the polar atmospheric regions would soon be exhausted by the stream of air, which, in the lower strata of the atmosphere, they are constantly sending towards the equator.

CAROLINE.

There is, then, a sort of circulation in the atmosphere; the air in the lower strata flowing from the poles towards the equator, and in the upper strata flowing back from the equator, towards the poles.

MRS. B.

Exactly. I can show you an example of this circulation on a small scale. The air of this room being warmed by the fire, and, consequently, more rarefied than the external air, a wind or current of air is pouring in from the crevices of the windows and doors, to restore the equilibrium; but the light air with which the room is filled must find some vent, in order to make way for the heavy air which enters. If you set the door a-jar, and hold a candle near the upper part of it, you will find that the flame will be blown outwards, showing that there is a draft or current of air flowing

out from the upper part of the room.—Now, place the candle on the floor close by the door, and you will perceive, by the inclination of the flame, that there is also a current of air setting into the room.

CAROLINE.

It is just so. The upper current is the warm light air, which is driven out to make way for the stream of cold dense air which enters below.

EMILY.

I have heard much of the violent tempests occasioned by the breaking up of the monsoons; are not they also regular trade-winds?

MRS. B.

They are called periodical trade-winds, as they change their course every half-year. This variation is produced by the earth's annual course round the sun, when the north pole is inclined towards that luminary one half of the year, and the south pole the other half. During the summer of the northern hemisphere, the countries of Arabia, Persia, India, and China, are much heated and reflect great quantities of the sun's rays into the atmosphere, by which it becomes extremely rarefied, and the equilibrium consequently destroyed. In order to restore it, the air from the equatorial southern regions, where it is colder (as well as

from the colder northern parts), must necessarily have a motion towards those parts. The current of air from the equatorial regions produces the trade-winds for the first six months in all the seas between the heated continent of Asia and the equator. The other six months, when it is summer in the southern hemisphere, the ocean and countries towards the southern tropic are most heated, and the air over those parts most rarefied; then the air about the equator alters its course, and flows exactly in an opposite direction.

CAROLINE.

This explanation of the monsoons is very curious: but what does their breaking up mean?

MRS. B.

It is the name given by sailors to the shifting of the periodical winds; they do not change their course suddenly, but by degrees, as the sun moves from one hemisphere to the other. This change is usually attended by storms and hurricanes, very dangerous for shipping; so that those seas are seldom navigated at the season of the equinox.

EMILY.

I think I understand the winds in the torrid zone perfectly well; but what is it that occasions the great variety of winds which occur in the tem-

perate zones? for, according to your theory, there should be only north and south winds in those climates.

MRS. B.

Since so large a portion of the atmosphere as is over the torrid zone is in continued agitations, these agitations in an elastic fluid, which yields to the slightest impression, must extend every way to a great distance. The air, therefore, in all climates will suffer more or less perturbation, according to the situation of the country, the position of mountains, valleys, and a variety of other causes; hence it is easy to conceive that almost every climate must be liable to variable winds. The air is so very easily affected by external causes that the slightest change of temperature, however local and however transitory, is sufficient to produce a gentle wind. Have you never observed that on a fine calm summer's day, if a small cloud obscures the sun for a few minutes, the air feels not only cooler, but it is set in motion, a gentle wind springing up, which subsides as soon as the sun re-appears, and restores the former temperature.

EMILY.

That is very curious; and I have observed that on the sea-shore a gentle sea-breeze generally sets in on the land on a summer's evening; how do you account for that?

MRS. B.

It is in order to restore the equilibrium which had been disturbed by reflections from the heated surface of the shore during the day; and when night has cooled the earth and condensed the air, at the approach of morning, it flows back towards the sea.

CAROLINE.

Is it known at what rate the wind moves, Mrs. B.?

MRS. B.

The velocity of the wind is calculated by an instrument called an anemometer, and it is found to vary from 10 to 130 feet in a second.

EMILY.

Since the air is a gravitating fluid, is it not affected by the attraction of the moon and the sun in the same manner as the waters?

MRS. B.

Undoubtedly; but as air is so much less dense a body than water, the aërial tides are scarcely sensible in comparison of those of water, and have no practical importance.

I shall now explain to you the nature of sound, which is intimately connected with that of air.

We have considered the effects produced by the wide and extended agitation of the air; but

there is another kind of agitation of which the air is susceptible, a sort of vibratory tremulous motion, which, striking on the drum of the ear, produces *sound*.

CAROLINE.

Is not sound produced by solid bodies? The voice of animals, the ringing of bells, musical instruments, are all solid bodies. I know of no sound but that of the wind which is produced by the air.

MRS. B.

Sound, I assure you, in all cases, results from a tremulous motion of the air; and the sonorous bodies you enumerate are merely the instruments by which that peculiar species of motion is communicated to the air.

CAROLINE.

What! when I ring this little bell, is it the air that sounds, and not the bell?

MRS. B.

Both the bell and the air are concerned in the production of sound, no doubt; but sound, strictly speaking, is a perception excited in the mind by the motion of the air on the nerves of the ear; the air, therefore, as well as the sonorous bodies which put it in motion, are only the cause of sound; the immediate effect is produced by the sense of hear-

ing, for without this sense there would be no sound.

EMILY.

That I can with difficulty conceive. A person born deaf, it is true, has no idea of sound, because he hears none; yet that does not prevent the real existence of sound, as all those who are not deaf can certify.

MRS. B.

I do not doubt the existence of sound to those who possess the sense of hearing: all I mean to say is, that it exists neither in the sonorous body nor in the air, but in the mind of the person whose ear is struck by the vibratory motion of the air produced by a sonorous body.

To convince you that sound does not exist in sonorous bodies, but that air or some other vehicle is necessary to its production, endeavour to ring the little bell, after I have suspended it under a receiver in the air pump, from which I shall exhaust the air . . . . .

CAROLINE.

This is indeed very strange. Though I shake it so violently, it does not produce the least sound.

MRS. B.

By exhausting the receiver, I have cut off the communication between the air and the bell; the



latter, therefore, cannot impart its motion to the air.

CAROLINE.

Are you sure that it is not the glass which covers the bell, that prevents our hearing it?

MRS. B.

That you may easily ascertain, by letting the air into the receiver, and then ringing the bell.

CAROLINE.

Very true. I can hear it now almost as loud as if the glass did not cover it; and I can no longer doubt but that air is necessary to the production of sound.

MRS. B.

And your ears are quite as essential to the existence of sound as the bell and the air; for were you not present, nor any other living being endowed with the sense of hearing, no sound would be produced; the bell might shake, and the air be put in a tremulous motion, but unless there were ears to hear, it would be all in vain.

EMILY.

How very extraordinary! Then, in order to produce sound, there must be a sonorous body, and air, and ears to hear it.

MRS. B.

Air is not absolutely necessary, though by far the most common vehicle of sound. Liquids as well as air are capable of conveying the vibratory motion of a sonorous body to the organ of hearing; for sound can be heard under water. Solid bodies also convey sound, as I can soon convince you by a very simple experiment. I shall fasten this string by the middle round the poker; now raise the poker from the ground by the two ends of the string, and hold one to each of your ears; —I shall now strike the poker with a key, and you will find that the sound is conveyed to the ear by means of the strings, in a much more perfect manner than if it had no other vehicle than the air.

CAROLINE.

That it is, certainly, for I am almost stunned by the noise. But what is a sonorous body, Mrs. B.? for all bodies are capable of producing some kind of sound by the motion they communicate to the air.

MRS. B.

Those bodies are called sonorous, which produce clear, distinct, regular, and durable sounds, such as a bell, a drum, musical strings, wind instruments, &c. They owe this property to their elasticity: for an elastic body, after having been

struck, not only returns to its former situation, but having acquired momentum by its velocity, like the pendulum, it springs out on the opposite side. If the string A B (fig. 7. Plate XIV.), which is made fast at both ends to C, be drawn on one side, it will not only return to its original position, but proceed onwards to D. This is the first vibration, at the end of which it will retain sufficient velocity to bring it to E, and back again to F, which constitutes its second vibration: the third vibration will carry it only to G and H, and so on, till the resistance of the air destroys its motion.

The vibration of a sonorous body gives a tremulous motion to the air around it, very similar to the motion communicated to smooth water when a stone is thrown into it. This first produces a small circular wave round the spot in which the stone falls; the wave spreads, and gradually communicates its motion to the adjacent waters, producing similar waves to a considerable extent. The same kind of waves are produced in the air by the motion of a sonorous body, but with this difference, that air being an elastic fluid, the motion does not consist of regularly extending waves, but of vibrations, composed of a motion forwards and backwards, similar to those of a sonorous body. They differ also in the one taking place in a plane, the other in all directions; the aërial undulations being spherical.

EMILY.

But if the air moves backwards as well as forwards, how can its motion extend so as to convey sound to a distance?

MRS. B.

The first sphere of undulations which are produced immediately around the sonorous body, by pressing against the contiguous air, condenses it. The condensed air, though impelled forwards by the pressure, re-acts on the first set of undulations, driving them back again. The second set of undulations which have been put in motion, in their turn communicate their motion, and are themselves driven back by reaction. Thus there is a succession of vibrations in the air, corresponding with the succession of waves in the water.

CAROLINE.

The vibrations of sound must extend much farther than the circular waves in water, since sound is conveyed to a great distance.

MRS. B.

This is owing to the elasticity of the air. The report of a cannon produces vibrations of the air, which extend several miles around.

EMILY.

Distant sound takes some time to reach us, since it is produced at the moment the cannon is

fired; and we see the light of the flash long before we hear the report.

MRS. B.

The air is immediately put in motion by the firing of a cannon; but it requires time for the vibrations to extend to any distant spot. The velocity of sound is computed to be at the rate of 1142 feet in a second.

CAROLINE.

With what astonishing rapidity the vibrations must be communicated! But the velocity of sound varies, I suppose, with that of the air which conveys it. If the wind sets towards us from the cannon, we must hear the report sooner than if it sets the other way.

MRS. B.

The direction of the wind makes less difference in the velocity of sound than you would imagine. If the wind sets from us, it bears most of the aërial waves away, and renders the sound fainter; but it is not very considerably longer in reaching the ear than if the wind blew towards us. This uniform velocity of sound enables us to determine the distance of the object whence it proceeds; as that of a vessel at sea firing a cannon, or that of a thunder cloud. If we do not hear the thunder till half a minute after we see the lightning, we

conclude the cloud to be at the distance of six miles and a half.

EMILY.

Pray how is the sound of an echo produced?

MRS. B.

When the aërial vibrations meet with an obstacle having a hard and regular surface, such as a wall, or rock, they are reflected back to the air, and produce the same sound a second time; but the sound will then appear to proceed from the object by which it is reflected. If the vibrations fall perpendicularly on the obstacle, they are reflected back in the same line; if obliquely, the sound returns obliquely in the opposite direction, the angle of reflection being equal to the angle of incidence.

CAROLINE.

Oh, then, Emily, I now understand why the echo of my voice behind our house is heard so much plainer by you than it is by me, when we stand at the opposite ends of the gravel walk. My voice, or rather, I should say, the vibrations of air it produces, fall obliquely on the wall of the house, and are reflected by it to the opposite end of the gravel walk.

EMILY.

Very true; and we have observed, that when we stand in the middle of the walk, opposite the house, the echo returns to the person who spoke.

MRS. B.

Speaking-trumpets are constructed on the principle of the reflection of sound. The voice, instead of being diffused in the open air, is confined within the trumpet; and the vibrations, which spread and fall against the sides of the instrument, are reflected according to the angle of incidence, and fall into the direction of the vibrations which proceed straight forwards. The whole of the vibrations are thus collected into a focus; and if the ear be situated in or near that spot, the sound is prodigiously increased. Figure 8. Plate XIV. will give you a clearer idea of the speaking-trumpet: the reflected rays are distinguished from those of incidence by being dotted; and they are brought to a focus at F. The trumpet used by deaf persons acts on the same principle; but as the voice enters the trumpet at the large, instead of the small end of the instrument, it is not so much confined, nor the sound so much increased.

EMILY.

Are the trumpets used as musical instruments constructed on this principle also?

MRS. B.

So far as their form tends to increase the sound, they are; but, as a musical instrument, the trumpet

becomes itself the sonorous body, which is made to vibrate by blowing into it, and communicates its vibrations to the air.

I will attempt to give you, in a few words, some notion of the nature of musical sounds, which, as you are fond of music, must be interesting to you.

If a sonorous body be struck in such a manner, that its vibrations are all performed in regular times, the vibrations of the air will correspond with them; and, striking in the same regular manner on the drum of the ear, will produce the same uniform sensation on the auditory nerve, and excite the same uniform idea in the mind: or, in other words, we shall hear one musical tone.

But if the vibrations of the sonorous body are irregular, there will necessarily follow a confusion of aërial vibrations; for a second vibration may commence before the first is finished, meet it half way on its return, interrupt it in its course, and produce harsh jarring sounds, which are called *discords*.

#### EMILY.

But each set of these irregular vibrations, if repeated at equal intervals, would, I suppose, produce a musical tone. It is only their irregular succession which makes them interfere and occasions discord.



MRS. B.

Certainly. The quicker a sonorous body vibrates, the more acute, or sharp, is the sound produced.

CAROLINE.

But if I strike any one note of the pianoforte repeatedly, whether quickly or slowly, it always gives the same tone.

MRS. B.

Because the vibrations of the same string, at the same degree of tension, are always of a similar duration. The quickness or slowness of the vibrations relate to the single tones, not to the various sounds which they may compose by succeeding each other. Striking the note in quick succession produces a more frequent repetition of the tone, but does not increase the velocity of the vibrations of the string. The duration of the vibrations of strings or chords depends upon their length, their thickness or weight, and their degree of tension; thus, you find, the low bass notes are produced by long, thick, loose strings; and the high treble notes by short, small, and tight strings.

CAROLINE.

Then the different length and size of the strings of musical instruments serves to vary the duration of the vibrations, and, consequently, the acuteness or gravity of the notes.

MRS. B.

Yes. Among the variety of tones, there are some which, sounded together, please the ear, producing what we call harmony, or concord. This is supposed to arise from the agreement of the vibrations of the two sonorous bodies; so that some of the vibrations of each strike upon the ear at the same time. Thus, if the vibrations of two strings are performed in equal times, the same tone is produced by both, and they are said to be in unison.

EMILY.

Now, then, I understand why, when I tune my harp in unison with the pianoforte, I draw the strings tighter if it is at too low, or loosen them if at too high a pitch, in order to bring them to vibrate in equal times with the strings of the piano.

MRS. B.

But concord, you know, is not confined to unison; for two different tones harmonise in a variety of cases. If the vibrations of one string, or of any sonorous body whatever, vibrate in double the time of another, the second vibration of the latter will strike upon the ear at the same instant as the first vibration of the former; and this is the concord of an octave.

If the vibrations of two strings are as two to three, the third vibration of the first corresponds

with the fourth vibration of the latter, producing the harmony called a fifth.

CAROLINE.

So, then, when I strike the key-note with its fifth, I hear every third vibration of one, and every fourth of the other at the same time.

MRS. B.

Yes; and the key-note struck with the fourth is likewise a concord, because the vibrations are as three to four. The vibrations of a major third with the key-note are as four to five; and those of a minor third, as five to six.

There are other tones which, though they cannot be struck together without producing discord, if struck successively, give us the pleasure which is called melody. Upon these general principles the science of music is founded; but I am not sufficiently acquainted with it to enter any farther into details.

We shall now, therefore, take leave of the subject of sound; and, at our next interview, enter upon that of optics, in which we shall consider the nature of vision, light, and colours.

## CONVERSATION XV.

## ON OPTICS.

OF LUMINOUS, TRANSPARENT, AND OPAQUE BODIES.  
 — OF THE RADIATION OF LIGHT. — OF THE NATURE  
 OF LIGHT. — OF SHADOWS. — OF THE REFLECTION  
 OF LIGHT. — OPAQUE BODIES SEEN ONLY BY RE-  
 FLECTED LIGHT. — VISION EXPLAINED. — CAMERA  
 OBSCURA. — IMAGE OF OBJECTS ON THE RETINA.  
 — OF THE PERCEPTION TO WHICH IT GIVES RISE  
 IN THE MIND.

CAROLINE.

I LONG to begin our lesson to-day, Mrs. B., for I expect that it will be very entertaining.

MRS. B.

Optics is certainly one of the most interesting branches of Natural Philosophy, but not one of the easiest to understand; I must therefore beg that you will give me the whole of your attention.

I shall first inquire, whether you comprehend the meaning of a *luminous body*, an *opaque body*, and a *transparent body* ?

CAROLINE.

A luminous body is one that shines ; an opaque . . . . .

MRS. B.

Do not proceed to the second until we have agreed upon the definition of the first. All bodies that shine are not luminous ; for a luminous body is one that shines by its own light, as the sun, the fire, the candle, &c.

EMILY.

A polished metal, then, when it shines with so much brilliancy, is not a luminous body ?

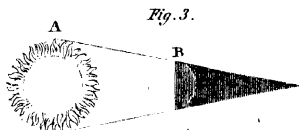
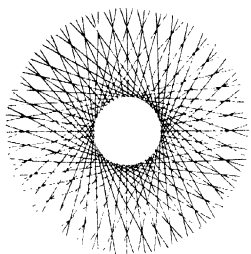
MRS. B.

No ; for it would be dark if it did not receive light from a luminous body ; it belongs, therefore, to the class of opaque or dark bodies, which comprehends all such as are neither luminous by themselves, nor will admit the light to pass through them.

EMILY.

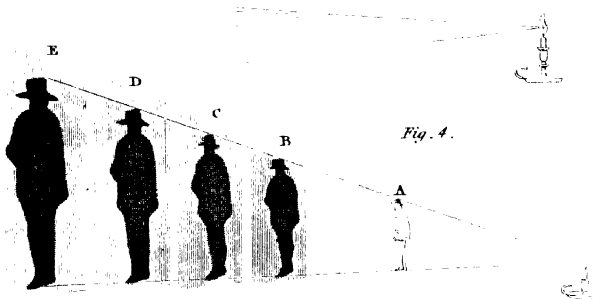
And transparent bodies are those which admit the light to pass through them ; such as glass and water.



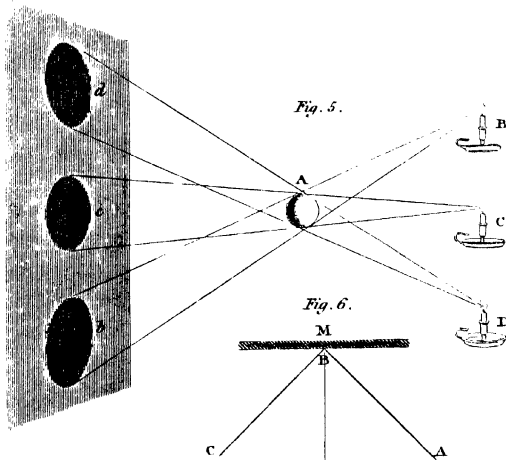


*Fig. 3.*

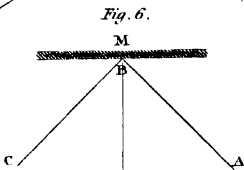
*Fig. 2.*



*Fig. 4.*



*Fig. 5.*



*Fig. 6.*

MRS. B.

You are right. There are, however, no bodies so perfectly transparent as to transmit all the rays, nor any so opaque as not to transmit some of them, if cut into sufficiently thin layers. Thus gold may be made to admit a passage to some of the rays of light.

Transparent or pellucid bodies are frequently called *mediums*; and the rays of light which pass through them are said to be *transmitted* by them.

A ray, when emanating from the sun or any other luminous body, is projected forwards in straight lines in every direction; so that the luminous body is not only the general centre whence all the rays proceed, but every point of it may be considered as a centre which radiates light in every direction. (Fig. 1. Plate XV.)

EMILY.

And the sun, which appears to be the grand source of light and heat, is itself, I suppose, composed of fire.

MRS. B.

We are entirely ignorant of what nature the sun is; but it is conjectured to be a dense opaque body floating in an ocean of light, through which its nucleus partially appears, like dark spots.

A A



CAROLINE.

The sun and earth are, then, exactly the reverse of each other; for I recollect your saying that the earth is supposed to consist of a mass of liquid fire enclosed in a solid crust; while the sun is a solid body, surrounded by an ocean of light.

MRS. B.

You must recollect that these are but mere conjectures with regard to either. A ray of light is a single line of light, emanating from a luminous body.

CAROLINE.

Is light, then, a substance, composed of corpuscular particles, like other bodies?

MRS. B.

Such was the supposition formerly entertained; and though there are some persons who still maintain that opinion, it is now generally believed, that light is produced by the vibrations of a very subtle ethereal fluid which is supposed to pervade all space. That this fluid is put in motion by the particles of luminous bodies, which are in constant agitation, and possess the property of exciting regular vibrations in the ethereal medium, the first impulse being transferred from particle to particle, and the undulation darting through the ether like a wave in water, till it reaches the eye, and produces the sensation of sight.

EMILY.

But why should you not call this ethereal fluid light, since light is produced by its vibrations?

MRS. B.

You do not say that sound is air, though the impression of sound on the ear is made by the vibratory motions of that fluid. This ethereal fluid is supposed to pervade all space, in darkness as well as in light, at night as well as in day; there is, therefore, still less reason to call this fluid light, than there is to call air sound.

EMILY.

It is very certain that we cannot call it light during the night. Light, then, consists of the tremulous motion of an ethereal substance, though it is not a substance itself.

MRS. B.

Yes; but remember that we have no direct knowledge of this ethereal fluid; its existence, even, is hypothetical.

CAROLINE.

But can the vibrations of this fluid take place in the interior of transparent bodies? for light, you know, passes through transparent bodies.

MRS. B.

Yes; this fluid is supposed to pervade all bodies, and its vibrations to be performed within the interstices of their molecules.

CAROLINE.

How extremely small, then, the vibrations must be! It really strains the imagination, to conceive the minuteness of the particles of which this fluid must be composed.

MRS. B.

In our conversations on astronomy, our ideas could not expand sufficiently to comprehend the immensity of the universe; as we approach towards infinity, whether it be in regard either to small or great dimensions, we perceive how narrow are the limits of our understandings: and I know not whether the mind is more overpowered by the idea of innumerable worlds revolving throughout unbounded space, or by that of a fluid whose particles are so minute that it vibrates freely in spaces too small to be perceived by the senses. It is also difficult to say, which of these extremes in the scale of creation is calculated to give us the most sublime ideas of the wisdom and power of the Creator.

But to return to our subject.

A sunbeam, or ray of light from any luminous body, we may consider as a succession of these vibrations in a straight line, extending from the luminous body to the eye; and a pencil of rays as a collection of them, proceeding from any one point of a luminous body

CAROLINE.

But you do not mean to say, Mrs. B., that the sun's rays would be dark and invisible if this ether did not exist?

MRS. B.

Certainly they would, if this theory be true.

CAROLINE.

Then I think it cannot be true: the idea of the sun sending forth dark rays is positively ludicrous.

EMILY.

It does not seem to me more so, than that the earth, which appears flat, should be spherical, or that we should feel no motion while we are travelling at the rate of a thousand miles in a minute.

CAROLINE.

It is so totally contrary to Nature as she appears to us.

MRS. B.

I am not teaching you what Nature appears to be, but what she really is, in spite of appearances. You must make up your mind to it, Caroline, as well as you can, for the present, trusting that conviction will come hereafter, as it has done in other cases.

CAROLINE.

Then does a candle also emit dark rays which put the ethereal fluid in motion, and produce light in the same manner as the sun does?

MRS. B.

Certainly; but it operates less perfectly on the ether, and produces light which is less pure. You may have observed that it has a yellower tint.

EMILY.

Pray tell me what becomes of the light of a candle when it is extinguished?

MRS. B.

When you extinguish a candle, you stop its combustion, and prevent any more light from being produced; or in other words, the candle sending forth no more of those particles which communicated vibrations to the ether, these vibrations cease and darkness ensues.

CAROLINE.

But what becomes of the light which the candle gave out before it was extinguished?

MRS. B.

An insensible moment of time is sufficient to disperse it throughout the room; and it is absorbed by the walls or other surrounding objects, so that darkness appears to succeed the extinction of light instantaneously. When you hear that light travels at the rate of 192,000 miles in a second, you wil

not wonder that you should not be able to distinguish the interval of time it takes to move from the candle to the surrounding objects in the room.

EMILY.

No, indeed! And what is it that produces shadows?

MRS. B.

When the vibrations of the ether meet with an opaque body, they cease to vibrate, and darkness is produced. But this darkness takes place only behind the object which interrupts the motion of the ether; the vibrations continue on each side of it, and thus define the outline of the shadow.

CAROLINE.

But this subtle and invisible ether, since it pervades all space, must be there where the shadow is?

MRS. B.

Certainly; but in a quiescent state, because the particles emanated by the sun cannot get access to it. It is as quiet, therefore, as the strings of a harp on which no one is playing, or the still water of a pond which the wind does not ruffle, and in which no boy throws a pebble to produce undulations.

CAROLINE.

You must admit, Mrs. B., that this *dark* daylight is very difficult to understand.

MRS. B.

Would you then wish that daylight should be without shadows?

CAROLINE.

No; I am alluding to the dark or invisible particles radiated by the sun; do pray, turn round and look at it; is it possible that those brilliant rays can be dark?

MRS. B.

No; I only say that they would be dark if they met with no ether to agitate them, and give birth to light.

CAROLINE.

Well! I wonder you did not say there were shadows to sound when you explained to us how the vibrations of the air produced sound: for when those vibrations are stopped by any obstacle, why should not they produce a shadow? I don't mean a shadow of darkness, but an effect analogous to that of the interruption of light. What would be produced by the absence of sound? Oh! it must be silence. Well, then, I mean that the absence of sound would produce silence.

MRS. B.

Your idea of the analogy between the shadow produced by the interruption of light and the

silence resulting from the interruption of sound, is perfectly correct. The two cases are similar, but we have no word to distinguish the shadow of sound from that of light, and it seems absurd to those who have not considered the subject scientifically, to talk of the shadow of sound.

EMILY.

An echo appears to me more like the shadow of sound than silence.

MRS. B.

Poetically speaking it is, but not philosophically; for an echo is the reflection of sound; and Caroline is quite right in considering silence as the shadow produced by sound.

EMILY.

Then the air behind the body which interrupted its vibrations would be perfectly still. But this does not actually take place, Mrs. B.: if I ring a bell on one side of the garden wall it is heard perfectly on the other side, and yet the vibrations cannot get through the wall any more than the vibrations of light.

MRS. B.

No: but they get over it; so that neither silence nor stillness is produced.



EMILY.

And why is not that the case with light, whose vibrations are so very minute that it seems as if they could make their way through any obstacle?

MRS. B.

The reason why sound is enabled to climb the wall, or to make its way round any obstacle it meets with, is, that air is a very elastic body, which enables the vibrations to make their way in every direction. When the sound from the bell reaches the wall, it is at first stopped, but its elasticity enables it to extend in every other direction, and part of it scales the wall and continues its course on the opposite side. Now the ether which produces light cannot be an elastic fluid, otherwise it would climb the wall as sound does, and prevent the formation of a shadow on the opposite side. We are led by this circumstance to conclude that the ether resembles a liquid rather than an elastic fluid, but of whatever nature it is, it so completely eludes the perception of our senses, that the ideas we form of it must necessarily be vague and uncertain.

EMILY.

If I recollect rightly, I think you told us that water was a still better conductor of sound than air. Now as water is a non-elastic fluid, its vibra-

tions could neither get over nor round about the object which stopped it, and consequently would produce that silence and stillness behind the obstacle which we have considered as the shadow of sound.

MRS. B.

And this is actually the case. If you ring a bell in a pond, or other body of water, and place some body to intercept the undulations, the bell will not be heard behind the obstacle, nor will any undulations be produced there.

But now let us return to the true shadow formed by the absence of light.

EMILY.

A shadow, then, is nothing more than darkness produced by the intervention of an opaque body, which prevents the rays of light from reaching an object behind the opaque body.

CAROLINE.

Why, then, are shadows of different degrees of darkness; for I should have supposed, from your definition of a shadow, that it would have been perfectly black?

MRS. B.

It frequently happens that a shadow is produced by an opaque body interrupting the course of the rays from one luminous body, while light from

another reaches the space where the shadow is formed, in which case the shadow is proportionally fainter. This happens if the opaque body be lighted by two candles: if you extinguish one of them, the shadow will be both deeper and more distinct.

CAROLINE.

But yet it will not be perfectly dark.

MRS. B.

Because it is still slightly illuminated by light reflected from the walls of the room, and from other surrounding objects.

You must observe, also, that when a shadow is produced by the interruption of rays from a single luminous body, the darkness is proportional to the intensity of the light.

EMILY.

I should have supposed the contrary; for as the light reflected from surrounding objects on the shadow must be in proportion to the intensity of the light, the stronger the light, the more the shadow will be illumined.

MRS. B.

Your remark is perfectly just; but as we have no means of estimating the degrees of light and of darkness but by comparison, the strongest light

will appear to produce the deepest shadow. Hence a total eclipse of the sun occasions a more sensible darkness than midnight, as it is immediately contrasted with the strong light of noonday.

## CAROLINE.

The re-appearance of the sun after an eclipse must by the same contrast be remarkably brilliant. But if we can judge of the intensity of light only by comparison, I should like to compare that of the sun to some light with which we are familiar; for instance, that of a candle.

## MRS. B.

The direct light of the sun, which we see only when we look at it, is said to be equal to that of 5563 moderate-sized wax candles placed at the distance of one foot from us.

There are several things to be observed in regard to the form and extent of shadows. If the luminous body, A (fig. 3.), be larger than the opaque body, B, the shadow will gradually diminish in size, till it terminate in a point; if smaller, the shadow will continually increase in size as it is more distant from the object which projects it.

## CAROLINE.

The first case is that of the shadows of the earth and the moon, as the sun which illumines

them is larger than either of those bodies. But why does not this happen with the shadows of terrestrial objects, which are equally illumined by the sun? Their shadows, far from diminishing, are always larger than the object, and increase with the distance from it.

MRS. B.

In estimating the effect of shadows, we must consider the *apparent* not the *real* dimensions of the luminous body; and in this point of view, the sun is a small object compared with the generality of the terrestrial bodies which it illumines; and when the luminous body is less than the opaque body, the shadow will increase with the distance to infinity. All objects, therefore, which are apparently larger than the sun, cast a magnified shadow. This will be best exemplified by observing the shadow of an object lighted by a candle.

EMILY.

I have often noticed that the shadow of my figure against the wall increases as it is more distant from me, which is owing, no doubt, to my being a larger object than the flame of the candle which shines on me.

MRS. B.

Yes. The shadow of a figure, A (fig. 4.), varies in size according to the distance of the several surfaces, B, C, D, E, on which it is described.

CAROLINE.

I have observed, that two candles produce two shadows from the same object; whilst it would appear, from what you said, that they should rather produce only half a shadow, that is to say, a very faint one.

MRS. B.

The number of lights (in different directions), while it decreases the intensity of the shadows, increases their number, which always corresponds with that of the lights; for each light makes the opaque body cast a different shadow, as illustrated by figure 5. It represents a ball, A, lighted by three candles, B, C, D; and you observe the light B produces the shadow *b*, the light C the shadow *c*, and the light D the shadow *d*.

EMILY.

I think we now understand the nature of shadows very well; but pray what becomes of the rays of light which opaque bodies arrest in their course, and the interruption of which is the occasion of shadows?

MRS. B.

Your question leads to a very important property of light, *Reflection*. When rays of light encounter an opaque body, which they cannot traverse, parts of them are absorbed by the body

itself, and part are reflected, rebounding from the surface of the body just like an elastic ball which is struck against a wall.

EMILY.

And is light in its reflection governed by the same laws as elastic bodies?

MRS. B.

Exactly. If a ray of light fall perpendicularly on an opaque body, it is reflected back in the same line, towards the point whence it proceeded. If it fall obliquely, it is reflected obliquely, but in the opposite direction; the angle of incidence being equal to the angle of reflection. You recollect that law in mechanics?

EMILY.

Oh, yes, perfectly.

MRS. B.

If you close the shutters, we shall admit a ray of the sun's light through a very small aperture, and I can show you how it is reflected. I now hold this mirror, so that the ray shall fall perpendicularly upon it.

CAROLINE.

I see the ray which falls upon the mirror, but not that which is reflected by it.

MRS. B.

Because its reflection is directly retrograde. The ray of incidence and that of reflection, both being in the same line, though in opposite directions, are confounded together.

EMILY.

The ray, then, which appears to us single is really double, and is composed of the incident ray proceeding to the mirror, and of the reflected ray returning from the mirror.

MRS. B.

Exactly so. We shall now separate them, by holding the mirror, M (fig. 6.), in such a position that the incident ray, AB, shall fall obliquely upon it;—you see the reflected ray, BC, is going off in another direction. If we draw a line from the point of incidence, B, perpendicular to the mirror, it will divide the angle of incidence from the angle of reflection, and you will see that they are equal.

EMILY.

Exactly; and now that you hold the mirror so that the ray falls more obliquely on it, it is also reflected more obliquely, preserving the equality of the angles of incidence and reflection.

MRS. B.

It is by reflected rays only that we see opaque objects. Luminous bodies send rays of light im-



mediately to our eyes; but the rays which they send to other bodies are invisible to us, and are seen only when they are reflected or transmitted by those bodies to our eyes.

EMILY.

But have we not just seen the ray of light on its passage from the sun to the mirror, and its reflection? yet in neither case were those rays in a direction to enter our eyes.

MRS. B.

No. What you saw was the light reflected to your eyes by small particles of dust floating in the air, and on which the ray shone in its passage to and from the mirror.

CAROLINE.

Yet I see the sun shining on that house yonder as clearly as possible.

MRS. B.

Indeed you cannot see a single ray which passes from the sun to the house; you see no rays but those which enter your eyes; therefore it is the rays which are reflected by the house to you, and not those which proceed from the sun to the house, that are visible to you.

CAROLINE.

Why, then, does one side of the house appear to be in sunshine, and the other in shadow; for

if I cannot see the sunshine upon it, the whole of the house should appear in the shade?

MRS. B.

That side of the house on which the sun shines reflects more vivid and luminous rays than the side which is in shadow; for the latter is illumined only by rays reflected upon it by other objects: these rays are therefore twice reflected before they reach your sight; and as light is more or less absorbed by the bodies it strikes upon, every time a ray is reflected, its intensity is diminished.

CAROLINE.

Still I cannot reconcile myself to the idea, that we do not see the sun's rays shining on objects, but only those which objects reflect to us.

MRS. B.

I do not, however, despair of convincing you of it. Look at that large sheet of water; can you tell me why the sun appears to shine on one part of it only?

CAROLINE.

No, indeed; for the whole of it is equally exposed to its rays. This partial brilliancy of water has often excited my wonder; but it has struck me more particularly by moonlight. I have frequently observed a vivid streak of moonshine on

the sea, while the rest of the water remained in deep obscurity; and yet there was no apparent obstacle to prevent the moon from shining on every part of the water equally.

MRS. B.

By moonlight the effect is more remarkable, on account of the deep obscurity of the other parts of the water; while by the sun's light the effect is too strong for the eye to be able to contemplate it.

CAROLINE.

But if the sun really shines on every part of that sheet of water, why does not every part of it reflect rays to my eyes?

MRS. B.

The reflected rays are not attracted out of their natural course by your eyes. The direction of a reflected ray, you know, depends on that of the incident ray; the sun's rays, therefore, which fall with various degrees of obliquity upon the water, are reflected in directions equally various; some of these will meet your eyes, and you will see them, but those which fall elsewhere are invisible to you.

CAROLINE.

The streak of sunshine, then, which we now see upon the water, is composed of those rays which by their reflection happen to fall upon my eyes?

MRS. B.

Precisely.

EMILY.

But is that side of the house yonder, which appears to be in shadow, really illumined by the sun, and its rays reflected another way?

MRS. B.

No: that is a different case from the sheet of water. That side of the house is really in shadow; it is the west side, which the sun cannot shine upon till the afternoon.

EMILY.

Those objects, then, which are illumined by reflected rays, and those which receive direct rays from the sun, but which do not reflect those rays towards us, appear equally in shadow?

MRS. B.

Certainly; for we see them both illumined by reflected rays. That part of the sheet of water over which the trees cast a shadow, by what light do you see it?

EMILY.

Since it is not by the sun's direct rays, it must be by those reflected on it from other objects, and which it again reflects to us.

CAROLINE.

But if we see all terrestrial objects by reflected light (as we do the moon), why do they appear so bright and luminous? I should have supposed that reflected rays would have been dull and faint, like those of the moon.

MRS. B.

The moon reflects the sun's light with as much vividness as any terrestrial object. If you look at it on a clear night, it will appear as bright as a sheet of water, the walls of a house, or any object seen by daylight, and on which the sun shines. The rays of the moon are doubtless feeble, when compared with those of the sun; but that would not be a fair comparison, for the former are incident, the latter reflected rays.

CAROLINE.

True; and when we see terrestrial objects by moonlight, the light has been twice reflected, and is consequently proportionally fainter.

MRS. B.

In traversing the atmosphere, the rays, both of the sun and moon, lose some of their light. For though the pure air is a transparent medium, which transmits the rays of light freely, we have observed, that near the surface of the earth it is

loaded with vapours and exhalations, by which a considerable portion of the rays is absorbed.

CAROLINE.

I have often noticed, that an object on the summit of a hill appears more distinct than one at an equal distance, in a valley, or on a plain; which is owing, I suppose, to the air being more free from vapours in an elevated situation, and the reflected rays being consequently brighter.

MRS. B.

That may have some sensible effect; but when an object on the summit of a hill has a back-ground of light sky, the contrast with the objects makes its outline more distinct.

CAROLINE.

I now feel well satisfied, that we see opaque objects only by reflected rays; but I do not understand how these rays show us the objects from which they proceed.

MRS. B.

The rays of light enter at the pupil of the eye, and proceeding to the retina, or the part where the fibres of the optic nerve are spread out, at the back part of the eye-ball, there describe the figure, colour, and (excepting as to size) form a perfect representation of the object from which

they proceed. We shall again close the shutters, and admit the light through the small hole, and you will see a picture on the wall, opposite the aperture, similar to that which is delineated on the retina of the eye.

CAROLINE.

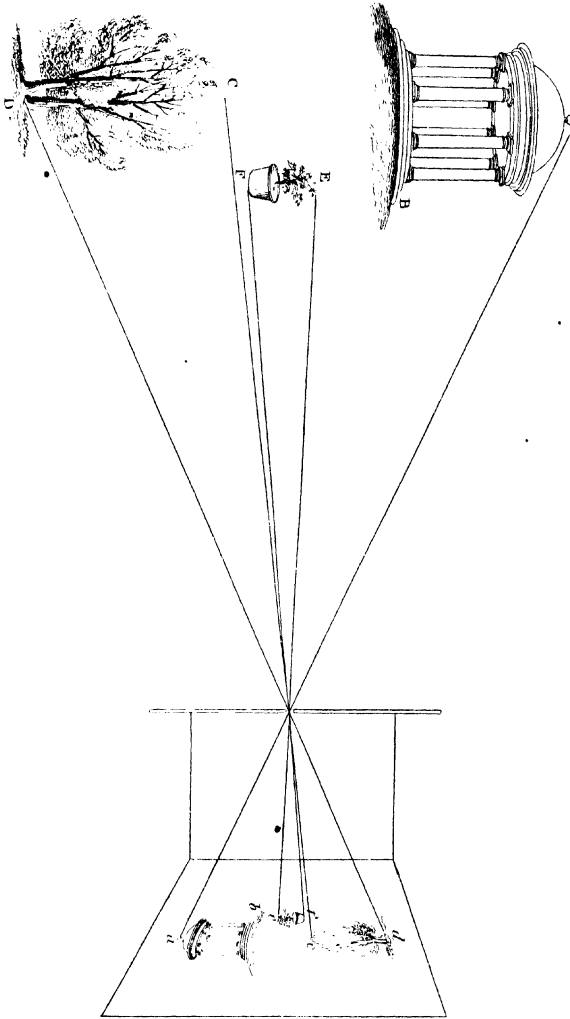
Oh, how wonderful! There is an exact picture in miniature of the garden, the gardener at work, the trees blown about by the wind. The landscape would be perfect if it were not reversed: the ground being above and the sky beneath.

MRS. B.

It is not enough to admire, you must understand this phenomenon, which is called a camera obscura, from the necessity of darkening the room, in order to exhibit it.

The picture is produced by the rays of light reflected from the various objects in the garden, and which are admitted through the hole in the window-shutter.

The rays from the glittering weathercock at the top of the alcove, A, (Plate XVI. fig. 1.) represent it in this spot *a*; for the weathercock being much higher than the aperture in the shutter, only a few of the rays, which are reflected by it in an obliquely descending direction, can find entrance there. The rays of light, you know, always move in straight lines; those, therefore, which enter the







room in a descending direction, will continue their course in the same direction, and will, consequently, fall upon the lower part of the wall opposite the aperture, and represent the weathercock inverted in that spot, instead of erect in the uppermost part of the landscape.

EMILY.

And the rays of light from the steps B, of the alcove, in entering the aperture, ascend, and will describe those steps in the highest, instead of the lowest part of the landscape.

MRS. B.

Observe, too, that the rays proceeding from the alcove, which is to our left, describe it on the wall to the right; while those which are reflected by the walnut-tree, CD, to our right, delineate its figure in the picture to the left, *cd*. Thus the rays, coming in different directions, and proceeding always in right lines, cross each other at their entrance through the aperture; those from above proceed below, those from the right go to the left, those from the left to the right; thus every object is represented in the picture as occupying a situation the very reverse of that which it does in nature; excepting the flower-pot, EF, which, though its position is inverted, has not changed its situation in the landscape; for, being immediately in front of the aperture, its rays fall

perpendicularly upon it, and, consequently, proceed perpendicularly to the wall, where they delineate the object.

EMILY.

And is it thus that the picture of objects is painted on the retina of the eye?

MRS. B.

Precisely. The pupil of the eye, through which the rays of light enter, represents the aperture in the window-shutter; and the image delineated on the retina is exactly similar to the picture on the wall, and it is thus that the presence of objects is perceived by the mind.

CAROLINE.

Or, in other words, it is thus that we see things?

MRS. B.

Yes; but in order to give you a more accurate notion of the sense of sight, I must tell you whence all our senses originate.

The nerves are the only part of our frame capable of imparting sensation: they appear, therefore, to be the instruments which the mind employs in its perceptions; for a sensation always excites an idea in the mind. Now it is known that our nerves can be affected only by contact; and for this reason the organs of sense cannot act at a

distance: for instance, we are capable of smelling only particles which are actually in contact with the nerves of the nose. We have already observed that the odour of a flower consists in effluvia, composed of very minute particles, which penetrate the nostrils, and strike upon the olfactory nerves, which instantly convey the idea of smell to the mind.

EMILY.

And sound, though it is said to be heard at a distance, is, in fact, heard only when the vibrations of the air, which convey it to our ears, strike upon the auditory nerve.

CAROLINE.

There is no explanation required, to prove that the senses of feeling and of tasting are excited only by contact.

MRS. B.

And I hope to convince you, that the sense of sight is so likewise. The nerves which constitute the sense of sight are not different in their nature from those of the other organs; they are merely instruments which suggest ideas to the mind, and can be affected only on contact. Now since real objects cannot be brought to touch the optic nerve, the image of them is conveyed thither by the rays of light proceeding from real objects, which actually strike upon that part of the optic nerve

which is purposely expanded to receive its impressions.

EMILY.

But is it possible, that the extensive landscape, which I now behold from the window, should be represented on so small a space as the retina of the eye?

MRS. B.

It would be impossible for art to paint so small and distinct a miniature : but nature works with a surer hand, and a more delicate pencil. That Power, which forms the feathers of the butterfly, and the flowerets of the daisy, can alone portray so admirable and perfect a miniature as that which is represented on the retina of the eye.

CAROLINE.

But how does this image convey ideas of objects to the mind?

MRS. B.

It gives rise to ideas in the mind, but it cannot convey them ; for the nerves do not think, they can therefore have no ideas to convey.

CAROLINE.

True ; the nerves are merely the organs of sensation, and it is the sensations they convey to the mind which excite corresponding ideas.

MRS. B.

I cannot even grant you that. The nerves are simply corporeal substances, as incapable of feeling as of thinking; and would, perhaps, be more accurately defined, were they called the organs which excite sensations in the mind; for it is not the eye that sees, but the mind; nor is it your hand which feels, but the mind. The mind both feels the sensation and conceives the corresponding ideas; and this combined power is called perception.

CAROLINE.

But if it is not the eye that sees, of what use is it?

MRS. B.

It is the instrument with which nature has furnished us, to excite the perception of external objects to the mind; and we can trace its effects from the entrance of the rays at the pupil, to the picture they describe on the retina; from thence, the optic nerve conveys some impression to the sensorium, which is immediately followed by sensation. The sensorium is that portion of the brain which seems to be most intimately connected with the mind; at that point our observation ceases, the link which connects the sensorium with the mind being utterly concealed from our observation. We must, therefore, rest satisfied

with knowing that it is through the organ of sight that we become conscious of the presence of objects; of their colour, form, and situation; though we are ignorant, and perhaps may ever remain ignorant, of the immediate means by which the mind acquires this knowledge. What you must endeavour to remember is, that the mind while inclosed in this corporeal frame has no other inlets of knowledge than the senses.

CAROLINE.

Yes; it cannot see without looking through that curious optical instrument, the eye; nor hear, without listening to the vibrations of the air on the ear.

EMILY.

I think, Mrs. B., that the mind, pent up in this opaque body of ours, might be compared to a prisoner confined in a dungeon, without means of knowing any thing of external objects, excepting through five *chinks* in the wall, by the help of which he may discern some of the objects that surround his prison.

CAROLINE.

And pray, when the mind is freed from this corporeal confinement, and we lose the organs of sense, how are we to obtain a knowledge of things?

MRS. B.

If the prisoner were released, by the walls of his dungeon crumbling into dust, would his perceptions, think you, be diminished by the destruction of the chinks in the wall?

When the mind is unconfined, and our means of acquiring knowledge not limited to the extent of the powers of the senses, we know not what bounds, or indeed whether any bounds, may be prescribed to its perceptions; whether we may not at once behold the countless worlds which fill the universe, and perceive with equal clearness that portion of nature which, from its minuteness, is now invisible. But you have led me deeper into the subject than I intended: we can form nothing more than conjecture on the degree of knowledge we may acquire in another state of existence; but we may rest satisfied that He who has provided so bountifully for us, in this sublunary world, will proportion his gifts to that eternity which, through his goodness, we hope hereafter to attain. Let us now return to the consideration of our present state of existence.

CAROLINE.

But, Mrs. B., if it is the image on the retina which gives rise to the corresponding sensation to the mind, it must give rise to false ideas, for it represents objects inverted.



MRS. B.

I rather believe it is you, Caroline, who have still a false idea of the connection of the image on the retina with the idea in the mind. It is very natural for you to think that the mind sees this image, just as we see that in the camera obscura, but this is not the case; we are even unconscious of its existence, and are conscious only of the ideas to which it gives rise; now these ideas do not represent to us inverted objects, or at least they have been so far corrected by observation and experience of the true position of objects, that they appear to us as they really are. We learn from experience that we always see an object in the direction of the rays which it sends to us.

EMILY.

I confess I do not understand that.

MRS. B.

It is, I think, a difficult point to explain clearly. A ray which comes from the upper part of an object, describes the image on the lower part of the retina; but experience having taught us, that the direction of that ray is from above, we consider that part of the object it represents as uppermost. The rays proceeding from the lower part of an object fall upon the upper part of the retina; but as we know their direction to be from below,

we see that part of the object they describe as the lowest.

•  
CAROLINE.

It is true that when I want to see an object above me, I look up; when an object below me, I look down.

MRS. B.

When you look up to an elevated object, it is in order that the rays reflected from it should fall upon the retina of your eyes: but the very circumstance of directing your eyes upwards convinces you that the object is elevated, and teaches you to consider as uppermost the image it forms on the retina, though it is, in fact, represented in the lowest part of it. When you look down upon an object, you draw your conclusion from similar reasoning. It is thus that we see all objects in the direction of the rays which reach our eyes.

## CONVERSATION XVI.

---

OPTICS—*continued.*

ON THE VISUAL ANGLE, AND THE REFLECTION  
OF MIRRORS.

ANGLE OF VISION.—REFLECTION OF PLAIN MIRRORS.  
—REFLECTION OF CONVEX MIRRORS.—REFLECTION  
OF CONCAVE MIRRORS.

---

CAROLINE.

WELL, Mrs. B., I am very impatient to hear more on the subject of vision; it appears to me more interesting than any thing we have yet learnt.

MRS. B.

Can you tell me, Caroline, why objects at a distance appear smaller than they really are?

CAROLINE.

I know no other reason than their distance.



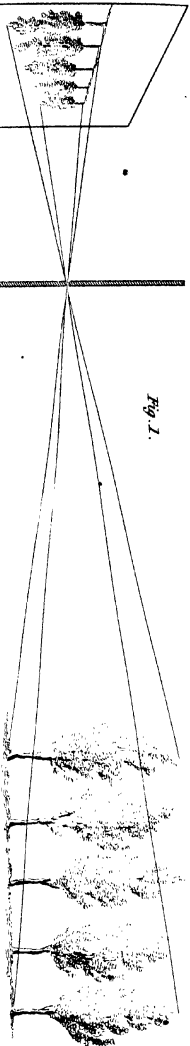


Fig. 1.

Fig. 3.

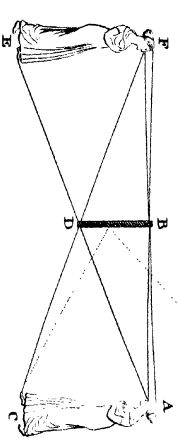


Fig. 4.

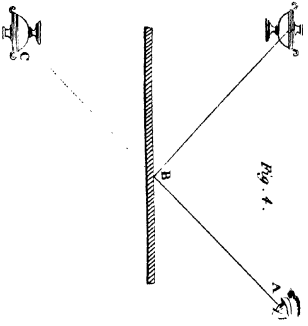
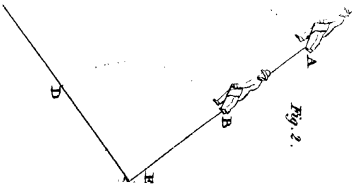


Fig. 2.



MRS. B.

I do not think I have much cause to be satisfied with your reason. We must refer again to the camera obscura to account for this circumstance; Fig. 1. Plate XVII. represents a row of trees as viewed in the camera obscura. I have shown the direction of the rays, from the objects to the image, by lines. Observe that the ray which comes from the top of the nearest tree, and that which comes from the foot of the same tree, meet at the aperture, forming an angle of about twenty-five degrees: this is called the visual angle, being that under which we see the tree. These rays cross each other at the aperture, forming equal angles on each side of it, and represent the tree inverted in the camera obscura. The size of the image is considerably smaller than that of the object, but the proportions are perfectly preserved.

Now let us notice the upper and lower ray, from the most distant tree; they form an angle of not more than twelve or fifteen degrees, and an image of proportional dimensions. Thus two objects of the same size, as the two trees of the avenue, form figures of different sizes in the camera obscura, according to their distance; or, in other words, according to the visual angle under which they are seen. Do you understand this?

CAROLINE.

Perfectly.

MRS. B.

Then you have only to suppose that the representation on the retina is similar to that in the camera obscura.

CAROLINE.

But does that chair at the further end of the room form an image on my retina much smaller than this which is close to me? they appear exactly of the same size.

MRS. B.

I assure you they do not. The experience we acquire by the sense of touch corrects the errors of our sight with regard to objects within our reach. You are so perfectly convinced of the real size of objects which you can handle, that you do not attend to their apparent difference.

Does that house opposite appear to you much smaller than when you are close to it?

CAROLINE.

No, because it is very near us.

MRS. B.

And yet you can see the whole of it through one of the windows of this room. The image of the house on your retina must, therefore, be smaller than that of the window through which you see it. It is your knowledge of the real size of the house which prevents your attending to its apparent

magnitude. If you were accustomed to draw from nature, you would be fully aware of this difference.

EMILY.

And pray, what is the reason that, when we look up an avenue, the trees not only appear smaller as they are more distant, but seem gradually to approach each other till they meet in a point?

MRS. B.

Not only the trees, but the road which separates the two rows, forms a smaller visual angle, in proportion as it is more distant from us; therefore the width of the road gradually diminishes as well as the size of the trees, till at length the road apparently terminates in a point, at which the trees seem to meet.

But this effect of the visual angle will be more fully illustrated by a little model of an avenue which I have made for that purpose. It consists of six trees leading to an hexagonal temple, and viewed by an eye, on the retina of which the picture of the object is delineated.

I beg that you will not criticise the proportions; for though the eye is represented the size of life, while the trees are not more than three inches high, the disproportion does not affect the principle which the model is intended to elucidate.



EMILY.

The threads which pass from the objects through the pupil of the eye to the retina, are, I suppose, intended to represent the rays of light which convey the image of the objects to the retina?

MRS. B.

Yes. I have been obliged to limit the rays to a very small number, in order to avoid confusion; there are, you see, only two from each tree.

CAROLINE.

But as one is from the top, and the other from the bottom of the tree, they exemplify the different angles under which we see objects at different distances, better than if there were more.

MRS. B.

Yes; and all the other rays which are not here represented, are included within this uppermost and undermost ray, which form the angle of vision.

There are seven rays proceeding from the temple, one from the summit, and two from each of the angles that are visible to the eye, as it is situated; from these you may form a just idea of the difference of the angle of vision of objects viewed obliquely, or in front; for though the six sides of the temple are of equal dimensions, that which is opposite to the eye is seen under a much larger

angle than those which are viewed obliquely. It is on this principle that the laws of perspective are founded.

EMILY.

I am glad to know that, for I have lately begun to learn perspective, which appeared to me a very dry study; but now that I am acquainted with its principles, I shall find it more interesting.

CAROLINE.

In drawing a view from nature, then, we do not copy objects as they really exist, but as we see them.

MRS. B.

Certainly. In sculpture, we copy nature as she really exists; in painting, we represent her as she appears to us. It was on this account that I found it difficult to explain by a drawing the effects of the visual angle, and was under the necessity of constructing a model for that purpose.

EMILY.

I hope you will allow us to keep this model some time, in order that I may study it more completely, for a great deal may be learned from it. It illustrates the nature of the visual angle, the apparent diminution of distant objects, and the inversion of the image on the retina. But pray,

why are the threads that represent the rays of light coloured the same as the objects from which they proceed?

MRS. B.

That is a question which you must excuse my answering at present, but I promise to explain it to you in due time.

I consent very willingly to your keeping the model, on condition that you will make an imitation of it, on the same principle, but representing different objects.

We must now conclude the observations that remain to be made on the visual angle.

If an object, with an ordinary degree of illumination, does not subtend an angle of more than one minute of a degree, it is invisible. There are, consequently, two cases in which objects may be invisible, either if they are too small, or so distant as to form an angle less than one minute of a degree.

In like manner, if the velocity of a body be so small, that the arc which it describes in an hour, does not subtend an angle of more than twenty degrees, its motion is imperceptible. The fixed stars, it is true, subtend much smaller angles, and yet are visible; but they are bodies luminous in themselves, and emit much more light than those which only reflect it.

CAROLINE.

A very rapid motion may then be imperceptible, provided the distance of the moving body be sufficiently great.

MRS. B.

Undoubtedly; for the greater its distance, the smaller will be the angle under which its motion will appear to the eye. It is for this reason that the motion of the celestial bodies is invisible notwithstanding their immense velocity; for the greatest *apparent* motion of any celestial body does not exceed 15 degrees in an hour, being that seemingly produced in a body by the revolution of the earth. The greatest of the real motions is that of the moon, and even that does not exceed about  $12\frac{1}{2}$  degrees in a day.

EMILY.

I am surprised that so great a velocity as 20 degrees an hour should be invisible.

MRS. B.

The real velocity depends altogether on the space comprehended in each degree; and this space depends on the distance of the object, and the obliquity of its path. Observe, likewise, that we cannot judge of the velocity of a body in motion unless we know its distance; for supposing two men to set off at the same moment from A and B (fig. 2.), to walk each to the end of their respective lines C

and D. If they perform their walk in the same space of time, they must have proceeded at a very different rate, and yet to an eye situated at E they will appear to have moved with equal velocity; because they will both have gone through an equal number of degrees, though over a very unequal length of ground. Sight is an extremely useful sense, no doubt, but it cannot be implicitly relied on: it deceives us both in regard to the size and the distance of objects; indeed, our senses would be very liable to lead us into error, if experience did not set us right.

EMILY.

Between the two, I think we contrive to acquire a tolerably accurate idea of objects.

MRS. B.

At least sufficiently so for the general purposes of life. To convince you how requisite experience is to correct the errors of sight, I shall relate to you the case of a young man who was blind from his infancy, and who recovered his sight at the age of fourteen, by the operation of couching. At first, he had no idea either of the size or distance of objects, but imagined that every thing he saw touched his eyes; and it was not till after having repeatedly felt them, and walked from one object to another, that he acquired an idea of their

respective dimensions, their relative situations, and their distances.

CAROLINE.

The idea that objects touched his eyes is, however not so absurd as it at first appears; for if we consider that we receive our notions of objects from the impression their image makes on the retina, this image does actually touch our eyes.

MRS. B.

This is doubtless the reason of the opinion he formed, before the sense of touch had corrected his judgment.

CAROLINE.

But since an image must be formed on the retina of each of our eyes, why do we not see objects double?

MRS. B.

The action of the rays on the optic nerve of each eye is so perfectly similar, that they produce but a single sensation: the mind, therefore, receives the same idea from the retina of both eyes, and conceives the object to be single.

CAROLINE.

This is difficult to comprehend, and, I should think, can be but conjectural.

MRS. B.

I can easily convince you that you have a distinct image of an object formed on the retina of each eye. Shut your left eye and look at the bell-rope: now tell me, do you see it to the right or the left of the pole of the fire-screen?

CAROLINE.

A little to the right of it.

MRS. B.

Now shut your right eye and open your left, and you will see it to the left of the pole.

CAROLINE.

That is true indeed.

MRS. B.

There are evidently two representations of the bell-rope in different situations, which must be owing to an image of it being formed on both eyes; if the action of the rays, therefore, on each retina were not so perfectly similar as to produce but one sensation, we should always see a double image, and we find that to be the case with many persons who are afflicted with a disease in one eye, which prevents the rays of light from affecting it in the same manner as the other.

This explanation, although perhaps the best

that can be offered, is, nevertheless, not a complete solution of the difficulty, that the mind should perceive but one object when the sight evidently sees two; it is therefore wiser to consider the fact as one established by experience, but which, in our present state of knowledge, does not admit of any satisfactory solution. I can only repeat that the manner in which external objects act upon the mind has not hitherto been capable of direct observation; without observation no theory can be deduced, and all therefore must be mere hypothetical speculation.

EMILY.

It may be wiser to doubt, but it is not half so satisfactory. You can however, perhaps, explain to us why the image of an object in a looking-glass is not inverted as in the camera obscura, and on the retina of the eye?

MRS. B.

Yes; it is because the rays do not enter the mirror by a small aperture, and cross each other, as they do at the orifice of a camera obscura, or at the pupil of the eye.

When you view yourself in a mirror, the rays from your eyes fall perpendicularly upon it, and are reflected in the same line; the image is, therefore, described behind the glass, and is situated in the same manner as the object before it.



EMILY.

Yes, I see that it is; but the looking-glass is not nearly so tall as I am; how is it, therefore, that I can see the whole of my figure in it?

MRS. B.

It is not necessary that the mirror should be more than half your height, in order that you may see the whole of your person in it (fig. 3.). The ray of light,  $AB$ , from your eye, which falls perpendicularly on the mirror,  $BD$ , will be reflected back in the same line; but the ray  $CD$ , from your feet, will fall obliquely on the mirror, for it must ascend in order to reach it: it will therefore be reflected in the line  $DA$ : and since we view objects in the direction of the reflected rays which reach the eye, and that the image appears at the same distance behind the mirror, as the object is before it, we must continue the line  $AD$  to  $E$ , and the line  $CD$  to  $F$ , at the termination of which the image will be represented.

EMILY.

Then I do not understand why I should not see the whole of my person in a much smaller mirror, for a ray of light from my feet would always reach it, though more obliquely.

MRS. B.

True; but the more obliquely the ray falls on the mirror, the more obliquely it will be reflected:

the ray would, therefore, be reflected above your head, and you could not see it. This is shown by the dotted line (fig. 3.).

Now stand a little to the right of the mirror, so that the rays of light from your figure may fall obliquely on it.

EMILY.

There is no image formed of me in the glass now.

MRS. B.

I beg your pardon, there is ; but you cannot see it, because the incident rays falling obliquely on the mirror will be reflected obliquely in the opposite direction, the angle of incidence and of reflection being equal. Caroline, place yourself in the direction of the reflected rays, and tell me whether you do not see Emily's image in the glass.

CAROLINE.

Let me consider.—In order to look in the direction of the reflected rays, I must place myself as much to the left of the glass as Emily stands to the right of it.—Now I see her image, but it is not straight before me, but before her ; and appears at the same distance behind the glass as she is in front of it.

MRS. B.

You must recollect, that we always see objects in the direction of the last rays which reach our

eyes. Figure 4. represents an eye looking at the image of a vase, reflected by a mirror: it must see it in the direction of the ray A B, as that is the ray which brings the image to the eye; prolong the ray to C, and in that spot the image will appear.

CAROLINE.

I do not understand why a looking-glass reflects the rays of light; for glass is a transparent body, which should transmit them.

MRS. B.

We have already observed that transparent bodies reflect some portion of the rays which fall upon them, but the greatest reflection is from the mercury behind the glass. In glass mirrors there are, therefore, two reflections, one from the surface of the glass, the other from the mercury.

CAROLINE.

But if mercury reflects the most rays, why should not mirrors be made of mercury only?

MRS. B.

Because mercury is a fluid. By amalgamating it with tin-foil, it becomes of the consistence of paste, attaches itself to the glass, and forms in fact a mercurial mirror, which would be much more perfect without its glass cover, for the purest glass

is never completely transparent; some of the rays, therefore, are lost during their passage through it, by being either absorbed or irregularly reflected.

This imperfection of glass mirrors has introduced the use of metallic mirrors for optical purposes.

EMILY.

But since all opaque bodies reflect the rays of light, I do not understand why they are not all mirrors.

CAROLINE.

A curious idea indeed, sister; it would be very gratifying to see one's self in every object at which one looked.

MRS. B.

It is very true, that all opaque objects reflect light; but the surface of bodies in general is so rough and uneven, that their reflection is extremely irregular, which prevents the rays from forming an image on the retina. This you will be able to understand better, when I shall explain to you the nature of vision, and the structure of the eye.

You may easily conceive the variety of directions in which rays would be reflected by a nutmeg-grater, on account of the inequality of its surface, and the number of holes with which it is pierced. All solid bodies resemble the nutmeg-grater in these respects, more or less; and it is only those which are susceptible of receiving a polish that can

be made to reflect the rays with regularity. As hard bodies are of the closest texture, the least porous, and capable of taking the highest polish, they make the best mirrors; none, therefore, are so well calculated for this purpose as metals.

CAROLINE.

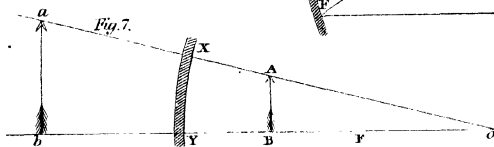
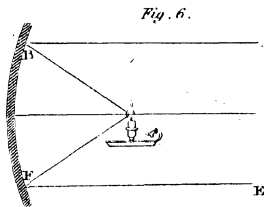
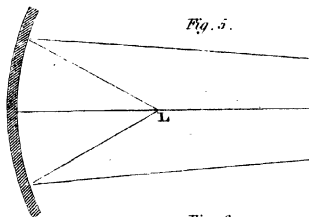
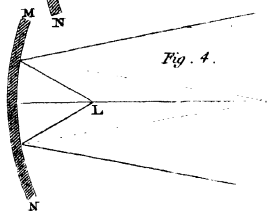
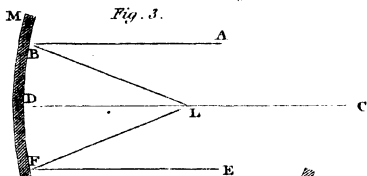
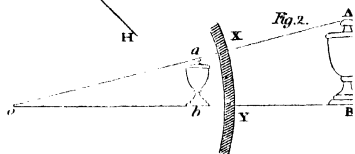
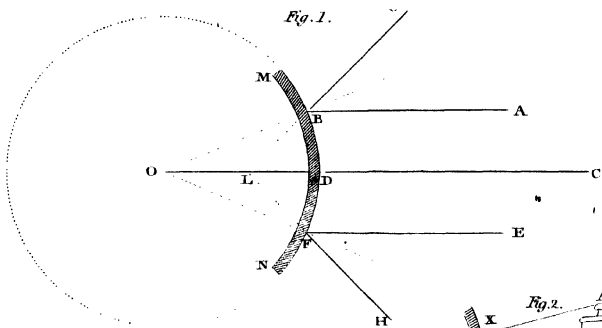
But the property of regular reflection is not confined to this class of bodies: for I have often seen myself in a highly polished mahogany table.

MRS. B.

Certainly; but as that substance is less durable and its reflection less perfect than that of metals, I believe it would seldom be chosen for the purpose of a mirror.

There are three kinds of mirrors used in optics; the plane or flat, which are the common mirrors we have just mentioned; convex mirrors; and concave mirrors. The reflection of the two latter is very different from that of the former. The plane mirror, we have seen, does not alter the direction of the reflected rays, and forms an image behind the glass, exactly similar to the object before it. A convex mirror has the peculiar property of making the reflected rays diverge, by which means it diminishes the image; and a concave mirror makes the rays converge, and, under certain circumstances, magnifies the image.





EMILY.

We have a convex mirror in the drawing-room which forms a beautiful miniature picture of the objects in the room; and I have often amused myself with looking at my face magnified in a concave mirror. But I hope you will explain to us why the one enlarges, while the other diminishes the objects it reflects.

MRS. B.

Let us begin by examining the reflection of a convex mirror. This is formed of a portion of the exterior surface of a sphere. When several parallel rays fall upon it, that ray only, which, if prolonged, would pass through the centre or axis of the mirror, is perpendicular to it. In order to avoid confusion, I have in fig. 1. Plate XVIII., drawn only three parallel lines, AB, CD, EF, to represent rays falling on the convex mirror, MN; the middle ray, you will observe, is perpendicular to the mirror, the others fall on it obliquely.

CAROLINE.

As the three rays are parallel, why are they not all perpendicular to the mirror?

MRS. B.

They would be so to a flat mirror: but as this is spherical no ray can fall perpendicularly upon



it which is not directed towards the centre of the sphere.

EMILY.

Just as a weight falls perpendicularly to the earth when gravity attracts it towards the centre.

MRS. B.

In order, therefore, that rays may fall perpendicularly to the mirror at B and F, the rays must be in the direction of the dotted lines, which, you may observe, meet at the centre O of the sphere, of which the mirror forms a portion.

Now can you tell me in what direction the three rays, A B, C D, E F, will be reflected?

EMILY.

Yes, I think so. The middle ray, falling perpendicularly on the mirror, will be reflected in the same line; the two others falling obliquely, will be reflected obliquely to G and H; for the dotted lines you have drawn are perpendiculars, which divide their angles of incidence and reflection.

MRS. B.

Extremely well, Emily; and since we see objects in the direction of the reflected ray, we shall see the image at L, which is the point at which the reflected rays, if continued through the mirror, would unite and form an image. This point is

equally distant from the surface and centre of the sphere, and is called the imaginary focus of the mirror.

CAROLINE.

Pray what is the meaning of focus ?

MRS. B.

A point at which converging rays unite. In this case it is called an imaginary focus ; because the rays only appear to unite at that point, or rather proceed, after reflection in the same direction as if they came from behind the mirror, from that point: for the rays do not pass through the mirror, since they are reflected by it.

EMILY.

I do not yet understand why an object appears smaller when viewed in a convex mirror.

MRS. B.

It is because the space from which the rays after reflection appear to proceed, is less than that occupied by the body itself. If the rays diverge before they fall on the mirror, they will diverge more after reflection ; but in this case also they will diverge as if they proceeded from a point within the mirror, which is the focus of those rays. The rays, therefore, which really proceed from a point in front of the mirror, will appear to proceed from a point within it, at which they would unite

and form an image. This point within the mirror, like the imaginary focus of parallel rays, is always a point in the line joining the centre of the sphere, and the point without the mirror from which the rays really proceed.

EMILY.

And if, instead of a single luminous point, a body of some magnitude were placed before the mirror, the rays of light, which proceed from each point of it, will no doubt be reflected exactly in the same manner as if that was a single luminous point: and an image, therefore, of that point will be formed, as before, in the line joining that point to the centre of the sphere.

MRS. B.

Exactly so. An image of each point in the object being thus formed, then also an image of the whole object will be formed, by the collection of these images of its different parts.

EMILY.

But this does not explain why the object appears smaller?

MRS. B.

A little patience and you will soon understand this. For if  $AB$  (fig. 2.) be an object (a vase, for instance) placed before the convex mirror,  $XY$ , and lines be drawn from its extreme points,

A, B, to O, the centre of the sphere, of which the mirror forms part, the image of the point A will be at  $a$ , a point in the line A O; that of B at  $b$ , a point in the line B O; and of course the image of every intermediate point of the vase somewhere between  $a$  and  $b$ . In other words, the rays which really proceed from A, are seen after reflection as if proceeding from  $a$ ; those from B as if from  $b$ ; and all others as if from some point between them. The lines A O, B O, converge to a point at O, and the points  $a$ ,  $b$ , which are nearer to O than A, B are, must necessarily be nearer together than A, B. Thus you perceive that the space from which the rays after reflection appear to proceed is less than that occupied by the body itself; in other words, the image of the vase is smaller than the vase itself.

You will now easily understand the nature of the reflection of concave mirrors. These are formed of a portion of the internal surface of a hollow sphere, and their peculiar property is to converge the rays of light.

Can you discover, Caroline, in what direction the three parallel rays, A B, C D, E F, which fall on the concave mirror M N (fig. 3.), are reflected?

CAROLINE.

I believe I can. The middle ray is sent back in the same line, as it is in the direction of the axis

of the mirror; and the two others will be reflected obliquely, as they fall obliquely on the mirror. I must now draw two dotted perpendiculars to their points of incidence, which will divide their angles of incidence and reflection; and in order that these angles may be equal, the two oblique rays must be reflected to L, where they will unite with the middle rays.

MRS. B.

Very well explained. Thus you see, that when any number of parallel rays fall on a concave mirror they are all reflected to a focus: for in proportion as the rays are more distant from the axis of the mirror, they fall more obliquely upon it, and are more obliquely reflected; in consequence of which they come to a focus in the direction of the axis of the mirror at a point equally distant from the centre and the surface of the sphere, and this point is not an imaginary focus, as happens with the convex mirror, but is the true focus at which the rays unite.

EMILY.

Can a mirror form more than one focus by reflecting rays?

MRS. B.

Yes. If rays fall convergent on a concave mirror (fig. 4.), they are sooner brought to a focus, L, than parallel rays; their focus is therefore nearer

to the mirror MN. Divergent rays are brought to a more distant focus than parallel rays, as in fig. 5., where the focus is at L; but the true focus of mirrors, either convex or concave, is that formed by parallel rays, which is equally distant from the centre and the surface of the sphere, as in fig. 1. and fig. 3.

I shall now show you the reflection of real rays of light, by a metallic concave mirror. This is one made of polished tin, which I expose to the sun; and as it shines bright, we shall be able to collect the rays into a very brilliant focus. I hold a piece of paper where I imagine the focus to be situated; you may see by the vivid spot of light on the paper how much the rays converge, but it is not yet exactly in the focus: as I approach the paper to that point, observe how the brightness of the spot of light increases, whilst its size diminishes.

CAROLINE.

That must be occasioned by the rays coming closer together. I think you hold the paper just in the focus now, the light is so small and dazzling:—Oh, Mrs. B., the paper has taken fire!

MRS. B.

The rays of light from the sun\* cannot be con-

\* The rays of light proceeding from the moon, however much concentrated by lenses or concave mirrors, have never

centrated without, at the same time, accumulating a proportional quantity of heat: hence concave mirrors have obtained the name of burning mirrors.

EMILY.

I have often heard of the surprising effects of burning mirrors, and I am quite delighted to understand their nature.

CAROLINE.

It cannot be the true focus of the mirror at which the rays of the sun unite; for, as they proceed from a point, they must fall divergent upon the mirror.

MRS. B.

Strictly speaking, they certainly do. But when rays come from such an immense distance as the sun, their divergence is so trifling as to be imperceptible: and they may be considered as parallel; their point of union is, therefore, the true focus of

been found to give any sensible heat. But this is not surprising, when we consider their great feebleness in comparison with the direct rays of the sun. Bouguer, by comparing each with the light of a candle in a dark room, came to the conclusion that the rays of the sun were about 300,000 times more intense than those of the moon. Hence, supposing the latter to be concentrated 1000 times, which is the utmost that can be effected, they would still be 300 times weaker than the direct solar rays; and any effect of heat could scarcely be rendered sensible.

the mirror, and there the image of the object is represented.

Now that I have removed the mirror out of the influence of the sun's rays, if I place a burning taper in the focus, how will its light be reflected? (Fig. 6.)

CAROLINE.

That, I confess, I cannot say.

MRS. B.

The ray which falls in the direction of the axis of the mirror is reflected back in the same line; but let us draw two other rays from the focus, falling on the mirror at B and F; the dotted lines are perpendicular to those points, and the two rays will therefore be reflected to A and E.

CAROLINE.

Oh, now I understand it clearly. The rays which proceed from a light placed in the focus of a concave mirror fall divergent upon it, and will be reflected parallel. It is exactly the reverse of the former experiment, in which the sun's rays fell parallel on the mirror, and were reflected to a focus.

MRS. B.

Yes. When the incident rays are parallel, the reflected rays converge to a focus; when on the contrary, the incident rays proceed from the focus,



they are reflected parallel. This is an important law of optics; and since you are now acquainted with the principles on which it is founded, I hope that you will not forget it.

CAROLINE.

I am sure that we shall not. But, Mrs. B., you said that the image was formed in the focus of a concave mirror; yet I have frequently seen glass concave mirrors, where the object has been represented within the mirror, in the same manner as in a convex mirror.

MRS. B.

That is the case only when the object is placed between the mirror and its focus; the image then appears magnified behind, or, as you call it, within the mirror.

CAROLINE.

I do not understand why the image should be larger than the object.

MRS. B.

Since rays proceeding from the focus are reflected parallel to each other, rays proceeding from a point still nearer the mirror, and therefore diverging more rapidly before reflection, will continue to diverge after reflection, although less than previously to it. They will therefore proceed after reflection as if they diverged from some point

behind the mirror ; and, as in the case of a convex mirror, this point will be in the line joining the centre of the mirror, and the point from which the rays originally proceed ; in other words, there will be an image there. The situation of the centre of the mirror being in this case before the mirror, and the image behind it, the image will be situated in this line produced, or prolonged through the mirror.

EMILY.

Exactly in the same manner as in the case of the convex mirror ; the image of the whole object will be made up of the images of the several points which constitute it.

MRS. B.

Yes. Now, if (fig. 7.)  $XY$  represent a concave mirror ;  $O$  the centre of the sphere of which it is part ;  $F$  its focus ; and  $AB$  an object placed between the focus and the mirror ; rays proceeding from  $A$  will, after reflection, proceed as if diverging from a point,  $a$ , in the line  $OA$  produced ; that is, there will be an image of  $A$  at  $a$ . In the same manner there will be an image of  $B$  at  $b$  ; and of the whole body  $AB$  between  $a$  and  $b$ . The lines  $OA$ ,  $OB$ ,  $aa'$ ,  $bb'$ , diverge from the point  $O$ , and the corresponding points in them are therefore farther from each other in proportion as they

are farther from O. The image  $a b$ , therefore, being more distant than the object A B from O, is larger than the object.

You now, I hope, understand the reflection of light by opaque bodies. At our next meeting, we shall enter upon another property of light, no less interesting, which is called *Refraction*.

## CONVERSATION XVII.

OPTICS—*continued.*

## ON REFRACTION AND COLOURS.

TRANSMISSION OF LIGHT BY TRANSPARENT BODIES.—  
 REFRACTION.—REFRACTION OF THE ATMOSPHERE.—  
 REFRACTION OF A LENS.—REFRACTION OF THE  
 PRISM.—OF THE COLOURS OF RAYS OF LIGHT.—  
 OF THE COLOURS OF BODIES.

MRS. B.

THE refraction of light will furnish the subject of to-day's lesson.

CAROLINE.

That is a property of light of which I have not the faintest idea.

MRS. B.

It is the effect which transparent mediums produce on light in its passage through them. Opaque bodies, you know, reflect the rays, and transparent bodies transmit them; but it is found, that if a ray,

in passing from one medium into another of different density, fall obliquely, it is turned out of its course.

CAROLINE.

It must then be acted on by some new power, otherwise it would not deviate from its first direction.

MRS. B.

The power which causes the deviation of the ray is not fully understood, nor completely ascertained; but the appearances are the same as if the ray were attracted by the denser medium more strongly than by the rarer. In explaining refraction, I shall follow this hypothesis, though it is less applicable to light when considered as resulting from the undulations of a subtle fluid, than when it is supposed to consist of corpuscular atoms, which would be naturally subject to the laws of attraction.

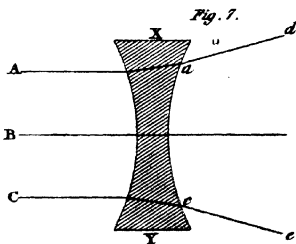
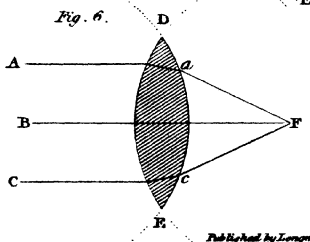
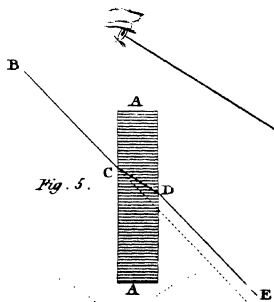
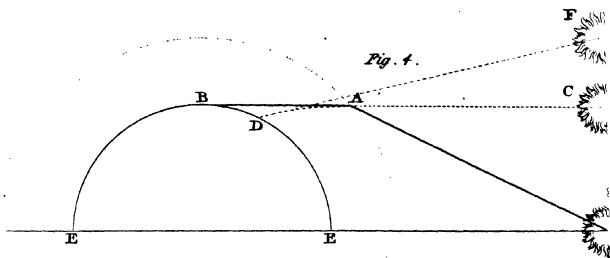
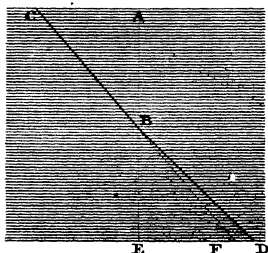
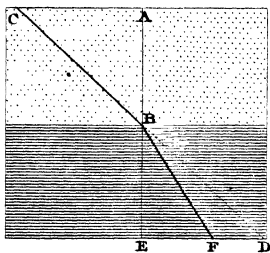
EMILY.

But, Mrs. B., this subtle ether must be of a corporeal nature; may it not, therefore, occasion the refraction of light?

MRS. B.

Undoubtedly; and refraction may be perfectly well explained on that theory: though the explanation is more complicated. At all events, we may consider the phenomena of refraction as if pro-





duced by attraction. Let us suppose two mediums to be air and water: if a ray of light pass from air into water, it is more strongly attracted by the latter.

EMILY.

In what direction does the water attract the ray?

MRS. B.

Perpendicularly towards it, in the same manner as gravity acts on bodies.

If then a ray, *A B* (fig. 1. Plate XIX.), fall perpendicularly on water, the attraction of the water acts in the same direction as the course of the ray; it will not, therefore, cause a deviation, and the ray will proceed straight on to *E*. But if it fall obliquely, as the ray *C B*, the water will attract it out of its course. Let us suppose the ray to have reached the surface of a denser medium, and that it is there affected by its attraction; if not counteracted by some other power, this attraction would draw it perpendicularly to the water, at *B*, towards *E*; but it is also impelled by its projectile force, which the attraction of the denser medium cannot overcome; the ray, therefore, acted on by both these powers, moves in a direction between them, and, instead of pursuing its original course to *D*, or being implicitly guided by the water to *E*, proceeds towards *F*, so that the ray appears bent or broken.



CAROLINE.

I understand that very well: and is not this the reason that oars appear bent in water? <sup>e</sup>

MRS. B.

It is owing to the refraction of the rays reflected by the oar: but this is in passing from a dense to a rare medium; for you know that the rays, by means of which you see the oar, pass from water into air.

EMILY.

But I do not understand why refraction takes place when a ray passes from a dense into a rare medium: I should suppose that it would be rather less than more attracted by the latter.

MRS. B.

And it is precisely on that account that the ray is refracted. C B, fig. 2., represents a ray passing obliquely from glass into water; glass being the denser medium, the ray will be more strongly attracted by that which it leaves, than by that which it enters. The attraction of the glass acts in the direction A B, while the impulse of projection would carry the ray to F; it moves, therefore, between these directions towards D.

EMILY.

So that a contrary refraction takes place when a ray passes from a dense into a rare medium.

CAROLINE.

But does not the attraction of the denser medium affect the ray before it touches it?

MRS. B.

The distance at which the attraction of the denser medium acts upon a ray is so small as to be insensible; it appears, therefore, to be refracted only at the point at which it passes from one medium to the other.

Now that you understand the principle of refraction, I will show you the refraction of a real ray of light. Do you see the flower painted at the bottom of the inside of this tea-cup? (Fig. 3.)

EMILY.

Yes.—But now you have moved it just out of sight, the rim of the cup hides it.

MRS. B.

Do not stir. I will fill the cup with water, and you will see the flower again.

EMILY.

I do indeed; let me try to explain this. When you drew the cup from me so as to conceal the flower, the rays reflected by it no longer met my eyes, but were directed above them; but now that you have filled the cup with water, they are re-

fracted by the attraction of the water, and bent downwards, so as again to enter my eyes.

MRS. B.

You have explained it perfectly. Fig.3. will help to imprint it on your memory. You must observe that when the flower becomes visible by the refraction of the ray, you do not see it in the situation which it really occupies, but you see its image higher in the cup; for as objects always appear to be situated in the direction of the rays which enter the eye, the flower will be seen in the direction of the refracted ray at B.

Observe that, in this instance, the image on the retina is not produced by the painted flower itself, but by an image of it formed by the refraction of the rays in passing from water into air.

EMILY.

Then, when we see the bottom of a clear stream of water, the rays which it reflects, being refracted in their passage from the water into the air, will make the bottom appear higher than it really is.

MRS. B.

And the water will consequently appear more shallow. Accidents have frequently been occasioned by this circumstance; and boys who are in the habit of bathing should be cautioned not to

trust to the apparent shallowness of water, as it will always prove deeper than it appears; unless, indeed, they view it from a boat on the water, which will enable them to look perpendicularly upon it; when, the rays from the bottom passing perpendicularly, no refraction will take place.

The refraction of light prevents our seeing the heavenly bodies in their real situation. The light they send to us being refracted in passing into the atmosphere, we see the sun and stars in the direction of the refracted ray; as described in fig. 4. Plate XIX., where the dotted line represents the extent of the atmosphere above a portion of the earth, EBE. In order to render the case more simple, we will suppose the atmosphere to be throughout of an equal density. Then a ray of light coming from the sun S falls obliquely on it at A, and is refracted to B; then, since we see the object in the direction of the refracted ray, a spectator at B will see an image of the sun at C, instead of the real object at S. 197

#### CAROLINE.

Now I think, Mrs. B., I can make out the case as it really exists.

The atmosphere not being throughout of an equal density, but more rare in the upper regions, and gradually augmenting in density as it approaches the earth, the attraction must increase in

a similar proportion ; therefore a ray of light, instead of moving in a straight line, would move in a curved line.

MRS. B.

You are quite right ; this curve is described in the dotted line, which reaches the earth at D (fig. 4. Plate XIX.), and from that spot we should see the sun at F.

EMILY.

But if the sun were immediately over our heads, its rays, falling perpendicularly on the atmosphere, would not be refracted, and we should then see the real sun in its true situation.

MRS. B.

You must recollect that the sun is vertical only to the inhabitants of the torrid zone ; its rays, therefore, are always refracted in our climates. There is also another obstacle to our seeing the heavenly bodies in their real situations. Light, though it moves with extreme velocity, is about eight minutes in its passage from the sun to the earth ; therefore, when the rays reach us, the sun must have quitted the spot he occupied on their departure ; yet we see him in the direction of those rays, and consequently in a situation which he had abandoned eight minutes before.

EMILY.

When you speak of the sun's motion, you mean, I suppose, his apparent motion, produced by the diurnal motion of the earth?

MRS. B.

No doubt; the effect being the same, whether it be our earth or the heavenly bodies which move: it is more easy to represent things as they appear to be, than as they really are.

CAROLINE.

During the morning, then, when the sun is rising towards the meridian, we must (from the length of time the light is in reaching us) see an image of the sun below that spot which it really occupies.

EMILY.

But the refraction of the atmosphere counter-acting this effect, we may, perhaps, between the two, see the sun in its real situation.

CAROLINE.

And, in the afternoon, when the sun is sinking in the west, refraction and the length of time which the light is in reaching the earth will conspire to render the image of the sun higher than it really is.

MRS. B.

The refraction of the sun's rays by the atmosphere prolongs our days, as it occasions our seeing

an image of the sun, both before he rises and after he sets; for below the horizon, he still shines upon the atmosphere, and his rays are thence refracted to the earth. So likewise we see an image of the sun before he rises, the rays that previously fall upon the atmosphere being reflected to the earth.

CAROLINE.

On the other hand, we must recollect that light is eight minutes on its journey; so that, by the time it reaches the earth, the sun may, perhaps, be risen above the horizon.

EMILY.

Pray, do not glass windows refract the light?

MRS. B.

They do; but this refraction is not perceptible, because, in passing through a pane of glass, the rays suffer two refractions, which being in contrary directions produce nearly the same effect as if no refraction had taken place.

EMILY.

I do not understand that.

MRS. B.

Fig. 5. Plate XIX. will make it clear to you: A A represents a thick pane of glass seen edge-wise. When the ray B approaches the glass at C,

it is refracted by it; and, instead of continuing its course in the same direction, as the dotted line describes, it passes through the pane to D; at that point, returning into the air, it is again refracted by the glass, but in a contrary direction to the first refraction, and in consequence proceeds to E. Now you must observe, that the ray B C and the ray D E being parallel, the light does not appear to have suffered any refraction.

EMILY.

So that the effect which takes place on the ray entering the glass is undone on its quitting it. Or, to express myself more scientifically, when a ray of light passes from one medium into another, and through that into the first again, the two refractions being equal and in opposite directions, no sensible effect is produced.

MRS. B.

This is the case when the two surfaces of the refracting medium are parallel to each other; if they are not, the two refractions may be made in the same direction, as I shall show you.

When parallel rays (fig. 6.) fall on a piece of glass having a double convex surface, and which is called a *Lens*, that only which falls in the direction of the axis of the lens is perpendicular to the surface; the other rays falling obliquely are



refracted towards the axis, and will meet at a point beyond the lens, called its focus.

Of the three rays, A, B, C, which fall on the lens DE, the rays A and C are refracted in their passage through it, to *a* and *c*, and on quitting the lens they undergo a second refraction in the same direction, which unites them with the ray B, at the focus F.

EMILY.

And what is the distance of the focus from the surface of the lens?

MRS. B.

The focal distance depends both upon the form of the lens, and upon the refractive power of the substance of which it is made; in a glass lens, both sides of which are equally convex, the focus is situated nearly at the centre of the sphere of which the surface of the lens forms a portion; it is at the distance, therefore, of the radius of the sphere.

There are lenses of various forms, as you will find described in fig. 1. Plate XX. The property of those which have a convex surface is to collect the rays of light to a focus; and of those which have a concave surface, on the contrary, to disperse them. For the rays A, C, falling on the concave lens XY, (fig. 7. Plate XIX.) instead of converging towards the ray B, which falls on the axis of the lens, will each be attracted towards



Fig. 1.

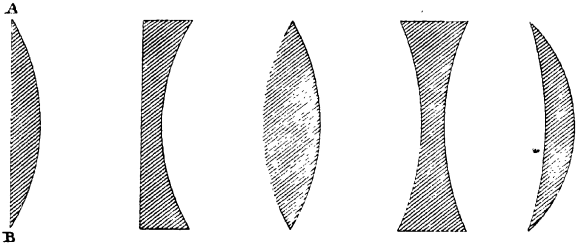


Fig. 2.

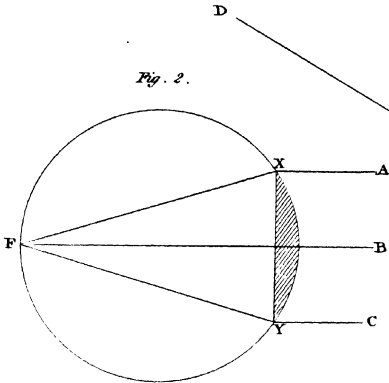


Fig. 3.

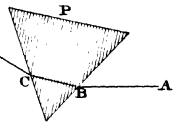


Fig. 4.

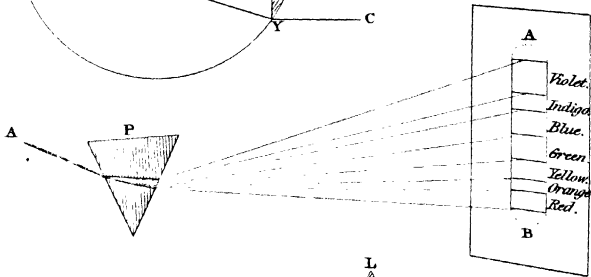
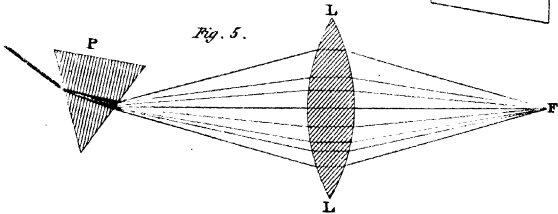


Fig. 5.



the thick edges of the lens, both on entering and quitting it, and will, therefore, by the first refraction, be made to diverge to *a, c*, and by the second to *d, e*.

CAROLINE.

And lenses which have one side flat and the other convex or concave, as *A* and *B*, fig. 1. Plate XX., are, I suppose, less powerful in their refractions?

MRS. B.

Yes; they are called plano-convex, and plano-concave lenses. The focus of the former is at the distance of the diameter of a sphere, of which the convex surface of the lens forms a portion; as represented in fig. 2. Plate XX. The three parallel rays, *A, B, C*, are brought to a focus by the plano-convex lens *X Y* at *F*.

I must now explain to you the refraction of a triangular piece of glass, called a prism. (Fig. 3.)

EMILY.

The three sides of this glass are flat; it cannot, therefore, bring the rays to a focus; nor do I suppose that its refraction will be similar to that of a flat pane of glass, because it has not two sides parallel. I cannot, therefore, conjecture what effect the refraction of a prism can produce.

MRS. B.

The refractions of the light, on entering and on quitting the prism, are both in the same direction. (Fig. 3.) On entering the prism P the ray is refracted from B to C, and on quitting it from C to D.

I shall show you this in nature; but for this purpose it will be advisable to close the window-shutters, and admit, through the small aperture, a ray of light, which I shall refract by means of this prism.

CAROLINE.

Oh, what beautiful colours are represented on the opposite wall! There are all the colours of the rainbow, and their brightness I never saw equalled. (Fig. 4. Plate XX.)

EMILY.

I have seen an effect, in some respects similar to this, produced by the rays of the sun shining upon glass lustres; but how is it possible that a piece of white glass can produce such a variety of brilliant colours?

MRS. B.

The colours are not formed by the prism, but existed in the ray previous to its refraction.

CAROLINE.

Yet, before its refraction, it appeared perfectly white.

MRS. B.

The white rays of the sun are composed of coloured rays, which, when blended together, appear colourless or white.

Sir Isaac Newton, to whom we are indebted for the most important discoveries respecting light and colours, was the first who divided a white ray of light, and found it to consist of an assemblage of coloured rays, which formed an image upon the wall, such as you now see exhibited (fig. 4.), in which are displayed the following series of colours: red, orange, yellow, green, blue, indigo, and violet. The spreading or separating these colours is called the dispersion of light; the image they form is called a spectrum; and the colours, the prismatic colours, owing to their being separated by a prism.

EMILY.

But how does a prism separate these coloured rays?

MRS. B.

By refraction. It appears that the coloured rays have different degrees of refrangibility; in passing through the prism, therefore, they take different directions, according to their susceptibility of refraction. The violet rays deviate most from their original course; they appear at one of the ends of the spectrum AB. Contiguous to the violet are the blue rays, being those which

have somewhat less refrangibility ; then follow, in succession, the green, yellow, orange, and, lastly, the red, which are the least refrangible of 'the coloured rays.

In passing through a prism, we have observed that the rays are twice refracted ; first, on entering into it, and, secondly, on coming out of it. The blue rays are of such a nature as to be more refracted than the red rays ; so that, after they enter the prism, they are more bent from their original course, and slightly diverge from the red rays. This separation and divergence is still farther increased when they pass out of the prism, when the second refraction takes place. This happens because the two surfaces of the prism are inclined to one another at an angle : for if they had to pass through two surfaces which were parallel to one another, as in a pane of glass, the rays would, on coming out, be bent back the contrary way to what they were on entering the glass ; the differently coloured rays would be again united as they were at first, and no spectrum would be formed.

When light is reflected, no separation of the coloured rays takes place, because the laws of reflection apply to each of them alike.

CAROLINE.

I cannot conceive how these colours, mixed together, can become white?

MRS. B.

That I am unable to explain: but it is a fact that the union of these colours, in the proportions in which they appear in the spectrum, produce in us the idea of whiteness. If you paint a card in compartments with these seven colours, in the same proportions as they exist in the spectrum, and whirl it rapidly on a pin, it will appear white.

But a more decisive proof of the composition of a white ray is afforded by re-uniting these coloured rays, and forming with them a ray of white light.

CAROLINE.

If you can take a ray of white light to pieces, and put it together again, I shall be quite satisfied.

MRS. B.

This can be done by letting the coloured rays, which have been separated by a prism, fall upon a lens, which will converge them to a focus; and if, when thus re-united, we find that they appear white as they did before refraction, I hope you will be convinced that the white rays are a compound of the several coloured rays. The prism P, you see (fig. 5.), separates a ray of white light into seven coloured rays, and the lens LL brings them to a focus at F, where they again appear white.



CAROLINE.

You succeed to perfection: this is, indeed, a most interesting and conclusive experiment. °

EMILY.

Yet, Mrs. B., I cannot help thinking that there may perhaps be but three distinct colours in the spectrum, red, yellow, and blue; and that the four others may consist of two of these colours blended together: for, in painting, we find, that by mixing red and yellow we produce orange; with different proportions of red and blue, we make violet or any shade of purple; and yellow and blue form green. Now it is very natural to suppose, that the refraction of a prism may not be so perfect as to separate the coloured rays of light completely, and that those which are contiguous in order of refrangibility may encroach on each other, and by mixing, produce the intermediate colours, orange, green, violet, and indigo.

MRS. B.

Your observation is, I believe, neither quite wrong nor quite right. The latest discoveries of Sir David Brewster on this subject tend to show that the different colours seen in the spectrum are produced by only three simple or elementary colours, variously combined together. These colours are, as you rightly supposed, red, yellow, and blue,

which are spread over the whole extent of the spectrum; but in very different proportions; the red rays predominating at one end, and the blue rays at the other, while the yellow rays are most abundant in the middle, where they prevail over the small quantities of red and blue rays which also exist there, and produce the yellow space which we see at that part. The yellow rays, by mixing with a larger proportion of red rays on one side, produce the orange; and by mixing with blue rays on the other side, produce the green. The indigo and the violet, which are seen beyond the blue, are likewise the result of admixture of a very small proportion of red rays, which extend to that part of the spectrum, with the strong blue rays. All the intermediate tints are produced, in a similar manner, by the different proportions in which these three coloured rays, the red, yellow, and blue are combined together; thus forming the spectrum as it was originally observed by Sir Isaac Newton, and which I have just shown you.

The rainbow, which exhibits a series of colours so analogous to those of the spectrum, is formed by the refraction of the sun's rays in their passage through a shower of rain, every drop of which disperses coloured rays as they pass through it.

EMILY.

But how can drops of rain separate the coloured

rays, for drops are spherical, and resemble a lens in form much more than a prism?

MRS. B.

Whatever be the form of the refracting medium, refraction always disperses the coloured rays more or less, because they have each different degrees of refrangibility. A prism produces this effect in the greatest degree, because its two surfaces being inclined to one another, the dispersion produced by the first is still farther increased by the second surface. The same effect will be produced in all cases where the rays have to pass through two surfaces of a medium, which are not parallel to one another, as in that of a spherical drop of rain. Lenses produce dispersion just as a prism does; for, indeed, the edges of a lens are in the same condition as those of a prism bent circularly. You need only look at the edge of a piece of white paper through the marginal parts of a lens, and you will see it fringed with the prismatic colours.

EMILY.

So it is, indeed! Water then will separate the coloured rays as well as glass?

MRS. B.

Water, as well as every transparent medium, will disperse the rays, but not as well as glass, for

the dispersive power varies in different substances, and glass is one of the best. The extent of this power depends also on the angle of incidence with which the ray falls on the prism; the greater the angle, the stronger is the refraction; and two prisms, the one of flint glass, the other of crown glass, may be so adjusted as completely to counteract each other's dispersive power, so that the ray will be refracted without any separation of the colours.

CAROLINE.

As is the case when the ray, after being dispersed by a prism, is united by a lens.

MRS. B.

Not exactly; for in the one case the dispersion takes place, and the rays are again united: in the other, the dispersion is prevented by the conflicting powers of the two glasses.

EMILY.

Pray, Mrs. B., cannot the sun's rays be collected to a focus by a lens, in the same manner as they are by a concave mirror?

MRS. B.

No doubt the same effect is produced by the refraction of a lens as by the reflection of a concave mirror: in the first, the rays pass through the glass

and converge to a focus behind it; in the latter, they are reflected from the mirror, and brought to a focus before it. A lens, when used for the purpose of collecting the sun's rays, is called a burning glass. The sun now shines very bright; if we let the rays fall on this lens you will perceive the focus.

EMILY.

Oh yes; the point of union of the rays is very luminous. I will hold a piece of paper in the focus, and see if it will take fire. The spot of light is extremely brilliant, but the paper does not burn.

MRS. B.

Try a piece of brown paper;—that, you see, takes fire almost immediately.

CAROLINE.

This is surprising; for the light appeared to shine more intensely on the white than on the brown paper.

MRS. B.

The lens collects an equal number of rays to a focus, whether you hold the white or the brown paper there; but the white paper appears more luminous in the focus, because most of the rays, instead of entering into the paper, are reflected by it; and this is the reason that the paper is not burnt: whilst, on the contrary, the brown paper,

which absorbs more light than it reflects, soon becomes heated and takes fire.

CAROLINE.

This is extremely curious; but why should brown paper absorb more rays than white paper?

MRS. B.

I am far from being able to give a satisfactory answer to that question. We can form but mere conjecture on this point, and suppose that the tendency to absorb or reflect rays depends on the arrangement of the minute particles of the body, and that this diversity of arrangement renders some bodies susceptible of reflecting one coloured ray, and absorbing the others; whilst other bodies have a tendency to reflect all the colours, and others again to absorb them all.

EMILY.

And how do you know which colours bodies have a tendency to reflect, or which to absorb?

MRS. B.

Because a body always appears to be of the colour which it reflects; for as we see only by reflected rays, it can appear but of the colour of those rays.

CAROLINE.

But we see all bodies of their own natural colour, Mrs. B.: the grass and trees, green; the sky, blue; the flowers of various hues.

MRS. B.

True; but why is the grass green?—because it absorbs all except the green rays: it is, therefore, these only which the grass and trees reflect to our eyes, and which make them appear green. The sky and flowers, in the same manner, reflect the various colours of which they appear to us; the rose, the red rays; the violet, the blue; the jonquil, the yellow, &c.

CAROLINE.

But these are the permanent colours of the grass and flowers, whether the sun's rays shine on them or not.

MRS. B.

Whenever you see those colours, the flowers must be illuminated by some light; and light, from whatever source it proceeds, is of the same nature, composed of the various coloured rays which paint the grass, the flowers, and every coloured object in nature.

CAROLINE.

But, Mrs. B., the grass is green, and the flowers are coloured, whether in the dark or exposed to the light.

MRS. B.

Why should you think so?

CAROLINE.

It cannot be otherwise.

MRS. B.

A most philosophical reason indeed! But, as I never saw them in the dark, you will allow me to dissent from your opinion.

CAROLINE.

What colour do you suppose them to be, then, in the dark?

MRS. B.

None at all; or black, which is the same thing. You can never see objects without light. Light is composed of colours; therefore, there can be no light without colours; and though every object is black, or without colour, in the dark, it becomes coloured as soon as it becomes visible. It is visible indeed, but by the coloured rays which it reflects; therefore we can see it only when coloured.

CAROLINE.

All you say seems very true, and I know not what to object to it; yet it appears at the same time incredible. What, Mrs. B., are we all as black as negroes in the dark? you make me shudder at the thought!



MRS. B.

Your vanity need not be alarmed at the idea, as you are certain of never being seen in that state.

CAROLINE.

That is some consolation, undoubtedly; but what a melancholy reflection it is, that all nature, which appears so beautifully diversified with colours, should be one uniform mass of blackness!

MRS. B.

Is nature less pleasing by deriving colour as well as illumination from the rays of light; and are colours less beautiful, for being accidental, rather than essential properties of bodies?

Providence appears to have decorated nature with the enchanting diversity of colours, which we so much admire, for the sole purpose of beautifying the scene, and rendering it a source of pleasurable enjoyment; it is an ornament which embellishes nature, whenever we behold her. What reason is there to regret that she does not wear it when she is invisible?

EMILY.

I confess, Mrs. B., that I have had my doubts, as well as Caroline, though she has spared me the pains of expressing them: but I have just thought of an experiment, which, if it succeed, will, I am

sure, satisfy us both. It is certain, that we cannot see bodies in the dark, to know whether they have then any colour. But we may place a coloured body in a ray of light, which has been refracted by a prism; and if your theory is true, the body, of whatever colour it naturally is, must appear of the colour of the ray in which it is placed; for since it receives no other coloured rays, it can reflect no others.

CAROLINE.

Oh! that is an excellent thought, Emily; will you stand the test, Mrs. B.?

MRS. B.

I consent: but we must darken the room, and admit only the ray which is to be refracted; otherwise the white rays will be reflected on the body under trial, from various parts of the room. With what do you choose to make the experiment?

CAROLINE.

This rose: look at it, Mrs. B., and tell me whether it is possible to deprive it of its beautiful colour?

MRS. B.

We shall see. — I expose it first to the red rays, and the flower appears of a more brilliant hue; but observe the green leaves —

CAROLINE.

They appear neither red nor green; but of a dingy brown with a reddish glow!

MRS. B.

They cannot be green, because they have no green rays to reflect; neither are they red, because green bodies absorb most of the red rays. But though bodies, from the arrangement of their particles, have a tendency to absorb some rays, and reflect others, yet they are not so perfectly uniform in their arrangement as to reflect only pure rays of one colour and wholly absorb the others. It is found, on the contrary, that a body reflects, in great abundance, the rays which determine its colour, and the others in a greater or less degree, in proportion as they are nearer or farther from its own colour, in the order of refrangibility. The green leaves of the rose, therefore, will reflect a few of the red rays, which, blended with their natural blackness, give them that brown tinge; if they reflected none of the red rays, they would appear quite black. Now I shall hold the rose in the blue rays——

CAROLINE.

Oh, Emily, Mrs. B. is right! look at the rose; it is no longer red, but of a dingy blue colour.

EMILY.

This is the most wonderful of any thing we have yet learnt. But, Mrs. B., what is the reason that the green leaves are of a brighter blue than the rose?

MRS. B.

The green leaves reflect both blue and yellow rays which produce a green colour. They are now in a coloured ray, which they have a tendency to reflect; they, therefore, reflect more of the blue rays, and will, of course, appear of a brighter blue than the rose, which naturally absorbs that colour.

EMILY.

Yet, in passing the rose through the different colours of the spectrum, the flower takes them more readily than the leaves.

MRS. B.

Because the flower is of a paler hue. Bodies which reflect all the rays are white: those which absorb them all are black: between these extremes the body appears lighter or darker, in proportion to the quantity of rays they reflect or absorb. This rose is of a pale red: it approaches nearer to white than black; it therefore reflects rays more abundantly than it absorbs them.

EMILY.

But if a rose has so strong a tendency to reflect

rays, I should have imagined that it would be of a deep red colour.

MRS. B.

I mean to say, that it has a general tendency to reflect rays. Pale-coloured bodies reflect all the coloured rays to a certain degree, which produces their paleness, approaching to whiteness: but one colour they reflect more than the rest: this predominates over the white, and determines the colour of the body. Since, then, bodies of a pale colour in some degree reflect all the rays of light, in passing through the various colours of the spectrum, they will reflect them all with tolerable brilliancy, but will appear most vivid in the ray of their natural colour. The green leaves, on the contrary, are of a dark colour, bearing a stronger resemblance to black than to white; they have, therefore, a greater tendency to absorb than to reflect rays; and reflecting very few of any but the blue and yellow rays, they will appear dingy in passing through the other colours of the spectrum.

CAROLINE.

They must, however, reflect great quantities of the green rays, to produce so deep a colour.

MRS. B.

Deepness or darkness of colour proceeds rather from a deficiency than an abundance of reflected

rays. Remember that bodies are, of themselves, black; and if a body reflects only a few green rays, it will appear of a dark green; it is the brightness and intensity of the colour which show that a great quantity of rays are reflected.

EMILY.

A white body, then, which reflects all the rays, will appear equally bright in all the colours of the spectrum.

MRS. B.

Certainly. And this is easily proved by passing a sheet of white paper through the rays of the spectrum.

CAROLINE.

What is the reason that blue often appears green by candle-light.

MRS. B.

The light of a candle is not so pure as that of the sun: it has a yellowish tinge, and when refracted by the prism, the yellow rays predominate; and as blue bodies reflect the yellow rays in the next proportion (being next in order of refrangibility), the superabundance of yellow rays gives to blue bodies a greenish hue.

CAROLINE.

Candle-light must then give to all bodies a yellowish tinge, from the excess of yellow rays; and

yet it is a common remark, that people of a sallow complexion appear fairer or whiter by candle-light.

MRS. B.

The yellow cast of their complexion is not so striking, when every object has a yellow tinge.

EMILY.

Pray, why does the sun appear red through a fog?

MRS. B.

It is supposed to be owing to the red rays having a greater momentum, which gives them power to traverse so dense an atmosphere. For the same reason, the sun generally appears red at rising and setting: as the increased quantity of atmosphere, which the oblique rays must traverse, loaded with the mists and vapours which are usually formed at those times, prevents the other rays from reaching us.

CAROLINE.

And, pray, why is the sky of a blue colour?

MRS. B.

You should rather say the atmosphere; for the sky is a very vague term, the meaning of which it would be difficult to define philosophically.

CAROLINE.

But the colour of the atmosphere should be white, since all the rays traverse it in their passage to the earth.

MRS. B.

Do not forget that we see none of the rays which pass from the sun to the earth, excepting those which meet our eyes; and this happens only if we look at the sun, and thus intercept the rays, in which case, you know, it appears white. The atmosphere is a transparent medium, through which the sun's rays pass freely to the earth; but when reflected back into the atmosphere, their momentum is considerably diminished; and they have not all of them power to traverse it a second time. The momentum of the blue rays is least; these, therefore, are the most impeded in their return, and are chiefly reflected by the atmosphere back again to the earth. Besides, the colour which the particles of air most readily reflect is blue, just as grass reflects the green, and a rose the red rays. This reflection is performed in every possible direction; so that whenever we look at the atmosphere, some of these rays fall upon our eyes; hence, we see the air of a blue colour.

EMILY.

Then, if the atmosphere did not reflect any rays would the skies appear black?



MRS. B.

Yes, perfectly so, though the objects on the surface of the earth would be illumined.

CAROLINE.

Oh, how melancholy that would be; and how pernicious to the sight, to be constantly viewing bright objects against a black sky. But what is the reason that bodies often change their colour, as leaves which wither in autumn, or a spot of ink which produces an iron mould on linen?

MRS. B.

It arises from some chemical change, which takes place in the internal arrangement of the parts, by which they lose their tendency to reflect certain colours, and acquire the power of reflecting others. A withered leaf thus no longer reflects the blue rays; it appears, therefore, yellow, or has a slight tendency to reflect several rays which produce a dingy brown colour.

An ink-spot on linen at first absorbs all the rays; but, exposed to the air, it undergoes a chemical change, and the spot partially regains its tendency to reflect colours, but with a preference to reflect the yellow rays; and such is the colour of the iron mould which the ink-spot produces.

EMILY.

Bodies, then, far from being of the colour which they appear to possess, are of that colour which

they have the greatest aversion to, which they will not incorporate with, but reject and drive from them.

MRS. B.

It certainly is so; though I scarcely dare venture to advance such an opinion, whilst Caroline is contemplating her beautiful rose.

CAROLINE.

My poor rose! not satisfied with depriving it of its colour, you even make it have an aversion to it; and I am unable to contradict you.

EMILY.

Since dark bodies absorb more solar rays than light ones, the former should sooner be heated if exposed to the sun.

MRS. B.

And they are found by experience to be so. Have you never observed a black dress to be warmer than a white one?

EMILY.

Yes, and a white one more dazzling. The black is heated by absorbing the rays, the white dazzles by reflecting them.

CAROLINE.

And this, I suppose, was the reason that the brown paper was burnt in the focus of the lens,

whilst the white paper exhibited the most luminous spot, but did not take fire?

MRS. B.

It was so. Light, I must not forget to tell you, is also susceptible of a double refraction. Crystallised minerals, and many animal and vegetable substances, such as gums, resins, and jellies, possess the property of doubly refracting light. That is to say, a ray of light falling upon any of these bodies is refracted into two pencils, one of which, following the direction, nearly, of simple refraction, is called the *ordinary ray*; the other, governed by much more complicated laws, is called the *extraordinary ray*.

Double refraction is remarkable for imparting new properties to the two rays, and they have been distinguished from common rays of light, by the name of polarized rays.

CAROLINE.

Polarized! What a strange name! It would seem to imply that light had poles; and since it is not a body, that cannot be.

MRS. B.

The name was first adopted when the corpuscular theory of light prevailed; and arose, as you suspect, from some imaginary analogy in the arrangement of the particles of light to the poles of

a magnet. But since that theory has been superseded, the name, it is true, ought not to have been retained; for by a false association it serves to confuse rather than elucidate the subject.

The faculty of polarizing light is, however, far from being confined to double-refracting substances; for it may be produced both by simple refraction (under certain circumstances), and by reflection. In the latter case it is necessary that it should be reflected at a particular angle; this angle varies according to the nature of the substance. Plate glass will polarize light, if reflected at an angle of  $57^{\circ}$ ; water, at an angle of  $53^{\circ} 11'$ .

EMILY.

And are the rays polarized by reflection, divided into two pencils, as they are by double refraction?

MRS. B.

No; but they possess the same peculiarity, in as much as they have different properties on their different sides. I regret that I must confine myself to the mention of these facts, for the laws which govern polarized light are too difficult for you to understand.

EMILY.

There is one thing that surprises me much in regard to light, Mrs. B. How is it that the immense number of rays which the sun darts

forth in every direction, and which, as you have shown us (Plate XV. fig. 1.), frequently cross each other, do not interfere and impede each other's course?

MRS. B.

The truth is, that they frequently do interfere; but when I first mentioned the radiation of light, I did not notice this interference, because the result is so very extraordinary, that I thought you would not then understand it; and, indeed, now that you are better acquainted with the laws by which light is governed, I doubt whether I shall be able to make it clear to you.

Do you recollect the theory of the undulations of light?

EMILY.

Oh, yes; light is propagated by an elastic ethereal medium, in waves produced by the vibrations of the ether.

MRS. B.

A ray, then, proceeding from a luminous body, consists of a succession of these waves impelling one another forward in a straight line. Now, suppose two rays proceeding from the same body slightly inclined to each other, they would in time meet in a point. If, at this point, the waves of which the two rays consist happen exactly to coincide; that is to say, the elevation or

bulging part of the last wave of one ray corresponds with the elevation of the last wave of the other ray, and the hollow or receding part of the last wave of one ray corresponds with those of the other ray, then the two rays will unite; and, if received on a skreen, will form a spot or image of double the brilliancy of a single ray.

CAROLINE.

It is a very natural consequence, that the union of two rays should produce twice the brilliancy that one of them does singly.

MRS. B.

But I have not yet finished my explanation.

Supposing that one of the rays should be half a wave in advance of the other, the undulations will no longer coincide, and at the point of junction one of them will be terminated by the middle of a wave, while the other will be terminated by the extremity of a wave; thus, the bulging part of the one will correspond with and fall into the hollow part of the other. At the point of junction, the motion of the two rays will be in opposite directions, and they will destroy each other's motion: now, let me ask you, what will be the result?

EMILY.

Why, since light is produced by the motion of

the rays, the cessation of their motion should destroy light as well as motion.

MRS. B.

And so it does. Thus, the rays at the point of contact extinguish each other; and a dark, instead of a brilliant, spot is produced.

CAROLINE.

This is, indeed, curious! The waves of light must, I suppose, be extremely small?

MRS. B.

The length of a wave of light has been ascertained with great precision, but by processes far too difficult for me to explain, or you to understand; I shall, therefore, only tell you the result. The dimensions of the undulations vary with the colour of the ray; the length of one undulation of red rays is  $\frac{1}{39180}$ th of an inch; that of the violet ray, which you may recollect is situated at the opposite extremity of the spectrum, is the  $\frac{1}{37490}$ th of an inch, and the intervening colours are of intermediate lengths.

CAROLINE.

One can hardly conceive any thing so small!

MRS. B.

And yet you know that it is necessary to halve this minute measurement to produce the extinction of light at the point of junction of the rays;

for one of the red rays must be half a wave, or the  $\frac{1}{78360}$ th of an inch longer than the other to produce this effect.

EMILY.

And supposing that one of the rays were a whole wave in advance of the other, would light or darkness be the result of their union?

MRS. B.

It would be light; because the waves, though unequal in number, would coincide. Whatever number of whole waves be added to one of the rays, light is produced by its junction with the other ray; but the addition of any fractional part of a wave produces an interference which extinguishes the light of both rays.

This is one of the strongest arguments in favour of the undulating theory of light, in opposition to that of the corpuscular theory; for it is contrary to all our ideas of matter to suppose that two particles coming in contact should annihilate one another, whilst it is very natural to suppose that the contact of two particles may destroy each other's motion.

•  
EMILY.

Oh, yes! I have seen two billiard balls, when struck with equal force from different ends of the table, destroy each other's motion at the point of



contact, but they could not destroy each other's substance.

MRS. B.

Neither could the smallest particles of matter do so; if, therefore, light were coporeal, it could not be extinguished by two particles coming in contact under any circumstances.

There is another property of light, which I cannot pass over in silence, though it will not admit of a familiar explanation any more than the interference of the rays or the polarization of light.

If a ray of light pass through a pin-hole into a dark room, and be received on a white skreen at the distance of a little more than six feet, a luminous spot will be described on the skreen, larger than the pin-hole through which the light passes, and this will be surrounded by a series of coloured rings separated from each other by dark intervals.

EMILY.

How very curious!

MRS. B.

Similar phenomena are produced when rays pass through a very narrow slit, excepting that instead of coloured rings, coloured stripes are formed, separated by dark ones.

This is explained on the principle of the interference of the rays: the brilliant coloured rings being the result of the junction of rays whose waves coincide, and the dark intervals being produced by the mutual extinction of rays whose waves do not coincide.

CAROLINE.

How strong the analogy is between the undulations of light and those of sound!

MRS. B.

It is indeed; and the deeper the subject is studied, the more perfect it appears.

The principle of the interference of rays, which is now fully established, has led to the explanation of many of the properties of light which were previously not understood. But I cannot attempt to follow up such investigations: it is sufficient for the present that I should point out the facts, in case that, at any future time, you should be induced to prosecute the study more deeply.

## CONVERSATION XVIII.

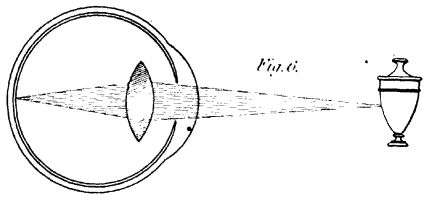
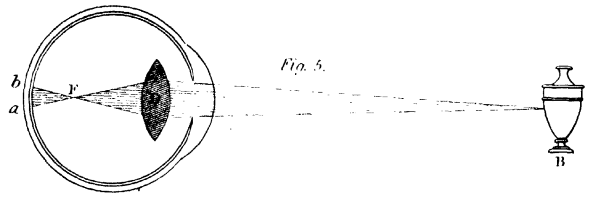
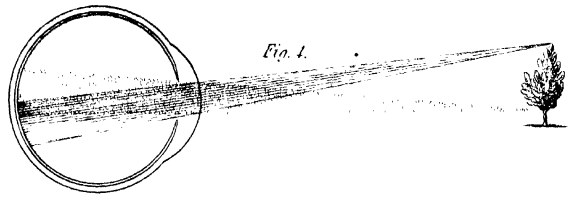
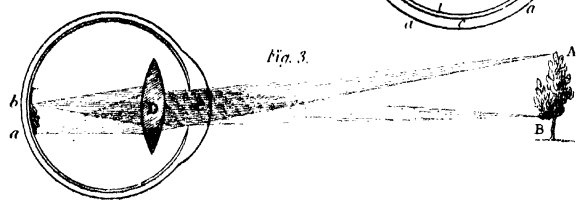
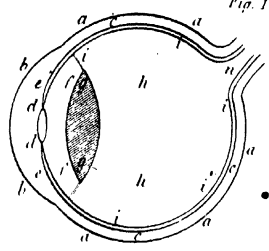
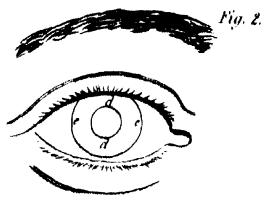
OPTICS — *continued.*ON THE STRUCTURE OF THE EYE, AND  
OPTICAL INSTRUMENTS.

DESCRIPTION OF THE EYE.—OF THE IMAGE ON THE  
RETINA.—REFRACTION OF THE HUMOURS OF THE  
EYE.—OF THE USE OF SPECTACLES.—OF THE  
SINGLE MICROSCOPE.—OF THE DOUBLE MICROSCOPE.  
—OF THE SOLAR MICROSCOPE.—MAGIC LANTERN.—  
REFRACTING TELESCOPE.—REFLECTING TELESCOPE.

MRS. B.

I SHALL this morning give you some account of the structure of the eye; you have hitherto considered it only as a simple camera obscura, in which the representation of objects is made on the retina; but I must now tell you, that this camera obscura is furnished with a variety of substances, all of which contribute to the perfection of vision,





and is enclosed in a double covering to guard it from injury.

• The body of the eye is of a spherical form (fig. 1. Plate XXI.); it has two membraneous coverings: the external one, *a a a*, is called the sclerotica: this has a projection in that part of the eye which is exposed to view, *b b*, which is called the cornea; because, when dried, it has nearly the consistence of very fine horn, and is sufficiently transparent for the light to obtain free passage through it.

The second membrane, which lines the cornea, and envelopes the eye, is called the choroid, *c c c*; this has an opening in front just beneath the cornea, which forms the pupil, *d d*, through which the rays of light pass into the eye. The pupil is surrounded by a coloured border of fibres, called the iris, *e e*, which, by its motion, always preserves the pupil of a circular form, whether it be expanded in the dark, or contracted by a strong light. This you will understand better by examining fig. 2.

EMILY.

I did not know that the pupil was susceptible of varying its dimensions.

MRS. B.

The construction of the eye is so admirable, that it is capable of adapting itself, more or less, to the

circumstances in which it is placed. In a faint light the pupil dilates so as to receive an additional quantity of rays, and in a strong light it contracts, in order to prevent the intensity of the light from injuring the optic nerve. Observe Emily's eyes, as she sits looking towards the windows: the pupils appear very small, and the iris large. Now, Emily, turn from the light, and cover your eyes with your hand, so as entirely to exclude it for a few moments.

CAROLINE.

How very much the pupils of her eyes are now enlarged, and the iris diminished! This is, no doubt, the reason why the eyes suffer pain when from darkness they suddenly come into a strong light; for the pupil being dilated, a quantity of rays must rush in before it has time to contract.

EMILY.

And when we go from a strong light into obscurity, we at first imagine ourselves in total darkness; for a sufficient number of rays cannot gain admittance into the contracted pupil to enable us to distinguish objects; but in a few minutes it dilates, and we clearly perceive objects which were before invisible.

MRS. B.

It is just so. The choroid, *c c*, is lined with a black paint, which serves to absorb all the rays

that are irregularly reflected, and to convert the body of the eye into a more perfect camera obscura. When the pupil is expanded to its utmost extent, it is capable of admitting ten times the quantity of light that it does when most contracted. In cats, and animals which are said to see in the dark, the power of dilatation and contraction of the pupil is still greater: it is computed that their pupils may admit one hundred times more light at one time than at another.

Within these coverings of the eye-ball are contained three transparent substances, called humours. The first occupies the space immediately behind the cornea, and is called the aqueous humour, *f f*, from its liquidity and its resemblance to water. Beyond this is situated the crystalline humour, *g g*, so called from its clearness and transparency: it has the form of a lens, and refracts the ray of light in a greater degree of perfection than any that have been constructed by art: it is attached by fibres to each side of the choroid. The back part of the eye between the crystalline humour and the retina, is filled by the vitreous humour, *h h*, which derives its name from an apparent resemblance to glass or vitrified substances.

The membraneous coverings of the eye are intended chiefly for the preservation of the retina, *i i*, which is by far the most important part of the eye,



as it is that which receives the impression of the objects of sight, and conveys it to the mind. The retina consists of an expansion of the optic nerve, which proceeds from the brain, enters the eye at *n*, on the side next the nose, and is finely spread over the interior surface of the choroid.

The rays of light which enter the eye by the pupil are refracted by the several humours in their passage through them, each pencil uniting in a focus on the retina.

CAROLINE.

I do not exactly understand what is meant by a pencil of rays.

MRS. B.

I have told you that rays proceed from bodies in all possible directions. We must, therefore, consider every part of an object which sends rays to our eyes as points from which the rays diverge, as from a centre. These divergent rays, issuing from a single point, are called a pencil of rays?

Now divergent rays, on entering the pupil, do not cross each other; the pupil, however, is sufficiently large to admit a small pencil of them; and these, if not refracted to a focus by the humours, would continue diverging after they had passed the pupil, would fall dispersed upon the retina, and thus the image of a single point would be expanded over a large portion of the retina. The divergent

rays from every other point of the object would be spread over a similar extent of space, and would interfere and be confounded with the first ; so that no distinct image could be formed, and the retina would represent total confusion both of figure and colour. Fig. 3. represents two pencils of rays issuing from two points of the tree *AB*, and entering the pupil *C*, refracted by the crystalline humour *D*, and forming distinct images of the spot they proceed from, on the retina, at *a b*. Fig. 4. differs from the preceding, merely from not being supplied with a lens ; in consequence of which the pencils of rays are not refracted to a focus, and no distinct image is formed on the retina. I have delineated only the rays issuing from two points of an object, and distinguished the two pencils in fig. 4. by describing one of them with dotted lines : the interference of these two pencils of rays on the retina will enable you to form an idea of the confusion which would arise, from thousands and millions of points at the same instant pouring their divergent rays upon the retina.

EMILY.

True ; but I do not yet well understand how the refracting humours remedy this imperfection.

MRS. B.

The refraction of these several humours unite the whole of a pencil of rays, proceeding from any

one point of an object, to a corresponding point on the retina, and the image is thus rendered distinct and strong. If you conceive, in fig. 3., every point of the tree to send forth a pencil of rays similar to those, *AB*, every part of the tree will be as accurately represented on the retina as the points *ab*.

EMILY.

How admirably, how wonderfully, this is contrived!

CAROLINE.

But since the eye requires refracting humours in order to have a distinct representation formed on the retina, why is not the same refraction necessary for the image formed in the camera obscura?

MRS. B.

Because the aperture through which we received the rays into the camera obscura is extremely small; so that but very few of the rays diverging from a point gain admittance: but we shall now enlarge the aperture, and furnish it with a lens, and you will find that the landscape will be more perfectly represented.

CAROLINE.

How obscure and confused the image is, now that you have enlarged the opening, without putting the lens!

MRS. B.

Such, or very similar, would be the representation on the retina, unassisted by the refracting humours. But see what a difference is produced by the introduction of the lens, which collects each pencil of divergent rays into their several foci.

CAROLINE.

The alteration is wonderful; the representation is more clear, vivid, and beautiful than ever.

MRS. B.

You will now be able to understand the nature of that imperfection of sight, which arises from the eyes being too prominent. In such cases the crystalline humour, D (fig. 5.), being extremely convex, refracts the rays too much, and collects a pencil, proceeding from the object A B, into a focus, F, before they reach the retina. From this focus, the rays proceed diverging, and consequently form a very confused image on the retina at *a*, *b*. This is the defect of short-sighted people.

EMILY.

I understand it perfectly. But why is this defect remedied by bringing the object nearer to the eye, as we find to be the case with short-sighted people?

MRS. B.

The nearer you bring an object to your eye, the more divergent the rays fall upon the crystalline

humour, and they are consequently not so soon converged to a focus: this focus, therefore, either falls upon the retina, or at least approaches nearer to it, and the object is proportionally distinct, as in fig. 6.

EMILY.

The nearer, then, you bring an object to a lens, the farther the image recedes behind it.

MRS. B.

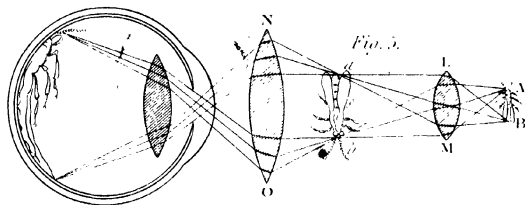
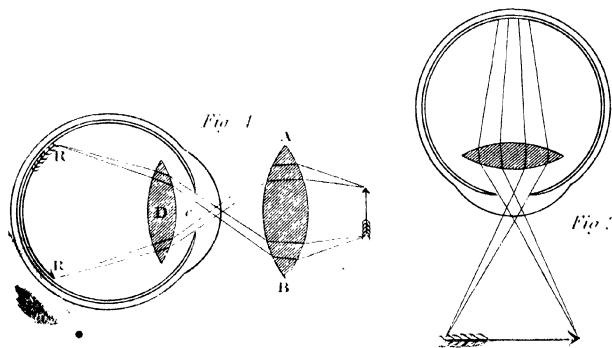
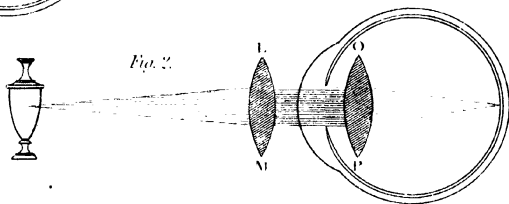
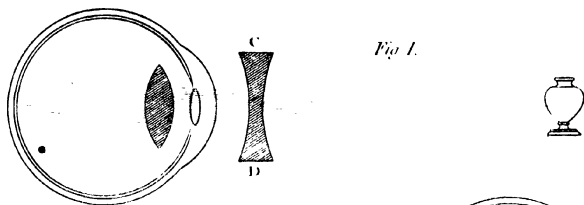
Certainly. But short-sighted persons have another resource for objects which they cannot approach to their eyes; this is to place a concave lens, C D (fig. 1. Plate XXII.), before the eye, in order to increase the divergence of the rays. The effect of a concave lens is, you know, exactly the reverse of a convex one; it renders convergent rays less convergent, parallel rays divergent, and those which are already divergent, still more so. By the assistance of such glasses, therefore, the rays from a distant object fall on the pupil as divergent as those from a less distant object; and, with short-sighted people, they throw the image of a distant object back as far as the retina.

CAROLINE.

This is an excellent contrivance, indeed. .

MRS. B.

And tell me, what remedy would you devise for such persons as have a contrary defect in their sight; that is to say, in whom the crystalline





humour, being too flat, does not refract the rays sufficiently, so that they reach the retina before they are converged to a point?

CAROLINE.

I suppose that a contrary remedy must be applied to this defect; that is to say, a convex lens, LM (fig. 2.), to make up for the deficiency of convexity of the crystalline humour OP. For the convex lens would bring the rays nearer together, so that they would fall either less divergent, or parallel on the crystalline humour; and, by being sooner converged to a focus, would fall on the retina.

MRS. B.

Very well, Caroline. This is the reason why elderly people, the humours of whose eyes are decayed by age, are under the necessity of using convex spectacles. And when deprived of that resource, they hold the object at a distance from their eyes.

CAROLINE.

I have often been surprised when my grandfather reads without his spectacles, to see him hold the book at a considerable distance from his eyes; but I now understand it; for the more distant the object is from the crystalline humour, the nearer the image will be to it.



EMILY.

I comprehend the nature of these two opposite defects very well; but I cannot now conceive, how any sight can be perfect; for if the crystalline humour is of a proper degree of convexity, to bring the image of distant objects to a focus on the retina, it will not represent near objects distinctly; and if, on the contrary, it is adapted to give a clear image of near objects, it will produce a very imperfect one of distant objects.

MRS. B.

Your observation is very good, Emily; and it is true, that every person would be subject to one of these two defects, if they had it not in their power to increase or diminish, in some degree, the convexity of the crystalline humour, and to project it towards, or draw it back from the object, as circumstances require. In a young well-constructed eye, the fibres to which the crystalline humour is attached have so perfect a command over it, that the focus of the rays constantly falls on the retina, and an image is formed equally distinct both of distant objects and of those which are near.

CAROLINE.

In the eyes of fishes, which are the only eyes I have ever seen separate from the head, the cornea does not protrude, in that part of the eye which is exposed to view.

MRS. B.

The cornea of the eye of a fish is not more convex than the rest of the ball of the eye; but to supply this deficiency, their crystalline humour is spherical, and refracts the rays so much, that it does not require the assistance of the cornea to bring them to a focus on the retina.

EMILY.

Pray what is the reason that we cannot see an object distinctly, if we place it very near to the eye?

MRS. B.

Because the rays fall on the crystalline humour too divergent to be refracted to a focus on the retina; the confusion, therefore, arising from viewing an object too near the eye is similar to that which proceeds from a flattened crystalline humour; the rays reach the retina before they are collected to a focus. (Fig. 3.) If it were not for this imperfection, we should be able to see and distinguish the parts of objects which are now invisible to us from their minuteness; for could we approach them very near the eye, their image on the retina would be so much magnified as to render them visible.

EMILY.

And could there be no contrivance to convey

the rays of objects viewed close to the eye, so that they should be refracted to a focus on the retina?

MRS. B.

The microscope is constructed for this purpose. The single microscope (fig. 4.) consists simply of a convex lens, commonly called a magnifying glass ; in the focus of which the object is placed, and through which it is viewed : by this means, you are enabled to approach your eye very near the object ; for the lens AB, by diminishing the divergency of the rays before they enter the pupil C, makes them fall parallel on the crystalline humour D, by which they are refracted to a focus on the retina at RR.

EMILY.

This is a most admirable invention, and nothing can be more simple, for the lens magnifies the object merely by allowing us to bring it nearer to the eye.

MRS. B.

Those lenses, therefore, which have the shortest focus, will magnify the object most, because they enable us to bring the object nearest to the eye.

EMILY.

But a lens that has the shortest focus is most bulging or convex ; and the protuberance of the

lens will prevent the eye from approaching very near to the object.

MRS. B.

This is remedied by making the lens extremely small: it may then be spherical without occupying much space, and thus unite the advantages of a short focus, and of allowing the eye to approach the object.

CAROLINE.

We have a microscope at home which is a much more complicated instrument than that you have described.

MRS. B.

It is a compound microscope (fig. 5.), in which you see not the object *AB*, but a magnified image of it, *a b*. In this microscope, two lenses are employed; the one, *LM*, for the purpose of magnifying the object, is called the object-glass; the other, *NO*, acts on the principle of the single microscope, and is called the eye-glass.

There is another kind of microscope, called the solar microscope, which is the most wonderful, from its great magnifying power: in this we also view an image formed by a lens, not the object itself. As the sun shines, I can show you the effect of this microscope; but it will be necessary to close the shutters, and admit only a small portion of light, through the hole in the window-

shutter, which we used for the camera obscura. We shall now place the object AB (Plate XXIII. fig. 1.), which is a small insect, before the lens, CD, and nearly at its focus; the image EF will then be represented on the opposite wall, in the same manner as the landscape was in the camera obscura; with this difference, that it will be magnified instead of being diminished. I shall leave you to account for this by examining the figure.

EMILY.

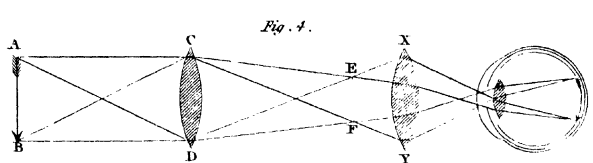
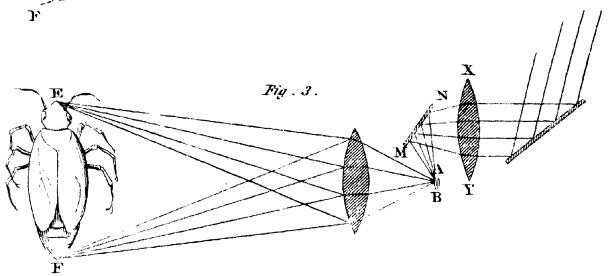
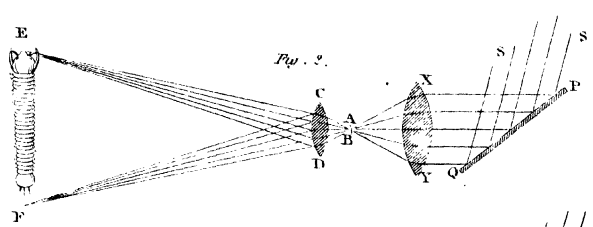
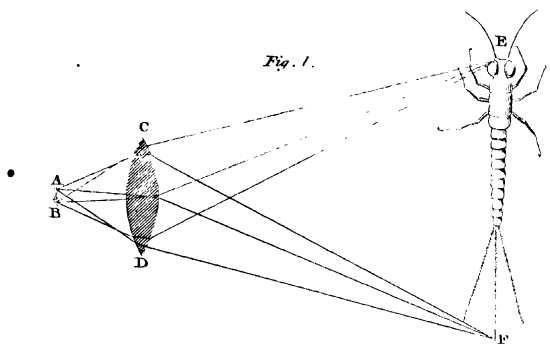
I see it at once. The image EF is magnified, because it is farther from the lens than the object AB; while the representation of the landscape was diminished, because it was nearer the lens than the landscape was. A lens, then, answers the purpose equally well, either for magnifying or diminishing objects.

MRS. B.

Yes. If you wish to magnify the image, you place the object near the focus of the lens; if you wish to produce a diminished image, you place the object at a distance from the lens in order that the image may be formed in, or near, the focus.

CAROLINE.

The magnifying power of this microscope is prodigious: but the indistinctness of the image,





for want of light, is a great imperfection. Would it not be clearer, if the opening in the shutter were enlarged, so as to admit more light?

MRS. B.

If the whole of the light admitted does not fall upon the object, the effect will only be to make the room lighter, and the image consequently less distinct.

EMILY.

But could you not, by means of another lens, bring a large pencil of rays to a focus on the object, and thus concentrate the whole of the light admitted upon it?

MRS. B.

Very well. We shall enlarge the opening, and place the lens  $XY$  (fig. 2.) in it, to converge the rays to a focus on the object  $AB$ . There is but one thing more wanting to complete the solar microscope, which I shall leave to Caroline's sagacity to discover.

CAROLINE.

Our microscope has a small mirror attached to it, upon a moveable joint, which can be so adjusted as to receive the sun's rays, and reflect them upon the object. If a similar mirror were placed to reflect light upon the lens, would it not be a means of illuminating the object more perfectly?



MRS. B.

You are quite right. P Q (fig. 2.) is a small mirror, placed on the outside of the window-shutter, which receives the incident rays S S, and reflects them on the lens X Y. Now that we have completed the apparatus, let us examine the mites on this piece of cheese, which I place near the focus of the lens.

CAROLINE.

Oh, how much more distinct the image now is! and how wonderfully magnified! The mites on the cheese look like a drove of pigs scrambling over rocks.

EMILY.

I never saw any thing so curious. Now, an immense piece of cheese has fallen: one would imagine it an earthquake. Some of the poor mites must have been crushed; how fast they run,—they absolutely seem to gallop.

But this microscope can be used only for transparent objects; as the light must pass through them to form the image on the wall.

MRS. B.

Very minute objects, such as are viewed in a microscope, are generally transparent; but when opaque objects are to be exhibited, a mirror, M N (fig. 3.), is used to reflect the light on the side of

the object next the wall : the image is then formed by light reflected from the object, instead of being formed by rays transmitted by it.

EMILY.

. Pray, is not a magic lantern constructed on the same principles ?

MRS. B.

Yes ; with this difference, that the light is supplied by a lamp, instead of the sun.

The microscope is an excellent invention, to enable us to see and distinguish objects which are too small to be visible to the naked eye. But there are objects, which, though not really small, appear so to us, from their distance ; to these we cannot apply the same remedy ; for when a house is so far distant as to be seen under the same angle as a mite which is close to us, the effect produced on the retina is the same : the angle it subtends is not large enough for it to form a distinct image on the retina.

EMILY.

Since it is impossible, in this case, to approach the object to the eyes, cannot we by means of a lens bring an image of it nearer to us ?

MRS. B.

Yes ; but then, the object being very distant

from the focus of the lens, its image would always appear much smaller than the object itself.

EMILY.

Then, why not look at the image through another lens, which will act as a microscope, enable us to bring the image close to the eye, and thus magnify it?

MRS. B.

Very well, Emily; I congratulate you on having invented a telescope. In fig. 4. the lens  $CD$  forms an image,  $EF$ , of the object  $AB$ ; and the lens  $XY$  serves the purpose of magnifying that image, and this is all that is required in a common refracting telescope.

EMILY.

But in fig. 4. the image is not inverted on the retina, as it usually is: the object should, therefore, appear to us inverted: and that is not the case in the telescopes I have looked through.

MRS. B.

When it is necessary to represent the image erect, two other lenses are required; by which means a second image is formed, the inverse of the first, and consequently upright. These additional glasses are used to view terrestrial objects; for no inconvenience arises from seeing the celestial bodies inverted.

EMILY.

The difference between a microscope and a telescope seems to be this:—a microscope produces a magnified image, because the object is nearest the lens; and a telescope produces a diminished image, because the object is farthest from the lens.

MRS. B.

Your observation applies only to the lens C D or object-glass, which serves to bring an image of the object nearer the eye: for the lens X Y, or eye-glass, is, in fact, a microscope, as its purpose is to magnify the image. But it was found, in constructing telescopes, that the object-glass, instead of bringing the rays to a perfect focus, slightly dispersed them, and produced a confused coloured image. This defect was remedied by substituting two lenses in contact, one of flint glass, the other of crown glass, of such forms and proportions as to counteract each other's dispersive powers (as I have before explained to you\*), so that a well defined and colourless image is produced. This is called the *achromatic telescope*.

EMILY.

I have observed this defect in an opera glass, when the actor I was looking at appeared to be

\* See page 435.

surrounded by a coloured fringe of the dispersed rays.

MRS. B.

The two surfaces of the edges of the lens, not being parallel, disperse the coloured rays nearly as much as a prism, and produce this effect.

When a very great magnifying power is required, telescopes are constructed with concave mirrors, instead of lenses. Concave mirrors, you know, produce, by reflection, an effect similar to that of convex lenses by refraction. In reflecting telescopes, therefore, mirrors are used in order to bring the image nearer the eye; and a lens, or eye-glass, the same as in the refracting telescope, to magnify the image.\*

The great advantage of the reflecting telescope consists in its producing no dispersion whatever of the rays: and the image, consequently, is much more distinct and perfect, and will bear to be magnified to a much greater extent: for you recollect that the rays of light are never dispersed by reflection, but only by refraction. See p. 415.

CAROLINE.

But I thought it was the eye-glass only which

\* It would have been difficult to have explained to the pupils the principles which have enabled opticians to shorten refracting telescopes.





# INDEX.

## A

**ACHROMATIC** telescope, 477  
**Air**, 5. 16. 42. 92. 308. 374.  
     379  
**Air-pump**, 50. 312  
**Angle**, 79  
     —, acute, 81  
     —, obtuse, 81  
     — of incidence, 82. 368.  
     393  
     — of reflection, 82. 345.  
     368. 393  
     — of vision, 387. 391  
**Anemometer**, 337  
**Aphelion**, 158  
**Arctic circle**, 207. 223  
**Artesian wells**, 304  
**Atmosphere**, 231. 288. 308.  
     330. 336  
     —, reflection of, 337  
     —, colour of, 415  
     —, refraction of,  
     415. 421  
**Attraction**, 4. 14. 33. 417  
     — of cohesion, 15. 28.  
     264. 309

**Attraction of gravitation**, 24.  
     52. 147. 169. 215. 255. 309  
**Avenue**, 389  
**Auditory nerve**, 347  
**Axis**, 164  
     — of motion, 88. 107  
     — of the earth, 206. 220  
     — of mirrors, 402  
     — of a lens, 411. 425

## B

**Balloon**, 48  
**Barometer**, 319  
**Bass**, 348  
**Bladder**, 313  
**Bodies**, 3  
     —, elastic, 70  
     —, luminous, 352  
     —, re-action of, 68  
     —, sonorous, 338  
     —, fall of, 35. 40. 50. 62  
     —, opaque, 352. 415  
     —, transparent, 374. 415  
**Bulk**, 18



## C

- Camera obscura, 376. 384.  
472  
Capillary tubes, 22  
Centre, 88  
——, of gravity, 88. 96.  
104. 108  
—— of motion, 88. 107  
—— of magnitude, 88. 101  
Central sun, 192  
Centrifugal force, 90. 152. 212  
Centripetal force, 90. 152  
Ceres, 175  
Circle, 206. 209  
Circular motion, 87. 153  
Clouds, 287  
Colours, 32. 428  
Comets, 186  
Compression, 75.  
Concord, 349  
Constellations, 193  
Convergent rays, 402. 405  
Crystals, 7  
Cylinder, 100

## D

- Day, 162. 220. 236  
Degrees, 80. 209. 221. 392  
—— of latitude, 211. 249  
—— of longitude, 211.  
249  
Density, 17  
Diagonal, 85

- Diameter, 209  
Diffraction of light, 450  
Diurnal, 164  
Discords, 347  
Divergent rays, 402  
Divisibility, 4. 8  
Double stars, 188  
Double refraction, 450

## E

- Earth, 25. 148. 175. 196.  
200  
Echo, 345  
Eclipse, 246. 253  
Ecliptic, 194. 207  
Elastic bodies, 70  
—— fluids, 16. 45. 264.  
308  
Ellipsis, 156  
Essential properties, 4  
Exhalations, 10  
Extension, 4. 6  
Equator, 206  
Equinox, 222. 225  
——, precession of, 239  
Eye, 375

## F

- Fall of bodies, 35. 40. 50. 62  
Figure, 4. 7  
Fluids, 263  
——, elastic, 263. 308

- Fluids, equilibrium of, 267. 319  
 —, pressure of, 269. 296. 319
- Flying, 71
- Focus, 405  
 — of convex mirrors, 402  
 — of concave, 407. 410  
 — of a lens, 425. 427
- Force, 54  
 —, centrifugal, 90. 152. 212  
 —, centripetal, 90. 152  
 — of projection, 92. 149  
 — of gravity, 24. 149. 169. 309
- Fountains, 306
- Friction, 141. 306
- Frigid zone, 208. 223
- Fulcrum, 107
- G
- General properties of bodies, 3, 4
- Glass, 424  
 —, refraction of, 424  
 —, burning, 436
- Gold, 278. 294
- Gravity, 24. 32—52. 54. 62. 92. 96
- H.
- Harmony, 349
- Heat, 19. 228
- Hemisphere, 397. 223
- Hydrometer, 284
- Hydrostatics, 264
- I and J
- Image on the retina, 378. 395  
 — reversed, 383  
 — in plain mirror, 398. 402  
 — in convex ditto, 402  
 — in concave ditto, 402
- Incidence, angle of, 82
- Impenetrability, 4
- Inclined plane, 106. 136
- Inertia, 4. 13. 54.
- Interference of rays, 455
- Juno, 175
- Jupiter, 176. 252
- K
- Kaleidoscope, 28
- L
- Lake, 394
- Latitude, 211. 249
- Lens, 425  
 —, convex, 425  
 —, concave, 426
- Lever, 106

Lever, first order, 118  
 —, second ditto, 121  
 —, third ditto, 123  
 Leverrier's planet, 179  
 Light, 353  
 —, corpuscular theory of, 450  
 —, undulatory theory of, 452  
 —, pencil of, 356. 462  
 —, reflected, 367  
 — of the moon, 372  
 —, refraction of, 415  
 —, absorption of, 437  
 —, double refraction of, 450  
 —, polarisation of, 450  
 —, diffraction of, 450  
 Liquid, 264  
 Longitude, 211. 249  
 Luminous bodies, 352  
 Lunar month, 244  
 — eclipse, 246

## M

Machine, 106. 135. 141  
 Magic lantern, 475  
 Mars, 175  
 Matter, 3. 169  
 Mechanics, 106  
 Mediums, 353. 416.  
 Melody, 350  
 Mercury, the planet, 173.  
 254

Mercury, or quicksilver, 318  
 Meridians, 209  
 Microscope, 475  
 —, single, 470  
 —, double, 471  
 —, solar, 471—475  
 Minerals, 7.  
 Minutes, 209  
 Mirrors, 397. 398  
 —, reflection of, 398—401  
 —, plane or flat, 402  
 —, convex, 402  
 —, concave, 402  
 —, axis of, 403  
 —, burning, 409  
 Mædler's central sun, 192  
 Momentum, 66. 115  
 Monsoons, 334.  
 Month, lunar, 244  
 Moon, 167, 168. 176. 243.  
 262  
 Moonlight, 371  
 Motion, 13. 53. 66. 68  
 —, uniform, 57  
 —, perpetual, 59  
 —, retarded, 60  
 —, accelerated, 61  
 —, reflected, 78  
 —, compound, 84—105  
 —, circular, 87. 152  
 —, axis of, 88. 107  
 —, centre of, 88. 107  
 —, diurnal, 163  
 Musical instruments, 348

- N
- Neap-tides, 259  
 Nerves, auditory, 347  
 ———, optic, 375. 379  
 ———, olfactory, 379  
 Night, 163. 222  
 Nodes, 221. 239
- O
- Octave, 349  
 Odour, 10  
 Opaque bodies, 352, 353  
 Optics, 351  
 Orbit, 172
- P
- Pallas, 175  
 Parabola, 96  
 Parallel lines, 37  
 Pellucid bodies, 353  
 Pencil of rays, 356. 462  
 Pendulum, 217  
 Perihelion, 158  
 Perpendicular lines, 38. 79.  
 230  
 Phases, 245  
 Piston, 324  
 Plane, 207  
 Planets, 160. 192  
 Poles, 199. 206  
 Polar star, 222. 250  
 Polarisation of light, 450  
 Pond, 301  
 Porosity, 76  
 Powers, mechanical, 106. 146  
 Projection, 92. 149  
 Precession of the equinoxes,  
 239  
 Prism, 427  
 Pulley, 106. 126  
 Pump, air, 50. 52  
 ———, sucking, or lifting, 323  
 ———, forcing, 327  
 Pupil of the eye, 375
- R
- Rain, 287  
 Rainbow, 433  
 Rarity, 18  
 Ray of light, 353  
 ——— of reflection, 367  
 ——— of incidence, 368  
 Rays, interference of, 457  
 Re-action, 68  
 Receiver, 51  
 Reflection of light, 367  
 ———, angle of, 82  
 ———, of mirrors, 397  
 ———, of plane mirrors,  
 402  
 ———, of convex mirrors,  
 402  
 ———, of concave mirrors  
 402. 407

- Reflected motion, 78  
 Refraction, 414  
     ———, of the atmosphere, 423  
     ———, of glass, 424  
     ———, of a lens, 425  
     ———, of a prism, 427  
 Resistance, 107  
 Retina, 375  
     ———, image on, 378  
 Rivers, 287  
 Rivulets, 294
- S
- Satellites, 168. 249. 252  
 Saturn, 177  
 Scales or balance, 107  
 Screw, 106. 140  
 Shadow, 247. 359. 363  
 Sidereal time, 238  
 Sight, 379  
 Signs of zodiac, 193. 208. 210  
 Siphon, 297  
 Smoke, 11. 46  
 Solar microscope, 471  
 Solstice, 221. 223  
 Sound, 338  
     ———, acute, 348  
     ———, musical, 347  
 Space, 55  
 Specific gravity, 275  
     ——— of air, 317  
 Spectrum, 429
- Speaking trumpet, 346  
 Sphere, 38. 99. 214  
 Springs, 293  
 Spring-tides, 259  
 Square, 85. 169. 186  
 Stars, fixed, 161. 192. 237. 250  
 Steam, 46  
 Steelyard, 112  
 Storms, 331  
 Substance, 3  
 Summer, 158. 221  
 Sun, 148. 169. 354. 422  
 Sunbeam, 356  
 Swimming, 73
- T
- Tangent, 91. 152  
 Telescope, 476  
     ———, reflecting, 476  
     ———, refracting, 476  
     ———, achromatic, 477  
 Temperate zone, 208. 224  
 Thermometer, 322  
 Tides, 254  
     ——, neap, 259  
     ——, spring, 259  
     ——, aërial, 337  
 Time, 236—241  
     ——, sidereal, 238  
     ——, equal, 241  
     ——, solar, 240  
 Tone, 347—350  
 Torrid zone, 208. 213. 331

Transparent bodies, 353  
 Treble and bass, 348  
 • Tropics, 207

## V

Valve, 324  
 Vapour, 20. 47. 287  
 Velocity, 55. 114  
 Venus, 174. 254  
 Vesta, 175  
 Vibration, 342  
 Vision, 386  
 —, angle of, 387  
 —, double, 395

## U

Undulations, 343  
 Unison, 349  
 Uranus, 177

## W

Water, 265

Water, spring, 293  
 —, rain, 293  
 —, level of, 267—275  
 Wedge, 106. 137  
 Weight, 18. 32. 214. 276.  
 310—314  
 Wheel and axle, 106. 134  
 Wind, 330  
 —, trade, 332  
 —, periodical, 334  
 Winch, 139  
 Winter, 158. 223

## Y

Year, 236  
 —, sidereal, 238  
 —, solar, 240

## Z

Zodiac, 193. 208. 210  
 Zone, 208  
 —, frigid, 208. 223  
 —, torrid, 208. 224. 331. 422  
 —, temperate, 208. 224

LONDON :  
SPOTTISWOODES and SHAW,  
New-street-Square.







