



始



ILLUSTRATED
PARTS CATALOGUE

FOR
**FAMILY AND INDUSTRIAL
MACHINES**

シ ン ガ ー 部 分 品
型 録

SINGER SEWING MACHINE COMPANY

特 210
410



ILLUSTRATED
PARTS CATALOGUE
FOR
FAMILY AND INDUSTRIAL
MACHINES

シンガー部分品
型 録



SINGER SEWING MACHINE COMPANY

Copyright, 1937
 By
Singer Sewing Machine Co.,
 YOKOHAMA, JAPAN.
 (Copyright in Japan and in all countries subscribing
 to the BERNE CONVENTION.)

Index of Illustrations 圖解目次

	自	至
	圖	圖
15K81, 15K83, 15K84 and 15K85 十五種K八十一、十五種K八十三、十五種K八十四及 十五種K八十五型	{ 1 21	9
15K88 and 15K90 十五種K八十八及十五種K九十型	10	21
Family and Industrial Machine Attachments and Accessories... 家庭用並=職業用ミシン附屬具及小道具	22	31
15K28 十五種K二十八型	{ 32 76	40
16K33 十六種K三十三型	{ 37 76	45
17 - 1 十七種一型	46	49
18 - 22 十八種二十二型	50	56
29K58 and 29K60 二十九種K五十八型及二十九種K六十型	57	66
31K20 and 44K13 三十一種K二十型及四十四種K十三型	67	78
32 - 1 三十二種一型	{ 76 79	86
103D10 百三種D十型	87	98
B. R. K. Motor ビー、アール、ケー、モーター	99	106
Cabinet Work and Fittings 木製品及之レ=附屬スル金具類	107	118
Stand Parts 脚部部分品	119	129
15K26, 15K70, 18-2, 27, 28, 29K51, 29K55, 31K22, 66, 103K Machines, Stands, B. U. K. Motor and 20 Machine 十五種K二十六、十五種K七十、十八種二型、二十七種 二十八種、二十九種K五十一、二十九種K五十五、三十一種K 二十二型、六十六種、百三種K、各種脚部並=、ビー、ユー、 ケー、モーター及二十番ミシン	130	145
K. A. 2151, 2160, 2161 Motors ケー、エー、二一五一、二一六〇、二一六一、モーター	146	151

NOTE:—Index of Parts precedes illustrations for each class of machines.

注 意一部分品番號ノ見出ハミシンノ種類毎=別=之ヲ掲ゲ

ILLUSTRATION OF PARTS



十五種 K 八十一型
十五種 K 八十三型
十五種 K 八十四型
十五種 K 八十五型

ミ
シ
ン
部
分
品
圖
解

15K81, 15K83, 15K84, 15K85

部分品 番 號	圖解番號	部分品 番 號	圖解番號	部分品 番 號	圖解番號	部分品 番 號	圖解番號
Parts No.	Plate No.	Parts No.	Plate No.	Parts No.	Plate No.	Parts No.	Plate No.
138	1	1285	3	8394	9	45846	21
145	5	1293	7	8399	4	45847	21
155	4	1381	4	8439	7	50291	6
157	3	1498	4	8505	6	50292	6
158	21	1518	2	8879	1	50353	2
183	8	1519	2	9544	21	50527	3
190	6	1520	4	10106	21	51002	4
190	21	1560	6	13710	6	51045	3
193	21	1813	3	15027	5	51224	1
208	7	1822	3	15072	21	"	7
208	21	2002	1	15140	5	51225	2
248	1	2007	1	15141	5	51228	4
251	4	2020	1	15147	7	51229	5
256	1	2022	2	15170	3	51246	3
315	2	2052	4	15238	6	51282	7
375	2	2054	4	15248	4	51303	21
399	8	2068	4	15272	7	51319	21
435	1	2070	4	15277	5	55621	4
448	4	2102	6	15278	5	55645	6
453	4	2509	3	15279	7	66601	21
462	2	2510	3	15282	2	66670	21
"	3	2515	5	15287	21	66752	4
"	5	2518	5	15288	21	66775	21
552	4	2523	5	15297	3	80028	9
S.S. 565	9	2528	5	15313	2	80314	2
S.S. 566	8	2530	5	15395	6	80316	3
S.S. 567	9	2531	5	15410	6	80317	3
570	4	2532	5	15412	6	80318	2
591	5	2535	5	15427	1	80319	4
592	5	2816	3	15428	6	94002	8
S.S. 599	8	2824	7	15432	6	94016	8
S.S. 600	9	2827	6	15477	7	94027	8
648	5	2835	2	15486	4	94028	9
659	8	2973	5	15491	3	94029	9
660	9	2974	5	15497	1	94030	9
662	5	2975	5	15498	1	94031	9
691	7	7071	21	26075	6	94032	9
857	6	8217	2	32572	6	94033	9
896	2	8280	9	32672	2	94034	9
1085	4	8282	9	45845	21	94035	9

15K81, 15K83, 15K84, 15K85

部分品 番 號	圖解番號	部分品 番 號	圖解番號	部分品 番 號	圖解番號	部分品 番 號	圖解番號
Parts No.	Plate No.	Parts No.	Plate No.	Parts No.	Plate No.	Parts No.	Plate No.
94036	9	125327	21				
94037	9	125342	21				
94038	9	125375	21				
94039	9	125376	21				
94040	9	125395	21				
94042	8	140138	21				
94043	8						
94044	9						
94045	8						
94046	9						
94047	8						
94048	9						
94049	8						
120842	7						
125021	2						
125029	7						
125036	2						
125038	1						
125039	1						
125041	1						
125042	1						
125046	4						
125047	4						
125048	3						
125049	3						
125050	2						
125052	4						
125055	3						
125059	3						
125060	3						
125061	4						
125064	5						
125065	5						
125068	21						
125078	4						
125079	4						
125080	5						
125095	4						
125324	21						
125326	21						

第一圖

15K81, 15K83
15K84, 15K85

PLATE 1

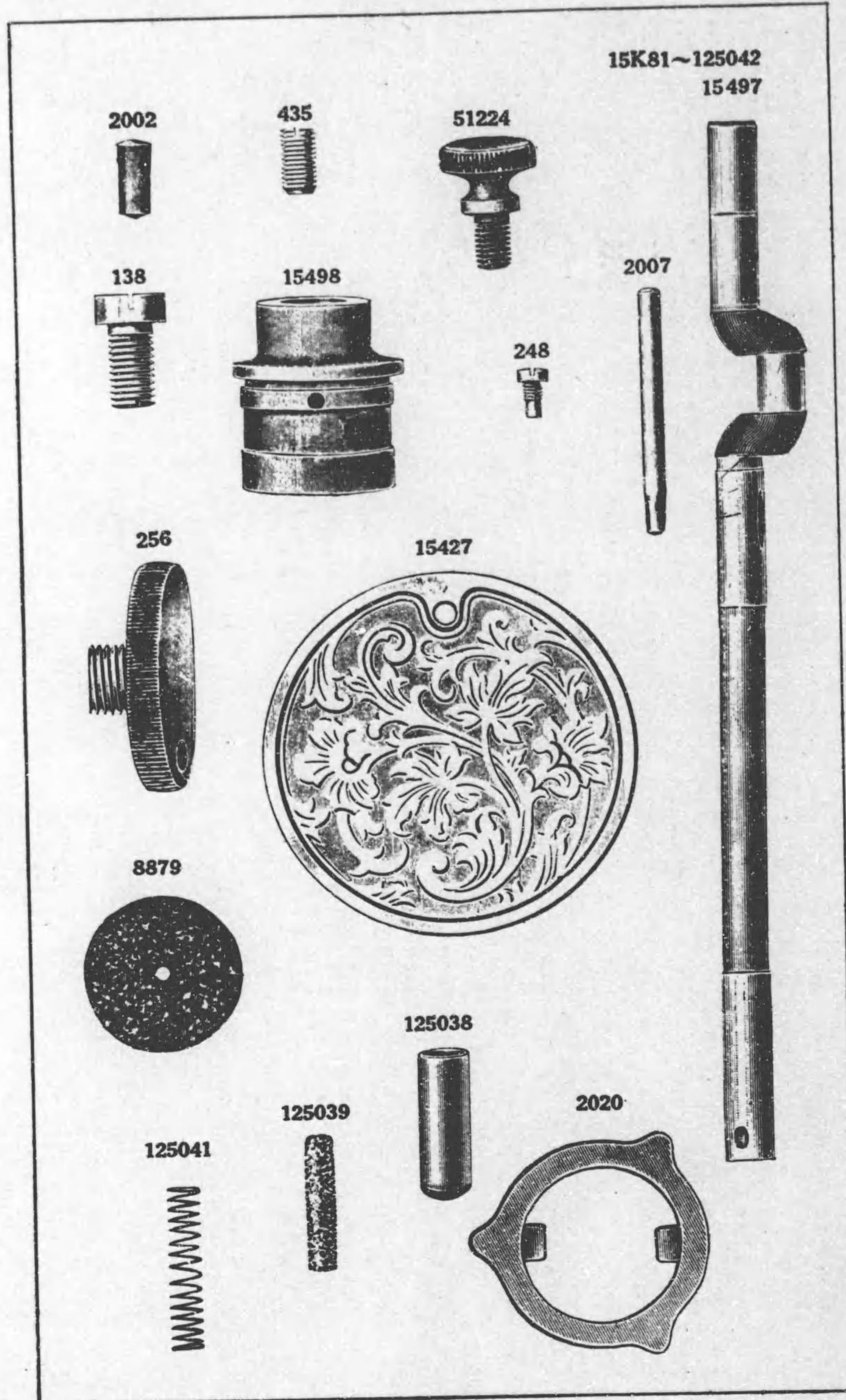
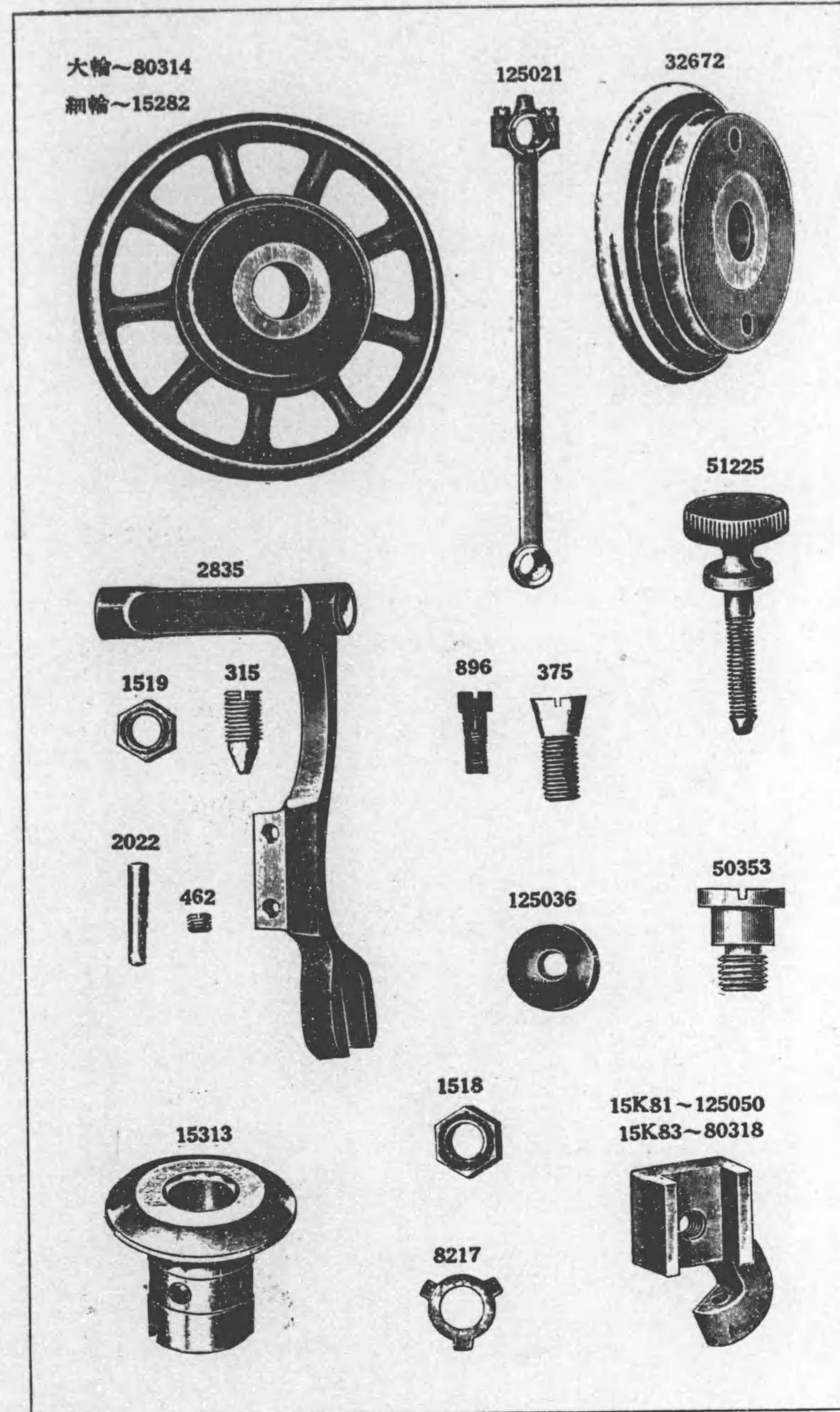

PLATE 2

15K81, 15K83
15K84, 15K85

第二圖



第三圖

15K81, 15K83
15K84, 15K85

PLATE 3

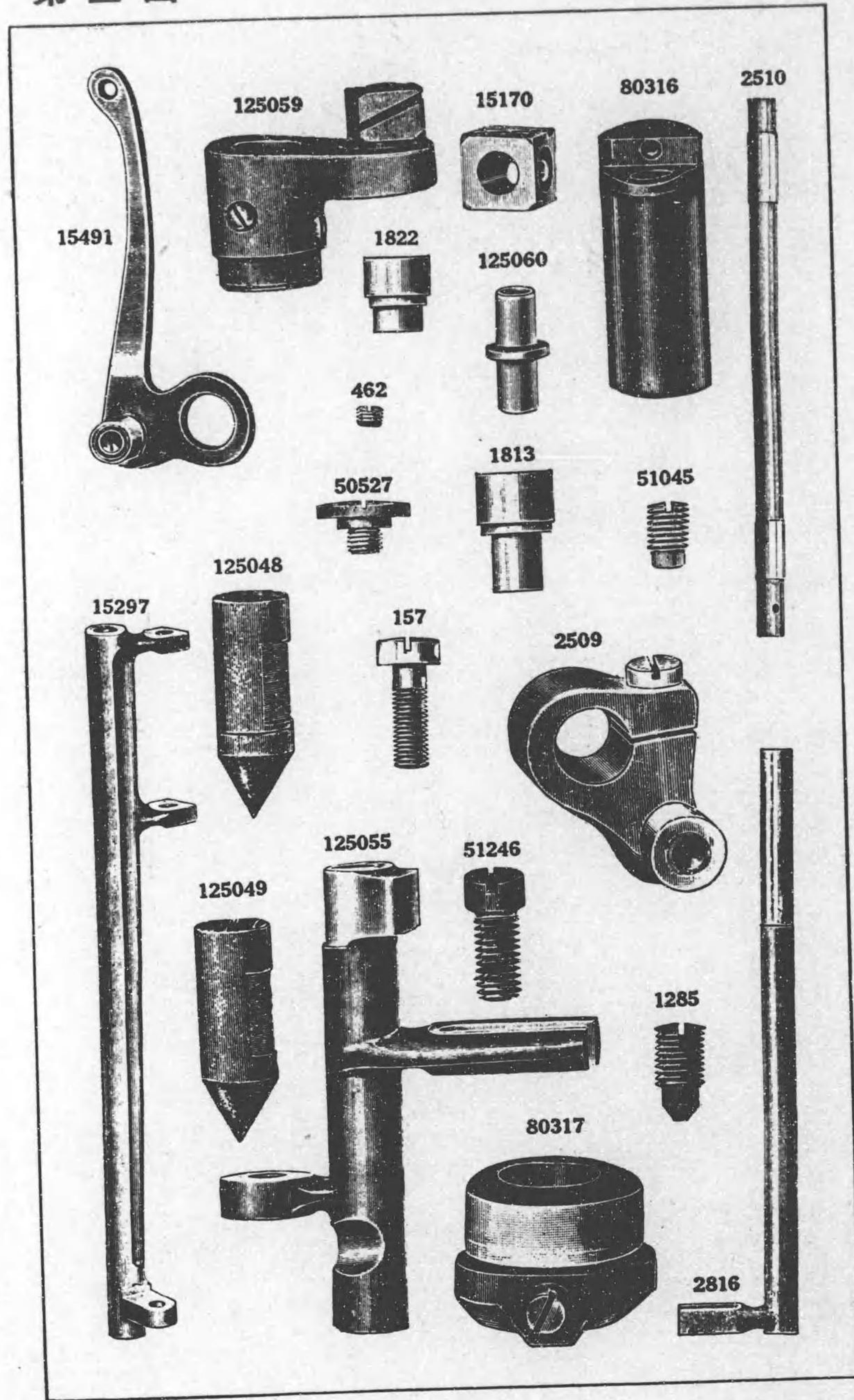
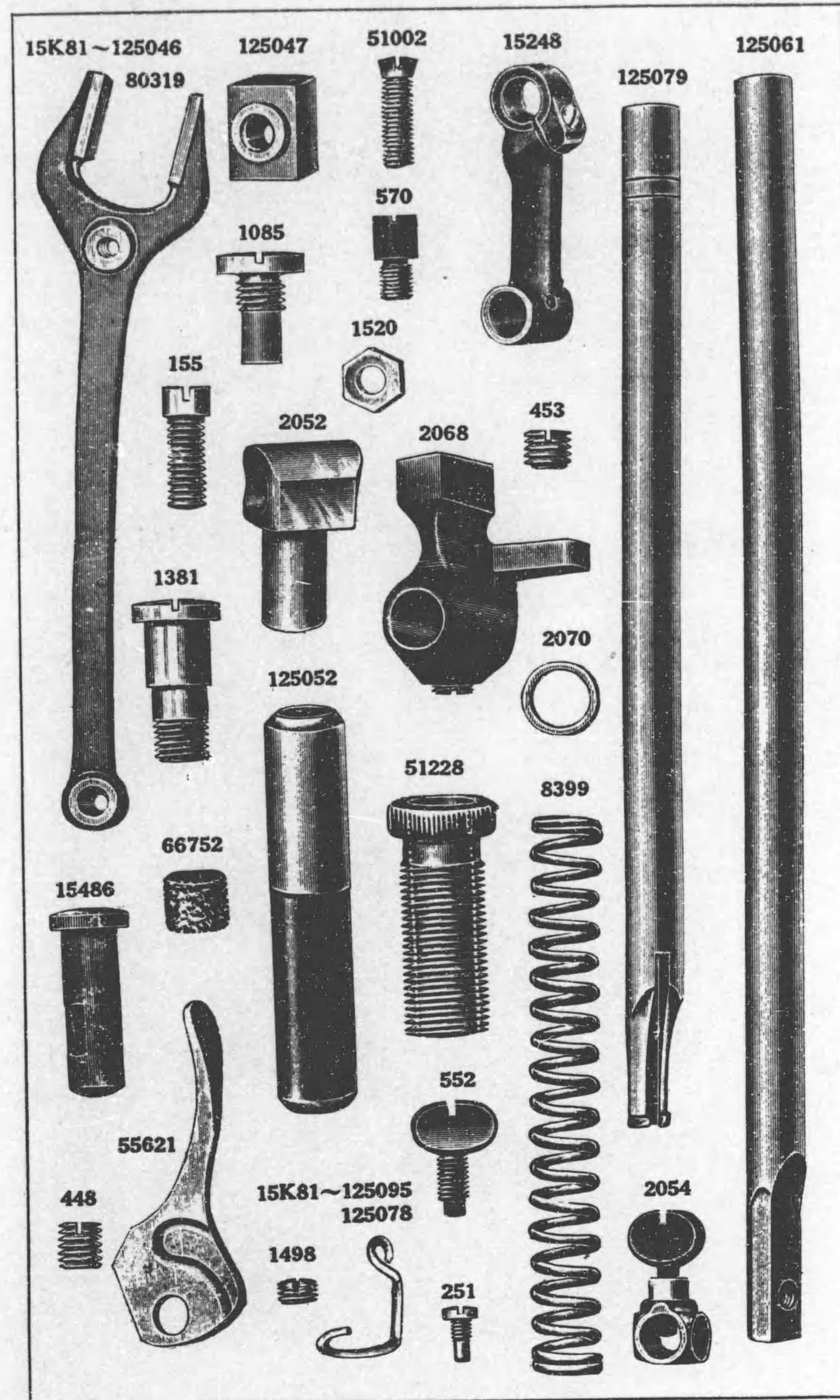

PLATE 4

15K81, 15K83
15K84, 15K85

第四圖



第五圖

15K81, 15K83
15K84, 15K85

PLATE 5

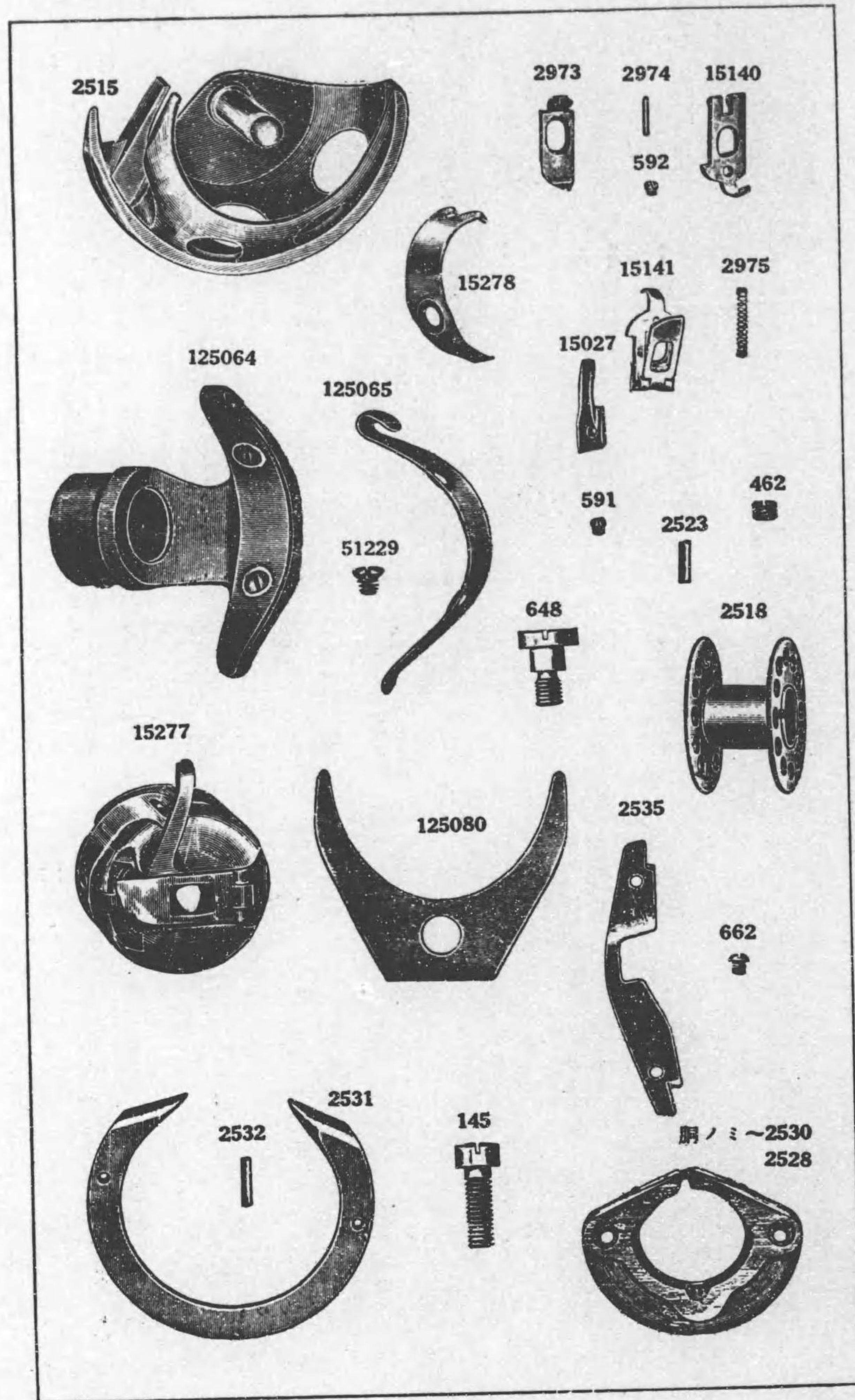
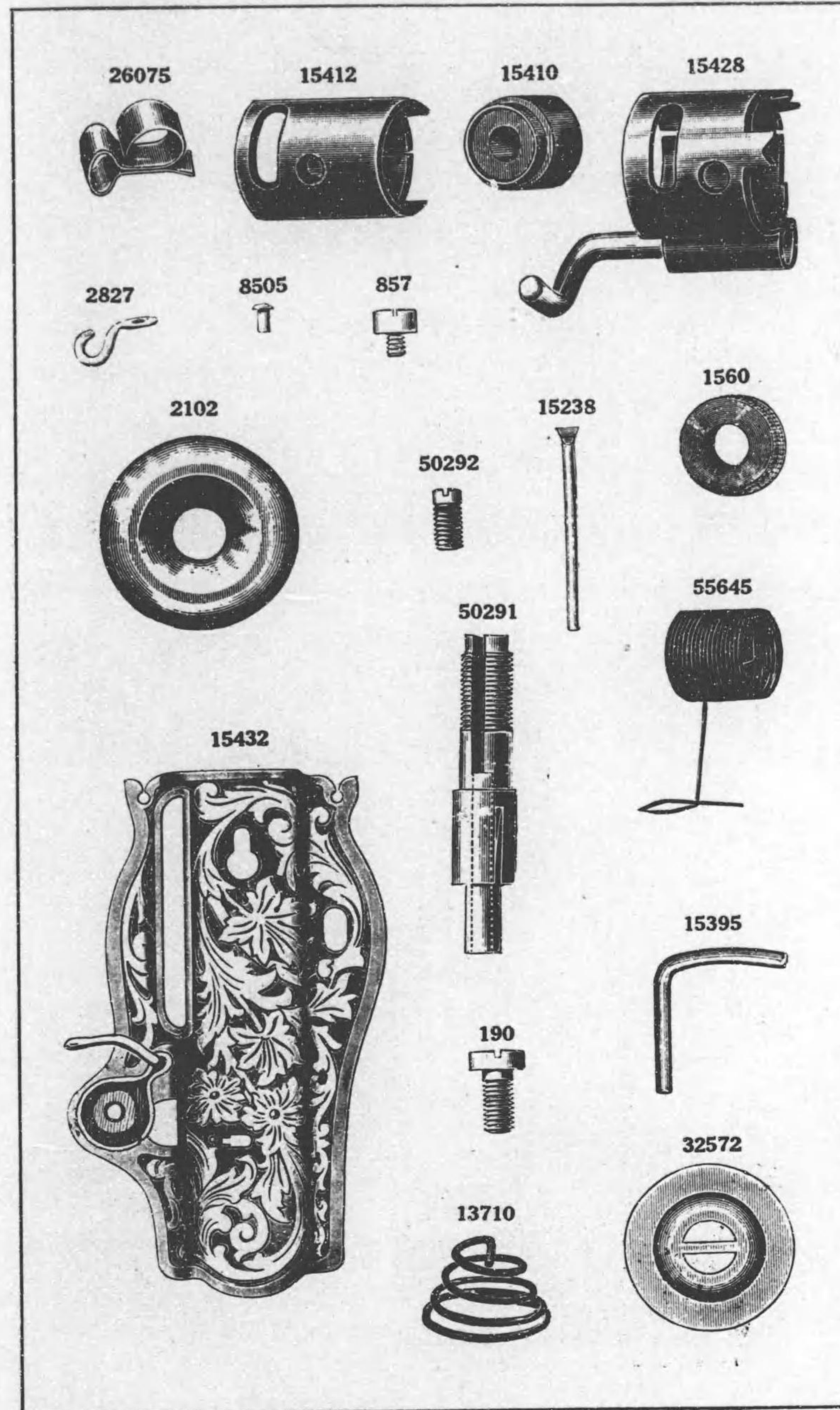

PLATE 6

15K81, 15K83
15K84, 15K85

第六圖



第七圖

15K81, 15K83
15K84, 15K85

PLATE 7

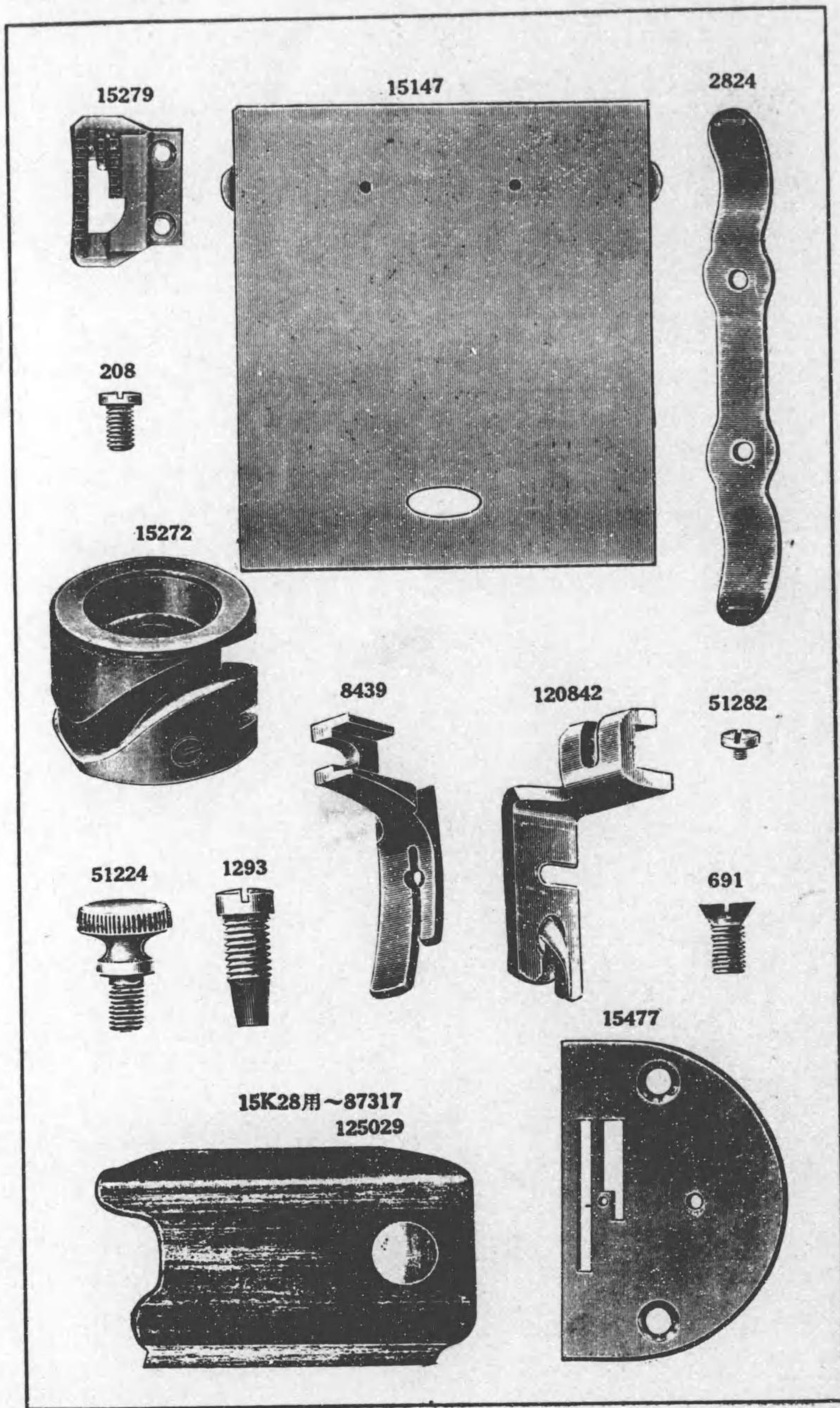
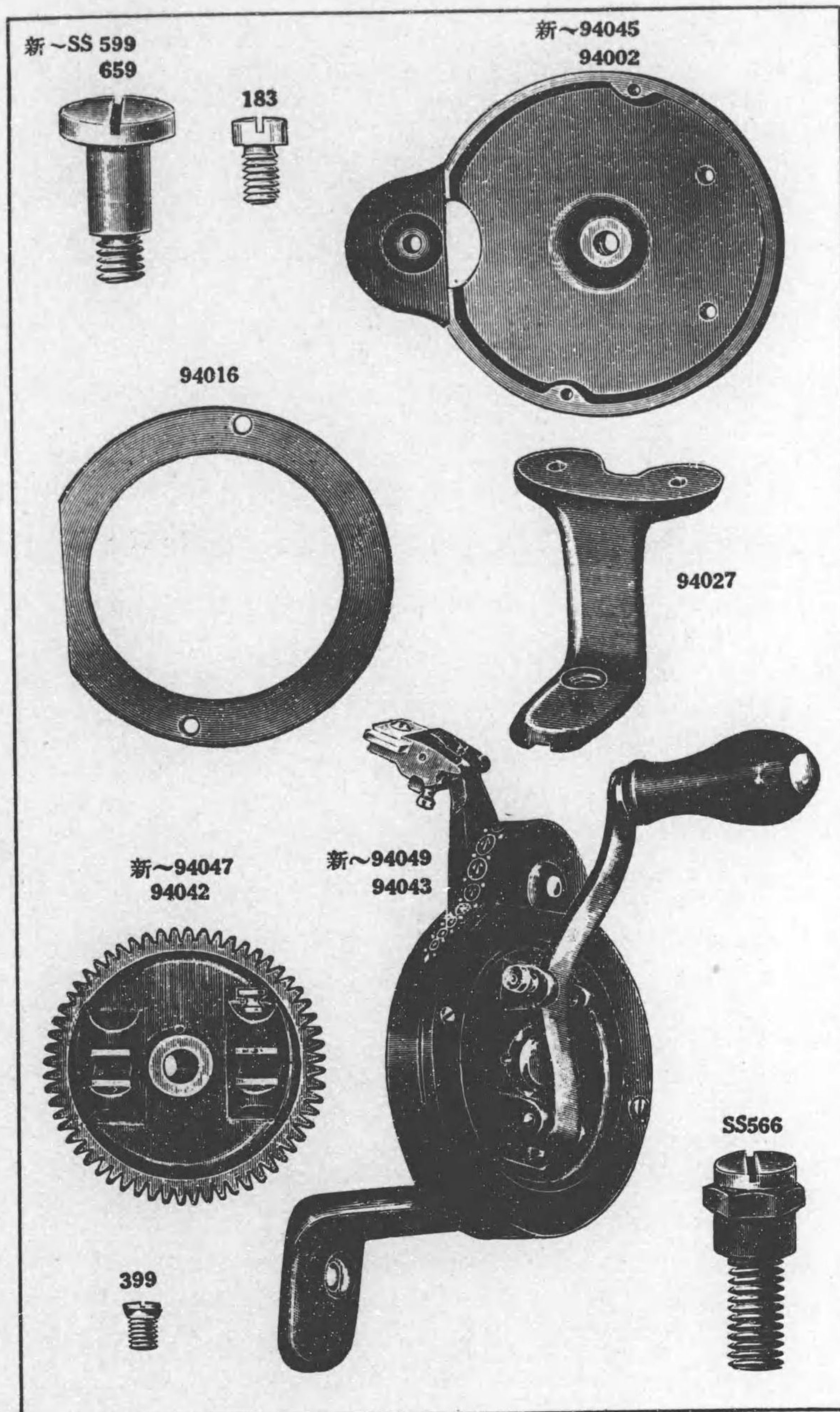

PLATE 8

15K81, 15K84

第八圖



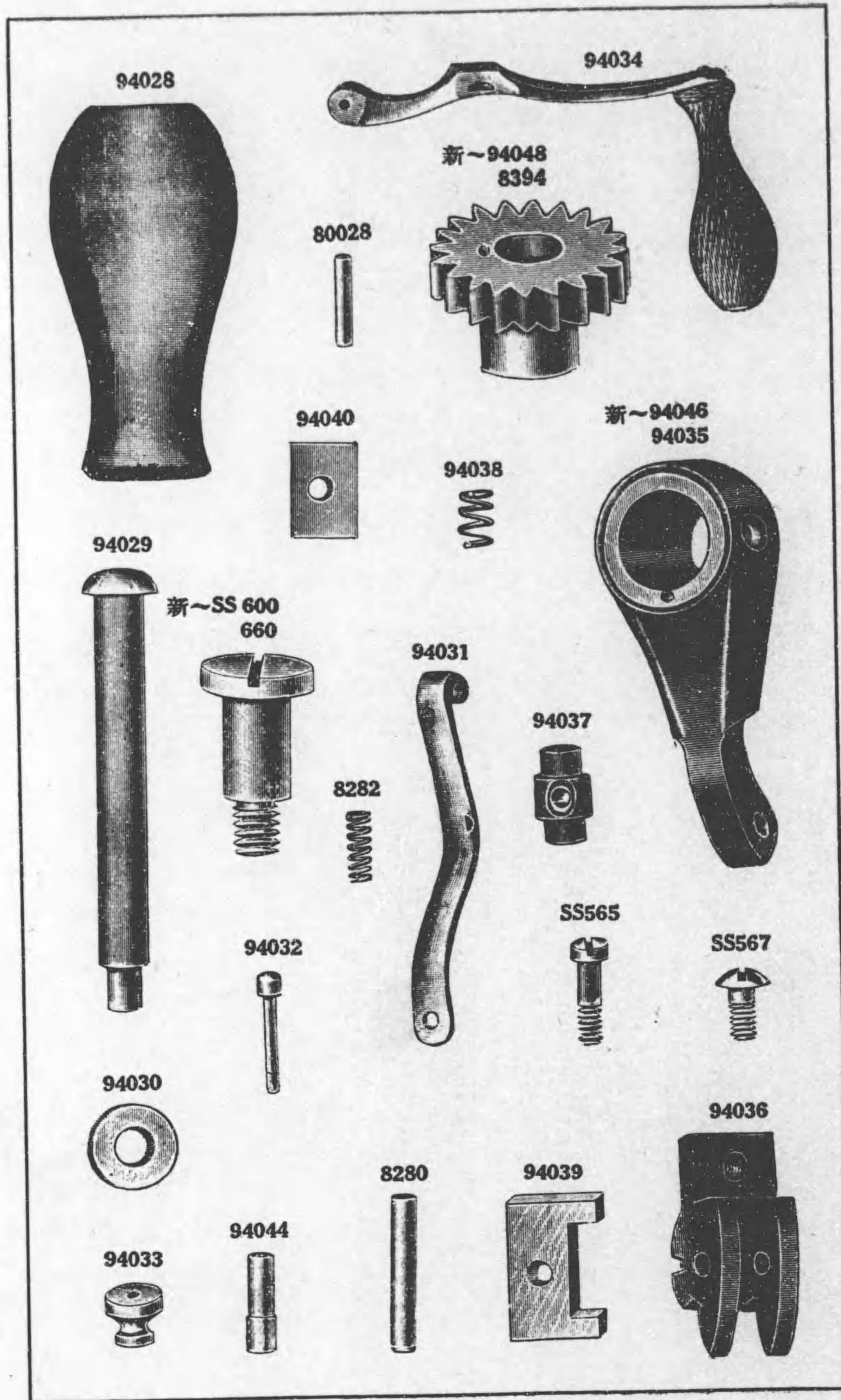

ILLUSTRATION OF PARTS

CLASS

15K88, 15K90

MACHINES

十五種 K 八十八型
十五種 K 九十型

ミ
シ
ン
部
分
品
圖
解

15K88, 15K90

部分品 番 號	圖解番號	部分品 番 號	圖解番號	部分品 番 號	圖解番號	部分品 番 號	圖解番號
Parts No.	Plate No.	Parts No.	Plate No.	Parts No.	Plate No.	Parts No.	Plate No.
138	10	1813	19	45310	13	125061	15
145	17	1822	12	45321	20	125068	21
157	12	2002	10	45845	21	125253	10
158	21	2007	10	45846	21	125258	19
175	14	2020	10	45847	21	125261	20
190	19	2022	11	50292	18	125262	14
"	21	2049	12	50353	11	125263	12
193	21	"	16	50527	12	125268	11
208	20	2068	15	51002	14	125270	12
"	21	2070	15	51224	10	125272	14
248	10	2102	18	"	20	125274	14
256	10	2518	16	51228	15	125276	14
304	12	2523	16	51229	16	125280	13
315	11	2835	11	51246	13	125281	12
335	13	2974	16	51252	14	125283	12
375	11	2975	16	51256	14	125285	20
391	16	7071	21	51257	18	125287	16
435	10	8217	11	51261	17	125288	16
448	15	8399	15	51282	15	125289	16
453	15	8879	10	51289	19	125290	16
462	11	9544	21	51303	21	125291	16
"	12	10106	21	51308	14	125292	16
570	14	15072	21	51312	13	125293	16
591	16	15170	12	51319	21	125295	16
592	16	15248	14	51608	18	125298	16
662	17	15272	19	55621	15	125299	17
691	20	15282	11	66601	21	125301	17
857	18	15287	21	66670	21	125302	17
896	11	15288	21	66752	15	125303	17
1085	14	15313	11	66775	21	125305	17
1253	16	15410	18	120855	20	125306	17
1285	12	15486	15	120914	20	125310	18
1293	19	15498	10	125021	11	125311	18
1341	14	26075	19	125044	11	125312	18
1498	14	32519	14	125045	12	125313	18
1513	12	32672	11	125047	14	125314	18
1518	11	45285	14	125048	13	125316	18
1519	11	45305	11	125049	13	125317	18
1520	14	45306	13	125056	13	125318	18
1550	11	45308	13	125060	12	125319	20

15K88, 15K90

部分品 番 號	圖解番號	部分品 番 號	圖解番號	部分品 番 號	圖解番號	部分品 番 號	圖解番號
Parts No.	Plate No.	Parts No.	Plate No.	Parts No.	Plate No.	Parts No.	Plate No.
125320	16						
125322	16						
125324	21						
125326	21						
125327	21						
125331	10						
125333	10						
125334	10						
125336	15						
125337	15						
125338	15						
125339	10						
125342	21						
125349	19						
125367	19						
125369	19						
125370	19						
125373	19						
125375	21						
125376	21						
125377	14						
125378	14						
125382	12						
125386	19						
125387	19						
125388	12						
125395	21						
140138	21						

第十圖

15K88, 15K90

PLATE 10

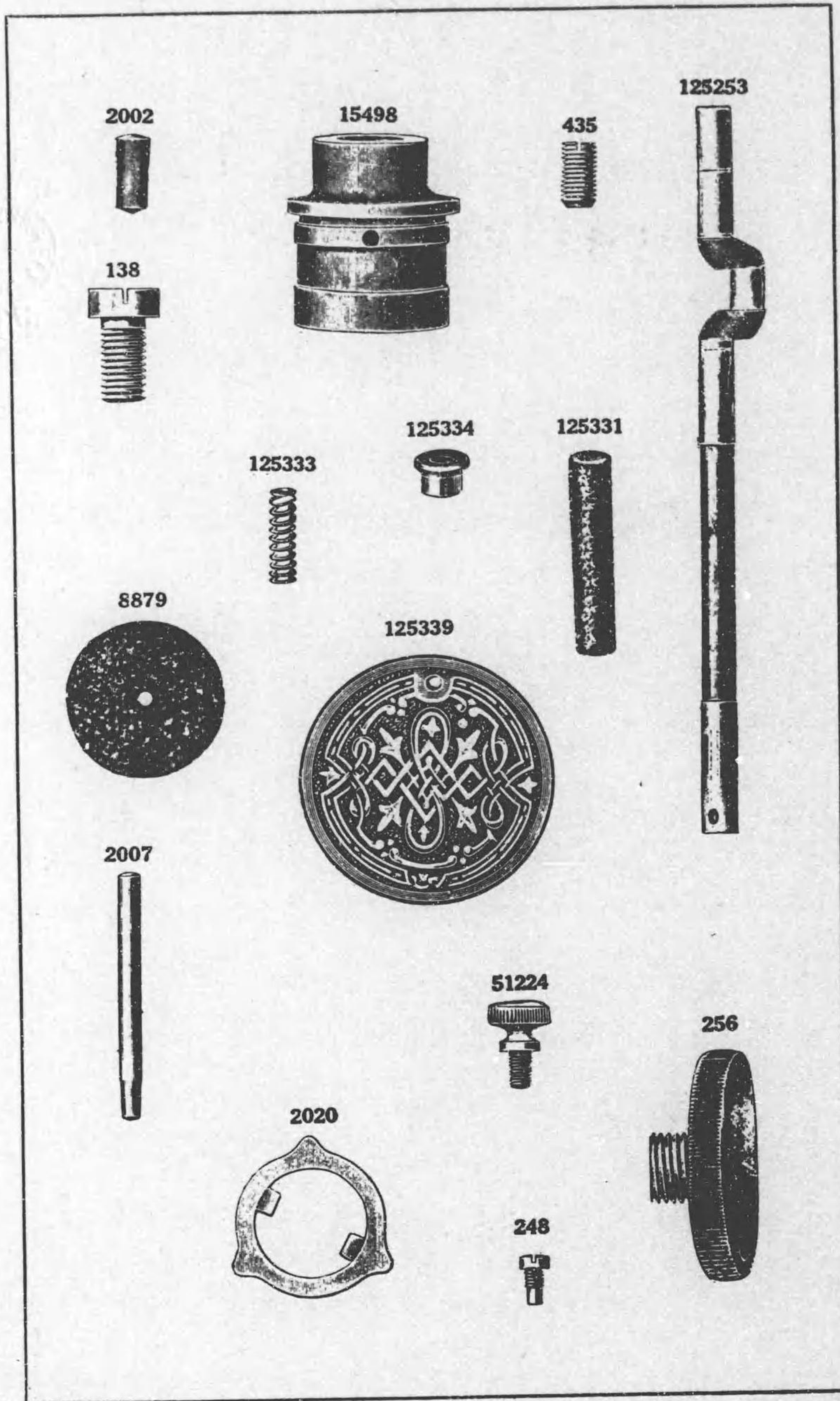
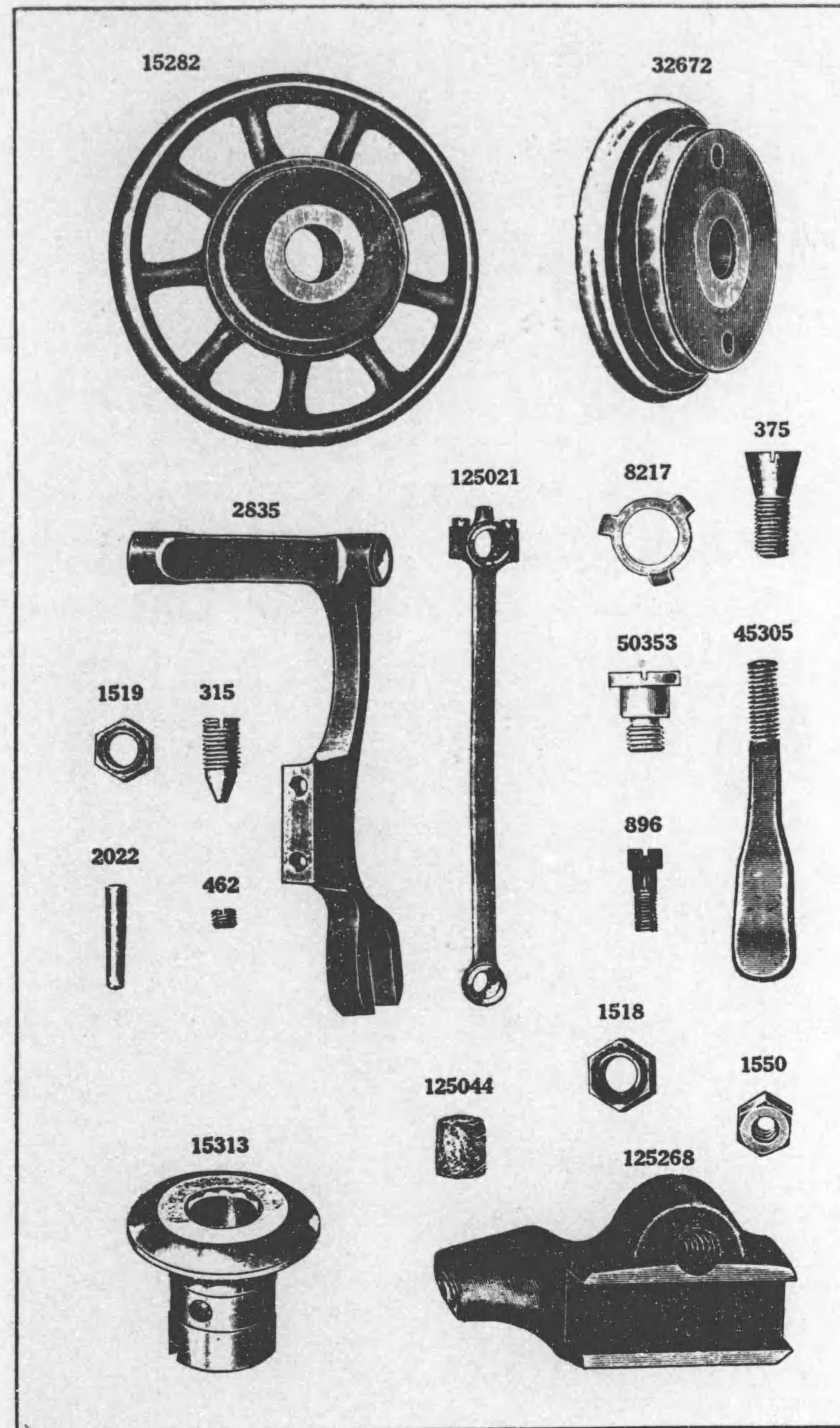

PLATE 11

15K88, 15K90

第十一圖



第十二圖

15K88, 15K90

PLATE 12

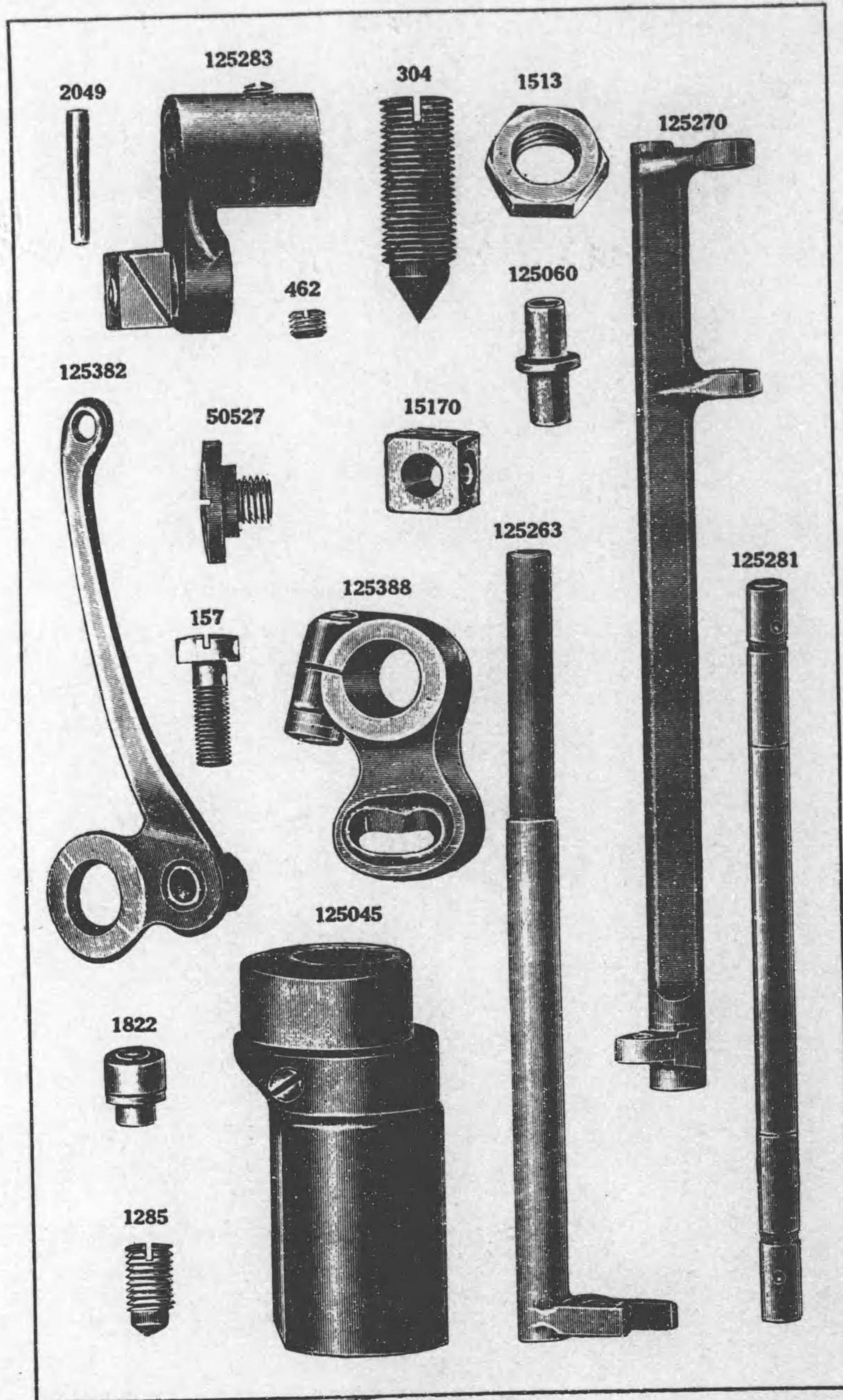
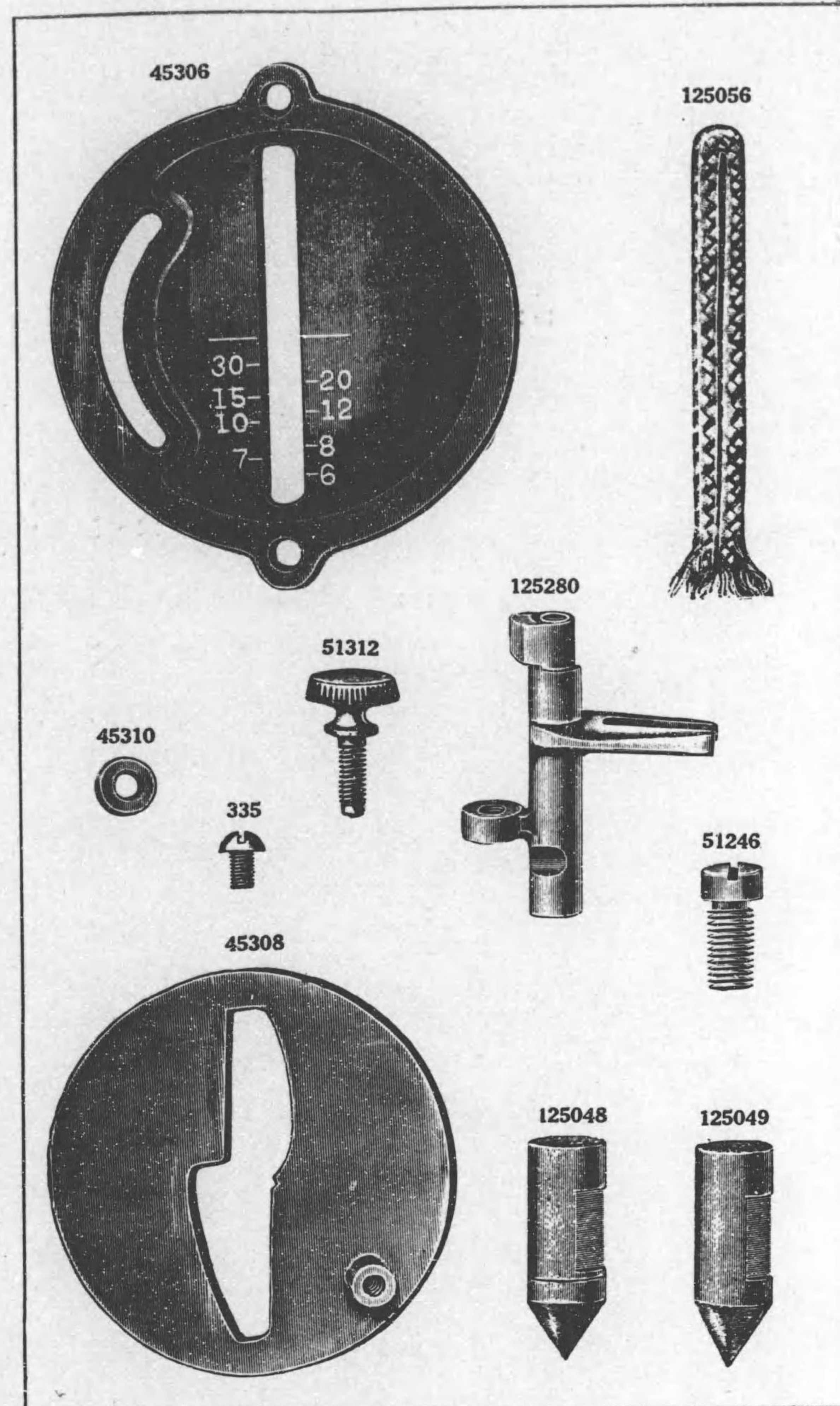

PLATE 13

15K88, 15K90

第十三圖



第十四圖

15K88, 15K90

PLATE 14

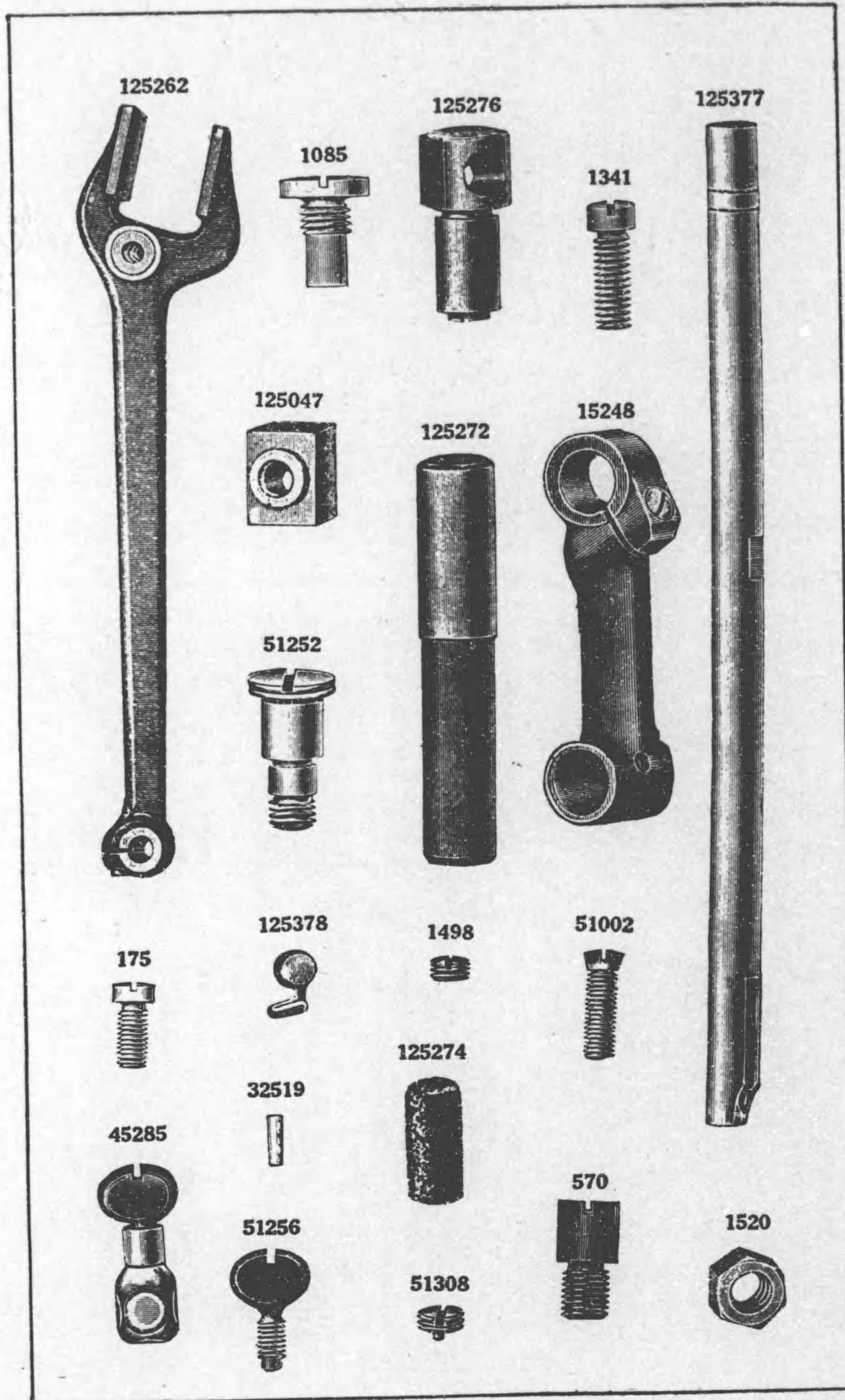
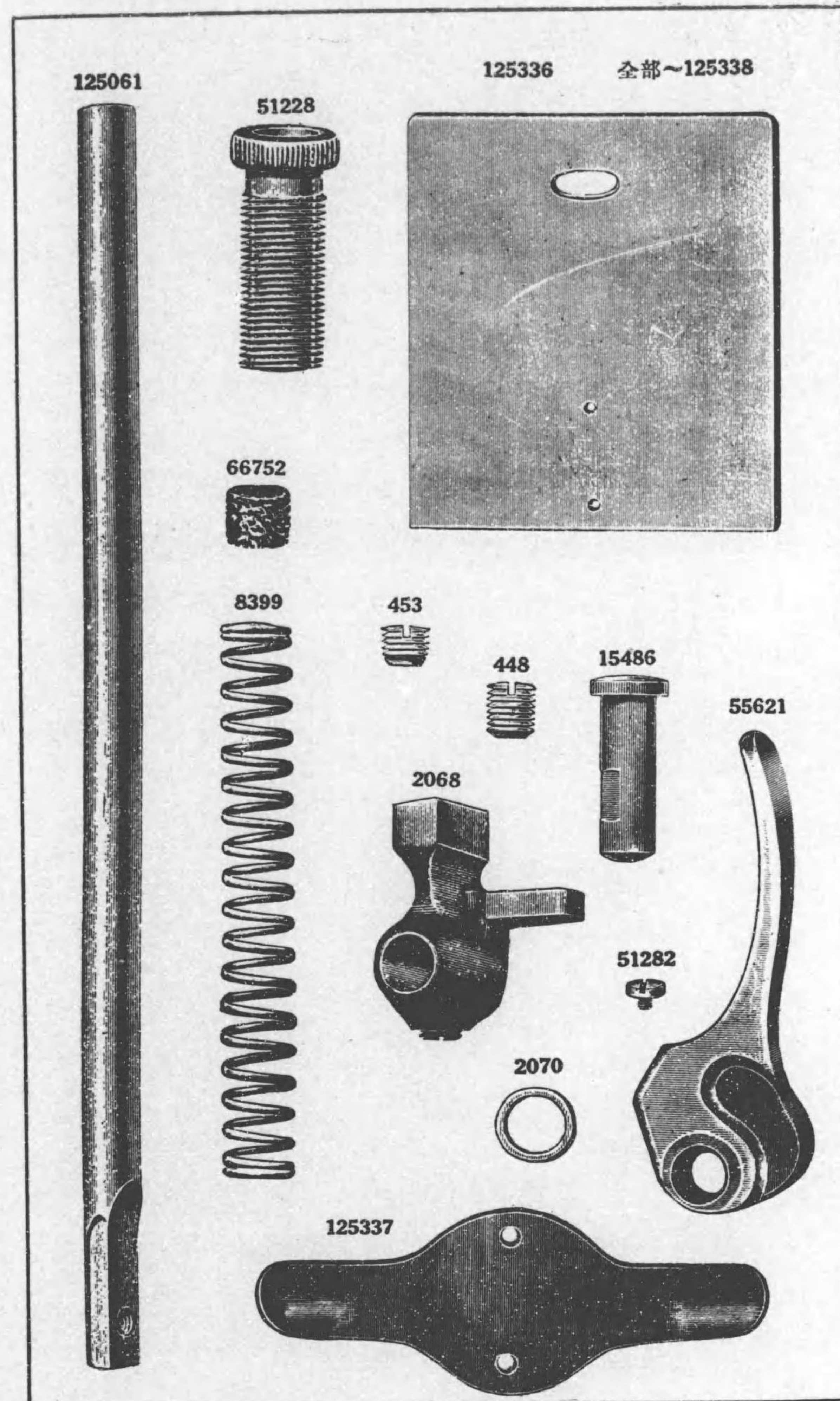

PLATE 15

15K88, 15K90

第十五圖



第十六圖

15K88, 15K90

PLATE 16

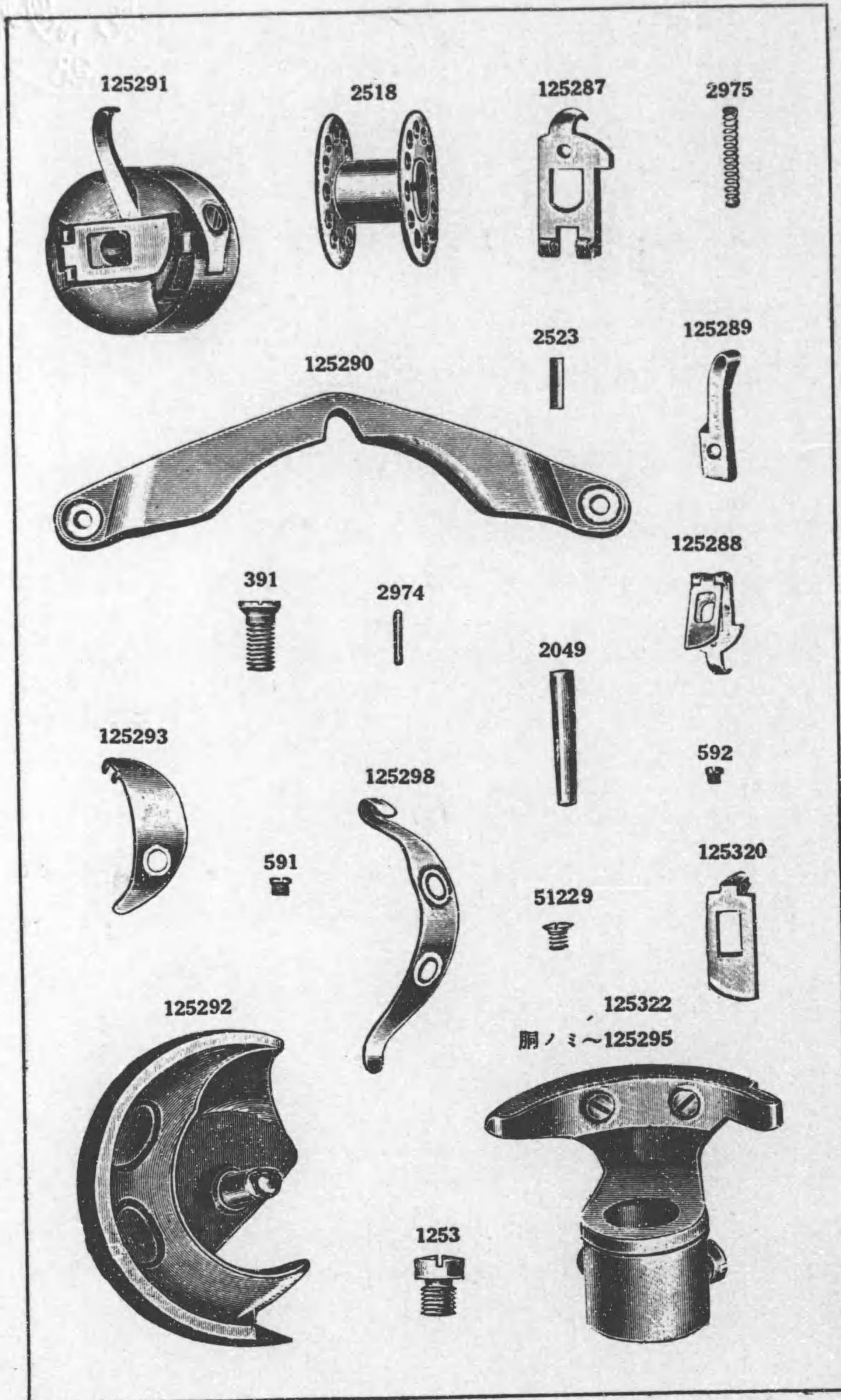
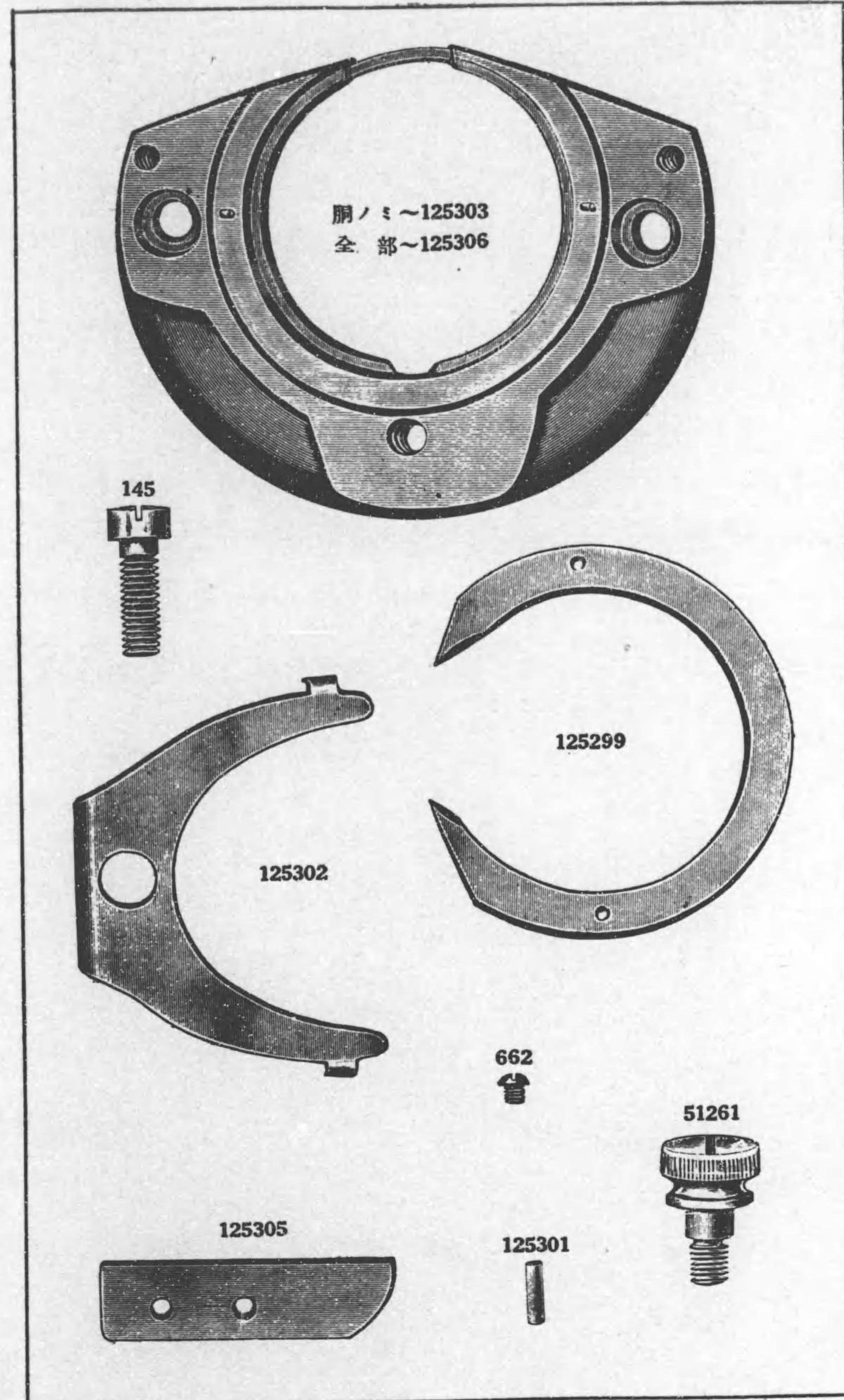

PLATE 17

15K88, 15K90

第十七圖



第十八圖

15K88, 15K90

PLATE 18

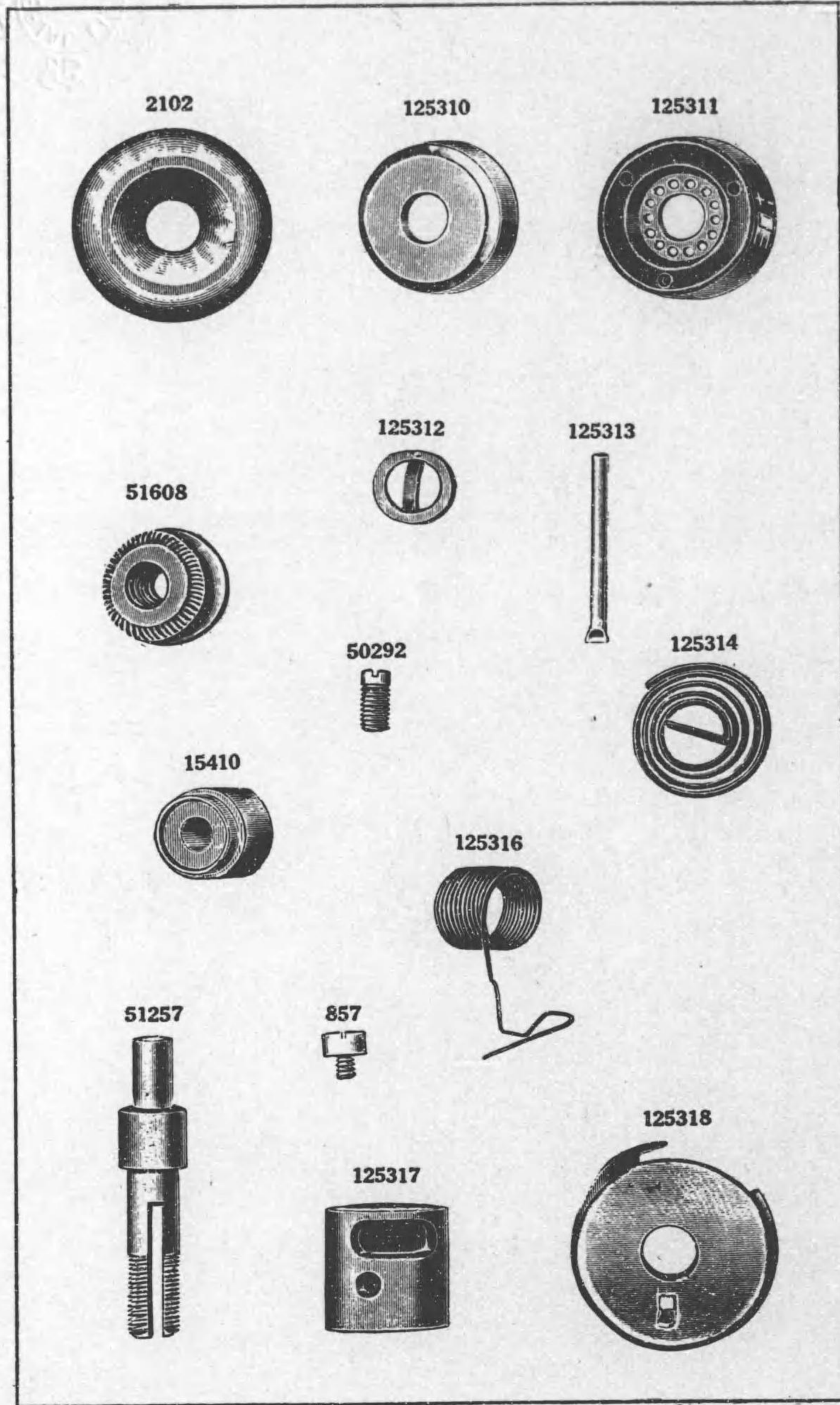
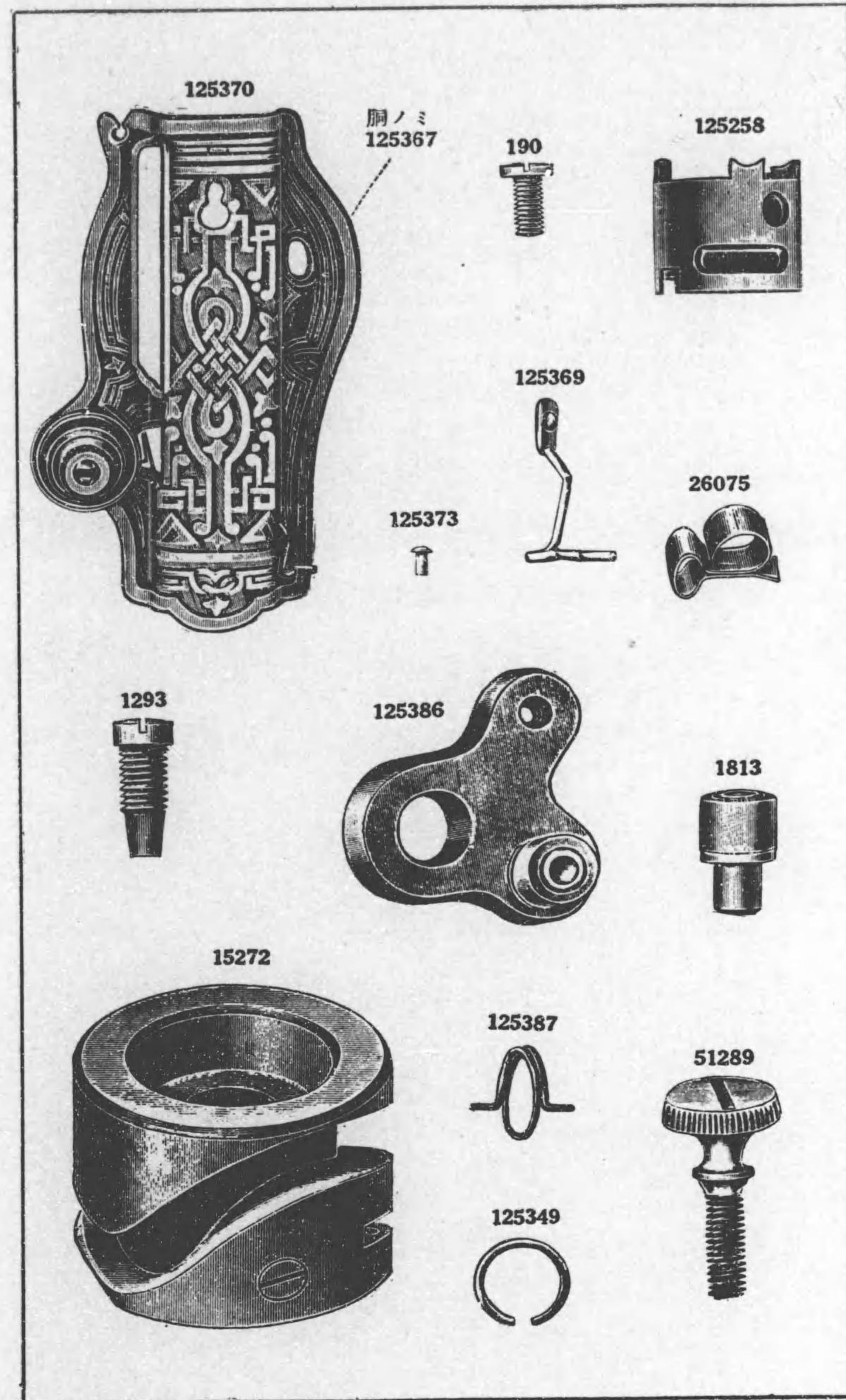

PLATE 19

15K88, 15K90

第十九圖



第二十圖

15K88, 15K90

PLATE 20

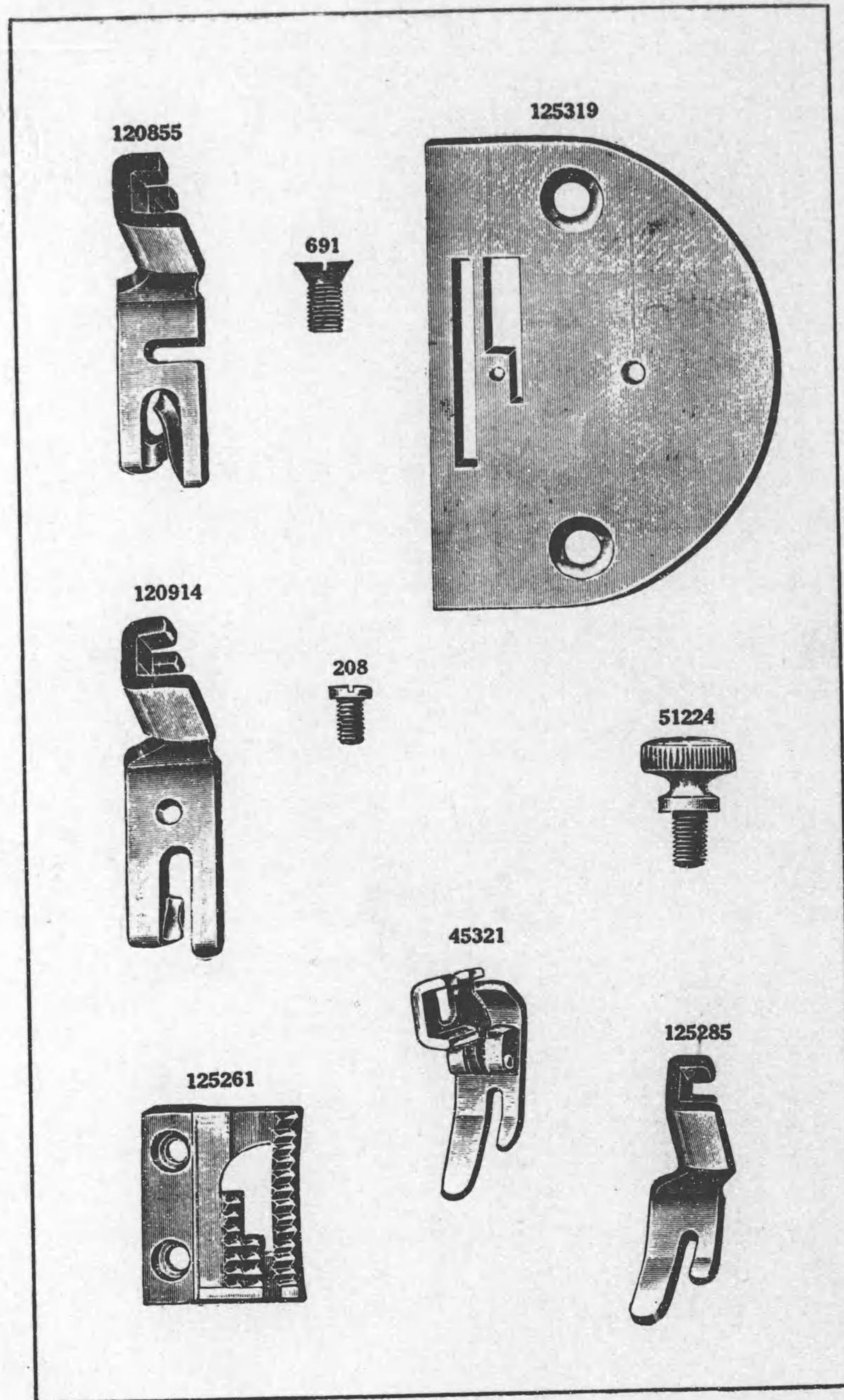

PLATE 21

15K81, 15K83, 15K84
15K85, 15K88, 15K90

第二十一圖

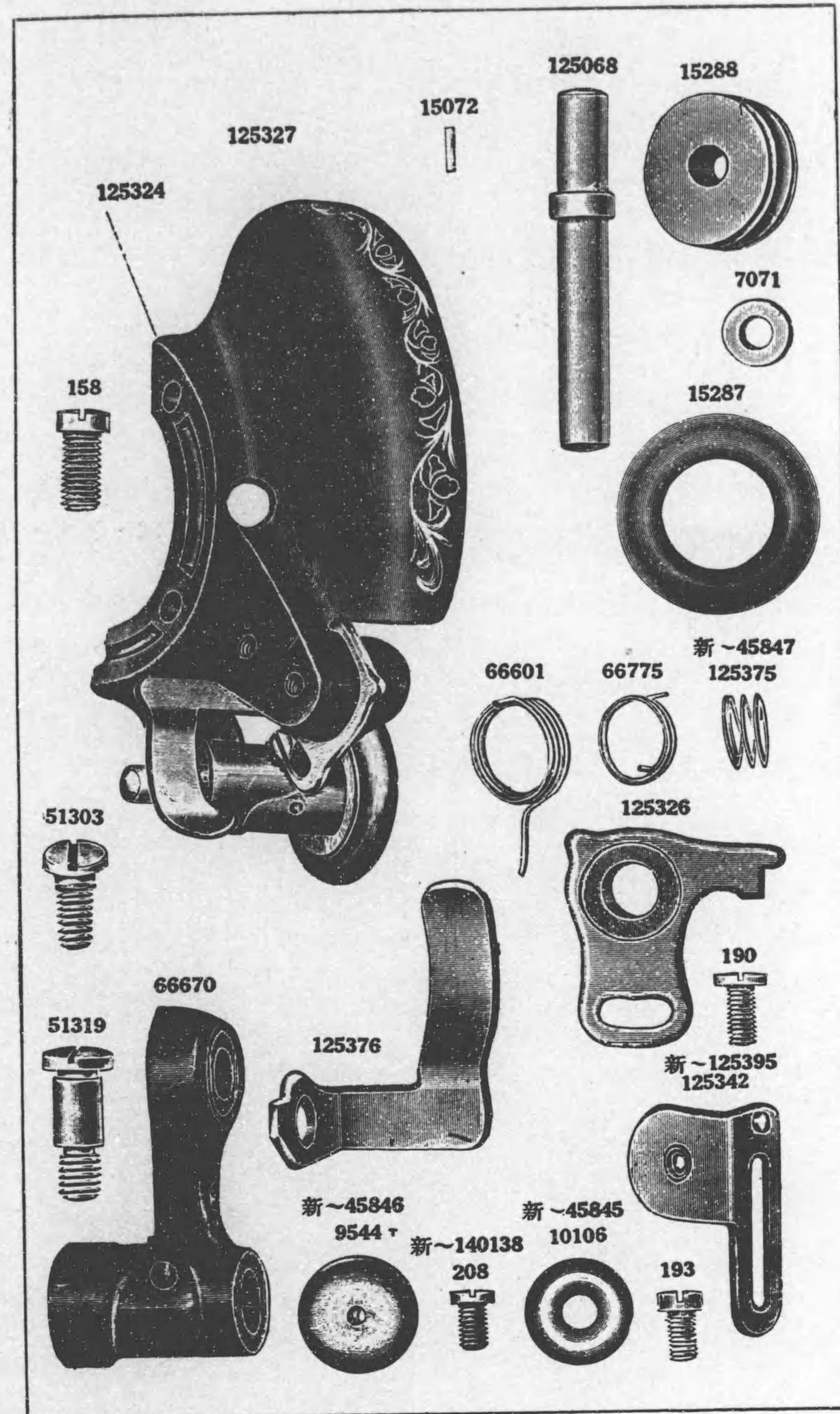
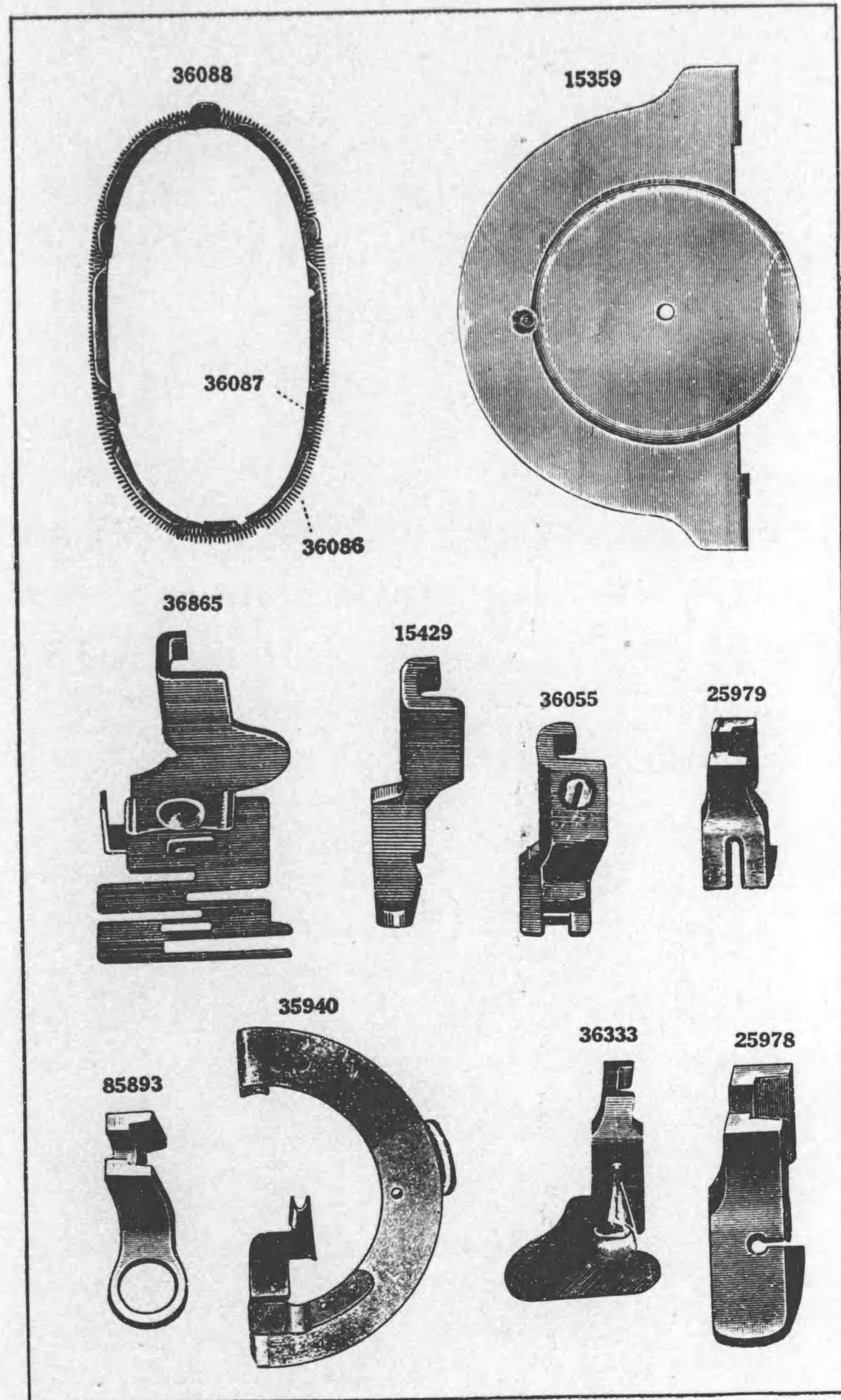
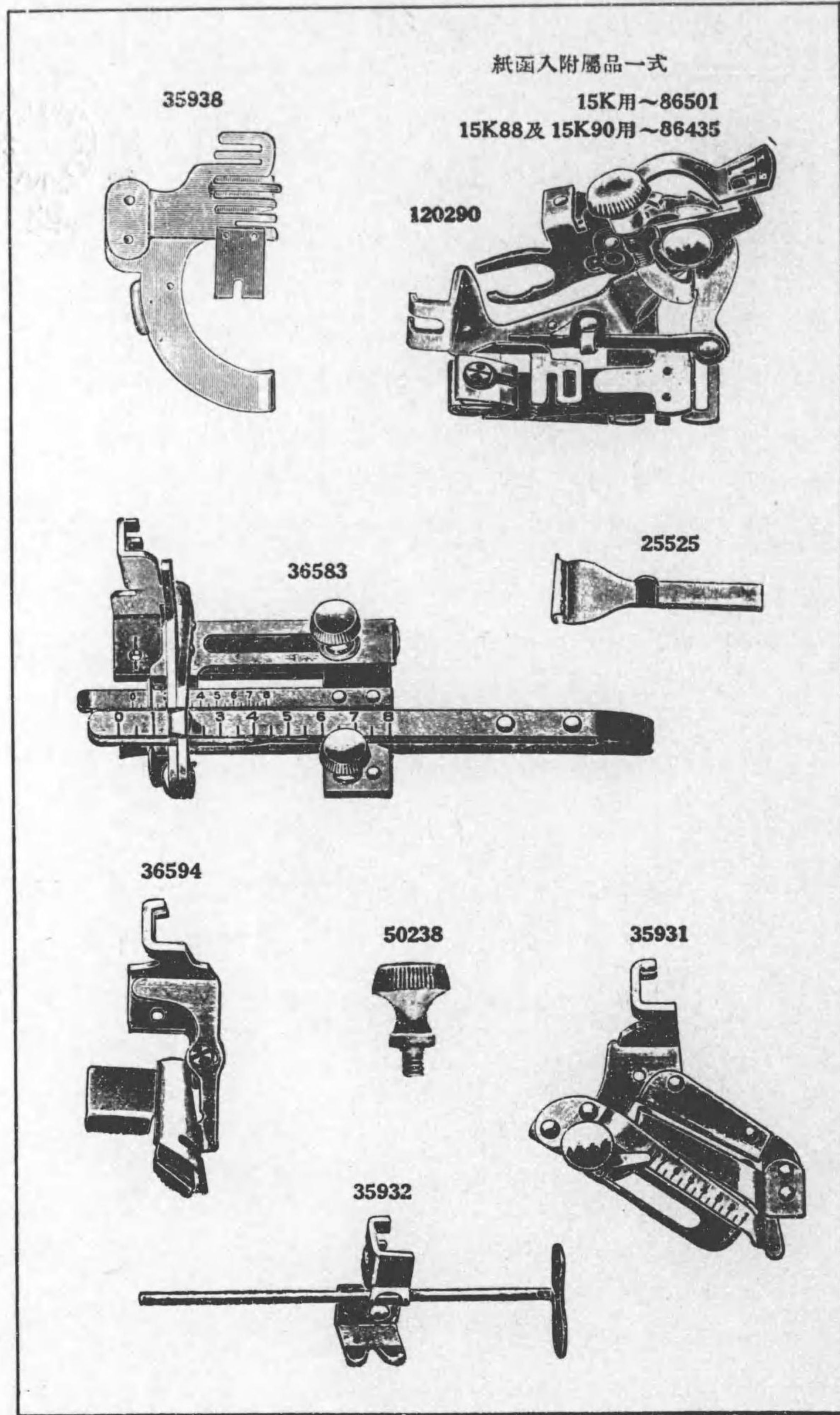
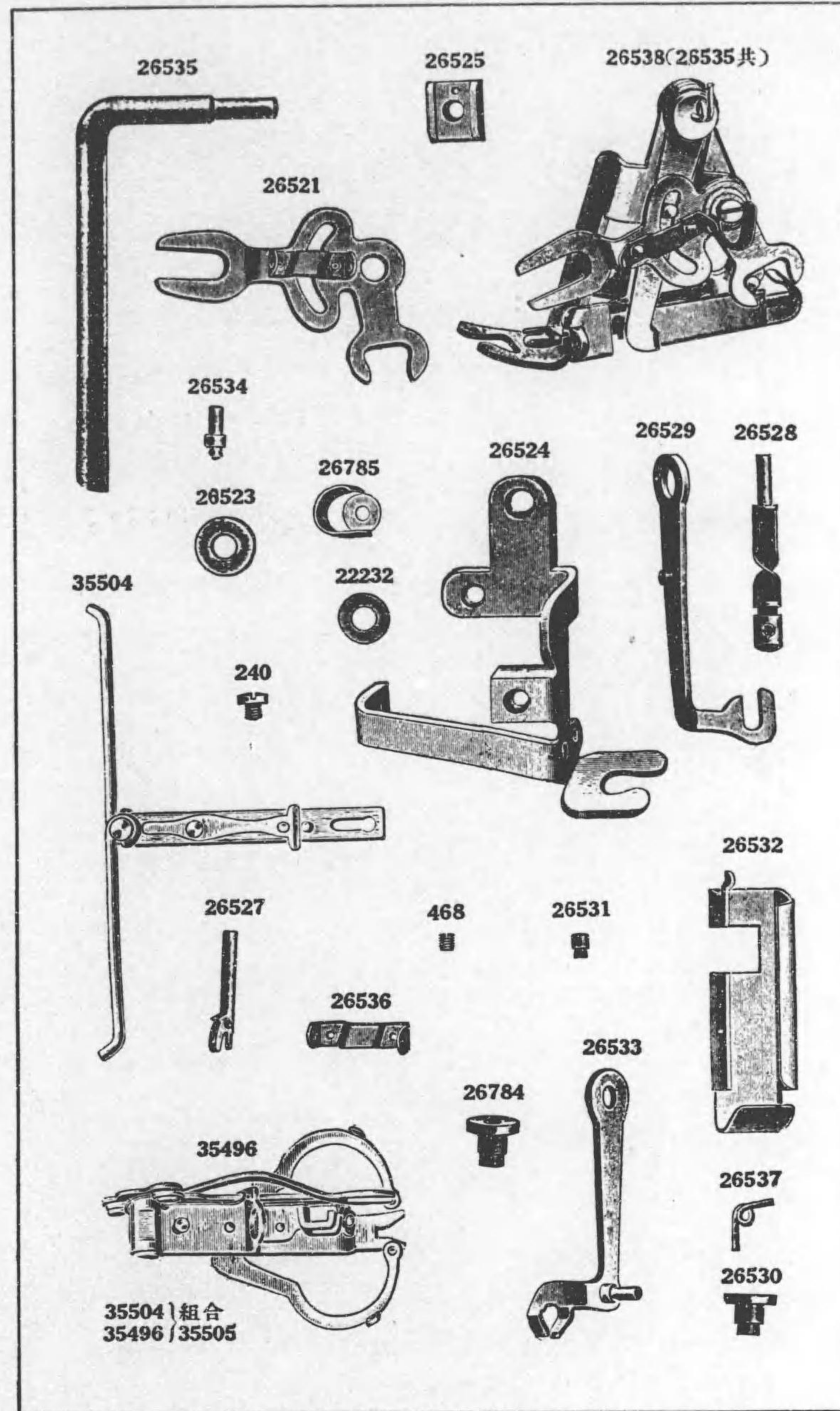
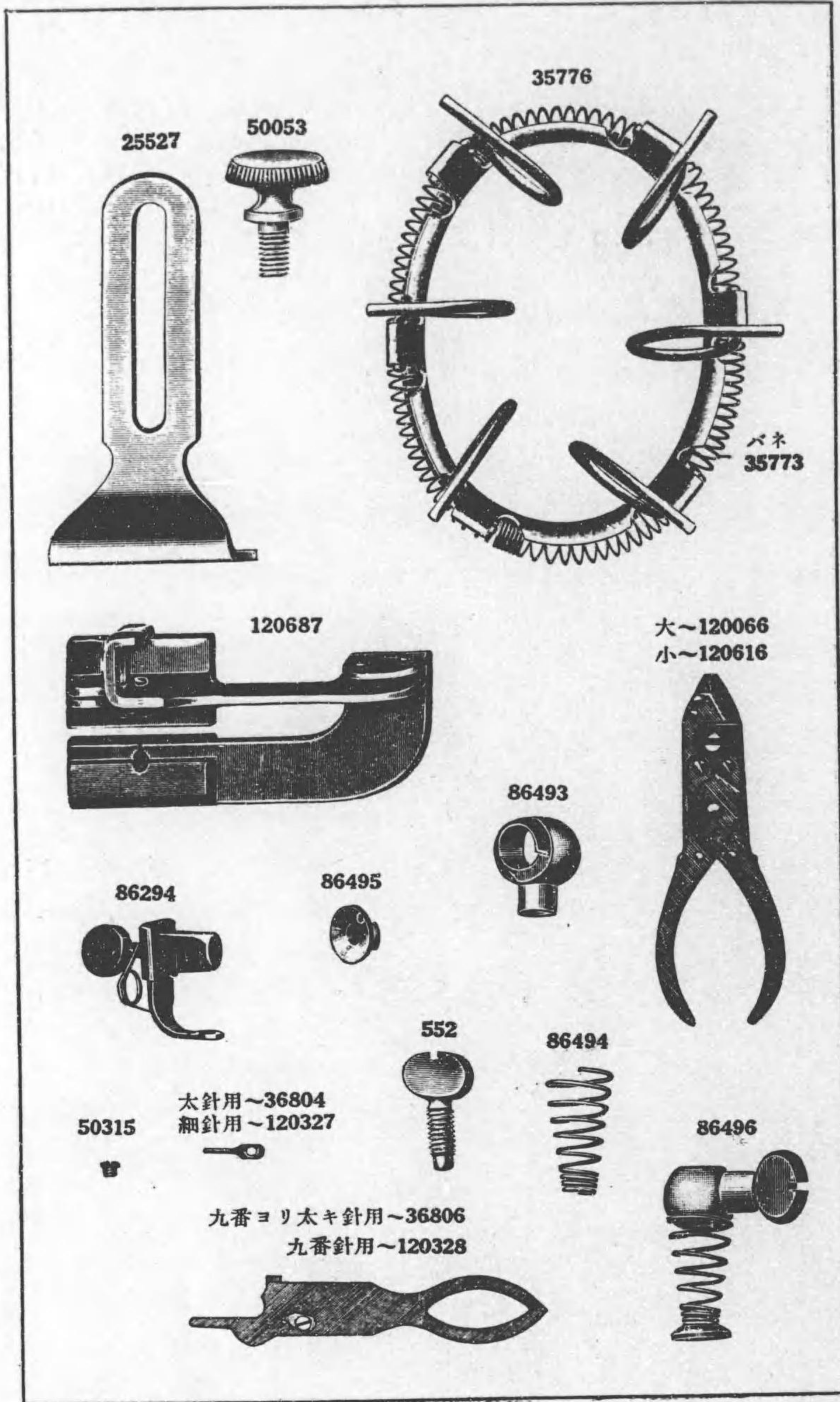

ILLUSTRATION OF PARTS
FAMILY & INDUSTRIAL
MACHINE
ATTACHMENTS & ACCESSORIES

職 家
業 庭
用 用

ミ
シ
ン
附
屬
具
及
小
道
具
圖
解





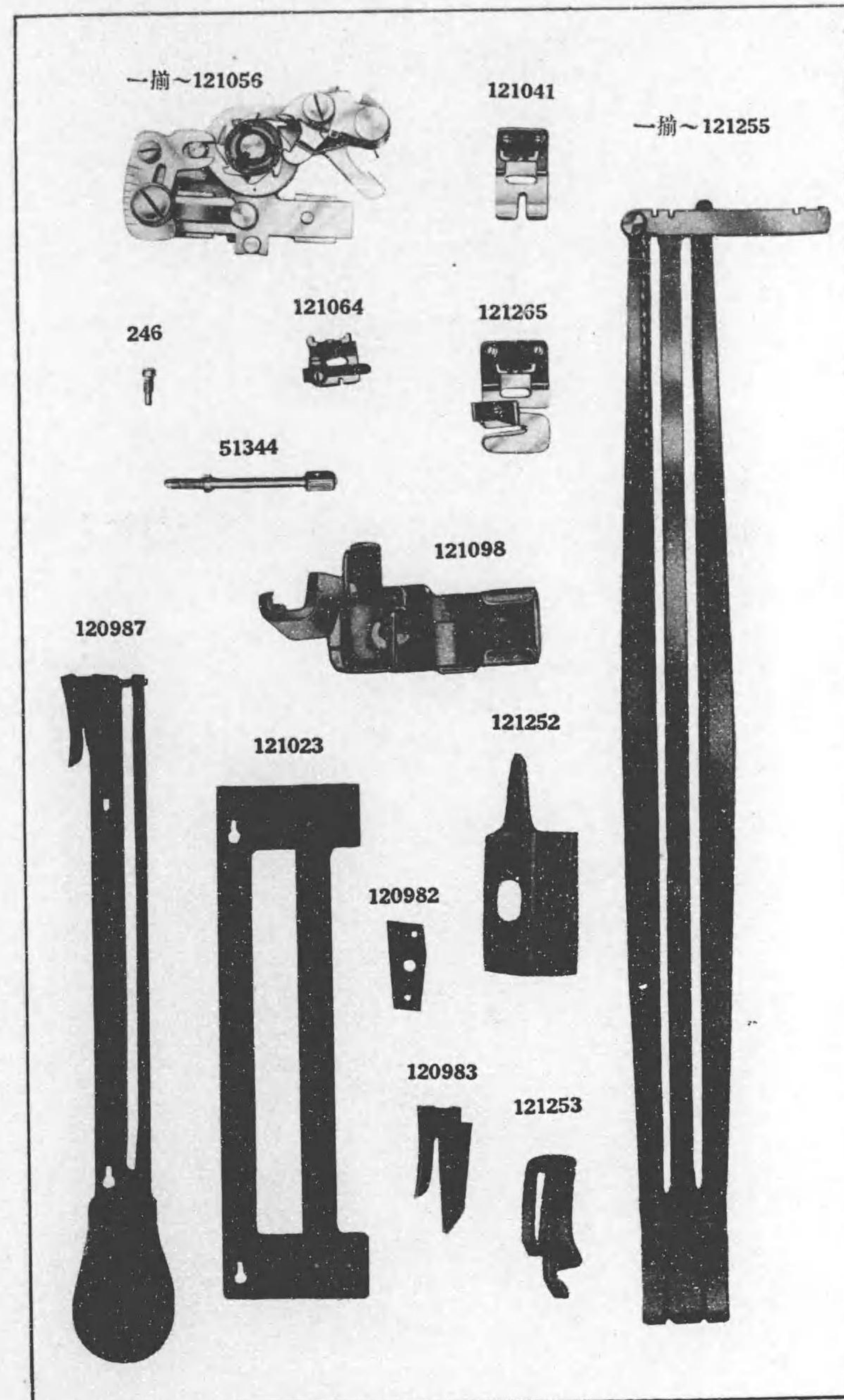
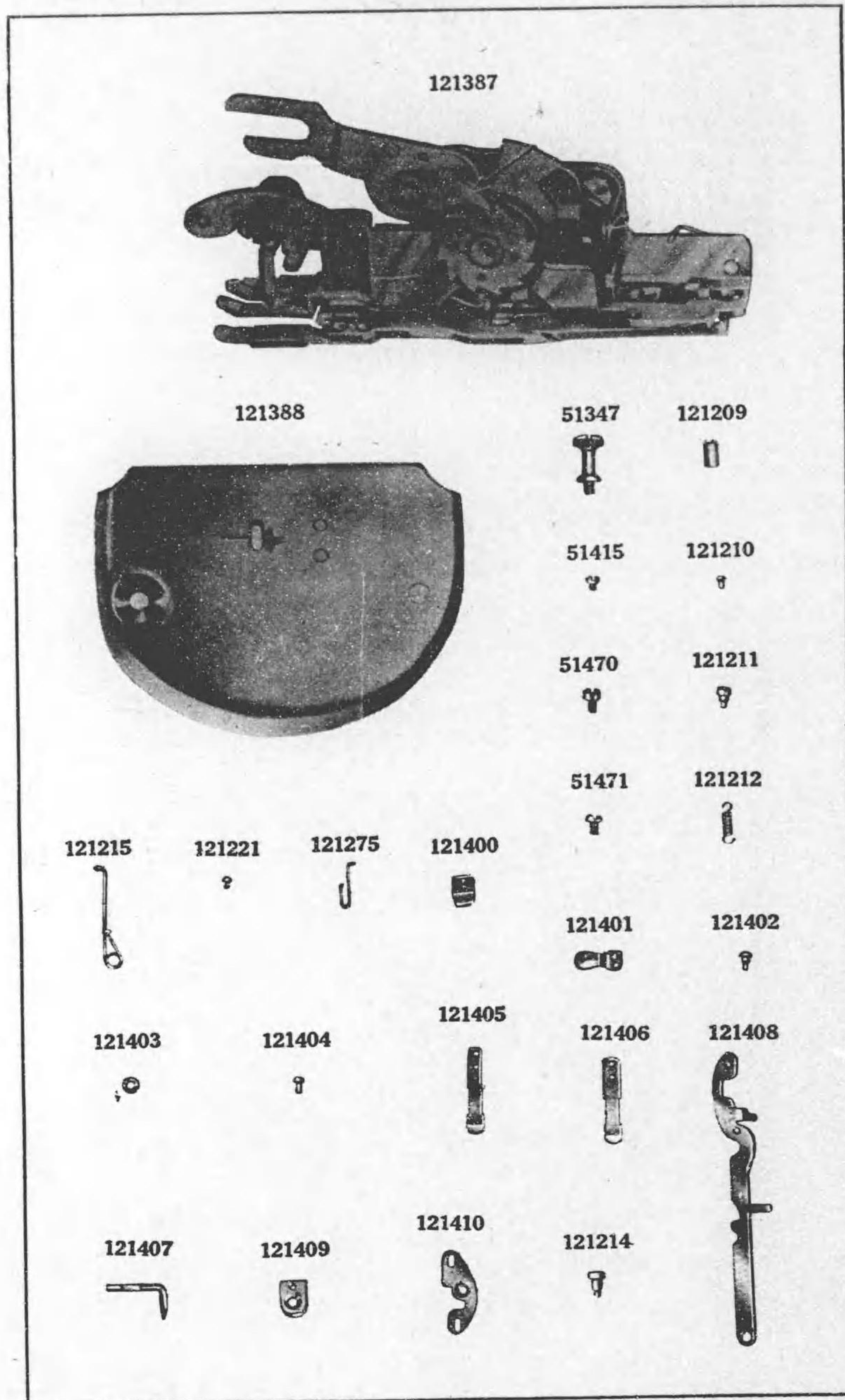

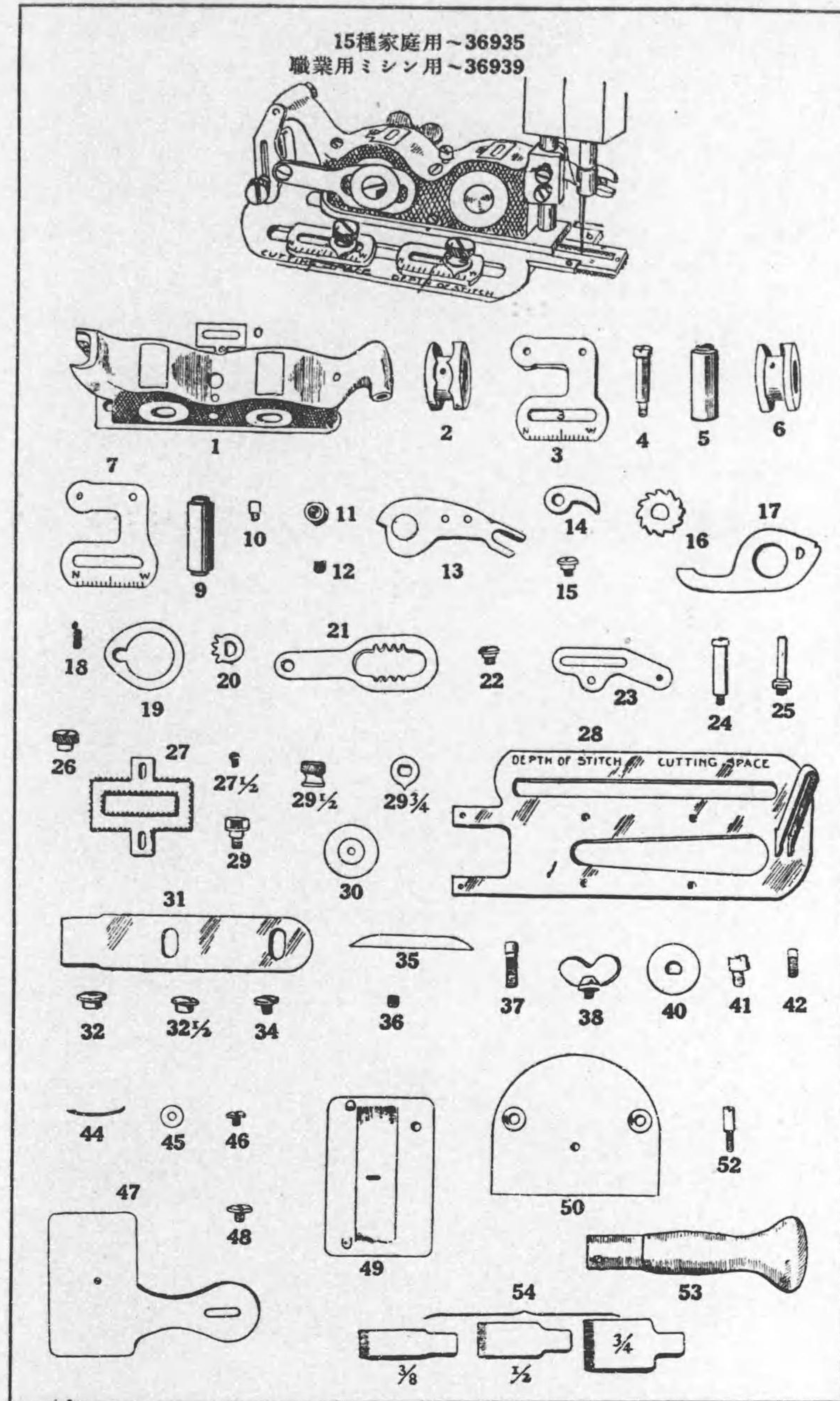
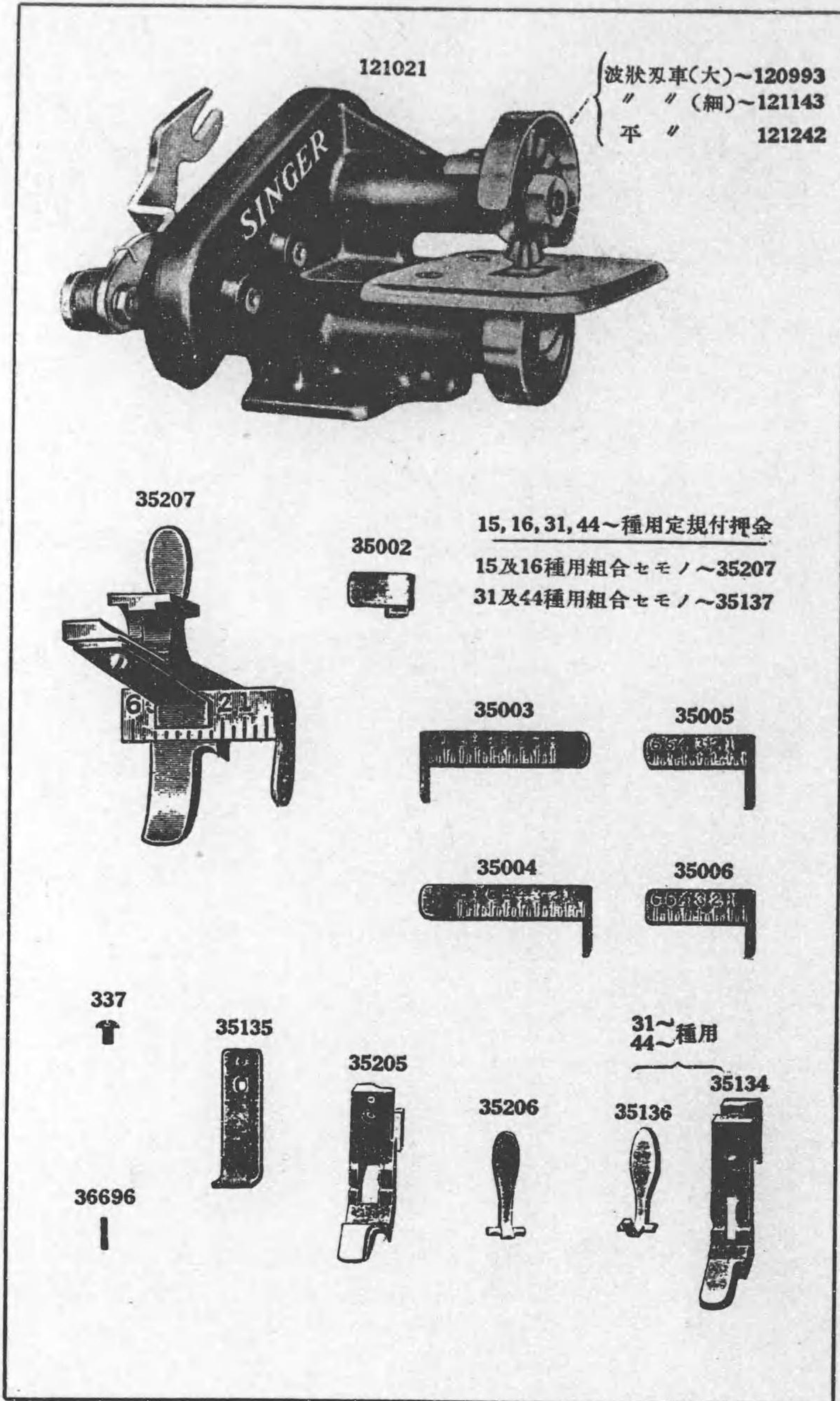

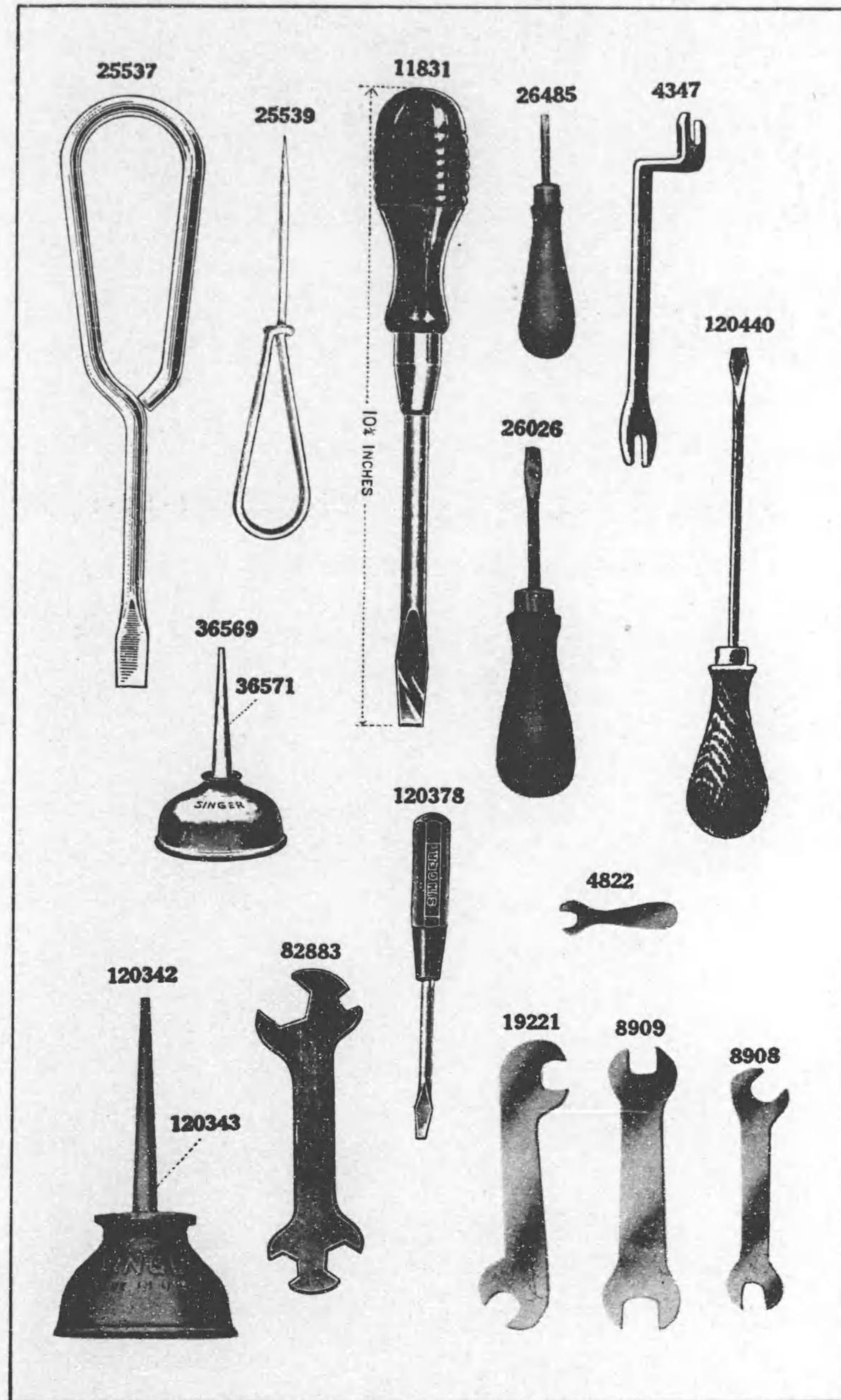
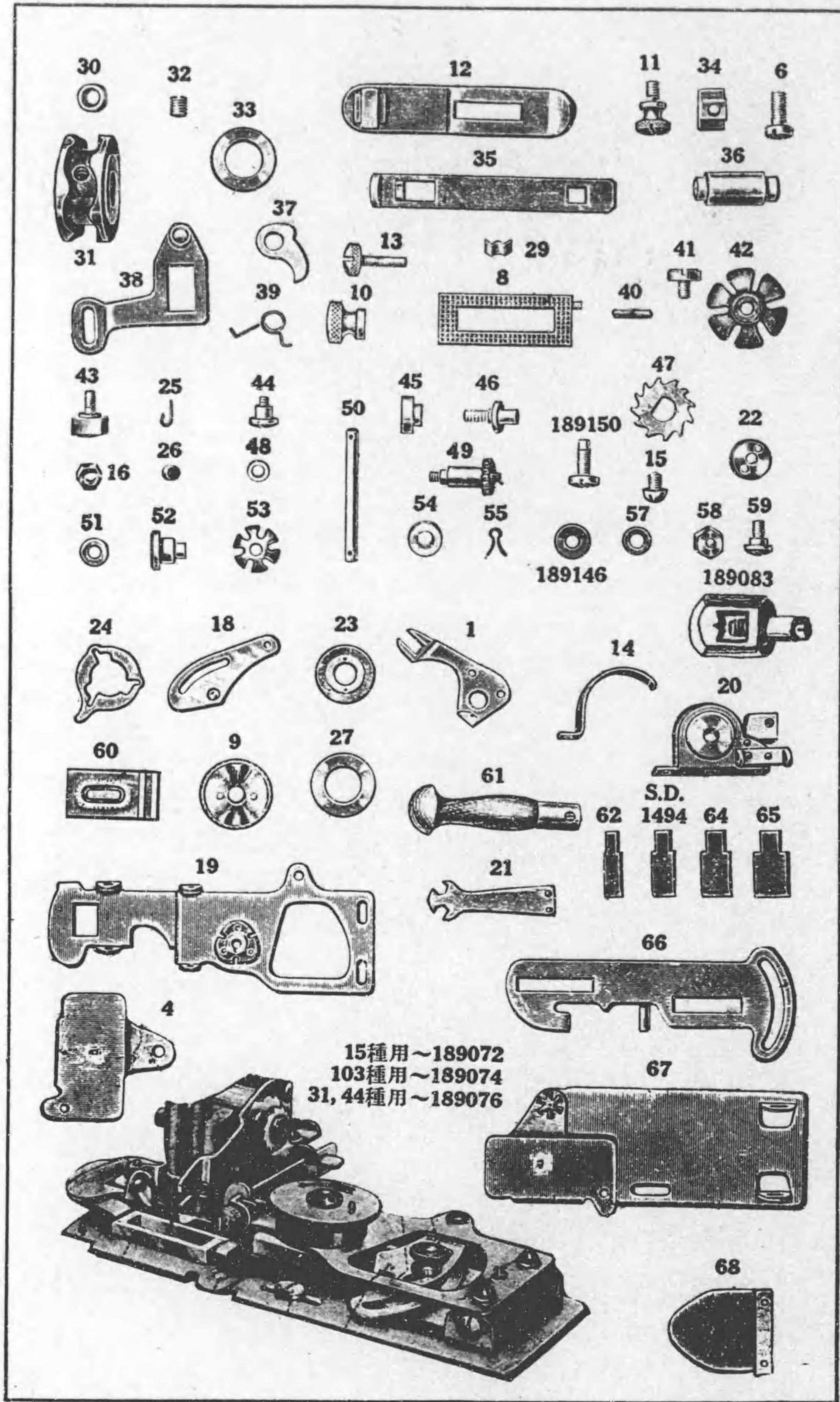

ILLUSTRATION OF PARTS

CLASS

15K28

MACHINE

十五種K二十八型ミシン部分品圖解

15K28

部分品 番 號	圖解番號	部分品 番 號	圖解番號	部分品 番 號	圖解番號	部分品 番 號	圖解番號
Parts No.	Plate No.	Parts No.	Plate No.	Parts No.	Plate No.	Parts No.	Plate No.
32	39	635	34	2106	76	8217	33
35	76	648	37	2111	35	8300	32
138	32	662	37	2112	35	10141	76
145	37	691	38	2113	35	11241	76
155	35	692	39	2114	35	12170	39
157	33	694	40	2115	35	12243	40
158	32	756	35	2183	38	12424	34
180	32	"	40	2441	37	15027	37
"	39	1035	34	2455	76	15072	76
190	36	1058	35	2506	38	"	39
"	38	1293	36	2509	33	15077	39
196	35	1513	33	2510	34	15140	37
208	38	1513	34	2515	37	15141	37
226	34	1518	32	2518	37	15147	36
233	36	1519	33	2523	37	15152	32
240	35	"	34	2528	37	15165	34
248	32	1520	34	2530	37	15170	34
256	32	"	35	2531	37	15171	34
263	35	1560	36	2532	37	15226	38
307	33	1562	76	2533	37	15227	38
315	33	1620	76	2535	37	15248	35
333	39	1813	33	2763	40	15257	35
356	40	1822	36	2765	40	15275	36
375	32	1832	34	2766	40	15277	37
378	34	2002	32	2767	40	15278	37
418	76	2007	32	2811	32	15281	38
435	32	2020	32	2816	33	15491	36
448	33	2022	32	2824	36	15498	32
"	36	2038	33	2831	38	27302	76
453	35	2042	34	2835	33	27303	76
"	40	2044	33	2897	38	27306	76
460	35	2047	33	2915	39	27307	76
462	32	2048	33	2973	37	27308	76
462	34	2049	33	2974	37	27312	76
"	37	"	34	2975	37	27538	76
465	33	"	37	3052	34	27540	76
570	35	2052	35	4304	34	27541	76
591	37	2070	35	5960	39	27647	76
592	37	2102	36	5961	39	43981	39
600	36	2103	36	6337	40	50353	33

15K28

部分品 番 號	圖解番號	部分品 番 號	圖解番號	部分品 番 號	圖解番號	部分品 番 號	圖解番號
Parts No.	Plate No.	Parts No.	Plate No.	Parts No.	Plate No.	Parts No.	Plate No.
50356	76						
50527	36						
51002	35						
51224	32						
51225	33						
51282	36						
80002	32						
80011	35						
80044	32						
80053	36						
80054	35						
80055	35						
80056	35						
80057	35						
80058	38						
80059	38						
80081	35						
80085	36						
80114	38						
80115	38						
80120	38						
80186	39						
80187	39						
80201	40						
80202	40						
80205	40						
80206	40						
80207	40						
80259	36						
80269	35						
82358	36						
87317	7						
97502	40						
125003	32						

第三十二圖

15K28

PLATE 32

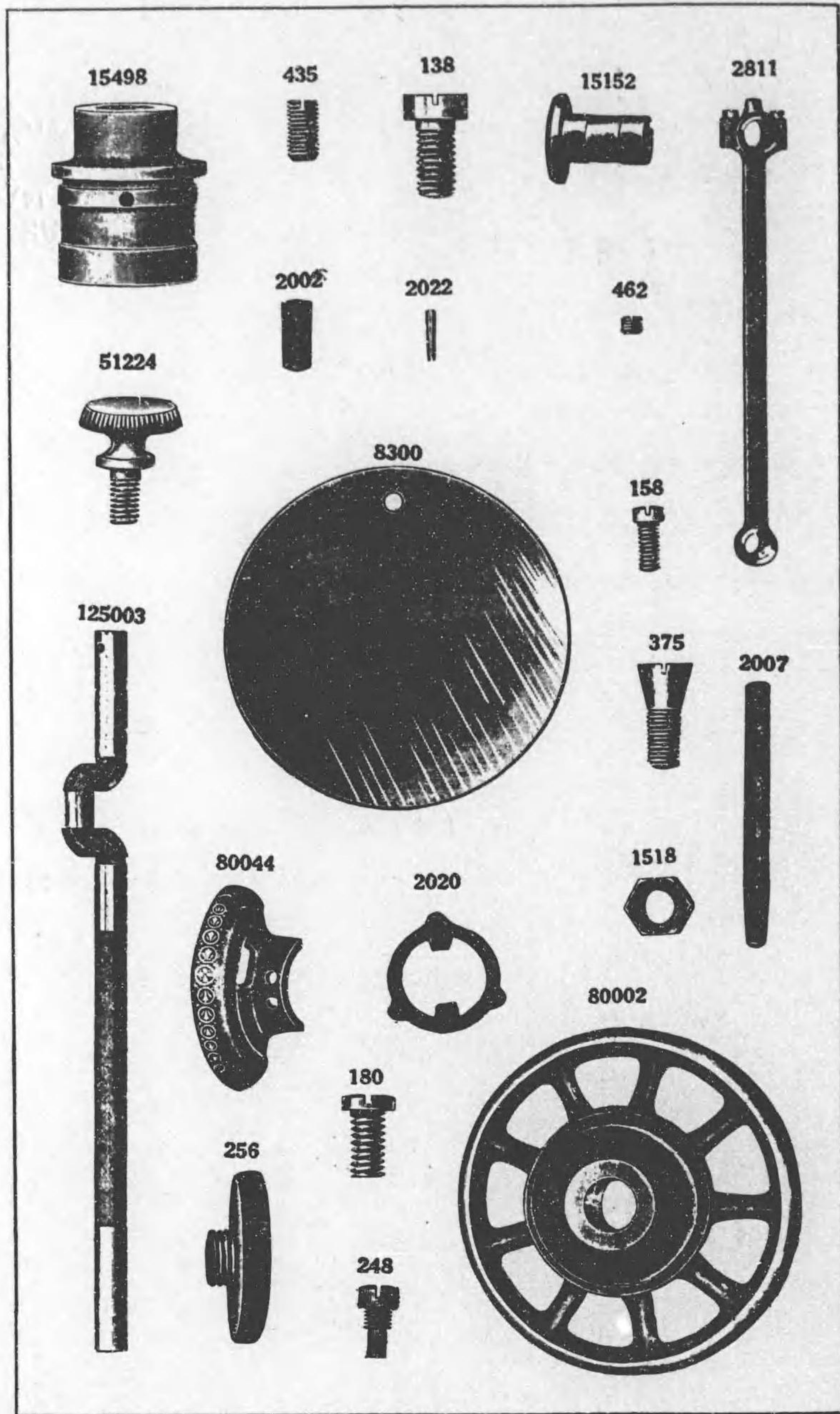
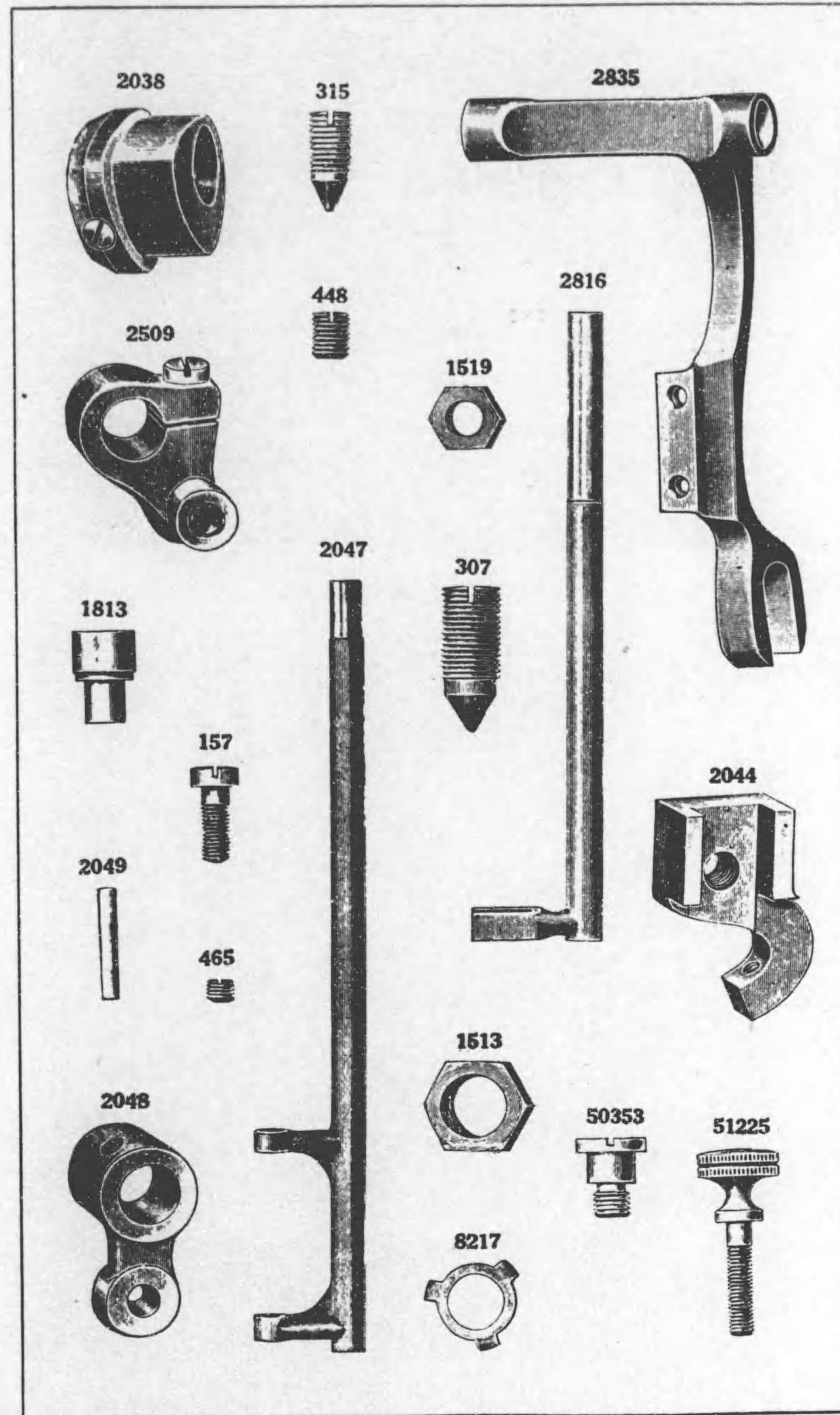

PLATE 33

15K28

第三十三圖



第三十四圖

15K28

PLATE 34

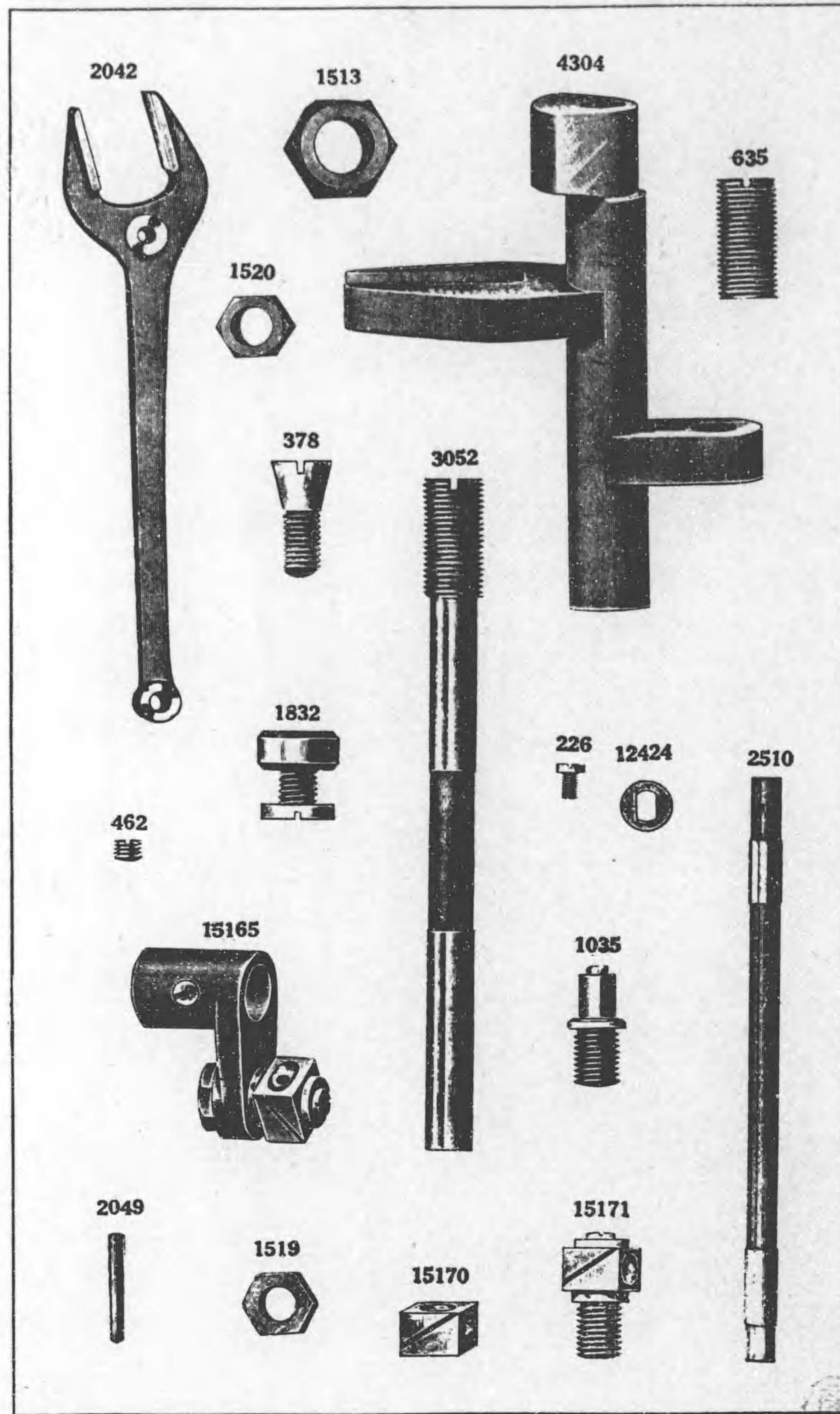
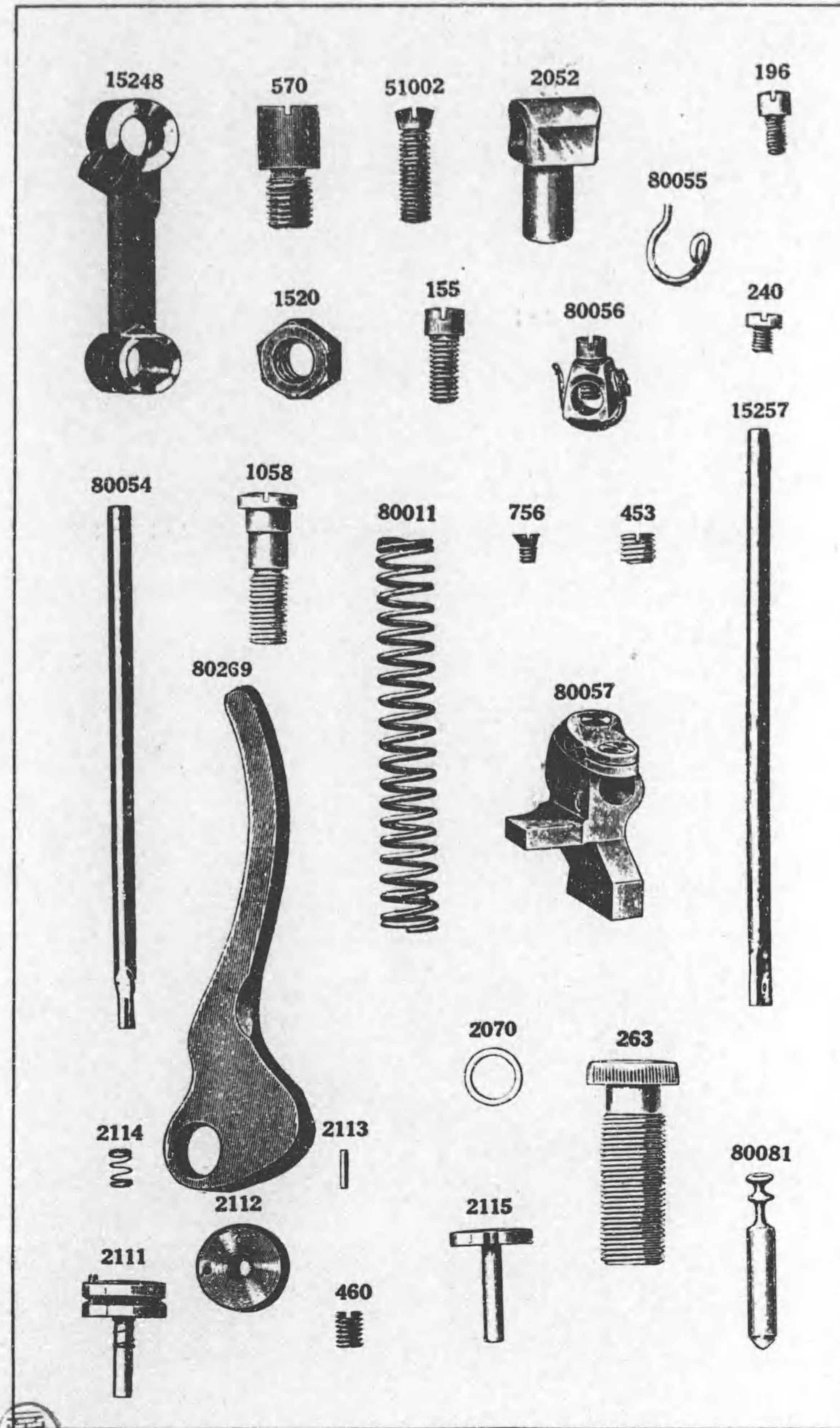

PLATE 35

15K28

第三十五圖



第三十六圖

15K28

PLATE 36

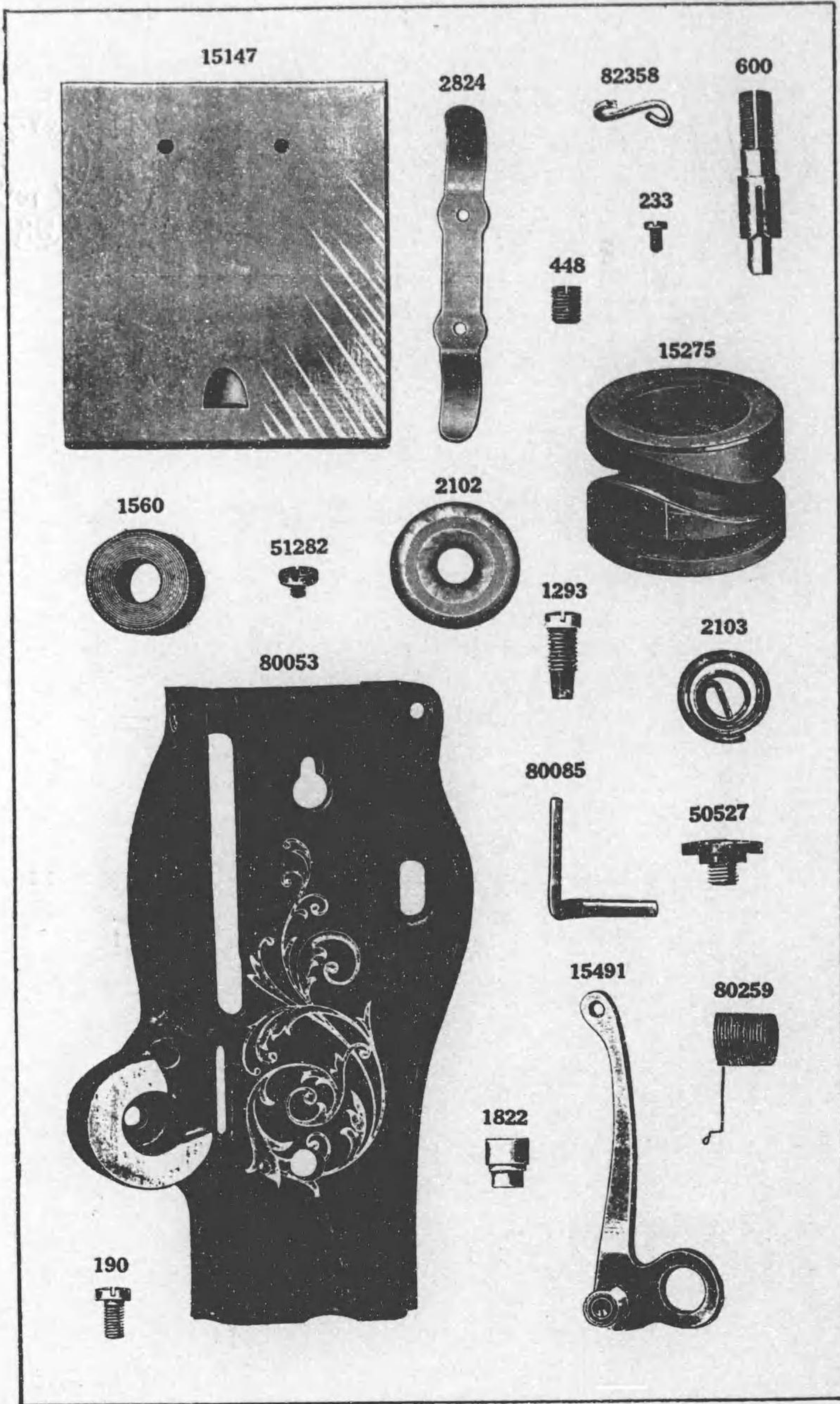
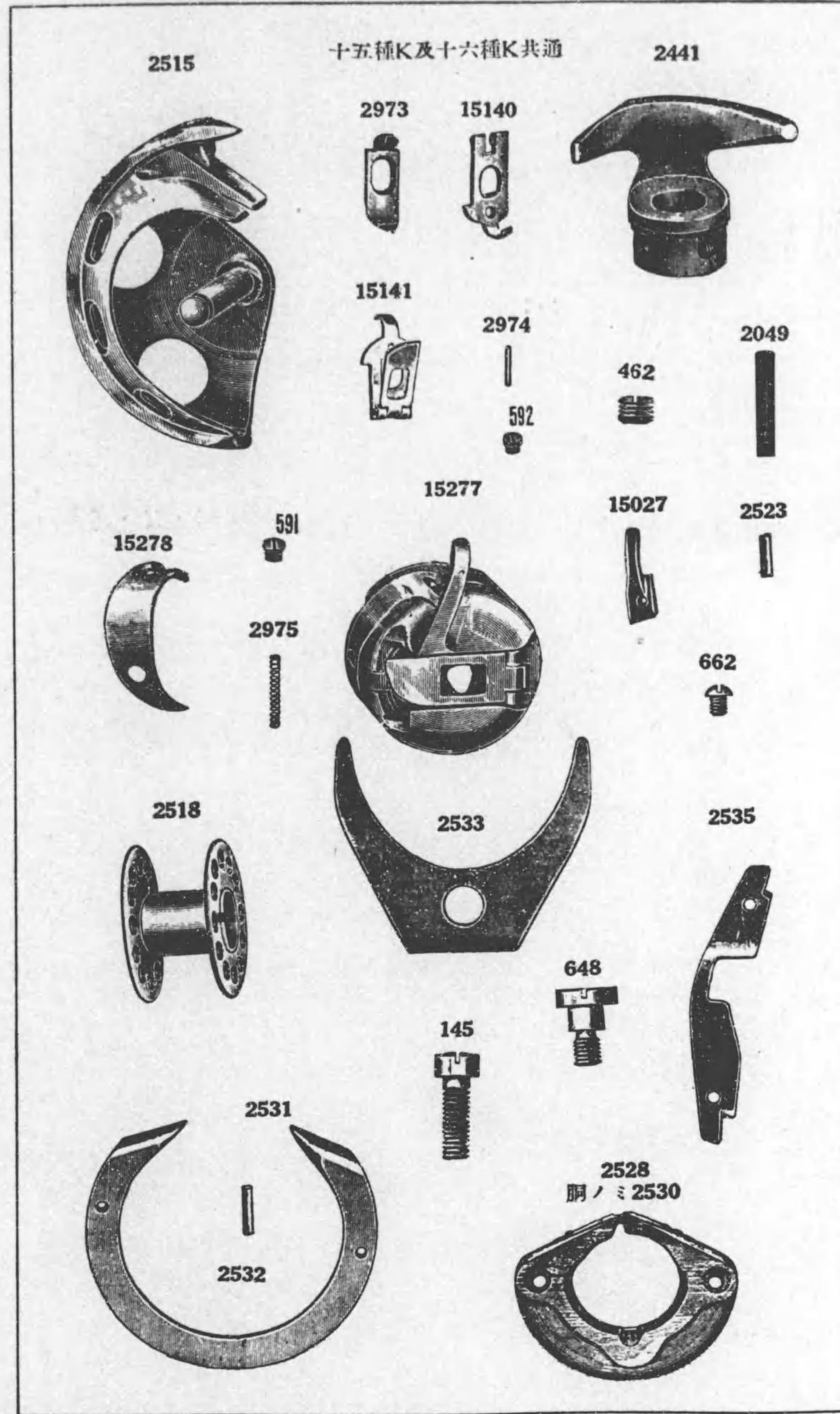

PLATE 37

15K28, 16K33

第三十七圖



第三十八圖

15K28, 16K33

PLATE 38

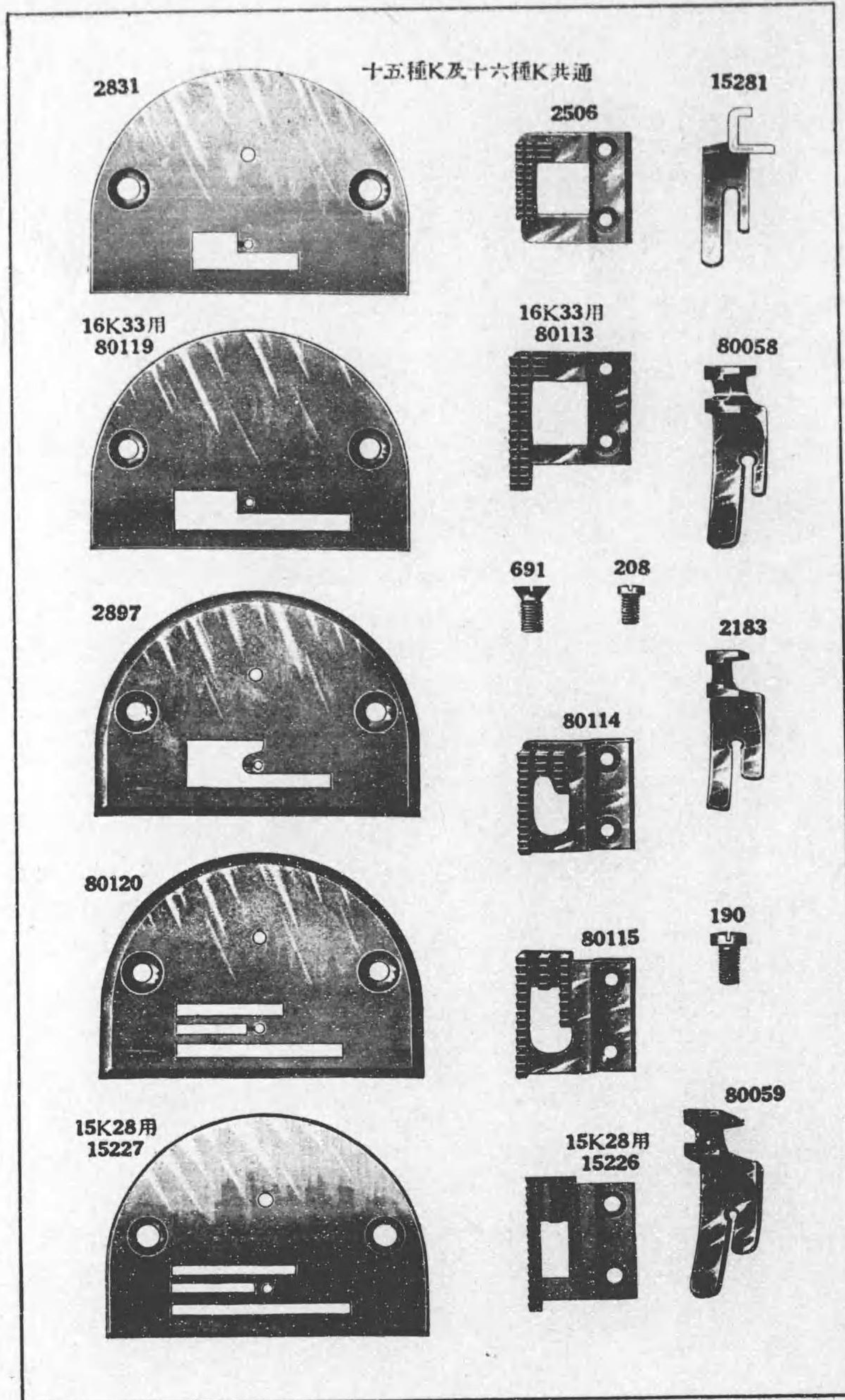
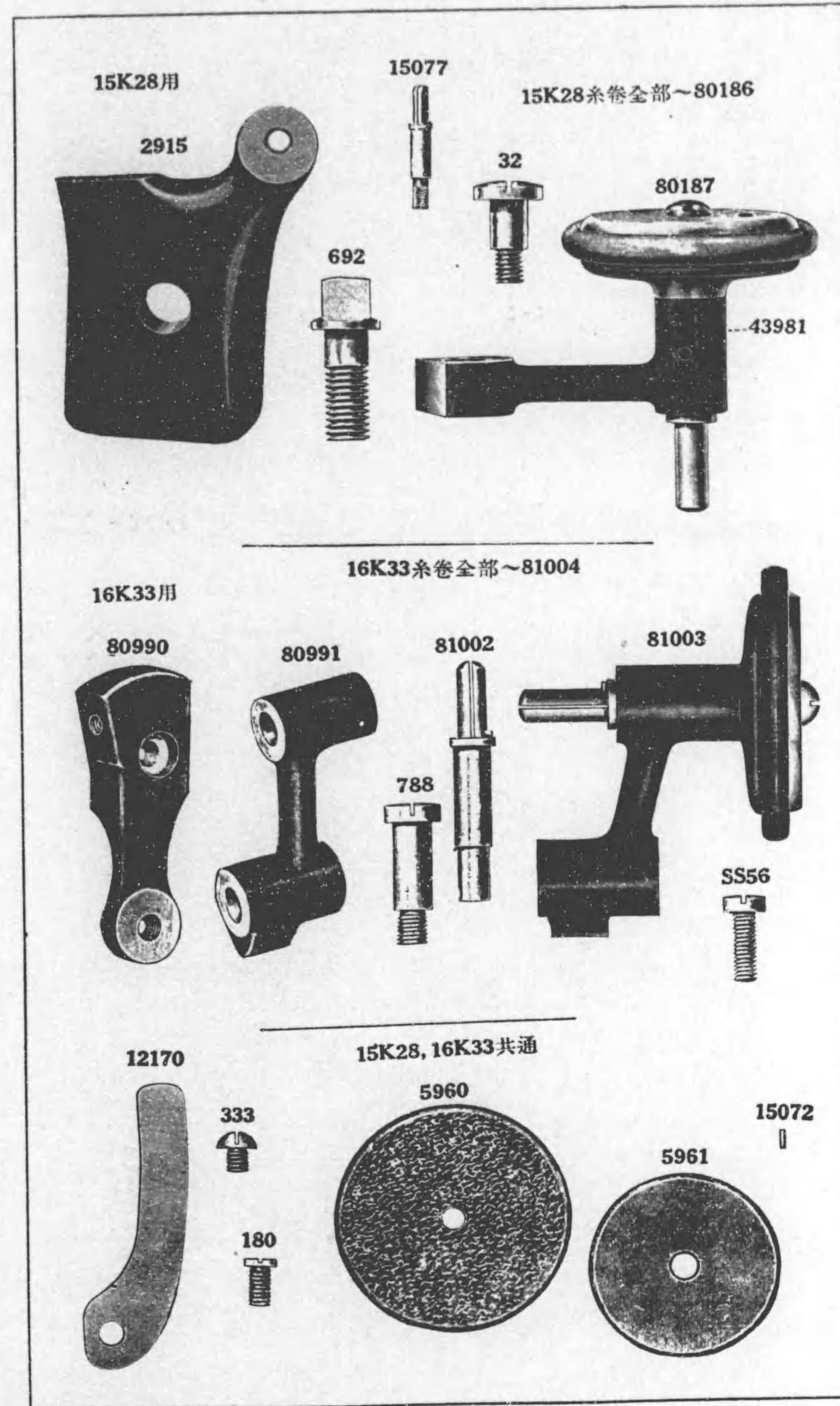

PLATE 39

15K28, 16K33

第三十九圖



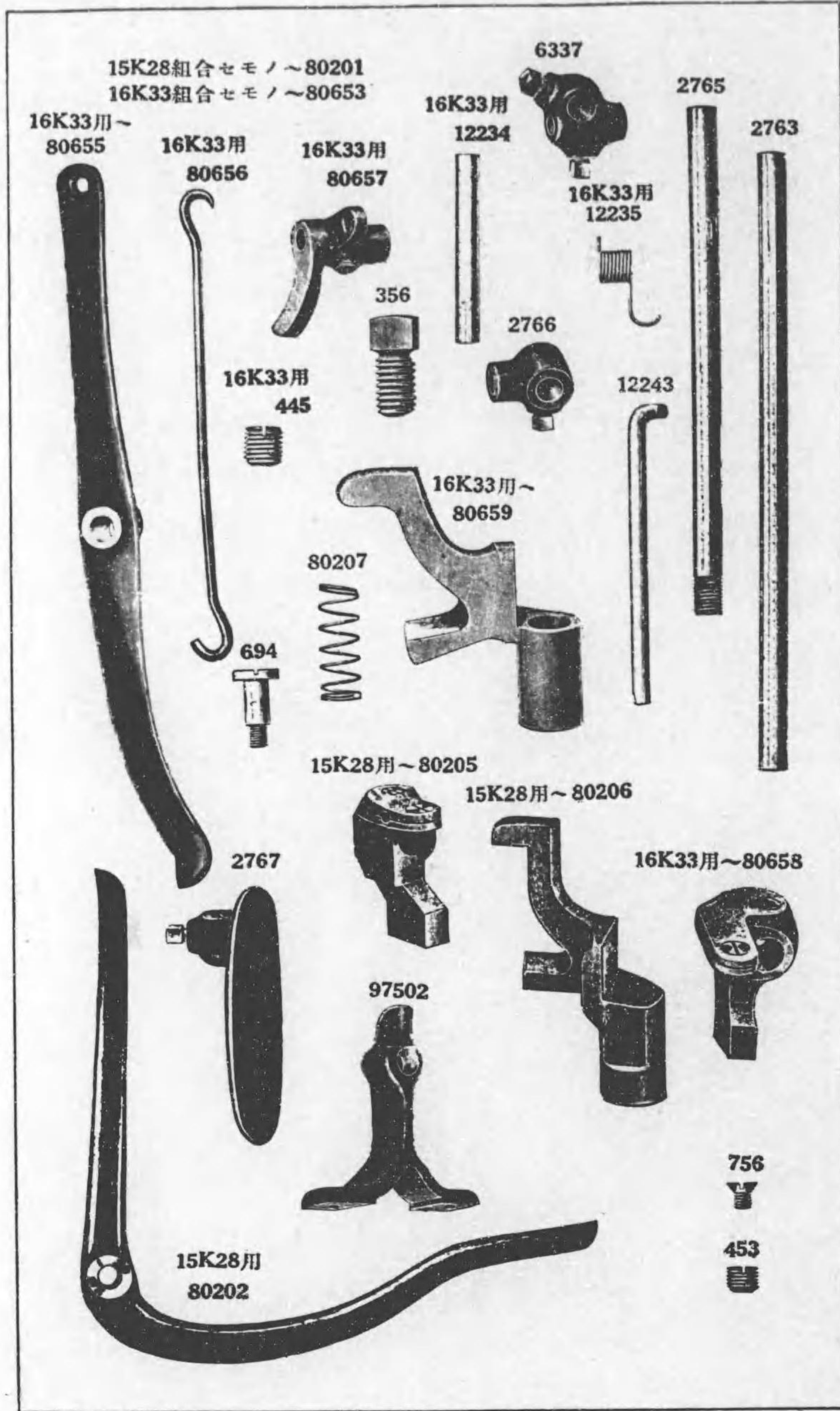

ILLUSTRATION OF PARTS

CLASS

16K33

MACHINE

十六種K三十三型ミシン部分品圖解

16K33

部分品 番 號	圖解番號	部分品 番 號	圖解番號	部分品 番 號	圖解番號	部分品 番 號	圖解番號
Parts No.	Plate No.	Parts No.	Plate No.	Parts No.	Plate No.	Parts No.	Plate No.
35	76	600	45	2183	38	4305	44
S.S. 56	39	635	43	2441	37	4389	41
76	45	648	37	2455	76	4391	42
123	41	662	37	2506	38	4449	41
145	37	689	45	2515	37	4933	41
"	45	691	38	2518	37	5960	39
155	44	694	40	2523	37	5961	39
157	43	756	44	2528	37	6337	40
158	42	"	40	2530	37	10141	76
164	45	788	39	2531	37	11241	76
180	39	818	42	2532	37	12170	39
190	38	1035	43	2533	37	12234	40
196	44	1128	42	2535	37	12235	40
208	38	1513	43	2763	40	12243	40
226	43	1518	42	2765	40	12424	43
233	45	"	44	2766	40	12453	41
240	44	1519	42	2767	40	15027	37
248	41	"	43	2824	44	15072	39
256	41	1520	45	2831	38	"	76
262	44	1560	45	2897	38	15140	37
290	44	1562	76	2973	37	15141	37
307	43	1620	76	2974	37	15163	43
313	42	1813	43	2975	37	15165	43
333	39	1819	45	3005	41	15170	43
356	40	2002	41	3012	45	15171	43
375	42	2007	41	3032	42	15277	37
377	44	2020	41	3033	42	15278	37
418	76	2022	41	3037	42	15281	38
445	40	2049	37	3039	42	27302	76
446	42	"	43	3042	43	27303	76
"	45	2052	44	3045	44	27306	76
448	41	2070	44	3052	43	27307	76
453	40	2102	45	3054	44	27308	76
"	44	2103	45	3072	45	27312	76
460	45	2106	76	3100	44	27538	76
462	37	2111	45	3165	43	27540	76
"	41	2112	45	3168	43	27541	76
"	43	2113	45	4288	41	27647	76
591	37	2114	45	4292	42	29633	43
592	37	2115	45	4304	43	50356	76

16K33

部分品 番 號	圖解番號	部分品 番 號	圖解番號	部分品 番 號	圖解番號	部分品 番 號	圖解番號
Parts No.	Plate No.	Parts No.	Plate No.	Parts No.	Plate No.	Parts No.	Plate No.
51224	41						
51282	44						
80055	44						
80056	44						
80058	38						
80059	38						
80081	45						
80085	45						
80113	38						
80114	38						
80115	38						
80119	38						
80120	38						
80207	40						
80259	45						
80269	45						
80501	41						
80504	41						
80518	45						
80519	44						
80524	44						
80528	44						
80541	43						
80543	45						
80544	45						
80653	40						
80655	40						
80656	40						
80657	40						
80658	40						
80659	40						
80990	39						
80991	39						
81002	39						
81003	39						
81004	39						
82358	45						
97502	40						

第四十一圖

16K33

PLATE 41

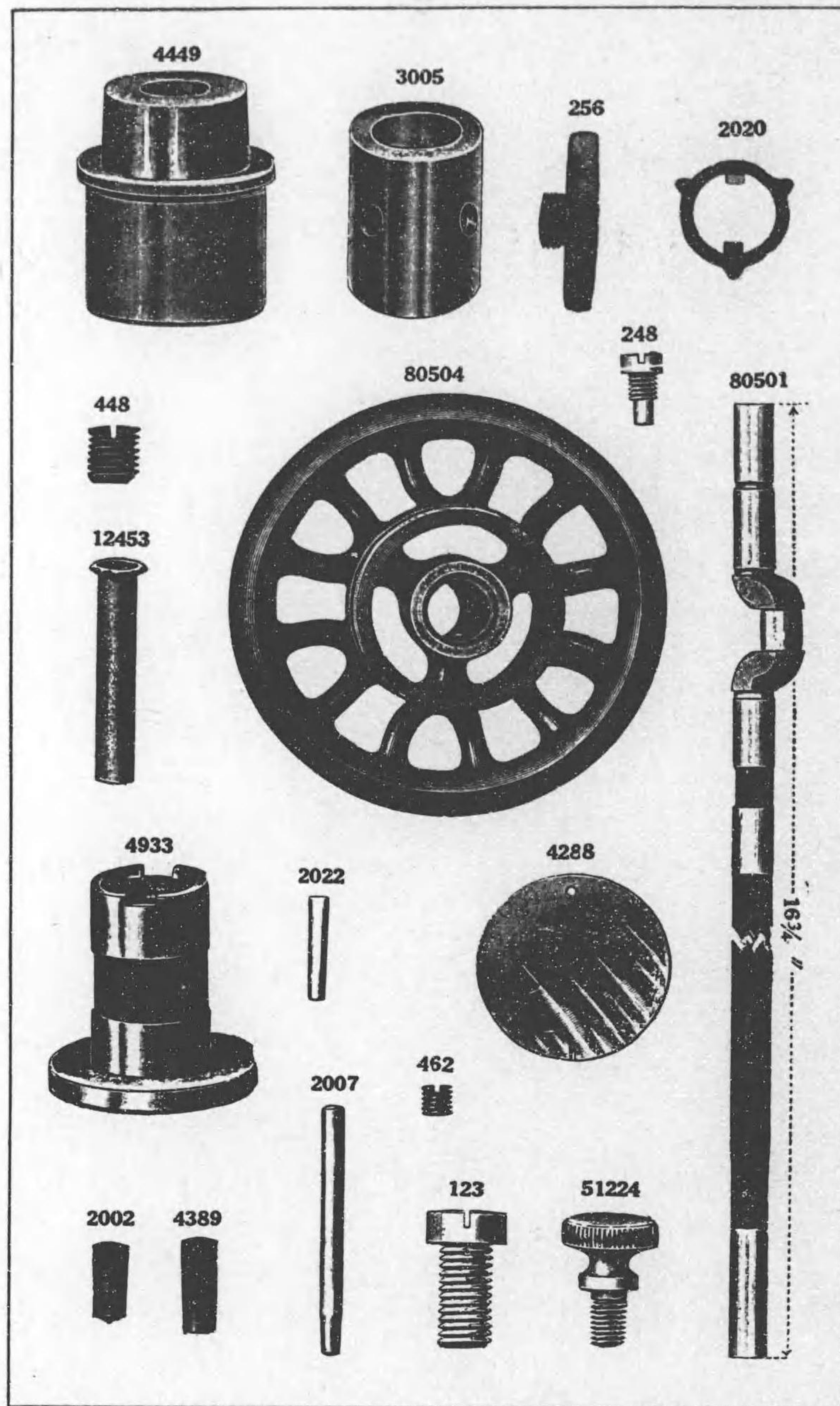
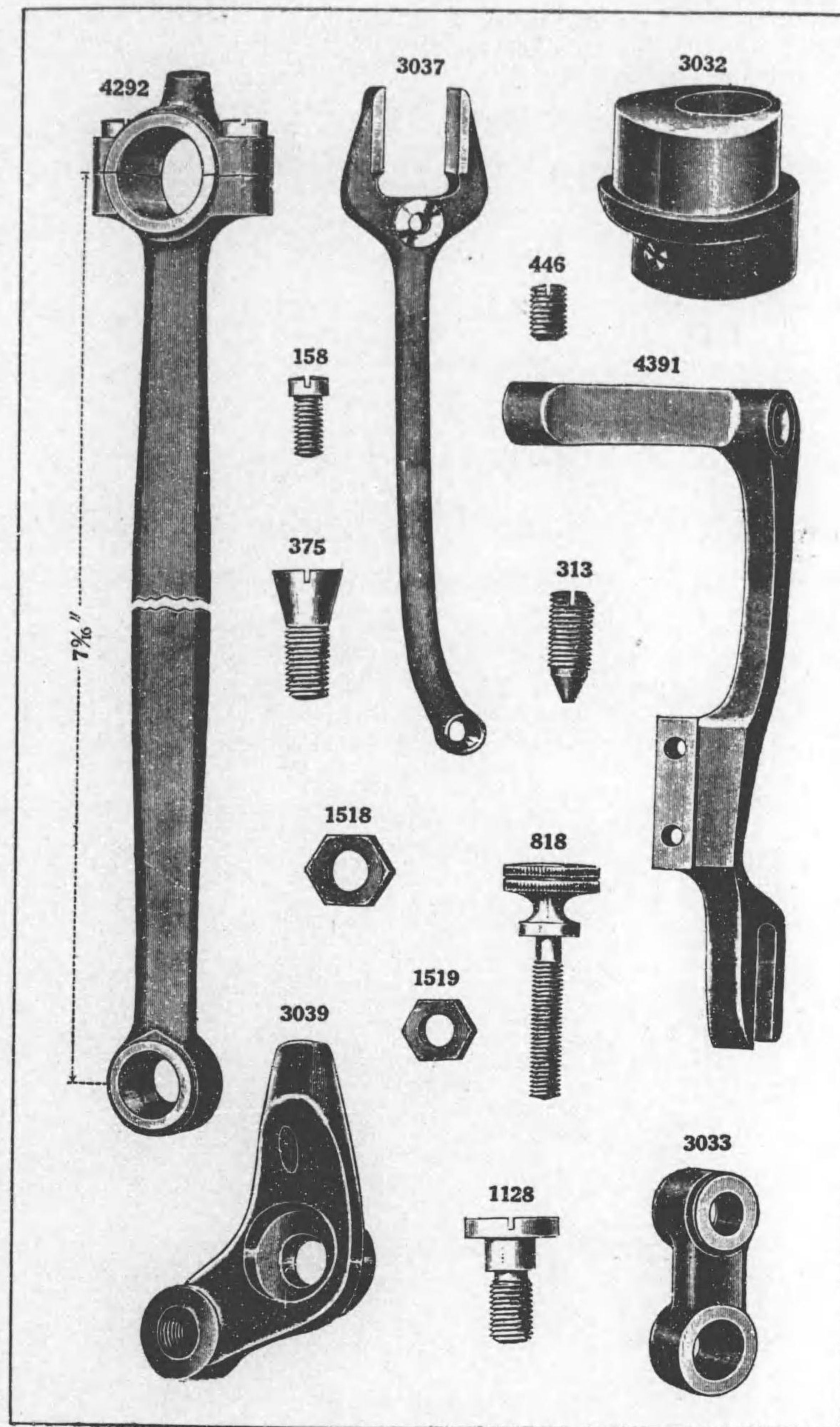

PLATE 42

16K33

第四十二圖



第四十三圖

16K33

PLATE 43

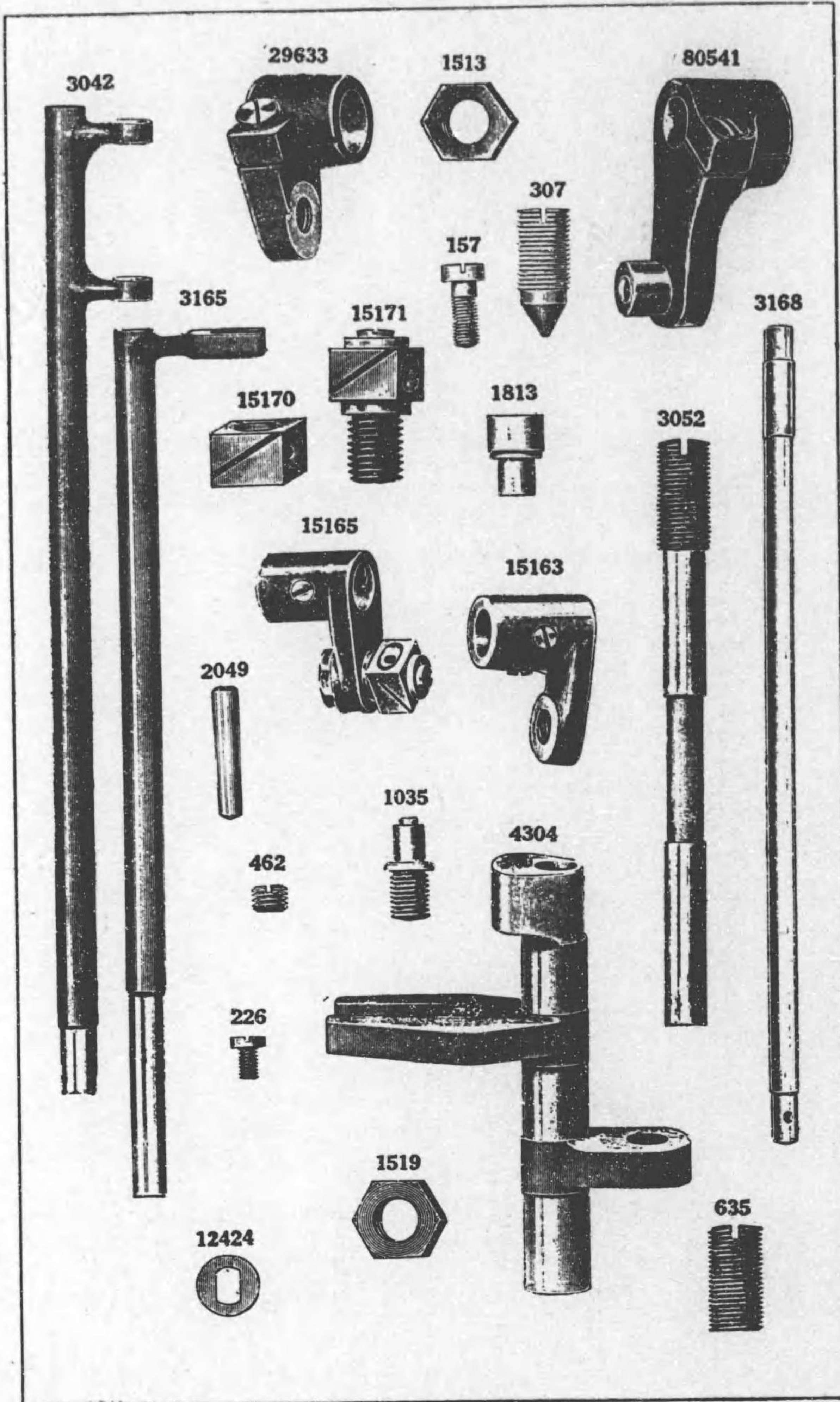
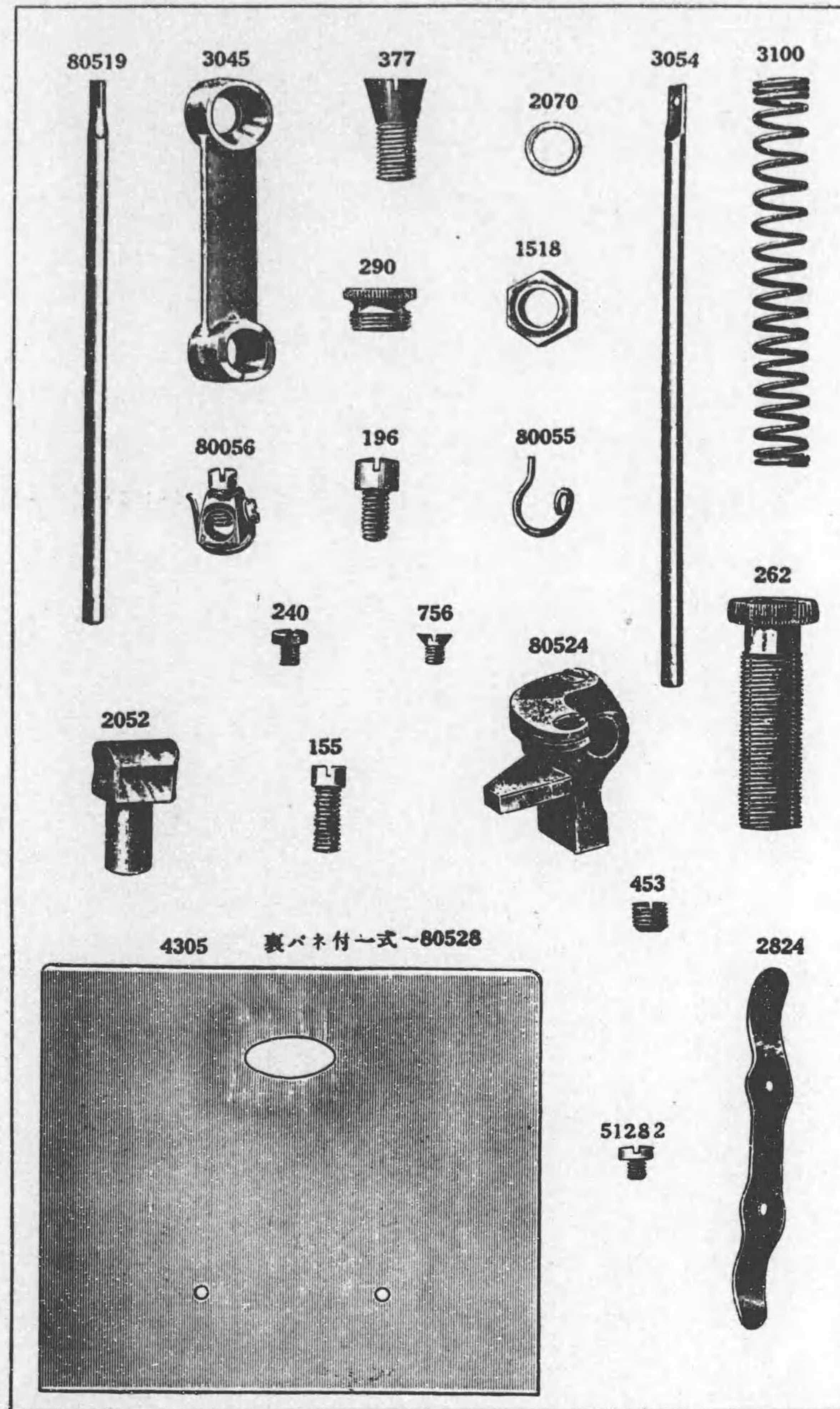

PLATE 44

16K33

第四十四圖



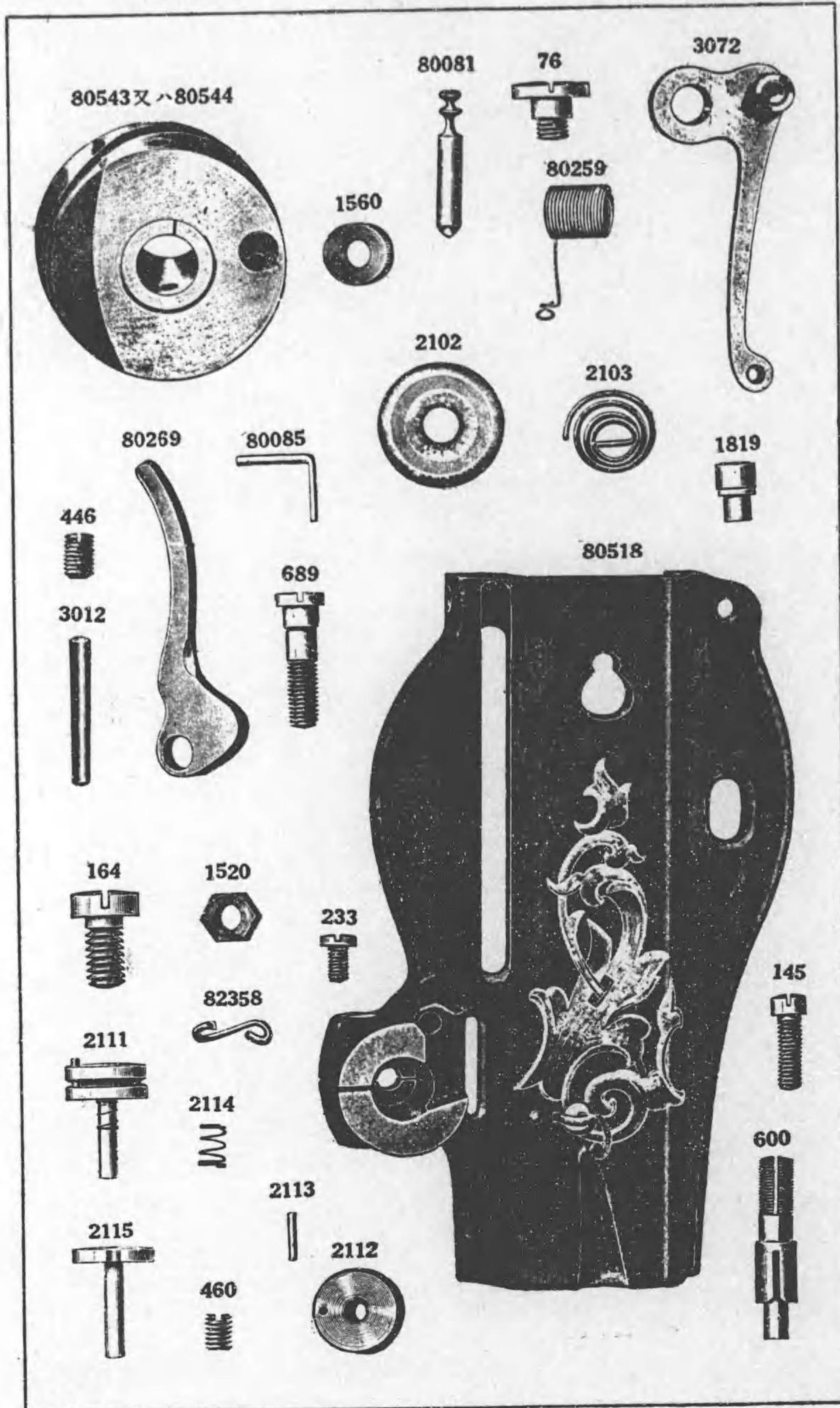

ILLUSTRATION OF PARTS

CLASS

17-1

MACHINE

十七種一型ミシン部分品圖解

部分品 番 號	圖解番號	部分品 番 號	圖解番號	部分品 番 號	圖解番號	部分品 番 號	圖解番號
Parts No.	Plate No.	Parts No.	Plate No.	Parts No.	Plate No.	Parts No.	Plate No.
123	46	3052	47	16892	48		
164	46	3056	46	50250	48		
175	48	3072	47	51224	49		
196	47	3280	46	52016	46		
225	47	4264	47	65059	48		
233	46	4343	46				
286	49	4368	47	上記以外ハ18-22 =同ジ			
337	48	4369	48				
345	47	4389	47				
401	47	4448	47				
453	49	5525	49				
460	48	5526	49				
651	47	5608	49				
689	46	6005	46				
1088	47	6008	47				
1489	49	6009	46				
1520	46	6011	47				
1819	47	6016	47				
2052	47	6017	47				
2105	48	6022	47				
2107	46	6023	47				
2111	48	6029	48				
2112	48	6032	48				
2113	48	6040	47				
2114	48	6053	49				
2115	48	6054	46				
2124	48	6057	48				
2127	48	6333	49				
2269	48	6334	49				
2308	46	6337	49				
2460	49	6338	49				
2461	49	6339	49				
2466	49	7170	49				
2468	49	7524	47				
2763	49	7525	47				
2766	49	11241	47				
2767	49	16242	48				
2770	49	16646	49				
2862	46	16659	49				
3039	47	16689	48				

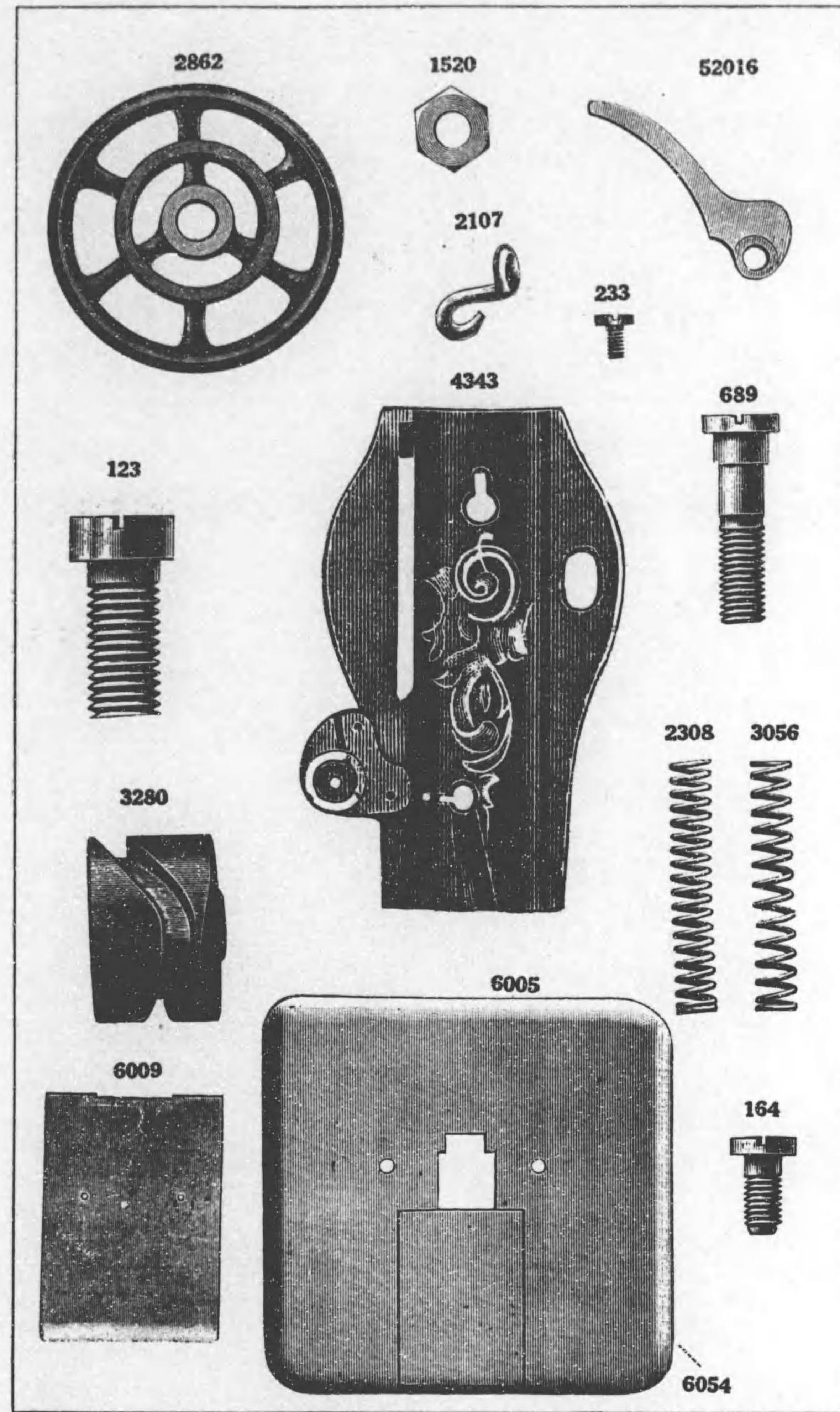

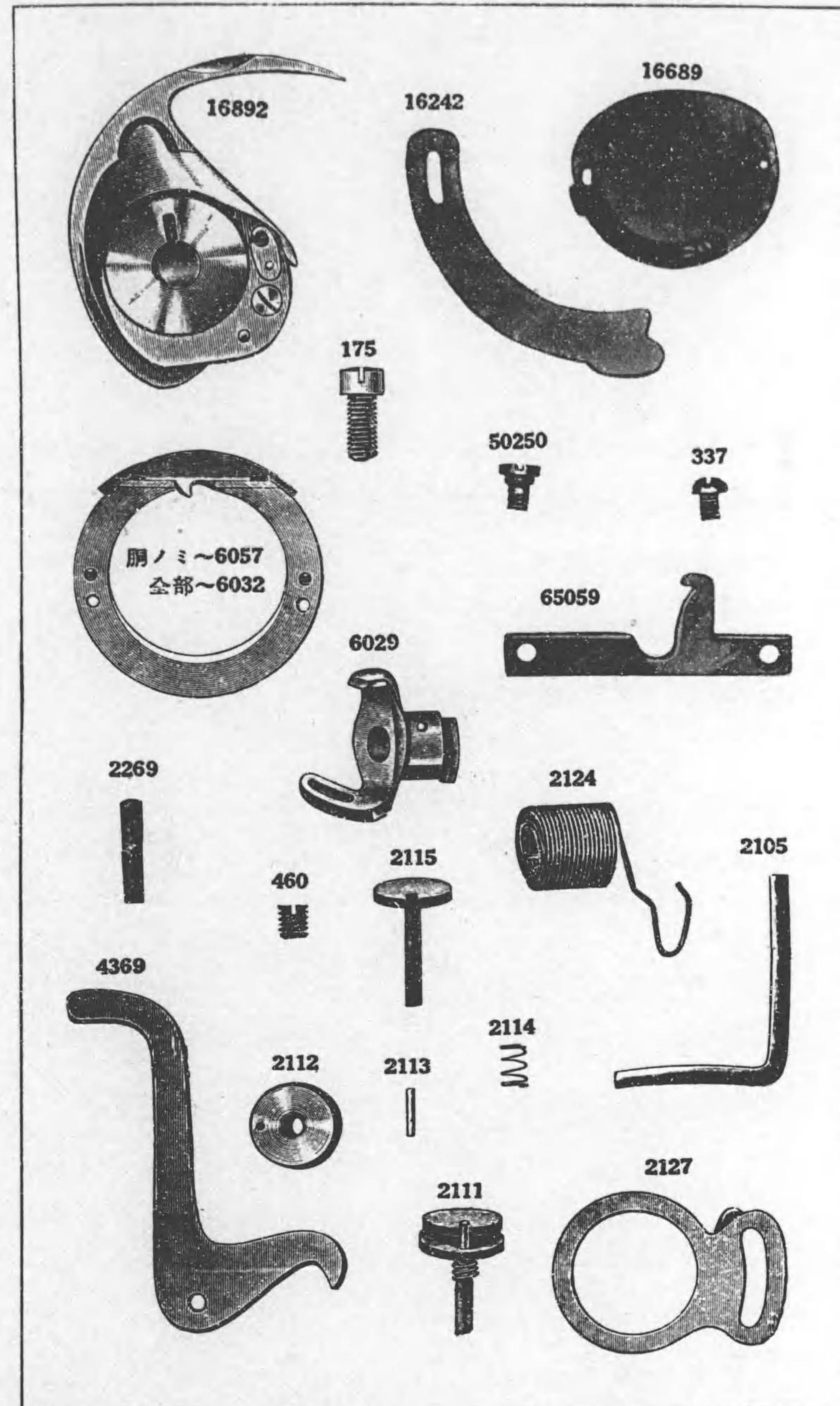
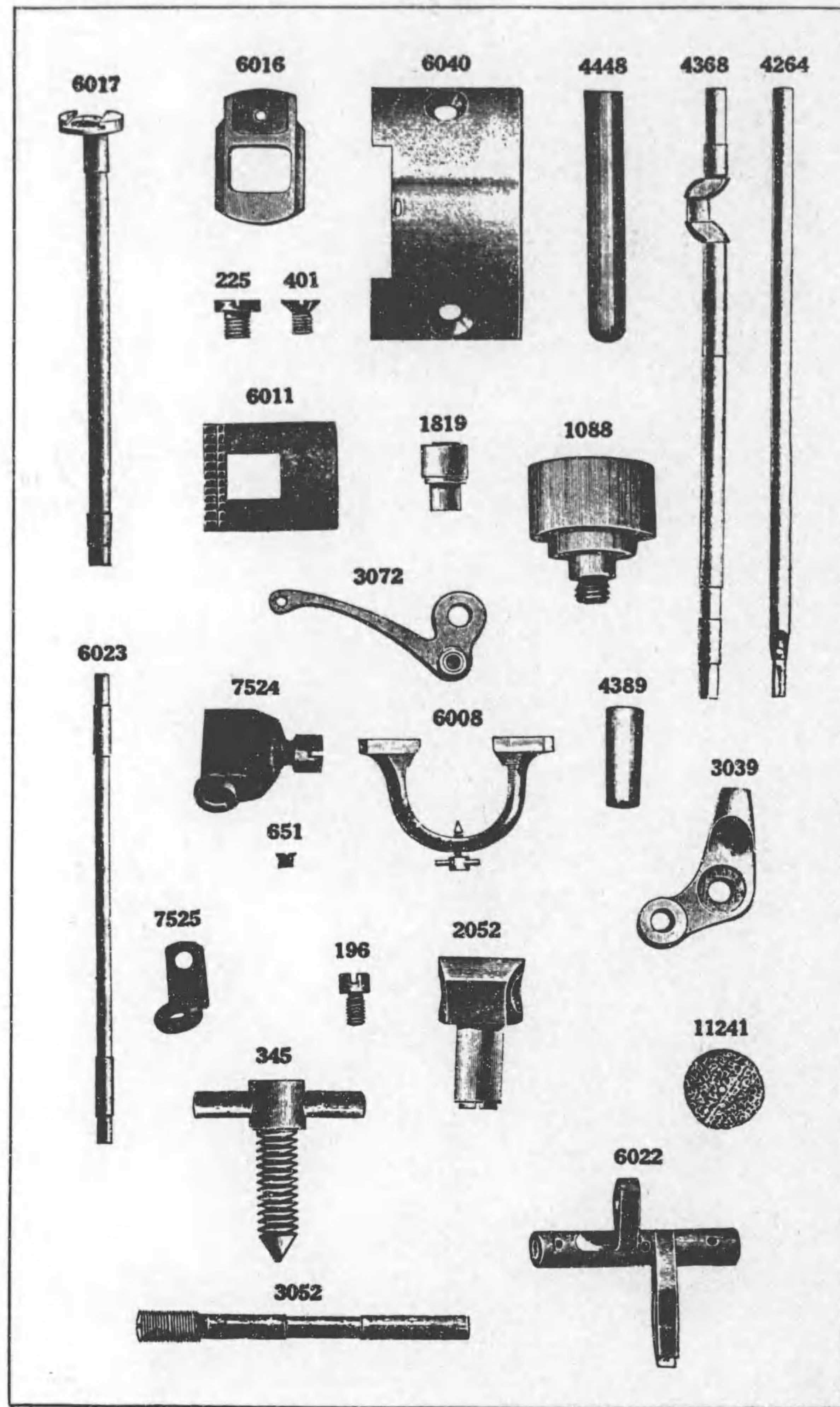

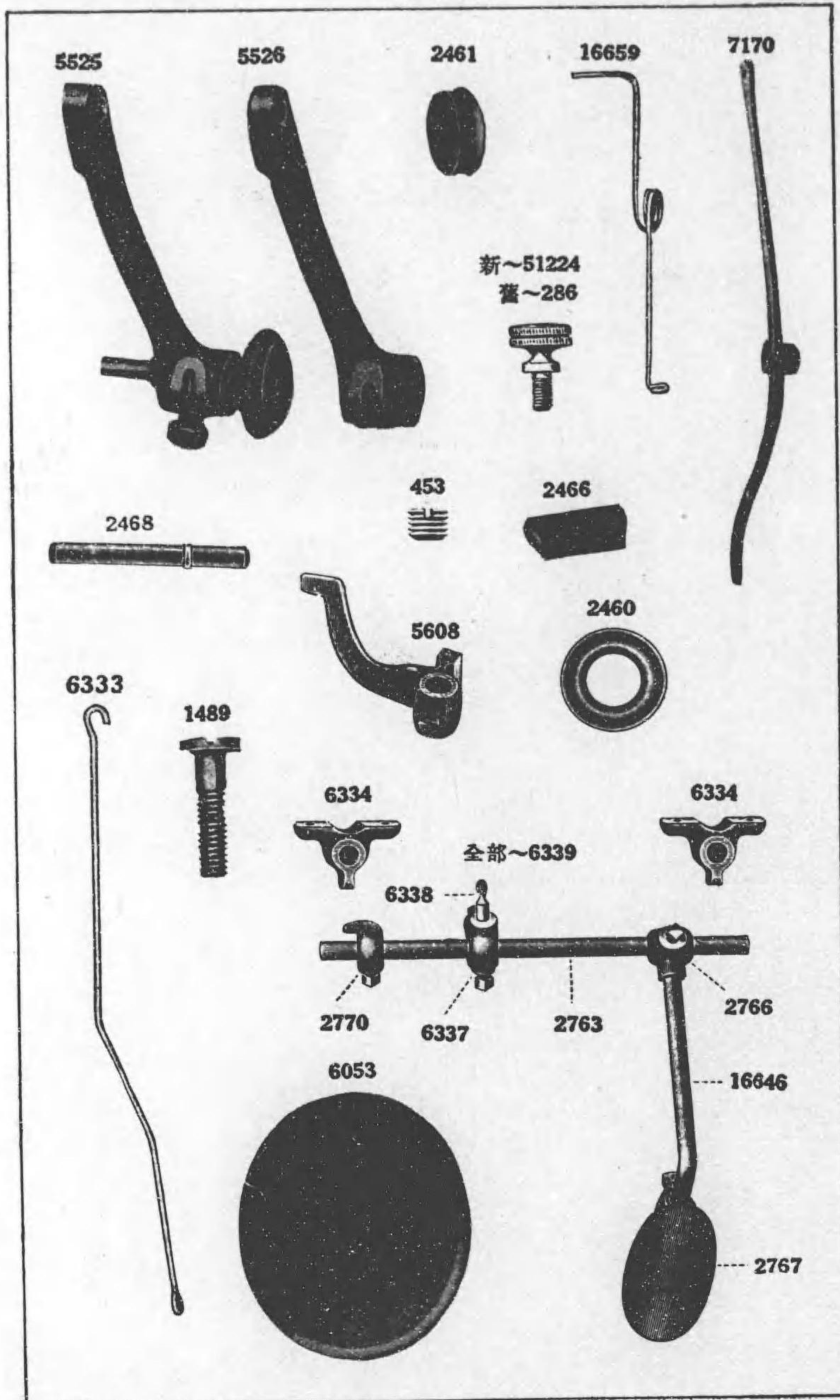

ILLUSTRATION OF PARTS

CLASS

18-22

MACHINE

十八種二十二型ミシン部分品圖解

部分品 番 號	圖解番號	部分品 番 號	圖解番號	部分品 番 號	圖解番號	部分品 番 號	圖解番號
Parts No.	Plate No.	Parts No.	Plate No.	Parts No.	Plate No.	Parts No.	Plate No.
35	56	462	50	2106	53	6462	51
58	51	"	51	"	56	6464	52
76	52	466	53	2180	54	6465	52
77	52	600	53	2196	54	6466	52
102	53	652	54	2197	54	6467	52
112	53	725	50	2203	54	6469	52
144	50	"	53	2205	54	6470	53
145	51	802	55	2206	54	6472	53
155	52	808	52	2211	53	6474	52
156	51	818	51	2212	53	6477	53
164	51	1107	50	2455	56	6479	50
175	52	1253	55	2764	55	6487	52
"	53	1513	51	2766	55	6489	51
176	54	1518	51	2767	55	6692	55
190	54	"	52	2770	55	6703	55
207	51	1528	54	3005	50	6768	53
219	53	1547	54	3012	52	6800	53
231	54	1549	54	3032	51	7124	55
233	52	1560	53	3033	51	7393	55
"	53	1562	56	3037	51	8879	50
248	50	1620	56	3045	52	10141	56
256	50	1813	51	3054	52	11241	56
262	52	1819	52	3286	50	12403	50
290	52	1841	54	4288	50	16022	53
316	54	1868	54	4292	51	16034	50
335	52	2020	50	4302	52	16036	50
356	55	2022	50	4303	52	16045	50
375	51	2049	51	4784	51	16077	55
377	52	"	53	4933	50	16095	54
389	50	2070	52	5459	52	16102	51
398	53	2073	53	6018	51	16107	54
399	54	2076	53	6024	51	16128	55
418	56	2078	53	6028	53	16129	55
440	54	2080	53	6055	55	16130	55
443	50	2082	53	6337	55	16143	50
446	51	2084	53	6338	55	16171	53
"	52	2086	53	6458	54	16194	52
448	50	2090	53	6459	51	16196	52
457	52	2102	53	6460	51	16240	55
460	51	2103	53	6461	51	16264	50

部分品 番 號	圖解番號	部分品 番 號	圖解番號	部分品 番 號	圖解番號	部分品 番 號	圖解番號
Parts No.	Plate No.	Parts No.	Plate No.	Parts No.	Plate No.	Parts No.	Plate No.
16266	50						
16268	52						
16270	52						
16271	56						
16272	56						
16278	50						
16279	55						
16646	55						
27305	56						
27306	56						
27307	56						
27308	56						
27321	56						
27322	56						
37326	56						
27541	56						
50037	53						
50116	55						
50356	56						
51072	55						
51224	50						
51581	55						

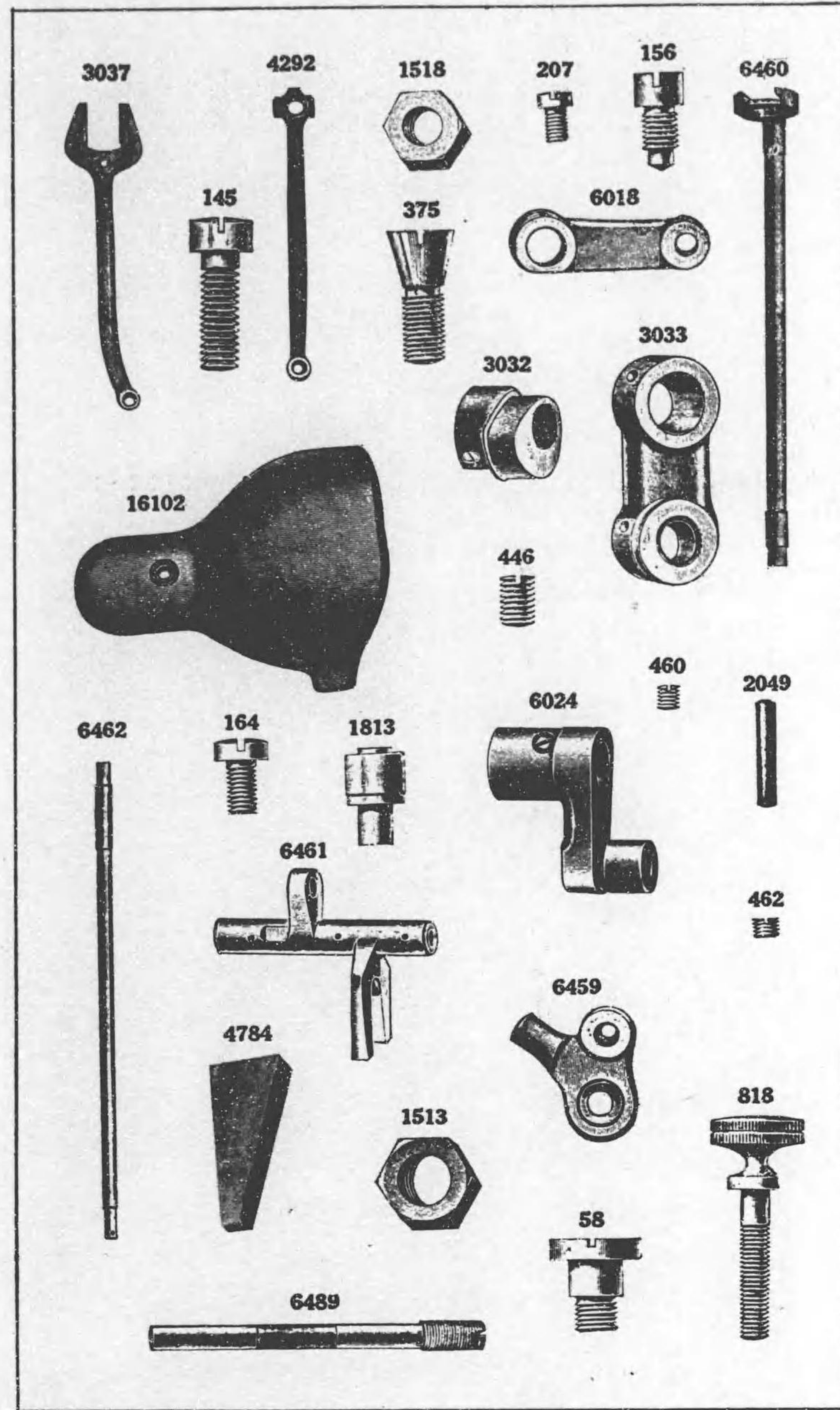
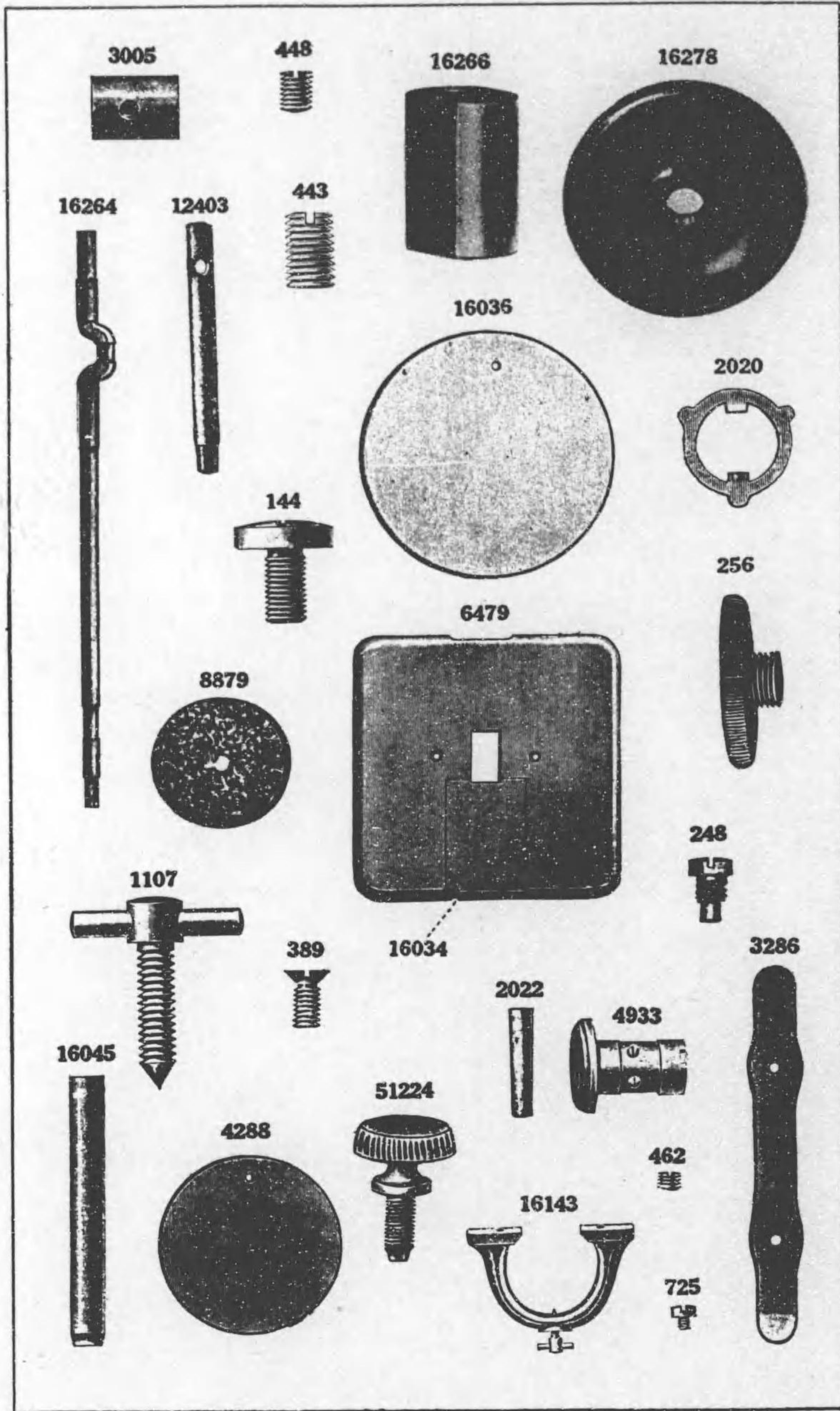

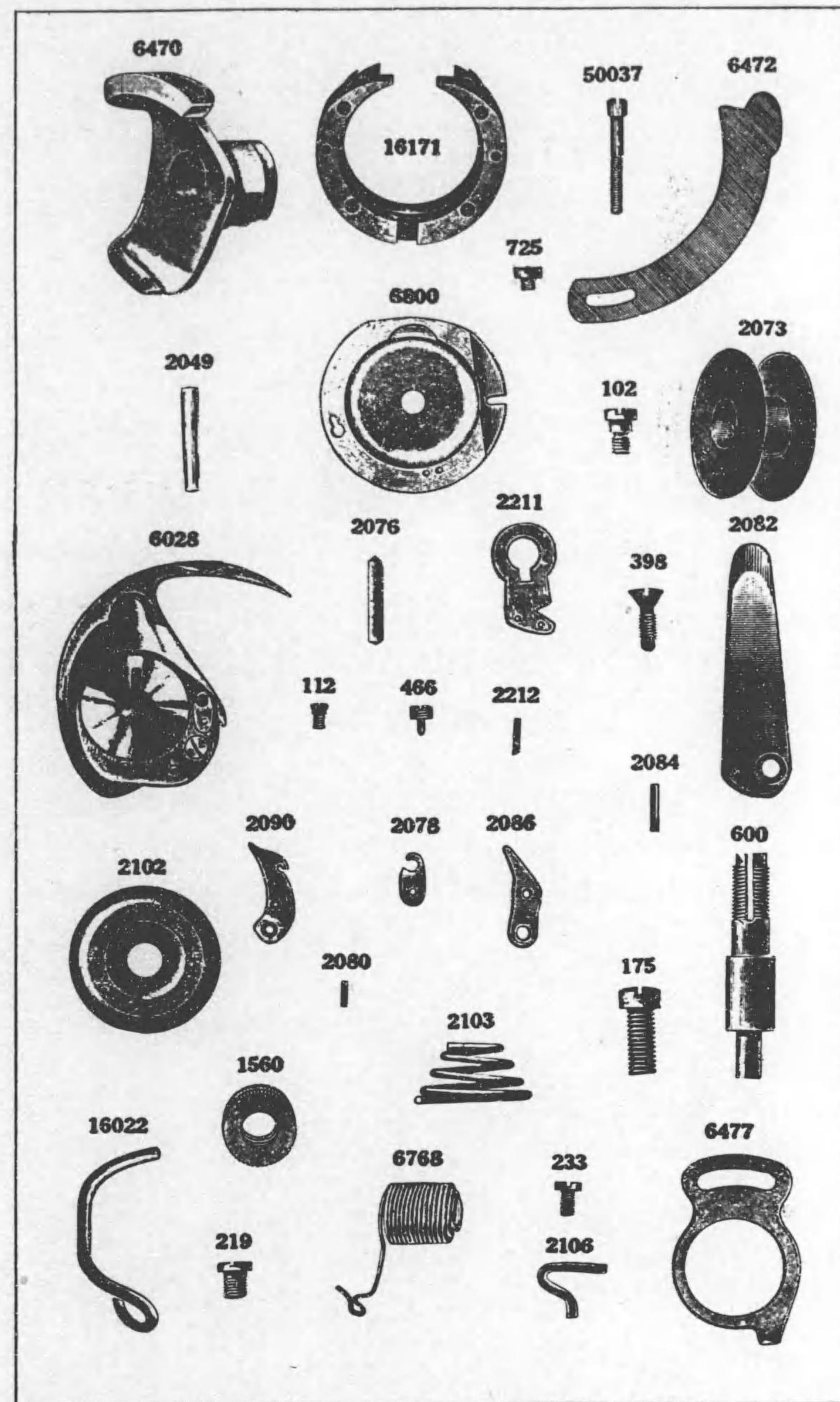
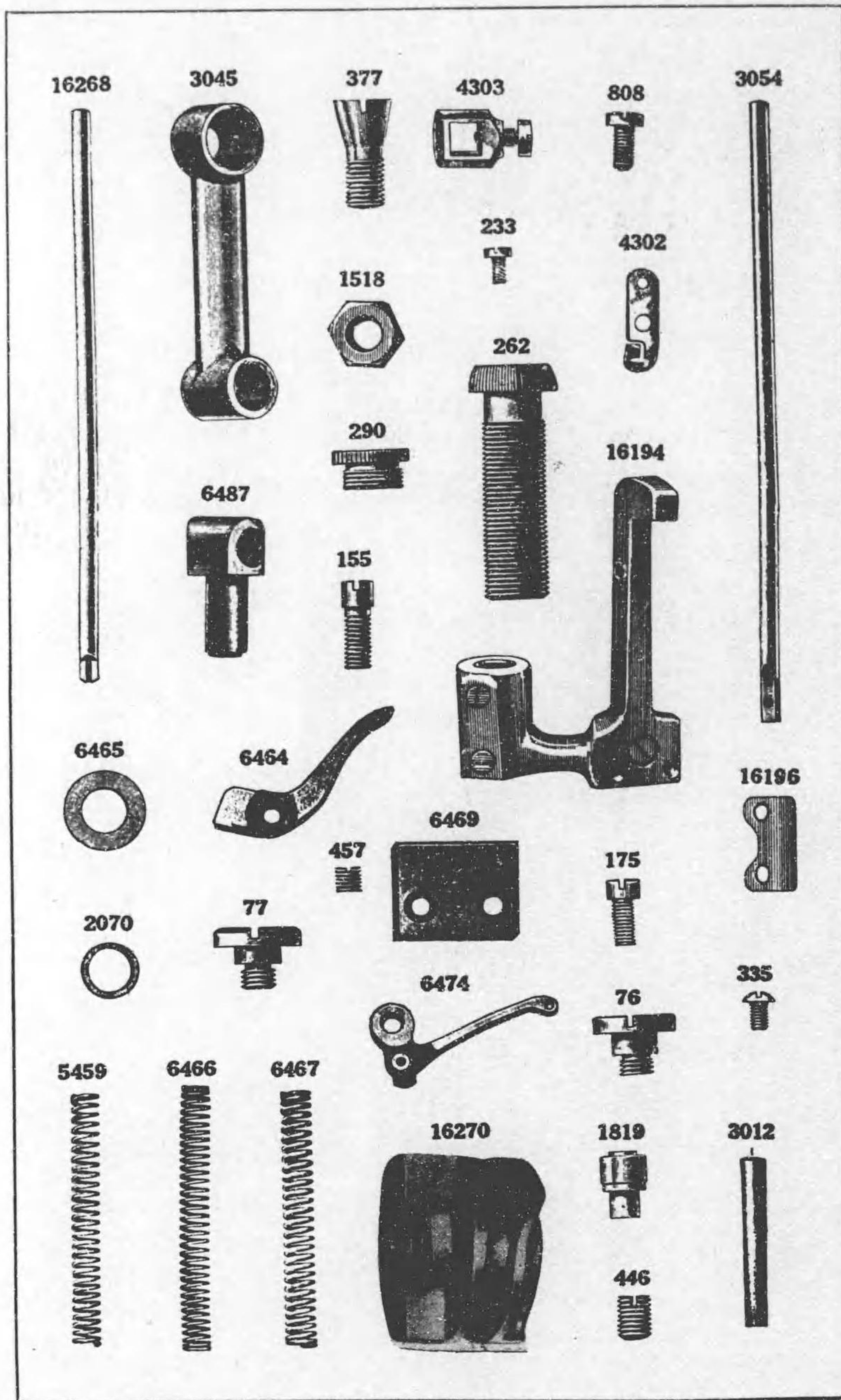

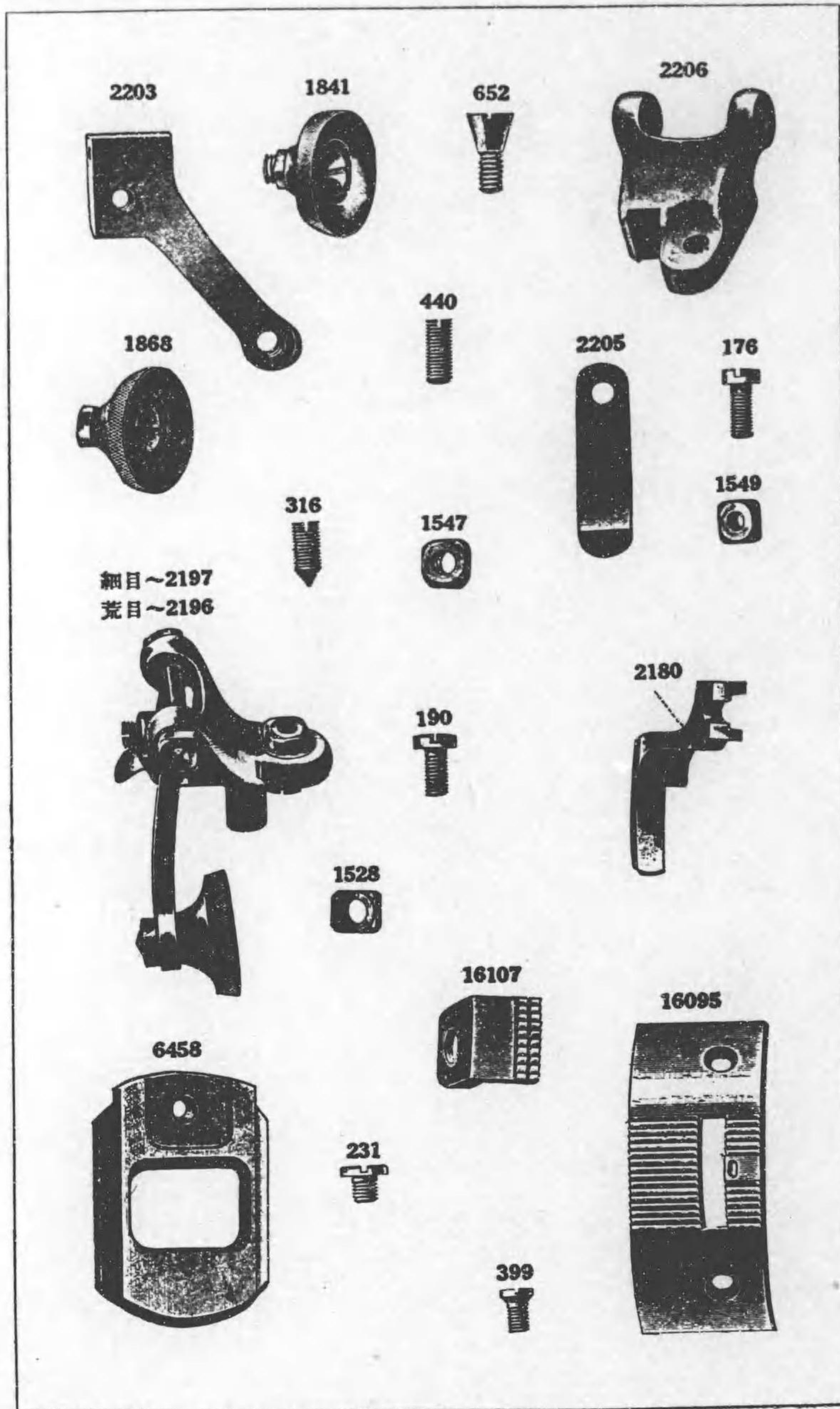

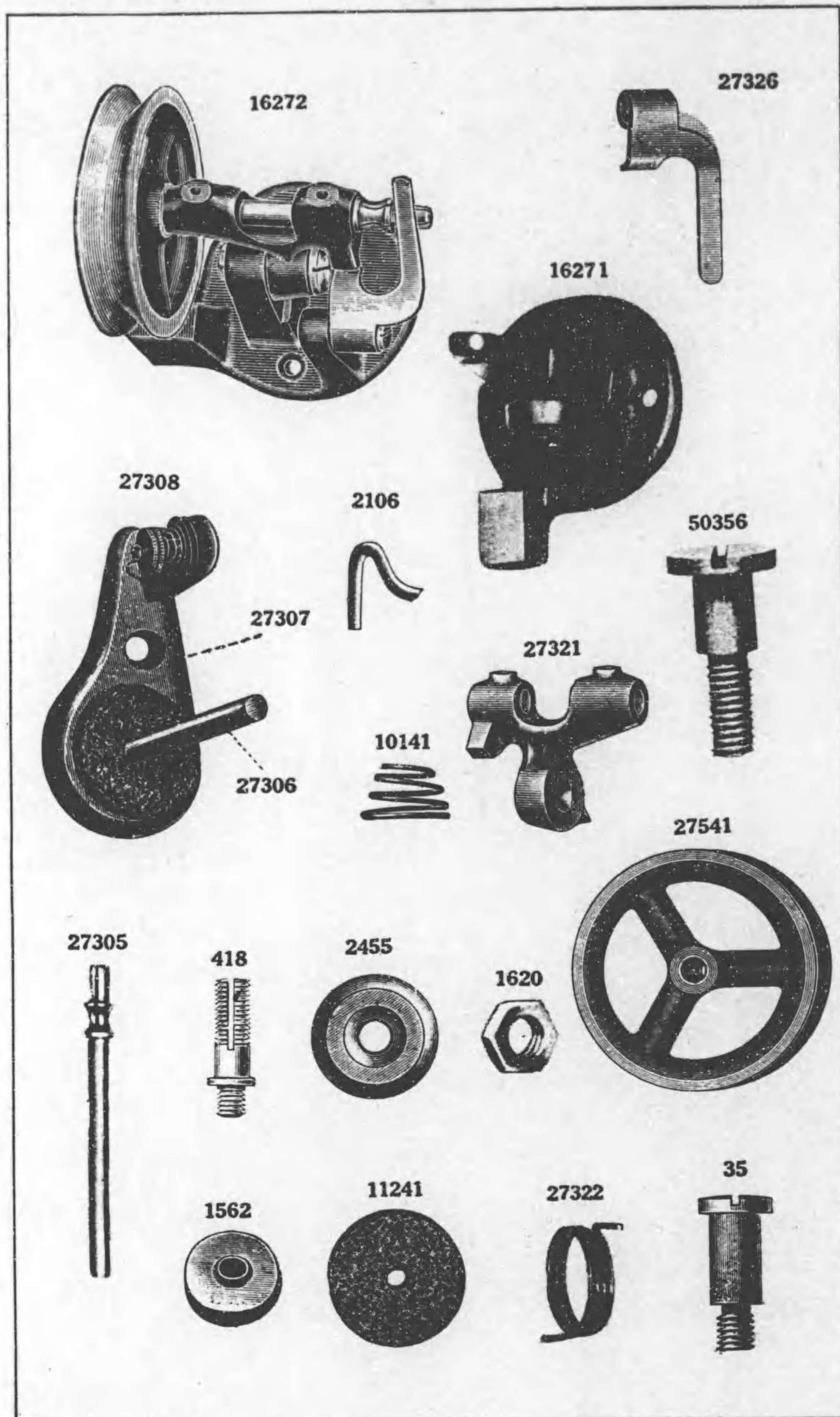

ILLUSTRATION OF PARTS

CLASS

29K58, 29K60

MACHINES

二十九種 K 五十八型
二十九種 K 六十型

ミ
シ
ン
部
分
品
圖
解

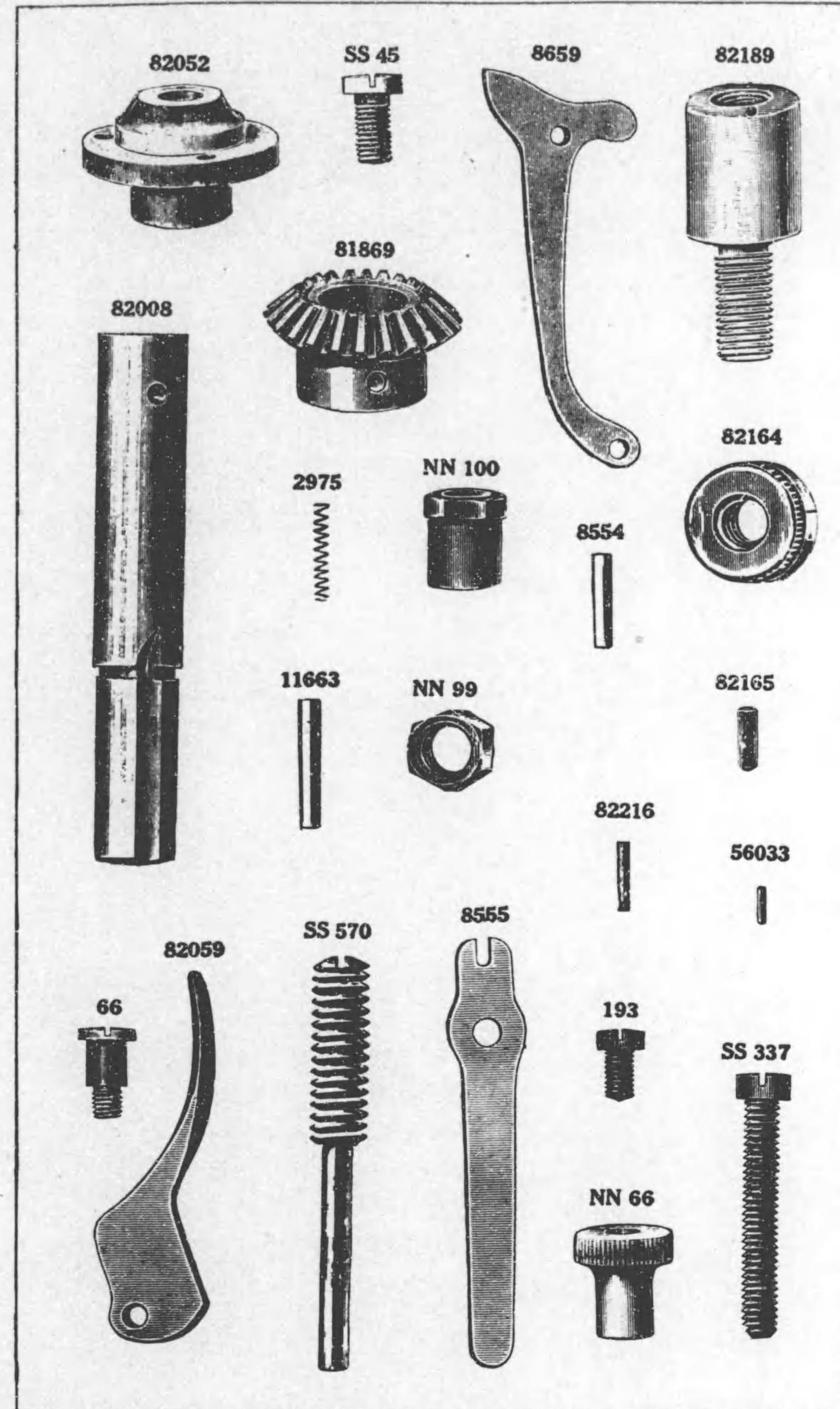
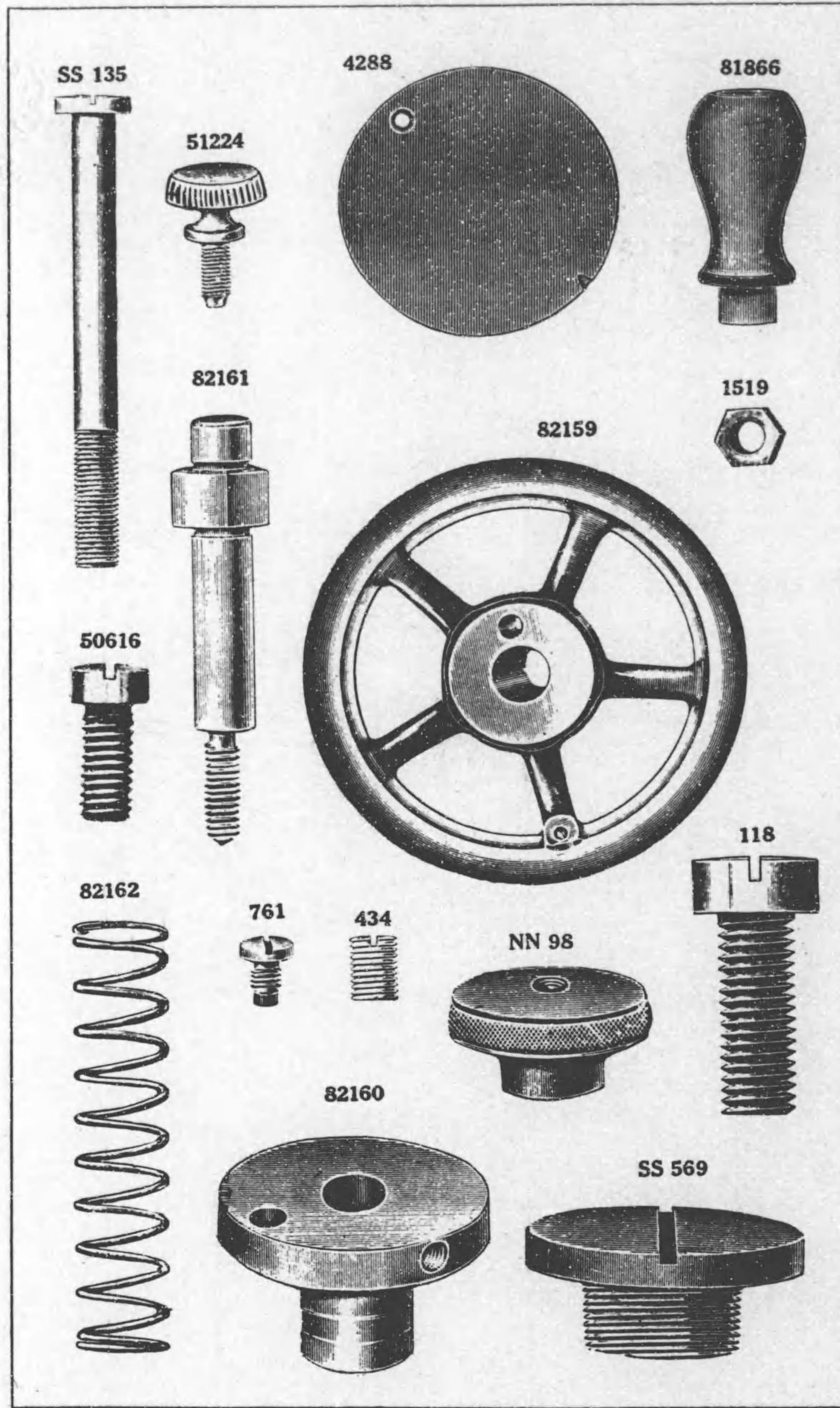

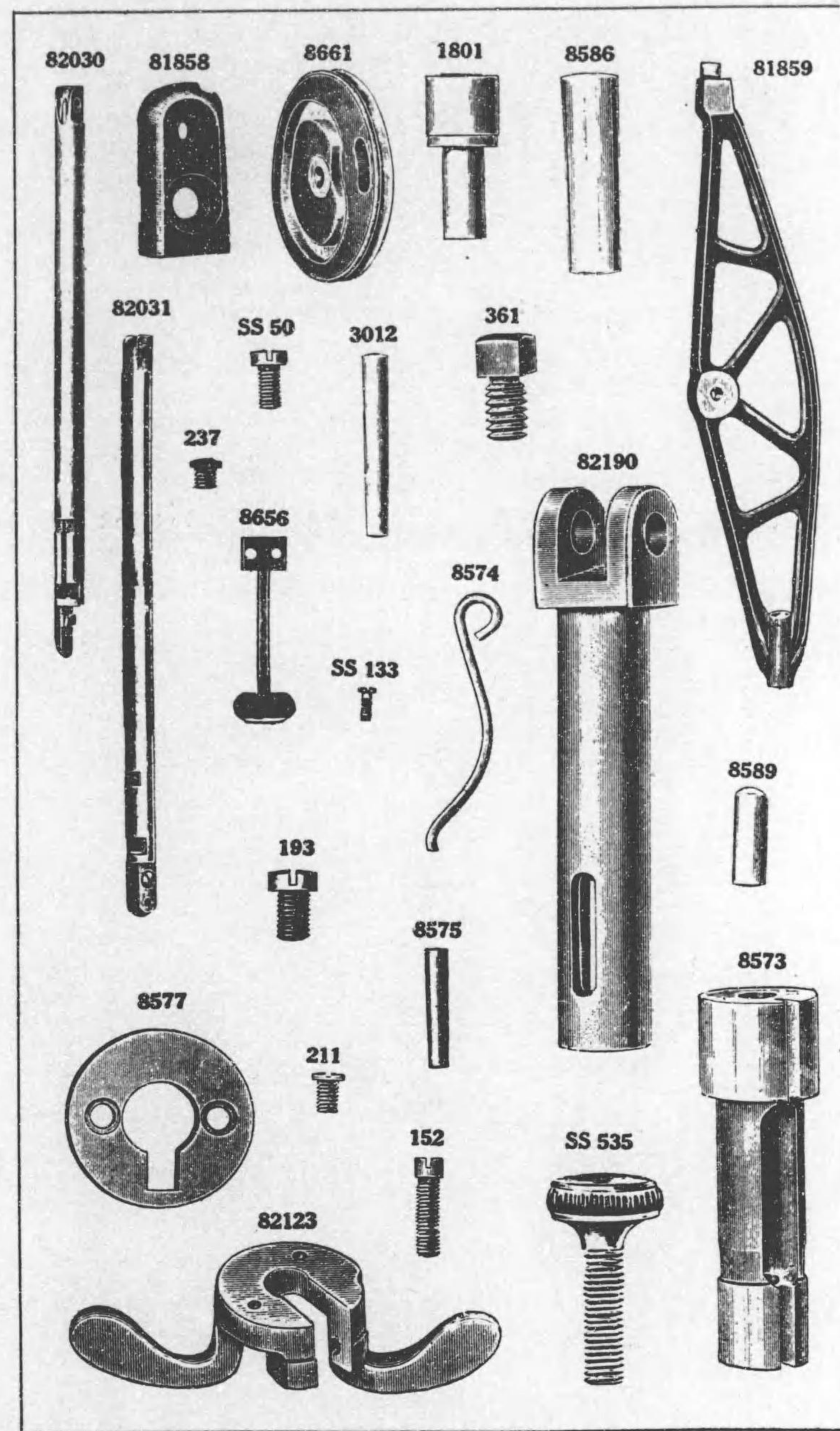
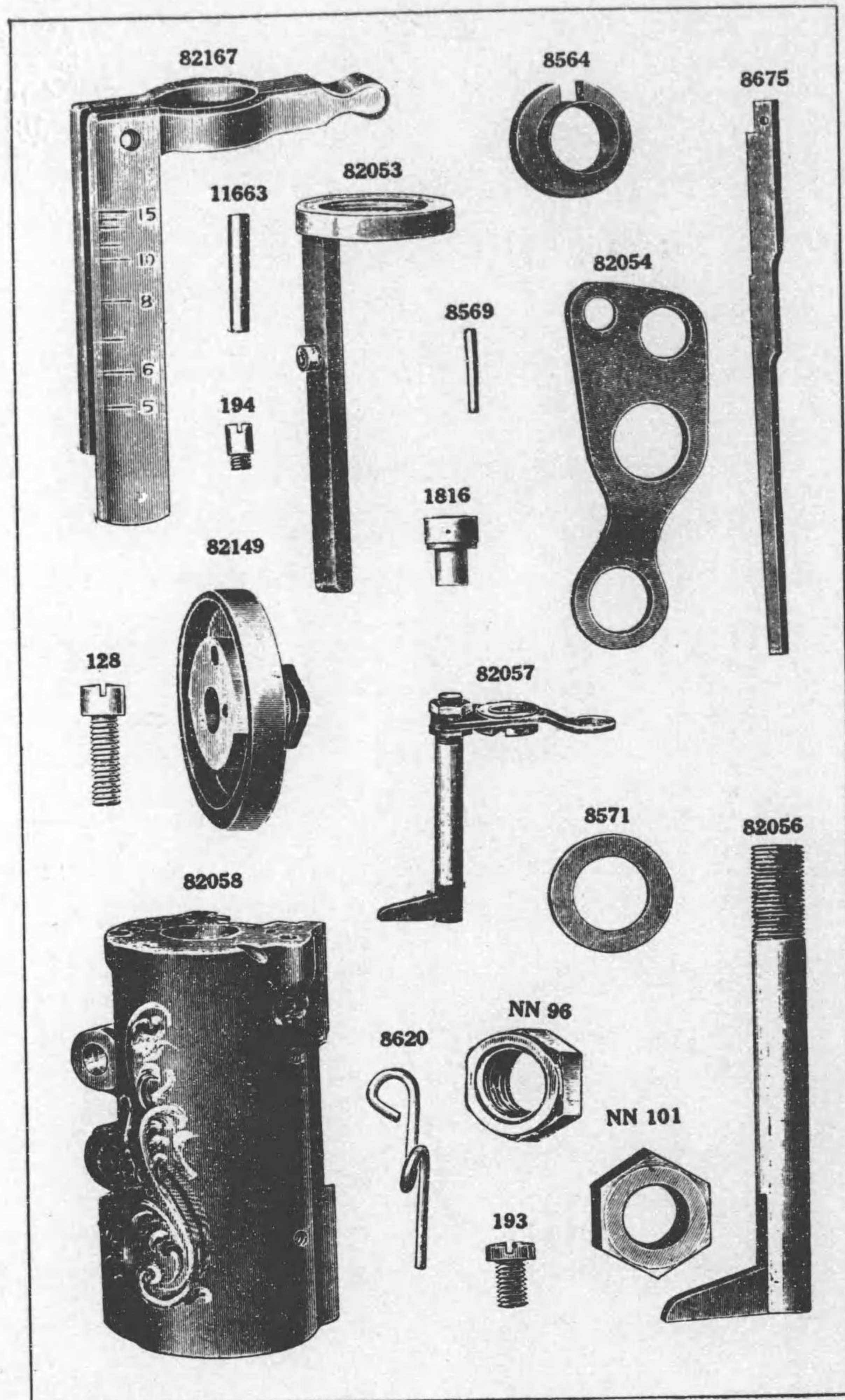

第六十一圖

29K58, 29K60

PLATE 61

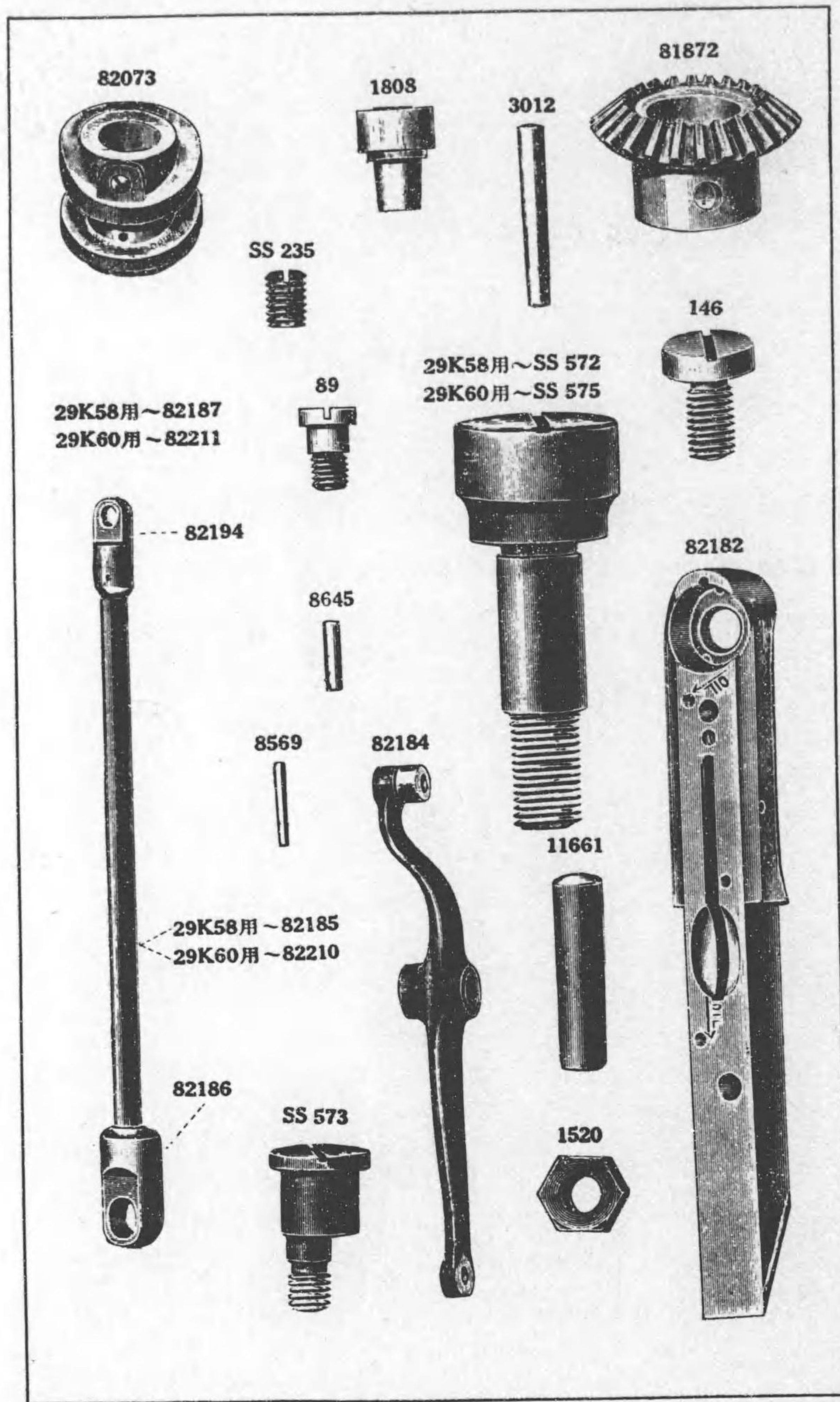
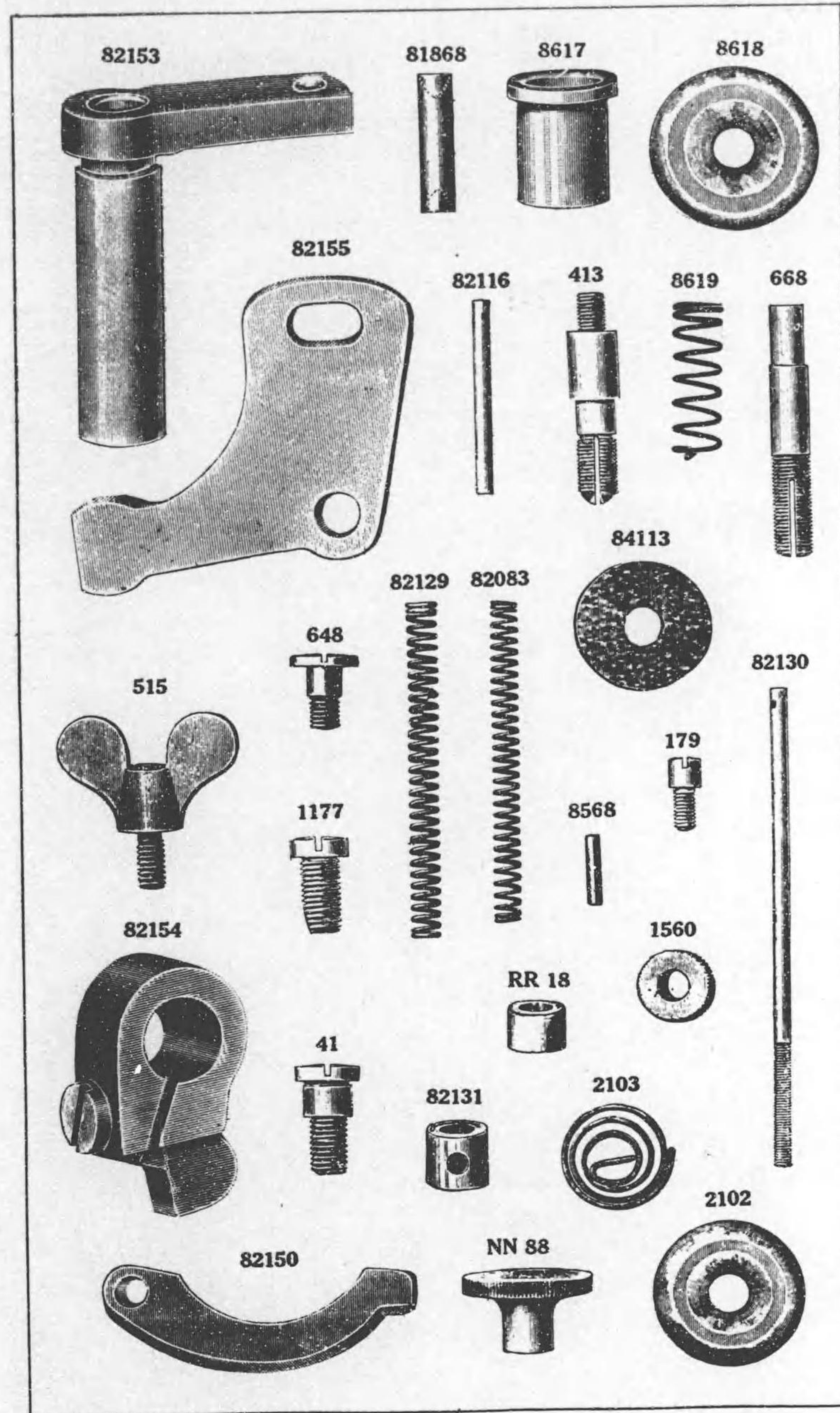

PLATE 62

29K58, 29K60

第六十二圖



第六十三圖

29K58, 29K60

PLATE 63

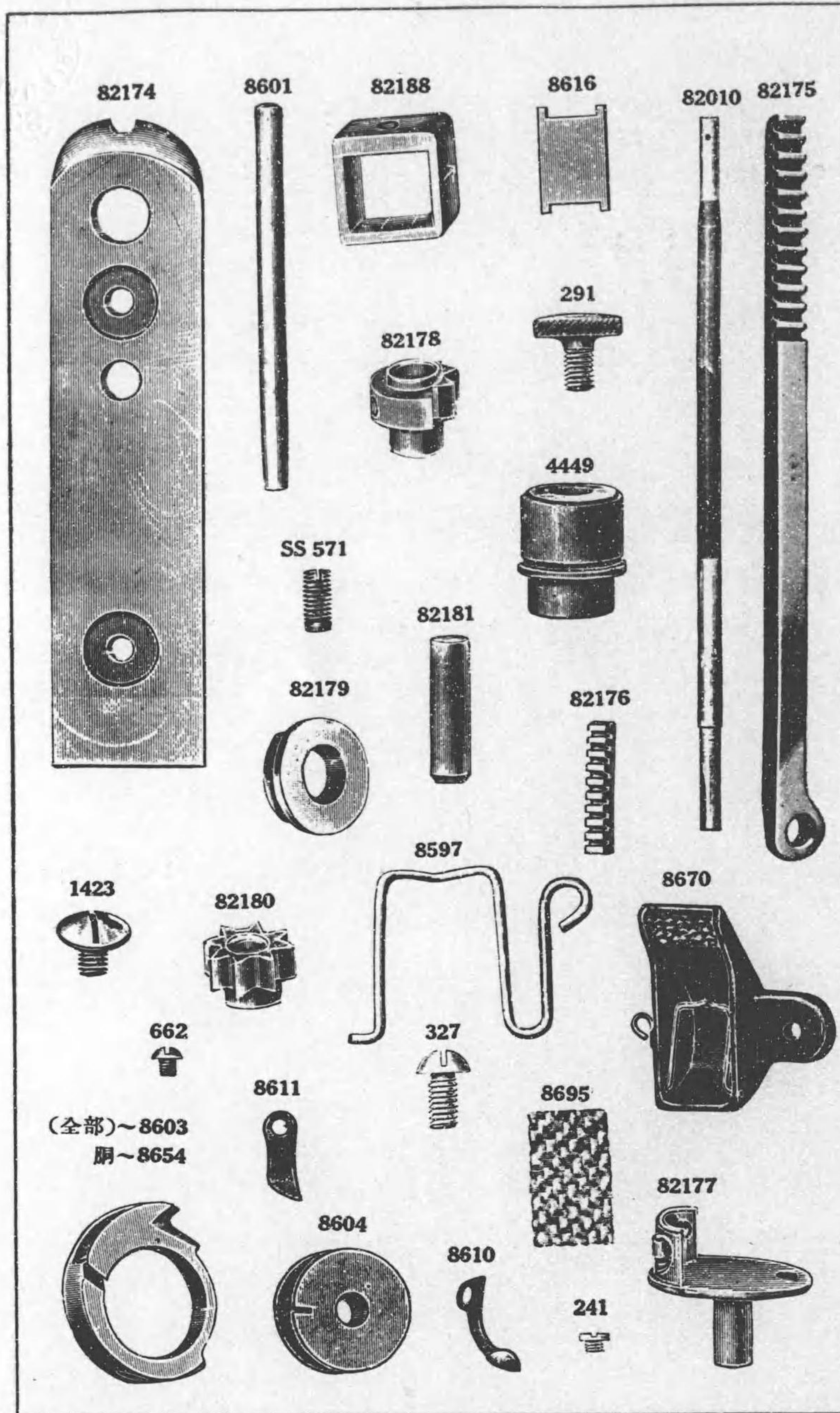
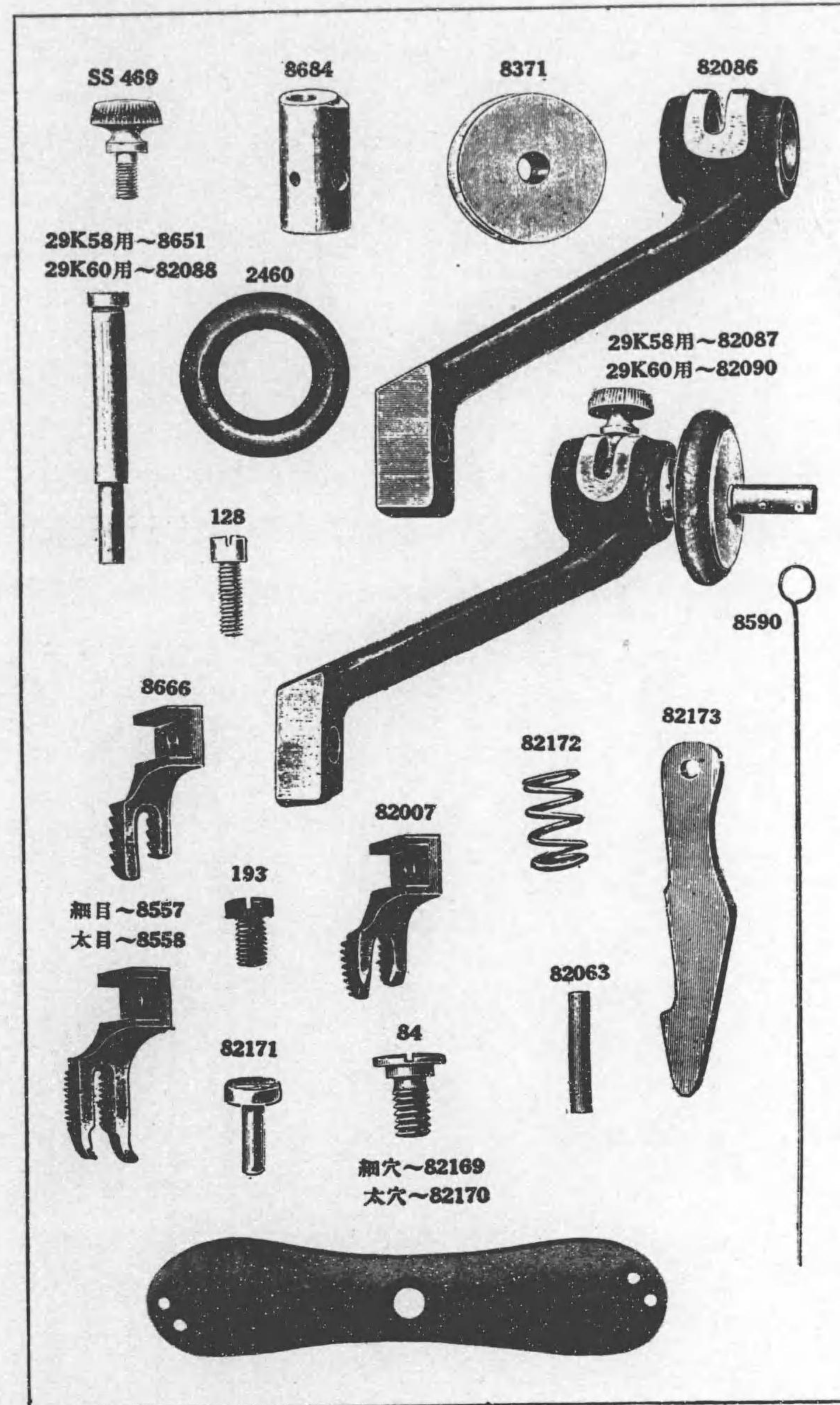

PLATE 64

29K58, 29K60

第六十四圖



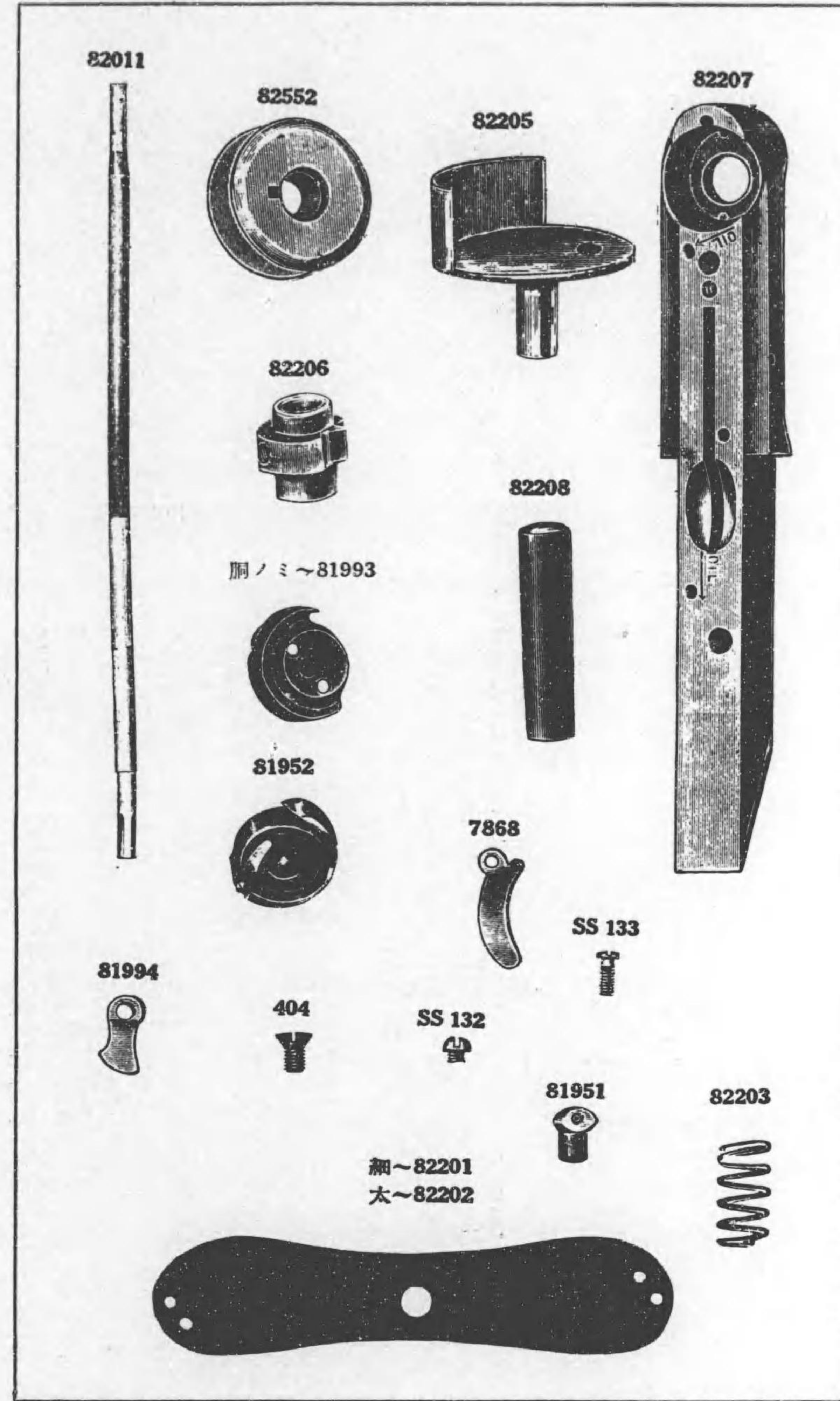
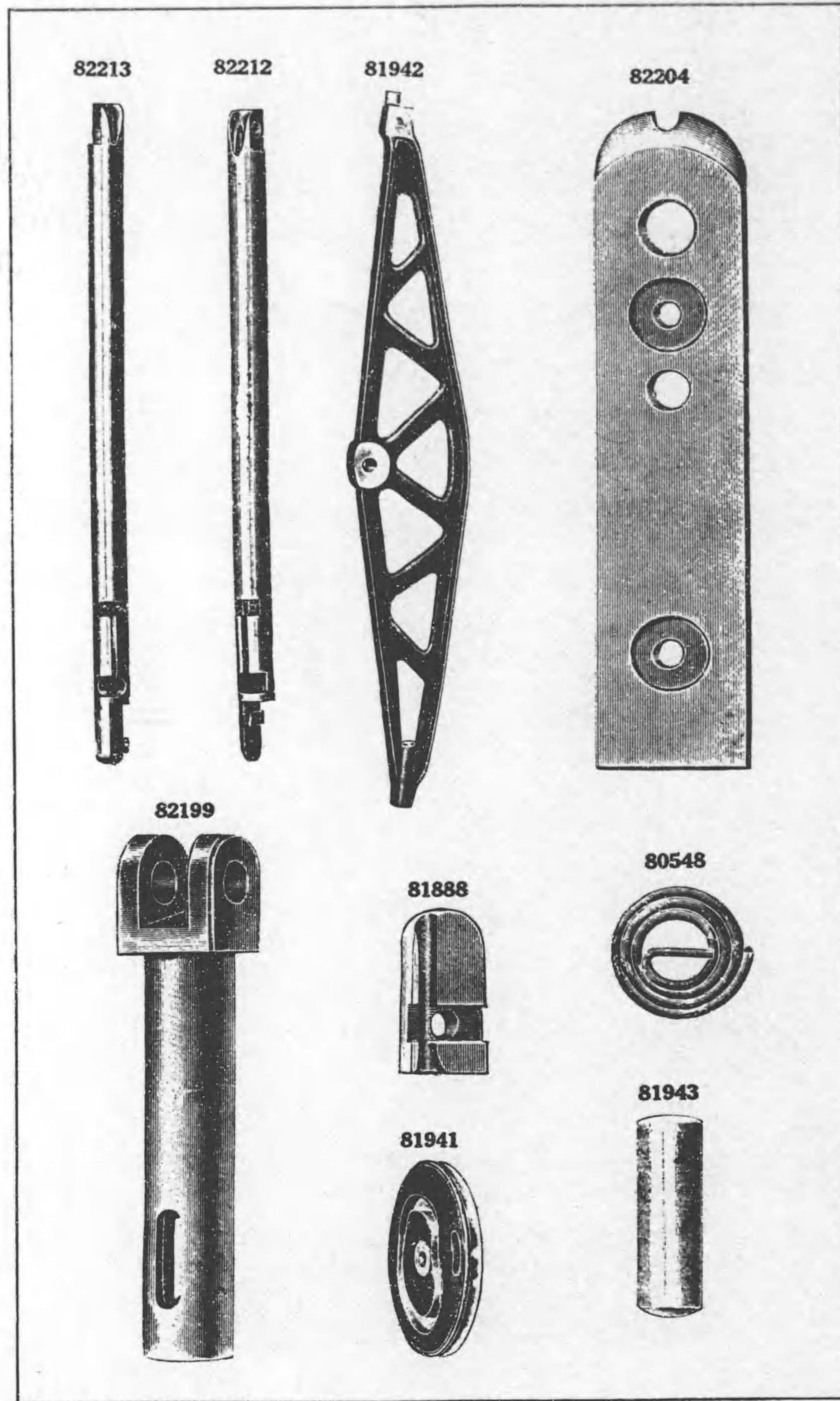

ILLUSTRATION OF PARTS

CLASS

31K20, 44K13

MACHINES



三十一種 K 二十型
四十四種 K 十三型

ミ
シ
ン
部
分
品
圖
解

31K20, 44K13

部分品 番 號	圖解番號	部分品 番 號	圖解番號	部分品 番 號	圖解番號	部分品 番 號	圖解番號
Parts No.	Plate No.	Parts No.	Plate No.	Parts No.	Plate No.	Parts No.	Plate No.
35	76	690	72	2102	72	11167	70
76	77	691	74	2106	76	11170	70
144	67	725	72	2135	68	11204	72
145	71	732	76	2419	71	11241	76
157	69	748	67	2455	76	12142	74
178	77	766	77	2523	71	12143	74
190	68	775	72	2532	71	12144	73
190	74	794	69	2533	71	12150	68
208	74	802	77	2763	77	12152	68
210	68	808	69	2765	77	12166	72
219	67	818	70	2766	77	12193	67
223	75	854	67	2767	77	12237	77
225	72	858	69	2770	77	12240	77
226	70	878	70	2778	77	12241	77
233	69	896	68	2827	68	12258	74
248	68	907	71	2862	68	12260	73
256	68	908	68	2973	71	12261	74
284	76	936	69	2974	71	12327	70
307	69	966	69	2975	71	12329	72
313	68	988	70	3033	69	12335	74
356	77	1053	71	3039	70	12357	67
375	69	1065	69	3093	70	12368	68
391	71	1128	70	3094	72	12369	74
418	76	1266	71	4302	69	12370	74
435	72	1513	69	4303	69	12376	69
446	68	1518	69	4307	72	12379	69
448	67	"	70	4933	68	12381	69
"	68	1519	68	5596	77	12382	69
"	70	1520	70	5598	77	12383	69
"	72	1521	77	5599	77	12388	70
"	77	1560	72	5601	77	12389	70
453	69	1562	76	5735	77	12391	70
453	70	1619	68	6267	75	12398	72
457	70	1620	76	6337	77	12403	67
462	68	1813	69	7336	72	12404	72
591	71	1904	69	8505	68	12408	72
592	71	2020	68	8582	67	12409	72
624	72	2022	68	10141	76	12410	72
688	70	2049	71	11104	67	12411	74
689	70	2062	70	11119	67	12412	74

31K20, 44K13

部分品 番 號	圖解番號	部分品 番 號	圖解番號	部分品 番 號	圖解番號	部分品 番 號	圖解番號
Parts No.	Plate No.	Parts No.	Plate No.	Parts No.	Plate No.	Parts No.	Plate No.
12415	77	20649	71	27306	76	44K13	
12416	77	20650	71	27307	76		
12424	70	20654	71	27308	76	868	67
12425	73	20755	71	27538	76	16506	78
12426	73	20756	71	27540	76	16509	78
12427	67	20757	71	27541	76	16510	77
12431	72	24009	71	27587	76	16511	78
12432	72	24036	68	27875	76	19496	70
12450	73	24104	70	28663	75	24969	78
12451	73	24131	67	29633	69	87698	77
12453	67	24297	68	32572	72		
12454	67	24323	71	32574	72	上記以外ハ31K20 型ト同ジ	
12457	74	24324	71	43944	72		
12459	70	24325	71	43945	72		
12464	73	24983	74	43946	72		
12474	74	25866	76	43976	69		
12480	67	25874	76	44125	69		
12481	74	25888	75	44134	70		
12482	74	25920	75	44136	73		
12483	74	25922	75	44137	73		
15072	76	25924	75	44181	68		
19131	71	25990	75	44212	77		
19336	74	25991	75	50327	72		
19406	71	25992	75	50356	76		
19448	70	26161	75	51224	67		
19496	70	26428	75	"	68		
19497	73	26640	75	52454	72		
20058	68	26641	75	84789	77		
20059	70	26643	75	86188	73		
20060	72	26646	75	97502	77		
20117	73	26650	75				
20119	73	26670	75				
20120	73	26671	75				
20188	69	26675	75				
20197	68	26678	75				
20270	74	26679	75				
20283	68	26719	75				
20284	69	26724	75				
20311	73	27302	76				
20348	73	27303	76				

第六十七圖

31K20, 44K13

PLATE 67

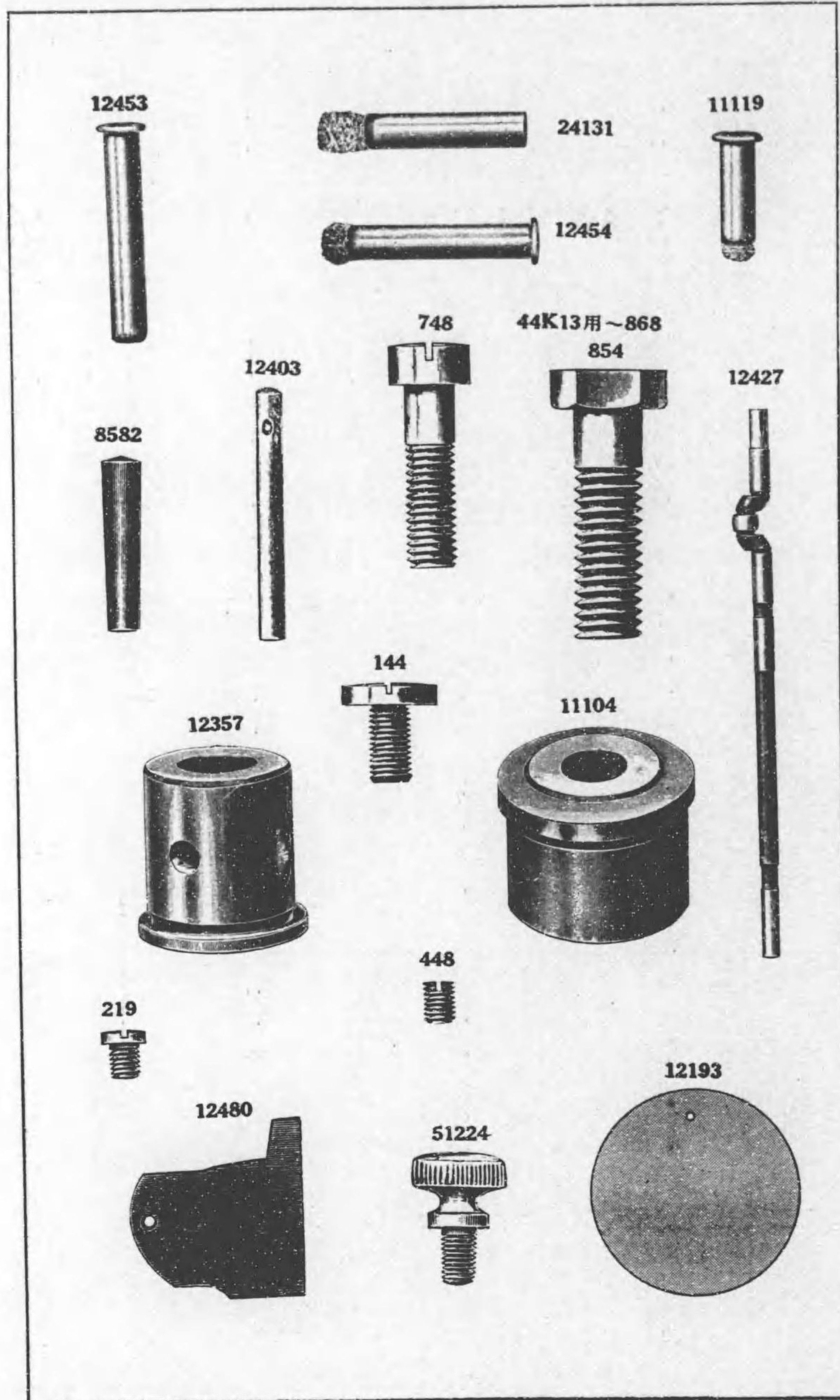
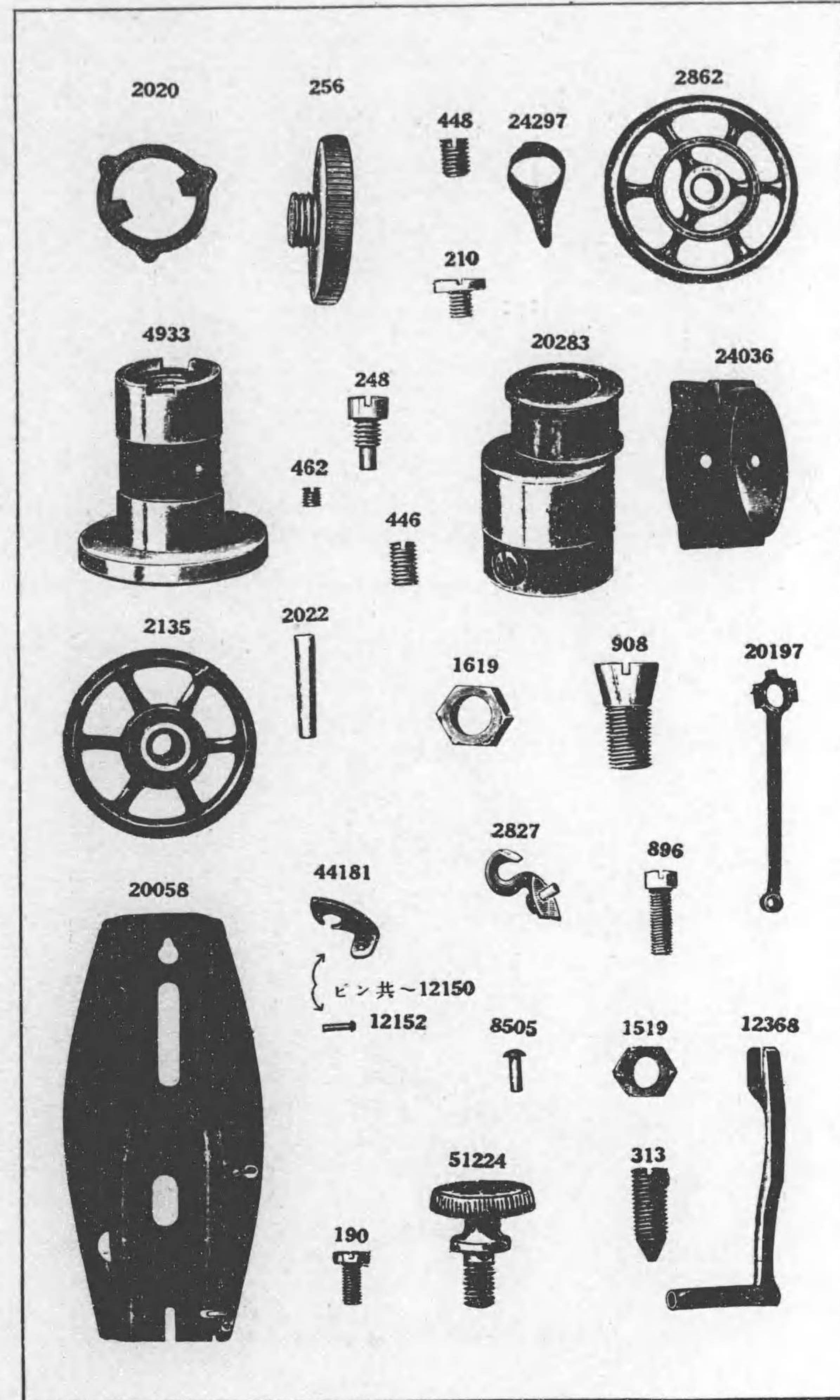
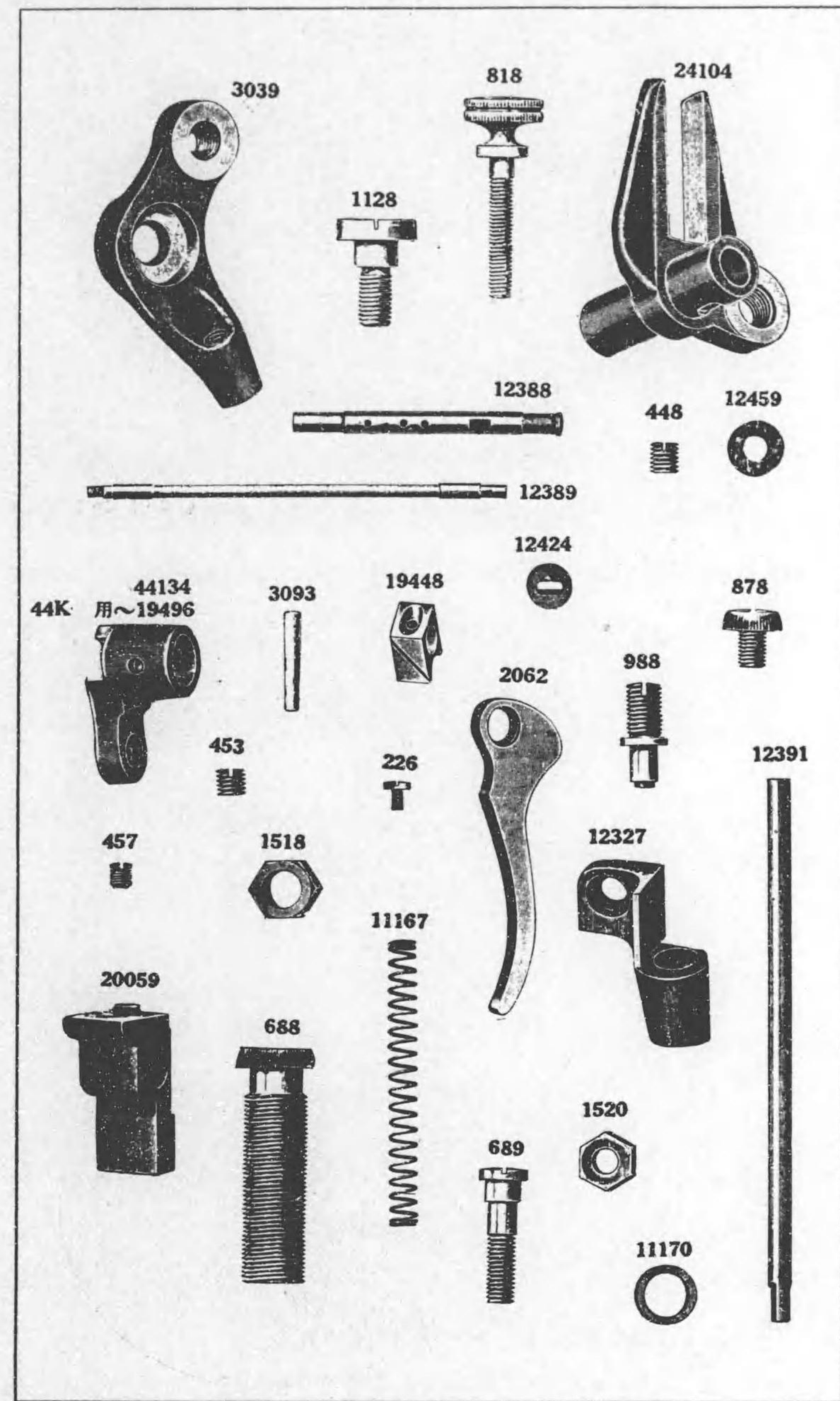
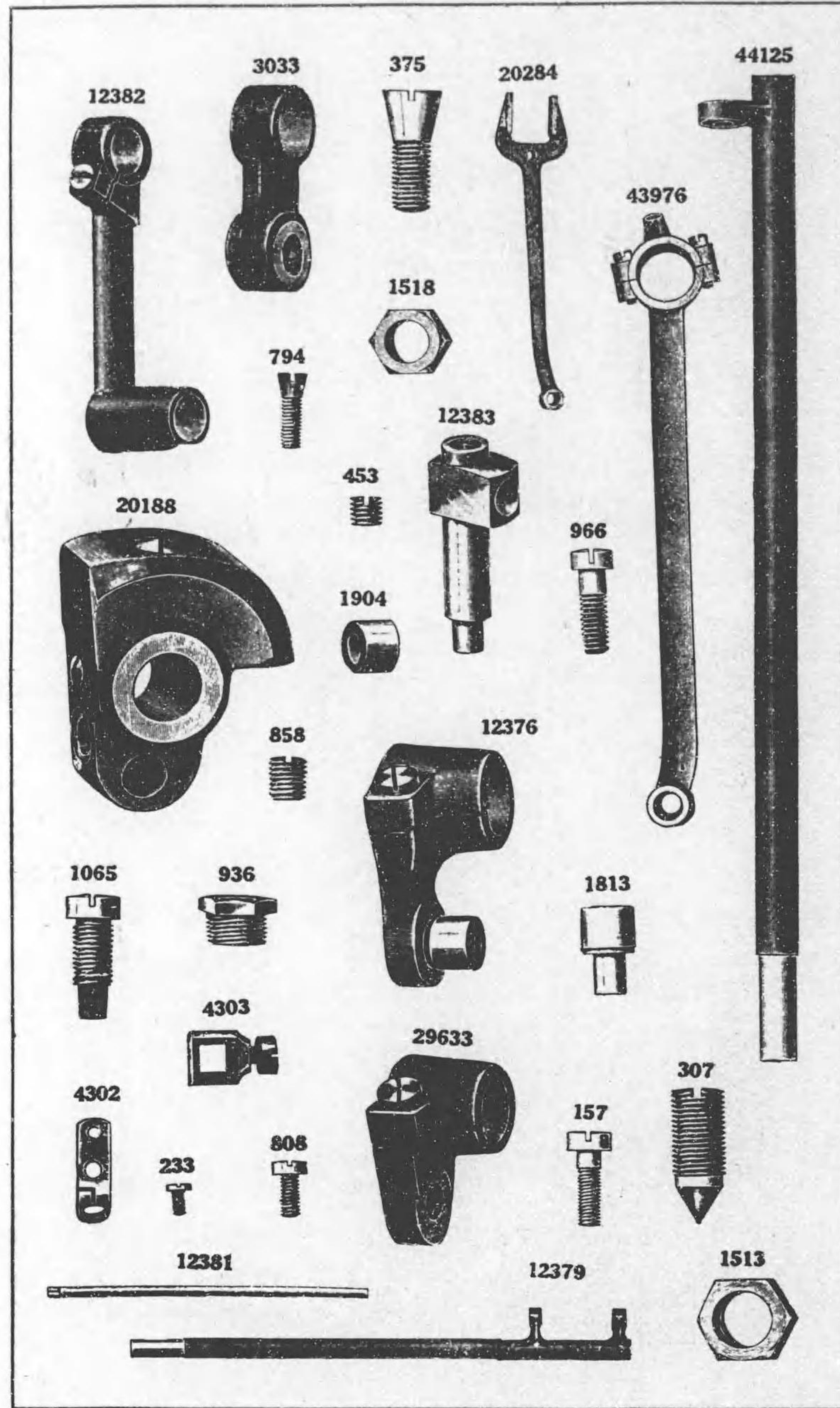

PLATE 68

31K20, 44K13

第六十八圖





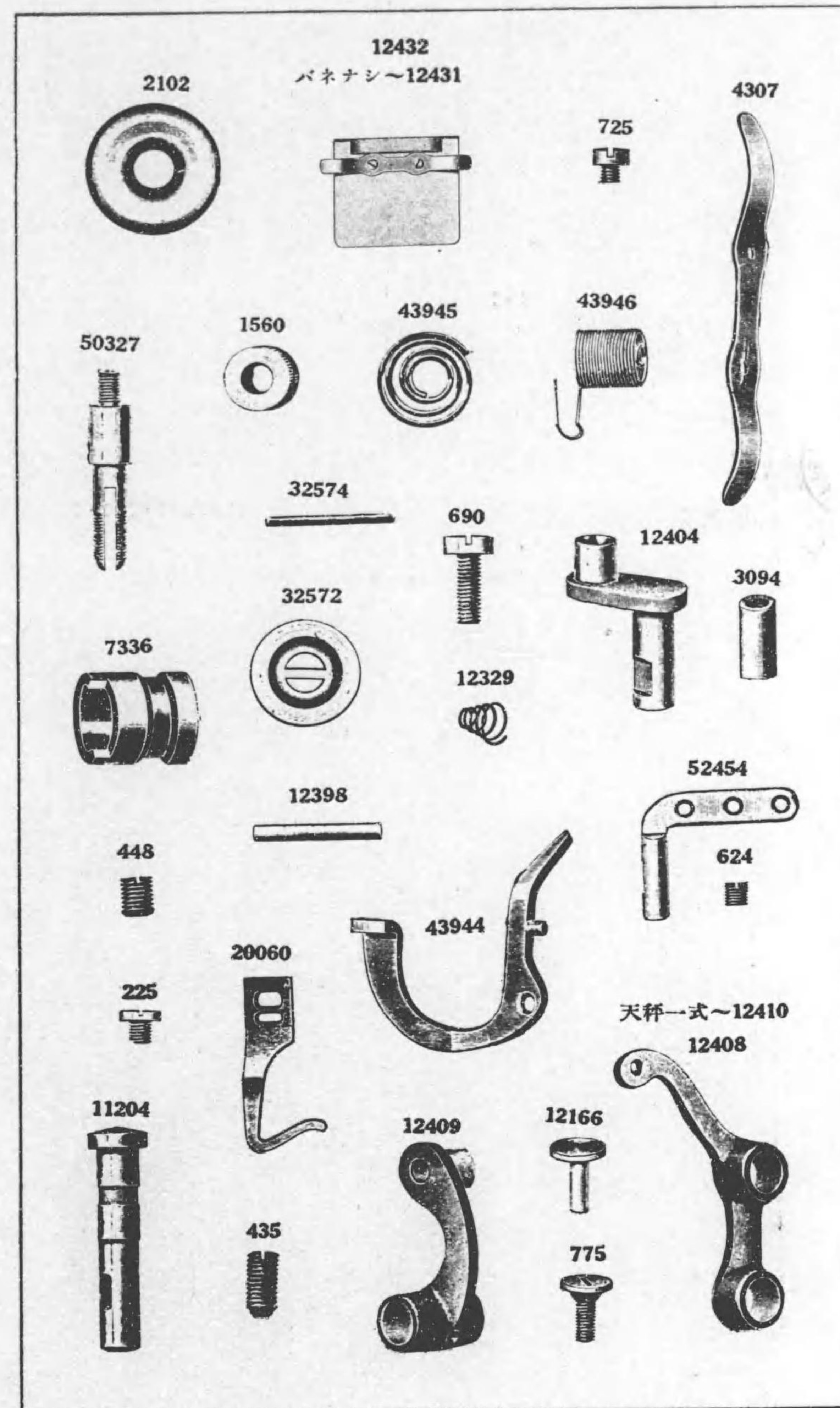
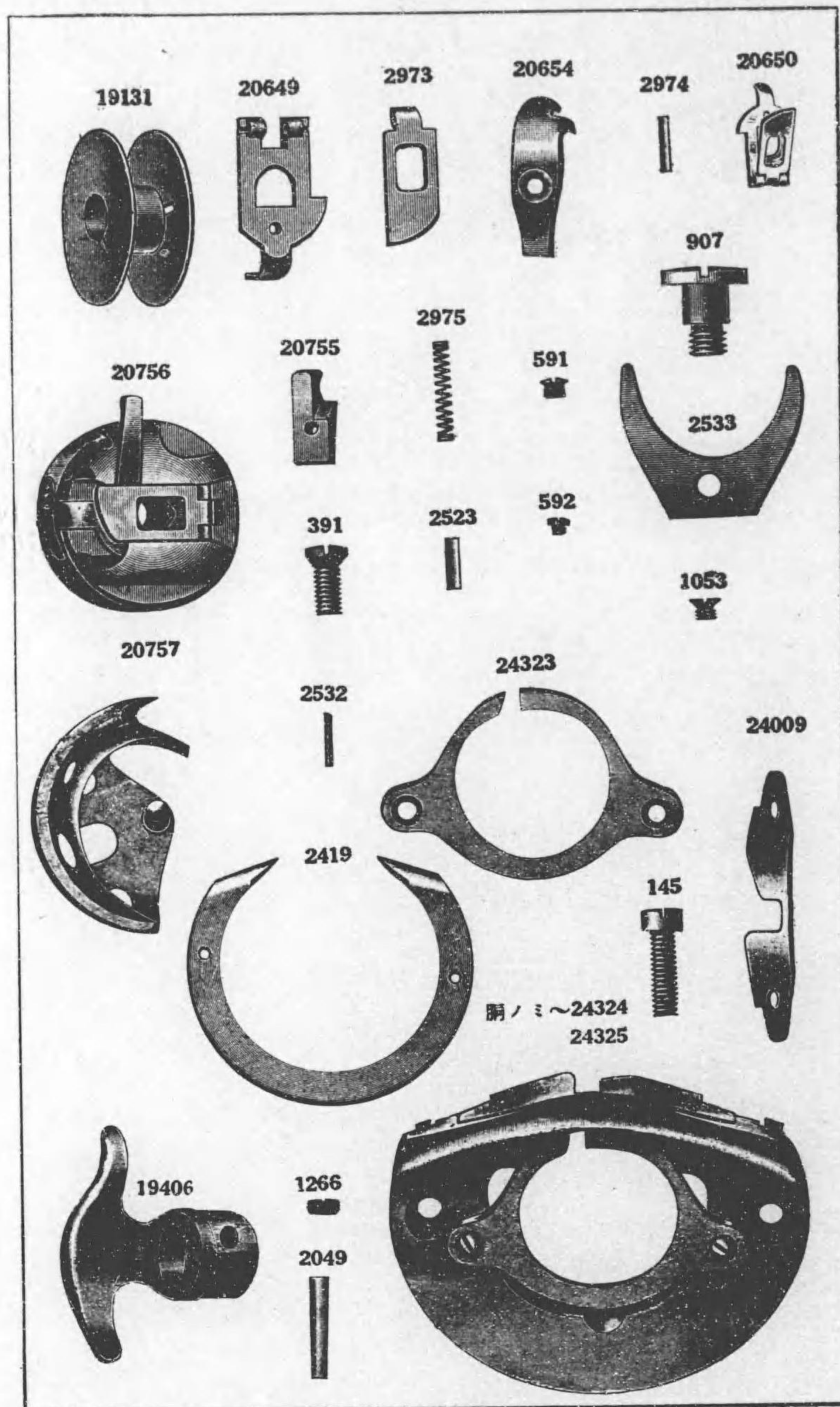

第七十三圖

31K20, 44K13

PLATE 73

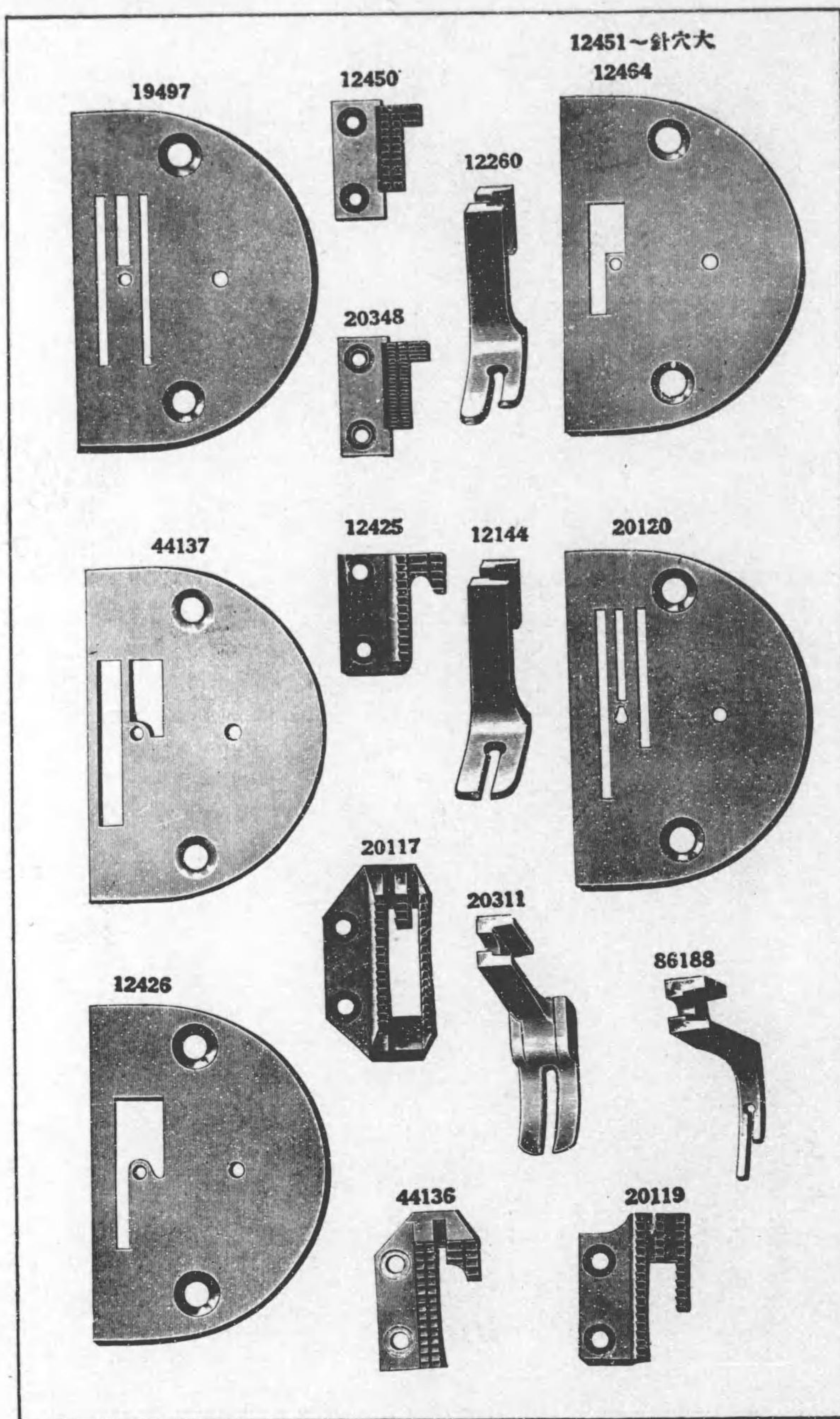
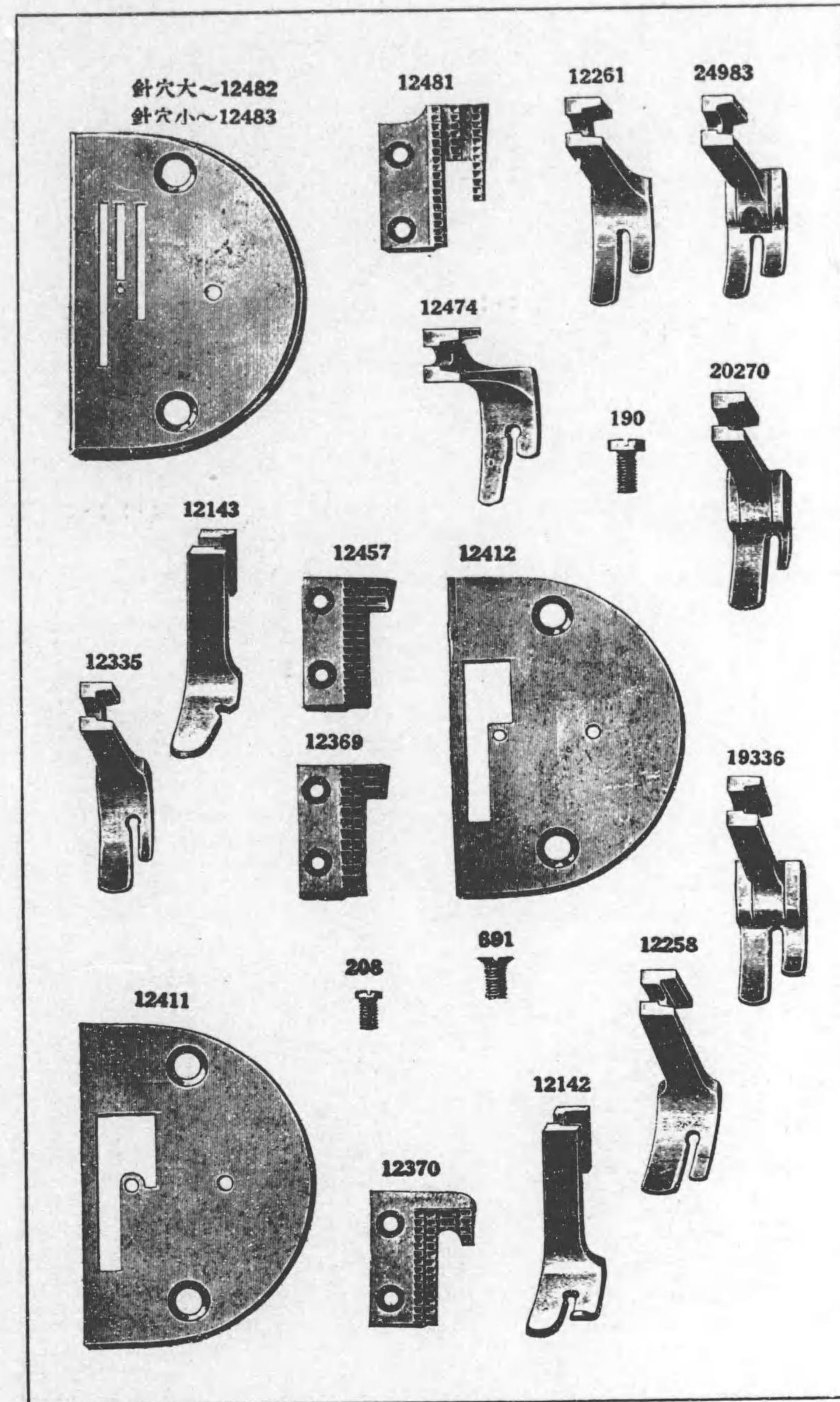

PLATE 74

31K20, 44K13

第七十四圖



第七十五圖

31K20, 44K13

PLATE 75

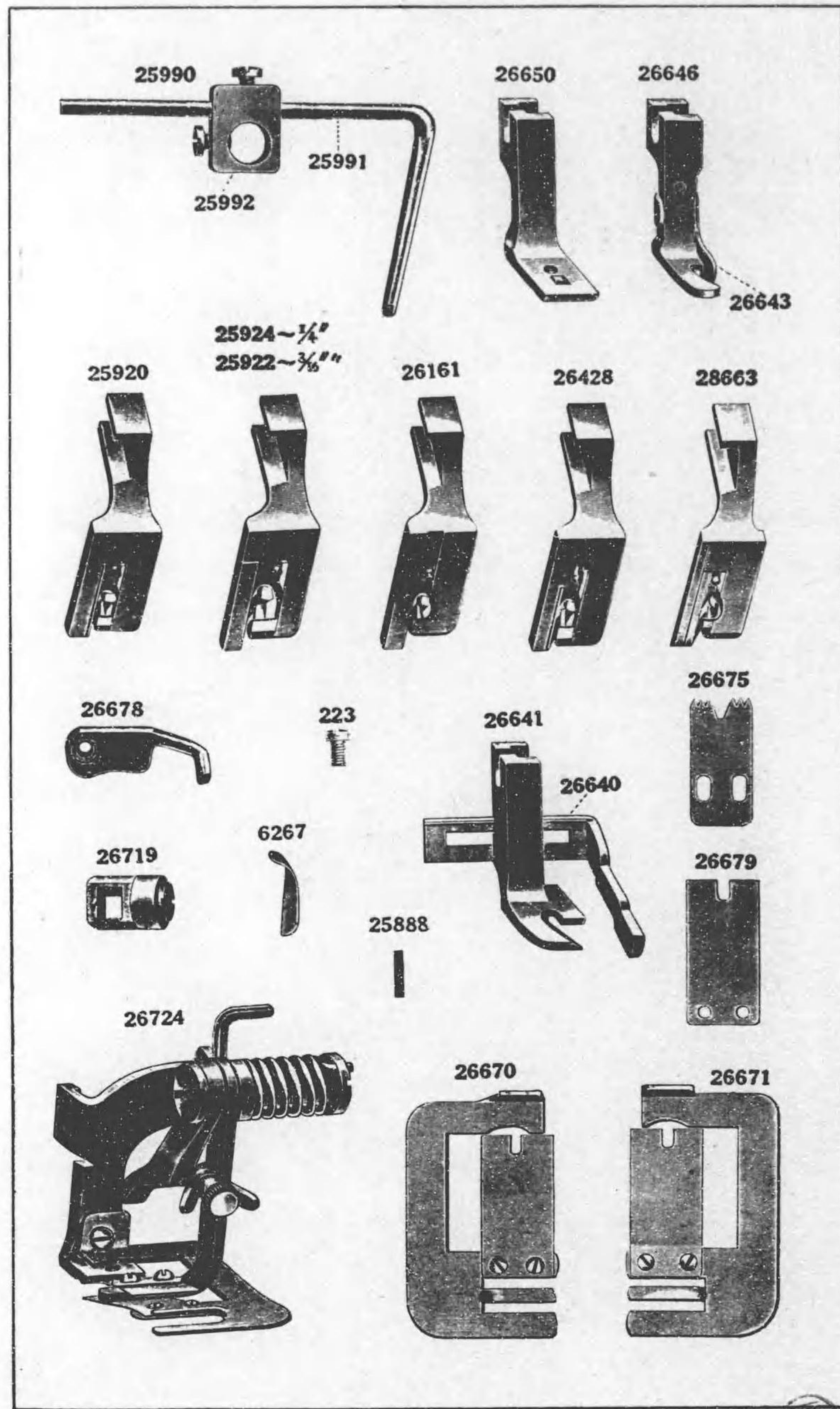
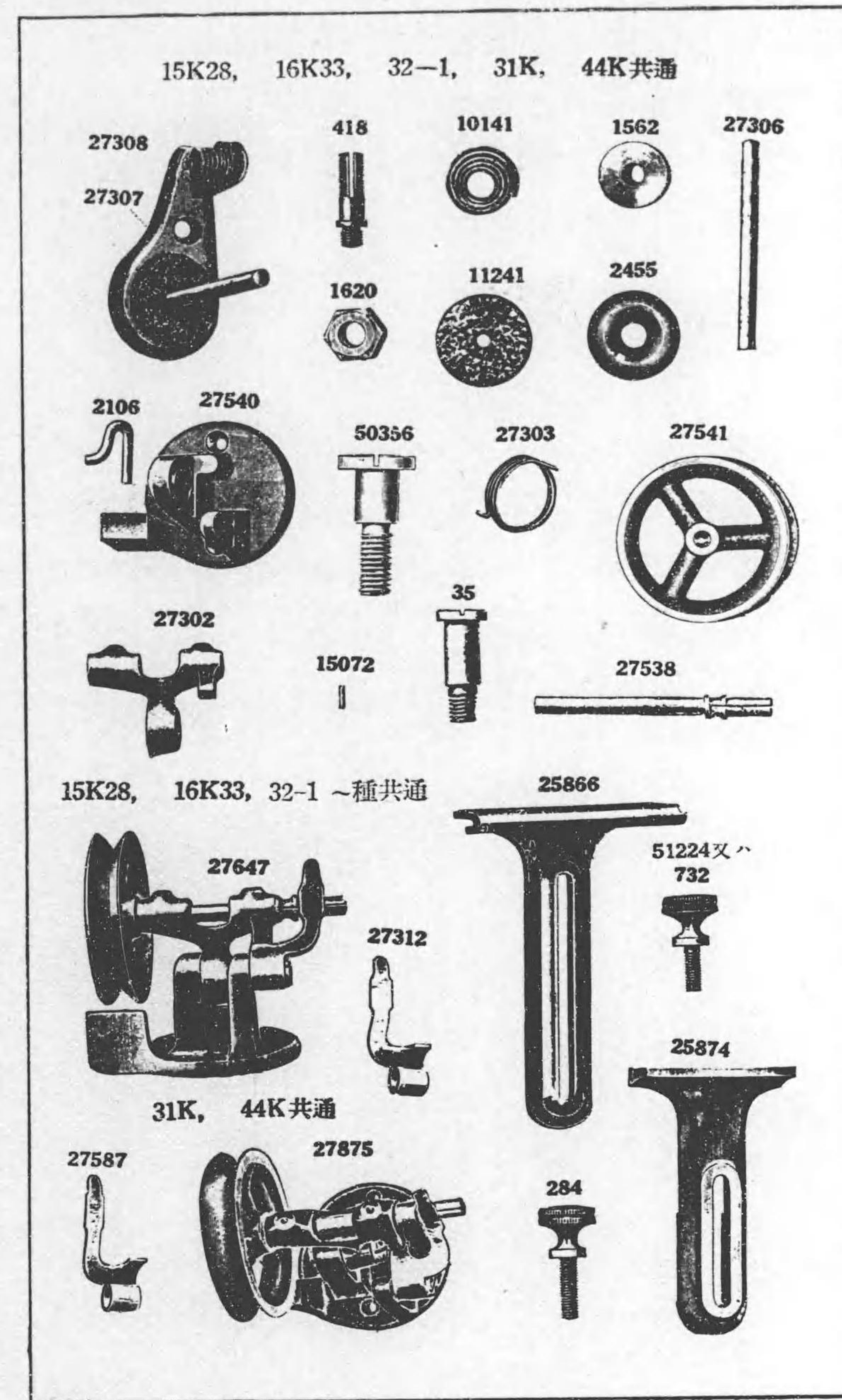

PLATE 76

15K28, 16K33
31K20, 32-1, 44K13

第七十六圖



第七十七圖

31K20, 44K13

PLATE 77

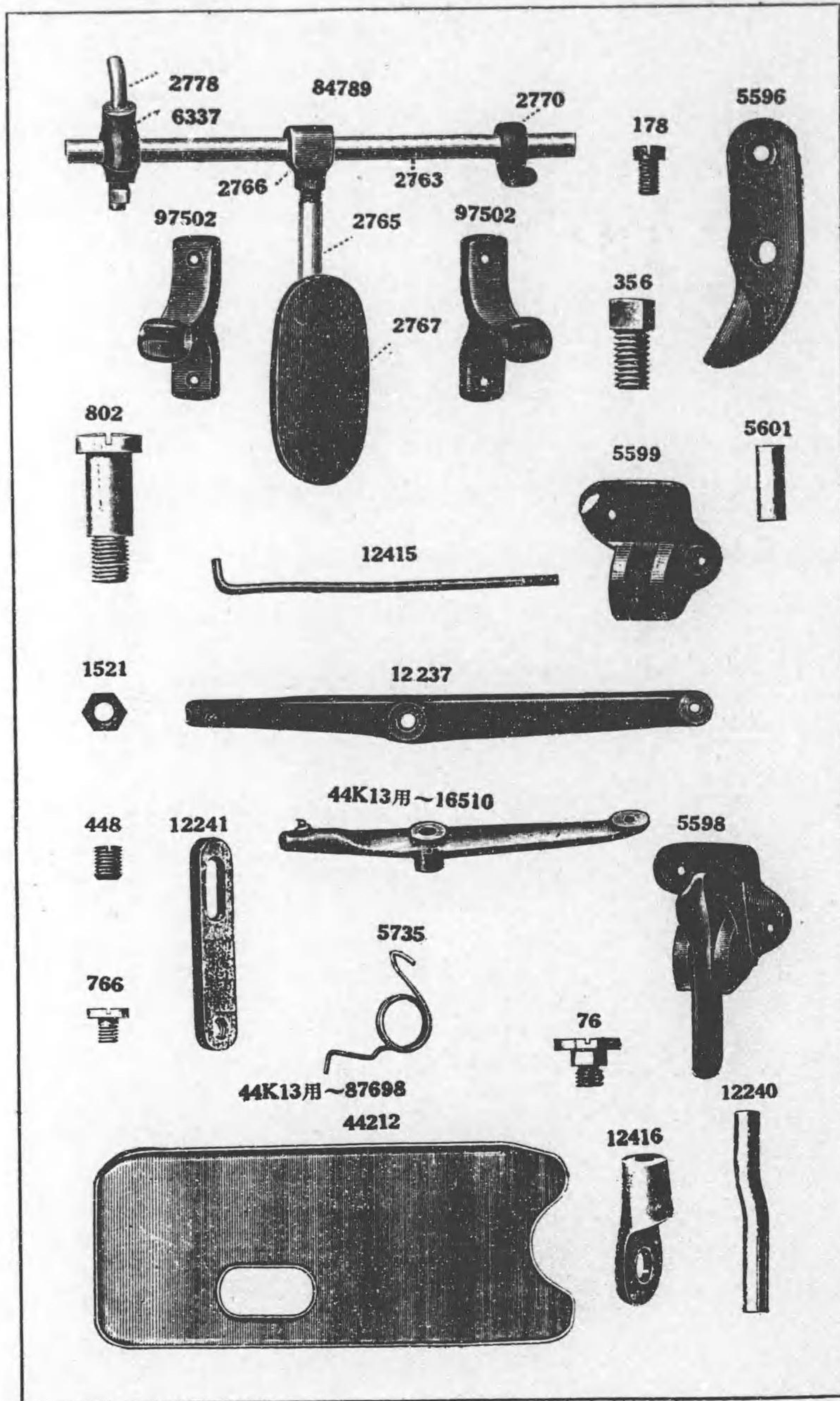

PLATE 78

44K13

第七十八圖

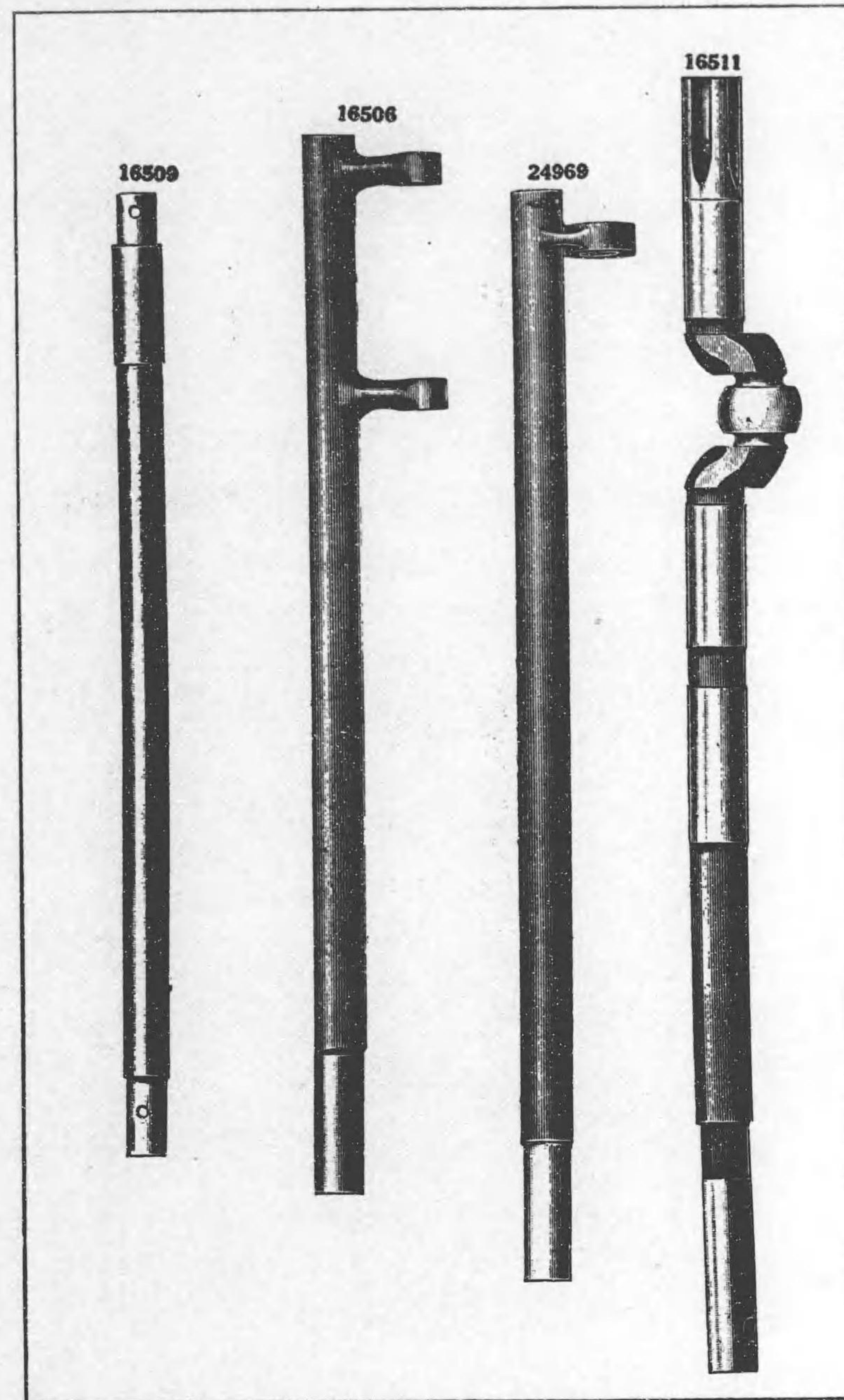

ILLUSTRATION OF PARTS

CLASS

32-1

MACHINE

三十二種一型ミシン部分品圖解

部分品 番 號	圖解番號	部分品 番 號	圖解番號	部分品 番 號	圖解番號	部分品 番 號	圖解番號
Parts No.	Plate No.	Parts No.	Plate No.	Parts No.	Plate No.	Parts No.	Plate No.
15	81	448	84	2049	80	7070	80
35	76	449	79	2049	83	7071	82
36	82	453	81	2062	82	7252	79
79	84	458	79	2070	82	7259	79
106	84	460	80	2102	84	7263	79
122	79	460	84	2103	84	7267	80
123	79	462	79	2106	76	7268	80
135	83	"	83	2111	84	7269	85
144	79	549	80	2112	84	7270	85
145	79	577	81	2113	84	7271	85
"	83	591	83	2114	84	7272	85
159	82	592	83	2115	84	7274	82
161	86	620	81	2117	79	7275	82
176	85	646	81	"	84	7276	82
183	82	648	83	2455	76	7277	82
187	83	662	83	2460	86	7278	82
190	81	665	81	2461	86	7279	80
"	82	673	81	2466	86	7280	82
196	81	735	80	2518	83	7281	82
219	83	740	82	2523	83	7283	81
226	80	740	86	2532	83	7284	81
233	80	743	83	2533	83	7287	81
248	79	777	83	2693	86	7288	81
256	79	802	86	2763	86	7290	81
263	82	1012	81	2765	86	7291	81
271	82	1513	80	2766	86	7292	81
283	79	1517	81	2767	86	7293	81
286	84	1519	80	2770	86	7294	81
286	86	1519	83	2778	86	7295	80
307	80	1520	81	2809	79	7298	80
313	80	1560	84	2862	79	7299	82
356	86	1562	76	2973	83	7300	82
380	81	1589	80	2974	83	7301	85
391	83	1620	76	2975	83	7302	85
413	84	1813	80	2996	83	7303	85
418	76	1820	80	4784	80	7317	80
435	82	1822	84	4933	79	7318	80
"	83	2002	79	6055	79	7319	83
446	84	2020	79	6337	86	7326	83
448	79	2022	79	6533	80	7332	84

部分品 番 號	圖解番號	部分品 番 號	圖解番號	部分品 番 號	圖解番號	部分品 番 號	圖解番號
Parts No.	Plate No.	Parts No.	Plate No.	Parts No.	Plate No.	Parts No.	Plate No.
7334	84	15072	76	51224	84		
7335	84	15140	83	"	86		
7336	84	15141	83	51581	79		
7337	85	15278	83				
7338	85	15517	79				
7339	85	15537	81				
7340	85	15588	81				
7341	85	15728	83				
7342	85	15731	83				
7343	85	15773	86				
7344	85	15783	79				
7474	82	15972	81				
7531	86	15990	80				
7532	86	15991	80				
7535	86	15992	82				
7538	86	25866	84				
7539	86	27302	76				
7545	86	27303	76				
7553	83	27306	76				
7562	84	27307	76				
7577	80	27308	76				
7593	83	27312	76				
7595	83	27538	76				
7599	79	27540	76				
7652	81	27541	76				
8238	84	27647	76				
8399	82	33875	79				
8879	79	33876	79				
10135	84	33887	79				
10136	84	33930	82				
10141	76	33932	84				
11241	76	33942	83				
12250	86	33947	83				
12403	79	33948	80				
14031	80	33949	81				
14049	83	33970	81				
14051	83	33993	83				
14098	79	50231	85				
14105	83	50356	76				
14856	80	51075	79				

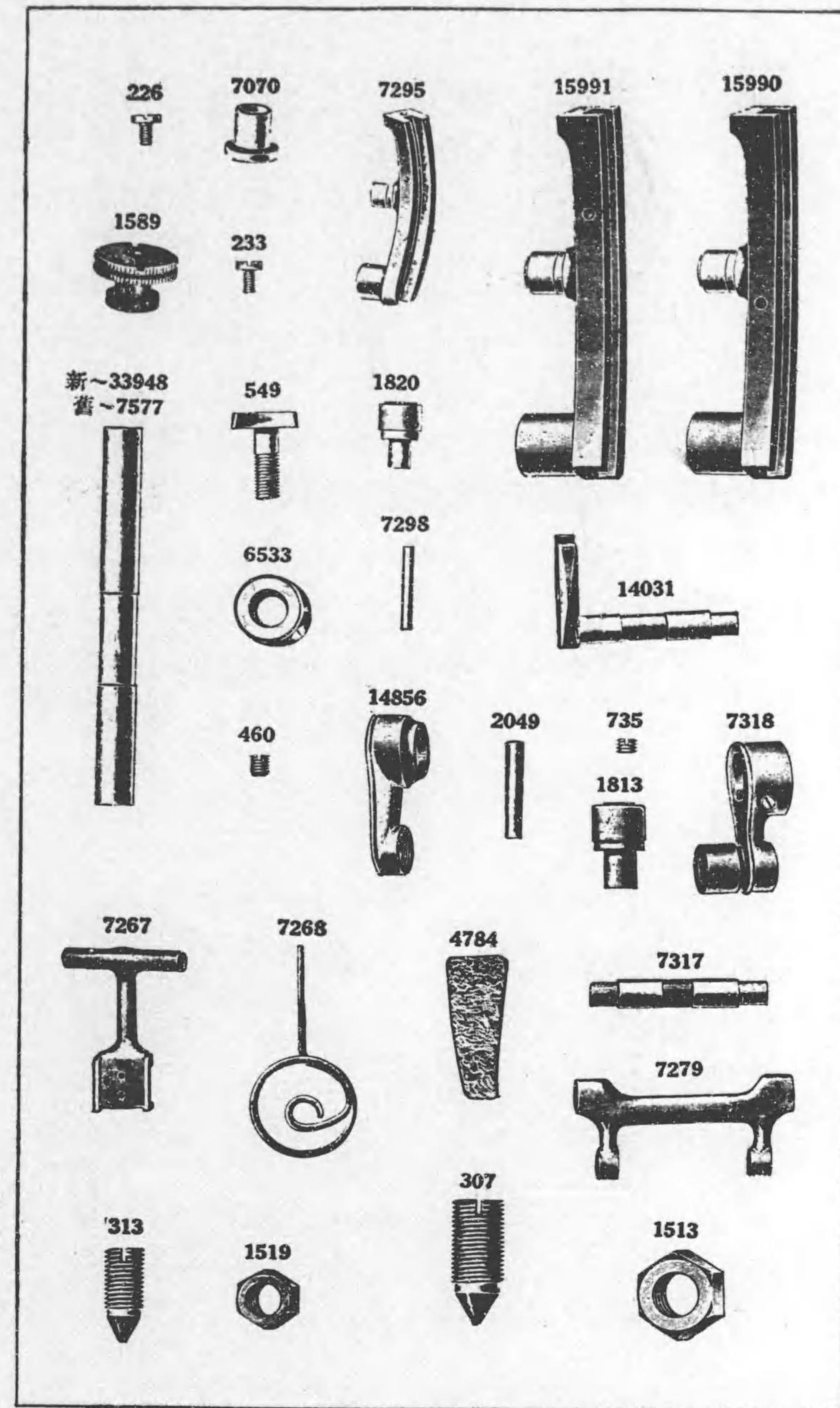
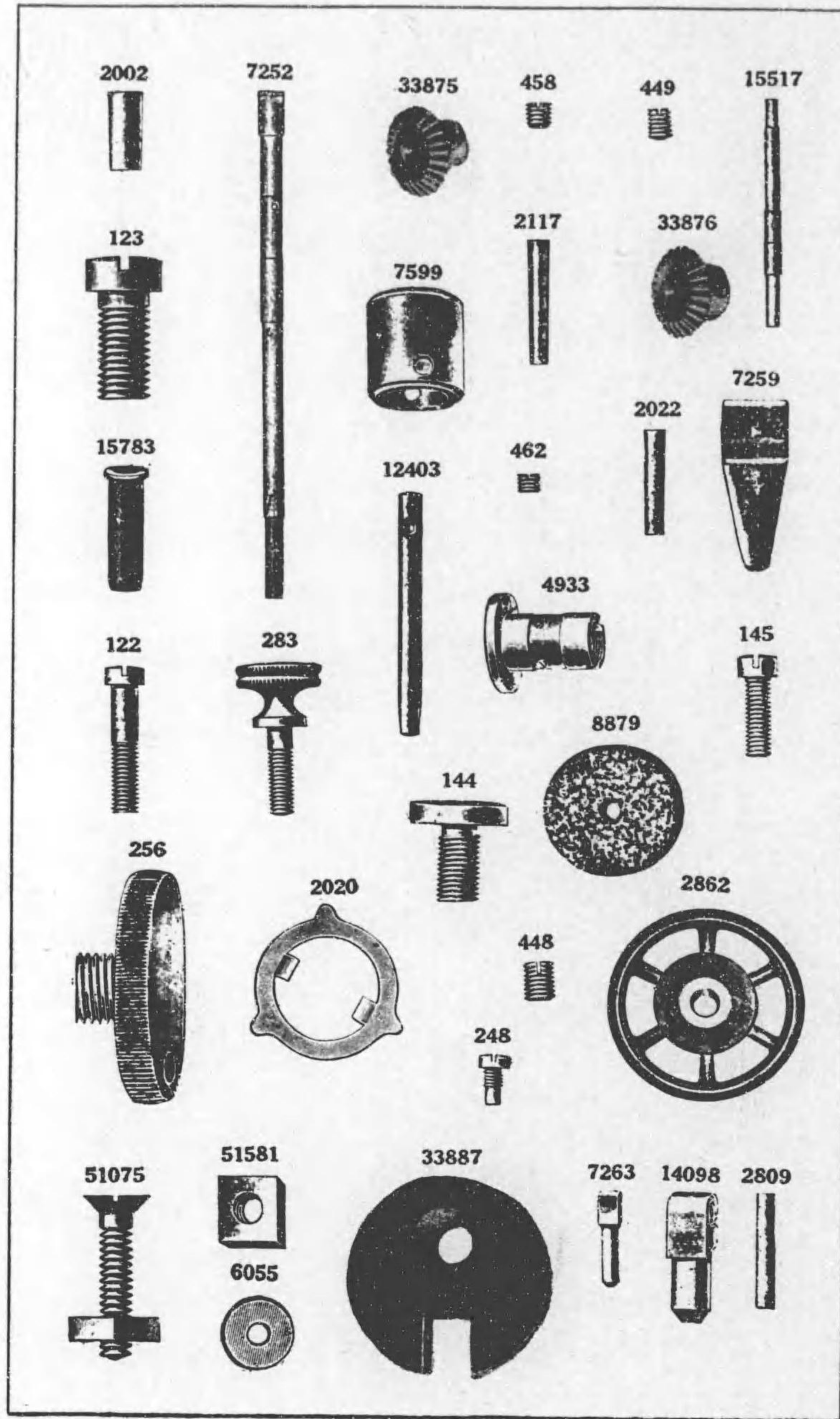

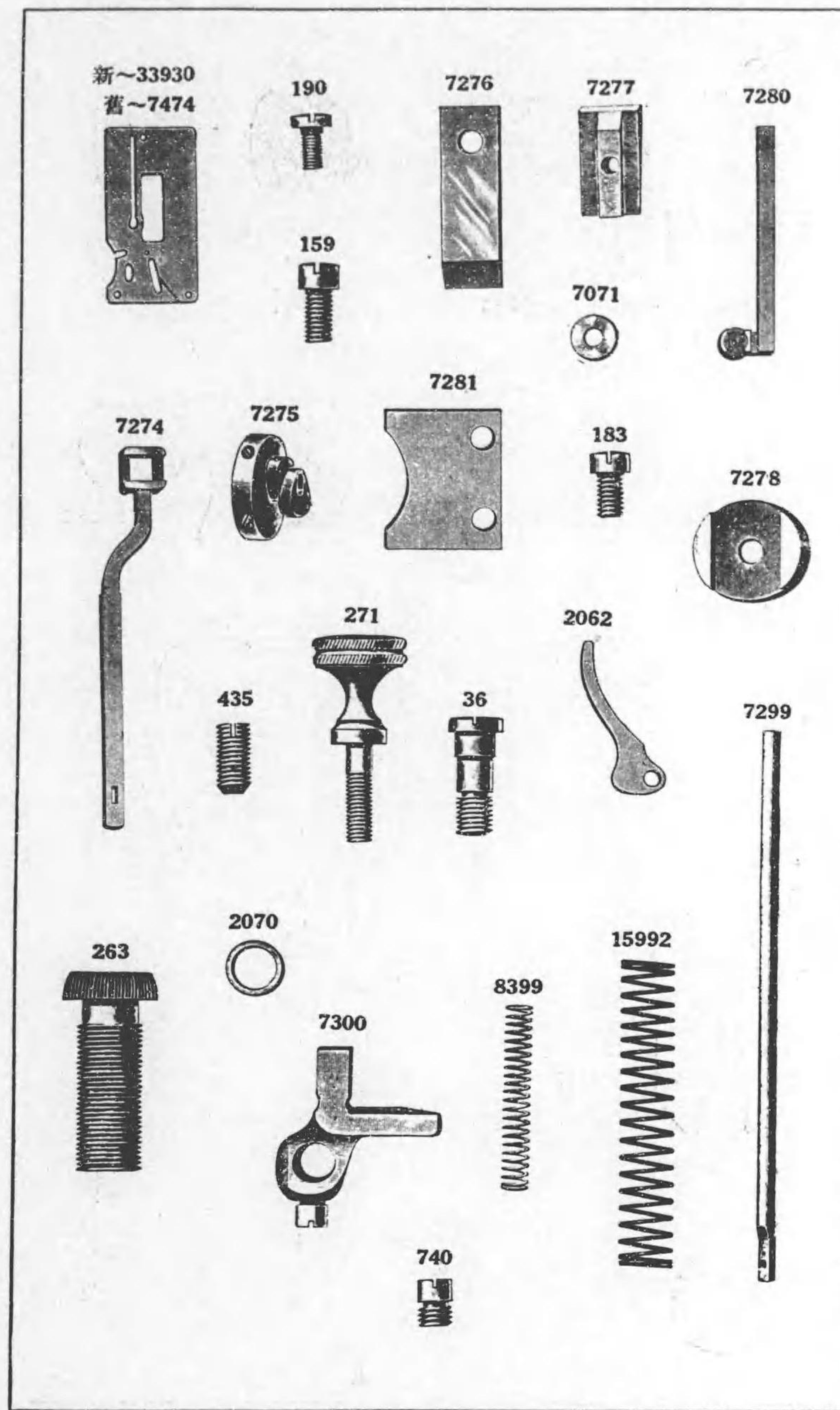
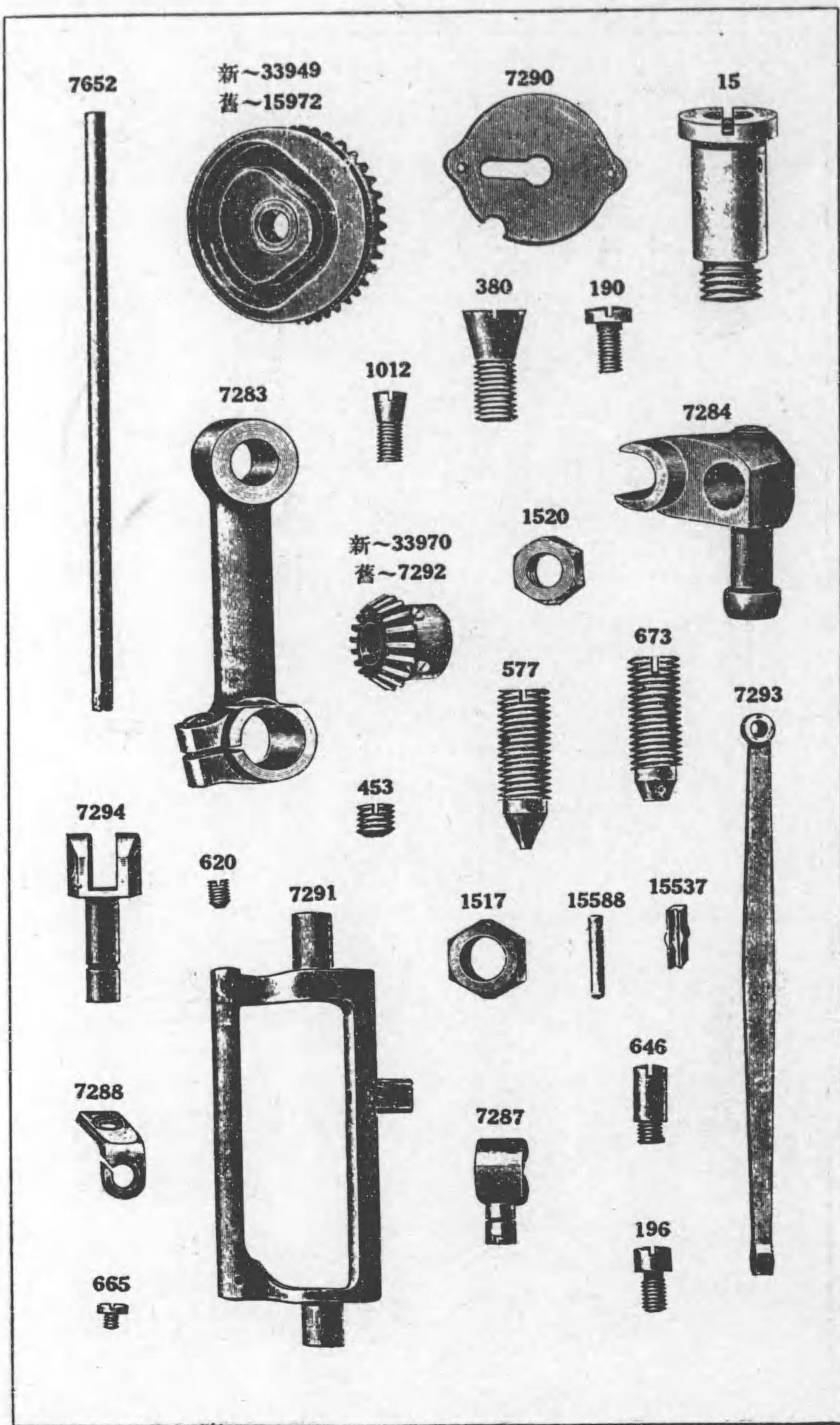

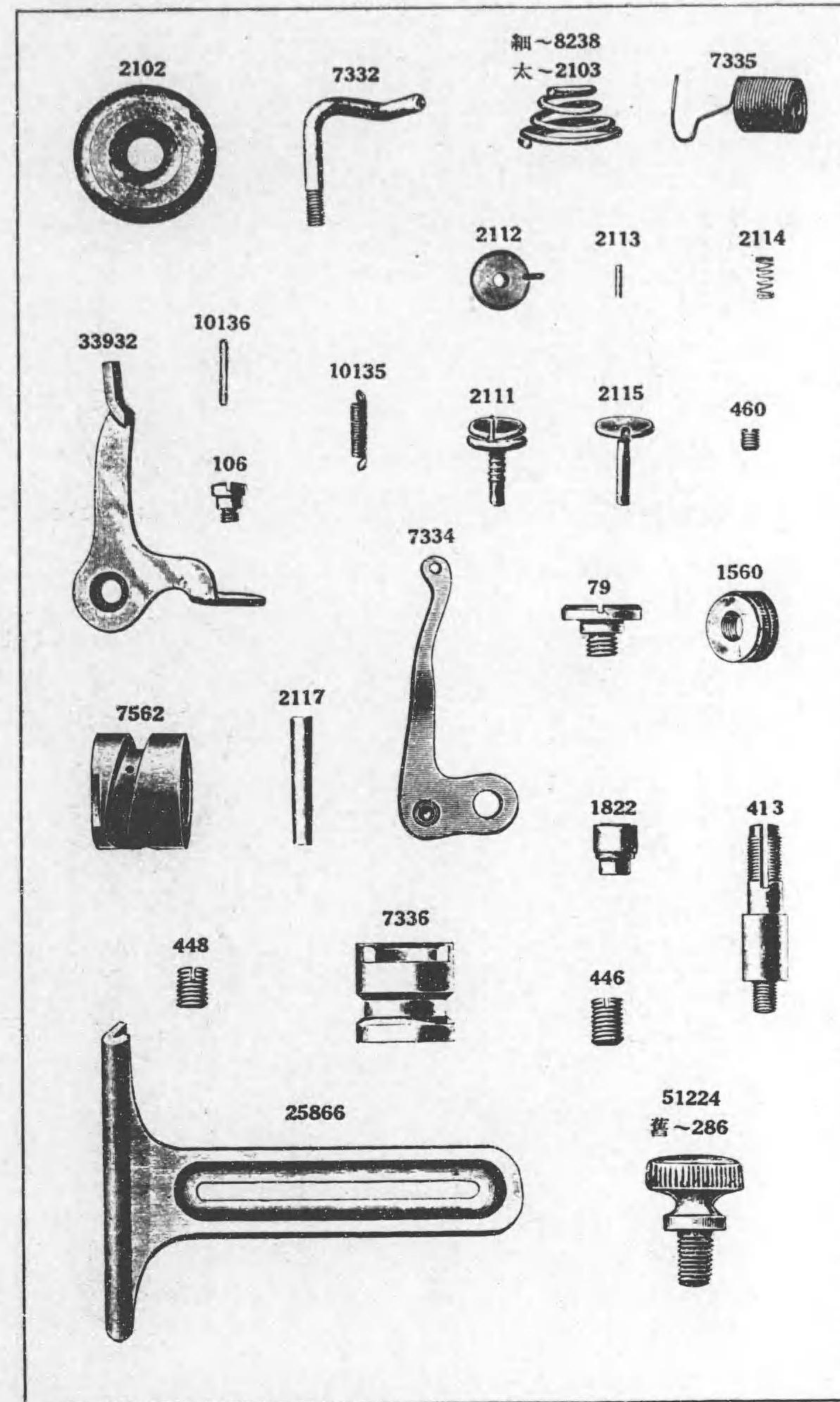
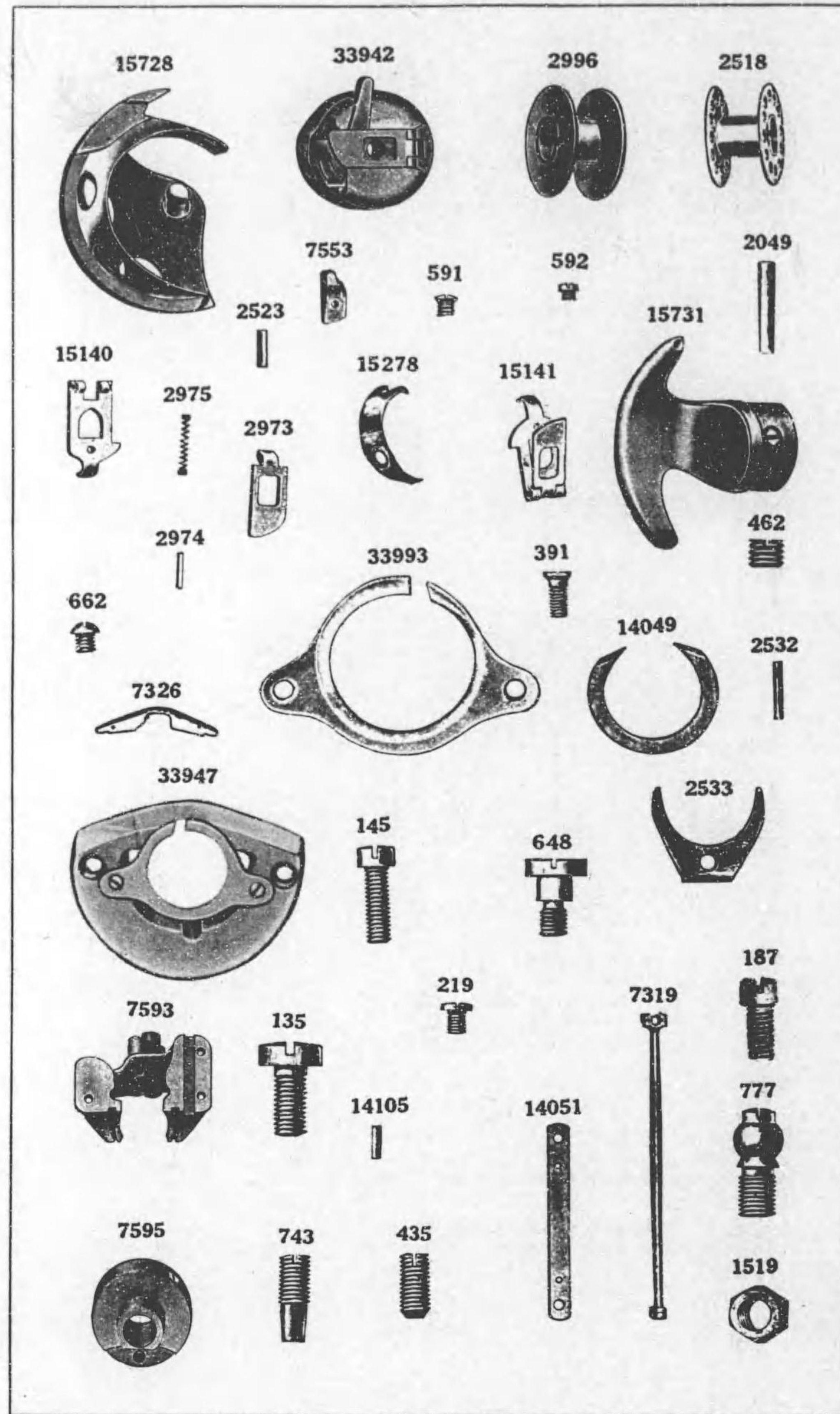

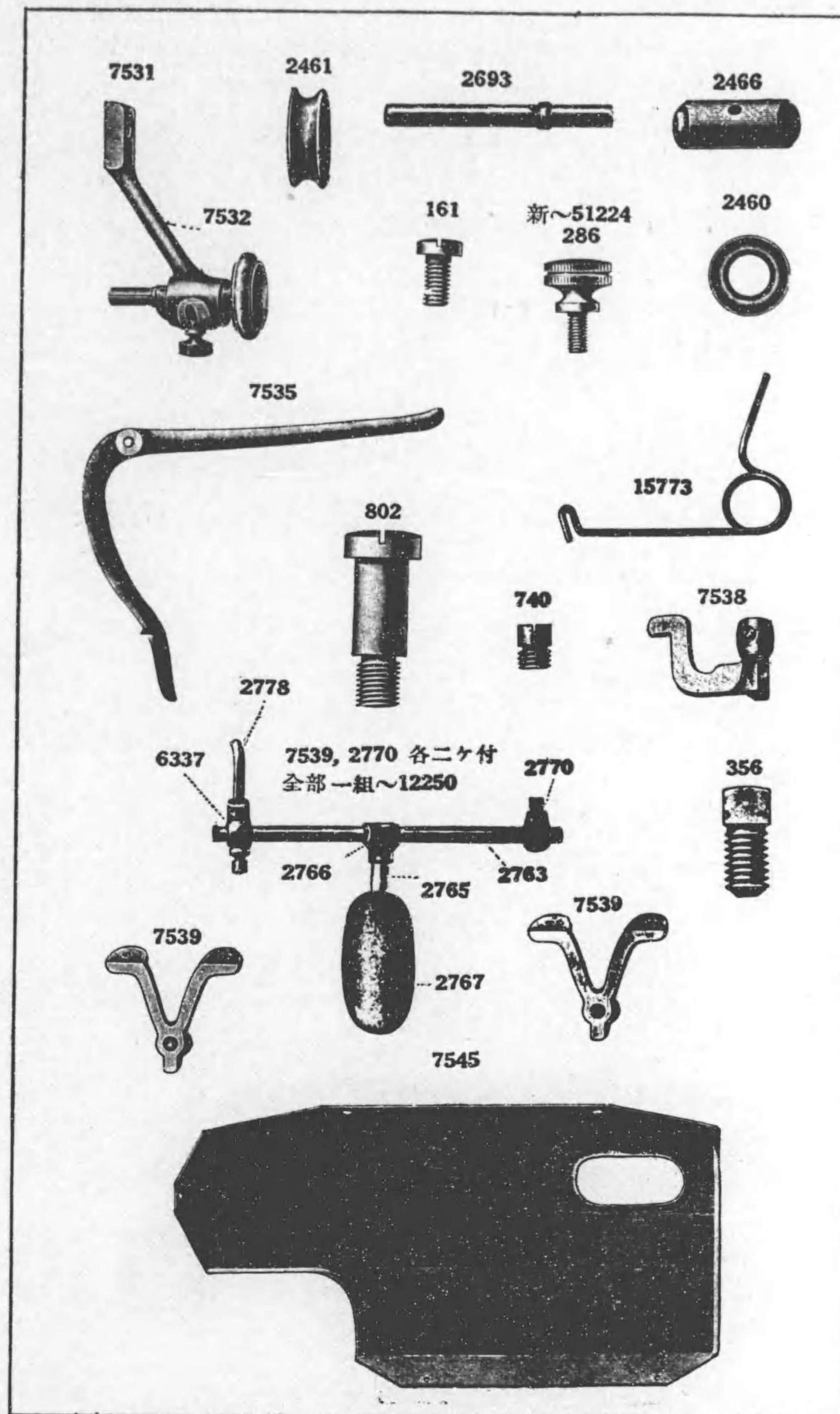
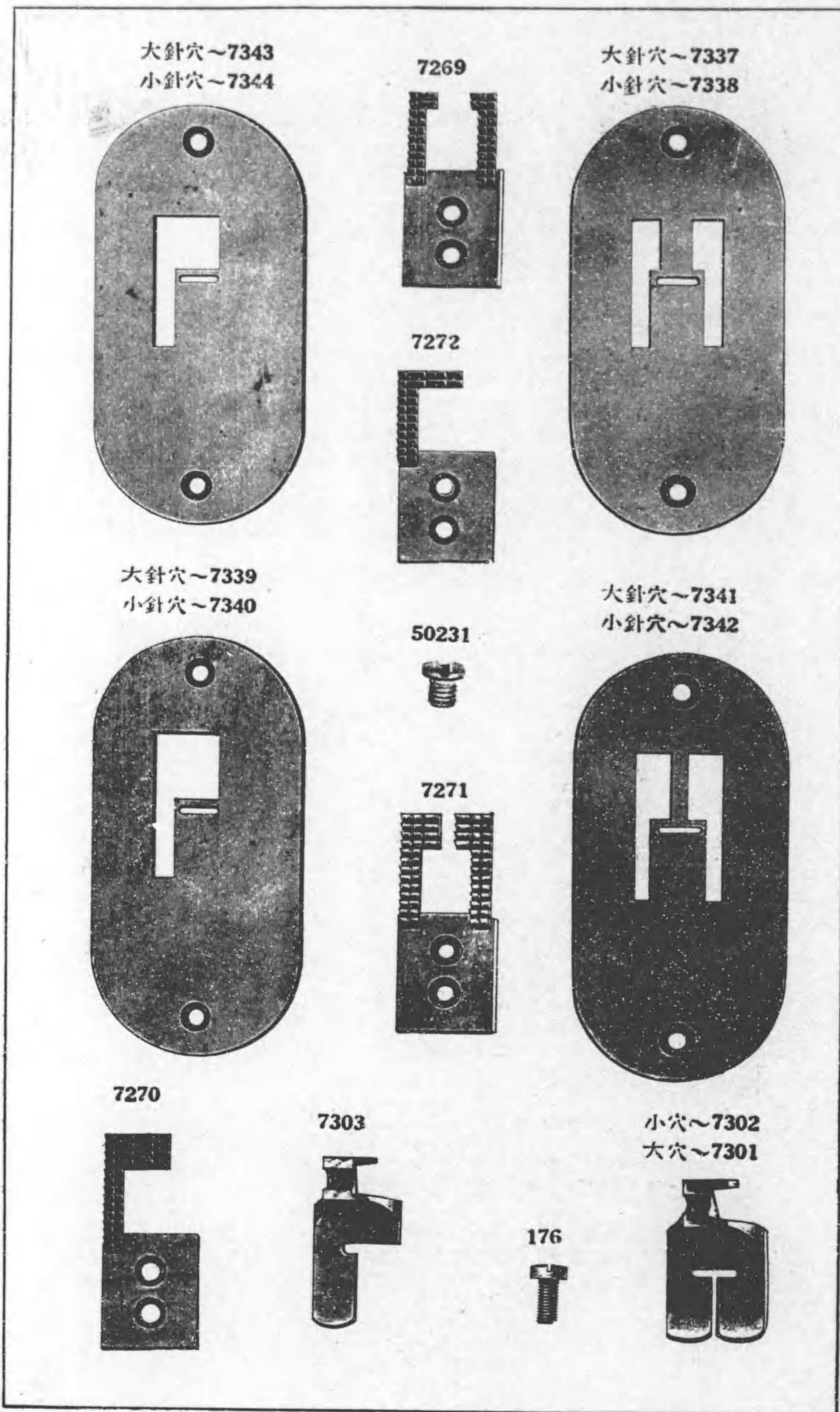

ILLUSTRATION OF PARTS

CLASS

103D10

MACHINE

百三種D十型ミシン部分品圖解

103D10

部分品 番 號	圖解番號	部分品 番 號	圖解番號	部分品 番 號	圖解番號	部分品 番 號	圖解番號
Parts No.	Plate No.	Parts No.	Plate No.	Parts No.	Plate No.	Parts No.	Plate No.
50	97	775	91	5596	98	36551	94
76	98	794	91	5601	98	36554	94
118	87	802	98	8422	96	36555	93
121	92	808	93	8879	88	36559	95
135	96	858	91	10106	96	36560	95
145	89	964	90	10107	96	36561	95
157	89	1036	87	11170	91	36613	95
171	96	1036	93	12329	93	36633	95
176	90	1053	92	12391	91	36634	95
178	98	1058	91	12398	93	36635	95
207	91	1082	91	12403	88	36639	95
219	96	1120	90	12416	98	36640	95
225	90	1133	87	12474	94	36641	95
226	90	1133	91	15072	96	36642	95
229	91	1253	88	15072	97	36644	95
248	88	1253	92	15282	88	36837	94
256	88	1259	93	15286	97	36838	94
313	90	1367	92	15287	97	36839	94
356	98	1380	92	15288	97	36840	94
375	89	1454	90	15291	97	40274	92
389	90	1513	89	15366	97	40392	92
440	93	1518	89	15376	97	40393	92
443	87	1519	90	15413	97	40394	92
448	88	1520	91	15416	97	41698	96
448	93	1521	98	20059	91	41699	96
453	91	1528	97	20437	96	41700	96
457	96	1560	93	24040	91	41707	96
S.S. 539	96	1813	89	24041	91	41708	96
S.S. 551	89	2020	88	24131	87	41709	96
S.S. 552	89	2102	93	25878	95	41728	96
571	97	2103	93	26092	95	41729	96
591	92	2269	96	26770	95	41730	96
592	92	2749	97	27795	90	41731	96
624	93	2763	98	29532	91	41815	96
647	87	2765	98	29633	89	41816	96
662	95	2767	98	32572	93	50053	88
691	94	2824	88	32628	97	50058	97
704	89	2974	92	34105	96	50059	97
725	88	2975	92	36549	95	50061	97
732	95	4389	87	36550	95	50117	94

103D10

部分品 番 號	圖解番號	部分品 番 號	圖解番號	部分品 番 號	圖解番號	部分品 番 號	圖解番號
Parts No.	Plate No.	Parts No.	Plate No.	Parts No.	Plate No.	Parts No.	Plate No.
50189	88	56029	89	56089	94		
50189	92	56032	90	56091	94		
50190	90	56033	90	56092	94		
50190	94	56034	90	56099	88		
50191	89	56035	90	56100	88		
50192	90	56036	90	56104	89		
50193	90	56037	90	56106	92		
50194	90	56038	90	56107	92		
50195	91	56039	89	56125	90		
50196	93	56042	91	56127	94		
50203	91	56044	91	56154	87		
50230	97	56045	91	56155	88		
50236	95	56046	91	56156	88		
52016	91	56053	90	56157	92		
52018	89	56054	90	56158	92		
52022	93	56055	90	56159	87		
52023	93	56056	93	56160	92		
52024	93	56057	93	99601	94		
52025	93	56059	93	99602	94		
52027	93	56060	93	99603	94		
52028	98	56062	93	99604	91		
52045	87	56063	93	99607	96		
52089	92	56064	93	99608	97		
52090	92	56065	94	99609	96		
52121	92	56066	94	99610	97		
52149	87	56070	87	99615	89		
52170	90	56071	98	99616	89		
52306	91	56072	98	99619	94		
52454	93	56073	98	99621	87		
52472	92	56074	98	99622	91		
52473	92	56075	98	99623	87		
55623	92	56076	98	99624	90		
56005	87	56077	98	99625	91		
56007	87	56078	98	99626	93		
56015	88	56079	98	99627	87		
56016	88	56080	98	125320	92		
56019	88	56081	98	127100	92		
56020	88	56083	94	200079	90		
56024	89	56084	93	204296	90		
56027	89	56087	96				

第八十七圖

103D10

PLATE 87

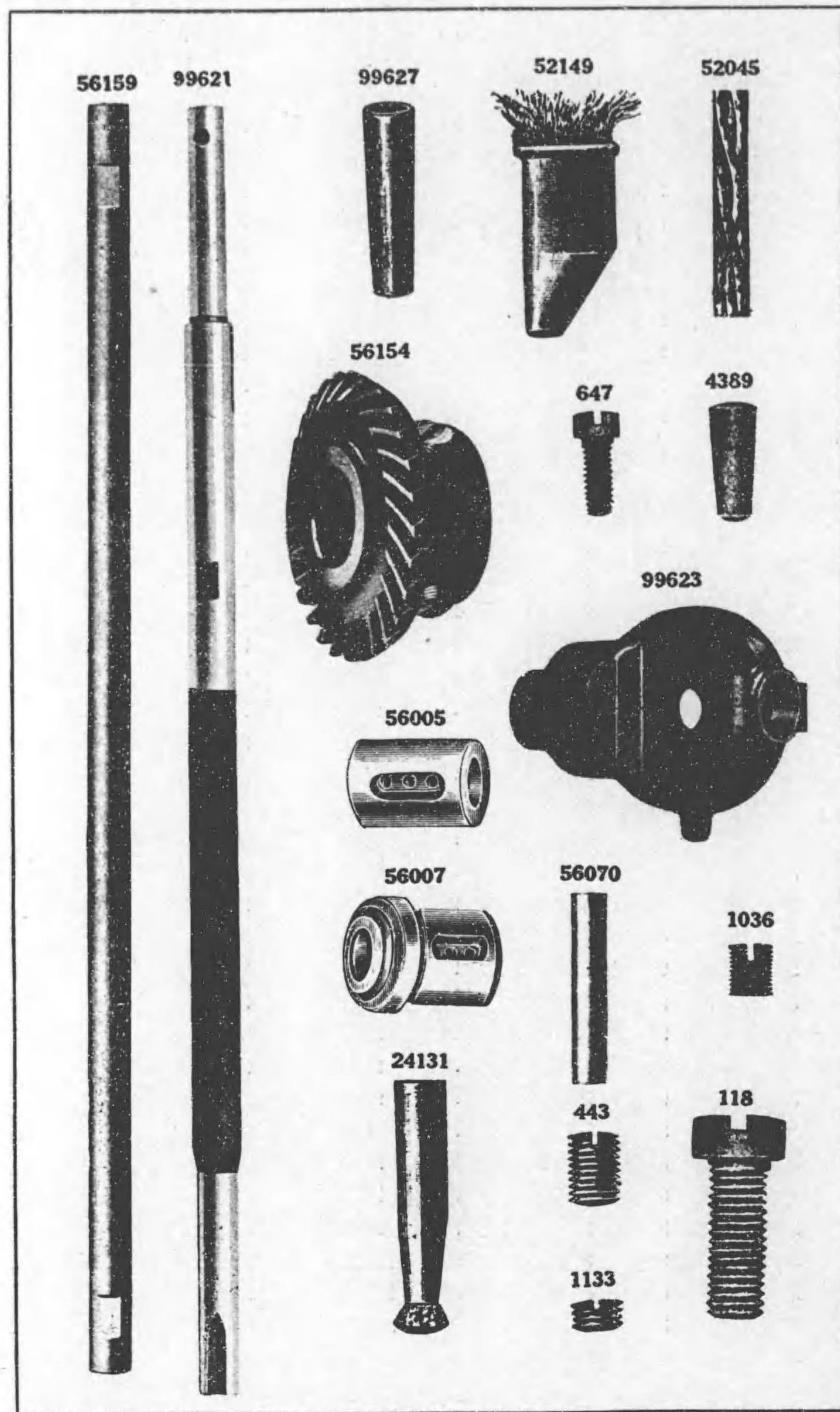
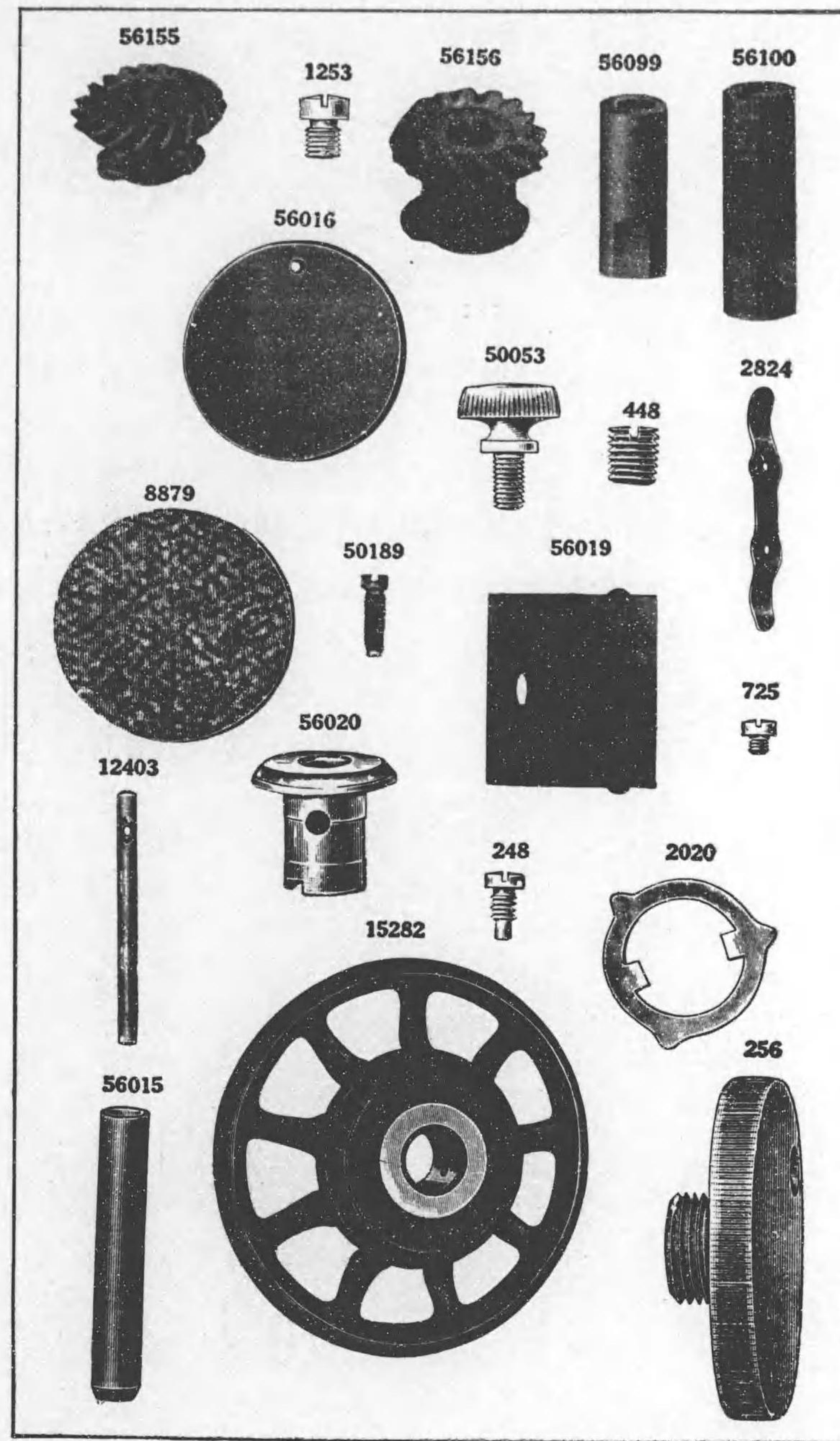
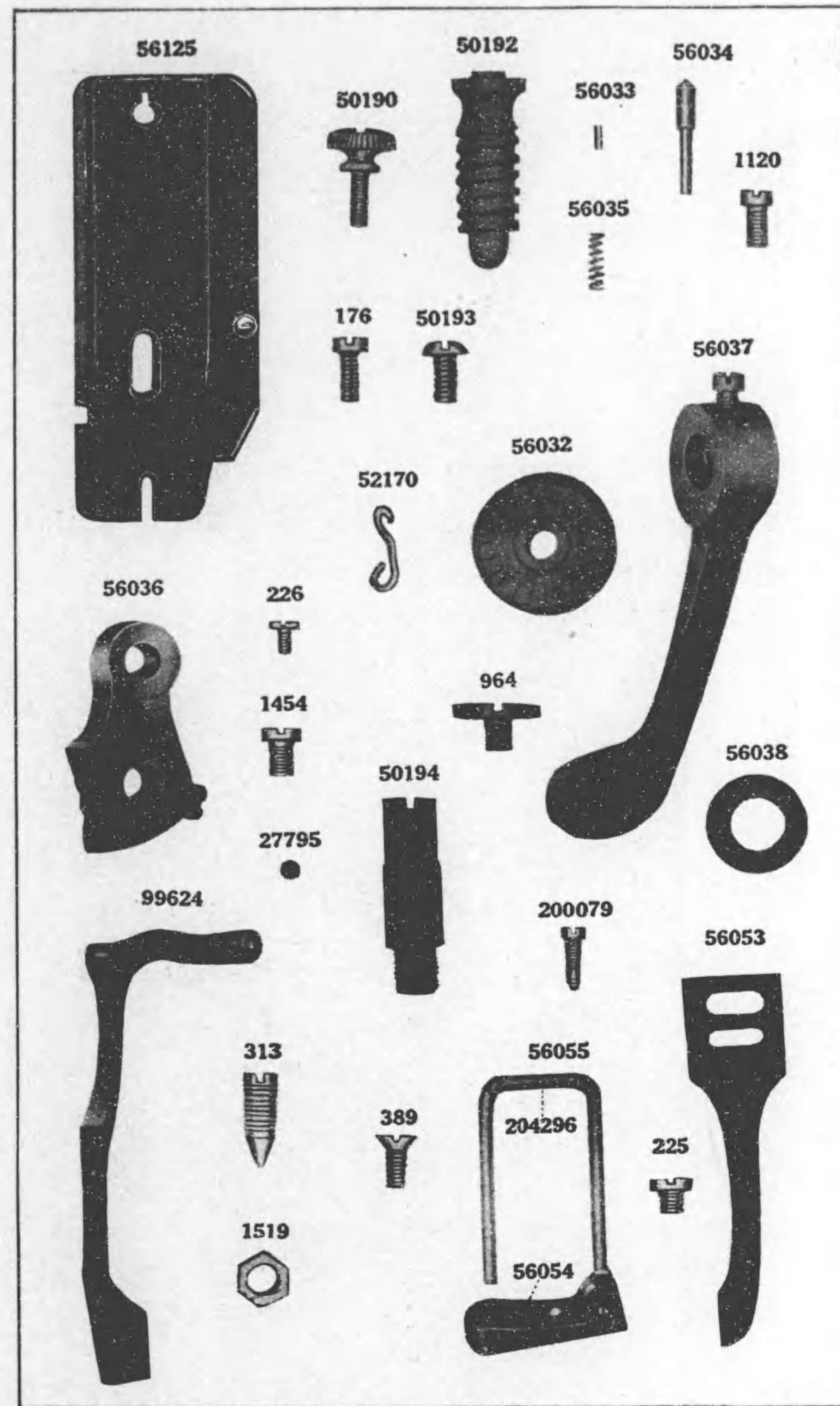
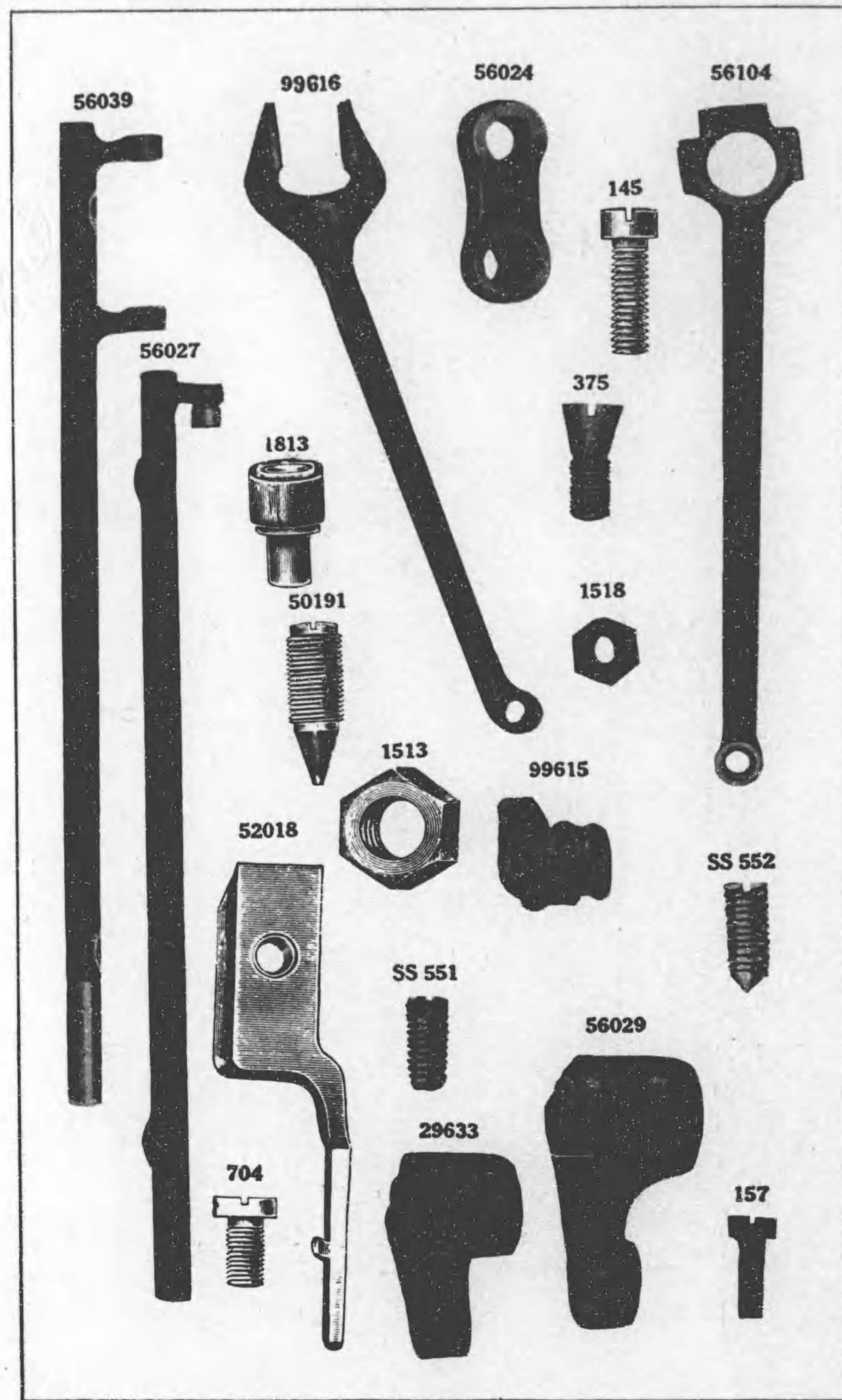

PLATE 88

103D10

第八十八圖





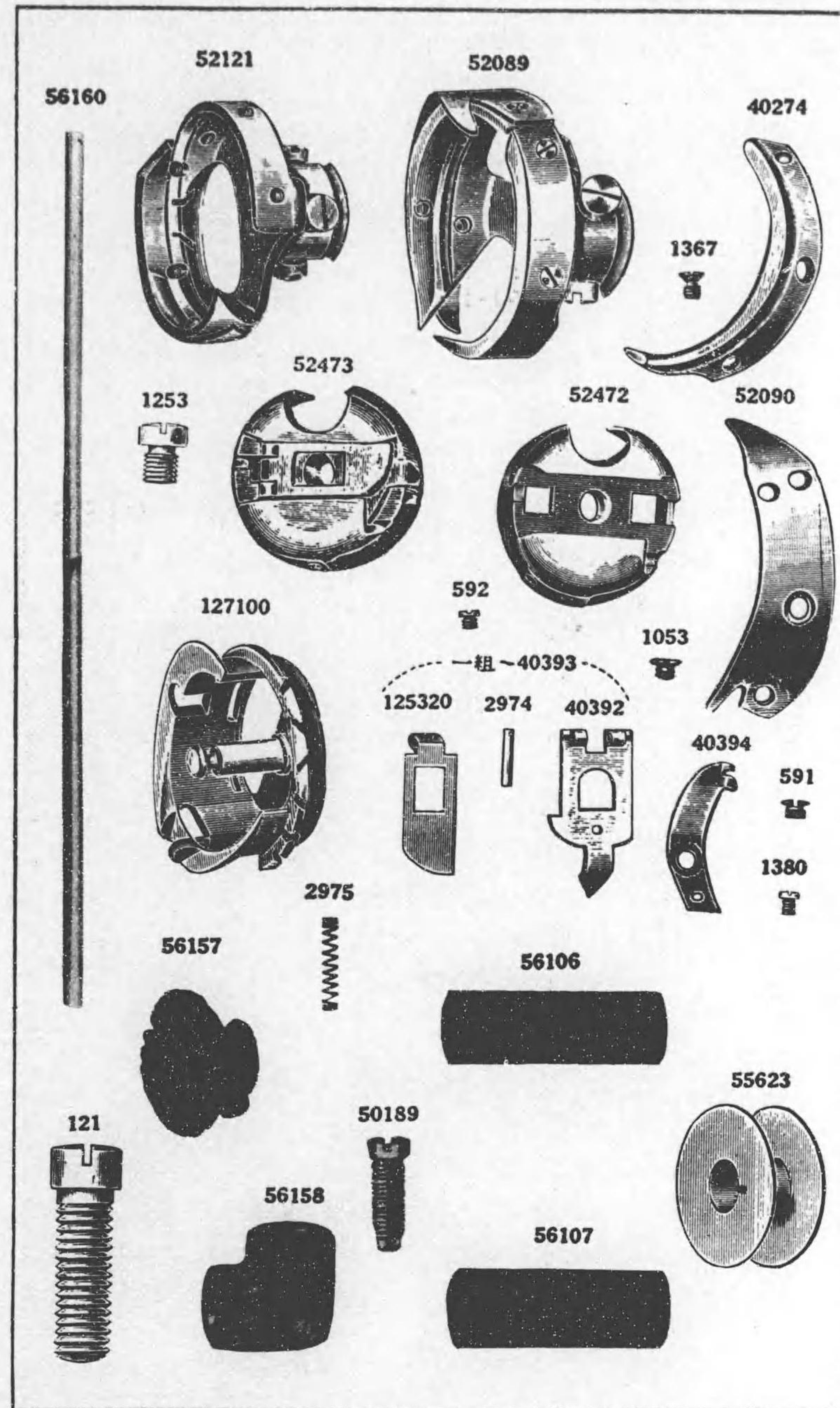
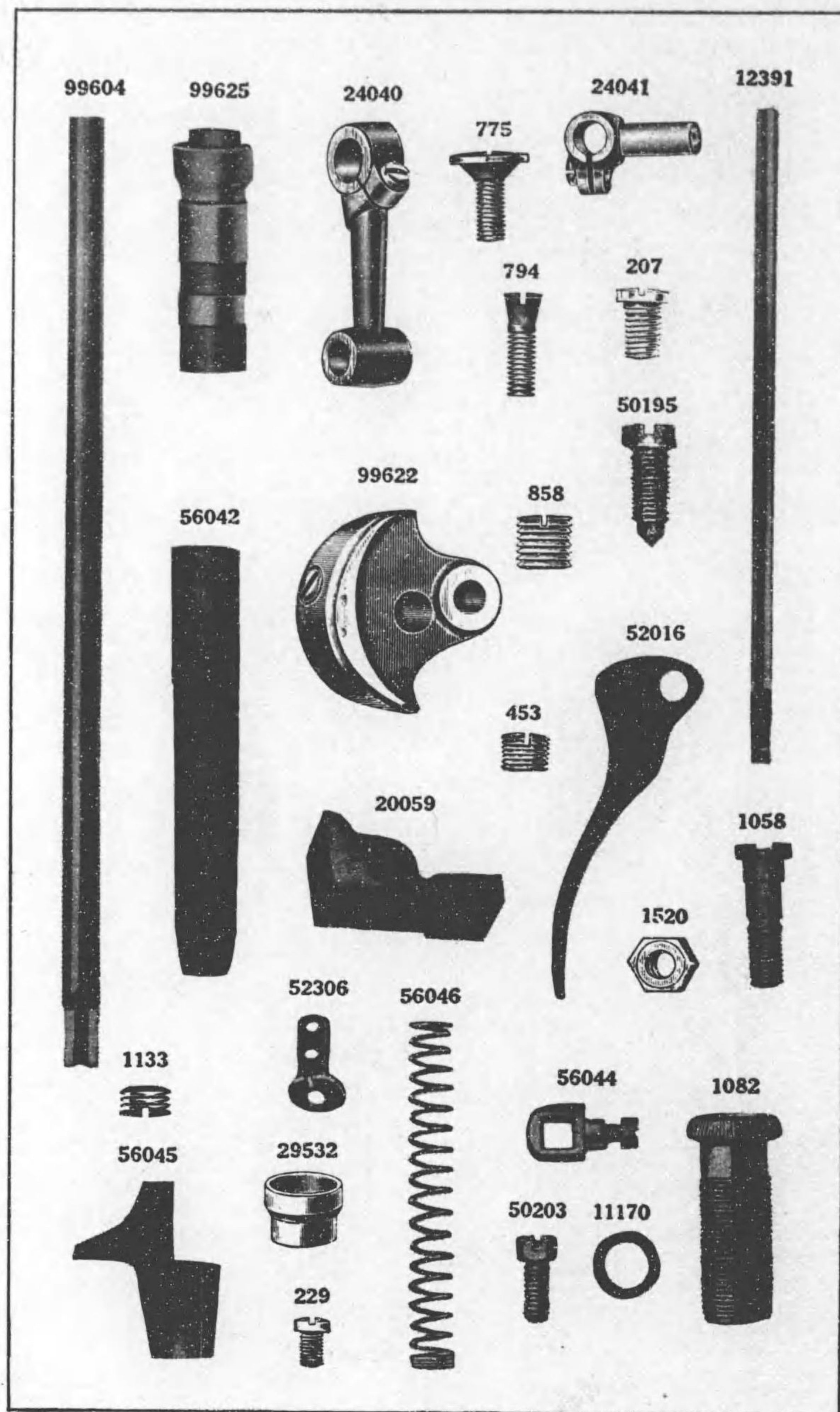

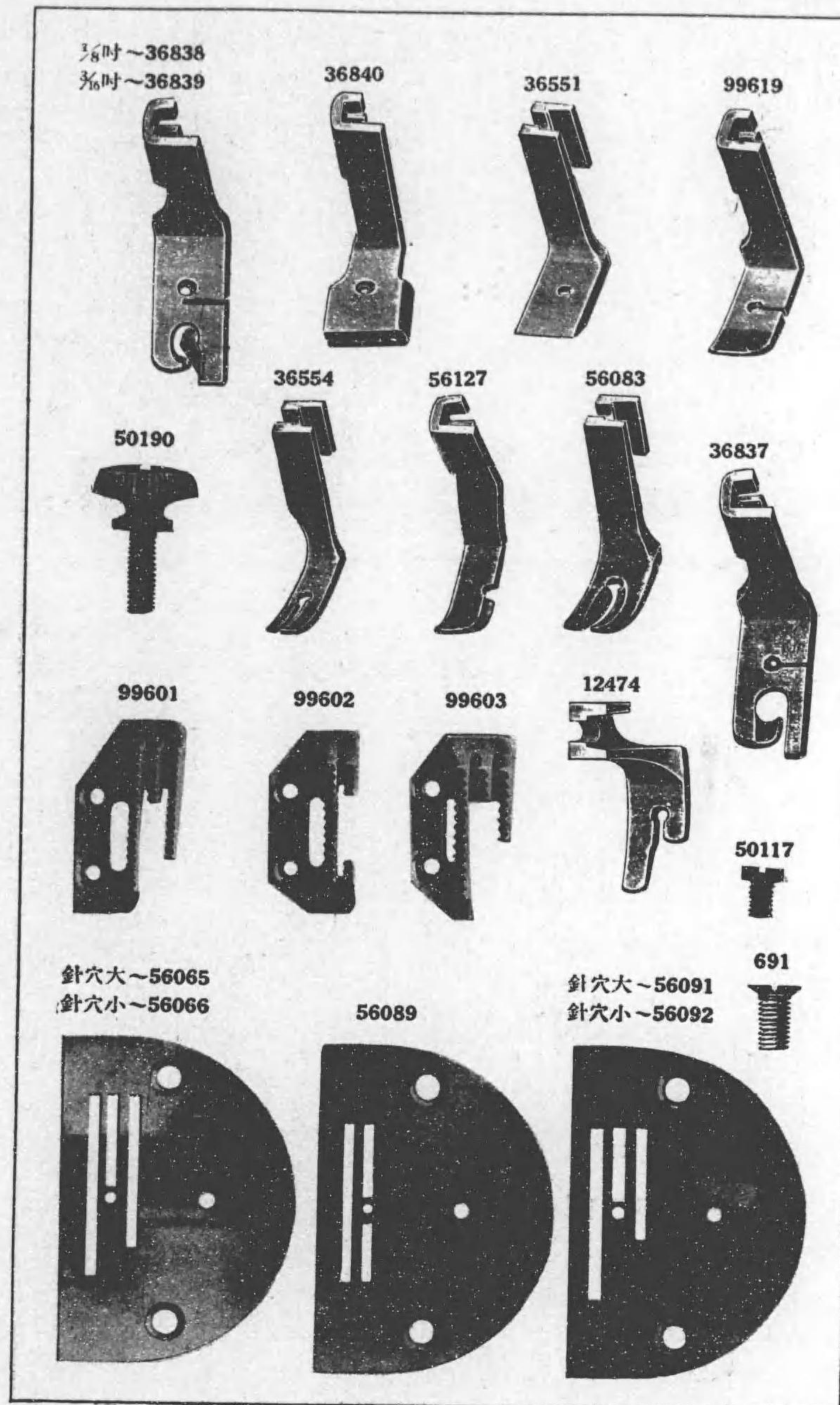
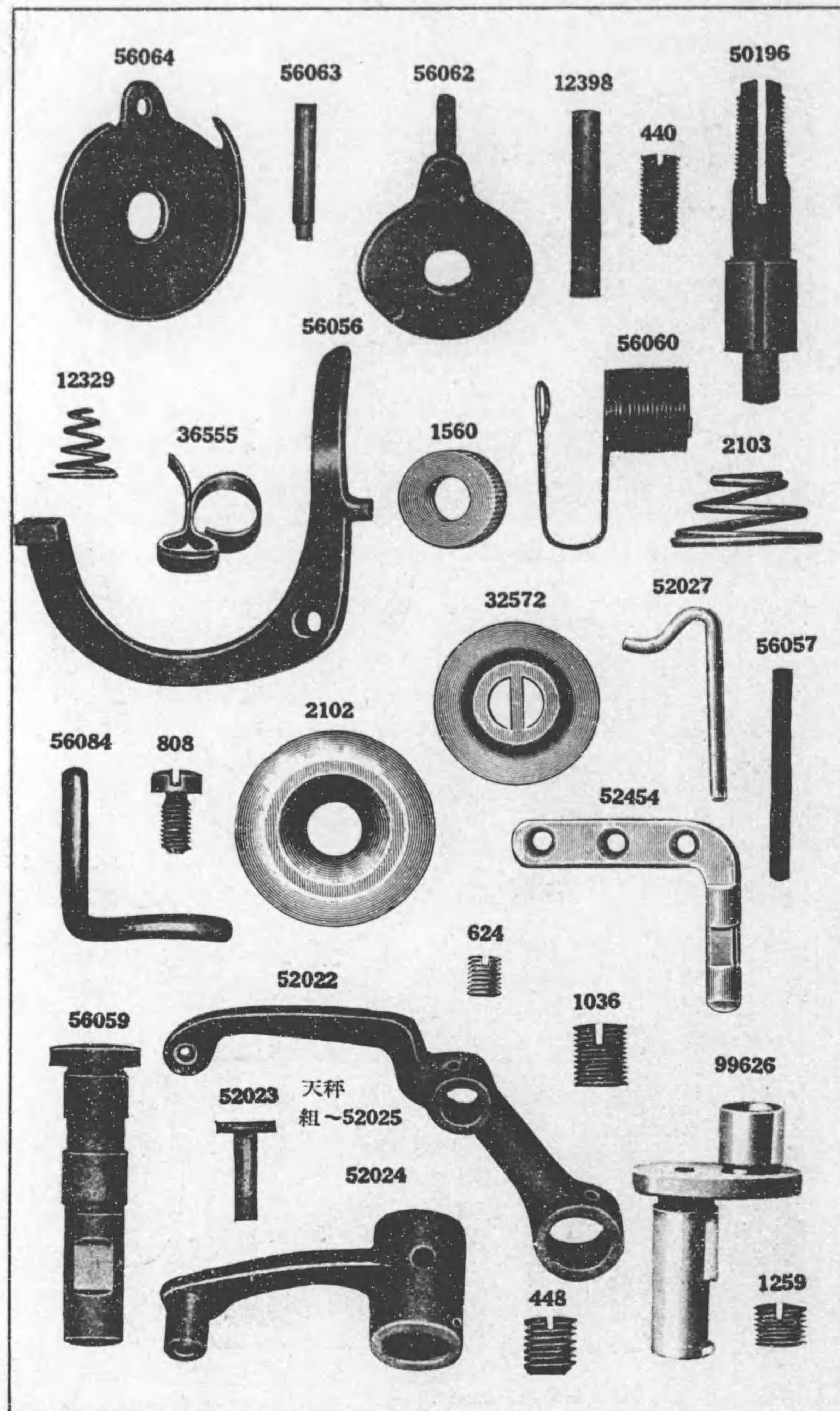

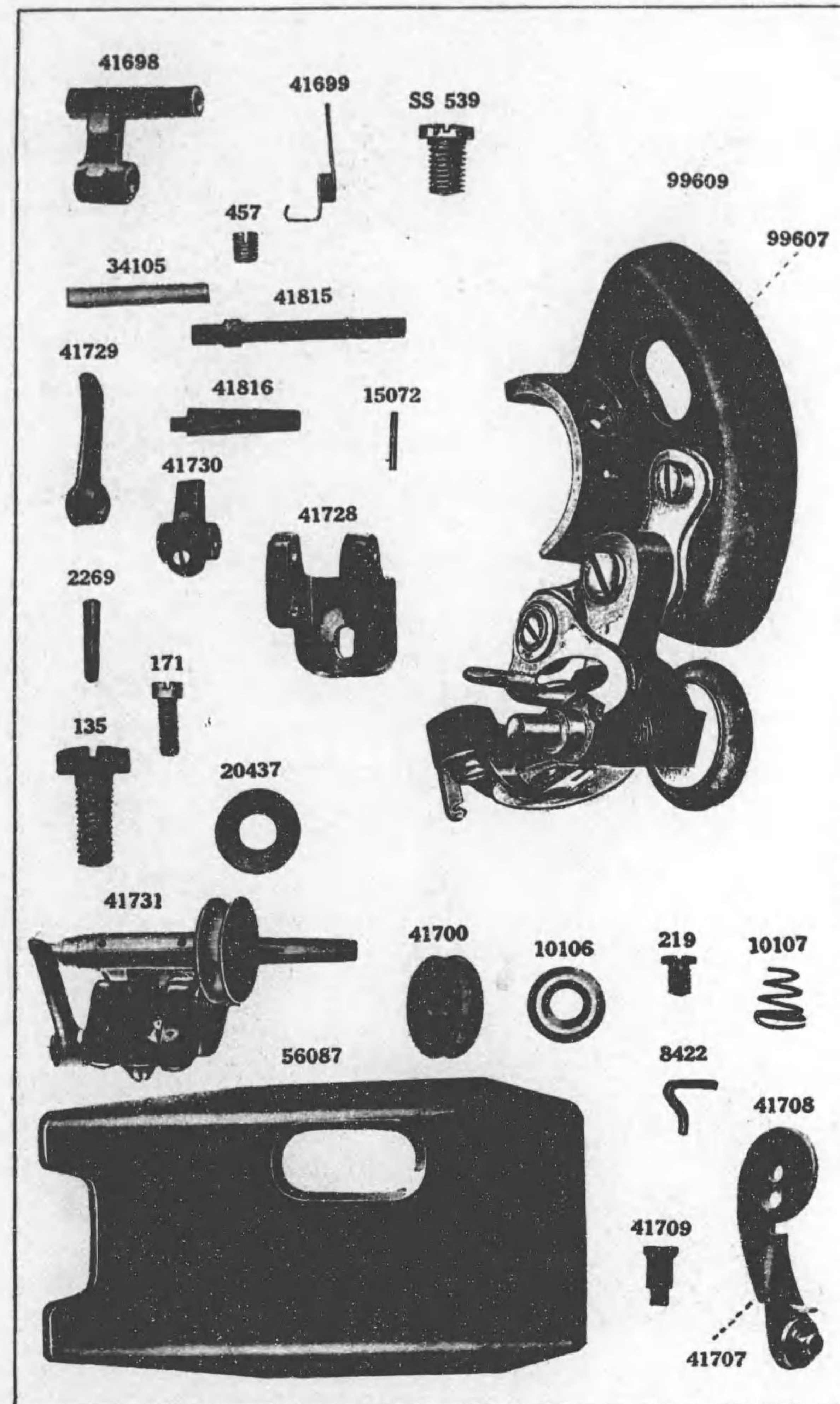
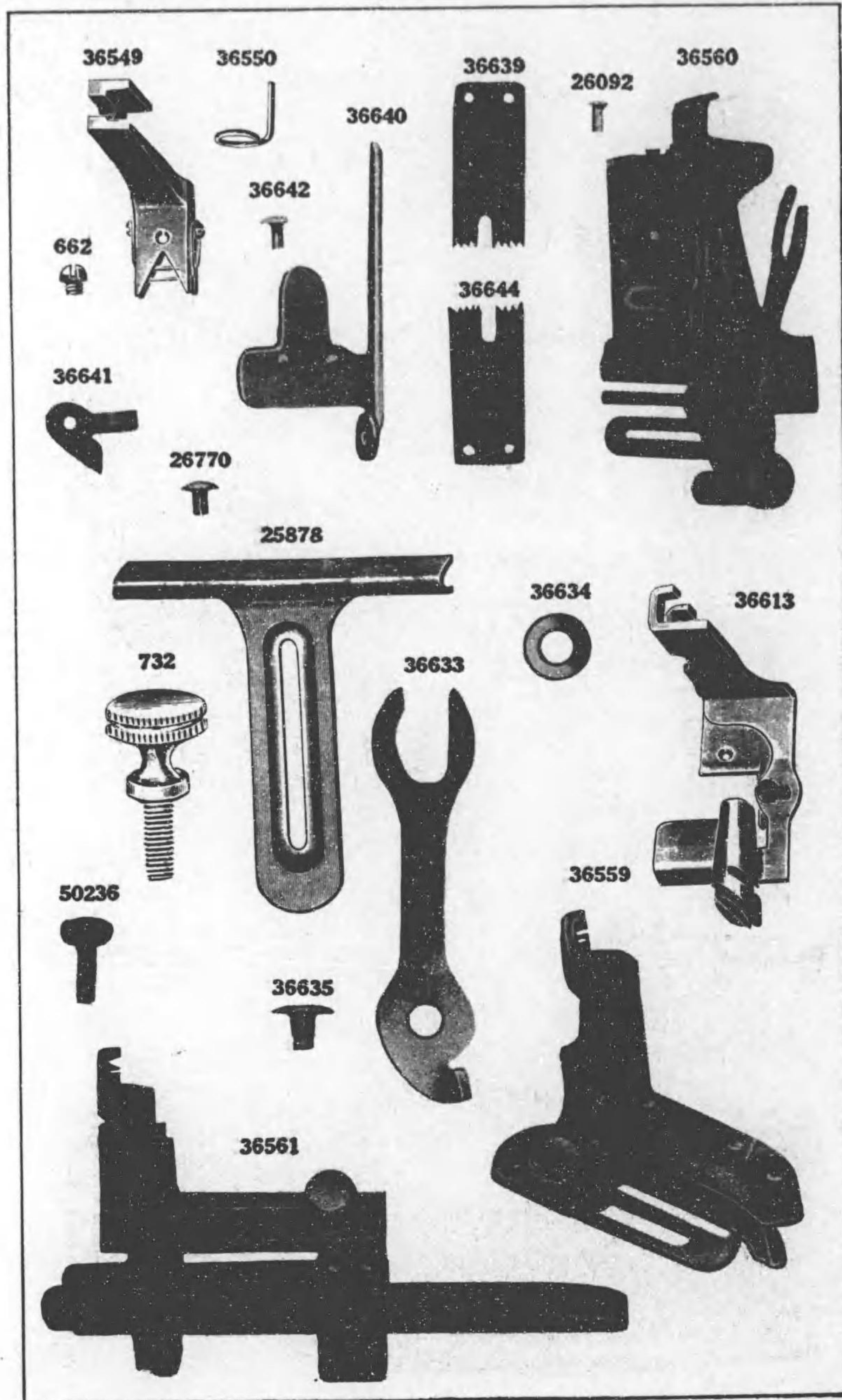

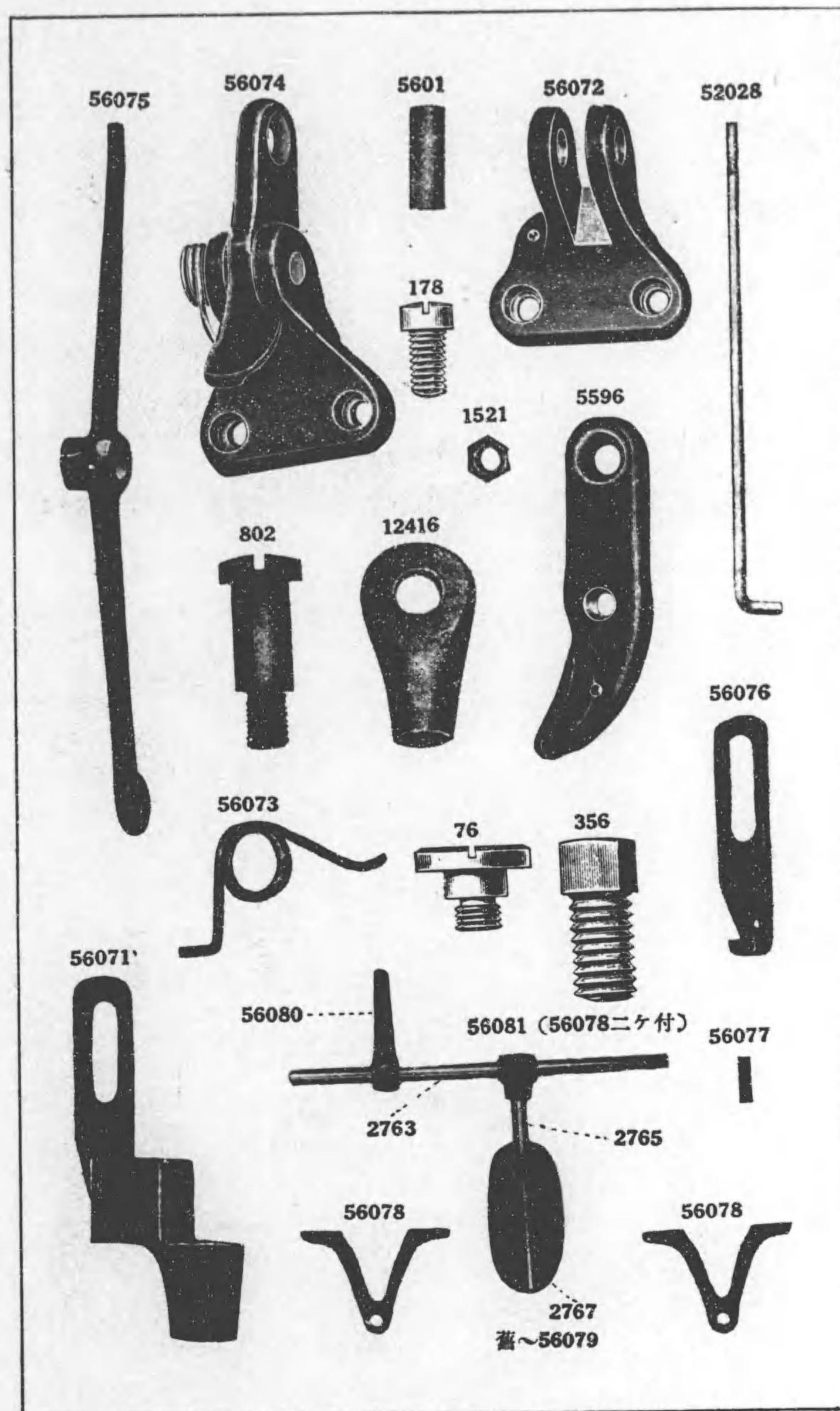
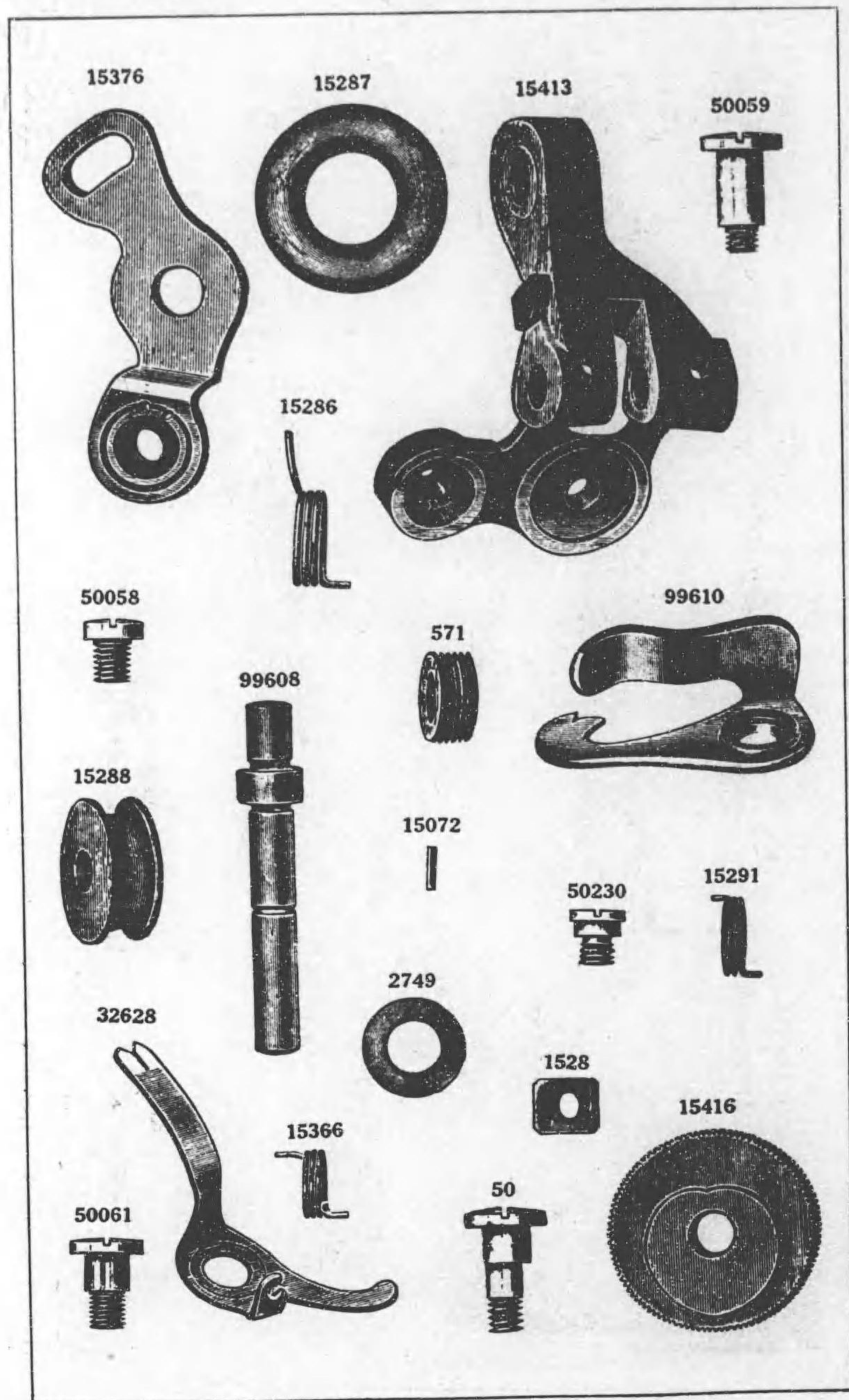

ILLUSTRATION OF PARTS

FOR

B. R. K. MOTOR

ビー、アール、ケー、モーター部分品圖解

部分品 番 號	圖解番號	部分品 番 號	圖解番號	部分品 番 號	圖解番號	部分品 番 號	圖解番號
Parts No.	Plate No.	Parts No.	Plate No.	Parts No.	Plate No.	Parts No.	Plate No.
145	103	191097	99	192989	103	193386	106
225	102	191098	99	192990	101	193387	106
227	101	191417	99	193045	104	193401	105
602	102	191703	101	193065	99	193402	99
691	105	191915	104	193066	99	193437	106
974	101	192140	101	193077	99	193438	100
1550	102	192240	103	193226	100	193509	105
1708	101	192329	103	193227	100	193512	105
1768	103	192339	103	193228	99	193765	106
23258	101	192348	102	193229	99	193794	106
50557	101	192540	99	193230	99	193795	106
50559	102	192542	99	193231	100	193796	106
50564	105	192641	99	193232	100	193797	106
50566	105	192691	103	193233	100	193815	106
50632	99	192692	103	193234	100	193829	105
51093	103	192790	103	193236	99	193936	105
51106	101	192793	103	193238	99	193940	105
51116	102	192796	104	193239	100	193941	105
51117	101	192797	103	193243	101	193942	106
51118	101	192810	101	193244	102	194046	99
51119	104	192819	101	193249	106	194120	105
51202	106	192835	104	193251	105	194304	106
51203	105	192837	101	193252	105	194379	102
51206	100	192851	100	193253	105	198162	104
51207	100	192872	102	193254	105	198163	104
51208	99	192873	103	193255	106	198164	104
51385	106	192875	103	193256	106	198169	104
51582	103	192876	103	193257	106	198222	104
51588	101	192880	102	193258	106	701400	99
51602	105	192882	102	193259	106	701513	99
97359	105	192884	102	193262	106	701690	101
190058	99	192887	103	193265	106	701719	103
190059	99	192907	104	193267	105	701909	105
190075	99	192923	101	193271	106		
190076	99	192925	104	193272	105		
190083	99	192926	104	193276	106		
190439	103	192929	102	193278	105		
190563	103	192957	102	193289	106		
190613	103	192983	102	193294	105		
190782	99	192985	101	193318	99		

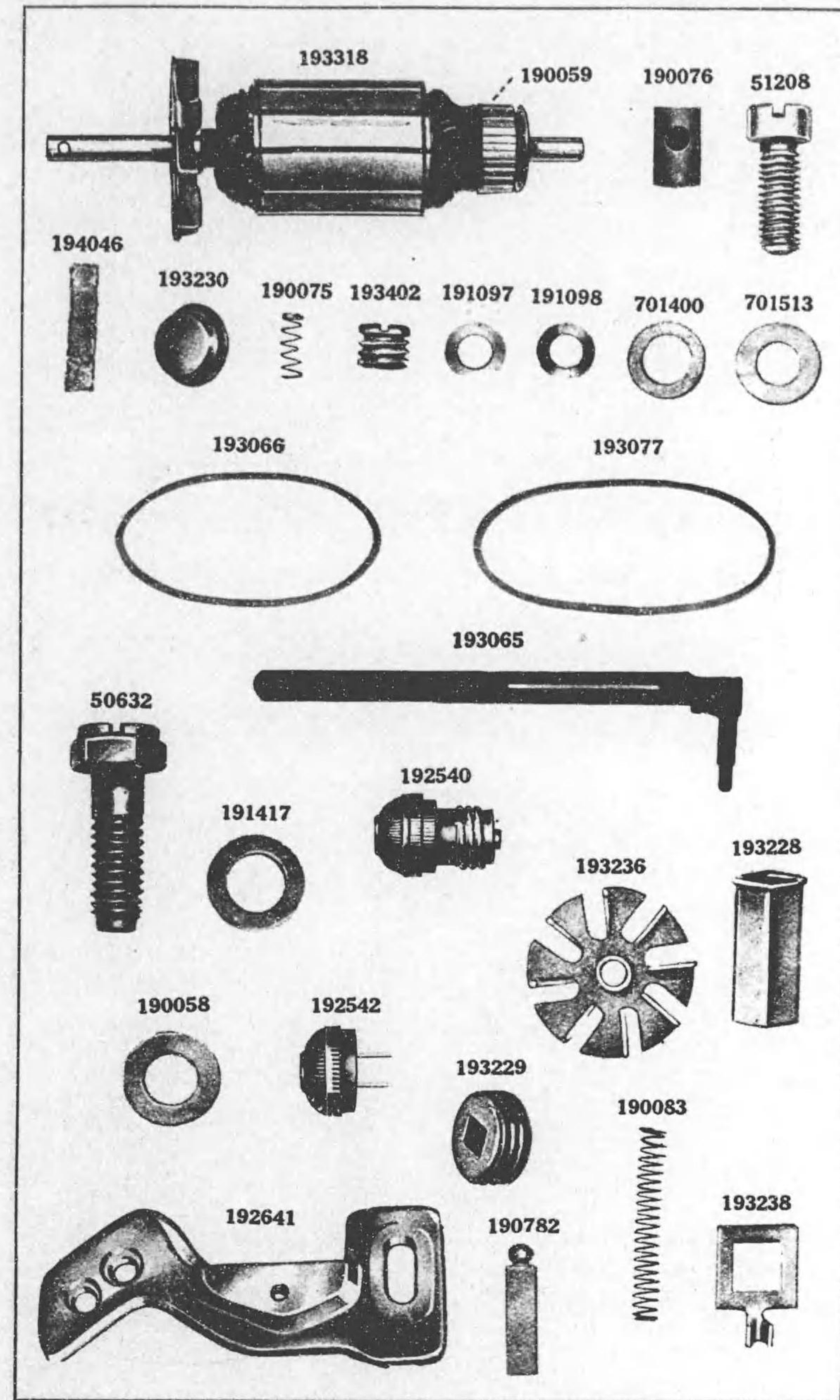

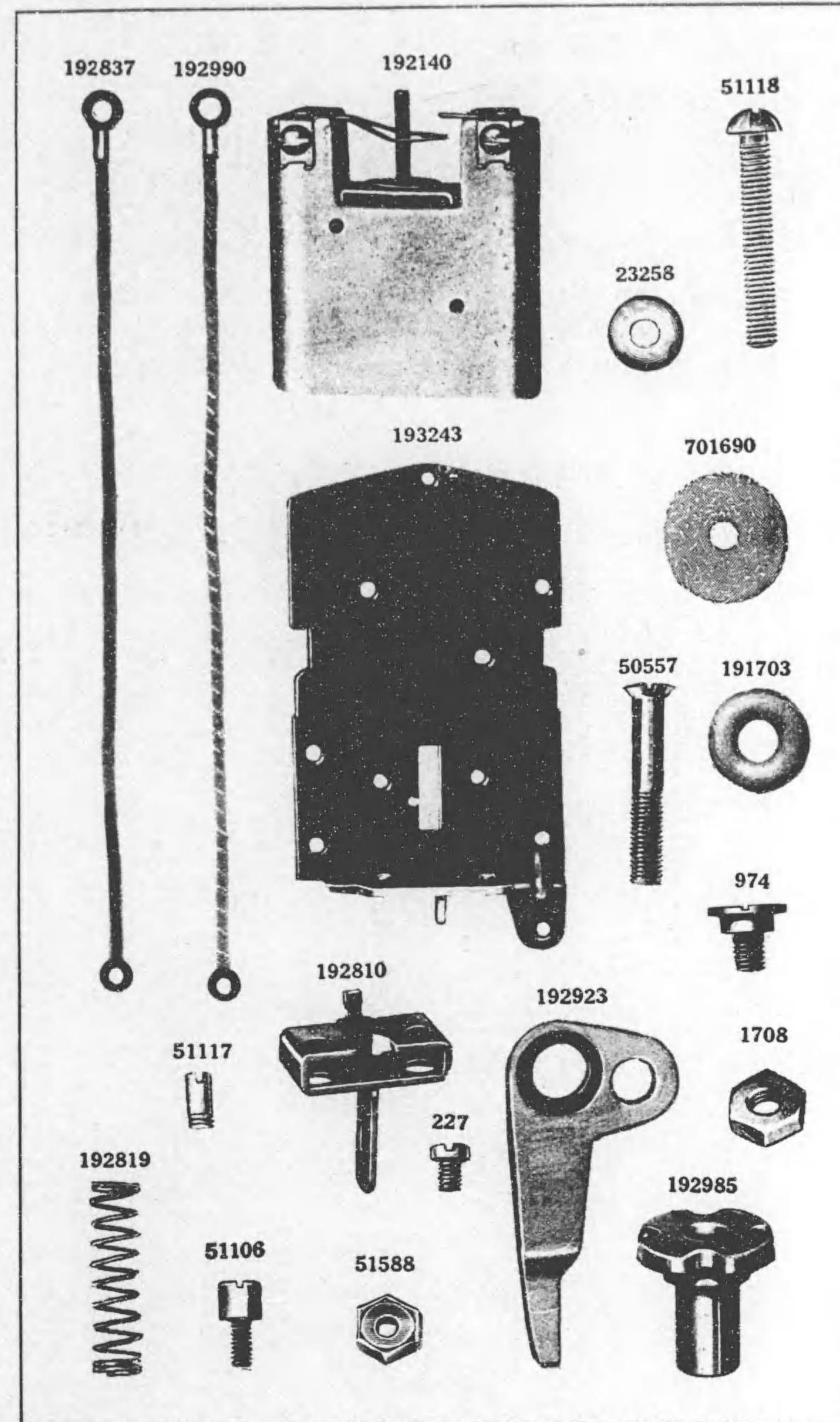
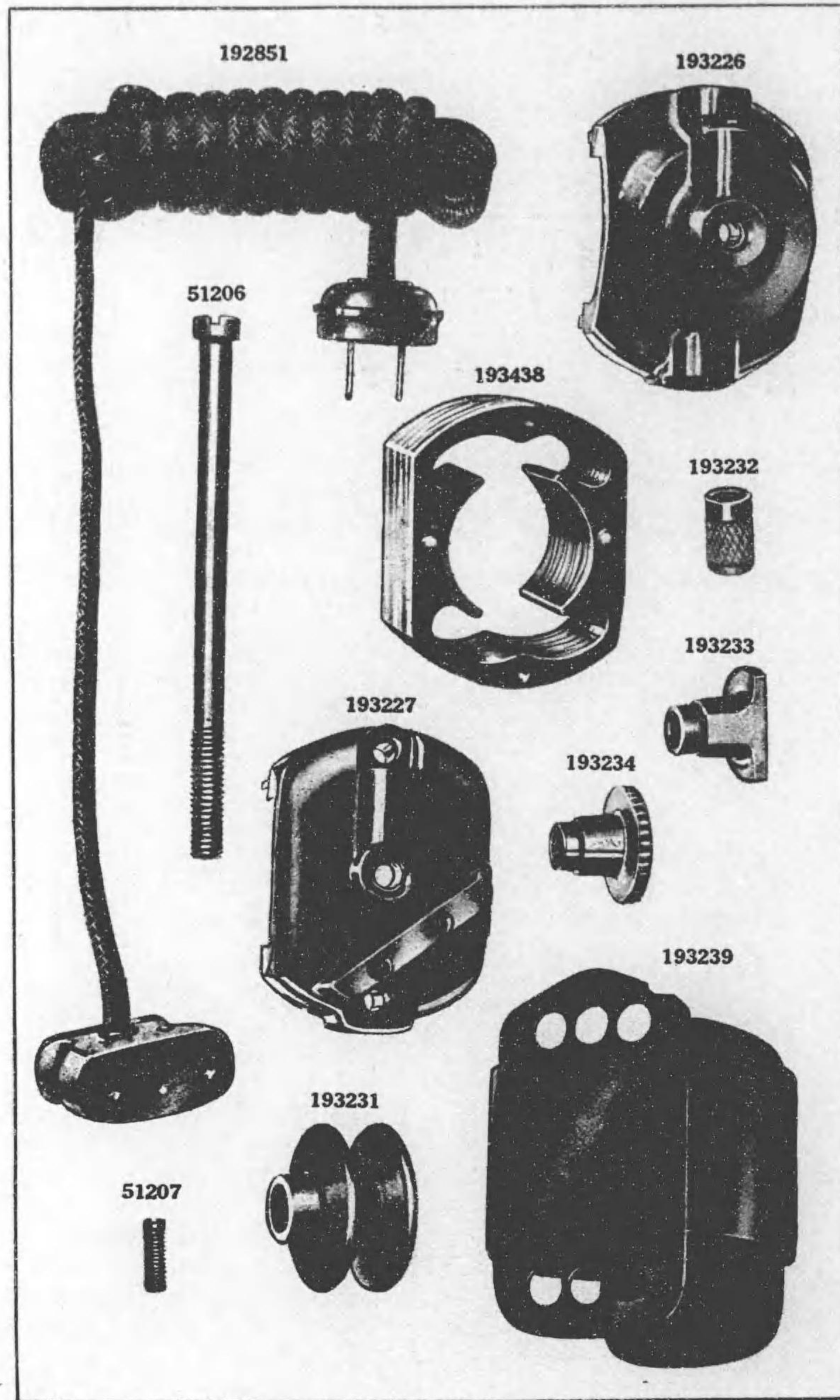

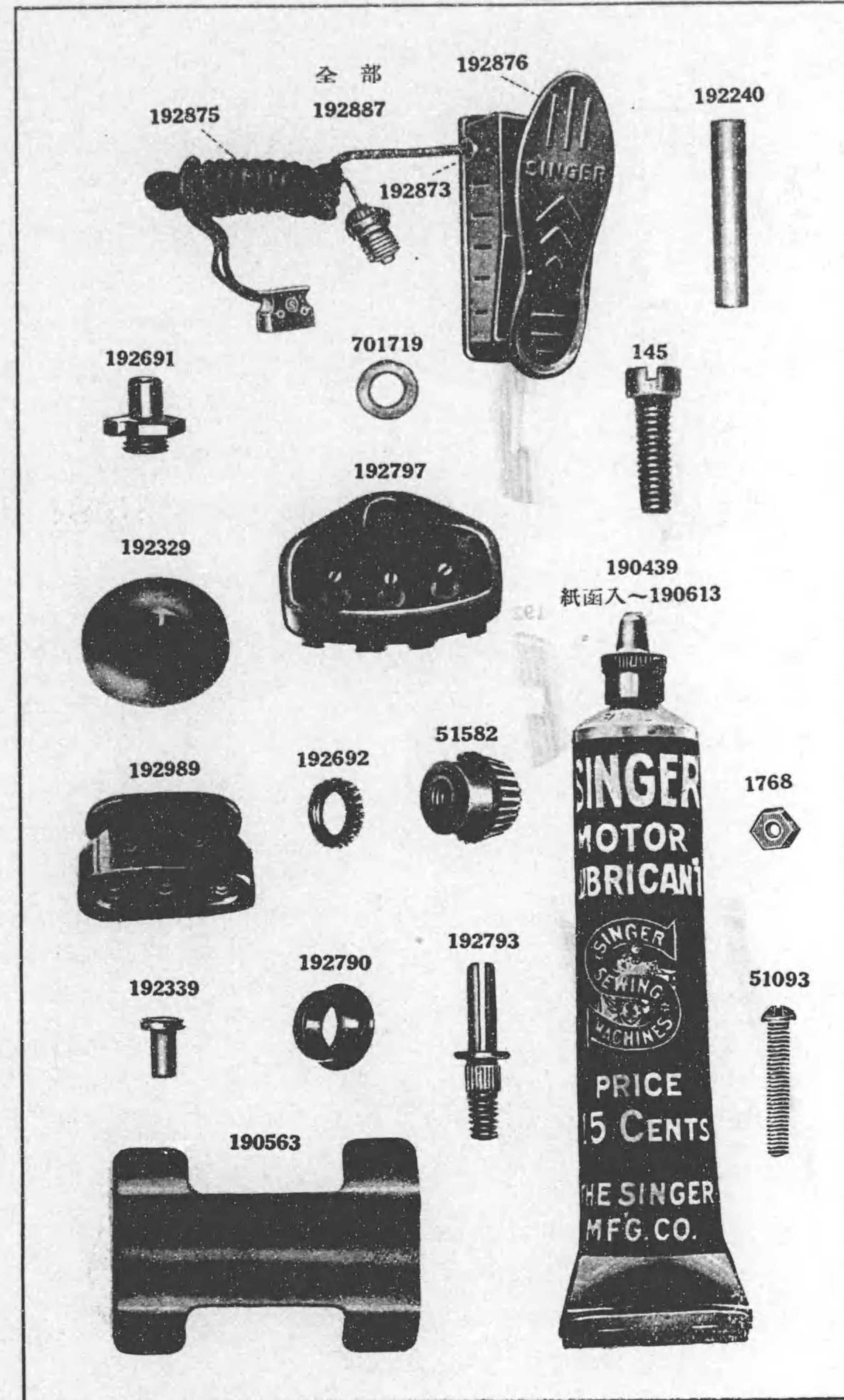
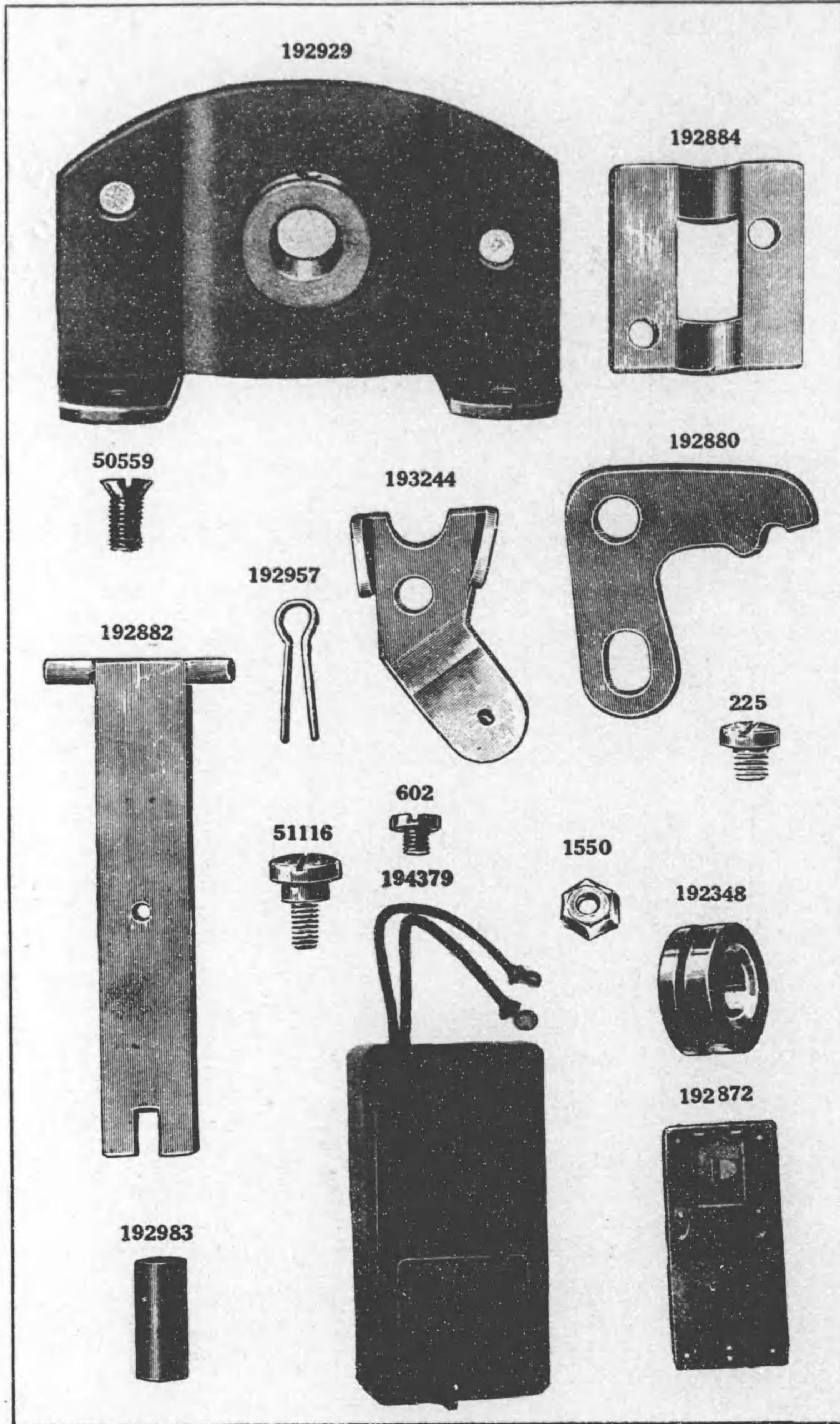

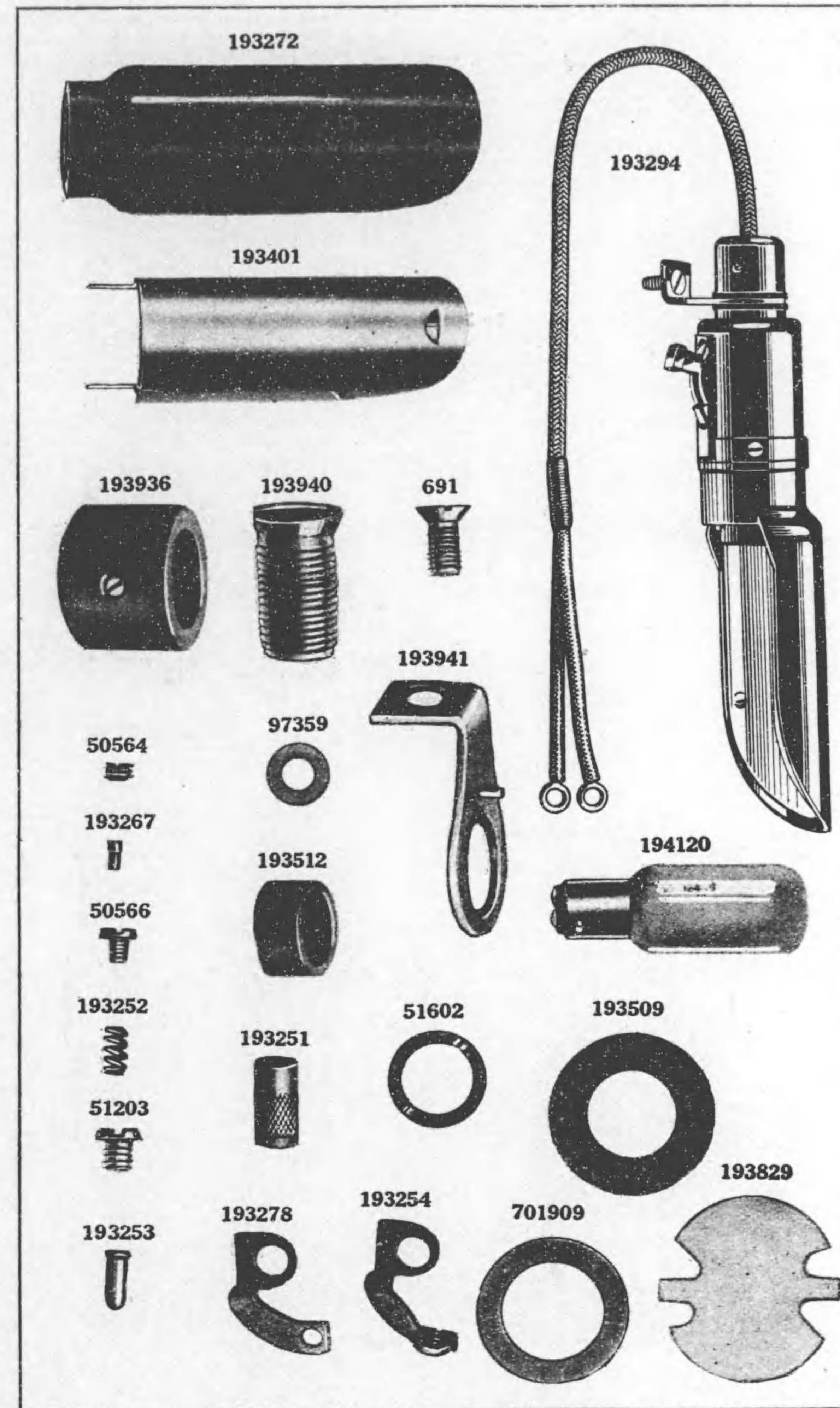
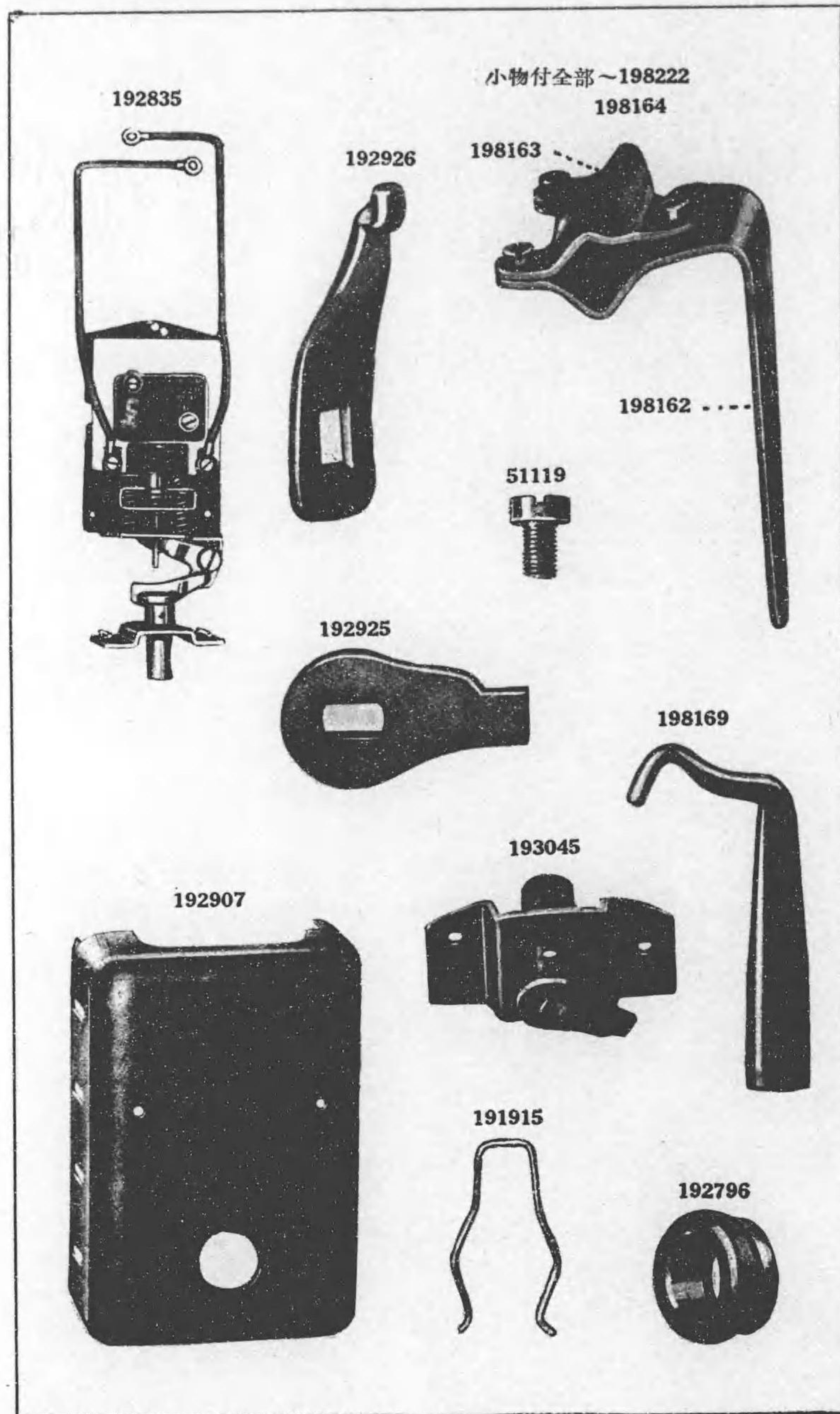

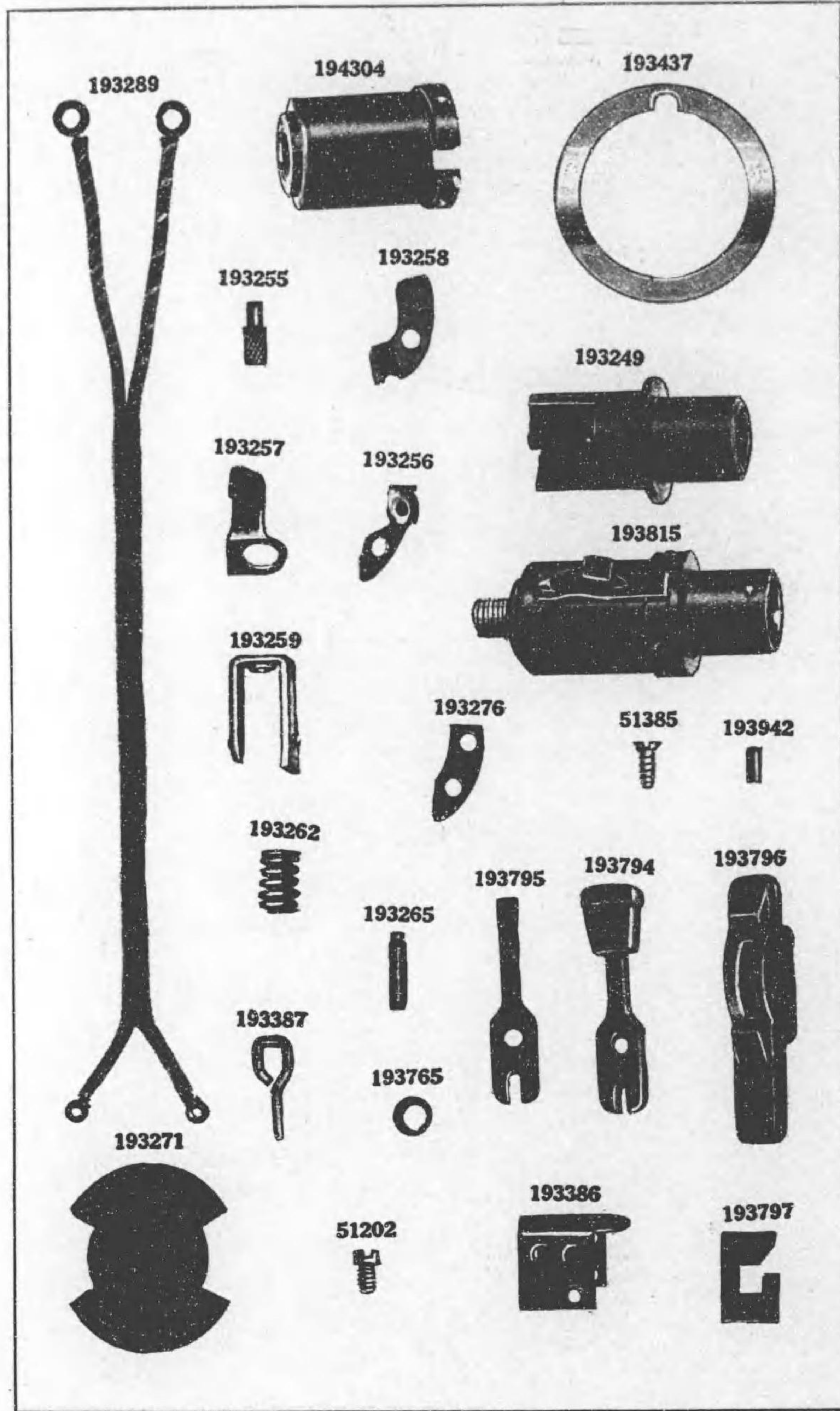

ILLUSTRATION OF PARTS

CABINET WORK AND FITTINGS

木製品及之レニ附屬スル金具類圖解

Cabinet Work-Fittings 木製品ト附属金具

部分品 番 號	圖解番號	部分品 番 號	圖解番號	部分品 番 號	圖解番號	部分品 番 號	圖解番號
Parts No.	Plate No.	Parts No.	Plate No.	Parts No.	Plate No.	Parts No.	Plate No.
34	110	28018	110	56262	109	96676	109
N.N. 83	112	28019	110	56356	110	96685	109
122	115	28076	107	56429	108	96779	118
302	110	28079	107	56430	107	96790	110
S.S. 368	113	28088	112	56493	113	96801	118
525	107	28123	109	56494	112	96802	118
732	113	28125	116	56495	113	96805	112
972	110	28205	110	56496	110	96806	112
1272	110	28206	110	56497	110	96807	117
1507	110	28208	111	56498	112	96808	117
1510	109	28210	110	82800	115	96839	114
1518	107	28211	110	87352	108	96896	113
1727	114	28227	110	87353	108	97001	116
1734	109	28231	112	87427	113	97010	115
2807	107	28242	113	87572	113	97011	115
"	114	28247	111	87605	108	97012	115
2809	108	28253	110	87606	108	97013	115
8292	107	28291	110	87623	114	97014	115
8294	107	"	118	87723	113	97015	115
"	114	28297	107	87724	112	97020	117
8306	107	28298	114	87876	115	97021	117
9281	109	41400	114	88025	115	97024	115
12361	114	44139	114	88093	117	97025	115
20022	114	44140	114	88094	117	97026	115
22436	113	46510	111	88100	117	97027	115
25001	114	46525	110	96473	108	97028	115
25003	114	46548	107	96507	107	97029	115
25027	114	46671	107	96512	116	97030	115
25033	110	50199	114	96513	116	97031	115
25047	107	50251	109	96514	116	97032	115
25056	107	50549	112	96517	116	97034	116
25057	114	50550	112	96522	115	97035	116
25060	114	50574	111	96546	116	97038	116
25070	113	50616	114	96547	116	97078	116
25127	114	50988	109	96615	115	97079	116
25152	108	51045	108	96616	115	97080	116
28005	110	56069	114	96618	107	97081	116
28012	110	56253	111	96632	107	97200	116
28016	110	56260	109	96633	116	124308	112
28017	110	56261	109	96634	116	124309	112

Cabinet Work-Fittings 木製品ト附属金具

部分品 番 號	圖解番號	部分品 番 號	圖解番號	部分品 番 號	圖解番號	部分品 番 號	圖解番號
Parts No.	Plate No.	Parts No.	Plate No.	Parts No.	Plate No.	Parts No.	Plate No.
124310	112						
124311	112						
124315	111						
124318	112						
124324	112						
124331	111						
124333	110						
124351	111						
124352	108						
124352	111						
124354	112						
124381	109						
124384	109						
124388	113						
124390	113						
124403	113						
124429	112						
124430	109						
124431	109						
124433	109						
124449	109						
124460	108						
124484	108						
124486	108						
124487	108						
124494	108						
124516	112						
124517	113						
124542	113						
124583	116						
124586	108						
126319	114						
126320	114						
126366	114						

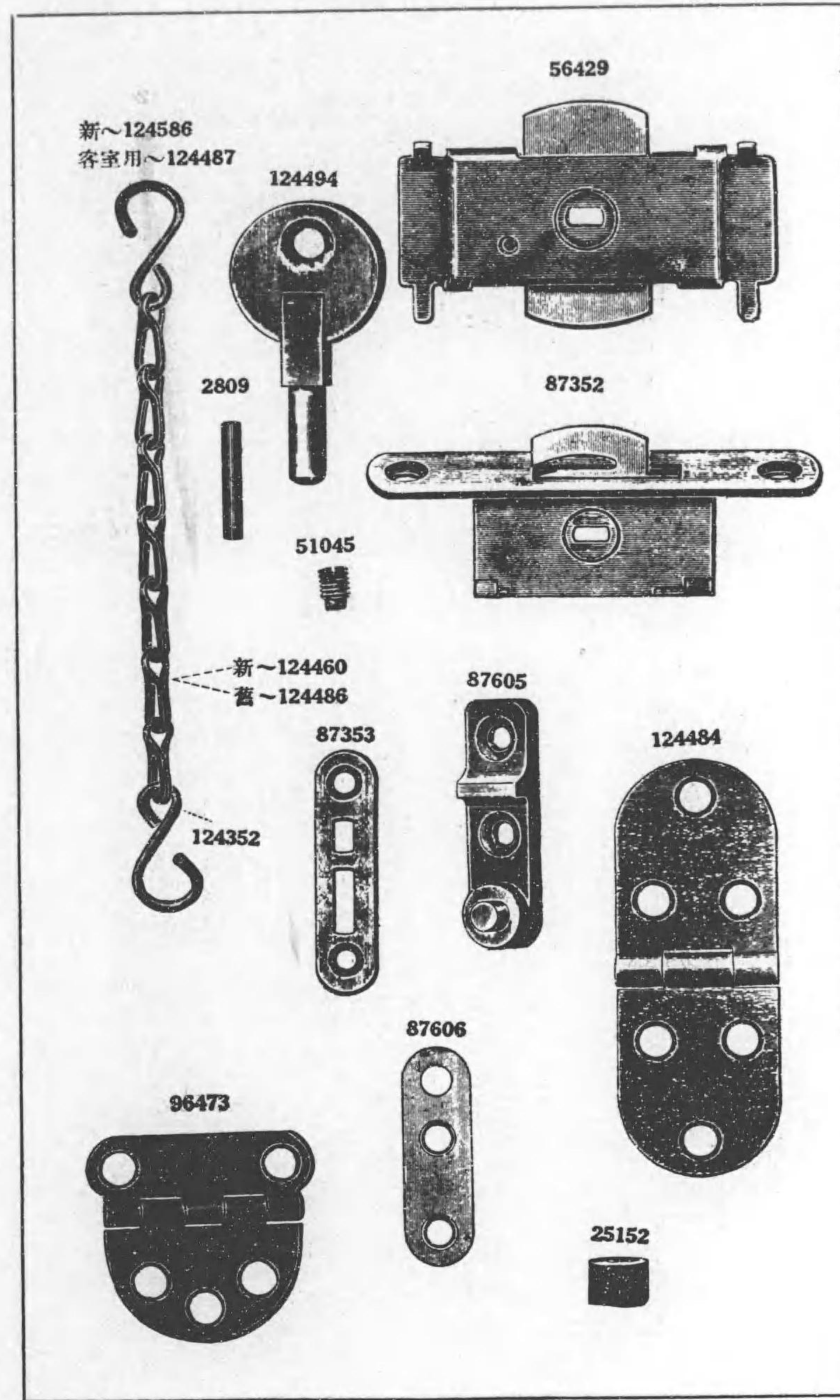
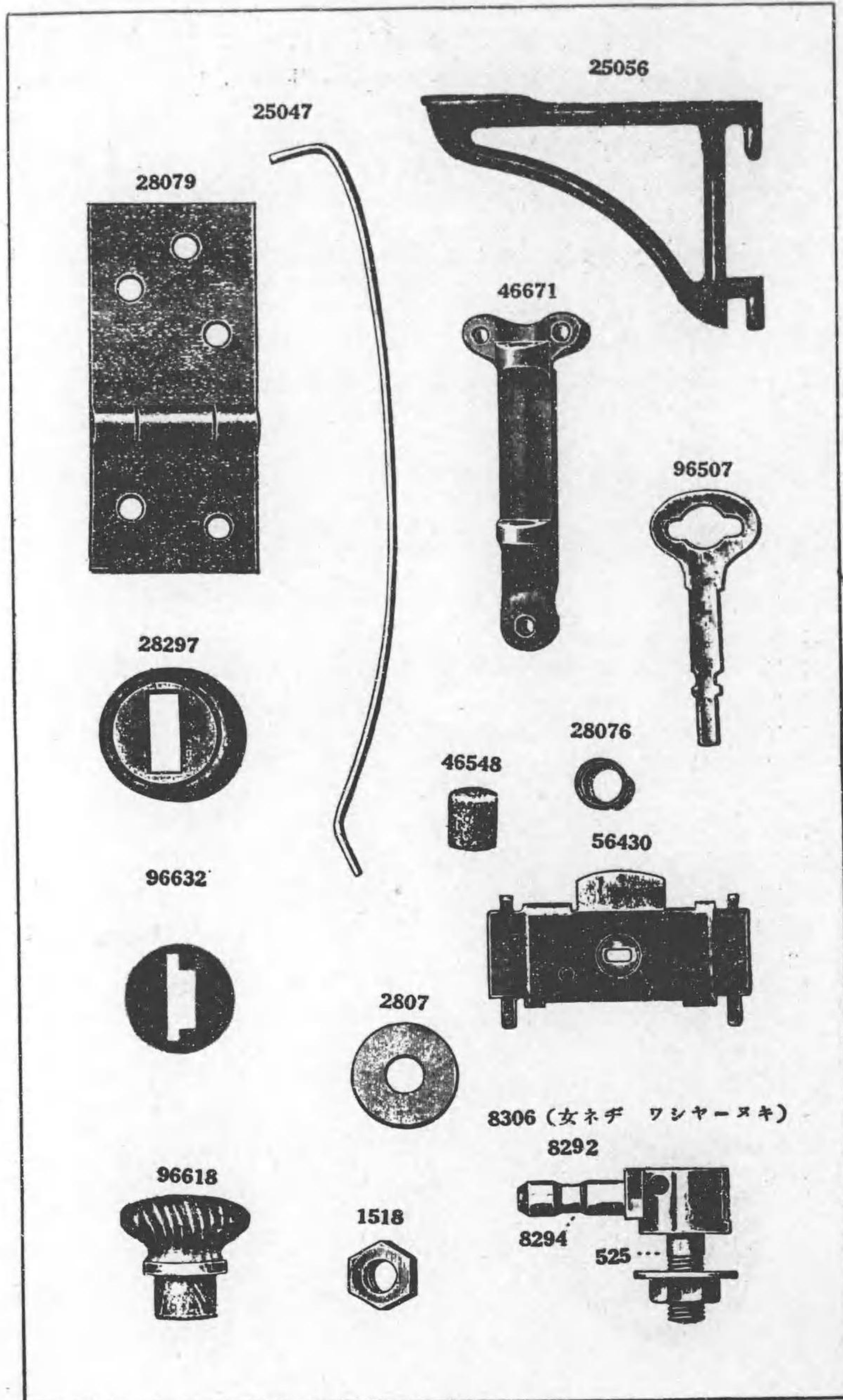

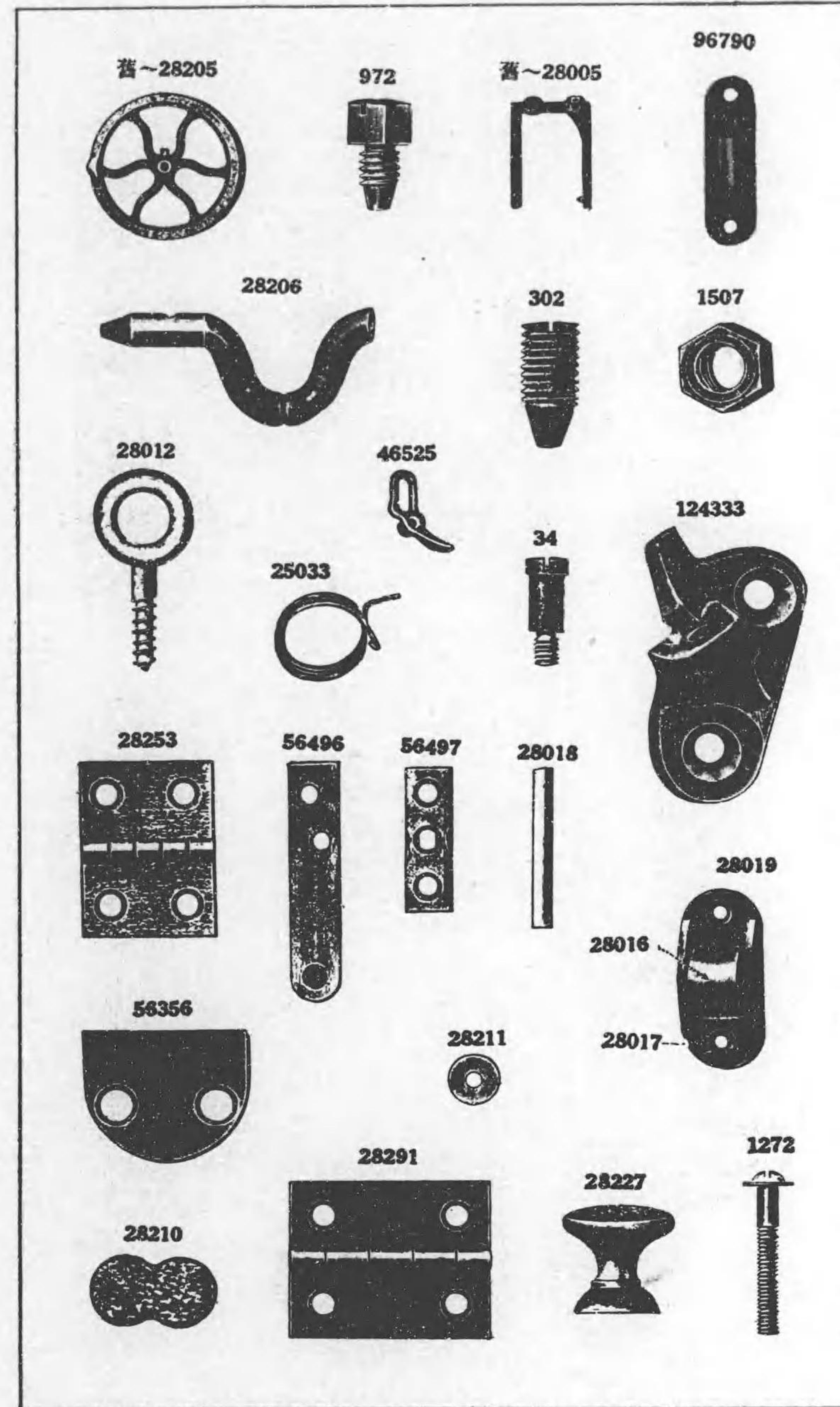
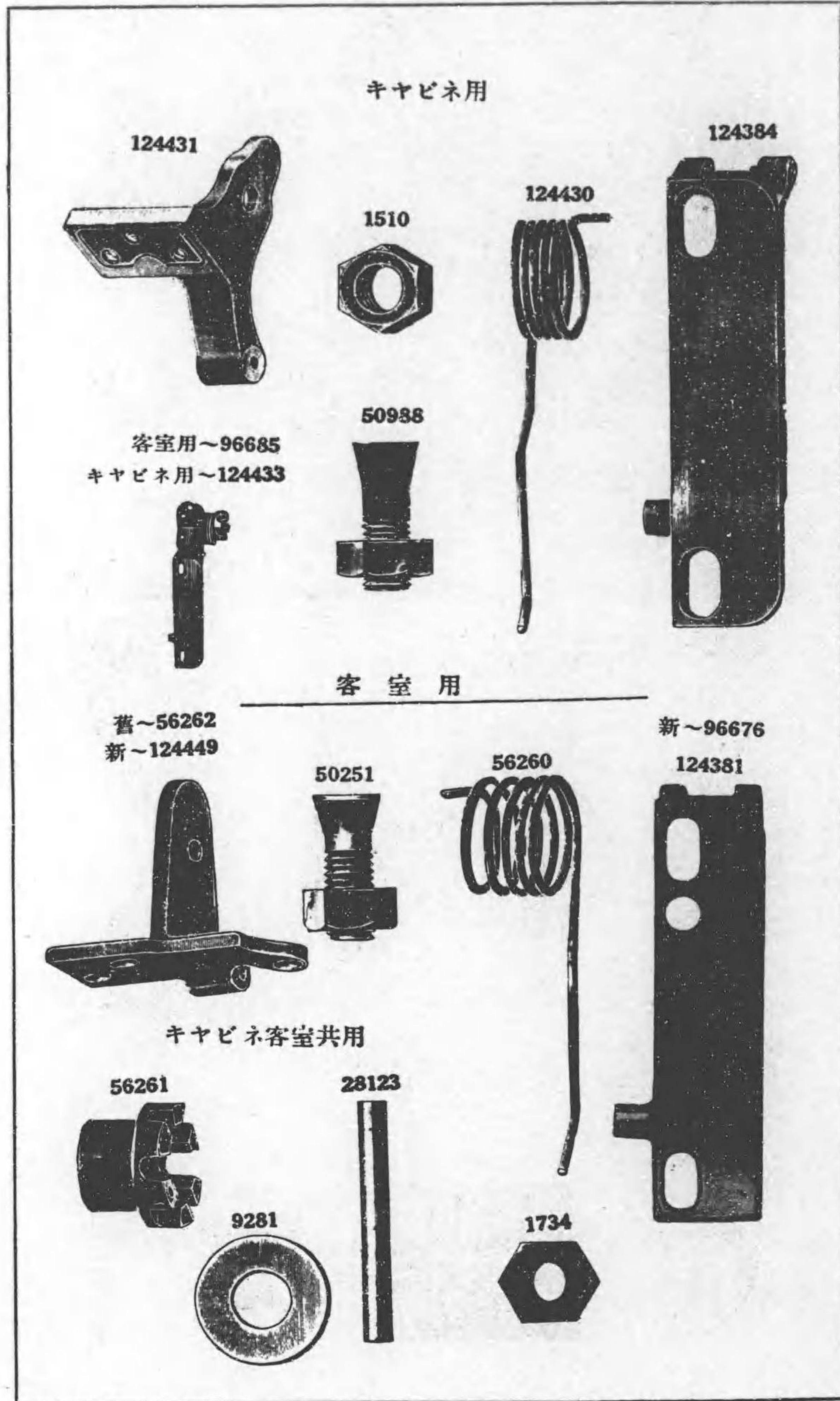

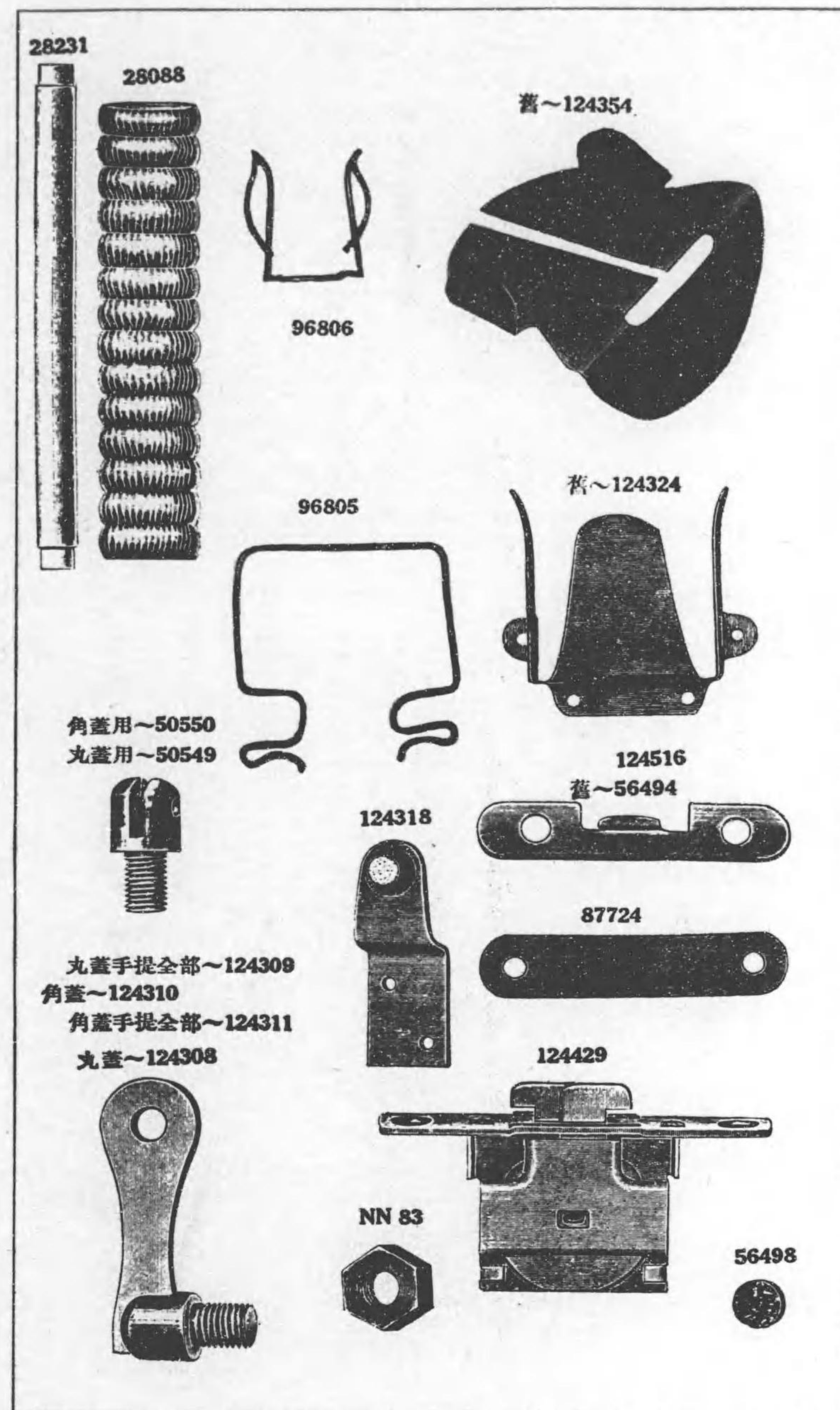
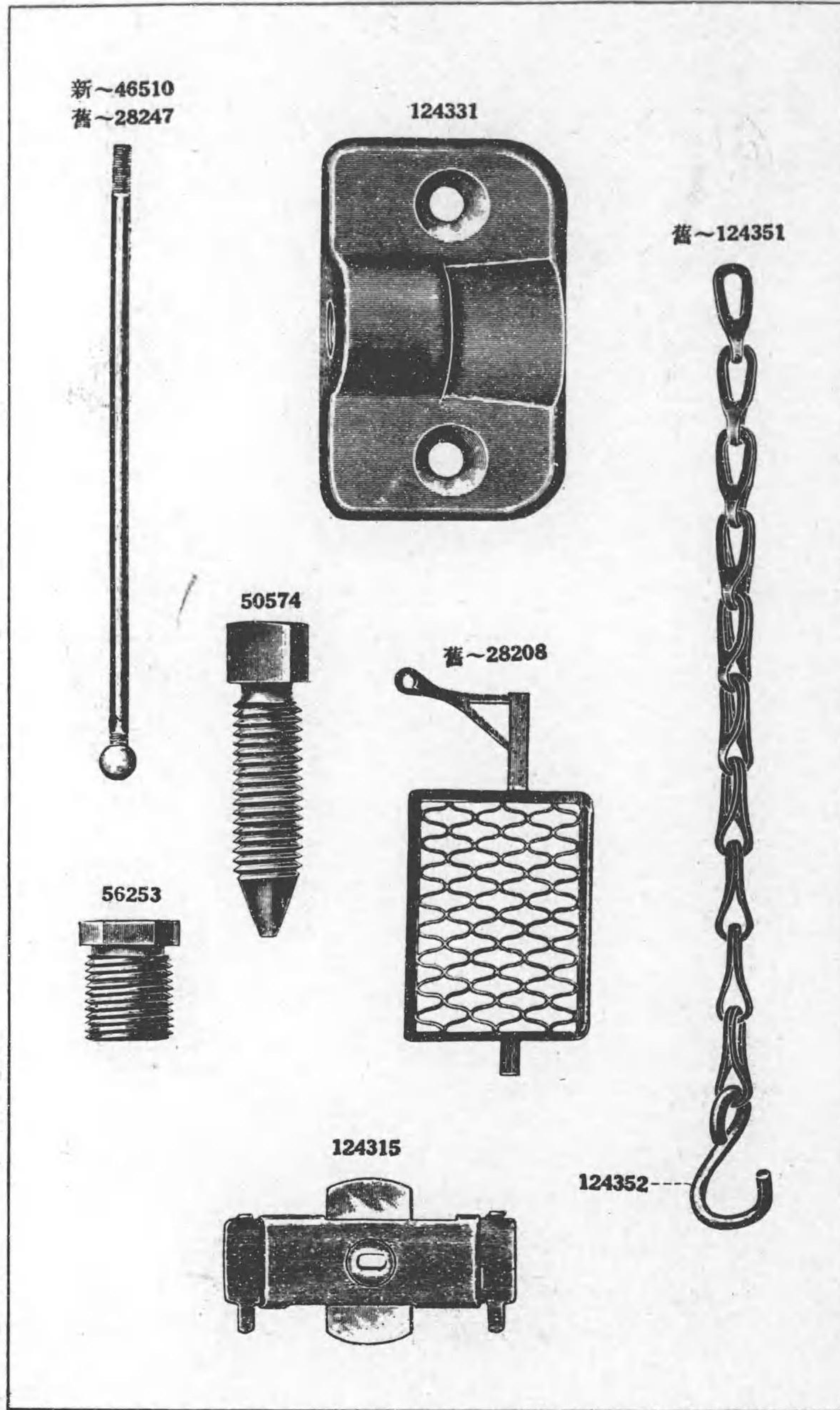

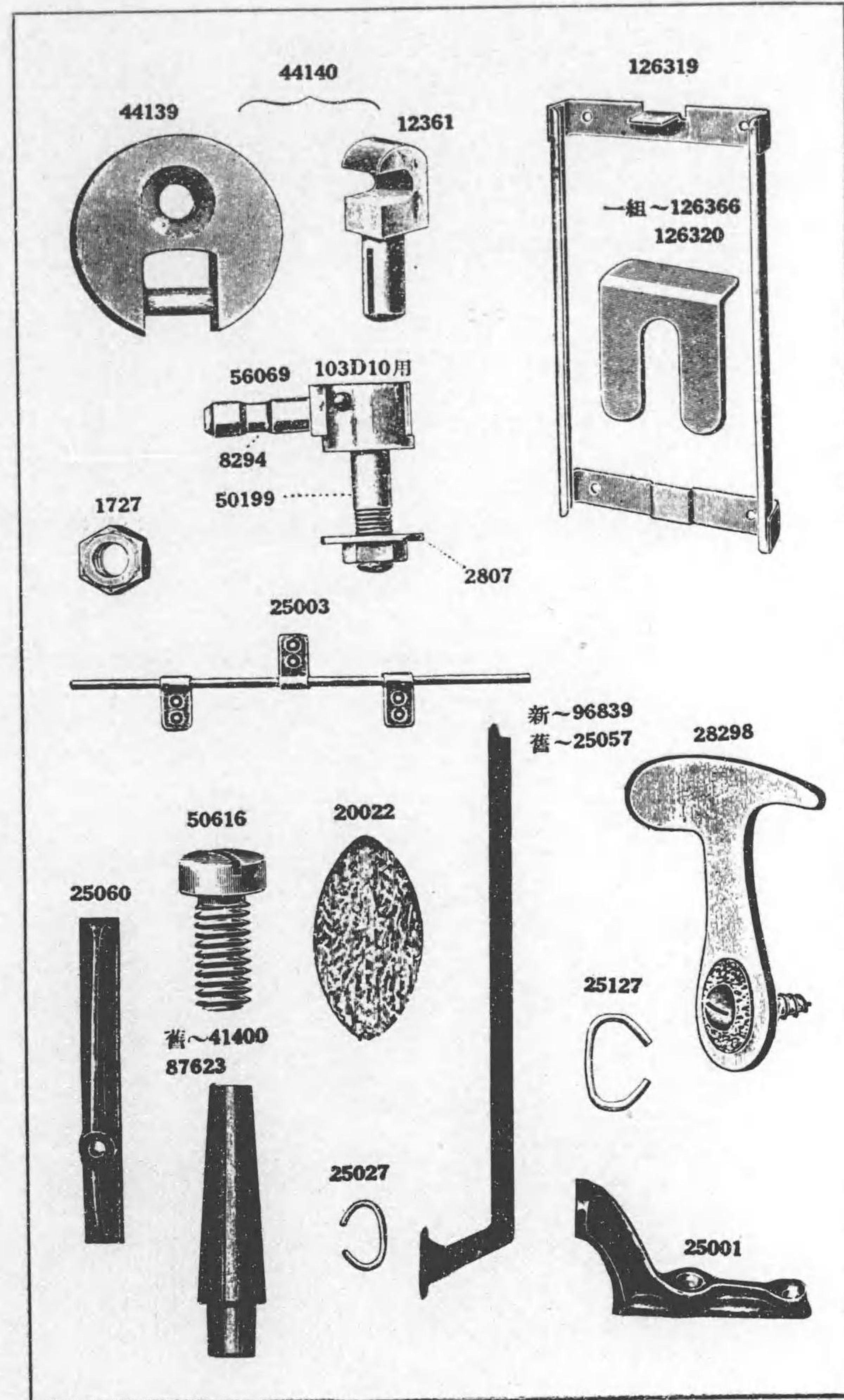
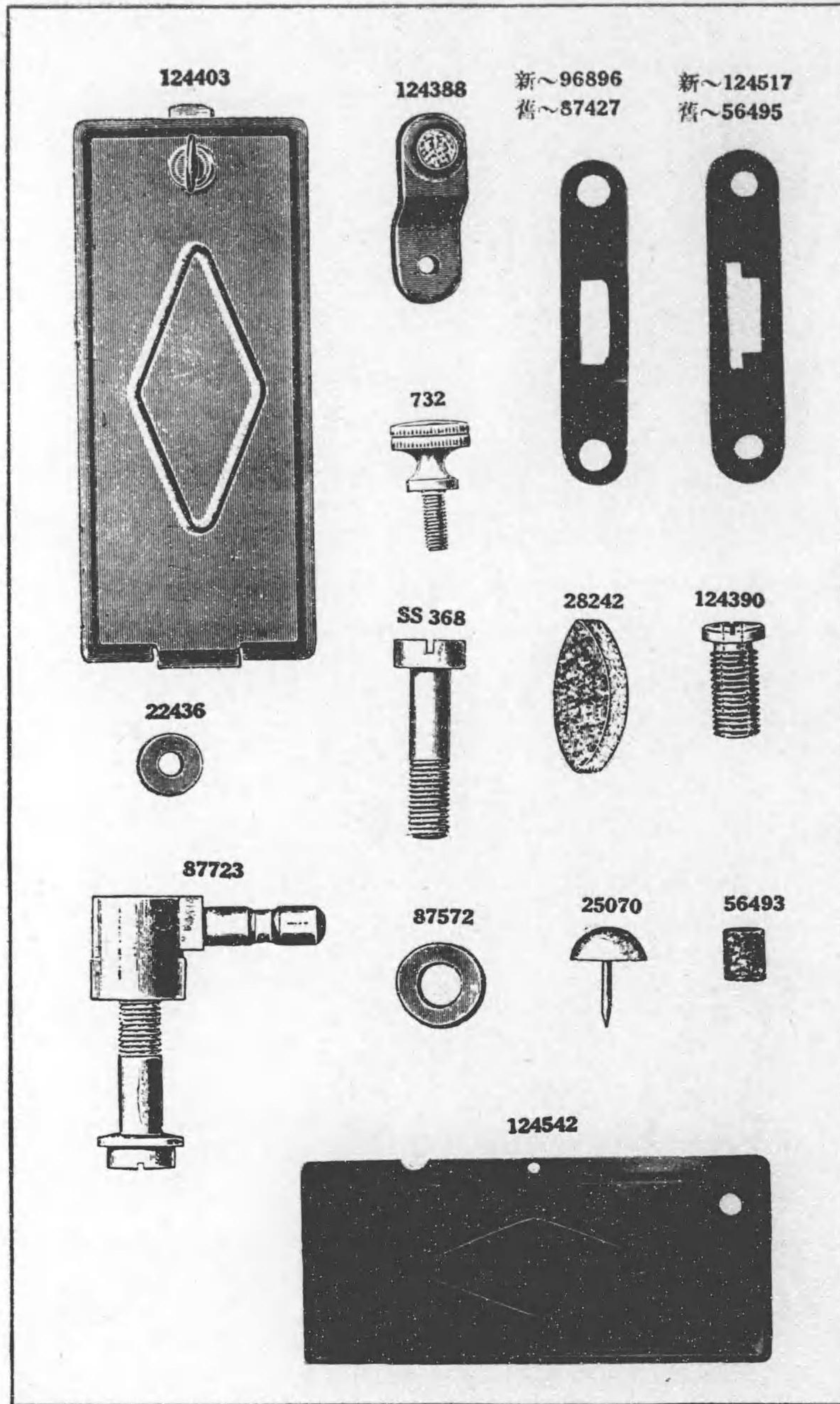

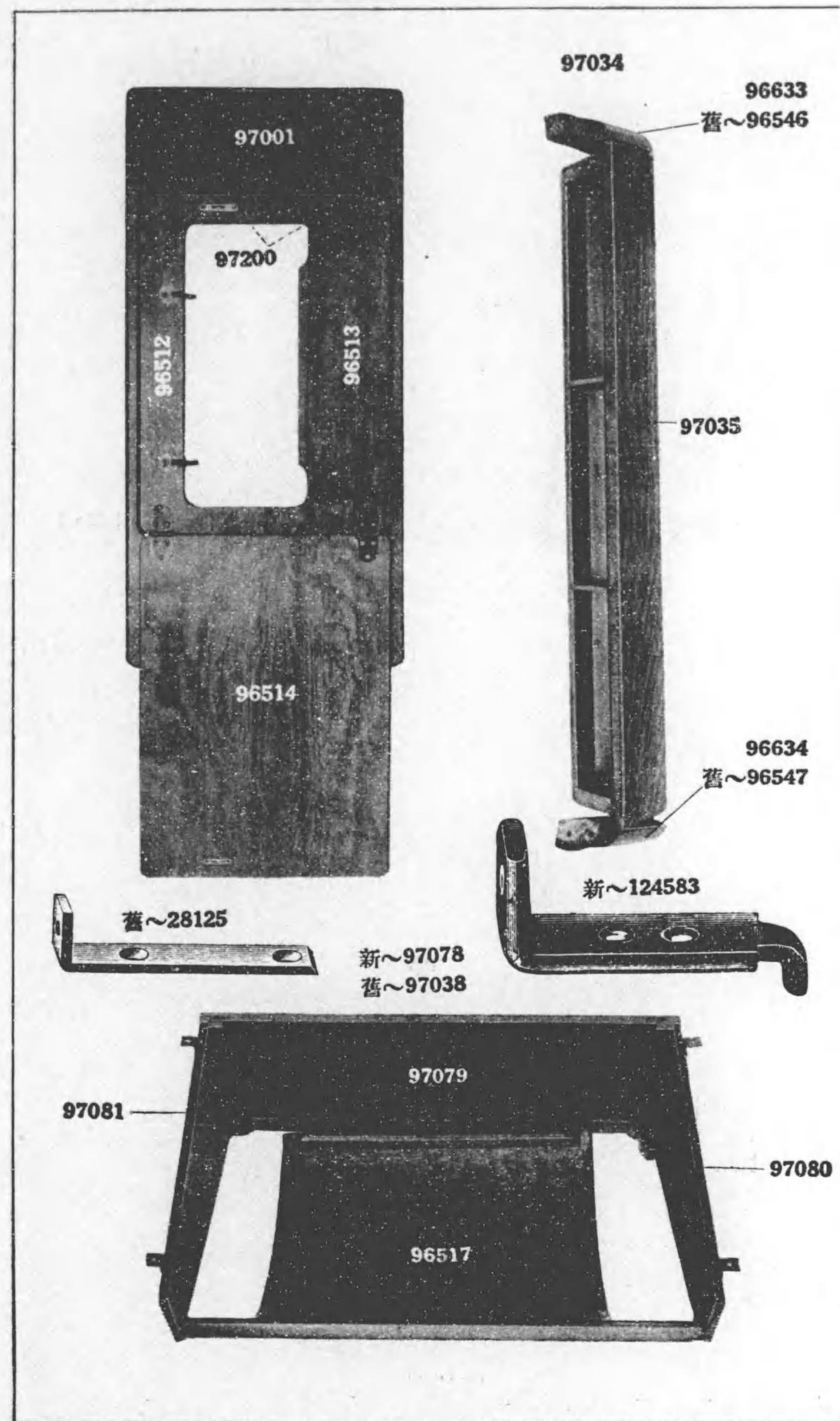
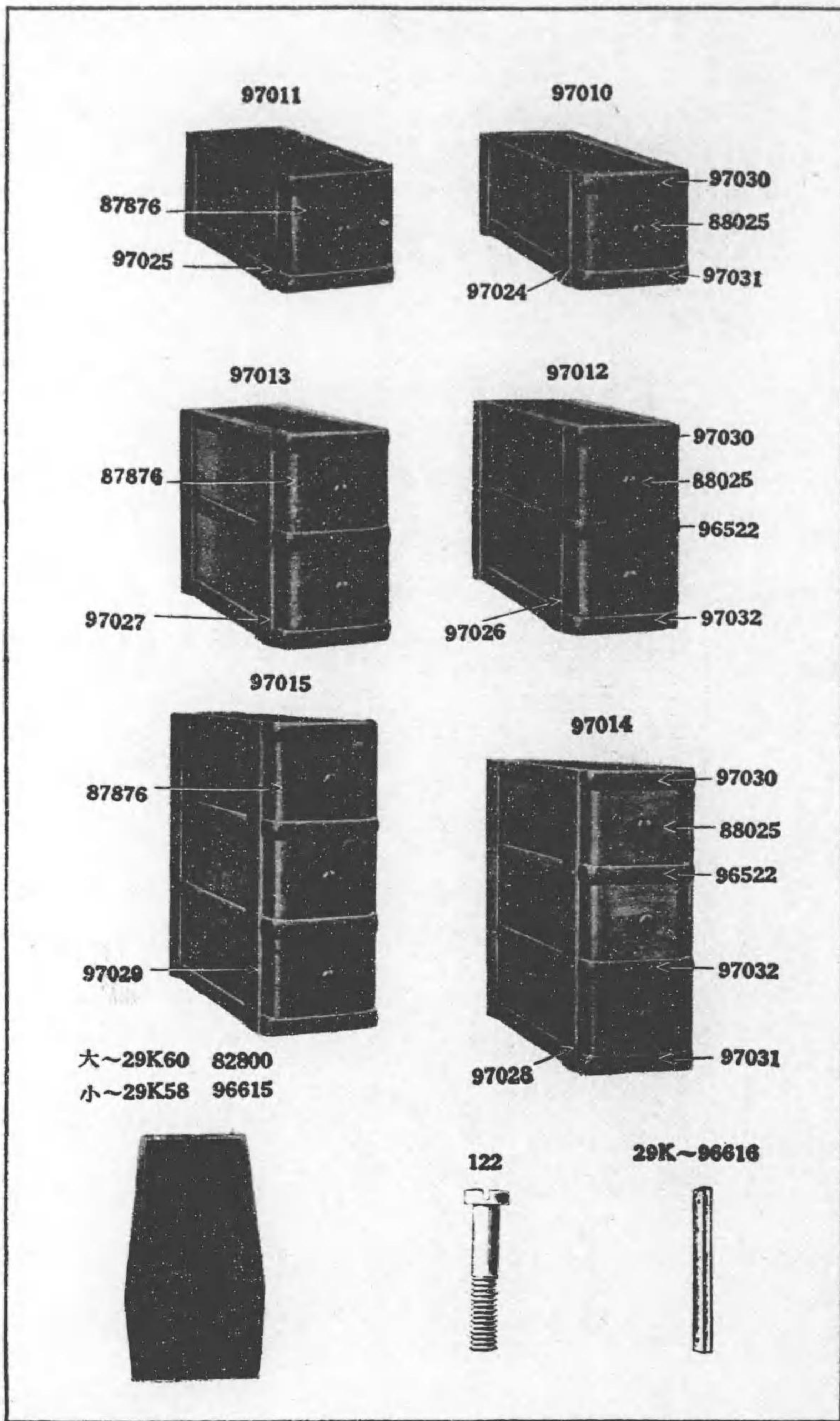

第百十七圖

Cabinet Work and Fittings
木製品ト附屬金具

PLATE 117

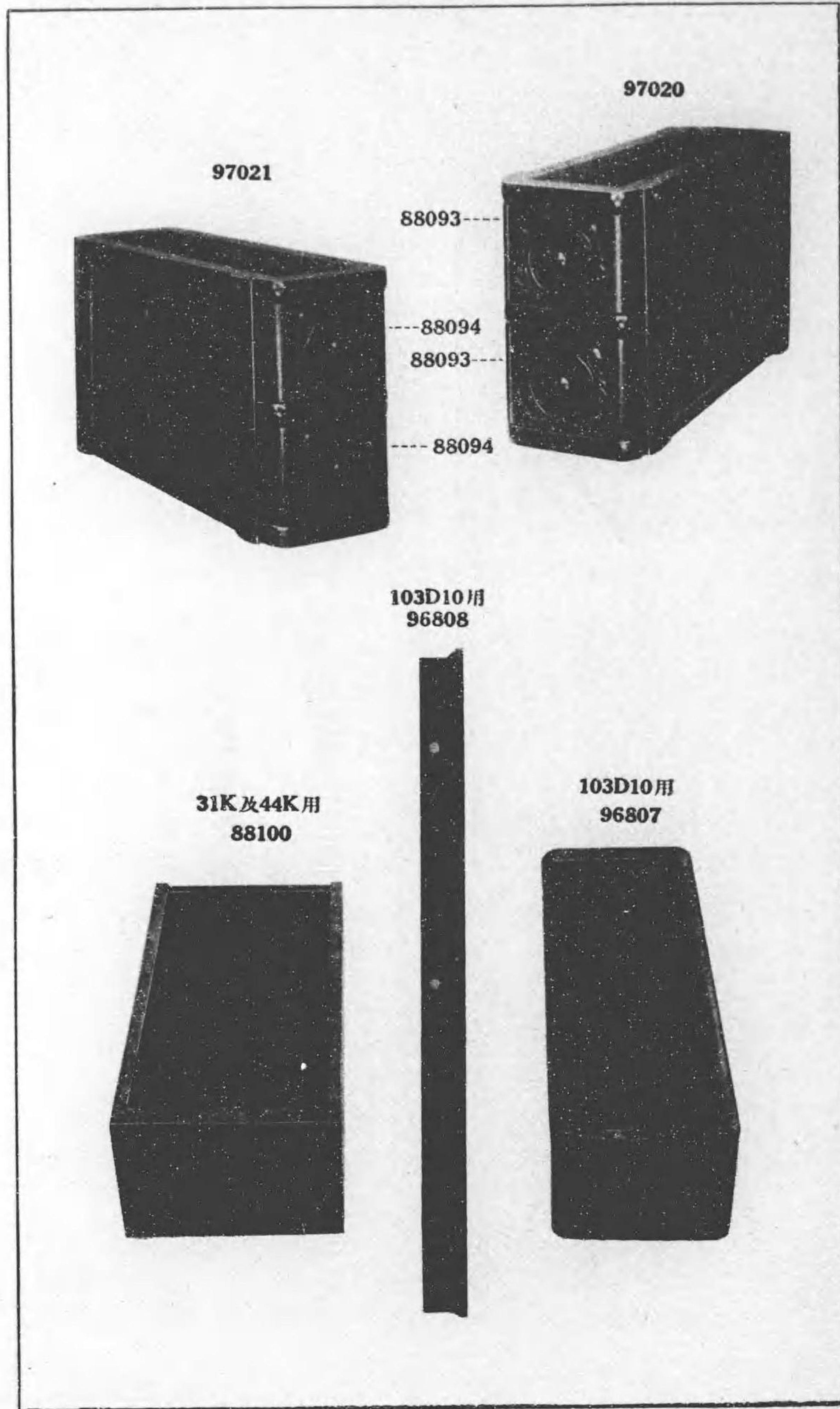

PLATE 118

Cabinet Work and Fittings
木製品ト附屬金具

第百十八圖

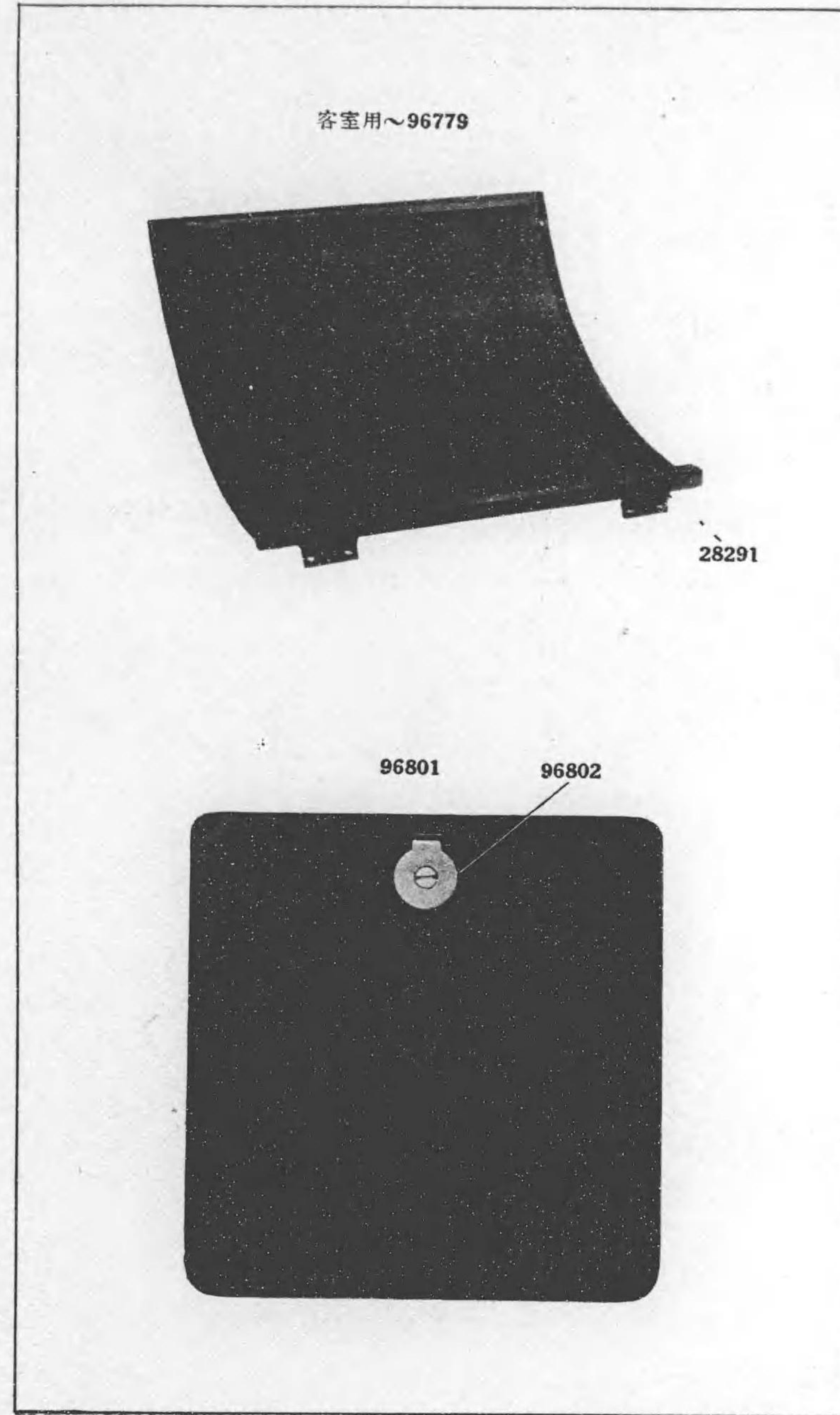

ILLUSTRATION OF PARTS

FOR
STANDS



脚
部
部
分
品
圖
解

Stands 脚部

部分品 番 號	圖解番號	部分品 番 號	圖解番號	部分品 番 號	圖解番號	部分品 番 號	圖解番號
Parts No.	Plate No.	Parts No.	Plate No.	Parts No.	Plate No.	Parts No.	Plate No.
34	121	46523	119	94770	127		
297	120	46524	124	94771	127		
297	123	46525	121	94772	126		
506	123	46550	124	94773	126		
S.S. 556	128	46551	124	94774	126		
S.S. 557	122	46552	124	"	129		
S.S. 585	128	46553	123	94775	127		
649	124	46554	123	94776	127		
670	124	46622	123	94777	126		
972	120	46623	128	94778	129		
972	123	46635	122	94779	125		
1059	121	46655	119	94780	125		
1059	123	46656	124	94781	129		
1288	120	46658	124	94782	125		
1507	120	46659	124	94783	125		
1507	123	46660	124	94798	129		
"	128	46664	124	94799	129		
1510	121	46665	124	94800	129		
"	123	46666	124	96750	128		
1520	119	46691	120	102030	128		
1670	119	46800	121	126038	124		
2718	124	50581	124				
25033	121	51074	128				
25065	123	51374	120				
25068	121	51581	128				
25069	121	94607	128				
25077	123	94727	120				
25078	123	94728	119				
25361	119	94729	119				
25362	119	94730	120				
25368	124	94734	121				
25369	123	94735	121				
25371	119	94736	122				
46506	119	94737	122				
46507	119	94738	122				
46508	119	94739	122				
46509	119	94749	128				
46510	119	94762	121				
46519	119	94763	121				
46520	119	94764	121				

PLATE 119

Stands 脚部

第一百十九圖

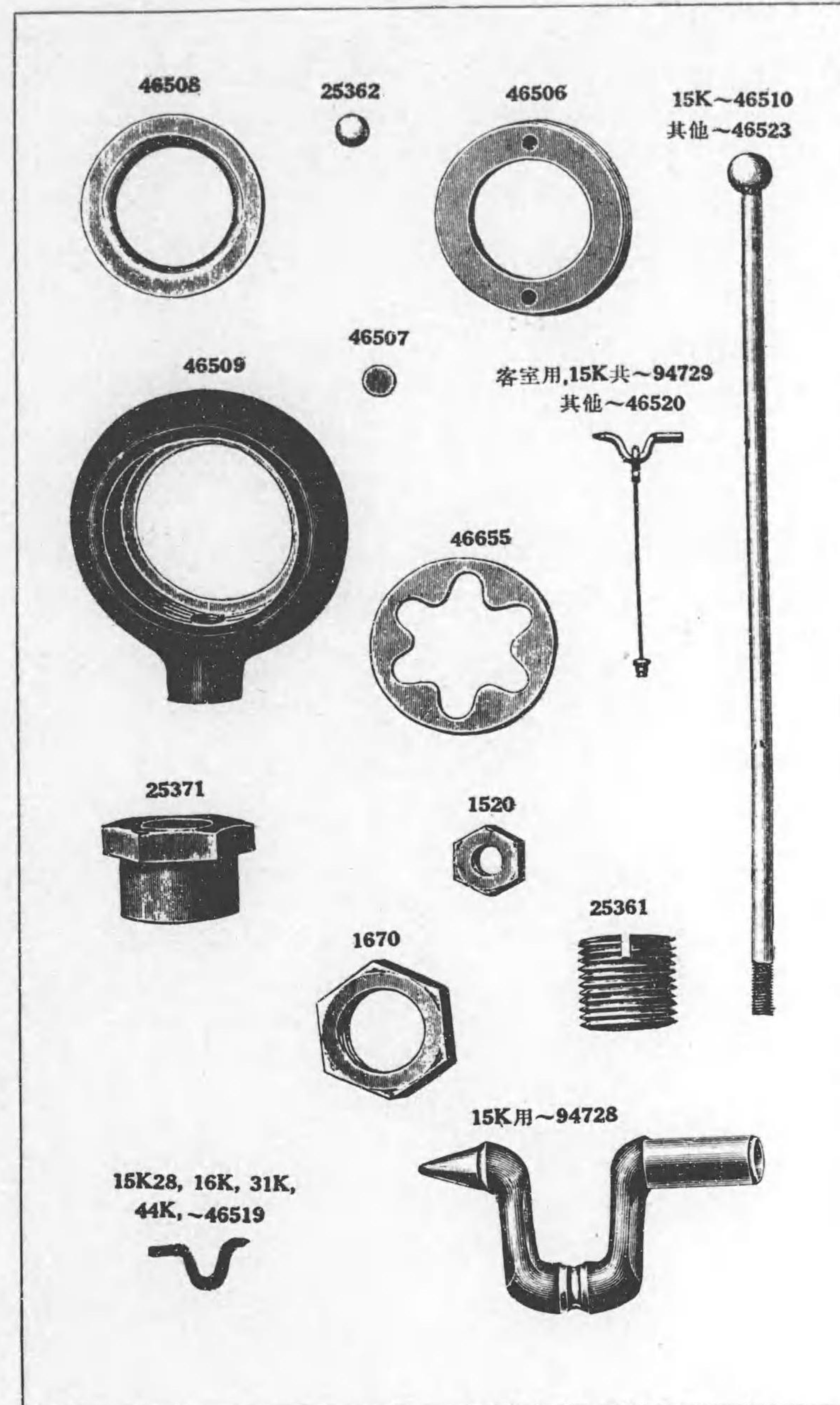

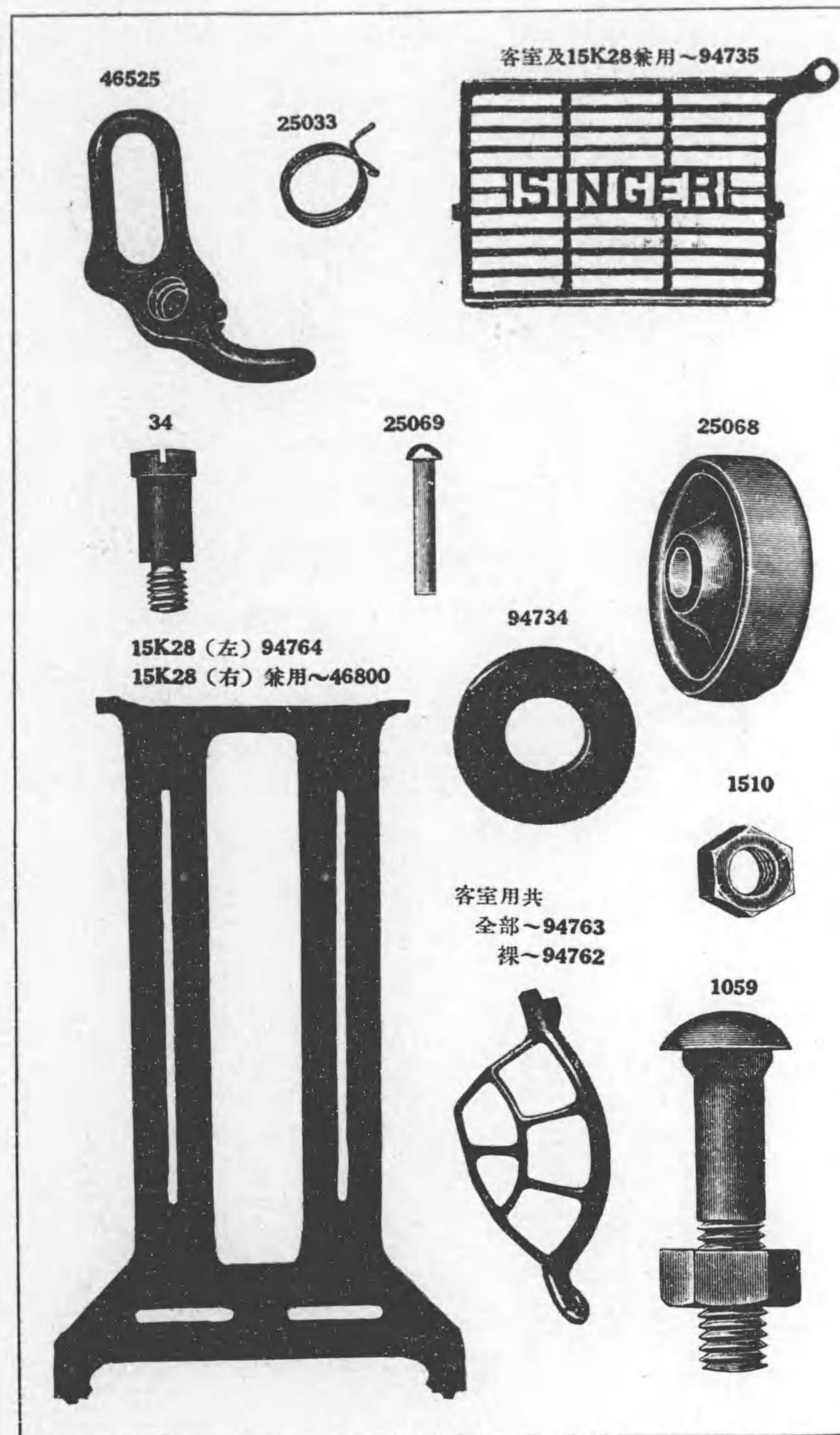
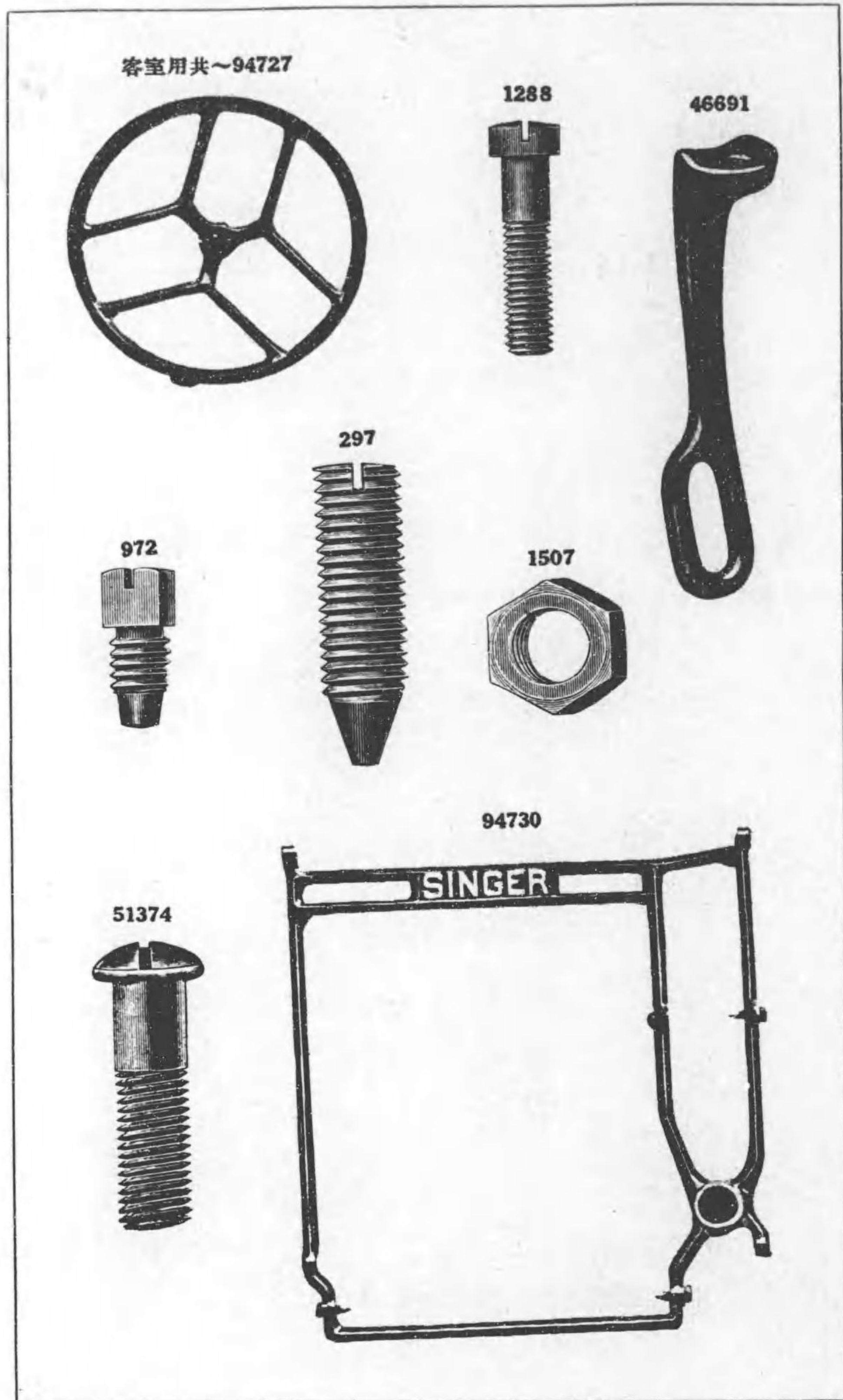

第一百二十二圖

15K28 (121圖參照)
Stands 脚部

PLATE 122

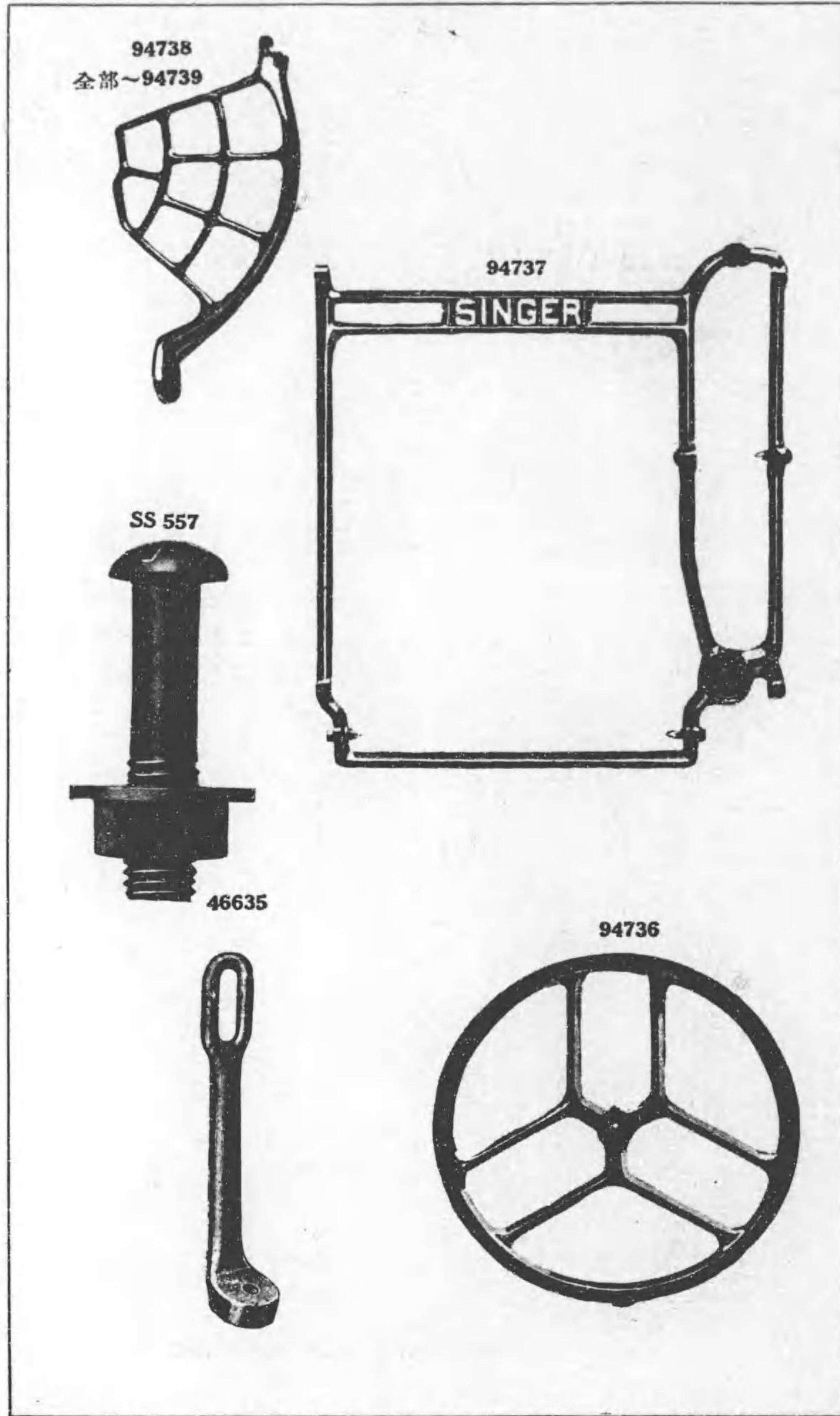
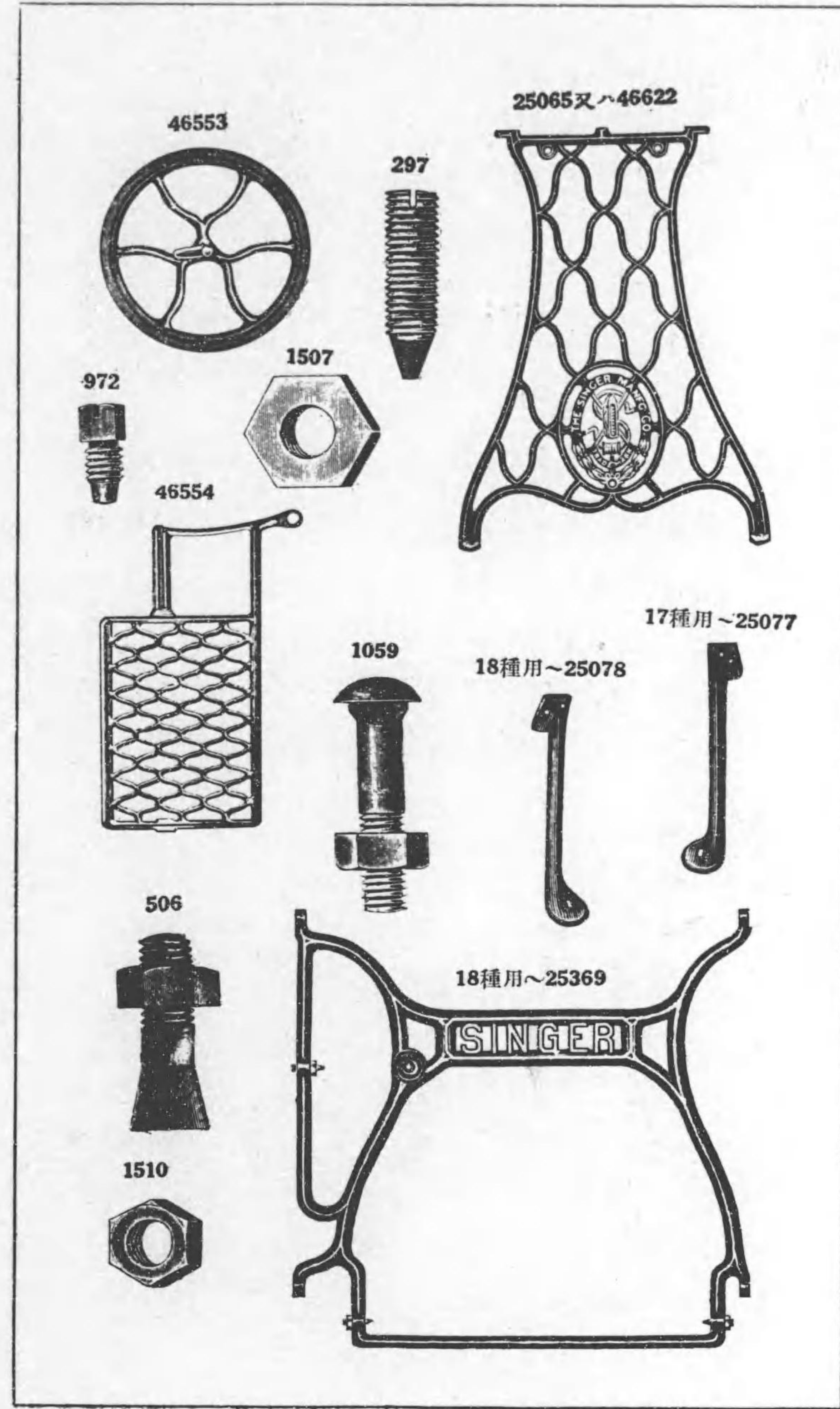

PLATE 123

17-1, 18-22
Stands 脚部

第一百二十三圖



第二百二十四圖

17-1, 18-22
Stands 脚部

PLATE 124

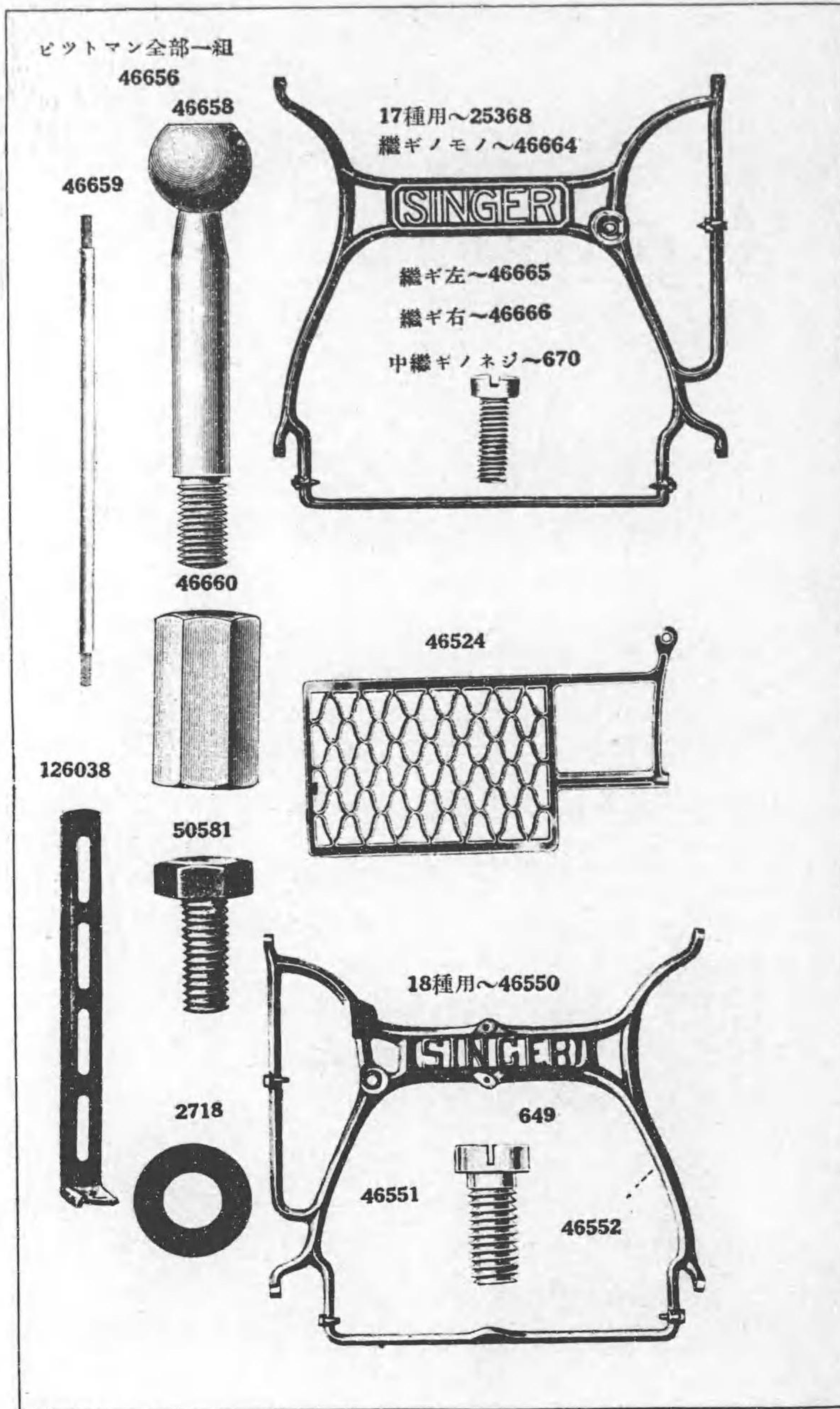
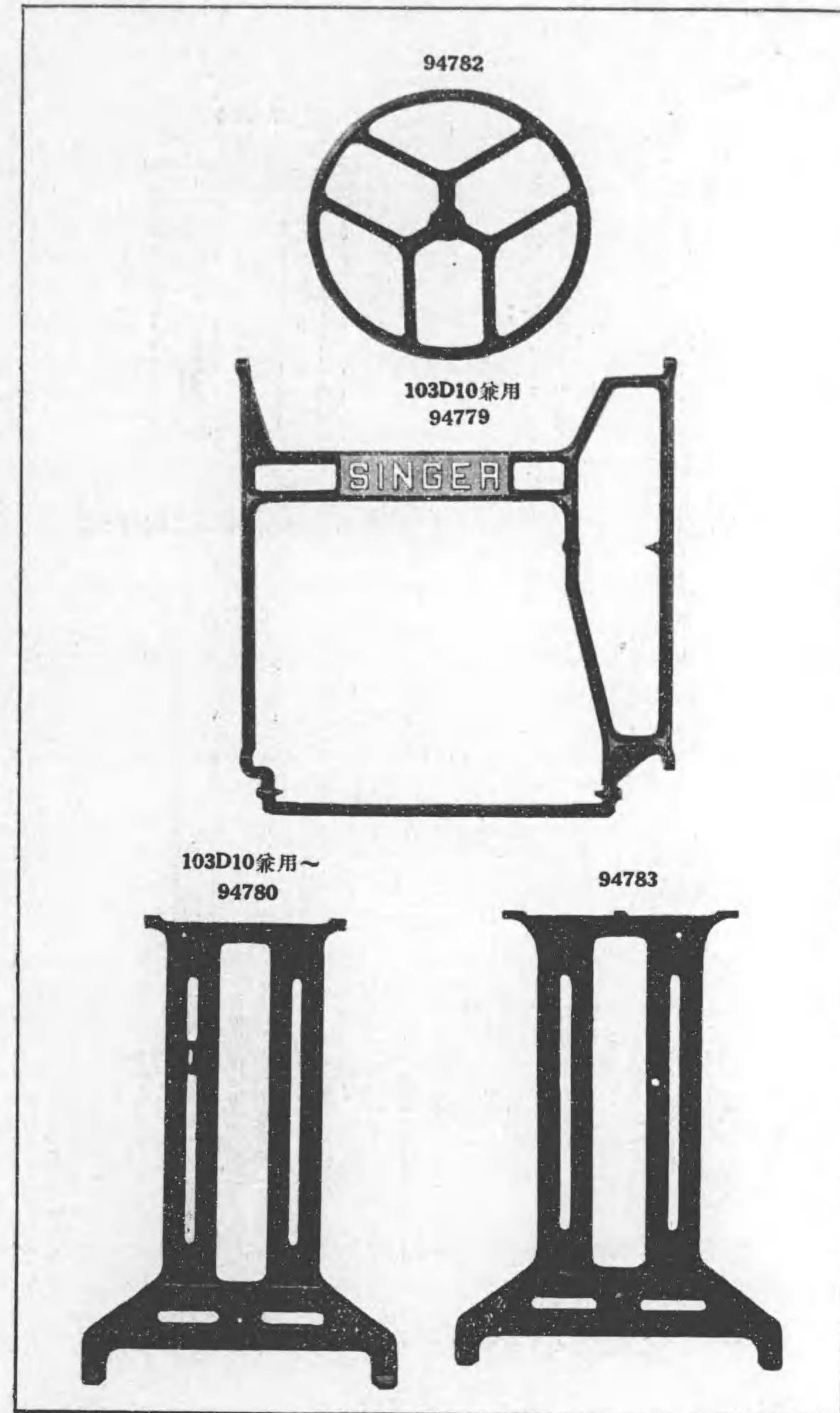

PLATE 125

16K, 31K, 32, 44K
Stands 脚部

第二百二十五圖



第二百二十六圖

29K58, 29K60
Stands 脚部

PLATE 126

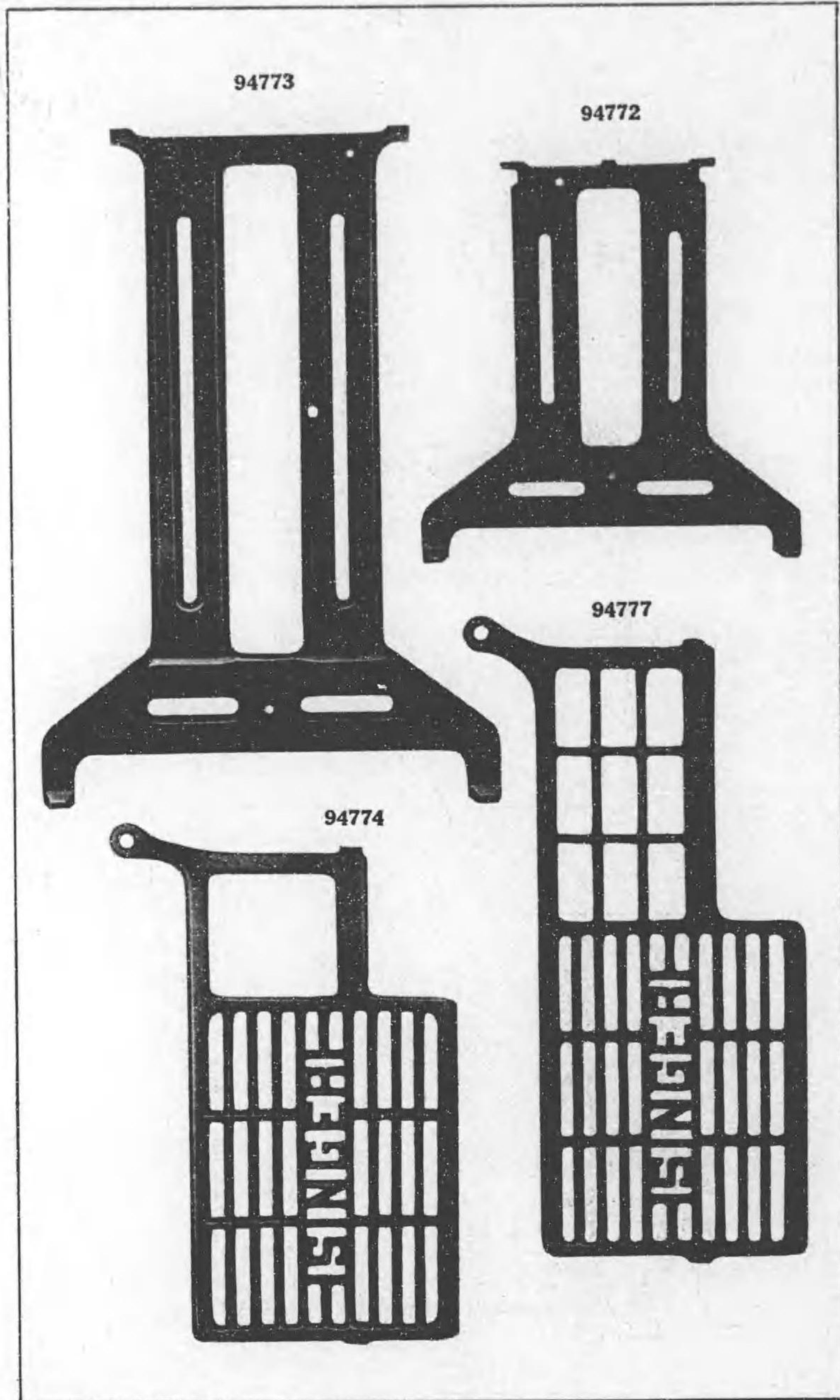
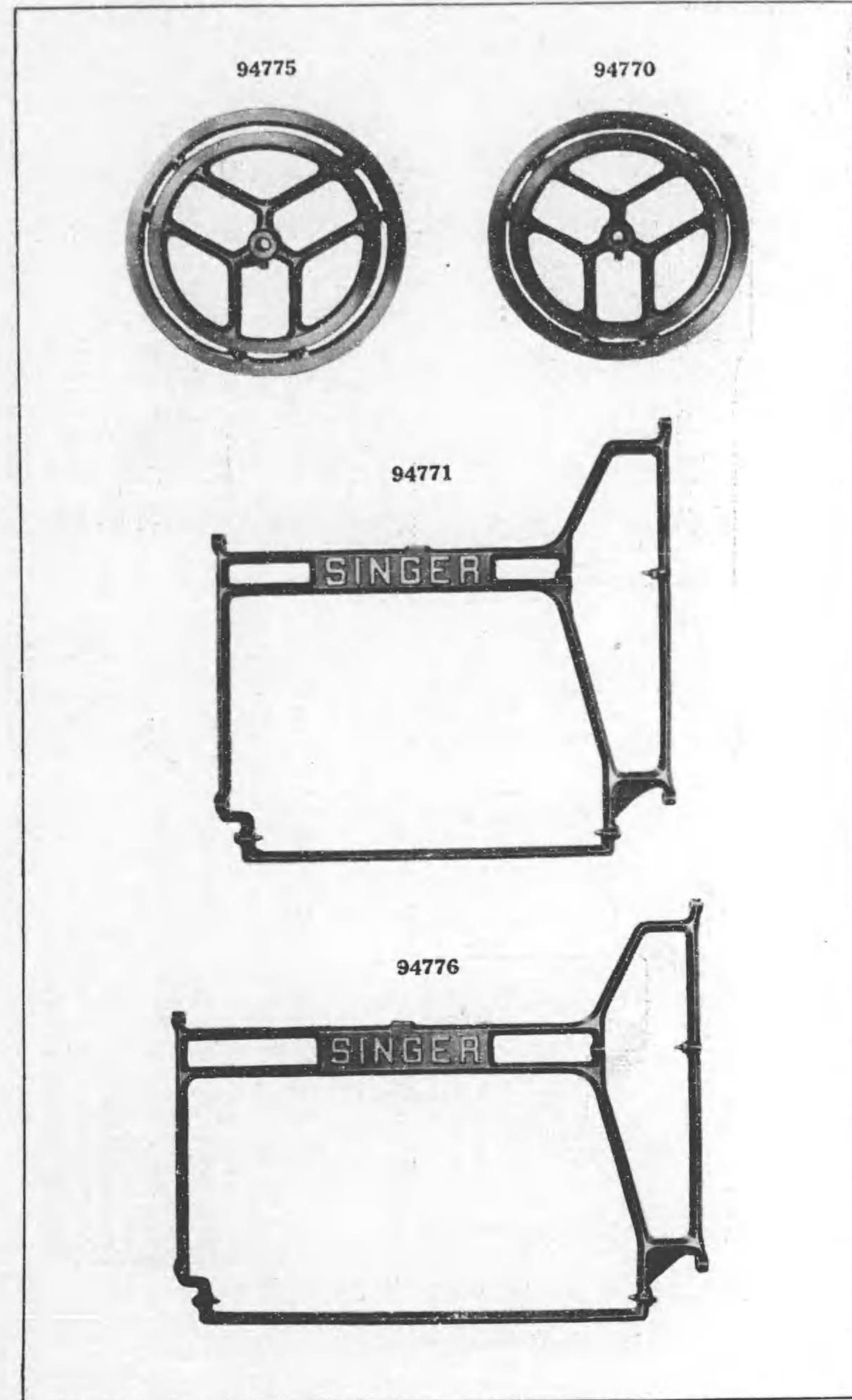

PLATE 127

29K58, 29K60
Stands 脚部

第二百二十七圖



第二百二十八圖

29K58, 29K60, 15K客室
Stands 脚部

PLATE 128

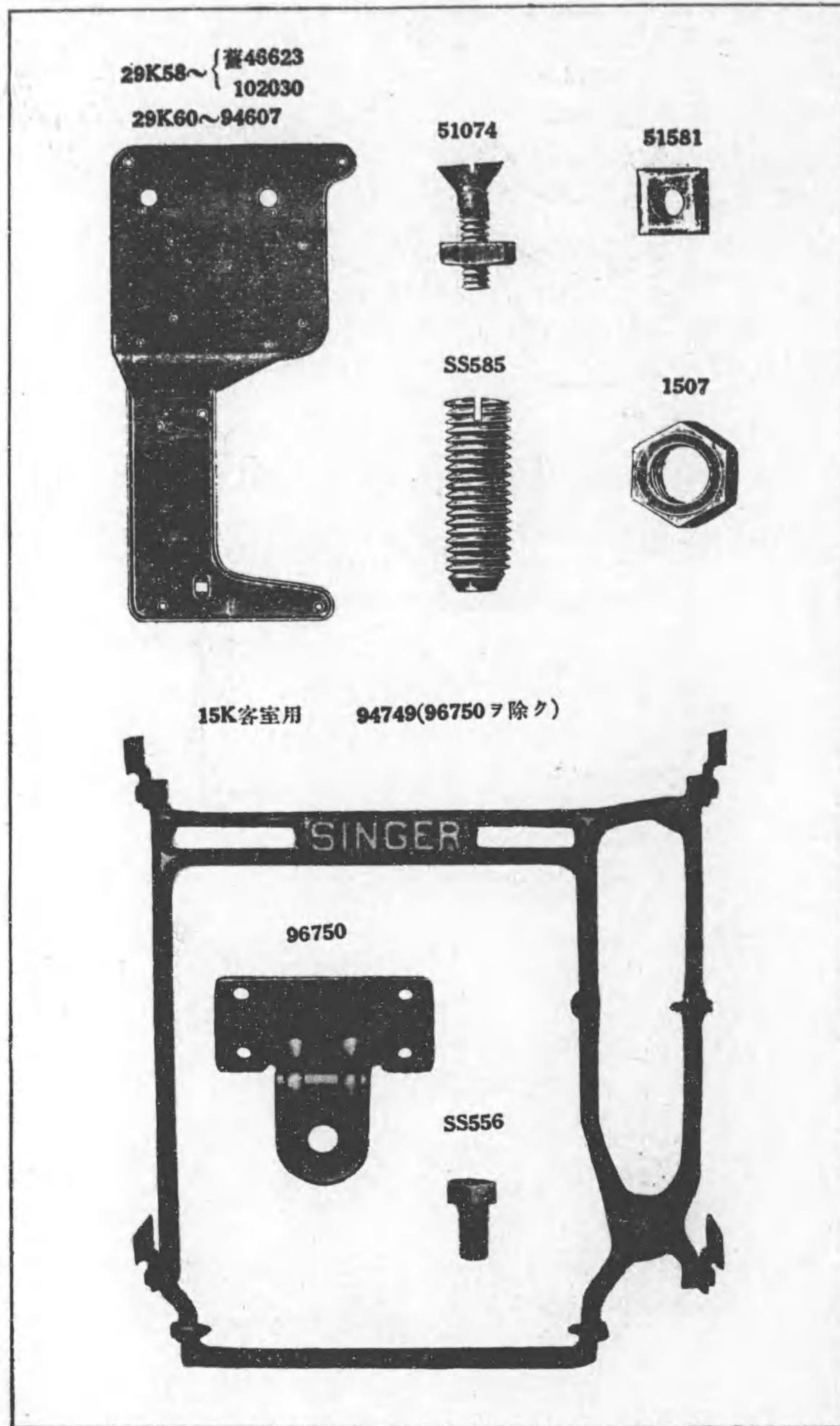

PLATE 129

103D10 (125圖参照)
Stands 脚部

第二百二十九圖

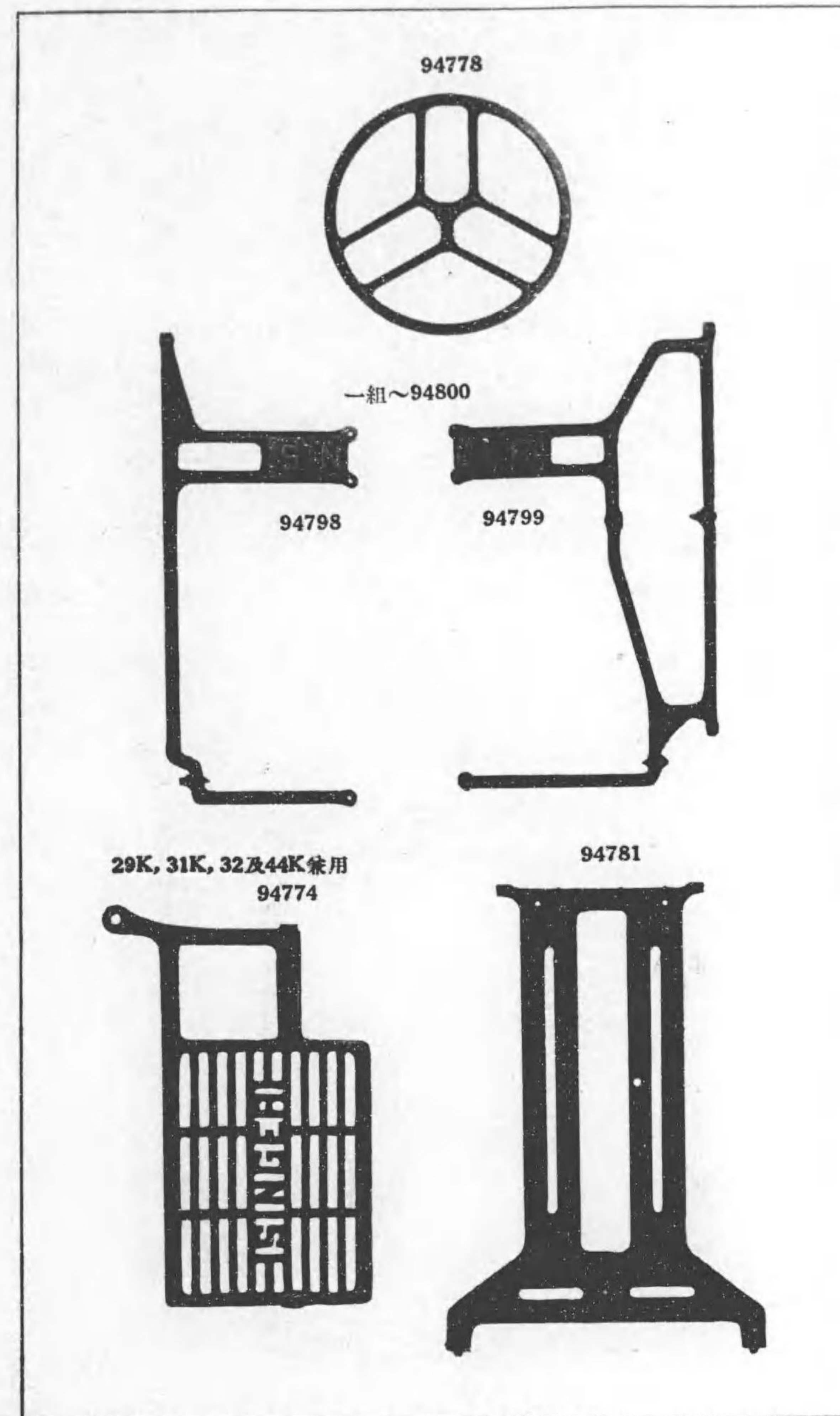

ILLUSTRATION OF PARTS

CLASS

15K26, 15K70, 18-2, 27, 28,
29K51, 29K55, 31K22 66, 103K MACHINES, STANDS,
B. U. K. MOTOR AND 20 MACHINE



二	十	十	二	二	二	三	六	百	各	十	二
十	五	八	十	十	十	十	十	十	十	十	十
種	種	種	種	種	種	種	種	種	種	種	種
K	K	K	K	K	K	K	K	K	K	K	K
二	七	七	八	五	五	二	六	六	十	十	十
十	十	十	十	十	十	十	十	十	十	十	十
六	六	六	六	六	六	六	六	六	六	六	六
番	部	部	部	部	部	部	部	部	部	部	部
1	1	1	1	1	1	1	1	1	1	1	1

ミ
シ
ン
部
分
品
圖
解

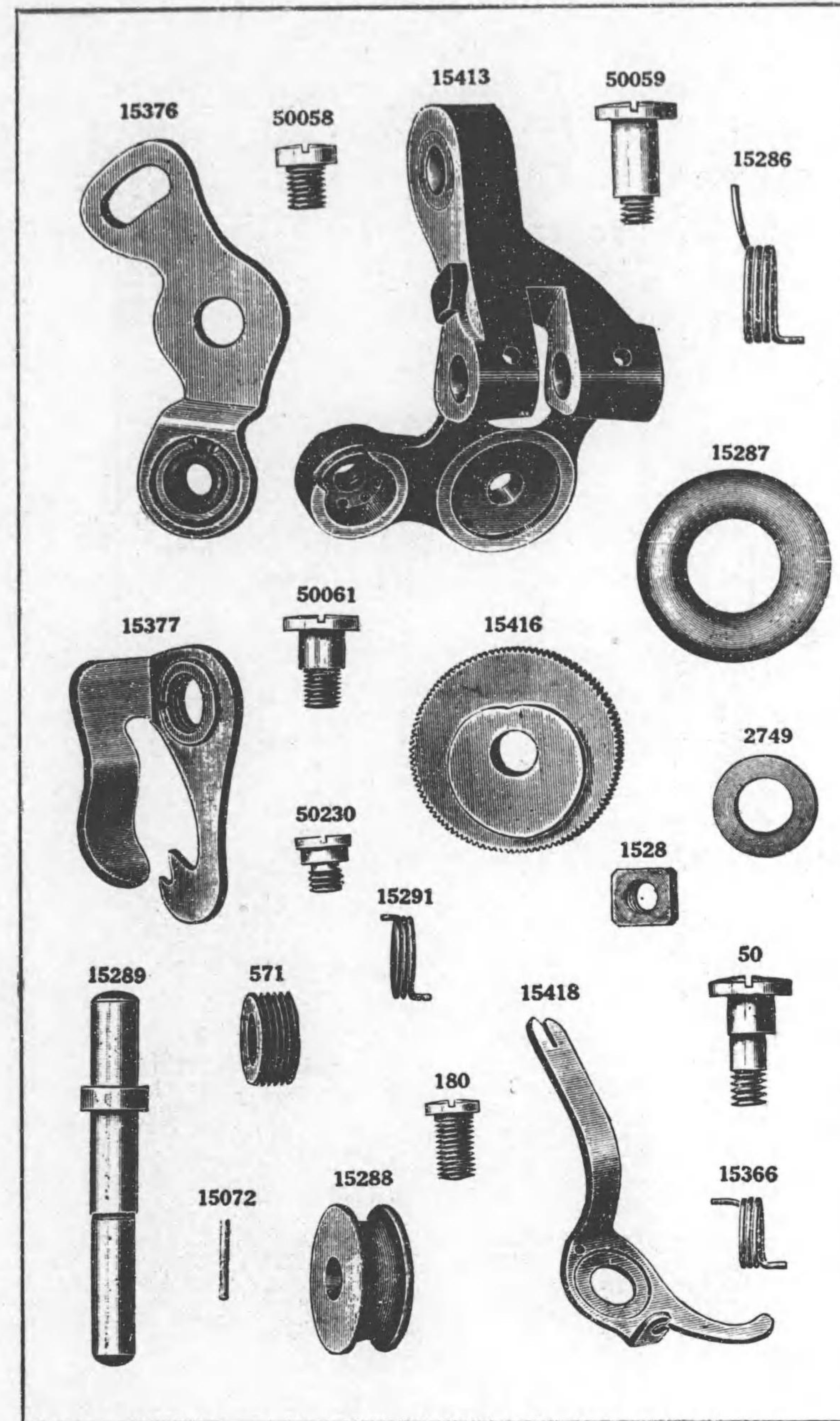
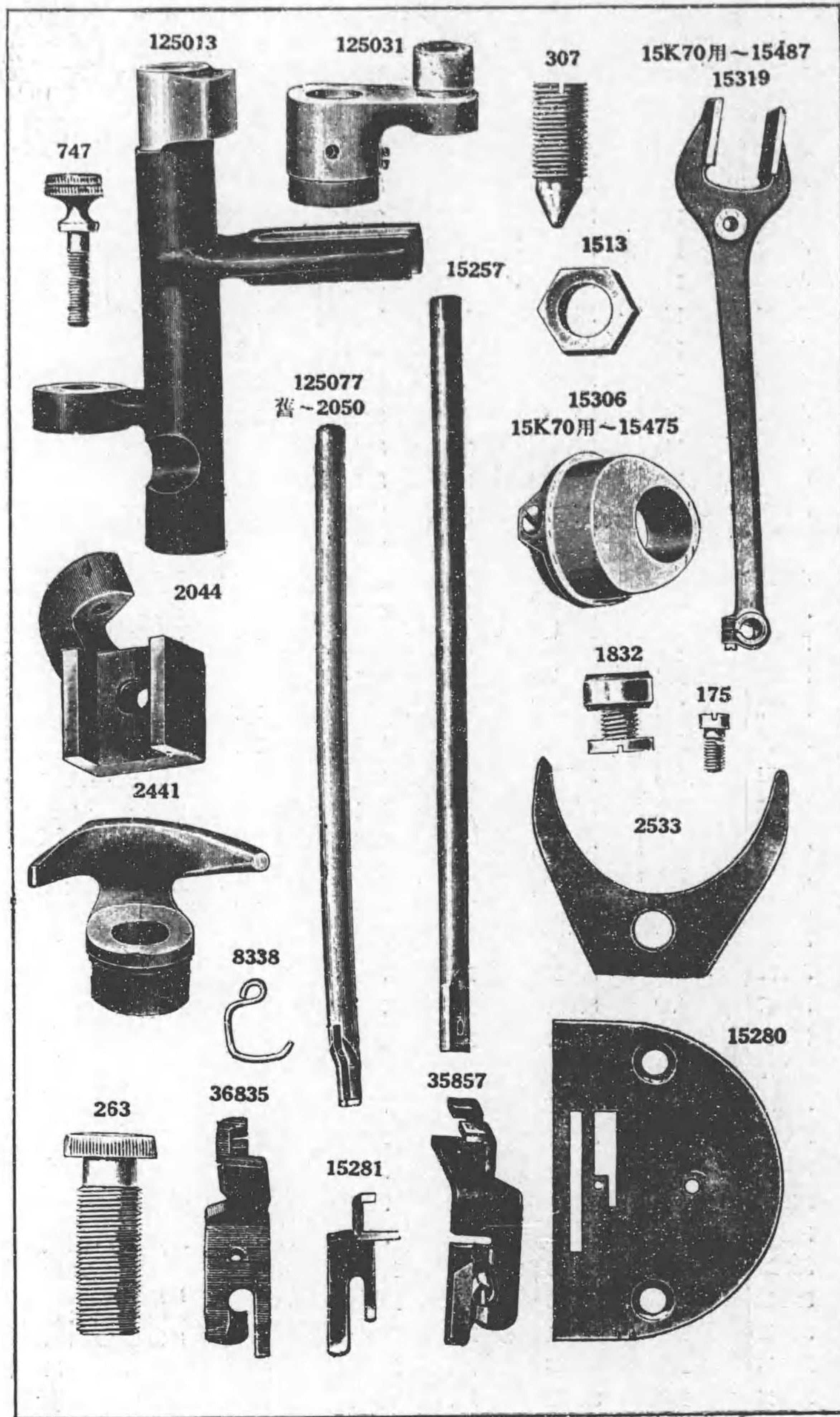

第三百二十二圖

15K26, 15K27, 15K70
15K71, 15K72

PLATE 132

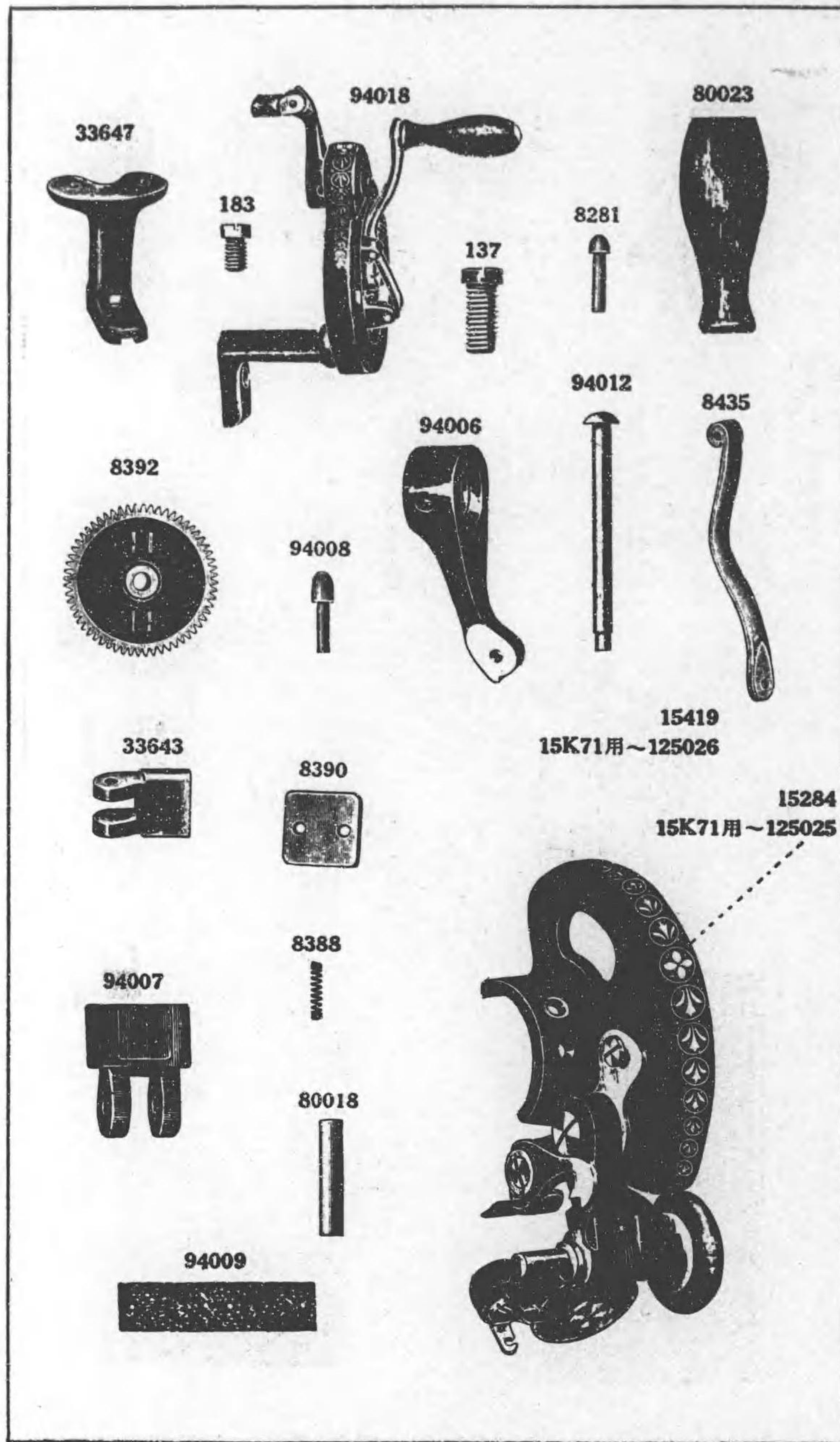
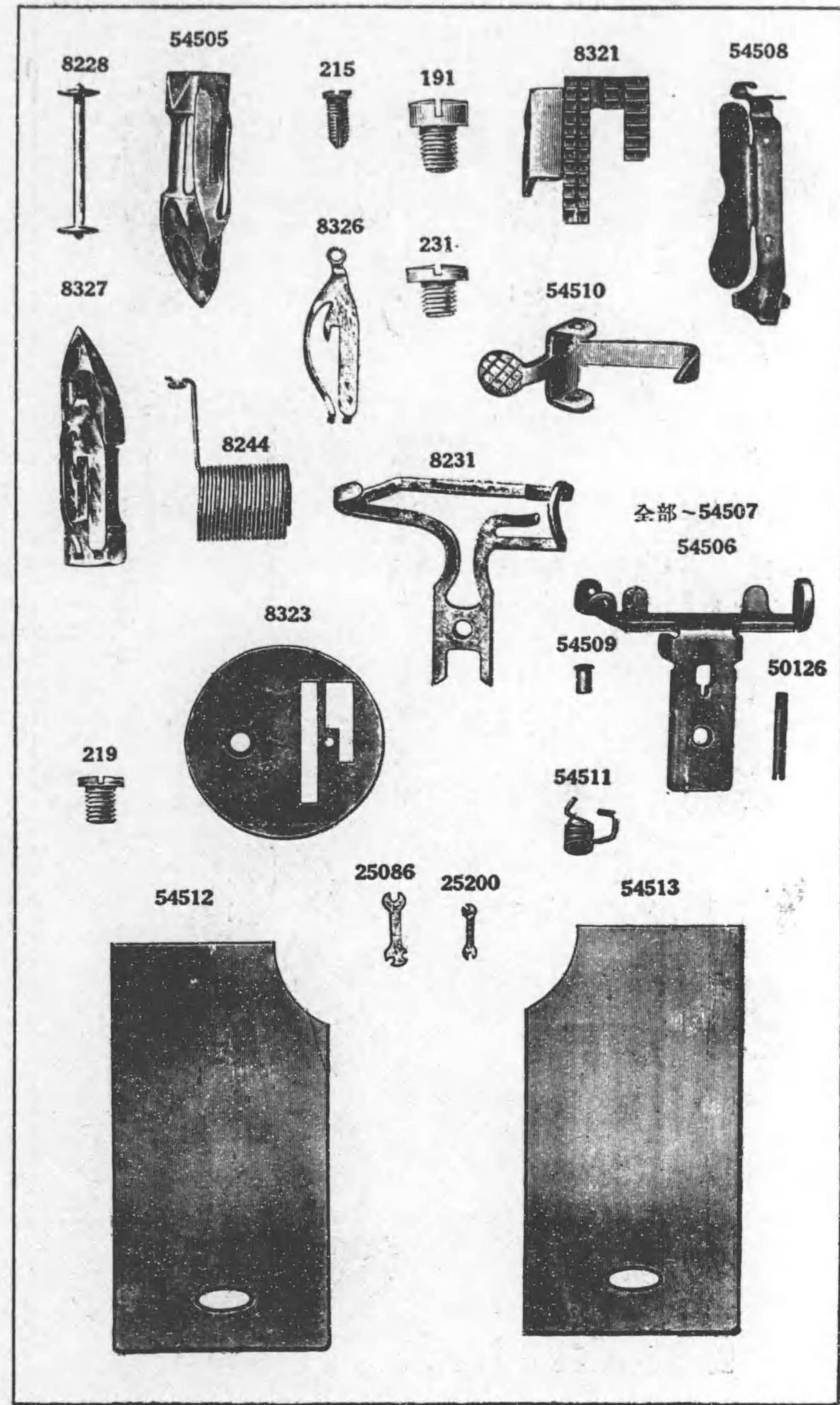
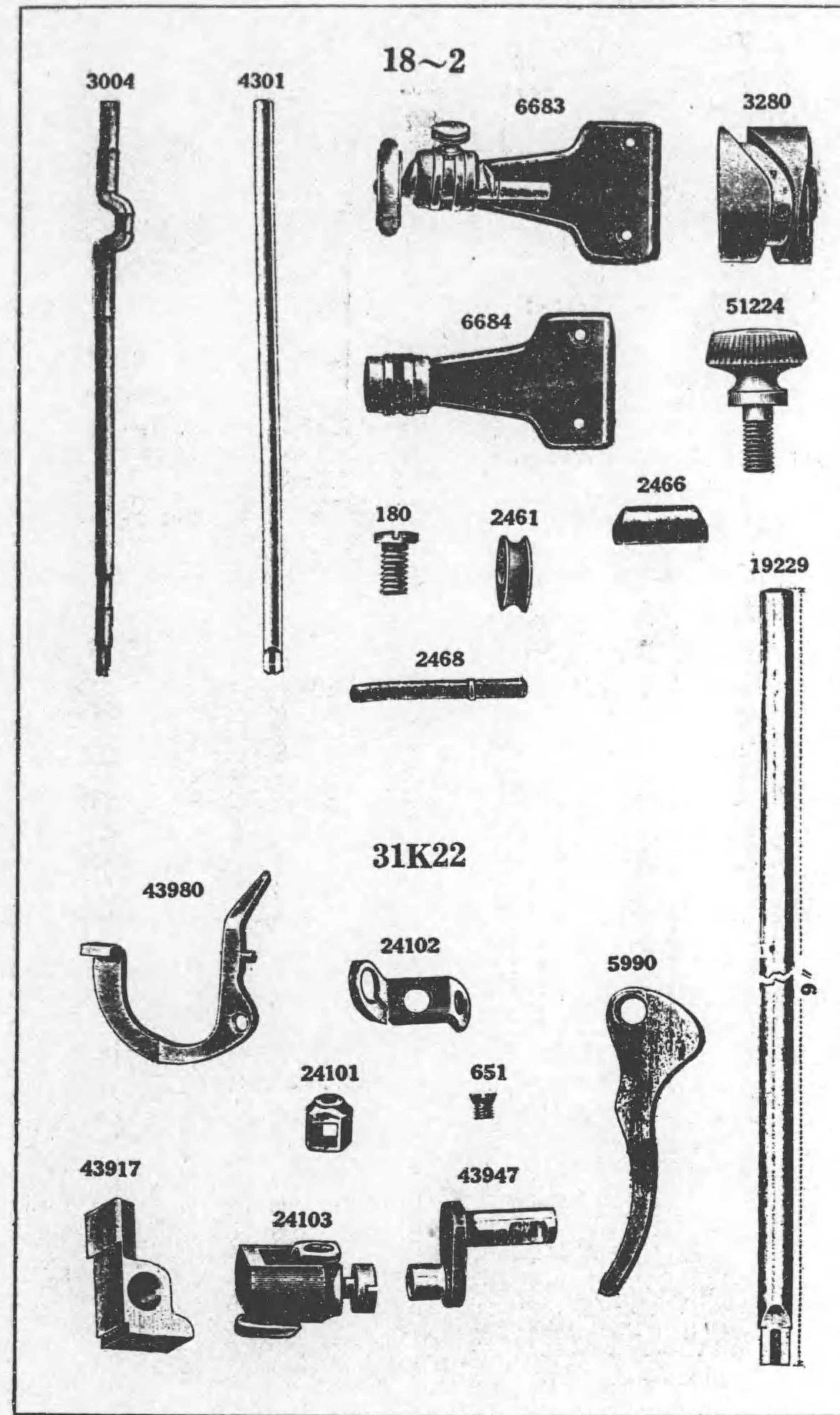
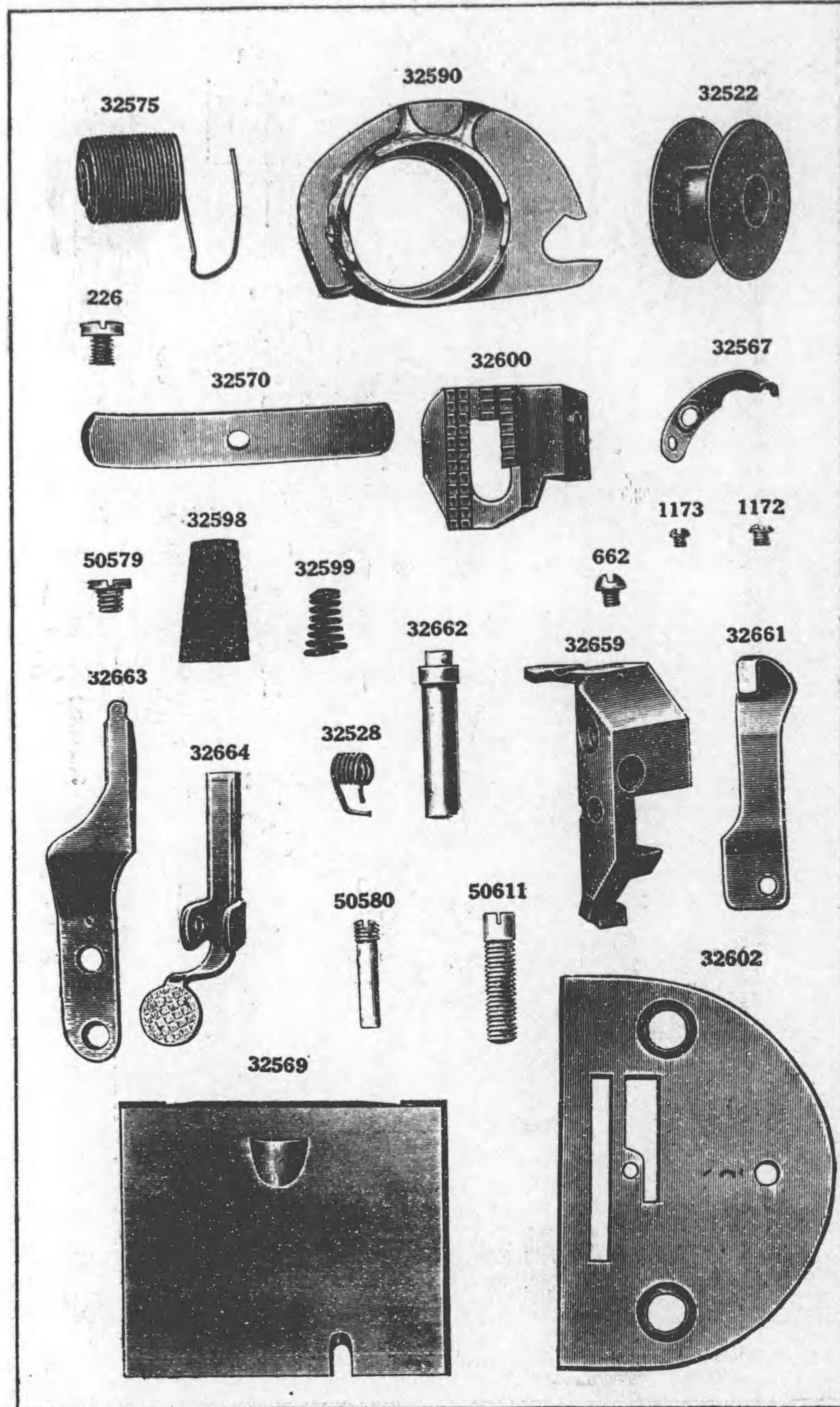

PLATE 133

27, 28

第三百二十三圖





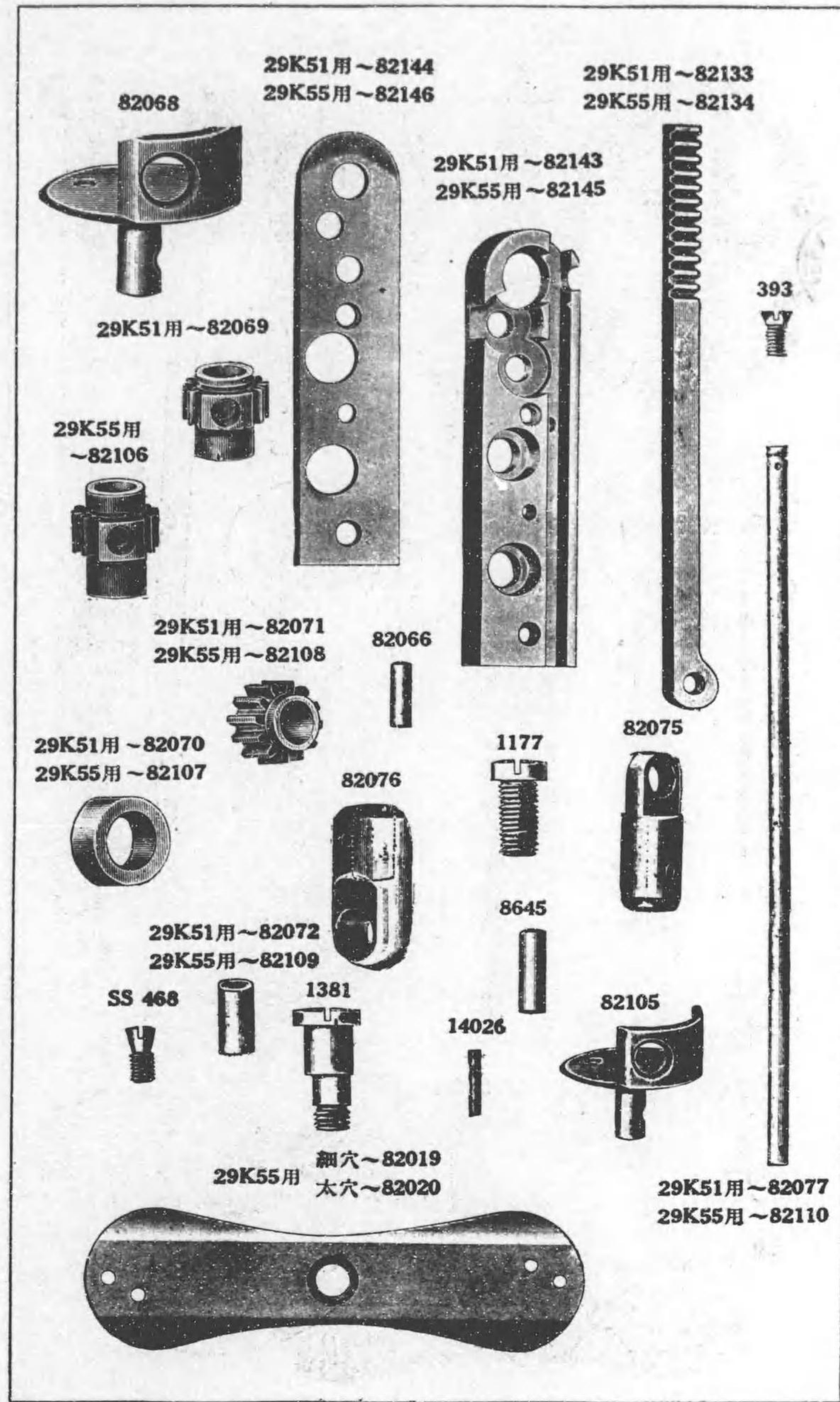
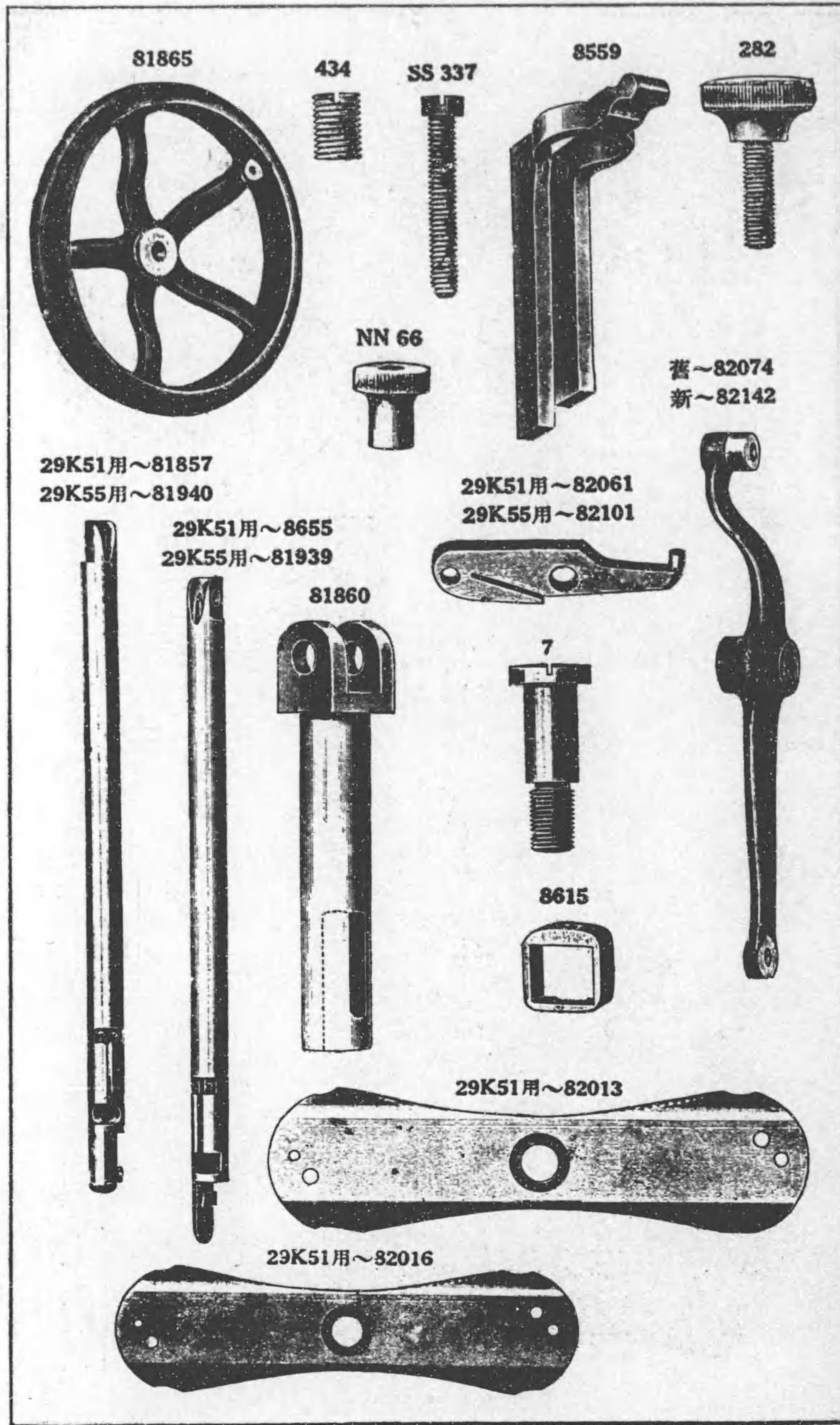

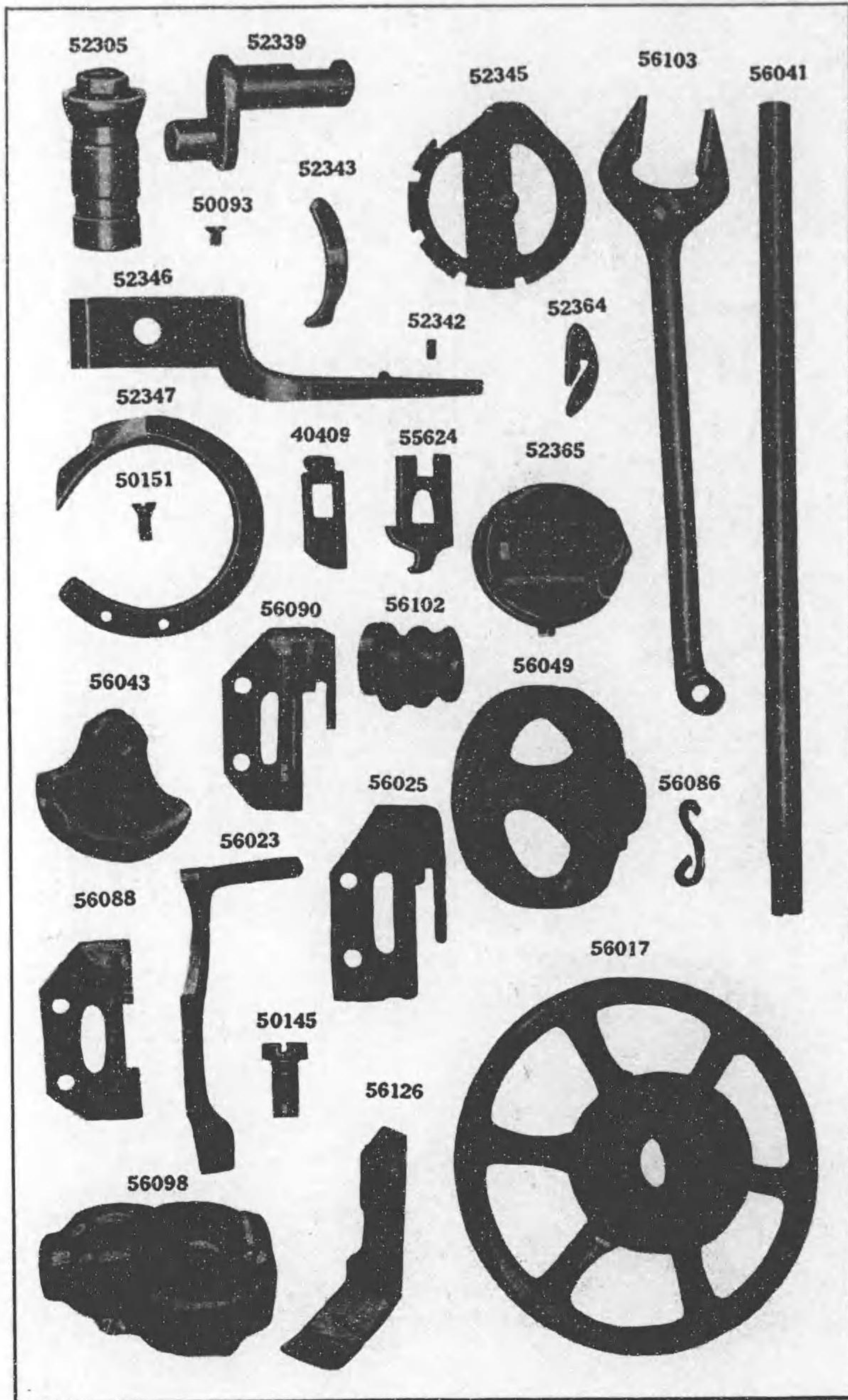

第一百四十圖

15K 舊式
Stands 脚部

PLATE 140

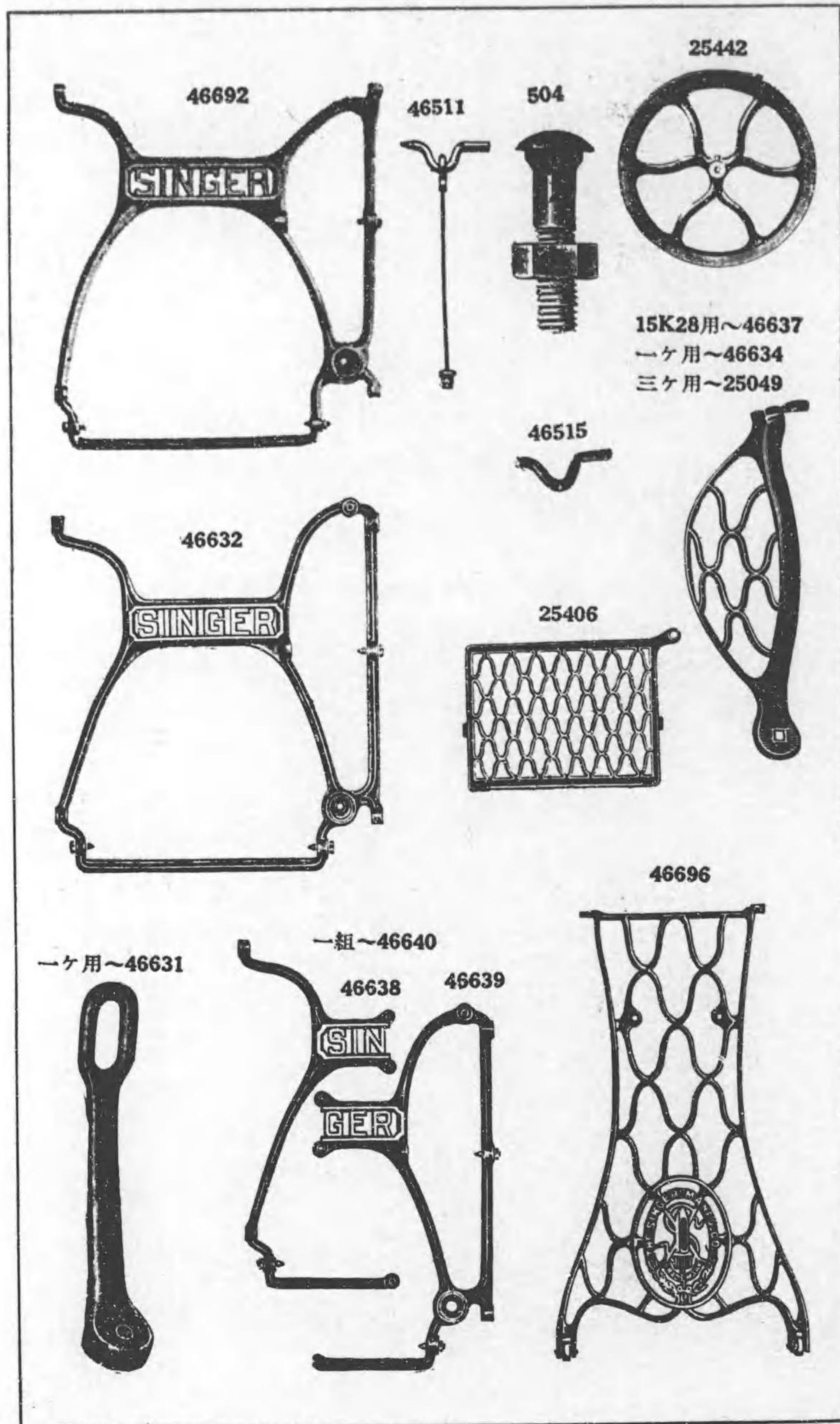

PLATE 141

15K28, 31K, 32K, 103K
舊式 Stands 脚部

第一百四十一圖

