



A TEXT-BOOK
OF
MYCOLOGY AND PLANT
PATHOLOGY

HARSHBERGER

A TEXT-BOOK
OF
MYCOLOGY AND PLANT
PATHOLOGY

BY

JOHN W. HARSHBERGER, PH.D.

PROFESSOR OF BOTANY, UNIVERSITY OF PENNSYLVANIA; MEMBER OF
THE BOTANICAL SOCIETY OF AMERICA; VICE-PRESIDENT OF THE
ECOLOGICAL SOCIETY OF AMERICA, ETC.

WITH 271 ILLUSTRATIONS

PHILADELPHIA
P. BLAKISTON'S SON & CO.
1012 WALNUT STREET

SB731
.H3

COPYRIGHT, 1917, BY P. BLAKISTON'S SON & CO.

433
AUG 20 1917

THE MAPLE PRESS YORK PA

©CLA470708
7 10 12

PREFACE

This book is the outcome of twenty-seven years' experience, as a teacher of botany, during which fifteen years have been given to a graduate course on the morphology, classification and physiology of the fungi, and five years to a course which combined with this consideration a parallel study of the most important cultural and inoculation methods used by the practical bacteriologist and mycologist at the present day. The English and Germans have led in the production of text-books on mycology and pathology; Berkeley, Smith, Cooke and Masee in England, Frank, Sorauer, von Tubeuf and Küster in Germany. Americans have been behind in this important field, notwithstanding, that American plants harbor some of the most destructive fungi, which, through our careless methods of agriculture and horticulture up to the present, are annually destructive to the extent of millions of dollars. This lack is being rapidly remedied and the appearance of text-books by Duggar, Stevens, Hall and Stevens, Mel T. Cook and general monographs by Erwin T. Smith, and others, augurs well for the future of this line of literary and scientific labor. The bacteriologists have led and mycologists should follow.

The following pages represent in a much extended form the lectures and laboratory exercises given by the author before his botanic classes at the University of Pennsylvania, and before public audiences elsewhere, especially, Farmers' Institutes with which he has had three years' experience as a lecturer in Pennsylvania. The arrangement of the text has been suggested by the needs of the classroom and from an acquaintance with similar work in other colleges and universities in America. It is hoped that the book and the suggestions, as to teaching which it contains, will appeal to those responsible for similar courses. The keys are given with the anticipation that they will prove useful to the student and teacher who desire exercises in the classification of the fungi: The illustrations have been chosen with care, and credit is given in all cases for those borrowed from other books and monographs. The author hopes that the book is reasonably free from misleading

statements, and that it will prove useful to the teaching and student body. The exercises, which are given in detailed form are designed to acquaint the student with the methods that are used in the cultural investigation of the bacteria and fungi. It is also designed to introduce the student to the highly important subject of Technical Mycology.

The modern demands for investigators trained in technical mycology are many. The health bureaus of our large cities need men and women, who can make a study of the milk, water and food supplies. The men, who are engaged in the fermentation industries, frequently demand expert information on the bacterial and fungal organisms, that are either useful, or harmful, in the fermentation process. The bread baker should have someone to whom questions relative to his, one of the oldest, arts could be referred. The canner also needs such expert advice. The farmer depends upon the fertility of his soil for the growth of crops, and the character of that fertility determines whether his crop shall be a large or a small one. It is conceded on all sides at present that fertility is due not alone to the chemical character of the soil, but also to other conditions which are quite as influential, such as, the physical state, the bacterial and fungous flora and the presence or absence of toxic substances. A study of the mycologic flora of the soil can only be pursued satisfactorily by those who have been trained in cultural methods.

Then too the study of plant diseases and animal diseases rests fundamentally upon technical mycologic laboratory methods. The alarming increase of plant diseases has attracted a larger and ever growing number of young men into the study of bacteriology and fungology. There seem to be unlimited opportunities for such carefully trained men and women to get profitable employment in health bureaus, manufacturing plants, agricultural experiment stations, and as plant doctors stationed in our larger towns and cities, ready, as a medical doctor is ready, to give for a monetary consideration expert advice and treatment. Lastly, there are chances for men and women trained in technical mycology to become professors, or teachers, of the subject in our colleges and agricultural high schools. Such trained specialists can help to increase the crop-producing capacity of our farms by eliminating the prevalent diseases, which reduce seriously the farmers' profits. Such specialists are conservationists in the truest sense of the term.

The author, with great pleasure, thanks the following persons for suggestive help in the preparation of the text-book: Professor J. C. Arthur read the proof of the chapter on the rust fungi; Prof. D. H. Bergey of the University of Pennsylvania the pages dealing with laboratory methods. Prof. Mel T. Cook and his associates J. C. Helyar and C. A. Schwarze of the New Jersey Agricultural Experiment Station, New Brunswick, read the galley proofs throughout and made valuable suggestions, Dr. J. S. Hepburn read the pages dealing with bio-chemistry. Messrs. H. R. Fulton and Donald Reddick also made valuable suggestions as to the arrangement of the contents of the book, while Prof. L. R. Jones and Dr. C. L. Shear furnished illustrations for reproduction in the text. Prof. A. H. Reginald Buller of the University of Manitoba gave permission to use five illustrations in his book, "Researches on Fungi." The author desires to express his thanks for the uniform courtesy of members of the firm of P. Blakiston's Son & Co., especially to Mr. C. V. Brownlow, whose unfailing interest has done so much to forward the publication of the work.

J. W. H.

CONTENTS

PART I. MYCOLOGY

	PAGE
CHAPTER I.—GENERAL STATEMENT AND CLASSIFICATION	1
CHAPTER II.—SLIME MOULDS (MYXOMYCETES)	7
CHAPTER III.—THE BACTERIA IN GENERAL.	21
Name; Size; Locomotion; Cell Division and Reproduction; Photogens; Chromogens; Thermogens; Aerobism and Anaerobism.	
CHAPTER IV.—CLASSIFICATION OF BACTERIA	28
According to Nutrition; Prototrophic Bacteria; Metatrophic Bacteria; Paratrophic Bacteria; Systematic Account of the Bacteria; Bibliography.	
CHAPTER V.—CHARACTERISTICS OF THE TRUE FUNGI	42
CHAPTER VI.—HISTOLOGY AND CHEMISTRY OF FUNGI	52
Histology; Cell Contents; Colors; Physiology; Enzymes; Classification of Enzymes in Fungi; Chemotaxis.	
CHAPTER VII.—GENERAL PHYSIOLOGY OF FUNGI	61
Influence of Light; Luminosity; Liberation of Spores.	
CHAPTER VIII.—ECOLOGY OF FUNGI	69
Saprophytes and Parasites; Sclerotia; Galls; Habitats; Xerophytism; Lichen Fungi.	
CHAPTER IX.—FOSSIL FUNGI AND GEOGRAPHIC DISTRIBUTION	82
Fossil Fungi; Geographic Distribution; Habitats of Lichens; Distribution of Chestnut Blight; Laboulbeniaceæ; Family Clathraceæ.	
CHAPTER X.—PHYLOGENY OF FUNGI	89
CHAPTER XI.—MOULD FUNGI	92
Order Zygomycetales; Sexual Reproduction; Spores and Sporangia; Fer- mentation; Key to Families of the Order Zygomycetales; Mucoraceæ; Mortierellaceæ; Choanephoraceæ; Chætocladiaceæ; Piptocephalidaceæ; Entomophthoraceæ; Bibliography.	
CHAPTER XII.—OOSPORE-PRODUCING ALGAL FUNGI	107
Sexual Reproduction; Haploid and Diploid State; Key to Families; Mono- blepharidaceæ; Saprolegniaceæ; Peronosporaceæ; Generic Key to Family Peronosporaceæ.	

	PAGE
CHAPTER XIII.—OOMYCETALES (CONTINUED)	116
Chytridiaceæ; Ancylistaceæ; Bibliography.	
CHAPTER XIV.—HIGHER FUNGI	120
Ascomycetales; Sexuality, Claussen and Harper; Life Cycle; Bibliography.	
CHAPTER XV.—SAC FUNGI IN PARTICULAR (YEASTS, ETC.)	131
Endomycetaceæ, Exoascaceæ; Saccharomycetaceæ; Yeasts, cells and fermentation, etc.; Systematic Position.	
CHAPTER XVI.—SAC FUNGI (CONTINUED).	143
Gymnoascaceæ; Aspergillaceæ; Elaphomycetaceæ; Terfeziaceæ; Tuberaceæ (Truffles); Myriangiaceæ.	
CHAPTER XVII.—MILDEWS AND RELATED FUNGI	154
Erysiphaceæ (Mildews); Perisporiaceæ; Microthyriaceæ; Hypocreaceæ; Dothideaceæ; Sordariaceæ; Chætomiaceæ; Sphæriaceæ; Valsaceæ; Melogrammataceæ; Xylariaceæ; Hysteriaceæ; Phacidiaceæ; Pyronemaceæ; Ascobolaceæ; Pezizaceæ; Helotiaceæ; Mollisiaceæ; Geoglossaceæ; Helvellaceæ; Cyttariaceæ; Rhizinaceæ; Phylogeny of Ascomycetales; General Bibliography.	
CHAPTER XVIII.—BASIDIA-BEARING FUNGI (SMUTS)	177
Key to Suborders; Ustilaginaceæ (Smuts); Bibliography of Smuts.	
CHAPTER XIX.—RUST FUNGI	187
General Structure; Forms; Life Cycles; Cytology; Phylogeny; Endophyllaceæ; Coleosporiaceæ; Pucciniaceæ; Bibliography of Rusts; Auriculariaceæ; Tremellaceæ (Trembling Fungi).	
CHAPTER XX.—FLESHY AND WOODY FUNGI	218
Cytology; Dacryomycetaceæ; Exobasidiaceæ; Hypochnaceæ; Thelephoraceæ; Clavariaceæ; Hydnameæ; Polyporaceæ; Manuals.	
CHAPTER XXI.—MUSHROOMS AND TOADSTOOLS	231
Agaricaceæ; Development of Fruit Bodies; Cultivation of Mushrooms; Chemistry and Toxicology of Mushrooms; Gasteromycetes; Hymenogastraceæ; Tylostomaceæ; Lycoperdaceæ; Nidulariaceæ; Key to; Sclerodermaceæ; Sphærobolaceæ; Phallomycetes; Development of Carrion Fungi; Clathraceæ; Phallaceæ; Bibliography of Eubasidii.	
CHAPTER XXII.—FUNGI IMPERFECTI (DEUTEROMYCETES).	258
General Characters; Systematic Position; Sphærospidales; Melanconiales; Hyphomycetales.	

PART II. GENERAL PLANT PATHOLOGY

CHAPTER XXIII.—GENERAL CONSIDERATION OF PLANT DISEASES	271
Etiology; Predisposing Causes; Determining Causes; Physical Character of Soil; Climatic and Meteorologic Factors, Effect of Smoke, etc.; Traumatism; Animate Agents of Disease; Insects.	

	PAGE
CHAPTER XXIV.—PLANTS AS DISEASE PRODUCERS, EPIPHYTOTISM, PROPHYLAXIS	298
Vegetal Agents of Disease; Parasitic Flowering Plants; Fungous Organisms as the Cause of Disease; Mechanic Injuries; Injuries Due to Meteorologic Causes; Infection; Incubation; Duration of Disease; Dissemination of Fungi; Epiphytotisms (Epidemics); Prophylaxis.	
CHAPTER XXV.—PRACTICAL TREE SURGERY	319
Preventive Measures; Character of Work; Cavity Treatment; Mixing and Placing the Cement; Metal-covered Cavities; Guying.	
CHAPTER XXVI.—INTERNAL CAUSES OF DISEASE	326
Enzymes; Panaschiering; Calico; Nutritive Disturbances; Mutations; Malformations and Monstrosities; Graft Hybrids; Chimæras.	
CHAPTER XXVII.—CLASSIFICATION OF ABNORMALITIES.	331
CHAPTER XXVIII.—SYMPTOMS OF DISEASE (SYMPTOMATOLOGY).	341
Symptoms of Disease; Discolorations; Shot-holes; Wilting; Necrosis, Dwarfing; Hypertrophy; Replacement; Mummification; Alteration of Position; Destruction of Organs; Excrescences and Malformations; Exudations; Rotting; Bibliography of Diseases in General.	
CHAPTER XXIX.—PATHOLOGIC PLANT ANATOMY	354
Restitution; Hypoplasia; Metaplasia.	
CHAPTER XXX.—PATHOLOGIC PLANT ANATOMY (CONTINUED).	364
Hypertrophy; Excrescences; Intumescences; Callous Hypertrophy; Tyloses; Gall Hypertrophies; Hyperplasia; Homoplasia; Heteroplasia; Callus; Conditions of Callous Formation; Wound Wood; Wound Cork.	
CHAPTER XXI.—GALLS	384
Kinds of Galls; Cataplasms; Histology of Cataplasms; Histology of Galls; Cecidial Tissue Forms; Bibliography of Galls.	
CHAPTER XXXII.—MECHANIC DEVELOPMENT OF PATHOLOGIC TISSUES	463
General Consideration; Bibliography of Developmental Mechanic, Suggestions to Teachers and Students.	

PART III. SPECIAL PLANT PATHOLOGY

CHAPTER XXXIII.—SPECIFIC DISEASES OF PLANTS.	411
General Statement; Principal Publications; List of Common and Important Diseases of Economic Plants in the United States and Canada Arranged according to Host Plants.	
CHAPTER XXXIV.—DETAILED ACCOUNT OF SPECIFIC DISEASES OF PLANTS.	475
Alfalfa to Grape.	
CHAPTER XXXV.—DETAILED ACCOUNT OF SPECIFIC PLANT DISEASES (CONTINUED).	517
Hemlock to Wheat.	

	PAGE
CHAPTER XXXVI.—NON-PARASITIC, OR PHYSIOLOGIC PLANT DISEASES.	564
Classification; Stag-head; Root Asphyxiation; Desiccation; Water-logging; Œdema; Frost Necrosis; Apple Fruit Spots; Water-core of Apple; Die-back, or Exanthema; Mottle-leaf; Curly-top of Sugar Beets; Peach Yellows; Tip-burn of Potato; Leaf-casting; Curly-dwarf of Potato; Bean Mosaic; Mosaic of Tobacco; Bibliography.	
PART IV. LABORATORY EXERCISES IN THE CULTURAL STUDY OF FUNGI	
CHAPTER XXXVII.—LABORATORY AND TEACHING METHODS	581
Introductory Remarks; Lesson 1, Micrometry; Lesson 2, Plugging Test-tubes, etc.; Lesson 3, Microscopic Study of Culture Material; Stains; Lesson 4, Liquid Nutrient Solutions; Lesson 5, Potatoes as Medium; Lesson 6, Solid Vegetable Substances; Lesson 7, Plant Juices; Lesson 8, Milk, Beer-wort; Lesson 9, Bouillon; Lesson 10, Eggs; Lesson 11, Nutrient Gelatin; Lesson 12, Agar-Agar; Lesson 13, Various Nutrient Agars; Lesson 14, General Directions for Making Plant Agars; Lesson 15, Potato Juice Agar; Lesson 16, Starch Agar; Lesson 17, Culture Media for Nitric Organisms; Lesson 18, Standardization of Culture Media; Lesson 19, Germination Studies; Lesson 20, Counting of Yeasts and Bacteria; Lesson 21, Cultivation of Yeasts on Gypsum Blocks, Method of Pouring Plates, Streak Method; Lesson 22, Isolation of Fungi; Lesson 23, Water Analysis; Lesson 24, Methods of Identification; Lesson 25, Plate Counter; Lesson 26, Systematic Bacteriology; Lesson 27; Scheme for the Study of Bacteria; Lesson 28, Detailed Study of Bacteria; Lesson 29, Directions for the Study of Pathogenic Fungi.	
CHAPTER XXXVIII.—LABORATORY AND TEACHING METHODS (CONTINUED)	643
Lesson 30, Inoculation Experiments; Lesson 31, Do.; Lesson 32, Do.; Lesson 33, Do.; Lesson 34, Do.; Lesson 35, Experiments with Artificial Wounding of Plants; Lesson 36, Gas Injuries; Lesson 37, Enzyme Diseases; Lesson 38, Study of Mistletoe; Lesson 39, Wire Worms in Plants; Lesson 40, Relation of Light to Pathogenic Conditions; Lesson 41, Withering, or Wilt-ing of Plants; Lesson 42, Methods of Sectioning, Celloidin, Paraffin; Lesson 43, Freezing and Cutting of Material; Lesson 44, Use of Drawing and Projection Apparatus, Drawing Methods; Lesson 45, Suggestions to Teachers and Students; Lesson 46, Content of Field Trips and Excursions.	
APPENDIX I.—FUNGICIDES.	669
Bordeaux Mixture, etc.	
APPENDIX II.—SPRAY CALENDAR	680
APPENDIX III.—ANTISEPSIS AND DISINFECTION	692
Preservation of Woods.	

	PAGE
APPENDIX IV.—CULTURE OF MUSHROOMS	693
APPENDIX V.—SYNOPSIS OF FAMILIES AND PRINCIPAL GENERA OF MYXO- GASTRALES	693
APPENDIX VI.—KEY FOR THE DETERMINATION OF SPECIES OF MUCOR	695
APPENDIX VII.—KEYS FOR THE DETERMINATION OF SPECIES OF ASPER- GILLUS AND PENICILLIUM	702
APPENDIX VIII.—KEYS TO THE GENERA OF THE ERYSIHACEÆ	721
APPENDIX IX.—COLLECTION AND PRESERVATION OF FLESHY FUNGI	726
APPENDIX X.—LIST OF KEYS TO FLESHY FUNGI AND SELECTED KEYS OF FLESHY FUNGI	729
APPENDIX XI.—KEY TO AGARICACEÆ	732
INDEX	753

PART I

MYCOLOGY

CHAPTER I

GENERAL STATEMENT AND CLASSIFICATION

The lower plant organisms which concern the mycologist, or the student of the fungi, may be considered in a general sense, or in a narrow way. A general definition would include all those thallophytes, or lower cellular plants (lacking archeogonia), which are destitute of chlorophyll and in its absence become dependent, with the exception of the prototrophic bacteria, upon extraneous supplies of organic food, either living or dead. This broad definition compels the mycologist to study the slime moulds, the bacteria and the true fungi, both as to their morphology and their physiology. He finds on such study, that broadly speaking, there are similarities of structure and function in both groups of dependent plants, in fact, he finds that the function of these plants is connected with cell organization and structure and *vice versa*. With this clearly in view, the mycologist finds that he has to deal with three distinct classes of chlorophyllless plants, namely:

CLASS MYXOMYCETES (slime moulds).

CLASS SCHIZOMYCETES (bacteria).

CLASS EUMYCETES (true fungi).

The classification of these colorless (chlorophyllless) lower plants has been elaborated in recent years with considerable detail by various authors, so that the broad fundamental facts both of taxonomy and phylogeny are known fairly well, but much remains to be done along the classificatory lines, especially, since the life histories of many of the bacteria and fungi are incompletely known. It may be many years before a generally acceptable nomenclature and classification will be an accomplished fact. The choice of a classification by any worker in mycology depends largely on his training and bias and on his detailed study of the various groups. No two men would entirely agree as to which was the best sequence to adopt in a systematic treatment of the different forms. The classification adopted in this

treatise is based on that of Engler and Gilg, as published in the seventh illustrated edition of "Syllabus der Pflanzenfamilien," Berlin, 1912, and on that of Wettstein in his "Handbuch der Systematischen Botanik," Leipzig and Vienna, 1911. Where consistent, the classificatory systems of these two books are harmonized and any departures which the student will find from the taxonomic arrangements of Engler and Wettstein have been made to simplify them by the omission of certain group names, or to bring the two systems into line with the facts as at present known. The author has not hesitated to make changes, where from his experience as a teacher, he has found it best to make such alterations, especially where, for example, Wettstein uses Ordnung and Engler Reihe for the same classificatory group, and where in American usage order and family are used. Then, too, the author has found it convenient to replace the name of a family, or order, as given by Engler for one used by Wettstein, or some other author, where such replacement is recommended by American usage, or where etymologically the name is more suggestive of the character of the group, and, therefore, best for the use of students who do not expect to follow out the intricacies of any system of classification. As the statements and views of Engler and Wettstein are generally dependable and as their classification is founded on long experience, as systematic botanists, it will be found that with respect to the larger subdivisions of the fungi their classifications are remarkably harmonious. The attempt has been made in the pages that follow to simplify for student use the facts of classificatory importance and while the groups are arranged in lineal sequence, it should be explained that true relationship is expressed better by a family tree with main trunk, larger and smaller branches. It will be noted that the arrangement of the families, as given in the two systematic works above mentioned, are sometimes reversed. The simple groups are given first place, followed by the more complex.

CLASS I. MYXOMYCETES.

ORDER I. ACRASIALES.

Family 1. Guttulinaceæ.

Family 2. Dictyosteliaceæ.

ORDER II. PHYTOMYXALES.

Family 1. Plasmodiophoraceæ.

ORDER III. MYXOGASTRALES.

SUBORDER. EXOSPOREÆ.

Family 1. Ceratiomyxaceæ.

SUBORDER. ENDOSPOREÆ.

Family 2. Physaraceæ.

Family 3. Didymiaceæ.

Family 4. Stemonitaceæ.

Family 5. Brefeldiaceæ.

Family 6. Cribrariaceæ.

Family 7. Liceaceæ.

Family 8. Tubiferaceæ.

Family 9. Reticulariaceæ.

Family 10. Trichiaceæ.

CLASS II. SCHIZOMYCETES.

ORDER I. EUBACTERIALES.

Family 1. Coccaceæ.

Family 2. Bacteriaceæ.

Family 3. Spirillaceæ.

Family 4. Phycobacteriaceæ (Chlamydobacteriaceæ).

Family 5. Thiobacteriaceæ (Beggiatoaceæ).

Family 6. Actinomycetaceæ (position doubtful).

ORDER II. MYXOBACTERIALES.

Family 1. Myxobacteriaceæ.

CLASS III. EUMYCETES.

SUBCLASS. PHYCOMYCETES.

ORDER I. ZYGOMYCETALES.

Family 1. Mucoraceæ.

Family 2. Mortierellaceæ.

Family 3. Choanephoraceæ.

Family 4. Chætocladiaceæ.

Family 5. Piptocephalidaceæ.

Family 6. Entomophthoraceæ.

ORDER II. OOMYCETALES.

- Family 1. Monoblepharidaceæ.
- Family 2. Saprolegniaceæ.
- Family 3. Peronosporaceæ.
- Family 4. Chytridiaceæ.
- Family 5. Ancylistaceæ.

SUBCLASS. MYCOMYCETES.

ORDER III. ASCOMYCETALES.

SUBORDER A. PROTOASCIINEÆ.

- Family 1. Endomycetaceæ.
- Family 2. Exoascaceæ.

SUBORDER B. SACCHAROMYCETINEÆ

- Family 1. Saccharomycetaceæ.

SUBORDER C. PLECTASCIINEÆ.

- Family 1. Gymnoascaceæ.
- Family 2. Aspergillaceæ.
- Family 3. Elaphomycetaceæ.
- Family 4. Terfeziaceæ.
- Family 5. Tuberaceæ.

SUBORDER D. PERISPORIINEÆ.

- Family 1. Erysiphaceæ.
- Family 2. Perisporiaceæ.
- Family 3. Microthyriaceæ.

SUBORDER E. PYRENOMYCETINEÆ.

- Family 1. Hypocreaceæ.
- Family 2. Dothideaceæ.
- Family 3. Sordariaceæ.
- Family 4. Chætomiaceæ.
- Family 5. Sphæriaceæ.
- Family 6. Valsaceæ.
- Family 7. Melogrammataceæ.
- Family 8. Xylariaceæ.

SUBORDER F. DISCOMYCETINEÆ.

- Family 1. Hysteriaceæ.
- Family 2. Phacidiaceæ.
- Family 3. Pyronemaceæ.
- Family 4. Ascobolaceæ.
- Family 5. Pezizaceæ.
- Family 6. Helotiaceæ.
- Family 7. Mollisiaceæ.
- Family 8. Celidiaceæ.
- Family 9. Patellariaceæ.
- Family 10. Cenangiaceæ.

SUBORDER G. HELVELLINEÆ.

- Family 1. Geoglossaceæ.
- Family 2. Helvellaceæ.
- Family 3. Cyttariaceæ.
- Family 4. Rhizinaceæ.

SUBORDER H. LABOULBENINEÆ.

- Family 1. Peyritschiellaceæ.
- Family 2. Laboulbeniaceæ.
- Family 3. Zodiomycetaceæ.

ORDER IV. BASIDIOMYCETALES.

SUBORDER. HEMIBASIDIINEÆ.

- Family 1. Ustilaginaceæ.
- Family 2. Tilletiaceæ.

SUBORDER. UREDINEÆ. (Usually Order UREDINALES).

- Family 1. Endophyllaceæ.
- Family 2. Melamsporaceæ.
- Family 3. Pucciniaceæ.
- Family 4. Coleosporaceæ.

SUBORDER. AURICULARINEÆ.

- Family 1. Auriculariaceæ.
- Family 2. Pilacraceæ.

SUBORDER. TREMELLINEÆ.

- Family 1. Tremellaceæ.

SUBORDER. EUBASIDIINEÆ.

A. HYMENOMYCETES.

Family 1. Dacryomycetaceæ.

Family 2. Exobasidiaceæ.

Family 3. Hypochnaceæ.

Family 4. Thelephoraceæ.

Family 5. Clavariaceæ.

Family 6. Hydnceæ.

Family 7. Polyporaceæ.

Family 8. Agaricaceæ.

B. GASTEROMYCETES.

Family 1. Hymenogastraceæ

Family 2. Tylostomaceæ.

Family 3. Lycoperdaceæ.

Family 4. Nidulariaceæ.

Family 5. Sclerodermaceæ.

Family 6. Sphærobolaceæ.

C. PHALLOMYCETES.

Family 1. Clathraceæ.

Family 2. Phallaceæ.

FUNGI IMPERFECTI (Deuteromycetes).

ORDER I. SPHÆROPSIDALES, with 4 families.

ORDER II. MELANCONIALES, with 1 family.

ORDER III. HYPHOMYCETALES, with 4 families.

The above classification has been given in outline with the object of presenting to students the information which is requested frequently of the professor in the class room. A detailed presentation of the special morphology, histology, embryology and taxonomy of each group will be given in the pages which follow, omitting matters concerning pathology and practice. A separate section of this treatise will be devoted to the consideration of fungus diseases of plants and their treatment.

CHAPTER II

SLIME MOULDS (MYXOMYCETES)

CLASS I. MYXOMYCETES

Considerable attention has been given in recent years to the slime moulds on account of their biologic interest, taxonomic relationship and disease-producing forms. As organisms, they have been bandied about. They have been claimed by zoologists and botanists alike, for in certain stages of their life cycle they strongly suggest the protozoa, such as the amœba. Perhaps on account of this uncertainty one would be justified in placing the slime moulds in the class Protista of Haeckel, which group was intended to include all such primitive organisms which naturalists have been unable to put satisfactorily either in the animal, or the vegetable kingdoms, but which partake of the nature of both the animal and the plant phylæ. Hence we would have as a tentative arrangement



where the Protista represent the primitive stock of organisms which have given rise to simple animals on the one hand, or primitive plants on the other.

Fries and some of his predecessors considered that the slime moulds were puffballs (Gasteromycetes) and the expression of this view is suggested in the name MYXOGASTRES given them by Fries in 1833. Wallroth in 1836 viewing them as related to the fungi termed them MYXOMYCETES. De Bary, the German botanist, in 1858, impressed by their closer relationship with the animal world, called them MYCETOZOA. Zopf in 1885 describes them as *Die Pilzthiere* and Rostafinski, a pupil of De Bary, working under his supervision in an elaboration of a monograph of these organisms, calls them MYCETOZOA. We, therefore, are limited by strict priority to adopt the name MYXOGASTRES for them; but there are valid reasons why the name MYXOMYCETES

should be used. One of the strongest arguments is that if we consider them as plants they belong to the phylum of the fungi and hence this name MYXOMYCETES aligns itself with SCHIZOMYCETES and EUMYCETES generally adopted for the other groups of fungi. It conduces to clarity and simplification of classification to adopt the name of Wallroth for the class of organisms incapable of an independent existence, being destitute of chlorophyll and mainly saprophytic. The older name is retained, however, as the name of the third order of MYXOMYCETES, hence there should be little criticism of the view taken above. The MYXOMYCETES (Mycetozoa, Schleimpilze, Pilztiere, Slime Moulds) are chlorophyllless organisms. Their vegetative condition is known as a plasmodium which is a naked streaming mass of protoplasm. Reproduction is by means of spores produced as exospores, or endospores, the latter in sporangia, æthalia, or plasmodiocarps. The spores give rise to amœboid cells or flagellate swimmers which unite later to form the plasmodium, or develop directly into the plasmodium.

ORDER I. ACRASIALES.—The members of this order live on the excrements of animals and on the decaying parts of plants. They commence their development with the escape of an amœboid body from the walls of the spore and then move about by creeping movements, never assuming cilia for locomotion. The amœboid cells pile up on one another without coalescing to form what has been called an aggregate plasmodium, and they remain distinct, and artificially separable, though closely packed together until the fructification forms, when they rise above the substratum and form bodies of definite shape. Every one, or the majority of these definitely arranged amœboid bodies, becomes a spore covered by a delicate membrane and of an average size of 5 to 10 μ . These heaps of spores resemble the sporangia of the true slime moulds, but there is no distinct sporangial wall, the spores being held together by a structureless enveloping substance. The plants of this group are saprophytes. *Guttulina rosea* lives on decaying wood in Europe. *Dictyostelium mucoroides* is frequent on old dung, while *Acrasis granulata* is found on old yeast cakes. *Poly-sphondylium violaceum* occurs in southern Europe on manure.

ORDER II. PHYTOMYXALES.—The slime moulds of this order are parasites which live in the cells of higher plants. The plasmodium is limited by the cell walls of the host plants, and has its origin in amœboid cells which enter and infest the host cells, resulting in a

stimulation of the host to form gall-like swellings. The whole plasmodium is later transformed by division into a greater or less number of parts, which become surrounded by membranes to form spores. The spores are free in the cells of *Plasmodiophora*, while in *Sorosphæra* and in *Tetramyxa* they are clumped, and surrounded by a delicate membrane. The order includes a single family:

FAMILY I. PLASMODIOPHORACEÆ.—The characters of this family are coincident with those of the class as given above. The family includes four genera distinguished as follows:

- A. Spores distinct from each other, irregularly aggregated and filling the host cells.
- (a) Spores regular in shape, spheric. (1) *Plasmodiophora*.
- (b) Spores irregularly shaped, rod-like, or angular. (2) *Phytomyxa*.
- B. Spores united into clumps inclosed by a delicate membrane.
- (a) Spores united in groups of four each. (3) *Tetramyxa*.
- (b) Spores in greater number, united into hollow spheres. (4) *Sorosphæra*.

The genus *Plasmodiophora* comprises possibly three species found in Europe and America. They are parasites in the parenchyma cells of the cortex of the roots of the higher plants, where they produce gall-like swellings. The plasmodium fills some of the living cells of the host. The spores formed subsequently are spheric and lie free within the host cells. The best known species is *P. brassicæ* which is the cause of a serious disease known as club foot, or finger and toes (Fig. 1). The symptoms of the disease, the relationship of host and parasite, will be described in a subsequent section of this book. Two other species have been described, viz., *P. alni* in the roots of the alder; and *P. eleagni* in the roots of *Eleagnus*, the silverberry. Considerable more study will have to be made of the organisms in the roots of the alder and silverberry before we can definitely place the causal organisms. Tentatively, we may adopt the generally accepted view of the systematic relationship of the two responsible organisms until later investigation either proves or disproves the nature of the parasites attacking *Alnus* and *Eleagnus*.

The genus *Phytomyxa* is represented by two species which live as parasites in the roots of living plants and cause tuber-like enlargements. The plasmodia fill the host cells, and later, the irregularly shaped

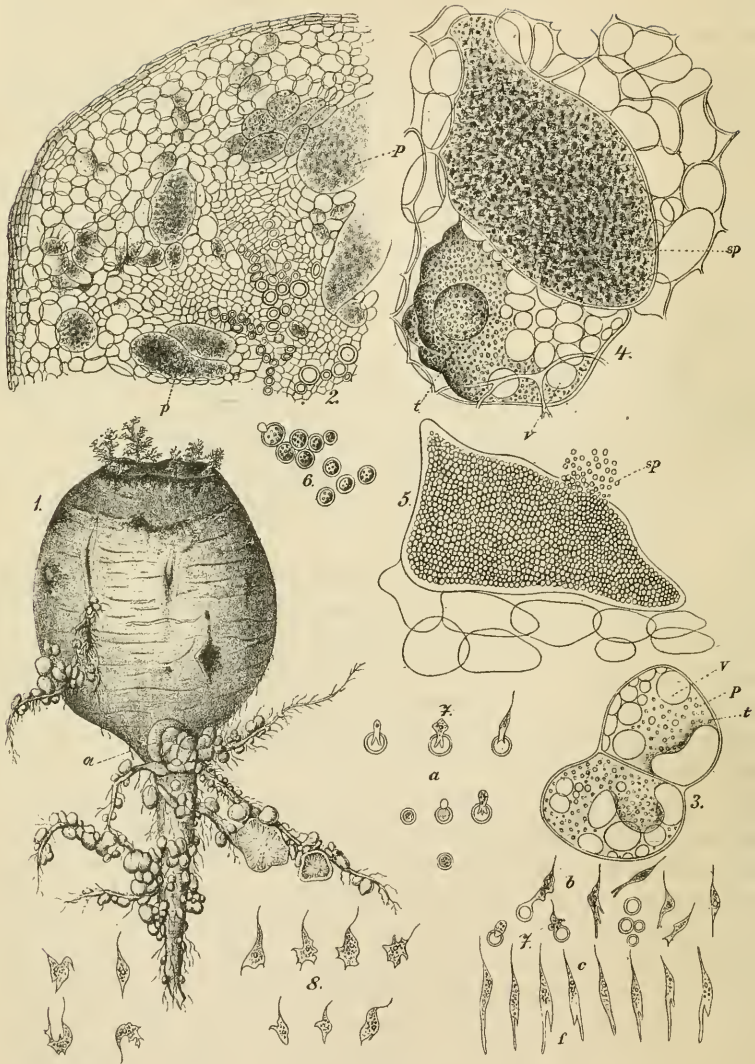

FIG. 1.—Club-root of cabbage, *Plasmiodiophora brassicae*. 1, Turnip with club-root; 2, section of cabbage root with parenchyma cells filled with slime mould; 3, isolated parenchyma cell, (*v*) vacuole; (*t*) oil-drops in plasmodium, (*p*) plasmodium; 4, lower cell with plasmodium, upper cell with spores developing; 5, parenchyma cell with ripe spores; 6, isolated ripe spores; 7, germinating spores; 8, myxamœba. (Figs. 2-8, after Woronin in Sorauer, *Handbuch der Pflanzenkrankheiten*, 1886, p. 72.)

spores fill the infested host cells. Two species have been described. The nature of *Ph. leguminosarum* is doubtful, as it may have been confused with one of the stages of the nodule-producing bacteria, which are found in the roots of leguminous plants.

The parasitic slime mould, *Tetramyxa*, occurs as one described species *Tetramyxa parasitica*, which lives in the stems and flower stalks of water plants, as *Ruppia rostellata*, where it causes tubercles 0.5 to 1 mm. in diameter. Each host cell contains numerous colorless spores united into tetrads.

Sorosphæra is represented in Germany by *S. veronica* found in the stems and petioles of *Veronica hederifolia*, *V. triphylla* and *V. chamaedrys*. The cells of the galls are swollen and filled with numerous spheric or ellipsoidal brown balls, 15 to 22 μ in diameter, formed of a single layer of spores united into a hollow sphere and covered externally by their pellicle.

ORDER III. MYXOGASTRALES.—This order includes the true slime moulds which are non-parasitic, but live on decaying organic material, such as old logs, leaf mould in the forest, compost heaps, spent tan bark and other organic débris in the fields, woods, and along the roadsides. One form grows over the grass of lawns and smothers the grass with its plasmodium and later by its sporangia and spores. The plasmodium is a naked mass of protoplasm usually of a reticulate structure and multinucleate. It arises by the union of the myxamœba which are developed from the flagellate myxomonads by the loss of the vibratile flagella. Such a plasmodium is known as a fusion plasmodium.¹ It usually assumes a reticulate, or net-like, structure and currents of protoplasm are seen flowing along the strands of greater or less thickness of which the plasmodium is composed. The central portion of each current is denser and moves more rapidly than the marginal clearer protoplasm. Perhaps we are justified in stating that the outer protoplasm is the ectoplasm and the inner granular cytoplasm containing food substances and other included substances is the endoplasm. For some time the plasmodium may flow in a given direction and later it may reverse its course, moving in an entirely opposite direction. The color of the plasmodium differs in different species, as the following table will show. White or yellow seem to be the more usual colors.

1 In *Labyrinthula Cienkowskii* parasitic in *Vaucheria* the plasmodium is filamentous.

Yellow.....	<i>Fuligo septica.</i>
Orange.....	<i>Trichia scabra.</i>
White.....	<i>Physarum ellipsoideum.</i>
Lead-colored.....	<i>Cribraria argillacea.</i>
Pink.....	<i>Enteridium splendens.</i>
Ruby-red.....	<i>Hemitrichia vesparum.</i>
Red.....	<i>Tubifera ferruginæ.</i>
Scarlet.....	<i>Cribraria purpurea.</i>
Brown.....	<i>Tubifera Casparyi.</i>
Violet.....	<i>Cribraria violacea.</i>

The movement of the plasmodium is associated with the incorporation of food. The yellow plasmodium of *Badhamia utricularis* has been most carefully studied in its relation to a food supply. It can be cultivated on such woody fungi as *Stereum hirsutum*, over which it extends, devouring by enzyme action the more delicate hyphæ. Thus nourished, it will spread over the moist filter paper inside of the covering bell jar until I have seen the plasmodium hanging down like stalactites from the inner top of the bell jar. Such a captive plasmodium has been fed by the writer pieces of mushroom *Agaricus campestris*. Shaggymane, *Coprinus comatus* and beefsteak have been placed on the surface of the protoplasm and in a few hours these substances have been found in advanced stages of digestion. Cheese is reluctantly invaded and is more refractory. The plasmodium is responsive to changes in the moisture surroundings. It moves toward a more abundant water supply. It is hydrotropic. It moves against a current of water and is, therefore, rheotropic. When highly illuminated, the plasmodium moves away from the lighted surface. It is negatively heliotropic. If there is a sudden change in the watery environment, the plasmodium will become massed into a cake-like lump in which form it remains as a sclerotium, macrocyst, or phlebomorph, if the substratum loses its water supply. In the sclerotial condition, the writer has kept a plasmodium for nine months on a plate of glass placed inside of a laboratory case in an absolutely dry condition. It was started into activity at the end of this period of rest on restoring free water to it again, and by feeding it mushrooms, it was kept in its restored activity for several weeks beneath a bell jar. The plasmodial stage may be prolonged for an indefinite period, if the environmental conditions of temperature, light, moisture and food, are favorable. The writer has

kept a plasmodium in a streaming condition for over a month beneath a bell jar. *Physarum psittacinum*, which inhabits the rotten stumps of old trees, appears to pass a year as a plasmodium.

The early stages in the formation of the sporangium have been described in *Comatricha obtusata*. When the fruiting period is reached, the watery-white plasmodium issues from the wood crannies and spreads over an area perhaps half an inch across. The plasmodium is seen to concentrate in thirty or forty centers and in an hour or two each center has by rhythmic pulsation of the protoplasm risen into a pear-shaped body with a slender base and an enlarged upper portion. The black hair-like stalk has grown to its full length in six hours and on its summit is borne the young sporangium, which is a white viscid globule of protoplasm. A pink flush now begins to appear in the sporangium. The included nuclei are like those of the plasmodium at first, but later as spore formation proceeds they divide mitotically. The sporangia of the different slime moulds take various forms which will be described in general in the systematic generic keys which follow. They may be either symmetric or irregular in shape, sessile or stalked. The irregular sessile forms, which simulate the net-like appearance of the streaming protoplasm, are called *plasmodiocarps*. When the fruit body is flat and cake-like with separating walls imperfectly developed it forms an *athalium*. The protoplasm which is left on the substratum and dries down as a film-like residuum is known as the *hypothallus* (Figs. 2 and 3).

The changes which take place in the formation of spores and capillitium have been minutely studied in a number of slime moulds. We owe much to R. A. Harper, E. W. Olive and B. O. Dodge in America and to E. Jahn in Germany for our knowledge of these processes. The process in *Didymium melanospermum*, according to Harper,¹ is as follows: The spore plasm condenses so that it is finely granular in the peripheral region and central region near the columella and foamy vacuolar in the middle zone. The capillitium is already formed before the condensation of the protoplasm has been accomplished. It consists of smooth threads which pass radially outward from the central dome-shaped columellar cavity to the sporangial wall. The threads of the capillitium are attached at their ends. The protoplasm is in contact with these threads and at this stage the nuclei are scattered

¹ HARPER, R. A.: Amer. Journ. Bot., i: 127-144, March, 1914.

rather uniformly through the spore plasm and are of unequal size. Vacuoles are formed in a still further condensation of the sporangial protoplasm and each of these apparent vacuoles is pierced by a capillitial thread which runs through its central axis. Droplets of water are formed along the capillitial thread as a still further evidence of water extrusion. Cleavage planes now appear at the periphery of the mass of sporangial protoplasm and progress inwardly toward the center. The process of cleavage parallels the extrusion of water and the formation of the blocks of protoplasm by these cleavage lines is assisted

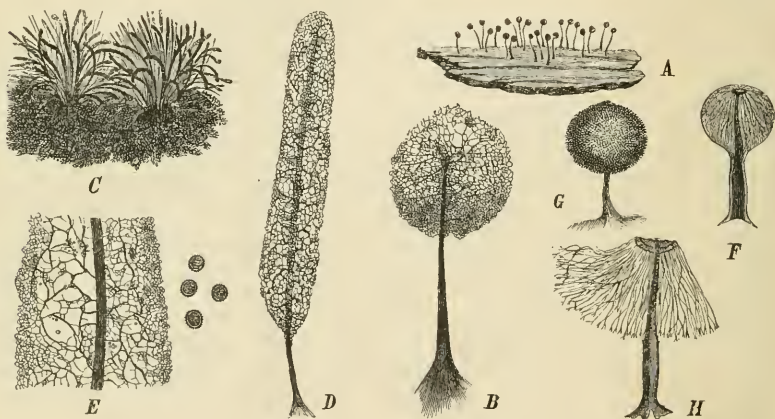

FIG. 2.—A, B, *Comatricha nigra*. A, Sporangium, natural size; B, capillitium, 20/1; C, E, *Stemonitis fusca*; C, sporangium, natural size; D and E, capillitia, 5/1, 20/1; F, H, *Enerthema papillatum*, F, unripe; G, mature sporangium, 10/1; H, capillitium, 20/1. (C, D, after nature. A, F, G, H, after Rostafinski; B, E, after de Bary in *Die natürlichen Pflanzenfamilien* I. 1, p. 26.)

by the presence of the vacuoles. The splitting up of the irregular blocks of protoplasm, which have the nuclei irregularly distributed through them, proceeds until the protoplasmic blocks are binucleated, and before this the nuclei are seen in various stages of division which proceeds irregularly in *Didymium*, while in *Fuligo* the division of the nuclei is simultaneous in a particular spore sack. The plasma membranes of the capillitial openings are the source of cleavage furrows to even a greater degree than the original surface plasma membrane of the spore sack as a whole. In *Fuligo* in the final stages of spore formation the spore plasm is condensed about the nuclei, but in *Didymium*, the ultimate

result of the progressive cleavage in furrowing is the formation of uninucleated rounded spores. They lie packed between the capillitial threads.

Most genera of slime moulds have a *capillitium* (Figs. 2 and 3) consisting of a system of threads, and as we have seen, it appears before the spores are formed. When the capillitium extends from the base of the sporangium, it is associated with a columella (Fig. 2). It differs widely in the different genera of the groups. In some genera, as *Trichia* and *Arcyria*, the capillitium consists of free threads, or elaters. In those genera in which calcium carbonate is present in the sporangia, it is found in the capillitium usually when several threads meet forming then the so-called lime knots. In *Dictydium*, purplish-red granules are imbedded in the threads of the false capillitium and are known as dictyidin granules. The formation of the capillitium in certain myxomycetes has been investigated by Harper and Dodge.¹ They find that the capillitium is formed by the deposit of materials in the vacuoles from which the capillitial thread is formed and that radiating threads run out from the larger granules which are deposited by the process of intraprotoplasmic secretion. These radiating fibrils suggest rather strongly that they are cytoplasmic streams which are bringing materials for the formation of the capillitial wall and its thickenings which are laid down sometimes as spirals, suggesting that the process is comparable to the ordinary processes of cell-wall formation, but along internal plasma membranes, rather than external. The relation of the fibrils to the capillitial granules is best seen where a capillitial vacuole runs longitudinally. Strasburger's earlier observations are confirmed by the recent work on capillitial formation, when he described the capillitium of *Trichia fallax* as originating in vacuolar spaces in the cytoplasm which elongate and take on the tubular form of young capillitial threads, while the formation of the wall and spiral thickenings are due to the deposition of granules as intraprotoplasmic secretions consisting of microsomes of the membranogenous type. Where the capillitial threads are solid they may be called stereonemata; where hollow, cœlonemata.

The spores are discharged from the sporangia, and if they find a suitable medium in which to grow, such as free water, they give rise to swarm cells, as amœboid bodies, or myxamœbæ. These soon acquire a

¹ Annals of Botany, xxviii: 1-18, January, 1914.

flagellum at the anterior end and creep in a linear form with the flagellum extended in advance, or swim about in the water with a dancing movement occasioned by the lashing of the flagellum. They have a single nucleus and a contractile vacuole. To a large extent they feed on bacteria which are swallowed by pseudopodia which project from the posterior end of the cell. The swarm cells increase rapidly by bipartition. When this takes place, the flagellum is first withdrawn and the main cell assumes a globular form; it then elongates and a constriction occurs at right angles to the long axis. The nucleus divides by karyokinesis and in the course of a few minutes the halves of the nuclear plate separate and retreat to the opposite ends of the constricted cell which now divides into two, each new cell acquiring a flagellum. Sometimes the swarm cells become encysted to form the so-called microcysts, or zoocysts.

The spores of *Ceratiomyxa*, which are borne on the outside of column-like sporophores, are white in color. The surface of the sporophore is divided into lozenge-shaped areas each with a projecting stalk bearing a single spore. The nucleus of these spores, according to Jahn, twice divide by karyokinesis, and finally, when the spore germinates, eight amœboid bodies are liberated, each of which develops a flagellum and the cluster swims away by the lashing of the flagella. Finally, these cells separate. All other myxomycetes have spores which in germination produce only one myxamœba.

Spores of *Reticularia* which had been dry for eight months germinated in thirty-five minutes at a temperature of 21° . Spores exposed to a temperature of 37° for only five minutes germinated in eleven minutes. The spores of *Stemonitis flaccida* germinated in one hour, those of *Amaurochate* in two and one-half hours, those of *Didymium* in four to five hours, while it took the spores of *Stemonitis ferruginea* in wood decoction three to five days to germinate.

Some remarkable discoveries have been made with regard to an alternation of generations in the slime moulds connected with a so-called sexual act. Jahn, Kränzlin and Olive have worked upon this problem. The generation in all the Myxomycetes, including *Ceratiomyxa*, with the double chromosome number (8) (diploid condition) in the nuclei is of short duration. The nuclei of the swarm bodies, amœboid bodies and the plasmodium have the single number (4) of chromosomes. Union of the nuclei to form fusion nuclei with double

the number (8) of chromosomes immediately precedes the formation of the sporangia. The reduction division, which results in the formation of spores, is preceded by synapsis, diakinesis and heterotypic nuclear division. Small nuclei and large nuclei are seen. The large nuclei are probably fusion nuclei. The small nuclei probably disintegrate.

To the order MYXOGASTRALES belong the majority of the MYXOMYCETES (Figs. 2 and 3). Many are found on decaying wood as *Diclydium cernuum* with black spore contents, *Arcyria nutans* and *A.*

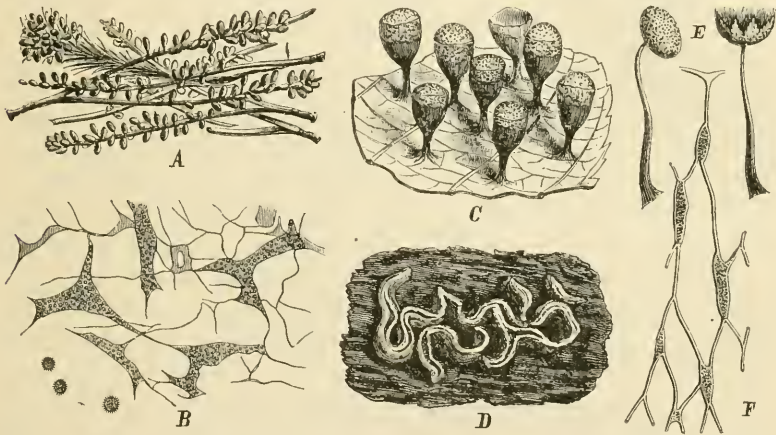

FIG. 3.—A, B, *Leocarpus fragilis*. A, Sporangium, natural size; B, capillitium 200/1; C, *Craterium leucocephalum* sporangia, 6/1; D, *Physarum sinuosum* sporangium, 6/1; E, F, *Tilmadoche mutabilis*; E, sporangia, 20/1; F, capillitium, 200/1. (A, C, D, after nature; B, E, F, after Rostafinski in *Die natürlichen Pflanzenfamilien* I. 1, p. 32.)

punicea have net-like capillitia, the former with yellow, the latter with a red one. *Lycogala epidendrum* has a cinnabar-red plasmodium and a brownish-gray æthaliium. *Trichia varia*, *T. chryso sperma*, *Hemiarcyria clavata* have yellow sporangia and golden-yellow spirally sculptured elaters, *Reticularia lycoperdon* has a large brown cake-like æthaliium. The yellow plasmodium of *Fuligo septica* sometimes covers spent tan bark and is known as "flowers of tan." It is one of the most generally distributed of slime moulds and the writer has found its æthalia on the bark of street trees and even on the bricks of the street pavements, as yellow-brown, cake-like fructifications crumbling readily

into a powder. The plasmodium of a species of *Chondrioderma* lives at the edge of melting snow fields, or even on the snow itself. The organism of malaria frequently called *Plasmodium malarie* is not a slime mould, but rightly belongs to the group of *Hämosporidiæ*, a division of the Protozoa.

The slime moulds are cosmopolitan. Many of the same forms have been found in North and South America, the West Indies, Europe, Cape of Good Hope, Australia, New Zealand and Japan. The writer has used a manual of the Myxomycetes of Buitenzorg, Java, in the identification of species found near Philadelphia. About 214 species are represented in the British Museum collection.

LABORATORY EXERCISE.—The writer has found in his experience as a teacher that time may be profitably spent by a class in mycology in the identification of the common slime moulds. The sporangia, æthalia and plasmodiocarps of the different kinds can be kept separately in different small pasteboard boxes and material out of these boxes can be distributed to the members of the class. The dried material is first treated with 70 per cent. alcohol to remove the air, and then the treated material is mounted for permanent preservation in glycerine jelly. The absorption of water by the glycerine jelly is prevented by a ring of asphalt. The "Guide to the British Mycetozoa exhibited in the Department of Botany, British Museum Natural History," 1st Edition, 1895, 2d Edition, 1905, 3d Edition, 1909, has been used in classes at the University of Pennsylvania with much success. After the generic name has been determined, Lister's "British Mycetozoa" or MacBride's "North American Slime Moulds" can be used to find the name of the species.

BIBLIOGRAPHY

- CONARD, H. S.: Spore Formation in *Lycogala exiguum* Morg. Iowa Acad. Sci., 17: 83, 1910.
- COOKE, M. C.: The Myxomycetes of Great Britain Arranged According to the Method of Rostafinski, 96 pp., 24 pls., London, Williams & Norgate, 1877.
- COOKE, M. C.: The Myxomycetes of the United States Arranged According to the Method of Rostafinski. Annals Lyceum, Nat. Hist., New York, 11: 378-409, 1877.
- COOK, O. F.: Methods of Collecting and Preserving Myxomycetes. Botanical Gazette, 16: 263, 1891.
- DE BARY, ANTON: Comparative Morphology and Biology of the Fungi, Mycetozoa and Bacteria. Oxford at the Clarendon Press, 1887, especially pp. 420-453.

- HARPER, R. A.: Cell and Nuclear Division in *Fuligo varians*. Botanical Gazette, 30: 217, 1900.
- HARPER, R. A.: Progressive Cleavage in *Didymium*. Science, new ser. 27: 341, 1908.
- HARPER, R. A.: Cleavage in *Didymium melanospermum* (Pers.) Macbr. Amer. Journ. Bot., 1: 127-143, March, 1914, with 2 plates.
- HARPER, R. A. and DODGE, B. O.: The Formation of the Capillitium in Certain Myxomycetes. Annals of Botany, xxviii: 1-18, January, 1914, with 2 plates.
- HARSHBERGER, J. W.: Observations upon the Feeding Plasmodia of *Fuligo septica*. Botanical Gazette, 31: 198-203, 1901.
- Distribution of Nuclei in the Feeding Plasmodia of *Fuligo septica*. Journ. of Mycology, 8: 158-160, 1902.
- A Grass-killing Slime Mould (*Physarum cinereum*). Proc. Amer. Philos. Soc., 45: 271-273, 1906.
- JAHN, E.: Myxomyceten Studien. Ber. Deutsch. Bot. Gesellsch. I. *Dictydium umbilicatum*, 19: 97-115, 1901; II. Arten aus Blumenau, 20: 268-280, 1902; III. Kernteilung und Geisselbildung bei den Schwärmen von *Stemonitis flaccida*, 22: 84-92, 1904; IV. Die Keimung der Sporen, 23: 489-497, 1905; V. *Listerella paradoxa*, 24: 538-541, 1906; VI. Kernverschmelzungen und Reduktionsteilungen, 25: 23-26, 1907; VII. *Ceratiomyxa*, 26^a: 342-352, 1908; VIII. Der Sexualakt, 29: 231-247, 1911.
- KRÄNZLIN, H.: Zur Entwicklungsgeschichte der Sporangien bei den Trichien und Arcyrien. Archiv Protistenkunde, ix: 170-194, 1907.
- LISTER, A.: Notes on the Plasmodium of *Badhamia utricularis* and *Brefeldia maxima*. Annals of Botany, 2: 1-24, 1888.
- LISTER, A.: On the Division of Nuclei in the Mycetozoa. Linn. Soc. Journ., xxxix: 529, 1893.
- LISTER, A.: A Monograph of the Mycetozoa, 224 pp., 78 pls., p. 894.
- LISTER, A.: Guide to the British Mycetozoa Exhibited in the Department of Botany, British Museum of Natural History, 1st Edition, 1895; 2d Edition, 1905; 3d Edition, 1909.
- MACBRIDE, T. H.: The North American Slime Moulds, being a list of all Species hitherto described from North America including Central America, pp. xvii+269; 16 pls., Macmillan Co., 1899.
- MACBRIDE, T. H.: On Studying Slime Moulds. Journ. Applied Microscopy, 2: 585-587, 1899.
- MACBRIDE, T. H.: The Slime Moulds. Rhodora, 2: 75-81, 1900.
- MASSEE, G.: A Monograph of the Myxogastres, 336 pp., 12 pls., London, Methuen & Co., 1892.
- OLIVE, EDGAR W.: Cytological Studies on *Ceratiomyxa*. Trans. Wisc. Acad. Sci. Arts and Letters, xv: 753-773.
- Monograph of the Acrasieæ. Proc. Boston. Soc. Nat. Hist., xxx: 451, 1902.
- Evidences of Sexual Reproduction in the Slime Moulds. Science, new ser. xxv: 266, 1907.
- PENZIG, O.: Die Myxomyceten der Flora von Buitenzorg, Leiden, 1898.

- REX, G. A.: The Myxomycetes, Their Collection and Preservation. Botanical Gazette, 10: 290, 1885.
- SCHROETER, J.: Myxogasteres in Engler and Prantl; Die natürlichen Pflanzenfamilien, 1: Abth. 1, pp. 1-35, 1889-92.
- SCHWARTZ, E. J.: The Plasmodiophoraceæ and Their Relationship to the Mycetozoa and the Chytrideæ. Annals of Botany, xxviii: 227, 1914.
- STRASBURGER, E.: Zur Entwickelungsgeschichte der Sporangien von *Trichia fallax*. Bot. Zeitung, xliii: 305-16; 321-3, May 16, 1884 and May 23, 1884.
- STURGIS, W. C.: The Myxomycetes of Colorado. No. 1. Science, ser. xii, No. I, pp. 1-43; general ser. No. 30, September, 1907; No. II. Science, ser. xii, No. 12, pp. 435-454, April, 1913; Colorado College Publications.
- STURGIS, W. C.: A Guide to the Botanical Literature of the Myxomycetes from 1875 to 1912. Science, ser. xii, No. 11, pp. 385-434. June-September, 1912. Colorado College Publication.
- ZOPF, W.: Die Pilzthiere oder Schleimpilze, i-vi + 1-174 pp., Figs. 1-51, Breslau. 1885.

CHAPTER III

THE BACTERIA IN GENERAL

CLASS II. SCHIZOMYCETES

The name Schizomycetes comes from two Greek roots ($\sigma\chi\acute{\iota}\zeta\omega$, I split + $\mu\acute{\upsilon}\kappa\eta\varsigma$, a fungus) which combined are equivalent to the term splitting fungi, or fission fungi in allusion to the manner in which the bacterial cells divide. The Germans call them Spaltpilze, which is the German way of expressing the same thing. The name bacteria is in American science used in a general sense to include all of the SCHIZOMYCETES without reference in particular to the genus *Bacterium*. In popular use, such as newspaper articles, these lowly plants are described as germs, microbes, or microorganisms. These English synonyms are, however, inexact, having different shades of meaning and are used in different ways in common speech, as consultation with any large dictionary of our language will show. There is no ambiguity, if we speak of all the SCHIZOMYCETES as bacteria, or bacterial organisms. These plants are generally unicellular, or the single cells are united into a cœnobium. These cœnobia are filamentous, sheet-like, or in groups, seldom arranged in fructification-like masses of definite form, as is the case with the *Mycobacteria*. All cells of the cœnobium are alike and only in the highest developed forms do we find a differentiation into basal cells and filament cells. The heterocyst, found in the blue-green algæ, is totally absent. The cells of bacteria are the smallest of plant cells; for example: *Micrococcus progrediens* has a diameter of 0.15μ and *Spirillum parvum* has a thickness of 0.1 to 0.3μ , but yet smaller are the ultramicroscopic organisms, which have come into prominence recently as the cause of certain diseases. The smallest bacteria stand at the borderline of what is with the best lenses and optimum illumination the practical limit of microscopic vision. On the other hand, with the application of the ultraviolet light of short wave length in microphotography, it has been possible to obtain an image of small objects whose enlargement has been 4000-fold. It has been possible with the ultramicroscope of Siedentopf and Zsig-

monly to demonstrate small particles whose size is only many million times that of a millimeter. The accompanying figure (Fig. 4) adopted from Fuhrmann¹ represents the relative size of the spheric bacteria and the rod-shaped organisms, while the breadth of the largest known bacterial cell, that of *Beggiatoa mirabilis*, which approaches that of a human hair in thickness, is represented in the larger area where the width of the cell is twice its length.

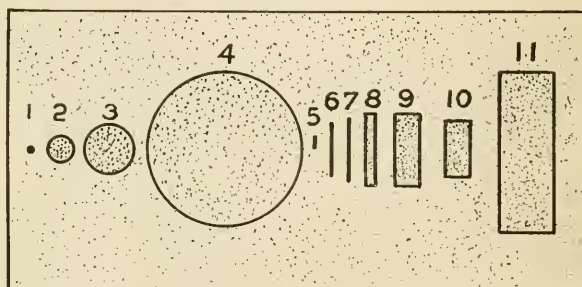

FIG. 4.—Diagram representing the relative sizes of spheric and rod-shaped bacteria (After Fuhrmann.)

		Diameter in μ	
Spheric Bacteria	1. <i>Micrococcus progrediens</i>	0.15	
	2. <i>Micrococcus ureæ</i>	1 to 1.5	
	3. <i>Sarcina maxima</i>	4.0	
	4. <i>Thiophysa volutans</i>	7 to 18	
Rod-shaped Bacteria	5. <i>Pseudomonas indigofera</i>	0.18	0.06
	6. <i>Bacillus influenzae</i>	4.2	0.4
	7. <i>Methane bacillus</i>	5.0	0.4
	8. <i>Urobacillus Duclauxii</i>	2 to 10	0.6 to 0.8
	9. <i>Bacillus nitri</i>	3 to 8	2 to 3
	10. <i>Beggiatoa alba</i>	2.9 to 5.8	2.8 to 2.9
	11. <i>Chromatium Okeni</i>	10 to 15	5.0
	12. <i>Beggiatoa mirabilis</i>	10 to 20	1.5 to 2.0

The cells exhibit a definite cell wall which differs from that of the higher plants in not containing cellulose. The chemical character of the cell membrane indicates its close relationship to the living protoplasm of the cell. Chitin has been found in the cell wall of some bacteria. Frequently the cell membrane undergoes a mucilaginous modification, so that the filamentous forms are surrounded by a sheath

¹ FUHRMANN, F.: Vorlesungen über Technische Mykologie, Fig. 7, page 17.

and the numerous individual forms are united into slimy, skin-like or lumpy masses known as *zoogloea*.

The interior of the cell shows no differentiation into nucleus and cytoplasm, but the nuclein in certain forms seems to be scattered in the plasma (Fig. 5). Considerable diversity of opinion exists as to the nature of the cell substance of bacteria. The uniform staining of the cell by ordinary methods suggests that the cell substance is all cytoplasm without nucleus. An opposite opinion is that the cell substance is composed almost entirely of nuclear matter (chromatin) with perhaps a thin layer of ectoplasm. Another view is that of Zettnow (*Zeitschr. f. Hyg.*, 1899: 18), who regards the cell body of bacteria as composed largely or almost wholly of chromatin mingled with varying amounts of cytoplasm. This, however, can be said, that it is fairly certain that bacteria contain both chromatin and cytoplasm which vary in amount and position in different cells (Fig. 5). The cell membrane is mostly colorless; seldom does it appear greenish or rose-red, as in the purple bacteria. When colonies of bacteria are colored, the coloring matter is an excretion product.

Locomotion.—The movement of many bacteria is a true movement from place to place, not merely a Brownian movement. It is accomplished in nearly all cases by the presence of cilia, or flagella, which by some are considered to arise directly from the cell membrane, by other investigators to arise from the ectoplasm within; its origin in some way associated with a blepharoplast. Whichever view is the correct one, the motile filaments can in some large spirilla be seen in the living unstained organism, but generally it requires special methods of treatment and staining to make them out. Great differences exist as to their distribution. Some forms, as the cholera bacillus, have a single flagellum at one pole (*monotrichous*); others, as many spirilla, have a flagellum at each pole (*amphitrichous*); others, as certain large spirilla, have a tuft at one pole (*lophotrichous*); while others have cilia covering the whole cell, as the typhoid organism (*peritrichous*). Many organisms are without cilia, or flagella (*atrichous*), and hence are non-motile.



FIG. 5.—1, *Chromatium okenii*. 2, *Beggiatoa alba*. Bacteria with a central body containing chromatin grains which are considered by Bütschli as the equivalent of a nucleus. (From Marshall, *Microbiology, Second Edition*, p. 91. After Bütschli.)

Cell Division and Reproduction.—As with other plant cells in general it may be said that growth is not conditioned on cell division. Growth is the enlargement of the cell, not merely a swollen condition, and this increase in size is within definite limits for each species, which can be determined by statistic study. As long as division is not preceded by nuclear division, the term fission is applicable. Certain students of the group claim that there is a division of the nuclear substance (Fig. 6), and Fuhrmann actually figures division of the nuclear material in such forms as *Bacillus nitri*, *Micrococcus butyricus*, *Spirillum volutans* and the potato bacillus. Possibly then division of the nuclear substance precedes that of cell division, and if that phenomenon is found general, the term fission is no longer applicable.

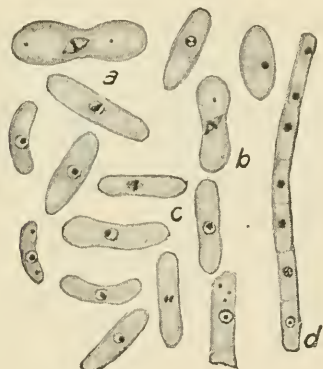

FIG. 6.

FIG. 6.—*Bacillum gammari*. a, b, c, Cells with typical nucleus of nucleoplasm, surrounded by a nuclear membrane and by one or two karyosomes also showing karyokinesis; d, a filamentous bacterium from intestine of an annelid worm, *Bryodrilus chlorii*, each cell with a nucleus. (From Marshall, *Microbiology*, Second Edition, p. 89, after Vějdowsky.)



FIG. 7.

FIG. 7.—Cells of *Bacillus megatherium*. 1, Polar granules as nuclei; 2, increase in size of nucleus at time of sporulation; 3, same; 4, change in size of nucleus which is surrounded by a membrane and becomes a spore. (From Marshall, *Microbiology*, Second edition, p. 90, after Penau)

Cell division may take place quite rapidly under favorable conditions. *Bacillus subtilis* divides in thirty minutes; *Vibrio cholera*, every twenty minutes. The young cells attain full size in a short space of time. Bacteriologists have estimated, that if bacterial multiplication was unchecked and the division of each cell was accomplished inside of an hour that in two days the descendants of a single cell would number 281,500,000,000, and that in three days the offspring of a single cell would weigh 148,356 hundredweights. Lack of food, accumulation of bacterial products injurious to the organisms that formed them explain why their rapid multiplication is kept in check.

The spores formed by the bacteria are of two kinds, arthrospores and endospores. Arthrospores are whole vegetative cells which by a thickening of their walls become resting spores. Some bacteriologists would not include arthrospores as true spores. The true spores are formed in the cells and differ from the cells in resisting greater heat and by other definite structural and physiologic qualities. (Fig. 7.) The shape of the cell may be altered with the formation of one or two spores within (endospores). In the hay bacillus, the spore occupies the center of the cell and is smaller than the original mother cell, hence the shape of the parent cell is not altered. *Bacterium panis* and *Bacillus amylobacter* become swollen in the middle when the spore forms so that the mother cell becomes spindle-shaped. The bacillus of lockjaw develops a spore at one end of the cell, which becomes drumstick-shaped, hence the German name trommelschlägel for such forms and the generic name *Plectridium* now given to cells that produce terminal spores.

Bacillus amylobacter may develop one terminal spore, or two spores, one at each end of the cell, so that the mother cell becomes dumbbell-shaped. *Bacillus inflatus* may develop two spores also.

Spores may germinate at the poles, as in *Bacillus Bütschli* and *B. amylobacter*; at the equator, as in *Bacillus subtilis* and *B. loxosporus*, or obliquely, as in *Bacillus loxosus*. In germination resting spores absorb water, and become more or less swollen, when the spore membrane is dissolved and the germ tube protrudes.

The classification of bacteria according to their special activities, or the products formed by these activities, is useful in presenting another phase of the subject to the mycologic student. The fact is noteworthy that we can group the various organisms into the photogenic (light-producing), chromogenic (color-producing), thiogenic (sulphur-producing), zymogenic (ferment-producing), pathogenic (disease-producing), saprogenic (decay-producing) and thermogenic (heat-producing) without reference to their morphology, or genetic relationship. It is useful to be able to discuss the light, heat, color, etc., produced by these organisms as distinct phenomena worthy of experimental treatment.

Photogenic Bacteria.—The phosphorescence associated with decaying haddocks, mackerel and other sea fishes, the faint glow seen on badly preserved meats (beef, mutton, veal) and sausages are produced by photogenic bacteria. Most success is obtained by using sea fishes in

experimenting with the phosphorescent bacteria, for these organisms require in their culture media from 2 to 3 per cent. of sodium chloride, besides the usual salts and peptone, the medium should contain some other source of carbon, such as sugar, glycerine, etc. The number of known photogenic bacteria is considerable. Migula names twenty-five species and Molisch twenty-six. A few need only be mentioned here, viz.: *Bacterium phosphorescens* Fischer; *Bacillus photogenus* Molisch; *B. luminescens* Molisch; *Microspira glutinosa* (Fischer) Migula; *M. luminosa* (Beijerinck) Migula; *Pseudomonas javanica* (Eijkmann) Migula. The results of numerous experiments are that the production of light by bacteria is an exclusively aerobic phenomenon, for in the absence of oxygen, they are non-luminous. The light is sometimes strong enough that jars containing luminous bacteria can be photographed by the light emitted by the organisms within the jar.

Chromogenic Bacteria.—Most bacteria are colorless and even in such forms in which color is associated with their growth on culture media, the organisms are colorless. The bacillus which causes the "bleeding host," *Bacillus prodigiosus*, is colorless with the pigment in the form of granules scattered about between the bacterial cells. In other cases, the pigments and fluorescent substances are diffused in the culture medium outside the living cells. Hence, we may call such bacteria as *chromoparous*. The *chromophorous* species are those in which the protoplasm is actually colored. Such are some sulphur bacteria *Chromatium* and *Thiocystis*, and finally, there are some forms as *Bacillus violaceus* in which pigment is lodged in the cell wall, when we may call them *parachromatophorous*. Practically all of the colors of the spectrum are represented in the color productions of bacteria: violet (*Bacillus violaceus*), indigo (*B. janthinus*), blue (*B. pyocyaneus*), green (*B. fluorescens*), yellow (*Sarcina lutea*), orange (*Sarcina aurantiaca*) and red (*B. prodigiosus*). The erythro bacteria, or colored sulphur bacteria, are unique in the power of assimilating carbon dioxide in the presence of sunlight by the activity of bacteriopurpurin (a red coloring matter) which behaves like the chlorophyll of green plants.

Thermogenic Bacteria.—Such substances as hay, silage, manure and cotton waste frequently become heated, the temperature inside the mass being raised to 60° or 70°C. This spontaneous heating is due to the respiratory activity of the thermogenic bacteria of Cohn (aerobic), which set up fermentation and putrefaction. The horticulturist uses

manure, especially horse manure, in the construction of hot beds for the cultivation and forcing of young plants. In silos, the highest temperature recorded during the fermentation of the ensiled material was 70°C. but the best silage is secured by keeping the temperature below 50°C. Sometimes this spontaneous heating increases to the point of actual ignition (spontaneous combustion) and it may occasionally happen that such substances, as baled cotton, may be set on fire in this way, for Cohn found in damp cotton waste a *Micrococcus* which, when furnished with a plentiful supply of air, raised the temperature of the decaying mass to 67°C.

Aerobic and Anaerobic Organisms.—Another useful division of bacteria is into those which are aerobic, requiring oxygen for their growth, and anaerobic, those which are indifferent to the presence of oxygen. The process of respiration in the aerobes is the same as in all ordinary organisms. Contrasted with the obligatory aerobes, we have those which thrive only in the absence of oxygen (obligatory anaerobes). The growth of some of the latter is inhibited by small traces of oxygen (*Bacillus tetani* and some butyric organisms). One of the classic experiments in biology was devised by Engelmann (*Botanische Zeitung*, 1881 and 1882) to detect minute traces of free oxygen. It is a well-known fact that in the process of photosynthesis, or carbon fixation, by green plants that free oxygen is formed. Experiments have shown that not all the rays of the spectrum are equally effective in causing this chemic change. The red rays between Fraunhofer's lines B and C are most effective and after them those just beyond the F line. It is these rays that are most active in the evolution of oxygen. Engelmann reasoned, that if a green alga was placed under the microscope and illuminated from below by a spectrum, so that the algal filament paralleled the band of spectrum colors, that if aerobic organisms were introduced into water beneath the cover glass, these aerobic organisms would congregate in greatest numbers along the green alga at those points illuminated by the rays most effective in oxygen evolution by the plant. His anticipations were realized for he found a grouping of the aerobic bacteria in the neighborhood of the B and C Fraunhofer lines and beyond the F line, where theory told him to expect the greatest photosynthetic activity. Such minute quantities of oxygen must be formed by a filamentous green alga, that this experiment becomes a microchemic test for the gas.

CHAPTER IV

CLASSIFICATION OF BACTERIA

Classification According to Nutrition.—An illuminating classification of bacteria has been based on their mode of life, where three biologic groups may be recognized: the prototrophic, the metatrophic and the paratrophic bacteria. The prototrophic bacteria, which include the nitrifying bacteria, bacteria of root nodules, sulphur and iron bacteria and erythro bacteria, are those which either require no organic compounds for their nutrition, or which given a small amount of organic carbon can derive all of their nitrogen from the atmosphere, or which with a minimum of organic matter can derive energy by breaking up inorganic bodies.

The sulphur bacteria live in sulphur springs where hydrogen sulphide (H_2S) is formed by putrefaction of dead animals and plants. The sulphur bacteria in such places form a white furry growth on the rotting vegetation. Here the H_2S is attacked and water and sulphur are formed, $H_2S + O = H_2O + S$. The sulphur is deposited in the living cells of the bacteria as yellow amorphous granules, which impart to the organism a yellow color. To explain the facts observed, we need assume only that the protoplasm increases the oxidizing power of the atmospheric oxygen and renders it active. The conversion of H_2S into water and S gives 71 calories and the further oxidation of the freed sulphur into sulphuric acid 2109 calories. The fact that the sulphur bacteria can live without organic compounds together with their inability to live without sulphur indicates that it is the oxidation of the sulphur alone which takes the place of respiration in other organisms.

The ferrobacteria live in stagnant pools in marshy places. On such pools of water, we find a greasy scum of ferric hydroxide $Fe(OH)_3$ together with organic matter and some phosphate of iron. The ferric compounds are reduced by the action of reducing substances formed by putrefaction to the ferrous state which are dissolved by carbon dioxide CO_2 and unite also with it to form ferrous carbonate. The atmospheric oxygen can convert this carbonate back to ferric hydroxide, but Wino-

gradsky has shown that the process is assisted by the iron bacteria and the ferric hydroxide is deposited as a tube about such organisms as *Leptothrix ochracea*. These tubes, or sheaths, are deposited later as bog iron ore.

The nitrifying bacteria are found in the soils of our gardens, fields and meadows and in virgin soil derived from places the world over. Winogradsky has discovered that the conversion of ammonia into nitric acid takes place in two steps and that bacteria are effective in both of these operations. One set of bacteria belonging to the genera *Nitrosococcus* and *Nitrosomonas* oxidize the ammonia to nitrous acid, or its nitrite, and the conversion of this nitrous acid (nitrite) to nitric acid, or its nitrate, is accomplished by *Nitrobacter*. *Nitrosococcus* is a non-motile spheric cell, 3μ in diameter, found in soil from South America and Australia, while *Nitrosomonas europæa* found in all soils from Europe, Africa and Japan is a short ellipsoidal motile form 0.9 to 1μ wide and 1.2 to 1.8μ long with a short cilium. *Nitrosomonas javanensis* from Java is almost spheric, 0.5 to 0.6μ , with a cilium 30μ long, which is the longest known among bacteria. *Nitrobacter* are minute non-motile rods ($0.5\mu \times 0.25\mu$). These organisms are of the greatest importance in putting the nitrogen of the soil into a form which can be absorbed by the roots of the cultivated plants.



FIG. 8.—Roots of soy bean, *Glycine hispida*, with tubercles. (After Conn, *Agricultural Bacteriology*, p. 97.)

The bacteria which produce the nodules (Fig. 8) on the roots of leguminous plants are probably the same the world over and to them Beyerinck has given the name of *Bacillus radicolica*, while Frank called them *Rhizobium leguminosarum* (Fig. 10). When the seeds of clover, or some other leguminous species are planted, and soon after the primary root appears with its root hairs, *Bacillus radicolica*, attracted chemotactically to the fine root hairs, penetrates the walls of these root hairs by ferment action. So many bacilli enter the root hair cells that they form slimy cords, almost hyphæ-like, as they move into the middle cortex cells of the root. Here in the cortex cells, the microorganisms form nests or pockets, that are filled with the nodule-producing bacteria

(Fig. 9). The presence of these bacteria causes the formation of swellings, tubercles, or nodules on the roots of the leguminous plants. Here *Bacillus radicola* remains, utilizing free atmospheric nitrogen until about the time of flowering of the host, when it begins to assume involution forms, enlarging considerably and assuming S-shaped or Y-shaped forms (Fig. 10). Then they are gradually absorbed by the

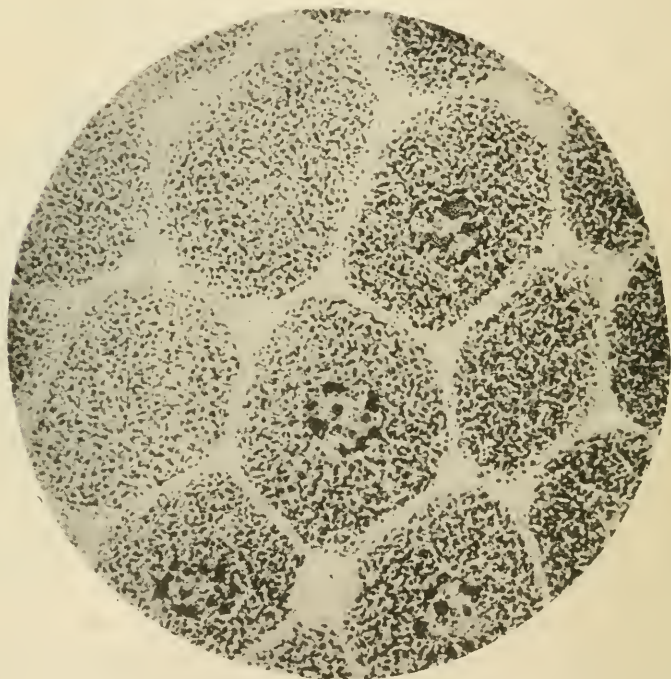

FIG. 9.—Cells of root tubercle of *Lupinus angustifolius* magnified to show the bacteria; four cells with nuclei. (After Moore, Geo. T., *Yearbook U. S. Dept. Agric.*, 1902, pl. xxxix.)

green leguminous plants and their substance is transformed into a form of nitrogenous substance, which is utilized by the leguminous host, either as food, or stored as nitrogenous reserve supplies. The nodule becomes emptied of its contents and remains as a hollow sac, enough of the organisms being returned to the soil to seed it and provide for infection of other leguminous crops that may follow. The growth

of these useful organisms in the soil is stimulated by aeration, by some organic material, by proper soil drainage, by the application of lime which overcomes soil acidity. The farmer becomes independent of the ordinary nitrogenous fertilizers, which are expensive, by plowing under the leguminous crops, which on decay yield up to the soil the nitrogenous substance largely accumulated by bacterial action where it is available to that large class of nitrogen-consuming plants such as the grasses, weeds, root crops, fruit crops and the like, which are dependent on the soil nitrates for their nitrogen. The leguminous plants as nitrogen-storing plants should, in an up-to-date rotation, be alternated with the nitrogen-consuming crops.



FIG. 10.—Left, branching forms of bacteria from clover tubercle ($\times 2000$); right, rod forms from fenugreek tubercle ($\times 2000$). (After Moore, Geo. T., *Yearbook U. S. Dept. Agric.*, 1902, pl. xxxix.)

Metatrophic Bacteria.—The metatrophic bacteria include the zymogenic, saprogenic and saprophile bacteria, which cannot live unless they have organic substances at their disposal, both nitrogenous and carbonaceous. They flourish where organic substances and foodstuffs are exposed to decay in impure water and in the waste from animal bodies. Many of them produce profound fermentative changes (zymogenic bacteria) in bodies. Others cause putrefaction and decay (saprogenic bacteria), while others develop in media which have been decomposed by saprogenic species and as saprophile organisms break these substances up into simpler chemical form.

Fermentation is well exemplified in an old and well-known process, the conversion of alcohol into acetic acid by a number of organisms morphologically very similar. Hansen considers that there are three different species concerned in the acetic fermentation, namely, *Bacterium aceticum*, *B. Pasteurianus* and *B. Kützingianus*, which are non-motile, medium-sized rods often in chains and forming pellicles which appear on the surface of the liquid, afterward sinking to form in the liquid a deposit known as mother of vinegar. The changes which take place in the conversion of alcohol to acetic acid may be expressed as follows:

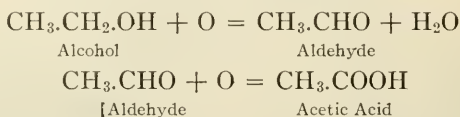

This is conducted in barrels with wood shavings, where the alcoholic fluid trickling over the shavings coated with the bacteria, and in contact with the air, is changed to acetic acid.

Lactic acid fermentation is important to man, because upon the changes in milk by the lactic acid organisms depends the manufacture of a considerable number of valuable products of the dairy, such as buttermilk and cheese. This fermentation is an aerobic process whose optimum is found between 30° and 35°C. There is a considerable number of bacteria capable of converting milk sugar into lactic acid, such as *Vibrio cholerae*, *Bacillus prodigiosus* and others, but the true lactic acid bacteria are those which are the cause of the souring of milk. Formerly, they were all classed as *Bacterium acidi lactici*, but recent investigations have shown that not one species but a considerable number are at work, sometimes one form; sometimes another being active. A common kind is a short non-motile rod, 0.5μ × 1 to 2μ, facultatively anaerobic, known by such names as *Bacterium acidi lactici*, *B. aerogenes*, and probably comprising several races of one species. The true lactic acid fermentation is the change of lactose, or milk sugar, into lactic acid. As lactose is not directly fermentable it must be converted into such simple sugars as glucose and galactose. The following equation approximately represents the chemic change involved.

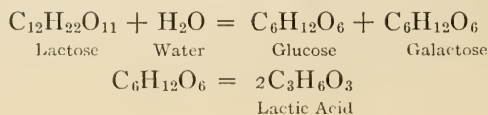

Several other important fermentations are due to bacteria, as the causal organisms, namely, the butyric, cellulose, and mucilaginous fermentations. The retting of vegetable fibers, the manufacture of indigo, the curing of tobacco are all dependent on bacterial fermentations.

The saprogenic organisms are concerned with decay, or putrefaction. The decomposition of dead animal and plant bodies is far from being a simple putrefactive process. Nitrogenous and non-nitrogenous bodies are both concerned in the putrefactive changes and they are broken down into simpler nitrogenous and non-nitrogenous compounds, or even elements. Proteins are split up into albumoses and peptones, aromatic compounds (indol and skatol), amino compounds (leucin, tyrosin, glyocol), fatty and aromatic acids and inorganic end products (nitrogen, ammonia, hydrogen, methane, carbon dioxide and hydrogen sulphide). Ptomaines and other poisonous bodies are formed known as toxins, a name applied indiscriminately to all bacterial poisons.¹

The activity of all these organisms in causing decomposition of animal and plant products is important in preserving the circulation of carbon and nitrogen in nature. Without such destructive changes, the elements carbon and nitrogen would be combined in such a form as to be forever lost to animals, and plants. In the dissolution of these complex bodies, the simpler chemic compounds are released and can be used over again by living animals and plants. Much should be made of the circulation of the elements in nature and the two chief cycles are the carbon cycle and the nitrogen cycle with a sulphur and phosphorus cycle as well. There are two main processes in organic life: the constructive processes (anabolism), and the destructive processes (katabolism). Construction is accomplished mainly by green plants and the prototrophic bacteria. Destruction is the work of animals, metatrophic and paratrophic organisms; which have to break down organic matter to live. Thus the elements of the organic world are kept in perpetual circulation.

Paratrophic Bacteria.—These organisms occur only in the tissues and vessels of living organisms and are, therefore, true parasites. Many of them are responsible for animal and plant diseases and the special types, as far, as they concern this book, namely, those which induce

¹Consult *Lathrop, Elbert C.*: The Organic Nitrogen Compounds of Soils and Fertilizers. Journ. Franklin Inst. 183: 169-206, Feb.; 303-321, Mch.; 465-498, Apr., 1917.

diseases in plants will be considered at length in another section. Most attention has been paid to diseases of animals and man due to bacteria and the number of special works dealing with the subjects of bacteriology, pathology, immunity and disease would form a library. Nearly every phase of the relationship of bacteria to animals and man has been cultivated, and microbiology has been placed on a firm foundation, as a subject of human inquiry. The field is too vast for one man to cultivate it, and hence, we find a narrow specialism perhaps more than in any of the other departments of biologic investigation.

An interesting phase of the relationship of parasite and host has come recently into the scientific limelight. Dr. Erwin F. Smith in the study of the organism which produces the crown gall of woody plants, *Pseudomonas tumefaciens* (Fig. 143), finds that the growth and formation of the tumors suggests the development of cancer in man. He thinks the formation of tumors in plants away from the point of infection suggests a similarity (Fig. 158).

SYSTEMATIC ACCOUNT OF THE BACTERIA

For the use of students who may not have access to larger works on bacteria and who would like a short systematic account of the bacteria the following synopsis is given.

ORDER I. EUBACTERIALES.—The organisms of this order are unicellular, or in plate-like, spheric, or filamentous cœnobia, if imbedded in a slimy matrix, then not of a definite form.

FAMILY 1. COCCACEÆ.—Single spheric cells. Division in one, two or three directions.

Streptococcus.—Division always in one direction, cœnobia, therefore, chain-like, cells without flagella. Pathogenic: *S. erysipelatos*, specific germ of erysipelas to be distinguished with difficulty from *S. pyogenes*. Not pathogenic: *S. mesenterioides* (*Leuconostoc mesenterioides*), occurring in mucilaginous masses in the molasses waste of sugar factories, and its presence disastrous to the industry.

Micrococcus.—Division in two directions, cœnobia, sheet-like, without flagella. Pathogenic: *Micrococcus pyogenes aureus* (= *Staphylococcus pyogenes aureus*), the cause of pus formation and purulent discharge from wounds, *M. gonorrhææ* (= *Gonococcus gonorrhææ*) specific germ of gonorrhœa. Not pathogenic: *M. aurantiacus*, *luteus*, *cinnabareus* producing pigments.

Sarcina.—Division in three planes, cœnobia in bales, or pockets, no flagella. *S. ventriculi*, frequent in the stomach of men, but non-pathogenic. *S. aurantiaca*, *flava*, *lutea* are chromogenic. *S. rosea* with red cell contents occurs in swamps, or colors the soil a rose-red color.

Planococcus.—Division and cœnobic formation as in *Micrococcus*, flagellate. *P. citreus* produces a yellow color.

Planosarcina.—Division and cœnobic formation as in *Sarcina*, flagellate.

FAMILY 2. BACTERIACEÆ.—Cells longer or shorter cylindrical, straight, or at least never spirally twisted. Division always at right angles to the long axis, and only after a preliminary elongation of the cell. The rods may separate early in some species, in others they remain united for a considerable time as longer or shorter filaments. Endospores are frequent, rare, or wanting. Flagella may or may not be present.

Bacterium (Ehrenberg char. emend.).—Cells as longer or shorter cylindrical rods, often forming filaments of considerable length. Without flagella. Endospore formation in many species, absent in others. Erwin F. Smith ("Bacteria in Relation to Plant Diseases": 168 to 171) believes that bacteriologists should substitute *Bacterium* for *Pseudomonas* as the older generic name, and he would establish a new generic name *Aplanobacter* for the non-motile forms generally referred to *Bacterium*. This distinction is not adopted in this text-book. Pathogenic: *Bacterium* (*Aplanobacter*) *Rathayi* the cause of Rathay's disease of the orchard grass; *B. michiganense* the cause of the Grand Rapids (Mich.) tomato disease; *B. anthracis* the first organism determined to be the cause of disease, causing anthrax or splenic fever; *B. mallei* specific in glanders in men and horses; *B. pneumoniae*, the cause of pneumonia; *B. tuberculosis* responsible for tuberculosis (consumption, phthisis) in man and animals. It can be distinguished by its staining reactions. If stained with carbol fuchsin and then treated with dilute nitric acid (1:5), the stain remains fast, while with other organisms, the stain will be washed out. After this treatment the tissues can be treated with methylene blue for differential staining. *B. lepræ*, the organism of leprosy; *B. influenzae*, the cause of influenza, or grippe; *B. diphtheridis*, the causal bacterium of diphtheria; *B. pestis*, specific in the disease known as the plague, which as the Black Death devastated

London in 1665 in which 70,000 persons perished. It is carried by infested rats.

Non-pathogenic: B. aceticum sets up in alcoholic solution the acetic acid fermentation and its films later form mother of vinegar. *B. acidi lactici* ferments sweet milk transforming it into sour milk where the acidity is due to lactic acid. *B. phosphoreum* is a phosphorescent fresh-water organism.

Bacillus (Cohn char. emend.).—Cells straight, rod-shaped to ovoid, long or short, sometimes united into filaments. Motile by wavy, bent flagella scattered over the whole surface of the cell. Formation of endospores frequent. Motility may be active for a time, and then is lost. Pathogenic: *B. musæ* causes the Trinidad banana disease; *B. tracheiphilus* is responsible for the wilt of cucurbitaceous plants; *B. amylovorus*, the pear-blight organism; *B. carotovorus*, specific in soft rot of carrot; *B. aroideæ*, an organism which causes soft rot of the calla; *B. tetani*, the causal microbe in tetanus, or lockjaw, is found in the soil and may enter the skin or superficial muscles of man through a pin prick, or rusty nail point; *B. typhi*, the typhoid bacillus. *Non-pathogenic: Bacillus subtilis*, the hay bacillus found in hay infusion, and is the cause of decay. *B. coli* in the alimentary canal of animals and men and in the water polluted by sewage. *B. butyricus* produces butyric acid fermentation and the coagulation of casein. *B. radicolica* (= *Rhizobium leguminosarum*) lives in the roots of leguminous plants and forms the root tubercles or nodules (Figs. 8, 9, 10). *B. amylobacter* (= *Clostridium butyricum*) ferments cellulose, dissolves casein and is useful in the retting of plants for fiber production. *B. prodigiosus* is found on many food substances imparting to them a dark red color. *B. calfactor* appears in hay infusions, where it produces a rise of temperature. *B. putrificus*, a widely distributed organism. Many bacilli that occur in the ocean are luminous.

Pseudomonas.—Cylindric bacteria, sometimes long, sometimes short, occasionally in threads. Locomotion accomplished by polar flagella, the number of which may vary from one to ten, most frequently one flagellum is present, or three to six. Endospores are formed, but are rare. The following are the causes of diseases in cultivated plants: *Pseudomonas campestris* is responsible for the black rot of cabbage and other cruciferous plants. *Ps. hyacinthi* causes the yellow disease of hyacinths. *Ps. vascularum* is associated as the causal bacterium in

Cobb's disease of sugar cane. *Ps. pyocyanea* causes blue pus. *Ps. putida* occurs in water, where it develops a green fluorescent pigment. *Ps. synchyanea* produces in milk a blue coloring matter (blue milk). *Ps. europæa* belongs to the group of organisms which cause nitrification.

FAMILY 3. SPIRILLACEÆ.—Spirally wound or bent cells with occasional endospore formation, usually motile. Cell division transverse to the long axis of the cell.

Spirosoma.—Spirally bent, rigid cells usually rather large and without flagella. Unicellular free or enveloped in a gelatinous capsule. Only a few species are known.

Microspira.—Comma-shaped, or sausage-shaped, single, or united cells, motile by means of a single, wavy, polar flagellum (rarely two or three flagella), rarely longer than the cell. Endospores unknown. Usually united with the next genus.

Spirillum.—Rigid rod-shaped cells of varying thicknesses, lengths and pitch of spiral turns, hence, either as long screws, or loosely wound. Flagella occur at one or both ends of the cells as polar tufts varying in number from five to twenty. In some species, endospore formation has been observed. *Sp. comma* is the cause of asiatic cholera and is found in cultures often in long spirally wound filaments. There are many non-pathogenic spirilla in water from rivers and ponds as *S. danubicum* in the Danube, *Sp. berlinense* in Spree water, *Sp. rufum* in stagnant water. *Sp. rufum* forms blood-red slimy masses between decaying algæ.

Spirochæta.—Thin, flexible, snake-like, motile cells usually quite long without observed flagella and endospores, and unsegmented. *Spirochæta Obermeieri* is the cause of relapsing fever (febris recurrens). *S. (Treponema) pallida* is the organism of syphilis. *S. dentium* is found associated with the teeth in man.

FAMILY 4. PHYCOBACTERIACEÆ (CHLAMYDOBACTERIACEÆ).—Cylindric cells united into sheath-surrounded threads and reproducing by motile or non-motile conidia, which arise from the vegetative cells without a resting stage.

Streptothrix (= *Chlamydothrix*, *Leptothrix*, *Gallionella*).—Non-motile, cylindric cells in unbranched threads possessing a sheath of varying thickness. Septa vague. Reproduction is accomplished by roundish, non-motile conidia arising from the vegetative cells. *S. fluitans* in water.

Crenothrix.—The cells are arranged in unbranched threads attached at one end and enlarging toward the distal extremity. Filaments covered by a rather thick sheath. The reproductive cells are non-motile conidia, which on discharge immediately germinate. *Crenothrix polyspora* in springs and water pipes, where it forms attached slimy growths. The sheaths in iron waters are impregnated with iron oxidhydrate.

Phragmidiothrix.—Cylindric cells with delicate, scarcely visible sheath. The cells of the filament are at first in one plane which later divide in three directions to form clumps or packets of cells. Later the single cells round off and become free. *Ph. multiseptata* with filaments 3 to 12 μ broad and 100 μ long attached to the bodies of crustaceæ.

Cladothrix (*Sphærotilus* in part).—The fixed and often tufted filaments form delicate sheaths. The cells are cylindric and by intercalary growth may break laterally through the sheath to form false dichotomous branches. Reproduction is accomplished by motile swarm spores (gonidia) which bear a tuft of flagella a little to one side of a pole. *Cladothrix dichotoma* occurs frequently in stagnant water, attached and forming furry growths. The following species occur in the soil: *C. rufula*, *C. profundus*, *C. intestinalis*, *C. fungiformis*, while *C. intricata* has been isolated from sea water and sea mud.

FAMILY 5. THIOBACTERIACEÆ (BEGGIATOACEÆ).—Cells with sulphur inclusions, unpigmented, or colored rose, red or violet by bacteriopurpurin; never green. The plants are generally filamentous with division transverse to the long axis.

Thiothrix.—Unequally thick attached filaments encased in a delicate, scarcely visible sheath. Rod-shaped conidia are formed at the ends of the threads. *Th. nivea* is found in sulphur springs and in stagnant water.

Beggiatoa.—Sheathless, free-filamentous bacteria, motile by means of an undulating membrane. Cells with included sulphur granules. Spore formation unknown. *B. alba* is found in dirty water, drain water from sugar factories and attached to decayed plants in sulphur springs. *B. mirabilis* forms white growths on dead marine algæ.

The colored sulphur bacteria, sometimes placed in the family RHODOBACTERIACEÆ, belong here. They have rose, red or violet cell contents due to the presence of bacteriopurpurin (see ante). The im-

portant genera according to Erwin F. Smith ("Bacteria in Relation to Plant Diseases," I: 163) are *Thiocystis*, *Thiocapsa*, *Thiosarcina*, *Lamprocystis*, *Thiopedia*, *Amabobacter*, *Thiothecca*, *Thiodictyon*, *Thiopoly-coccus*, as well, as the three genera *Chromatium*, *Rhabdochromatium*, *Thiospirillum*.

FAMILY 6. ACTINOMYCETACEÆ (Position doubtful).—Radially arranged branched filaments in colonies, non-motile. Filaments dividing into oidia-like reproductive cells.

Actinomyces chromogenes occurs in soil. *A. bovis* is the cause of lumpjaw in cattle and occasionally in man. The plant occurs in rosettes usually 30 to 40 μ in diameter. The filaments which are often curved sometimes spirally exhibit true branching and are interlaced in a network. Recently Youngken (Amer. Jour. Pharm., September, 1915) has described the foundation of the large swellings (mycodomatia) on the roots of the waxberry, *Myrica carolinensis*, and other species, as due to a species of ray fungus, *Actinomyces myricarum*, that abundantly fills infested cells in the cortex of the tubercular swellings. *A. thermophilus* is found on hay and manure.

ORDER II. MYXOBACTERIALES.—Individual plants enclosed in slimy masses which assume more or less regular fructification-like shapes.

FAMILY I. MYXOBACTERIACEÆ.—Erwin Baur and Roland Thaxter have studied these forms most intimately. The plants of this family consist of motile, rod-like microorganisms, with a gelatinous base and forming false plasmodioid aggregations preceding a cyst-producing, quiescent state in which the rods may be encysted in groups or converted into spore-masses. The slightly reddish rods in the vegetative stage are elongate, sometimes 15 μ long and vary little in size in the different genera and species. Cell division is by fission and the active rods show a slow sliding movement without organs of locomotion. The vegetative phase in artificial cultures usually lasts about a week, or even two weeks, and the formation of cysts which follows must be more rapid in nature. These organisms are found in moist places on decaying wood, dung, funguses and lichens, growing best, according to Baur, at 30°C. Three genera are included in this family.

Chondromyces.—Rods producing free cysts within which they remain unchanged. The cysts are various, sessile or developed on a stalk (cystophore).

Polyangium (= *Myxobacter*, *Cystobacter*).—The rods form large rounded cysts one or more of which are free inside a gelatinous stalked matrix.

Myxococcus.—Slender rods which swarm together, after a vegetative phase, to form well-defined, more or less sessile or stalked encysted masses of coccus-like spores.

BIBLIOGRAPHY

- ABBOTT, A. C.: The Principles of Bacteriology, 9th Edition: Lea & Febiger, 1915.
- DE BARY, A.: Comparative Morphology and Biology of the Fungi, Mycetozoa and Bacteria. Oxford at the Clarendon Press, 1887.
- BAUR, ERWIN: Myxobakterien Studien. Archiv für Protistenkunde, v Bd., Heft I, 92-121, 1904.
- BUCHANAN, ESTELLE D. and ROBERT EARLE: Household Bacteriology. The Macmillan Co., New York, 1914.
- CHESTER, FREDERICK D.: A Manual of Determinative Bacteriology. The Macmillan Co., 1914.
- CONN, H. W.: Bacteria, Yeasts, and Molds in the Home. Ginn & Co., Boston, 1903.
- DUGGAR, BENJAMIN M.: Fungous Diseases of Plants. Ginn & Co., Boston, 1909.
- ELLIS, DAVID: Outlines of Bacteriology (Technical and Agricultural), Longmans, Green & Co., 1909.
- ENGLER, ADOLF and GILG, ERNEST: Syllabus der Pflanzenfamilien. Berlin, 1912, Siebente Auflage, pp. 1-5.
- EYRE, J. W. H.: The Elements of Bacteriological Technique. Philadelphia, W. B. Saunders & Co., 1902.
- FISCHER, ALFRED, transl. by JONES, A. COPPEN: The Structure and Functions of Bacteria. Oxford at the Clarendon Press, 1900.
- FUHRMANN, DR. FRANZ: Vorlesungen über technische Mykologie. Jena, Gustav Fischer, 1913.
- HISS, PHILIP H. and ZINSSER, HANS: A Text-book of Bacteriology. D. Appleton & Co., 1915.
- JORDAN, EDWIN O.: A Text-book of General Bacteriology, 3d Edition. Philadelphia, W. B. Saunders & Co., 1913.
- KISSKALT, K.: Bakteriologie Zweite Auflage. Erster Teil von Practicum der Bakteriologie und Protozoologie. Jena, Gustav Fischer, 1909.
- KÜSTER, DR. ERNST: Anleitung zur Kultur der Mikroorganismen. Zweite Auflage, Leipzig und Berlin, 1913.
- LAFAR, DR. FRANZ: Technical Mycology. The Utilization of Microorganisms in the Arts and Manufactures. London, Charles Griffin & Co., vol. i, 1898.
- LIPMAN, JACOB G.: Bacteria in Relation to Country Life. The Macmillan Co., New York, 1908.
- MARSHALL, CHARLES E. and OTHERS: Microbiology for Agricultural and Domestic Science Students. Philadelphia, P. Blakiston's Son & Co., 1911.

- MEYER, DR. ARTHUR: Practicum der botanischen Bakterienkunde. Jena, Gustav Fischer, 1903.
- MUIR, ROBERT AND RITCHIE, JAMES: Manual of Bacteriology. The Macmillan Co., 1913.
- NEWMAN, GEORGE: Bacteria. Especially As They Are Related to the Economy of Nature to Industrial Processes and to Public Health. G. P. Putnam's Sons, New York, 1899.
- PARK, WILLIAM H. and WILLIAMS, ANNA W.: Pathogenic Microorganisms. Lea & Febiger, Philadelphia, 1914.
- PERCIVAL, JOHN: Agricultural Bacteriology Theoretical and Practical. Duckworth & Co., London, 1910.
- PRESCOTT, SAMUEL C. and WINSLOW, CHARLES EDWARD A.: Elements of Water Bacteriology, 3d Edition. John Wiley & Sons, New York, 1913.
- QUEHL, A.: Untersuchung über Myxobakterien. Zentralblatt für Bakteriologie, II Abt., xvi Bd., 1906.
- SMITH, ERWIN F.: Bacteria in Relation to Plant Diseases, vol. i, 1905; vol. ii, 1911; vol. iii, 1914. Publication No. 27, Carnegie Institution of Washington.
- THAXTER, ROLAND: On the Myxobacteriaceæ, a New Order of Schizomycetes. Bot. Gaz., xvii, 1892; Further Observations on the Myxobacteriaceæ. *Loc. cit.*, xxiii, 1897; Notes on the Myxobacteriaceæ. *Loc. cit.*, xxxvii, 1904.
- WETTSTEIN, RICHARD R. VON: Handbuch der Systematischen Botanik Zweite Auflage, 1911: 69-83.

CHAPTER V

CHARACTERISTICS OF THE TRUE FUNGI

CLASS III. EUMYCETES

The true fungi or hyphomycetes (ὕφῃ, a web + μύκης, a mushroom) are thallophytes in which the thallus, as the Greek derivation implies, consists of a system of threads (*hyphæ*) which form a cobwebby structure known as the *mycelium* (Fig. 11). A single thread of the mycelium is an hypha (plural *hyphæ*) and a hypha may be unicellular, or multicellular. All true fungi are colorless, that is they are chlorophyllless; and although they may have other pigments present, yet in the absence of chlorophyll, they are dependent plants.



FIG. 11.—Gray mould, *Mucor*, showing mycelium and the sporangia on upright sporangiophores. (After Conn.)

As dependent plants, they must get their organic food from extraneous sources, and as all organic matter is either dead, or living, a natural classification of fungi into saprophytes and parasites can be made. A saprophyte (σαπρὸς, rotten + φυτόν, a plant) is any organism which derives its chief food supply from dead, or dead and decaying animal or plant organic material, while

a parasite (παράσιτος, one who lives at another's expense) is an organism, which exists at the expense of living animals, or plants (Fig. 12). But some saprophytes may change their mode of nutrition and become parasitic; such saprophytes are called facultative parasites, while those which retain their saprophytism under all conditions are obligate saprophytes. Again some parasites can adjust their methods of nutrition, so that they can become saprophytes. Such parasites are called facultative saprophytes, while those organisms which are always parasitic are obligate parasites. These distinctions are useful, but it should be emphasized that there is no absolute borderline between one condition and the other. There are imperceptible

gradations which preclude an absolute pronouncement as to whether a plant is a saprophyte, or a parasite.¹ Botanists generally concede that the true fungi have been derived from filamentous algal ancestors and the groups of algæ from which the principal forms of fungi have

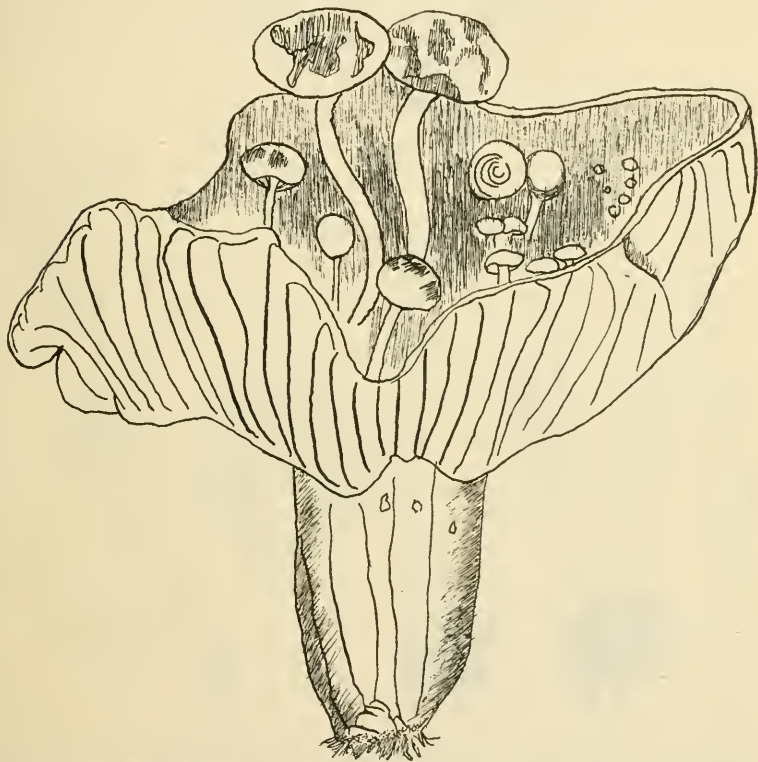

FIG. 12.—*Russula nigricans* parasitized by *Nyctalis asterophora*. (After Brefeld.)

been derived are fairly well known. For example, it is believed that such fungi as belong to the order OOMYCETALES have been derived

¹ MASSEE, GEORGE: On the Origin of Parasitism in Fungi. *Annals of Botany*, xviii: 319.

WARD, H. M.: Recent Researches on the Parasitism of Fungi. *Annals of Botany*, xix: 1.

BANCROFT, C. K.: Researches on the Life History of Parasitic Fungi. *Annals of Botany*, xxiv: 359, 1910.

from a green alga like *Vaucheria*. With our present knowledge, it is impossible to name any one existing alga as the progenitor of a definite fungous form, but we are safe in assuming in a general way that certain phyla of fungi have been derived from certain phyla of algæ, by the loss of chlorophyll and in the loss of an independent existence. Another view, which is open to argument, is that certain of the prototrophic

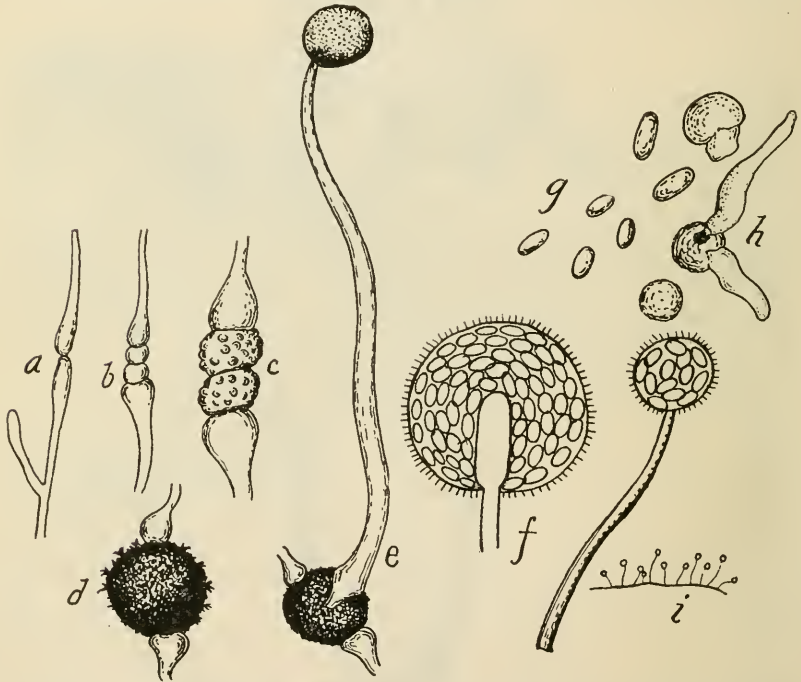

FIG. 13.—Development of *Mucor mucedo*. *a, b, c, d*, Stages in the formation of zygospore; *f*, sporangium; *g*, mature sporangiospores; *h*, one germinating. (After Schneider, *Pharmaceutical Bacteriology*, p. 142.)

filamentous bacteria to which attention has been previously called have been the direct progenitors of certain of the filamentous fungi, but on account of the character of the reproductive organs in the lower true fungi their derivation from green algæ is the more probable, and mycologists even speak of the algal fungi referring especially to aquatic genera, such as *Saprolegnia*, which like their algal ancestors not only retain the general morphologic features of the algæ, but also live in an

aquatic medium, and the success of the process of fertilization depends on the presence of free water. Such fungi form a subclass of EUMYCETES, the PHYCOMYCETES.

The vegetative organs of fungi are concerned with the absorption of food, the assimilation of the food and in the nutrition of the organs of fructification which together form the reproductive system. That the student may appreciate the morphology of the vegetative organs of the fungi, three examples from widely divergent orders will be chosen by way of illustration. A common mould is *Mucor mucedo* which appears on horse manure. If a spore of this fungus is placed in a nutritive medium, its wall breaks and there protrudes a germ tube rich in protoplasmic contents (Fig. 13, *h*). This germ tube grows in length into an hypha without the development of partition walls dividing it into shorter cells. This hypha branches and rebranches in its growth over the nutrient substratum spreading in all directions, if unimpeded by other organisms growing on the same food substance. The ultimate branches of this mycelium, which is throughout unicellular, are much attenuated, fine hyphæ representing the end ramifications of larger and coarser hyphæ nearer the point of origin of the whole mycelium (Fig. 13). The finest hyphæ usually enter the substratum, while the coarser, stronger hyphæ form a cobwebby mass over its surface. We can distinguish therefore the feeding hyphæ, which are rhizoidal hyphæ, and the aerial hyphæ in which probably the metabolic changes are most active where the mycelium is in open contact with the air. Later, when the mycelium is well established on the nutrient substratum, erect vertical hyphæ appear at indefinite points on the larger aerial hyphæ. These are the fruiting hyphæ, or sporangiophores, which ultimately cut off a terminal cell which becomes the sporangium, or case, in which the reproductive cells or spores are formed, while the end of the sporangiophore projects into the interior of the sporangium as a columella (Fig. 13, *f*).

The common green mould, *Penicillium glaucum*, may be taken as the second illustration (Fig. 14). If we sow a spore on nutrient agar in a Petri dish after a few hours the spore swells and there emerges a germ tube which at first is undivided by a partition wall. Later, as the older hyphæ branch to form new ramifications, cross-partitions are formed which divide the mycelium into short cells, so that in that respect the mycelium of *Penicillium* differs from that of *Mucor*. The hyphal

branches are coarser in *Penicillium* and do not form the fine-pointed ends found in *Mucor*. The presence of transverse walls in the fungi is thought of sufficient importance to make a subclass known as the MYCOMYCETES to contain all of the true fungi EUMYCETES which have a mycelium which is multicellular in contradistinction to those which have unicellular mycelia and that form the subclass PHYCOMYCETES. From this spreading mycelium of transversely septated hyphæ in *Penicillium* arise hyphæ which branch at the extremity into a number of erect branches from the ends of which are cut off in sequence a series of small round cells, the spores, which if undisturbed remain connected in a chain, so that the fructification roughly resembles a small broom, or whisk. The large vertical hypha is a conidiophore, and as the spores are pinched, or abstricted off from the secondary branches as single cells, they are known as conidiospores (κόνις, dust + σπορά a seed) (Fig. 14 and Figs. 243 to 263 inclusive).



FIG. 14.—Conidiophores of common green-mould, *Penicillium glaucum* with terminal chains of conidiospores. (After Conn, *Agricultural Bacteriology*, p. 7.)

The third example, which we will use to describe in general terms the vegetative organs of the fungi, is the honey-colored toadstool, *Armillaria mellea* (Fig. 15). The toadstools, or fruit bodies, often form dense clumps around the base of some dead or dying tree, or almost cover an old stump on which they grow. The cap is of a honey-colored brown, about two inches across, and the stem may be six inches long and paler than the cap. Microscopic sections of the stem and cap show that they consist of hyphæ that are closely bound together to form the stem and

cap. If we examine the base of the stalk, we find that it arises from a dark-colored cord-like strand which has been termed a rhizomorph because of its resemblance to a root (Fig. 15, II and IV). These rhizomorphs constitute the mycelium and they either ramify through the soil, or else are found beneath the bark of the dead tree, where they unite to form open-meshed nets of a dark brown color. These rhizomorphs are strands of hyphæ that run longitudinally. The hyphal cells are bound together in a cord-like cable which is peculiar in that it shows apical growth, constantly elongating at its extremity, as it grows beneath the bark, or penetrates the soil (Fig. 15)

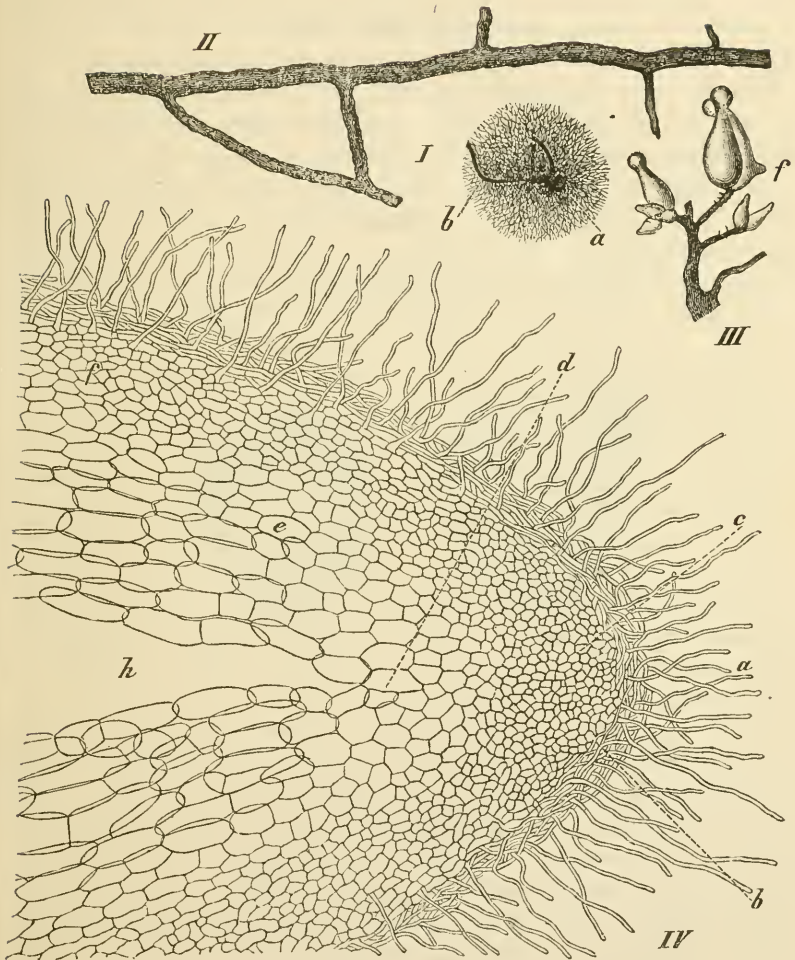

FIG. 15.—Details of the mycelium of *Armillaria mellea*. I, Piece of mycelium on slide; II, piece of old mycelium (*Rhizomorpha subterranea*); III, rhizomorph producing fruit bodies; IV, apex of rhizomorph capable of growth; (a) peripheral hyphae; (b) pseudo-epidermis; (c) growing point; (d, e, h) pith; (h) hollow center. (I and IV after Brefeld; III, after Hartig in Zopf, *Die Pilze*, 1890, p. 25.)

its extremity, as it grows beneath the bark, or penetrates the soil (Fig. 15). Such a compound thallus differs strikingly from the filamentous thalluses of the two previously described fungi. The union of the hyphal cells in some of these fleshy fungi may be so intimate as to constitute a pseudoparenchyma, and this close union of the cells may be made still more intimate by clamp connections where two adjoining cells are bound together endwise by a clamp-like protuberance of one of the cells attached to the end of the other adjoining cell. When the pseudoparenchyma is external, it may serve for the protection of the internally disposed hyphæ, and be looked upon as protective tissue. Mechanic tissues for the support of fungi are not unknown in some of the groups, as in some of the polypori; where there are clamp connections, transverse septa and thickened cell walls. A few of the higher fleshy fungi have conducting hyphæ, which are larger and more tubular than the surrounding hyphæ, and which conduct later, oil and other substances. Those which conduct a milky juice, as in some species of *Russula* and *Lactarius*, may be termed laticiferous hyphæ. There are some fungi in which the hyphal form of thallus is not present. The yeasts are either single ellipsoidal cells, or these cells are loosely connected together in a chain of bead-like cells. These chains are due to the budding or sprouting method of cell multiplication where a bud, gemma, or sprout, grows out from the mother cell as a daughter cell. It in turn buds producing a granddaughter cell and so forth. Such a method of reproduction is known as gemmation.

In the parasitic fungi, the hyphæ run either into the cells, through the cells (intracellular), or between the cells (intercellular). Where the hyphæ are intercellular, short branches may be formed which penetrate the host cells. These short branches take various forms and are known as *haustoria*; a single one as an *haustorium* (Figs. 36 and 67). Occasionally in the mildews, the mycelium may be superficial and hence *epiphytic*, while the mycelia which are internal are *endophytic*. These are useful terms when describing the parasitic habits of fungi. Some of the groups of fungi have mycelia that form resting bodies of hyphæ. These are the most compact of all forms of mycelia and are known as sclerotes (*sclerotium—ia*), which in many cases assume tuberous forms. They are resting states of the mycelia and act as stores of reserve material. These are some of the principal forms of the vegetative thallus of the fungi. Further details will be given in the discussion which follows. Some sudden epidemics of rust fungi

have been ascribed by Eriksson to the presence of the protoplasm of the rust mixed with the protoplasm of the host. To this included fungous protoplasm he gave the name *mycoplasm*.

Some fungi are *symbiotic*, that is, they are found in intimate relation with chlorophyll-containing plants and obtain from them food of a carbonaceous character, but without apparently injuring the green symbiont. When they live with algae, they commonly form lichens; or if in connection with the roots of trees, orchids; and in prothallia they form what is known as *mycorrhiza* (Fig. 16).

The spores or reproductive cells of fungi may be of two kinds: non-sexual spores and sexual spores. The non-sexual spores are cells which are formed vegetatively. They are cells which take special

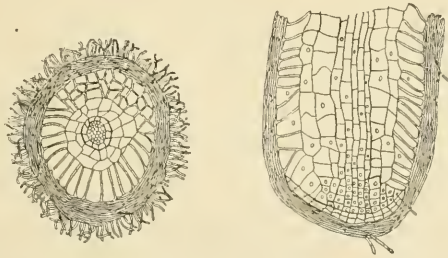

FIG. 16.—Ectotrophic mycorrhizas. At left hyphal mantle on root of hickory *Carya ovala* in cross section; at right root tip of an oak, *Quercus*, with fungous mantle. (From Gager, after W. B. McDougall.)

forms in the different groups of fungi and are produced as special cells in a purely vegetative manner. They represent a special part of the thallus given over to reproduction. Upon the formation of these spores, which may germinate at once or live for some time as resting spores, the rapid multiplication of the fungi depends. It is the innumerable quantity of these non-sexual spores upon which an epidemic of some particular fungous disease may depend. Only the most general characters of the various kinds of spores can be discussed in an introduction of this kind. The special kinds will receive due attention as we proceed. Spores which are cut off, or pinched off, in concatenation from the end of a vertical hypha, are known as *conidiospores*. In the rusts such conidiospores become *uredospores*, and in the mushrooms *basidiospores*. Where the non-sexual spores are formed in a spore case,

or sporangium, they may be termed *sporangiospores* (Fig. 13, *f*). Frequently spores are formed by a modification of certain cells of the hyphal branch. These spores are usually thick-walled, as in the smuts, and become known as *chlamydospores*. Where the whole hypha is divided up into a chain of spores one after the other in close order, such spores are called *oidiospores*. Special receptacles are associated with the formation of the non-sexual spores. These are found in the sac fungi, ASCOMYCETALES, where the depressed conceptacle becomes a *pycnidium*, or conidial fruit, and the spores which it contains are *pycnidiospores*, *pycnospores*, *pycniconidia* or the *stylospores* of Tulasne. This form of conidial fruit is surrounded by a firm wall or peridium. The pycnidia may be depressed in the tissues of a host plant or elevated above its surface, as the case may be. In some fungi the conidiophores, instead of being separate, are arranged in parallel order, side by side, at an early stage, and thus are united into a fascicle to which the name *coremium* has been applied.

The principal sexually produced spores in the fungi are *zygospores*, *oospores*, and *ascospores*. The first two forms are found in the subclass PHYCOMYCETES.

Their formation proceeds in such a manner that the zygospores are produced isogamously, that is, by the union of two similar cells, while the oospores are heterogamous, that is, they are produced by a union of an egg cell and a sperm cell. Hence, we distinguish two orders of the PHYCOMYCETES, namely, the ZYGOMYCETALES and the OOMYCETALES, the first showing isogamy and the latter heterogamy. Details will be given when these orders are considered in detail. Until recently, it was believed that sexuality did not exist in the sac fungi, ASCOMYCETALES, but recent research has shown that the nuclei of two adjoining cells unite and this is followed by the formation of a spore sac, or ascus, containing sac spores, or *ascospores*. The formation of the asci is usually associated with the production of definite fruit bodies. It is doubtful whether sexuality is found in any of the other groups of fungi. Curious nuclear fusions in the rusts have been suggested as a sexual union, but it is safer to await future discoveries before adopting such a position. However, there are fungi in which sexual organs seem to be lost entirely and many of these belong to the most highly developed forms where the thallus and fructifications are of a complex type. The whole trend of evolution in the fungi is for

the reduction in size and importance of the sexual organs, until they have disappeared completely. This may be a result of the perfect manner in which the different specific types are reproduced and multiplied by the various kinds of non-sexual spores found in the different fungous groups.

CHAPTER VI

HISTOLOGY AND CHEMISTRY OF FUNGI

Histology.—Naked cells which are destitute of a cell wall and consist of naked protoplasm occur as motile cells in only two unimportant groups of the OOMYCETALES. The cell wall of fungi does not appear from the results of numerous workers upon its chemistry to be of the same nature in the different groups of them. A general term which has been in current use and which was first suggested by A. de Bary is that of fungous cellulose, but that term, as far as indicating the chemic character of the membrane is concerned, is a misnomer. It has its correct application, if we employ the term in the sense of fungous membrane substance. We owe to C. van Wisselingh (1898) the examination of about a hundred species from nearly all of the orders and most of the families of EUMYCETES. Wisselingh could detect the presence of cellulose with certainty only in two families, the SAPROLEGNACEÆ and the PERONOSPORACEÆ. This carbohydrate could not be detected either in the ZYGOMYCETALES or in any of the MYCOMYCETES examined, and especially was it found to be absent in the yeast *Saccharomyces cerevisiæ*. The researches of Winterstein, Gilson and Wisselingh proved that chitin formerly supposed to be of animal origin was found in the membranes of fungi. With the exception of the two families mentioned above, the bacteria and the yeasts, chitin has been detected in all other species of fungi examined, e.g., *Mucor mucedo*, *M. racemosus*, *Rhizopus nigricans*, *Penicillium glaucum*, *Trichothecium roseum*, in the sclerotia of *Botrytis cinerea* and *Claviceps purpurea*. We do not know at present of the simultaneous occurrence of cellulose and chitin in the same cell wall. E. Winterstein has found true hemicellulose in certain fungi and other chemic substances have been reported such as carbohydrates of the pentosan group, pectose, callose, etc.

The outer layers of the wall, in some fungi (TREMELLACEÆ) may be mucilaginous, so that it is resolved into a soft gelatinous mass. Lignification has been reported in the large pileated fungi though whether

the presence of lignin is proved thereby must remain an open question. Deposits and incrustations of calcium oxalate crystals are found in the membranes of fungi, as the spicules in the sporangial wall of *Mucor mucedo*.

The cell contents, or protoplasm, of fungi may be divided into cytoplasm with its inclusions and nucleoplasm. The cells contain either a single nucleus (*Erysiphe*), two, as in *Exoascus*, or several, as in the mycelial cells of *Penicillium glaucum* and *Peziza convexula*. The hyphæ of many contain numerous, sometimes over hundreds of nuclei (PHYCOMYCETES). The structure of the nucleus in basidia as described by Wager agrees with that of the higher flowering plants. It has a nuclear membrane, nucleolus and nuclear network of threads coiled in a loose knot. Chromatin granules occur. The nucleus undergoes division either by fission, or by karyokinesis, as first observed by Sadebeck. Chromosomes are formed from the chromatin bodies when the nucleus begins to divide. A reduction of chromosomes has been observed by Stevens. Fats and oils are present in fungous cells and are found in the form of drops or globules. Glycogen has been detected in the spore sacs of the ASCOMYCETALES. Volutin is a name given by Meyer to a reserve substance which contained C, H, O, N and P atoms. Mannite, trehalose and glucose have been found in many fungi by Bourquelot. Special substances of a poisonous nature such as ergotin, muscarin, phallin are of special significance in certain fungi.

Colors.—Full details regarding the coloring matters in fungi will be found in Zopf's "Die Pilze in morphologischer, physiologischer, biologischer und systematischer Beziehung," 1890. Clear bright colors are present in such species as *Peziza aurantia*, *P. coccinea*. *Russula virescens*, has a cap with shade of green lighter, or darker, in individual specimens. *Russula emetica* is red. Blue is the predominant color in the genus *Leptonia*. *Armillaria mellea* has a honey-brown, or yellow color. The violet color of *Cortinarius violaceus* is well known. The color in a number of fleshy fungi changes when the fruit bodies are broken, injured or exposed to the air. This change of color is due to an oxidizing enzyme. The flesh of a number of species of *Boletus* changes from white or yellow to a deep indigo-blue when broken, or abraded. The deliquescence of species of the genus *Coprinus*, when the color changes from white to black with the melting

down of the whole fruit body has been proved to be a process of auto-digestion. When the hyphæ are colored, the color is confined generally to the cell wall, although Biffen states that in some hyphæ the color is located in the contents, the wall remaining colorless. Spores are colored frequently as in *Ascobolus* which grows on manure. The spores at first colorless change through pale lilac to clear deep amethyst. The coloring matter is confined to the spore walls, but in some cases the contents are colored, while the wall is colorless, as in many æciospores.

PHYSIOLOGY OF FUNGI

The research of recent years in the nutrition of fungi has shown that nine chemic elements are necessary for the structure and complete development of the true fungi. These elements are carbon, hydrogen, oxygen, nitrogen, sulphur, phosphorus, potassium (or rubidium), magnesium and iron. Analysis of the ash constituents of fungi shows that phosphoric acid and potassium are the chief ones, the latter forming seldom less than one-quarter and sometimes one-half of the total. Phosphorus is present in the ash to the extent of 15 to 60 per cent. and is eagerly absorbed by growing fungi, as is shown by *Dadalea quercina*, which in its growth completely extracted the phosphoric acid from decayed wood. Winogradsky, Meyer, H. Molisch and W. Benecke have shown that magnesium is indispensable to fungi. Benecke has demonstrated a considerable difference in development shown by two, otherwise equal, specimens, the one grown without magnesium and the other in a medium containing 0.0025 mg. of crystallized magnesium sulphate per 25 c.c. and Guenther has proved that 0.005 mg. of magnesium sulphate was necessary to induce a sowing of *Rhizopus nigricans* to grow at all.

As to iron, as an indispensable element before the matter was put to the test, it was thought that fungi being chlorophyllless did not require iron like the green plants in which iron was concerned in the formation of chlorophyll. The experiments of Hans Molisch tend to prove the essential importance of iron in the nutrition of the true fungi for in presumably iron-free cultures, the spores of *Aspergillus niger* did not develop beyond the formation of a sickly mycelium. Similar results were obtained with sowings of pressed yeast cells, spores of *Mucor racemosus* and a species of *Penicillium*. Iron in addition to

being a nutritive material also acts as a stimulant. The position of sulphur, as an important nutritive element, is doubtful. It is inferred that because this element forms an important constituent of the albuminoids, that it is, therefore, essential to fungi, but there are no reliable experiments which prove that to be so. Awaiting more detailed investigations, sulphur has been included in the above list of nutritive elements. The source of the C, H, and O which form such an important part of the food of fungi is the dead or living bodies of other plants and animals, principally plants in which are found sugars, starch, cellulose, mannite, citric acid, and other bodies of organic origin. The source of nitrogen is similarly from soluble nitrogenous bodies, peptones, propylamin, asparagin and others, but few if any of the higher fungi can utilize free atmospheric nitrogen, as can the bacteria which form the nodules on the roots of leguminous plants, described in a former section of this book. The various culture media on which bacteriologists and mycologists cultivate successfully a large series of bacteria and fungi will be considered in a subsequent chapter. Modern research along the lines of technique has demonstrated many important points about the growth and nutrition of the higher fungi and these will be discussed, as we proceed to the end of the book.

The chemic investigation of the fungi began with the refinements in the technique of modern organic chemistry and much has been published on the subject, so that there is a bibliography too voluminous to give. Much of the most important chemic work on fungi published prior to 1890 will be found in Zopf's "Handbook." No general work of this kind has recently appeared, so that we must depend on recent original papers on the chemistry of fungi, and in part on the statements of Zopf's great book. The following inorganic elements have been found in fungi: chlorine, sulphur, phosphorus, silicon, potassium, sodium, lithium, calcium, magnesium, aluminium, manganese and iron. Manganese has been found in the cap of *Lactarius piperatus*. Aluminium has been reported as occurring in the ash of lichens. The mean of a number of analyses¹ of mushroom (*Agaricus campestris*), truffle (*Tuber*), *Morchella esculenta*, two other species of *Morchella*, species of *Boletus*, and *Polyporus officinalis* is as follows: potassium 45 per cent., phosphoric acid 40 per cent., magnesia 2 per cent., sodium 1.4 per cent., calcium 1.5 per cent., iron oxide 1 per cent., silicic acid

¹ZOPF, WILHELM: Die Pilze: 118.

1 per cent., sulphuric acid 8 per cent., chlorine 1 per cent. The organic compounds of the carbohydrate group found in fungi are cellulose, grape sugar, glycogen and kinds of gums, mannit, inosit, and several other less important ones. The organic acids include oxalic, malic, acetic, citric, formic, lactic, helvellic, and propionic acid, as well as other less well-known acids.

Fats and oils are often present as reserve substance in many reproductive spores, as in oospores, zygosporcs, ascospores, and the like. Large quantities are also often present in the mycelium, as in *Lactarius deliciosus*, which contain 6 per cent. (5.86 per cent.). Fat is, as a rule, not entirely absent from any species of fungus. Flückiger gives the fat content of the sclerotium of *Claviceps purpurea* as 35 per cent. The mushroom *Agaricus campestris* has 0.18 per cent. and *Helvella esculenta* 1.65 per cent.

Resin occurs in fungi in the form of excretions, partly as infiltration of the cell walls, partly as contents of the living cells. The intense orange-yellow color of the caps and stipe of the *Agaricus (Pholiota) spectabilis*, according to Zopf, as also the pale yellow of the gills and the flesh of cap and stipe together with the ochre-yellow color of the masses of spores is due to the presence of a resin acid which is present as a hyphal cell content. Pigments of various kinds classified by Zopf are also found. Besides the important substances mentioned above, chemists have found coniferin, muscarin, trimethylamin (spores of *Tilletia caries*), ergotin, cholin, phallin, cholesterin. Several of these will be discussed in connection with the poisonous or non-poisonous character of certain of the fleshy fungi.

ENZYMES (ἔνζυμος, leavened, from ἐν, in and ζύμη, leaven, a term first suggested by Kühne for an unorganized ferment).—The study of the ferments, or enzymes, of the fungi and higher plants has thrown a flood of light upon their metabolic activity, for enzyme action is the strategic center of vital activity. Pasteur emphasized the rôle of micro-organisms as ferment producers, and that led to the classification of ferments into organized and unorganized. Since Buchner discovered zymase, ferments have been divided into endocellular and extracellular. Endocellular enzymes as those which cannot diffuse out of the cell, such as zymase, while extracellular enzymes are those which are capable of diffusion out of the cell, such as invertase. Hepburn defines an enzyme as a soluble organic compound of biologic origin functioning

as a thermolabile catalyst in solution. In connection with this definition, it is important to know that a catalytic agent is one which alters the rate of a reaction without itself entering into the final product (Ostwald, 1902), or which does not appear to take any immediate part in the reaction, remains unaltered at the end of the reaction and can be recovered again from the reaction product unaltered in quantity and quality.

Enzymes differ from ordinary inorganic catalysts in their sensitiveness to heat and light. They are destroyed at 100°C ., and most of them cannot be heated safely above 60°C .¹ The velocity of the reaction increases with a rise of temperature up to an optimum and as the temperature is increased above the optimum the enzyme is permanently inactivated. Enzymes retain activity even after exposure to action of liquid air. Light in its ordinary form in the presence of oxygen and ultraviolet light independent of oxygen are destructive to enzymes. Again, enzymes possess most of the important properties of colloidal solutions, such as their non-diffusibility. They are soluble in water, in dilute salt solutions, or in glycerin. They exhibit the phenomenon of adsorption.

An important discovery has recently been made which has thrown considerable light on the activity of enzymes, and that has been the stimulation exercised by certain substances which have been called *activators* and the inhibition exercised by other substances, which have been called *paralyzers*. The activators are in some cases simple chemical substances, such as acids, alkalis and salts, or they are complex bodies of unknown chemical character, but they have this in common that they can be separated from the enzyme by dialysis, and are not destroyed by heating. An enzyme may be rendered inactive by the removal of its activator, but it can be restored to activity by mixing again with this substance. In the case of some enzymes, the inactive substance, as it is formed in a cell may be called a *zymogen*, or *proferment*, but when associated with the activator the active enzyme is developed. An activator is inorganic. A *kinase* is a more or less complex organic body which activates a proferment.

Substances which reduce, or destroy, the activity of enzymes are called *paralyzers*, which may be formed as products of enzymatic

¹ HAAS, PAUL, and HILL, T. G.: An Introduction to the Chemistry of Plant Products, 1913: 340-341.

activity or be foreign substances. Acetic and lactic acids formed by enzyme activity will destroy the ferments producing them unless neutralized. Among foreign substances which act as paralyzers may be mentioned formaldehyde, mercuric chloride, alcohol, chloroform and hydrocyanic acid. Anti-enzymes are a class of substances, which are antagonistic to the action of enzymes. The distribution of the enzymes in the various groups of fungi including the slime moulds, bacteria and true fungi have been investigated by a number of zymologists. For example, *Monilia sitophila* may form maltase, trehalase, raffinase, invertase, cytase, diastase, lipase, tyrosinase and trypsin. Dox¹ has demonstrated in moulds, the following: protease, nuclease, amidase, lipase, emulsin, amylase, inulase, raffinase, sucrase, maltase, lactase, histozyme, catalase and phytase, and he has found that these enzymes are formed regardless of the chemic character of the substratum. Without going into all the details of the occurrence of enzymes in the fungi, the following classification of the principal enzymes found in the various groups may prove useful to the student.

CLASSIFICATION OF ENZYMES IN FUNGI

I. HYDROLYTIC ENZYMES.

(a) CARBOHYDRATE-SPLITTING ENZYMES (CARBOHYDRASES):

Amylase, or *Diastase*, which hydrolyzes starch to dextrin and maltose. The Koji fungus, *Aspergillus oryzae* (Taka-dia-*stase*).
Cytase, which hydrolyzes hemicellulose to galactose and mannose in *Botrytis*.

Inulase, which hydrolyzes inulin to levulose.

Invertase, which hydrolyzes cane sugar to dextrose and levulose.

Saccharomyces, *Fusarium*, *Aspergillus niger*.

Lactase, which hydrolyzes lactose (milk sugar) to dextrose and galactose. Kephir organism.

Maltase, which hydrolyzes maltose (malt sugar) to dextrose.

Saccharomyces octosporus.

Raffinase, which hydrolyzes raffinose to levulose and melitiose.

Aspergillus niger.

Trehalase, decomposing trehalose into a reducing sugar. *Polyporus sulphureus*.

¹ Dox, A. W.: Enzyme Studies of Lower Fungi. Plant World, 15: 40, February 1912.

(b) PROTEIN-SPLITTING ENZYMES (PROTEASES):

Pepsin, which hydrolyzes proteins to albumoses and peptones.
Trypsin, which hydrolyzes proteins to peptides and amino-acids in *Amanita muscaria* and *Boletus edulis*.

(c) UREA-SPLITTING ENZYMES (UREASES):

Urease obtained from *Micrococcus ureæ*, which hydrolyzes urea into ammonia and carbon dioxide.

(d) NUCLEASE, which splits nucleic acid.

(e) FAT-SPLITTING ENZYMES (ESTERASES and LIPASES):

Lipase in *Penicillium glaucum* and *Aspergillus niger*, also *Empusa*. *Phycomyces*, which break up fatty oils.

(f) GLUCOSIDE-SPLITTING ENZYMES:

Emulsin, which hydrolyzes amygdalin to glucose, hydrocyanic acid and benzaldehyde. Also such other glucosides as salicin, populin, coniferin which fungi are able to utilize.

2. FERMENTING ENZYMES.

(a) Alcoholic fermentation of glucose, levulose, mannose, etc., by *zymase* in yeasts.

(b) Lactic acid fermentation of lactose by lactic acid bacteria.

(c) Butyric fermentation of lactose by the butyric acid bacteria.

3. CLOTTING ENZYMES (Coagulation, Curdling).

Rennin (Chymosin), which curdles milk. *Bacillus mesentericus vulgatus*.

4. OXIDIZING ENZYMES.

(a) OXIDASES, which oxidize alcohols to acids, e.g., the action of *Mycoderma aceti*, etc.

(b) TYROSINASE. *Russula nigricans* and species of *Boletus*, *Lactarius*, etc.

(c) PEROXIDASES, which set free oxygen from hydrogen peroxide, causing this substance to blue guaiacum resin.

(d) CATALASE, which decomposes hydrogen peroxide with the evolution of molecular oxygen.

In concluding this brief study of the enzymes it may be stated that they can be detected by chemic, bacteriologic, serologic and histologic

means. Details of the occurrence of the above enzymes will be found in the books noted in the footnote below.¹

CHEMOTAXIS

The attraction or repulsion of motile microorganisms by chemical stimulants known as *chemotaxis* is found in the activity of the zoospores of the OOMYCETALES and in the growth of the hyphæ of fungi in general toward or away from the stimulus. To these phenomena the names of *positive and negative chemotropism* have been given. The thorough investigations of M. Miyoshi with *Aspergillus niger*, *Mucor mucedo*, *Penicillium glaucum*, *Phycomyces nitens*, *Rhizopus nigricans* have shown that the following substances act as powerful stimulants: ammonium phosphate, asparagin, dextrin, saccharose and glucose. The threshold value (marginal limit) or minimum quantity capable of producing a chemotactic effect was ascertained by Miyoshi as 0.01 per cent. in the case of glucose acting on *Mucor mucedo*. On gradually increasing the dose, a second limit is reached where repulsion occurs. The entrance of fungi into leaves and the growth of hyphæ along certain lines inside of the host tissue and the formation of haustoria are perhaps all indications of chemotropic response.

¹ BAYLISS, W. M.: The Nature of Enzyme Action (Monograph on Biochemistry). Longmans, Green & Co., 1914.

GREEN, J. REYNOLDS: The Soluble Ferments and Fermentation. Cambridge at the University Press, 1899.

HAAS, PAUL and HILL, T. G.: An Introduction to the Chemistry of Plant Products. London, Longmans, Green & Co., 1913.

HARDEN, ARTHUR: Alcoholic Fermentation (Monograph on Biochemistry). London, Longmans, Green & Co., 1914.

LAFAR, FRANZ, TRANSL. BY SALTER, CHARLES, T. C.: Technical Mycology, ii, Pt. 1: 61-65.

MARSHALL, CHARLES E. and others: Microbiology. Philadelphia, P. Blakiston's Son & Co., 1911

OPPENHEIMER, CARL: Die Fermente und ihre Wirkungen. Leipzig, 1903.

VERNON, H. M. Intracellular Enzymes. London, John Murray, 1908.

CHAPTER VII

GENERAL PHYSIOLOGY OF FUNGI

The influence of light on the development of the EUMYCETES has been investigated by a number of workers. The influence of light on the direction of growth is known as phototropism. On account of the contradictory evidence of earlier investigations, Friedr. Oltmanns experimented with *Phycomyces nitens* using a powerful electric arc light. He found that *Phycomyces* behaved positively phototropic under weak illumination, but negatively so under a powerful light. It remained aphototropic with an intermediate illumination, and in young sporangial hyphæ with gray sporangia, a given degree of illumination caused attraction, while with older sporangiophores with blackened sporangia repulsion was noticed. The germination of the spores of such fungi, as *Penicillium glaucum*, *Trichothecium roseum*, *Fusarium heterosporium*, *Rhizopus nigricans*, does not seem to be affected by light; while von Wettstein found that light retarded the germination of the spores of *Rhodomycetes Kochii*. The evidence as to the influence of light on the vegetative development seems to be contradictory. J. Schmitz found that *Sphæria carpophila* grew better in the dark than in daylight. G. Winter found *Peziza Fuckeliaqua* to cease growth in the dark and the fungus perishes if light be long excluded. Mac Dougal¹ experimented with *Coprinus stercorearius*. He found that it developed a much greater length than the normal in darkness, but the fruit bodies remained in a rudimentary or incomplete stage. After growth had proceeded in this manner for some time the illumination of the body was followed by the production of fruit bodies in a manner demonstrating most conclusively that the action in question was due to a purely stimulative action of light, since the rays did not participate in any synthesis of material.

The rate of cell reproduction does not seem to be influenced by the presence or absence of light. In many fungi, the formation of a

¹ MAC DOUGAL, D. T.: The Influence of Light and Darkness upon Growth and Development. Memoirs of the New York Botanical Garden, ii (1903: 279).

fructification does not seem to be affected by the light conditions, but here the evidence is contradictory, some fructifications being formed better in light than in the dark and vice versa. Kolkwitz after eliminating various sources of error of earlier experimenters found that in his cultures of *Aspergillus niger* and *Oidium lactis* that considerable acceleration of respiration is experienced with a brief illumination by a powerful electric arc. Koernicke¹ finds that Roentgen rays inhibit the growth of fungi with prolonged action.

Luminosity of Fungi.—The luminosity of wood and decaying logs in the forest is associated with the mycelia of certain fungi. The phenomenon is connected frequently with gill-bearing fungi, such as *Agaricus*, *Armillaria mellea*, *Pleurotus olearius*, and as determined by Molisch with the two ascomycetous fungi, *Xylaria hypoxylon* and *X. Cookei*. In order to prevent any error arising in the experiments through the presence of luminous bacteria, Molisch² grew *Armillaria mellea*, *Xylaria hypoxylon*, *X. Cookei*, *Mycelium X.* in pure cultures, the latter succeeding well on bread. He found that under such conditions the plants became phosphorescent. Such phosphorescence is connected with a supply of oxygen and is not due to the separation of some luminous substances, but is intracellular in its origin.

Liberation of Spores.—The spores of the gill fungi (HYMENOMYCETES) are very adhesive, when freshly set free. As a result of this, special arrangements are found for the liberation of the spores from the surfaces of the gills and the hymenial tubes. Paraphyses between the special conidiophores known as basidia serve to increase the spaces between the spores, preventing contact and allowing a freer fall of the spores. The arrangement of the gills is such as to economically increase the spore-bearing surface, and, therefore, the total number of spores that a fruit body can produce. By various growth movements of the cap and fruit stalk, the spore-bearing surface is placed in the best possible position for the liberation of spores. The spores liberated from the gills on the under surface of a pileus placed over a horizontal sheet of paper fall vertically downward and form a spore print, which consists of radiating lines corresponding to the inter-lamellar spaces. The number of spores set free by large fruit bodies is prodigious. A specimen of the mushroom *Agaricus*

¹ KOERNICKE, MAX: Ber. d. deutsch. Bot. Ges., 1904: 22, 148.

² MOLISCH, HANS: Leuchtende Pflanze, 1904: 25-46.

(*Psalliota*) *campestris* with a diameter of 8 cm. produced 1,800,000,000 spores, one of *Coprinus comatus* 5,000,000,000 and one of *Polyporus squamosus* 11,000,000,000 spores. Buller has estimated that a large fruit-body of the giant puffball *Lycoperdon bovista* (40 × 28 × 20 cm.)

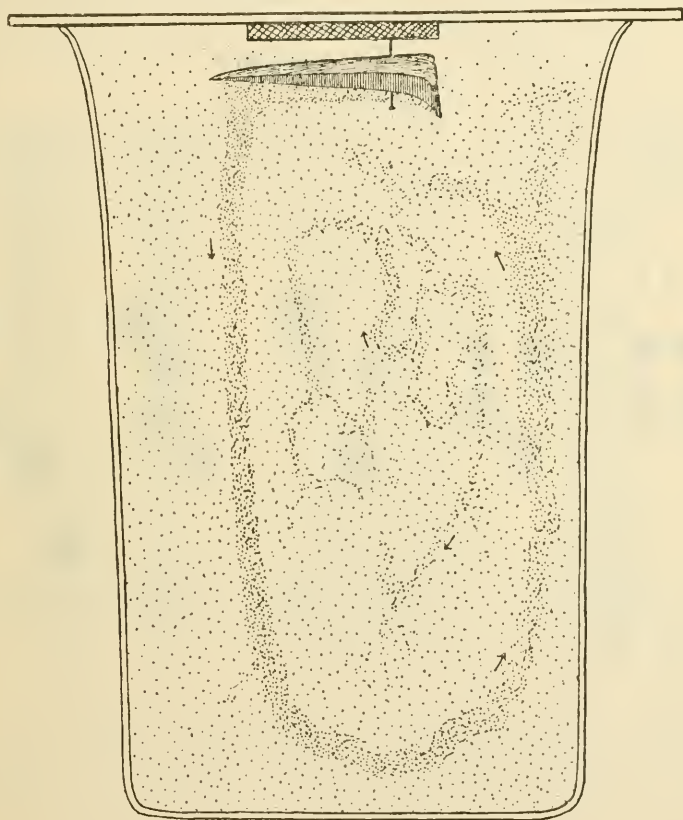

FIG. 17.—Diagram of the discharge of spores from a fruit-body of *Polystictus versicolor* as seen by a beam of light. A stream of spores is carried round within the beaker very slowly by convection currents and recorded. Reduced about 2/3. (After Buller: *Researches on Fungi*, 1909: 97.)

contained 7,000,000,000,000 spores, or as many as 4000 mushrooms of the size above mentioned.

Spores dropping from any fruit body which is suspended in a closed glass chamber can be seen in clouds, or individually, without the

microscope by concentrating a beam of light upon them (Fig. 17). This is a simple method of examining the discharge of spores from the mushroom. It can be used conveniently with the xerophytic fruit bodies of *Lenzites betulina*, *Polystictus versicolor*, *Schizophyllum commune* at any time in the laboratory by keeping them dry for months and reviving them by placing them in a jar with wet cotton. They quickly revive and begin to shed their spores in six hours and this discharge continues for some days.

Ordinarily, spore discharge from any fruit body is a continuous process, but if placed in hydrogen, or carbon dioxide, the liberation of spores ceases quickly, demonstrating that oxygen is necessary. Ether and chloroform act similarly to the gases above mentioned. The

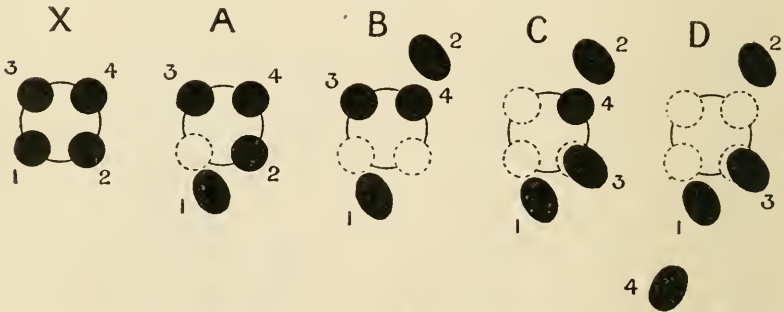

FIG. 18.—The successive and violent discharge of the four spores from the basidium of a mushroom *Agaricus (Psalliota) campestris*. X, The basidium with four ripe spores; A, B, C, D, successive stages of the discharge of spores 1, 2, 3, 4 respectively. (After Buller, *Researches on Fungi*, 1909: 144.)

special conidiophore, or basidium, usually bears four spores which are discharged successively, each spore being shot out violently by the pressure of the cell sap upon the wall of the basidium and perhaps also on the spore wall within a few seconds or minutes of one another (Fig. 18). The rate of the fall was observed by Buller, who used a horizontal microscope and a revolving drum to record accurately the rate of their fall. The rate of fall of the spores of gill fungi ranges from 0.3 to 6.0 mm. per second. It varies with the size, specific gravity and the progress of desiccation of the spores. Buller found the relatively small spores of *Collybia dryophila* in dry air to fall at an average rate of 0.37 mm. per second while the relatively large spores of *Amanitopsis vaginata* in a saturated chamber attained a speed of 6.08 mm. per

second and the spores of the common mushroom shortly after leaving the cap fall at the rate of 1 mm. per second approximately.

The violent discharge of the spores prevents the adhesive spores from massing together and from sticking fast to the gill surface. At first the spore is shot out horizontally, then under the influence of gravity, it describes a sharp curve and then falls vertically. The path described by the falling spore has been appropriately called a

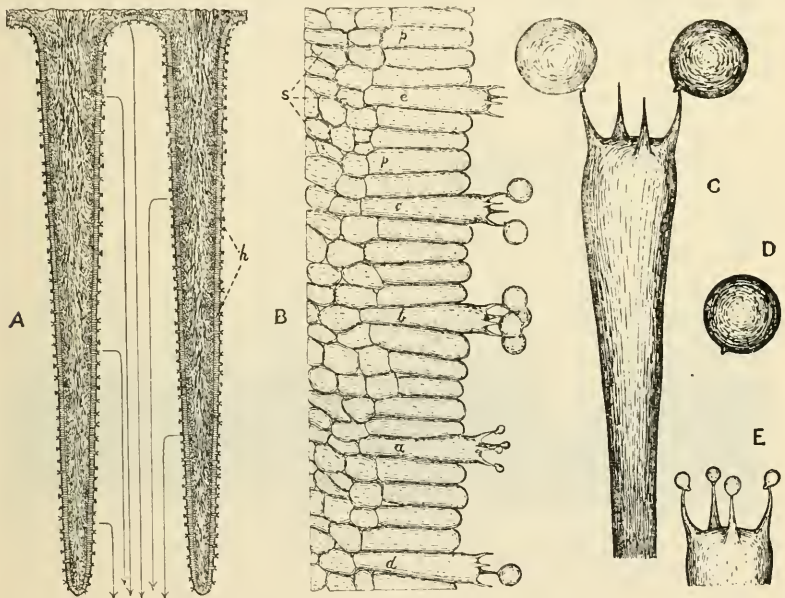

FIG. 19.—*Amanitopsis vagineta*. Relations of spores to the fruit-body. A, Transverse section through two gills, *h*, basidia projecting, the arrows show spore parts (sporabola), Magn. 15; B, vertical section of hymenium and subhymenium, *c*, paraphyses, *a-c*, basidia stages, Magn. 370; C, isolated basidium with two basidiospores; D, discharged spore; E, basidium, Mayer, 1110. (After Buller, 1909: 165.)

sporabola (Fig. 19). There are two distinct types of fruit bodies as to spore production and spore liberation. These are the *Coprinus comatus* and the mushroom types. The deliquescence, or melting of the fruit bodies of the Coprini is a process of auto-digestion and it assists mechanically in the discharge of the spores. Spore discharge precedes deliquescence. The spores are set free from below upward and by auto-digestion those parts of the gills are removed from which the spores have

been shed, thus permitting the opening out of the cap and the freer discharge of the remaining spores. The discharged spores are conveyed by the wind (Fig. 20). The mushroom type is the usual kind where the spores are discharged without deliquescence.

The spores of *Bulgaria*, *Gyromitra*, *Peziza* and others of the ASCOMYCETALES are scattered by the wind, but those of *Ascobolus immersus* and *Saccobolus* are dispersed by herbivores. The spores of *Peziza repanda*, according to Buller, are shot up into the air to a height of 2 to 3 cm. and leave the spore sac (*ascus*) together, but

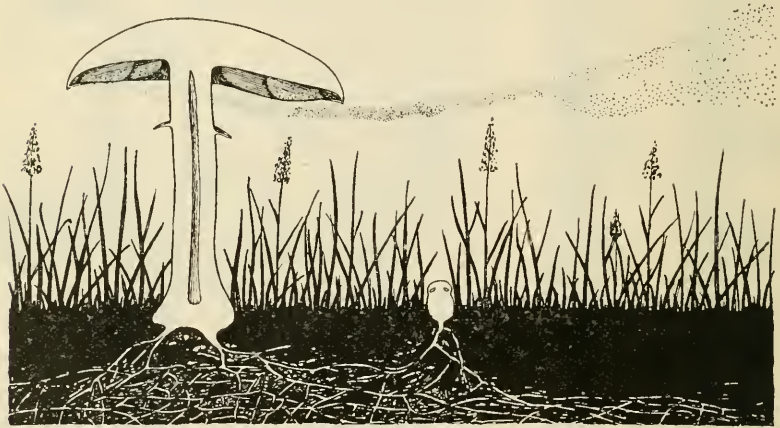

FIG. 20.—Semidiagrammatic sketch in a field with horse mushroom, *Agaricus* (*Psalliota*.....) *arvensis*, showing liberation and discharge of spores horizontally and from velum. Reduced to $\frac{1}{2}$. (After Buller, *Researches on Fungi*, 1909: 218.)

separate as they leave the ascus mouth. Puffing is due probably to a stimulus given to the protoplasm in contact with the ascus lid, and it is observed when poisonous substances are applied such as iodine mercuric chloride, silver nitrate, copper sulphate, sulphuric and acetic acids are used. With some of these forms the ascus may be considered as a squirting apparatus by which a jet of spores leaves its mouth. The writer¹ noted the puffing of the spores in *Peziza badia* when the large saucer-shaped fruit bodies were held in the hand. At intervals of several minutes the puffing took place.

Ascobolus immersus as a coprophilous (dung-inhabiting) fungus has

¹ HARSHBERGER, J. W.: *Journ. of Mycol.*, 8: 158, October, 1902.

special adaptations: (1) the protrusion of the ripe asci beyond the general surface of the fruit body; (2) the diurnal periodicity in the ripening of successive groups of asci; (3) the positive heliotropism of the asci; (4) the considerable distance to which the spores are ejected (sometimes 30 cm.) with which is associated; (5) the large size of the asci and spores; and (6) the clinging of the eight spores together, while describing their trajectory through the air. The forcible explosion of the sporangio-phore of *Pilobolus crystallinus* by which the whole sporangium is discharged a considerable distance into the air is due to the tension exerted by gases and water vapor within the swollen sporangiophore.

The escape of biciliate zoospores (swarm spores) in such genera of aquatic fungi as *Achlya* and *Saprolegnia* is through a terminal pore in the zoosporangium. It appears that the discharge is associated with the motility of the cilia. In the moulds (MUCORACEÆ), the sporangial wall which is coated with minute particles of calcium oxalate becomes soluble in water at maturity and the intersporal substance swells up assisting in the liberation of the spores. The entire inner peridium about the size of a pin's head is forcibly ejected in the gasteromycetous fungus, *Sphærobolus stellatus*, and this is due to the unequal tension of the different peridial layers.

The disposal of spores and conidia is facilitated by water in the case of the motile zoospores of such fungi as *Achlya prolifera*, *Phytophthora infestans* and *Saprolegnia ferax*, where cilia come into play. Many spores are no doubt carried passively by water currents. Wind is, however, one of the chief agents in the distribution of fungous spores, such as those of the puffballs, the rusts and the moulds, although the distance that such spores are carried is probably exaggerated. Flies, which feed upon the strong-smelling slime in which the minute spores of such fleshy fungi as *Mutinus caninus*, *Icthyophallus impudicus* are imbedded, assist in the carriage of such spores and those of ergot (*Claviceps purpurea*) in the *Sphacelia* stage, where viscid drops exude that are attractive to flies, and although some flies are killed by it, yet sufficient escape to carry the spores. Slugs and snails by crawling alternately over diseased and healthy plants, probably disseminate spores. That birds serve as distributors of spores is indicated by the studies of Heald with the chestnut blight fungus, *Endothia parasitica*, in which he found that a single downy woodpecker carried as many as 657,000 pycnospores. Certain subterranean fungi such as truffles are

eaten by rodents attracted by the strong smell that they possess and probably the mammal is instrumental in the spread of the spores.

Many of the coprophilous fungi have spores which pass through the alimentary canals of different animals without being destroyed and germinating in the dung, or manure from such animals, they propagate the species. *Pilobolus crystallinus* is one of them. The sporangia, which are shot off from the sporangiophore, adhere to blades of grass, which are eaten by horses, and later the fungus makes its appearance on horse manure. The spores have passed through the horse apparently unaffected and more readily germinable. Man with his agricultural implements is concerned with the spread of fungous spores. Güssow states that a threshing machine, which has been used for threshing smutted wheat, is infested so fully with spores that any grain subsequently threshed, unless the machine is sterilized properly after use, will become liable to infection.

CHAPTER VIII

ECOLOGY OF FUNGI

As fungi are either saprophytes or parasites, their life history is bound up with the substratum on which the saprophytes are found and with the host plant upon which the parasite lives, yet there are many diverse forms of saprophytic fungi and the greatest variety of fungous parasites. Of special interest in connection with the ecology of fungi are the organs by which various fungi are tided over periods of drought, inclement seasons, or during the winter's cold. These organs are compacted masses of hyphæ of a rounded, globular, or ellipsoidal form ranging in size from those that are almost microscopic to those which are the size of a small canteloupe. These tuber-like masses of hyphæ in a resting state are known as sclerotia (Gr. *σκληρός*, hard). They are found in a great many fungi, as commonly in the ergot, *Claviceps purpurea*, and the lettuce drop, *Sclerotinia libertiana*, which forms sclerotia that may reach a length of 3 cm. in exceptional cases. These sclerotia are obtained readily in culture tubes with beerwort agar, or glucose agar, as culture media. From the sclerotium later arises the stalked fruit body, or apothecium. *Cordyceps militaris* is a fungus which attacks the larva of insects. Its mycelium penetrates the insect's body and later in the *Isaria* form produces aerial hyphæ which cut off conidiospores. The growth of the mycelium is such as to penetrate to all parts of the larva filling it up as if it were stuffed with cotton.

The mass of hyphæ is converted into a sclerotium and the larval body is mummified, but still retaining its original external form. Later, the next spring, a stiff-stalked stroma arises with an enlarged extremity in which the perithecia with their asci- and ascospores are formed. Later the needle-shaped ascospores are set free and by cutting off conidiospores reproduce the disease. *Cordyceps (Torrubia) ophioglossoides* is parasitic upon an underground truffle, *Elaphomyces muricatus*, Fig. 21). The stroma is erect, yellow and club-shaped at the extremity. Perithecia, asci- and ascospores are borne in the swollen part of the stroma. The fungus which discharges its spores above ground finds the

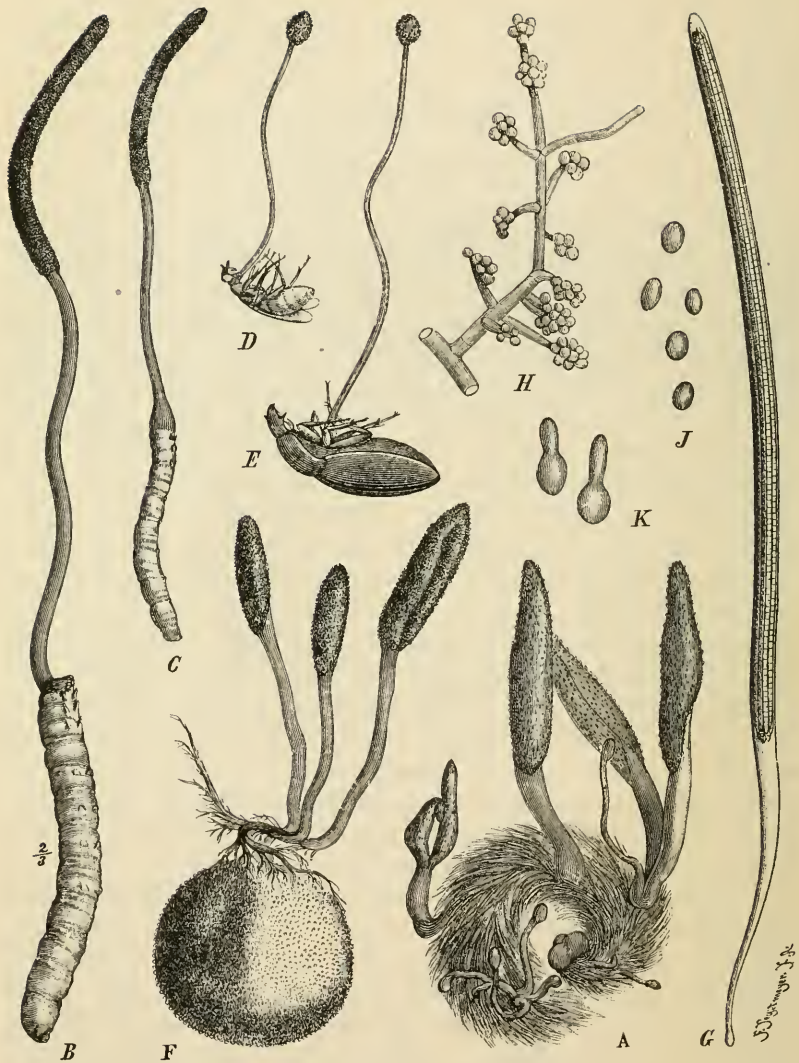

FIG. 21.—A *Cordyceps militaris*; B, *Cordyceps Hugelii* on a caterpillar; D, *Cordyceps sphaerocephala* on a wasp; E, *Cordyceps cinerea* on a beetle; F–K, *Cordyceps ophioglossoides*, F on a deer truffle; G, ascus; H, conidiophore; J, conidiospores; K, germinating spore. See *Die natürlichen Pflanzenfamilien* I. 1, p. 368.

underground truffle in the following manner. When the spores germinate, they give rise to hyphæ which grow over a densely cespitose, common moss, *Mnium hornum*, which develops a large number of feeding rhizoids, that penetrate the soil to the depth at which *Elaphomyces* grows. The mycelium of *Cordyceps* not only covers the aerial portions of the moss, but follows the rhizoids underground until they reach the underground truffle over which the moss may happen to grow. Botanists searching for *Elaphomyces* always know where to look for it by the presence of the *Cordyceps* hyphæ, on the moss *Mnium hornum*. There is a black beetle, a native of France¹ with a pale, velvety abdomen, known as *Bulboceras gallicus*, about as large as a cherry stone. By rubbing the end of the abdomen against the edge of the wing cases it produces a gentle chirping sound. The male has a horn on his head. This insect burrows in the soil among the trees of the pine forests and is nocturnal in its habits. It descends vertically into the soil in search of the underground truffle-like fungus, *Hydnocystis arenaria*, upon which the insect *rabassier* feeds. The fungous fruit body is about the size of a cherry with a reddish exterior covered with shagreen-like warts. The beetle, which feeds upon *Hydnocystis arenaria* and *Tuber Requeni* one of the truffles, locates the fungi by a subtle sense of smell. The human truffle hunter finds these underground by the burrows which the beetles make in digging for their chief source of food and he usually finds groups of these fleshy funguses directly beneath the openings of the beetle holes.

Rozites gongylophora is a gill fungus which is raised as a fodder by leaf-cutting ants in their subterranean passageways in the tropics of South Brazil.

On a visit to the Berlin Botanical Garden in 1898, the writer noted the following remarkable examples of sclerotia-bearing fungi: *Polyporus sapurema* A. Möller (Fig. 92, Teil I, Abt. 1**, Die natürlichen Pflanzenfamilien, p. 171). The sclerotium is over 30 cm. in diameter and weighs at least 20 kg. It is furrowed and roughened and leather colored. A specimen from Blumenau, Brazil, developed in the Victoria house of the Berlin Garden four large pilei in August and September, 1897. *Polyporus mylittæ* found in Australia produces a sclerotium (*Mylitta australis* Fr.), which as "native bread" is used as food by the natives. *Polyporus tuberaster*, which grows in the mountains

¹ FABRE, F. H.: Social Life in the Insect World, 1912 217-237.

of Italy, develops a large edible sclerotium called by the natives *pietra fungosa*. The sclerotium of *Polystictus soccer* (Fig. 94 A, Teil I, Abt. 1**, Die natürlichen Pflanzenfamilien, p. 177), known as *Pachyma malacense*, is of variable shape, 8 to 10 cm. long, brownish red externally with a white interior. It is found in the Malay Archipelago. These are a few of the true sclerotia which probably includes the "tuckahoe" of the North American Indian, *Pachyma cocos*.

Living on limbs, twigs and the leaves of the beech in the deep shade of the forest is found a scale insect (*Schizonema imbricator*),¹ which is covered by a woolly coat consisting largely of a waxy secretion from the body. This woolly material is quite abundant and where the insects live in masses together the entire limb, or leaf surface has a downy white appearance. The abdomen of the insect moves constantly with a jerky motion and the cottony material is, therefore, constantly agitated. The insects secrete a honey dew so copiously that it runs down to the leaves beneath and to the ground. Upon this honey dew and the dead bodies of the scale insect, a pyrenomycetous fungus, *Scorias spongiosa*, lives. It grows as a spongy mycelium consisting of much-branched, rigid, septate hyphæ with the strands glued together by a mucilage. Pyriform perithecia, long-necked spermogonia and pycnidia are formed from the mycelium, which is saprophytic on the products of the insect's body.

The anther smut of the caryophyllaceous flowers occurs in America and Europe on *Cerastium viscosum*, *Saponaria officinalis* and *Silene inflata*, and on species of *Dianthus*, *Lychnis*, *Melandrium*, *Stellaria*, etc. The spores of this smut replace the pollen grains in the anthers of these plants and when the flowers open a violet smut dust is discharged from the anthers instead of the pollen. Female flowers of *Melandrium* attacked by the fungus show a marked morphologic differentiation in the development of mature stamens out of staminal rudiments. These anthers are invaded by the fungus and in them the parasite fructifies.

The formation of galls is a marked feature of the ecology of fungi. One form of these malformations is seen in the witches' broom (hexen besen) which are due to the attack of a number of species of *Exoascus* on different forest trees. The branchlets are clustered into broom-like masses with leaves that are somewhat altered in shape and fall earlier

¹ HARSHBERGER, J. W.: JOURNAL of Mycol., 8: 160, October, 1902.

than those on normal twigs. 'Witches' brooms' are found on such coniferous trees as the white cedar in New Jersey and are due to *Gymno-*



FIG. 22.—Black knot of plum, *Plowrightia morbosa*, on beach plum, *Prunus maritima* Nantucket, August 17, 1915.

sporangium Ellisii, a rust fungus. These malformations occur on the hackberry, but on this tree they are due to the attack of a mite *Phytoptus* followed by a fungus. Plum pockets are a form of gall in which

the fruit is enlarged by the attack of the fungus at the expense of the stone which fails to develop. The hollow galls on the plum are due to *Exoascus pruni*. The so-called cedar apples on our red cedar trees in the spring are caused by the attack of an annual rust fungus, *Gymnosporangium juniperi-virginiana*, and from the surface of these apples two-celled spores arise. The white rust of cruciferous plants, *Cystopus candidus*, produces blisters on the leaves and stems of shepherd's purse. The black knot of the plum is a tumor-like swelling of the branches of plum trees due to the attack of an ascomycetous fungus, *Plowrightia morbosa* (Fig. 22). Large swellings on oak trees the size of a man's head and over are caused by a fungus, *Diachæna strumosa*, and some of these swellings may be the size of a large pumpkin. Galls due to insects are frequent on plants, but a discussion of them is extralimital.

According to conditions of environment, we may briefly treat of fungi as hygrophytic, mesophytic and xerophytic forms. The hygrophytic forms include the aquatic fungi, such as *Achlya*, *Monoblepharis*, *Saprolegnia* and other genera which live and carry on their reproduction in water. Perhaps to this group would belong a fungus of the genus *Cyttaria*, which was found by Darwin in the beech (*Nothofagus*) forests of southern Patagonia. The beech trees grow in cold, wet valleys completely barricaded by great mouldering trunks of former beech trees on which the globular, bright yellow fructification occurs and which is eaten by the Fuegians.

The mesophytic forms include many of the common fleshy gill fungi that live in our woods and forests, appearing in surprisingly great numbers after a spell of wet weather. Here we might include species of *Amanita*, *Boletus*, *Russula*, and *Clavaria* and others which are not infrequent, while in our meadows occur mushroom and coprini. Three conditions seem favorable to their growth: abundant leaf mould, warmth and abundant moisture.

The habitats of the fleshy fungi are of general interest. *Collybia platyphylla* develops its fruit bodies on the shaded side of decaying logs. The fairy-ring fungus, *Marasmius oreades* (Fig. 23) produces its sporophores in lawns in the form of rings long known as fairy rings. Frequently grassy spots are enclosed by the circle of toadstools which are several feet in diameter. The fruit bodies of *Pholiota adiposa* (Fig. 24) grow from wounds in living trees.

In forest operations the slash, when scattered, rots more rapidly than when piled. This is due to the fact that two types of fungi

are active in rotting the brush, one set entering the limbs and branches above the ground and the other gaining access to the brush actually in contact with the soil. Brush is rotted at the top when piled with one group of fungi and at the bottom by another group, while the middle of the pile, not in contact with the soil and yet protected from the sunlight, apparently will not rot to any extent until the



FIG. 23.—Fairy ring formed by *Marasmius oreades*, an edible toadstool. (From Wiley, *Foods and Their Adulteration*. After Coville, *Circular 13*, *Division of Botany*.)

pile disintegrates sufficiently to expose these central layers to the soil moisture on the one hand, or to the sunlight on the other. Four fungi cause rotting of oak slash in Arkansas, viz., *Stereum rameale*, *S. umbrinum*, *S. versiforme* and *S. fasciatum*. Two fungi are responsible for the decay of short-leaf pine slash. They are *Lenzites sepiaria* and *Polystictus abietinus*.¹

The xerophytic forms are those which have corky or leathery fruit

¹Long, W. H.: Investigation of the Rotting of Slash in Arkansas. U. S. Dept. Agric. Bull. 496, Feb. 16, 1917; also Humphrey, C. J.: Timber Storage Conditions in the Eastern and Southern States with Reference to Decay Problems Bull, 510, U. S. Dept. Agric., May 17, 1917.

bodies growing on sticks and logs where they can dry up without any loss of vitality. They revive after a rainfall and resume the function of discharging spores and the discharged spores are capable of germina-

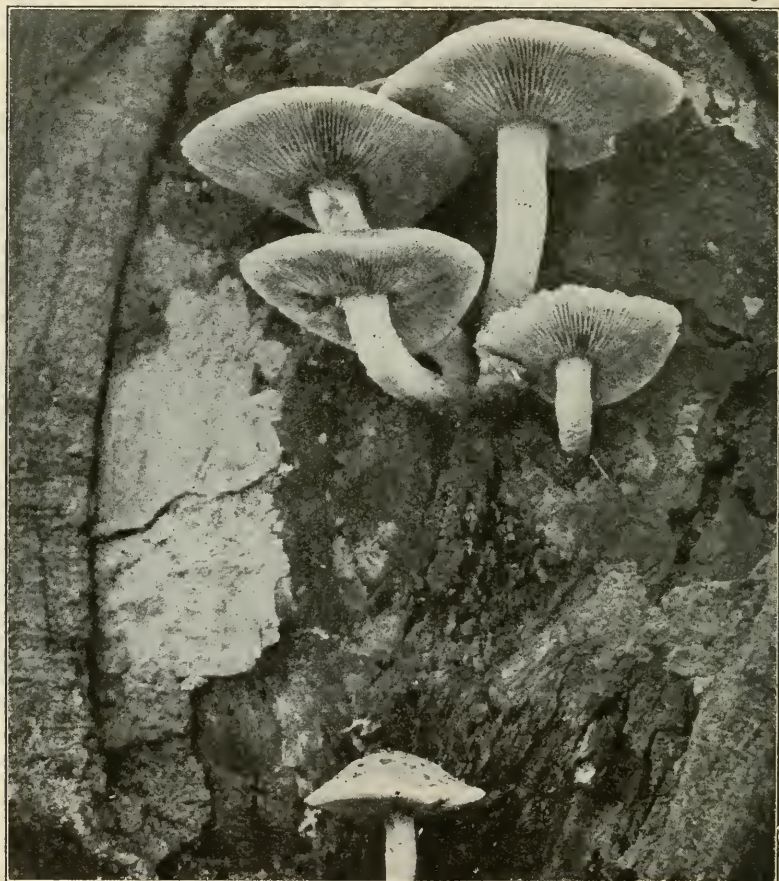

FIG. 24.—*Pholiota adiposa* growing from a wound in a living tree (edible). (After Patterson, Floraw and Charles, Vera K., Bull. 175, U. S. Dept. Agric., Apr. 25, 1915.)

tion. *Dædalea* (Fig. 202), *Polystictus* and *Stereum* are typical genera of the xerophytic log flora. Buller¹ describes the fruit bodies of *Schizophyllum commune* as possessing special adaptations for a xerophytic mode of

¹ BULLER, A. H. REGINALD: Researches on Fungi, 1909: 264.

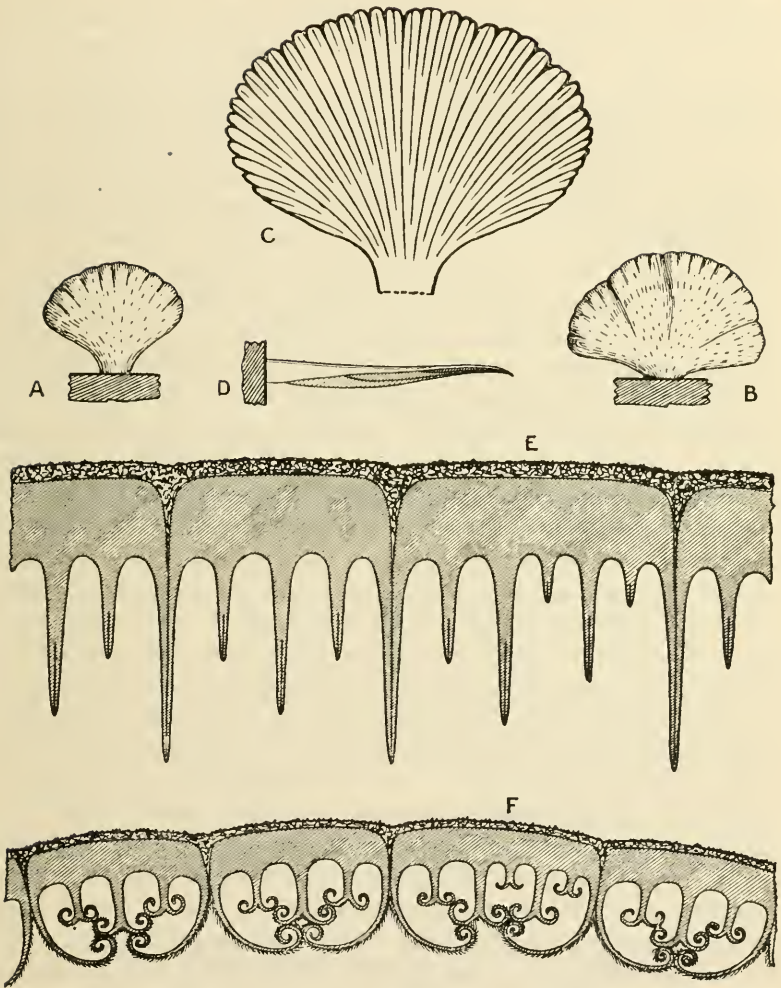

FIG. 25.—*Schizophyllum commune*, a xerophyte. A and B, fruit-bodies seen from above growing on wood, natural size. C and D, two fruit-bodies seen from below and in section; about twice magnified; E, section through pileus in wet weather showing gills split down their median planes; F, section of a dry pileus; E and F about 12 times natural size, (after Buller, *Researches on Fungi*, 1909: 114.)

existence (Fig. 25). "The gills are partially or completely divided down their median planes into two vertical plates. While desiccation is proceeding, the two plates of each of the longer and deeper gills bend apart and spread themselves over the shorter and shallower gills. When desiccation is complete, the whole hymenium is hidden from external view and the fruit body is covered both above and below with a layer of hairs (Fig. 25). The closing up of the fruit bodies at the beginning of a period of drought serves to protect the hymenium. A fruit body which retains its vitality even when dry for two years will revive again in a few hours and spores are discharged" (Fig. 25).

As it is not the purpose of this book to consider the so-called lichens in the classification which follows as distinct entities in which the lichen fungus and the lichen alga are in symbiosis forming a lichen thallus, it is important to describe the ecology of the actual relationship of the two plants to each other, as a matter of botanic interest. Danilov, Elenkin, Peirce and Fink have shown that the dual hypothesis, or that of mutualistic symbiosis, is untenable. A lichen is a fungus belonging to the orders ASCOMYCETALES, or BASIDIOMYCETALES, which lives during all or part of its life in parasitic relation with an algal host and also sustains a relation with an organic or an inorganic substratum. Having squarely assumed this position as to the true nature of what currently passes for a lichen, it is interesting to note that there are ten algæ known as lichen hosts: *Chlorococcum* (*Cystococcus*) *humicola*, *Palmella botryoides*, *Trentepohlia* (*Chroolepus*) *umbrina*, *Pleurococcus vulgaris*, *Dactylococcus infusionum*, *Nostoc lichenoides* (?), *Rivularia nitida*, *Polycoccus punctiformis*, *Gleocapsa polydermatica* and *Sirosiphon pulvinatus*. It is important to note, that although the larger number of the above are blue-green algæ, yet the two species of green algæ. *Chlorococcum humicola* and *Trentepohlia umbrina* form the hosts of many more lichens than all the others combined. Hence the student of these plants can study the algicolous fungi, mainly ASCOMYCETALES, a few BASIDIOMYCETALES, those parasitic upon algæ, as the lichens, while the non-algicolous fungi can be overlooked by the lichenologists. We can do no better than quote Bruce Fink,¹ who sums up the main arguments against mutualism and the

¹ FINK, BRUCE: The Nature and Classification of Lichens. I. Views and Arguments, *Mycologia*, iii: 231-269, September, 1911; II. The Lichen and its Algal Host, *Mycologia*, iv: 97-166, May, 1913.

advocation of the fungal nature of lichens, as follows: "Lichens commonly grow where there are free algæ of the same species as those parasitized by these lichens. The spores of the lichens germinate and attack the free algæ as other fungi attack their hosts. Lichens perform like other fungi on culture media and may be made to produce their reproductive organs on these media. Lichen spores also attack the algal hosts, when the spores and the algæ are introduced into cultures together; and the resulting lichen is normal and sometimes fructifies in the cultures. Algal hosts extracted from lichen thalli grow in cultures like free algæ of the same species grown on similar culture media. The researches of Elenkin and Danilov prove that lichen hyphæ absorb food from the algal host cells, which are killed by severe parasitism, or more probably by parasitism and saprophytism combined. The relation of the lichen to its substratum proves that higher lichens can take comparatively little food from it and must depend more than lower lichens upon the algal hosts; and this shows that the parasitism of the lichen upon the algal host has become more severe in the evolution of the higher lichens. Finally, the algæ parasitized by lichens are in a disadvantageous position with reference to carbon assimilation.

"Lichens are like other fungi with respect to vegetative structure and fruiting bodies. The bridges which connect lichens with other fungi are not few, but many. Since it is thoroughly demonstrated that the lichen is parasitic, or partly parasitic and partly saprophytic on the alga, there is no longer even a poor excuse for a 'consortium' or an 'individualism' hypothesis.

"The parasitism of lichens on algæ is peculiar in that the unicellular or the filamentous hosts are enclosed usually by the parasite, which carry more or less food to the host. The host inside of the parasite is placed in a disadvantageous position with reference to carbon assimilation and may depend, for its carbon supply, more or less upon material brought from the substratum by the parasite. Some algal individuals, not yet parasitized, may be found in most lichen thalli."

Lichen thalli are of three kinds: crustaceous, foliose and fruticose. The arrangement of the layers of the lichen fungus and its algal host varies in different lichens, but in *Sticta* the following are met in a vertical section of the thallus (Fig. 26):

(a) Tegumentary layer.

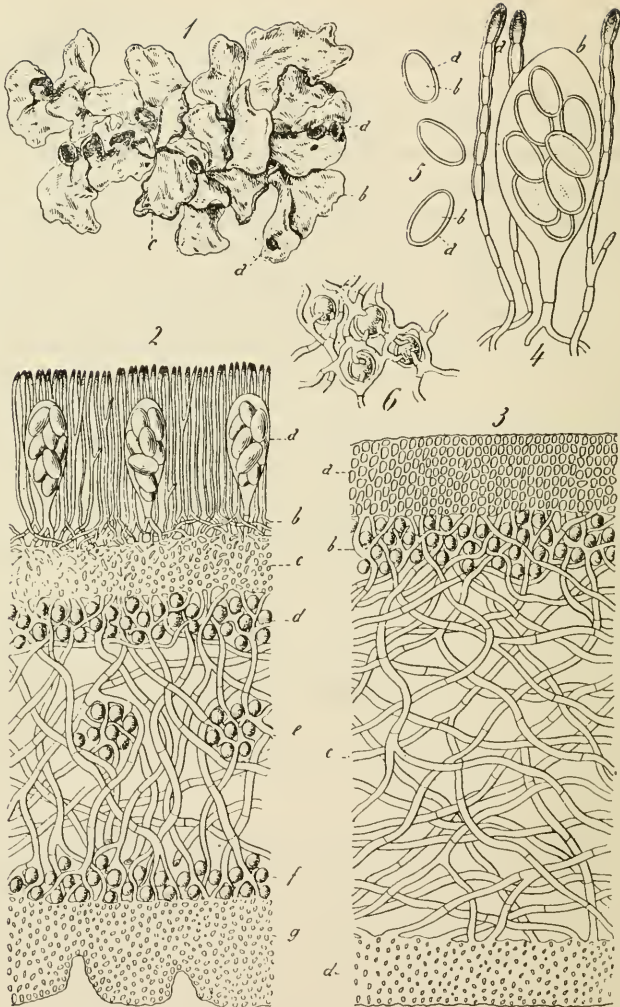

FIG. 26.—A foliaceous lichen, *Parmelia perlata*. 1, Plant slightly reduced in size; *a*, apothecia; *b*, lobe of thallus; *c*, patches of soredia; 2, longitudinal section of apothecium and cross-section of thallus; *a*, ascus; *b*, *c*, hypothecium; *d*, upper gonidial (upper algal) layer; *e*, medullary layer; *f*, lower gonidial layer; *g*, lower cortical layer; 1, 3, cross-section of vegetative thallus. (From Gager. After Schneider.)

- (b) Upper cortical layer.
- (c) Algal layer (gonidial layer).
- (d) Medullary layer.
- (e) Lower cortical layer.

The tegumentary layer consists of several rows of flattened hyphal cells extending at right angles to the underlying cortical cells which consisting of hyphal cells are pseudoparenchymatous, resembling the parenchyma tissue of higher plants. The algal layer contains the gonidia, or green plants, which act as hosts to the fungous hyphæ. The medullary layer which is thicker than the others consists of much elongated hyphæ forming a loosely interwoven tissue with large air spaces. The lower cortical layer is pseudoparenchymatous and from its lower surface rhizoids are developed. The apothecia and perithecia are the fruit bodies of the ascomycetous fungi which form the lichens. A vertical section through an apothecium of *Sticta* shows the following layers: (a) the epithecium, (b) the thecium consisting of the spore sacs (asci) and paraphyses, (c) the hypothecium or hyphal structure immediately below the thecium, (d) upper algal layer, (e) medullary layer, (f) lower algal layer, (g) cortical layer (Fig. 26).

Some of the fruticose lichens have a central core-like strand of hyphæ running through the medullary region which serves as supporting mechanic tissue as in *Usnea barbata*. The soredia are vegetative reproductive bodies consisting of from one to many algæ surrounded by continuous hyphal tissue and are common upon the upper surface and margins of most of the higher lichen thalli. Among the BASIDIO-LICHENES basidia are formed with basidiospores on sterigmata as in *Cora*, *Dictyonema*, *Laudatea*.

CHAPTER IX

FOSSIL FUNGI AND GEOGRAPHIC DISTRIBUTION

*Fungi in the Fossil State.*¹—All the known fossil fungi numbering over 400 species have been figured and described by Meschinelli in his "Fungorum fossilium omnium Iconographia" published in 1898. Zeiller in discussing the chronologic sequence of the groups of fungi states that representatives of the families CHYTRIDEACEÆ, MUCORACEÆ and PERONOSPORACEÆ have been found in the tissues of the higher plants preserved in rocks of lower Carboniferous and Permian ages. Many different plants extending from the Carboniferous period upward show various forms of the ASCOMYCETALES on leaves and in the tissues especially those of the stems. The fleshy fungi of the families AGARICACEÆ and POLYPORACEÆ have been found in deposits of tertiary age. Weiss has announced the discovery of a mycorrhiza in the root of a probable Lycopodiaceous plant of the lower Carboniferous strata. Where *Polyporus* and *Lenzites* occur, as in the brown coals, silicified woods occur which have been half destroyed by their mycelia.

GEOGRAPHIC DISTRIBUTION OF FUNGI

This important and interesting subject can be presented in the barest outline. The modern teaching of geography emphasizes home geography as a fundamental study. In following this suggestion in the investigation of the local fungi, it will be found that we must deal with distinct habitats, such as leaf mold, sandy soil, wet soil, decayed logs, tree stumps, living trees, living herbs and the like. The black mould, *Rhizopus nigricans*, is one of the commonest of fungi. It occurs on bread and other organic substrata, such as sweet potatoes, whenever the conditions are suitable for its growth. If horse manure is covered with a bell jar with wet paper inside, there develops first the gray mould, *Mucor mucedo*. This is accompanied or followed by *Pilobolus*

¹ SEWARD, A. C.: Fossil Plants, 1898: 207-222.

WEISS, F. E.: A Mycorrhiza from the Lower Coal Measures. Annals of Botany, xviii: 255 with 2 plates.

crystallinus, and this in turn by the white flecks of *Oospora scabies*. *Coprinus stercorarius* usually completes this series of coprophilous fungi generally found on horse dung. Sometimes the *Mucor* is parasitized by *Piptocephalis* and sometimes by *Chatocladium*. *Peziza coccinea* is attached to dead twigs buried in the forest leaf mould, and as it rises to the surface, it develops a long stipe with a crimson-red saucer-shaped apothecium at its extremity. *Russula emetica*, *R. virescens*, species of *Clavaria* and *Boletus* are regularly found beneath deciduous trees growing out of the forest litter. The puffball, *Scleroderma vulgare*, is found on the tops of old stumps in gregarious clusters. *Polyporus sulphureus* grows out of partly dead chestnut and oak trunks; while the hymenophores of *Armillaria mellea* are found clustered about the bases of trees beneath the bark of which the rhizomorphs will be found growing. A species of *Hydnum* was found a few feet above the ground on a beech tree and *Fistulina hepatica* attached to tree trunks, where the swollen base gradually blends with the straighter hole above. *Amanita muscaria* and *A. phalloides* grow in solitary splendor at the edges of woods and copses, while the habitat of the mushroom in open fields is quite distinctive.

The earth-star, *Geaster hygrometricus*, grows more frequently in sandy soil, where it spreads out its peridial segments.

The habitat of the local species of the lichen fungi is of interest. The brown-fruited cup cladonia, *Cladonia pyxidata*, grows on stumps and on the earth, while the scarlet-crested cladonia, *Cladonia cristatella*, is found on dead wood. The Iceland moss, *Cetraria islandica*, grows on the ground as also the reindeer-lichen, *Cladonia rangiferina*, in extensive masses. Another earth-inhabiting form is *Peltigera canina*. The trunks of trees are marked by the presence of *Parmelia perlata* and the fruticose bearded lichen, *Usnea barbata*. Smooth bark appears covered with runic character traced by the fruit bodies of *Graphis scripta*. The rock-dwelling lichens include *Physcia parietina* and the rock tripe (tripe de roche), *Umbilicaria* which grows on the outcrops of Octorara schists at the Gulph.

The distribution of the chestnut blight fungus, *Endothia parasitica*, is of more than local interest, although the agitation to control it started near Philadelphia. Apparently the fungus was introduced from China, where it has been found recently, with nursery stock into Long Island. From the neighborhood of New York City, it spread northeast,

northwest, west and southwest.¹ Now it is found in Connecticut, New York, throughout New Jersey, and as far west as the Alleghany mountains in Pennsylvania. In isolated areas, it occurs in Virginia and West Virginia, endangering the future of the chestnut tree in America (Fig. 27).

Wherever the cultivation of the higher plants extends, the fungi peculiar to these plants will be found, as the wheat rust, *Puccinia*

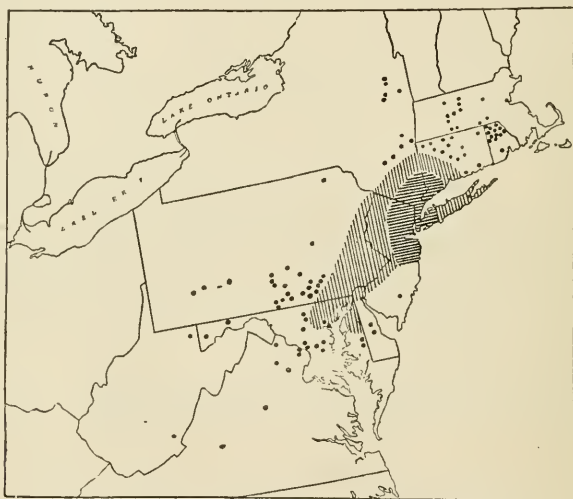

FIG. 27.—Map of the eastern United States showing distribution of chestnut blight disease in 1911. Horizontal lines indicate area with approximately all the trees dead; vertical lines approximate area where infection is complete; dots indicate advanced points of infection. (From Gager, after Metcalf, *U. S. Farmers' Bull.* 467.)

graminis, in Europe, America and Australia. The damping-off fungus, *Pythium de Baryanum*, which is death to seedlings, has been studied by German, English and American botanists, as a reference to the literature will show. The downy mildew, of the grape, *Plasmopara viticola*, apparently of eastern American origin, is found now in Europe and California, where it has become a serious pest.

The black knot, *Plowrightia morbosa*, was apparently at one time confined largely to the Atlantic seaboard and was particularly abundant in New England and New York. It has now spread across the northern

¹ Cf. Stevens, Neil E.: Some Factors influencing the Prevalence of *Endothia gyrosa*. *Bull. Torr. Bot. Club*, 44:127-144. March, 1917.

United States to the Pacific coast. Such diseases as the sooty mold of orange, *Meliola camellia*, and the brown rot of the lemon, *Pythiacystis citriophthora*, are confined to these last plants and to the regions where the citrus fruits grow. The anthracnose of the sycamore, *Gnomonia veneta*, is parasitic upon the leaves and shoots of the sycamore or plane tree, *Platanus occidentalis*, causing its leaves to dry up, as if bitten by early frosts. It seems to be more prevalent in the bottom of valleys, where the plane tree grows along streams, as here we find cold-air drainage. Sometimes after the first crop of leaves is lost, a second crop appears. Wherever the sycamore grows, *Gnomonia* may be expected. The so-called fly-cholera fungus, *Empusa musca*, is parasitic in flies and is present on these insects in Europe, even in the far north, in North America and South America (Argentina). The coprophilous fungus, *Basidiobolus ranarum* occurs on the dung of frogs in Europe and America. *Taphrina cærulescens* does not seem to be choice about its hosts, occurring as spots on the leaves of *Quercus cerris*, *pubescens*, *sessiliflora* in middle and southern Europe and on *Quercus alba*, *aquatica*, *coccinea*, *laurifolia*, *rubra*, *velutina* in North America. The hairy earth-tongue, *Geoglossum hirsutum*, is truly cosmopolitan, as it has been reported from all over Europe, North America, Java, Mauritius and Australia. The genus *Cyrtaria* with eight ascospores in each ascus includes six species. *C. Darwinii* and *C. Berterii* were discovered by Darwin in Patagonia. *C. Gunnii* occurs in Tasmania and *C. Harioti* in Terra del Fuego. None of the species, therefore, are found outside of the southern hemisphere (Fig. 28). The genus *Hypomyces* includes species which live parasitically, or saprophytically, on other fleshy fungi. *H. ochraceus* lives on species of *Russula* in Germany, England and North America; *H. chrysospermus* occurs on species of *Boletus* in Europe; *H. aurantius* on POLYPORACEÆ and THELEPHORACEÆ in Europe; *H. lateritius* on *Lactarius* in Europe and North America; *H. violaceus* with its tender small stroma and violet-colored fruit body lives on a slime mould *Fuligo septica* in northern Europe; *H. viridis* is found on species of *Lactarius* and *Russula* in northern Europe and North America; *H. cervinus* grows on HELVELLACEÆ and large PEZIZACEÆ in Europe; *H. fulgens* appears on the bark of pine trees in Finland and Sweden; *H. Stuhlmanni* is confined to *Polyporus bukabensis* in Central Africa; *H. chrysostomus* is reported from Ceylon and *H. flavescens* on a *Polyporus* in North America. *Hypomyces lactifluorum* planes down

the gill surfaces of the *Lactarius* *sp.* on which it grows, converting an otherwise grayish-white fruit body into a cinnabar-red one. It is found in the woods about Philadelphia, Pa. The fungi belonging to the family LABOULBENIACEÆ are included in 28 genera and approximately 152 species, and have been made known largely through the studies of Prof. Roland Thaxter of Harvard University. A few species are found in Europe, in the tropics of Africa, America and Asia, but North America is extraordinarily rich in specific forms. They occur on dipterous, neuropterous and coleopterous insects, especially those which live in damp places or in the water. The corn-smut *Ustilago maydis* is a parasite confined exclusively to the maize plant, *Zea mays*, and to the closely related if not identically the same grass the teosinte; *Euchlæna mexicana* as pointed out some years ago by the writer¹ as proof of the common origin of these two grasses. Wherever maize is cultivated the smut is found associated with it.

The rusts (UREDINEÆ) are among the most specialized of fungi in their parasitic habits, some species being confined to one or two hosts. They ascend with their host plants above the snow line on high mountains and toward the poles wherever flowering plants and ferns grow. Whole genera are confined, however, to certain regions. Thus the genus *Ravenelia* which lives on mimosaceous and cæsalpinaceous plants extends north to the 40° north latitude. Many rust fungi are identically the same in North America, north and middle Europe, and of the 500 species known from North America and 400 European rusts approximately 150 species are common to both countries. Only a few Mediterranean species are found in North America, as *Uromyces glycyrrhizæ* and *Puccinia Mesneriana*. A less number of species are common to North and South America. It is noteworthy that *Puccinia malvacearum* introduced into Spain from Chile in 1869 has in the forty-six years which have elapsed since its introduction into Europe spread over the world.

The genus *Exobasidium* includes 18 species of fungi which cause the formation of fleshy galls chiefly on plants of the family ERICACEÆ. Tabulated the principal species are:

Exobasidium vaccinii on *Vaccinium*, Europe, Siberia, America.

Exobasidium rhododendri on *Rhododendron*, Europe, America.

¹ HARSHBERGER J. W.: Cont. Bot. Lab. Univ. of Pa., 1901: 234.

Exobasidium ledi on *Ledum*, Finland.

Exobasidium andromedæ on *Andromeda*, Europe, North America.

Exobasidium azalæ on *Azalca*, North America.

Exobasidium antarcticum on *Lebetanthus*, Patagonia.

Exobasidium gaylussaciæ on *Gaylussacia*, Brazil.

Exobasidium leucothoes on *Leucothoë*, Brazil.

Exobasidium tauri on *Laurus*, Italy, Portugal, Canaries.

Exobasidium Warmingii on *Saxifraga aizoon*, Greenland, Tyrol, North Italy.

In closing this consideration of the geographic distribution of the fungi, the interest which attaches to it as a study may be best emphasized by giving in tabular form the distribution of the species belonging to a single family. The family CLATHRACEÆ includes eleven genera of highly specialized morphology.

FAMILY CLATHRACEÆ.

1. *Clathrus cancellatus*, Mediterranean Region, South England, North America.
Clathrus columnatus, North and South America.
2. *Blumenavia rhacodes*, Brazil.
3. *Ileodictyon cibarium*, Australia, New Zealand, South America.
4. *Clathrella chrysomycelina*, Tropic South America.
Clathrella pusilla, Australia, New Caledonia.
Clathrella kamerunensis, Cameroon.
Clathrella Preussii, Cameroon.
Clathrella crispa, Central and Tropic South America.
5. *Simblum periphragmoides*, Tonkin, Java, Ceylon, East Indies, Mauritius.
Simblum sphærocephalum, North and South America.
6. *Colus Mülleri*, Australia.
Colus hirudinosus, Mediterranean Region.
Colus Garciaë, Tropic South America.
Colus Gardneri, Ceylon.
7. *Lysurus mokusin*, China.
8. *Anthurus borealis*, North America.
Anthurus Clarazianus, Argentina.
Anthurus Woodii, Natal.
Anthurus Müllerianus, Australia.
Anthurus cruciatus, Tropic South America.

9. *Aseroë rubra*, New Zealand, Australia, Java, Ceylon, Tonkin, South America.
10. *Calathiscus sepia*, East Indies.
Calathiscus Puiggarii, South Brazil.
- 11 *Kalchbrennera corallocephala*, Africa, Cape, Natal, Angola, Cameroon, Zambezi Region.

CHAPTER X

PHYLOGENY OF THE FUNGI

One of the most consistent attempts at representing the phylogeny of the fungi has been made by Dr. O. Brefeld through his researches which were published in collected form in "Untersuchungen aus dem Gesamtgebiet der Mykologie." As these volumes are bulky ones, a student of Brefeld, Dr. F. von Tavel, has given a useful summary of the chief points in his teacher's system in a book published in 1892, entitled "Vergleichende Morphologie der Pilze." The phylogeny of the higher fungi, according to Brefeld, is based on the assumption, that there is an entire absence of sexual organs in all of those groups above the PHYCOMYCETES, but this view has been rendered untenable owing to the discovery of undoubted sexual organs among the ASCOMYCETALES and the discovery of nuclear fusions in some of the rusts, suggesting a sexual condition. However this may be, Brefeld and von Tavel hold that the PHYCOMYCETES are algal-like fungi and probably derived from algal ancestors.

The OOMYCETALES are not linked directly with any of the higher fungi, but the ZYGOMYCETALES through the former with sporangia and conidia have probably given rise to the HEMIASCI and directly through them to the ASCOMYCETALES. The forms of ZYGOMYCETALES with conidia above are phylogenetically connected in the Brefeldian system though the HEMIBASIDII with the BASIDIOMYCETALES. This in brief is an outline of the phylogenetic views of Brefeld, as expressed in a useful ground plan of the natural system of hyphal fungi by von Tavel.

The question is asked naturally, whether the origin of the fungi has been monophyletic, that is from a single ancestral form, or polyphyletic, from a number of distinct ancestors? This question can be answered only after an examination of the evidence. There are two orders of the PHYCOMYCETES, or algal fungi, namely, ZYGOMYCETALES and OOMYCETALES. As to the origin of these forms, the monophyletic view would have us derive the ZYGOMYCETALES from the OOMY-

CETALES, which have been derived in all probability from an alga like *Vaucheria* with oogonia and antheridia, where the male sexual organs are smaller than the female. To derive the ZYGOMYCETALES from such a group would necessitate that the sexual organs become of equal size.

Entomophthora is a connecting form where the sexual organs approach each other in size. This genus is then connected by insensible differences with the heterogamic hermaphroditic moulds where there is an appreciable difference in the size of the two cells that conjugate, the larger being the female, the smaller the male, as in *Absidia spinosa* and *Zygorhynchus heterogamus*. These are directly connected with the homogamic hermaphrodite moulds and these with the homogamic heterothallic forms. The polyphyletic view necessitates the derivation of the OOMYCETALES from a *Vaucheria*-like ancestor, and the ZYGOMYCETALES from a *Zygnema*-like ancestor, where conjugation of similar cells (gametes) is found. The polyphyletic origin of the fungi is emphasized by the adherents to the doctrine of the origin of the ASCOMYCETALES from red algæ, as there are three points of contact: *first*, sac fungi with highly developed trichogyne (sterilized archicarp) of the *Collema* type with red algæ-like certain existing forms; *second*, sac fungi with highly developed trichogyne of the *Polystigma* type; *third*, sac fungi with simple generalized copulating gametes of the *Gymnoascus* type. We are, however, not in the position to name any known red alga as the progenitor of the sac fungi, and it is far more reasonable to search for one in another fungous line, where, in the light of present-day knowledge, there are known forms with sexual organs very much like the sexual organs of simple, known forms of the Ascomycetales. We are not now in a position to name any known phycomycete as a probable ancestor, though the likelihood is that the original stock possessed phycomycetous characters, thus attributing a monophyletic origin to them. One of the most instructive forms suggesting a mode of transition from the PHYCOMYCETES to the ASCOMYCETALES, is *Dipodascus*. Its sexual organs are strikingly like those of certain MUCORACEÆ or PERONOSPORACEÆ in their young stages. The sexual organs can be recognized as antheridium and oögonium either from the same thread (homothallic) or from different threads (heterothallic). After absorption of the wall between the gametes, the fertilized oögonium (or zygote) grows out into an elongate stout ascus, or zyogametangium with the

production of numerous spores.¹ *Eremascus* also represents such a connecting form. From *Eremascus* by reduction forms like *Endomyces* arose which in two diverging series connects various ascomycetous fungal forms. One series shows sprout conidia, the other oidia. The yeast series, the *Exoascus* series are thus connected. Some would have us derive the LABOULBENIACEÆ from red algal ancestors, but another opposing view is that these unusual fungi have had a *Monascus*-like ancestor. The other branch leads to the Basidiomycetales where the most primitive forms have not typical basidia, as in the Hemibasidii, and which are connected with such primitive types as are included in the family. ENTOMOPHTHORACEÆ.² The differentiation of types within these large phyla will be dealt with as we proceed with a discussion of the various groups of PHYCOMYCETES and MYCOMYCETES.

¹ ATKINSON, GEO. F.: Phylogeny and Relationships in the Ascomycetes. Annals Missouri Botanical Garden, II: 315-376.

² Cf. ENGLER und PRANTL: Die natürlichen Pflanzenfamilien, I Teil Abt.: 60-63.

MASSE, GEORGE: A Text-book of Fungi, 1906: 182-195.

CHAPTER XI

MOULD FUNGI

SUBCLASS PHYCOMYCETES

The fungi of this subclass are distinguished by their siphon-like hyphæ, because these hyphæ are unicellular and multinucleate and suggest the algæ of the family SIPHONACEÆ to which *Vaucheria* belongs. Hence the fungi of the subclass PHYCOMYCETES ($\phi\upsilon\kappa\omicron\varsigma$, seaweed + $\mu\acute{\upsilon}\kappa\eta\varsigma$, a fungus) are usually designated as algal fungi. Although the absence of transverse septa in the hyphæ is used as a fundamental characteristic, yet in the formation of the reproductive organs transverse walls or septa cut these organs off from the rest of the vegetative mycelium. Transverse septa are found regularly in some of the genera, such as *Dimargaris*, *Dispira*, *Protomyces* and *Mucor*, so that the general statement above is modified by such exceptions. A fungus, *Leptomitus lacteus*, found in ditches and rivers shows a characteristic segmentation of the hyphæ, where through the deposit of a substance known as cellulose the lumen of the hyphæ is nearly closed, but at the point of constriction, a small pore remains through which the protoplasm passes.¹

There are genera of the family CHYTRIDIACEÆ, such as *Reessia* and *Rozella* in which the protoplasm during the vegetative state is not surrounded by a cell wall, but is naked, and amoeboid in the host cells. The fungi of this subclass are saprophytic or parasitic, aquatic, or aerial, living endophytically as a rule. A few are parasitic on insects and fishes. Two orders are distinguished, viz., the ZYGOMYCETALES and the OOMYCETALES.

ORDER ZYGOMYCETALES

The fungi of this order show a strongly developed mycelium consisting usually of unicellular, sometimes pluricellular, multinucleate hyphæ. These hyphæ are distinguished in the typical forms as the rhizoidal hyphæ, aerial hyphæ and reproductive hyphæ. Vegetative re-

¹ MASSEE, GEORGE: Text-book of Fungi, 1906: 242.

production is never through motile zoospores, but through immotile spores produced in sporangia borne at the tips of the reproductive hyphæ known as sporangiophores, or by means of conidiospores, chlamydospores (*Mucor racemosus*), oidiospores, or gemmæ. Sexual reproduction is by the conjugation of two similar or slightly dissimilar gametes, and the formation of a resting cell, or sexually produced spore, known as the zygote, or zygospore. Brefeld believed that this group gave rise to the higher groups of fungi and he showed an interesting series of transition forms from those like *Mucor* with a typic terminal sporangium (Fig. 13) with numerous sporangiospores (endospores) through *Thamnidium elegans* with a large terminal sporangium (mega-sporangium) and secondary lateral smaller sporangia (sporangioles, microsporangia) and *Thamnidium chætocladioides* (Fig. 32), where the absent terminal megasporangium is represented by a spine-like sporangiophore, to *Chætocladium*, where the number of endospores in the sporangioles is reduced to one inclosed within the sporangium, which behaves as a conidiospore; thence to *Piptocephalis*, where the monosporous sporangiole has become virtually a conidium, or conidiospore. He regarded the ascus as potentially a sporangium, but recent discoveries have shown this hypothetic view to be untenable, so that his views as to the origin of the ASCOMYCETALES and the BASIDIOMYCETALES from the ZYGOMYCETALES must be considered as not satisfactorily proved.

Blakeslee, who has studied the sexual reproduction in the moulds, finds that they may be divided into two groups, the homothallic (monœcious) and the heterothallic (diœcious) forms. The homothallic moulds are those in which the sexual gametes, which conjugate, arise from the same mycelium, while the heterothallic forms are those in which two distinct mycelia contribute the gametes which ultimately unite sexually. The homothallic (hermaphroditic) moulds he divides into the heterogamic hermaphrodites in which there is an inequality in the size of the gametes (the large one being female and the small one male), and the homogamic hermaphrodites in which the gametes are of equal size. The heterogamic hermaphrodites include the following fungi: *Syncephalis*, *Dicranophora fulva*, *Absidia spinosa*, *Zygorhynchus heterogamus*, *Z. Mælleri*, *Z. Vuillemini*. The homogamic hermaphrodites comprise: *Mortierella polycephala*, *Mucor genevensis*, *Spinellus fusiger* and *Sporodinia grandis* (Fig. 28). The diœcious, or hetero-

thallic species are all homogamic, that is, there is no difference in the size of the two gametes which conjugate. This group includes such

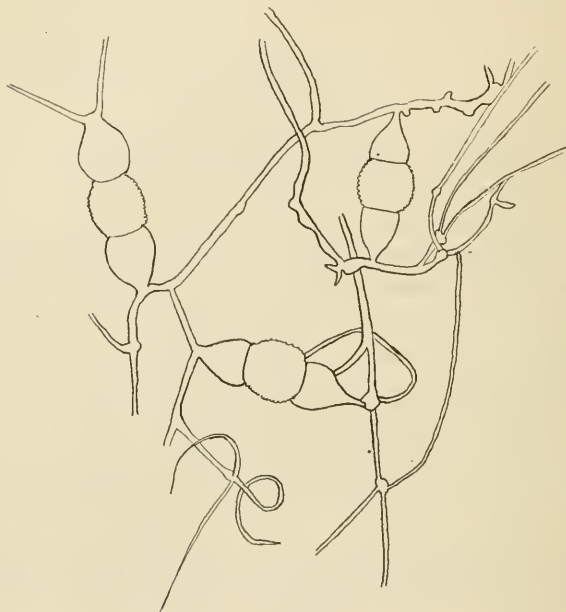

FIG. 28.—Zygospore formation in *Sporodinia grandis* from material growing on toad-stool. (Slide prepared by H. H. York, Cold Spring Harbor, July 29, 1915.)

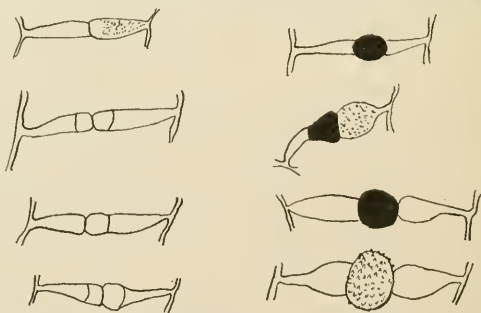

FIG. 29.—Conjugation and development of zygospores between + and - races of black mould, *Rhizopus nigricans*.

fungi as *Absidia cærulea*, *Mucor mucedo*, and five other forms of *Mucor*, *Phycomyces nitens* and *Rhizopus nigricans* (Fig. 29). Taking the con-

jugation in *Mucor mucedo* as an illustration of the method, we find that the hyphæ of two distinct mycelia, which may be designated as the + and - strains, give rise to lateral club-shaped branches. The tips of these two branches (progametes) come into contact and a terminal cell (gamete) is cut off from each branch respectively by a transverse wall. The double partition wall is dissolved away by an enzyme, and the two cells coalesce, their nuclei uniting in pairs. A zygospore is formed, as a resting spore (Figs. 28, 30 and 33). It becomes covered with a thick, warty brown coat. The zygote (zygospore) germinates after a period of rest producing at once, because of the concentrated foods it contains, a sporangiophore bearing a terminal sporangium with sporangiospores. Sometimes the gametes fail to unite through some check to the normal conjugation and the two gametes may then round off and form thick-walled azygospores, and the size of these azygospores depends upon the size of the gametes from which they develop. Blakeslee has discovered that for the production of zygospores in heterothallic moulds the contact of the hyphæ of two distinct mycelia designated + and - are essential. If two - races or two + races meet, there is no result. In the homothallic moulds, the two conjugating gametes may arise from the same mycelium. Where the + race of one species of mould meets the - race of another species imperfect "hybrids" are formed. The testing out, maleness or femaleness, of the different races is made possible by growing in proximity different kinds of moulds, where a reaction occurs and imperfect hybrids are formed one race must be plus and the other minus. Where the hermaphrodite forms are grown, it is noticed that one gamete is larger and the other smaller, and it is assumed, that the larger gamete is female and the smaller one male. The race of diœcious *Mucors*, designated tentatively (+), shows a sexual reaction with the smaller or male gamete, while the (-) or vegetatively less vigorous race shows a reaction with the larger or female gamete. It is inferred that the + race of diœcious *mucors* is female and the - race, male.

The immediate stimulus to the formation of the progametes probably lies in the contact of hyphæ from different strains through the osmotic activity of the hyphal contents. For this reason progametes fail to form in relatively dry air. By suspending two small bags filled with bread soaked in dilute orange juice and inoculated with mould spores, any influence which the substratum might show is eliminated.

Zygosporcs were formed in one week where the aerial radiating hyphæ had come into contact. By this experiment all influences exerted through the solid culture media, or which were due to contact of vegetative mycelia, were eliminated.

The sporangia of *Mucor mucedo* are raised upon the ends of sporangio-phores. When fully formed the sporangium consists of a wall beset with spicules of calcium oxalate, the spores separated from each other by a slimy intersporal substance (zwischenstanz), and a columella which projects into the interior of the sporangium. The formation of spores in *Rhizopus nigricans* and *Phycomyces nitens* has been studied by Swingle,¹ who finds that the columella is formed by the cutting upward of a circular surface furrow or cleft, thus cleaving out the columella over the end of which a plasma membrane is formed. The spore plasm of *Rhizopus* divides into spores by furrows pushing progressively inward from the surface and outward from the columella cleft both systems branching, curving and intersecting to form multinucleated bits of protoplasm (the spores) surrounded only by plasma membranes, which become the spore walls and separated by spaces filled with the intersporal substance (zwischen substanz). The endospores, or sporangio-spores, of *Rhizopus nigricans* and *Sporodinia grandis* are multinucleate, while those of *Pilobolus* are binucleate, according to Harper. The escape of the mature sporangiospores takes place when a portion of the sporangial wall is dissolved. The spores escape imbedded in the intersporal slime, which dries up liberating the spores. Certain species of *Mucor* are capable of fermenting grape juice, the power of fermentation depending on the species. The following species produce alcoholic fermentation (Lindner):

Species	Quantity of alcohol by volume, per cent.
<i>Mucor Jansseni</i>	3.41
<i>Mucor lamprospor</i>	3.71
<i>Mucor javanicus</i>	2.83
<i>Mucor plumbeus</i>	4.62
<i>Mucor pirelloides</i>	1.06
<i>Mucor racemosus</i>	4.62
<i>Mucor Rouxianus</i>	5.25
<i>Mucor griseo-cyanus</i>	4.00
<i>Mucor genevensis</i>	5.21

¹ SWINGLE, DEAN B.: Formation of the Spores in the Sporangia of *Rhizopus nigricans* and of *Phycomyces nitens*. Bull. 27, Bureau of Plant Industry, 1903.

KEY TO FAMILIES OF THE ORDER ZYGOMYCETALES

Non-sexual spores in sporangia, which in some genera are reduced to conidioid bodies.

A. Non-sexual spores formed in sporangia in many cases accompanied by conidiospores.

(a) Sporangia (at least the main sporangia) with columella. Conidiospores absent, or only sparingly found. Zygosporangia naked, or only covered by curled outgrowths of the suspensors. I. MUCORACEÆ.

(b) Sporangia without columella; zygosporangium surrounded by a thick covering of hyphæ. II. MORTIERELLACEÆ.

B. Non-sexual spores as conidiospores. Sporangia exceptionally present.

(a) Conidiospores single. Zygosporangia formed directly by the united gametes.

1. Sporangia present transitional to conidia; sporangia monosporic and polysporic. III. CHOANEPHORACEÆ.

2. Sporangia never present; parasitic on other MUCORALES. IV. CHÆTOCLADIACEÆ.

(b) Conidia in chains zygosporangium formed where the bent ends of the gametes unite. V. PIPTOCEPHALIDACEÆ.

Non-sexual spores as true conidiospores borne singly at the end of conidiophores. VI. ENTOMOPHORACEÆ.

FAMILY I. MUCORACEÆ.—The mycelium of the true moulds is homogeneous, or it becomes heterogeneous through differentiation into aerial and nutritive hyphæ. Non-sexual reproduction by the formation of endospores in sporangia. The sporangia here may be simple or branched. The sporangia are all alike, or there are as in *Thamnidium* two different types known as megasporangia and microsporangia. The larger sporangia have a columella, while the smaller ones are mostly without a columella, but occasionally a columella is present. The formation of conidiospores is unknown in the family. The zygosporangium may arise by the fusion of two similar gametes formed from the same mycelium (homogamic hermaphrodites) or by the union of two slightly dissimilar gametes the product of the same mycelium (heterogamic hermaphrodites), or it arises by the conjugation of similar gametes (+ and - races) from two distinct mycelia (heterothallic and homogamic).

The important genera of the family are *Mucor*, *Rhizopus*, *Phycomyces*, *Absidia*, *Sporodinia*, *Thamnidium*, *Dicranophora*, *Pilaira* and *Pilobolus*. The genus *Mucor*, a key for the identification of the species will be given at the end of the book, was established in 1729 by Micheli. The genus may be divided into three groups of species. The first division includes those species with unbranched sporangiophores, such as *Mucor mucedo*. The second group comprises the moulds with clustered branches of the sporangiophores, as *Mucor corymbifer*, *M. erectus*, *M. fragilis*, *M. pusillus*, *M. racemosus*, and *M. tenuis*. The third section is made up of species the sporangiophores of which show sympodial

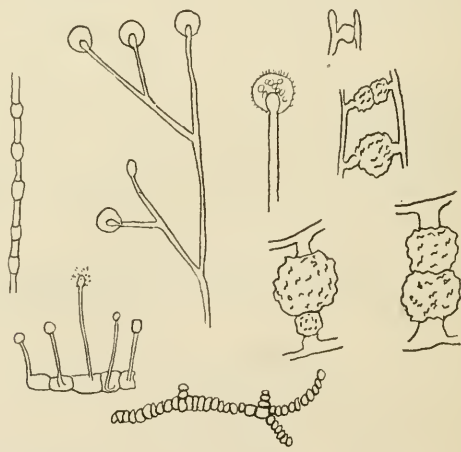

FIG. 30.—Details of *Chlamydomucor racemosus* showing oidia, sporangia and zygospore formation.

branching. Such are *Mucor alternans*, *M. circinelloides*, *M. javanicus*, *M. Rouxii* and *M. spinosus*. (Also consult pages 695-702.)

The oldest known species, *Mucor mucedo*, was described fully for the first time by O. Brefeld in 1872. Stiff sporangiophores, 3° to 40μ thick, arise from the mycelium and are 2 to 15 cm. in height. Each bears a single globular sporangium 100 to 200μ in diameter and the sporangial wall is beset with fine needles of calcium oxalate. The spores are ellipsoidal 3 to 6μ by 6 to 12μ with faint yellowish cell contents. As previously described, conjugation is between two similar gametes from + and - mycelia. *Mucor racemosus*, also known as *Chlamydomucor*

racemosus (Fig. 30), shows the clustered branching of the sporangiophore and in addition the hyphæ are marked by the intercalary formation of chlamydospores. This mould produces sporangiophores 8 to 20 μ thick by 5 to 40 mm. in height, bearing brownish sporangia 20 to 70 μ in diameter. The globular colorless spores are 5 to 8 μ broad by 6 to 10 μ in length. This mould which grows on bread and decaying vegetable matter, and if cultivated submerged in beer-wort, the hyphæ swell irregularly and a large number of transverse septa appear, which divide the hyphæ into barrel-shaped portions. These cells or gemmæ can be separated readily, and when free, they become spheric and multiply by budding, as in the true yeasts, and the submerged spores also bud and constitute the so-called Mucor-yeast. At the surface of the liquid, they develop the typic mould form. *Mucor racemosus*, according to Hansen, is the only mould capable of inverting cane-sugar solution. It produces in beer-wort as much as 7 per cent. by volume of alcohol. *Mucor erectus*, which grows on decaying potatoes, produces azygospores as well as zygo-spores. It has the same appearance as the preceding and possesses an active power of fermentation. In beer-wort of ordinary concentration, it yields up to 8 per cent. by volume of alcohol, and in dextrin solutions it induces alcoholic fermentation. *Mucor spinescens*, which grows on Brazil nuts, has spiny projections on the rounded upper surface of the columella. *Mucor (Amylomyces) Rouxii* occurs in the so-called "Chinese yeast," which is in the form of small whitish cakes, consisting of rice grains kneaded together with assorted spices. These cakes are powdered and mixed with boiled rice upon which the mycelium grows, converting the rice by slow degrees into a yellowish liquid which contains glucose produced by the diastatic ferment of the fungus.

The black mould *Rhizopus nigricans (Mucor stolonifer)* grows on bread and other organic substrata (Fig. 31). Several sporangiophores arise from a single point of origin, namely, at the top of a mass of rooting (rhizoidal) hyphæ which constitute an adhesive organ or oppressorium. Each erect stalk bears oblate spheroidal sporangia with distinct columella and sporangiospores, 6 to 17 μ long. Arising from the base of the clustered sporangiophore is a horizontal hyphæ, which often attains a length of 3 cm. and is known as the stolon, or stoloniferous hypha. When the tip of this stolon comes into contact with the substratum a new appressorium is formed from which arises a number of sporangiophores bearing sporangia (Fig. 31). This method of growth enables the

black mould to spread rapidly and it sometimes chokes out other moulds growing in competition with it on the same nutritive medium. In 1818, on account of this method of growth, it was named by Ehrenberg *Mucor stolonifer*. Related to this fungus is one named *Rhizopus oryzae* which grows in Ragi. The fungus *Phycomyces nitens* is found in empty oil casks, on oil cakes and in concentrated fodder. It puts forth stiff sporangiophores 7 to 30 cm. long and 50 to 150μ in diameter which bear at the summit black globular sporangia 0.25 to 1.0 mm. in diameter, filled with yellow-brown, thick-walled endospores, 16 to 30μ long and 8 to 15μ broad. Its zygospores are 300μ broad and their

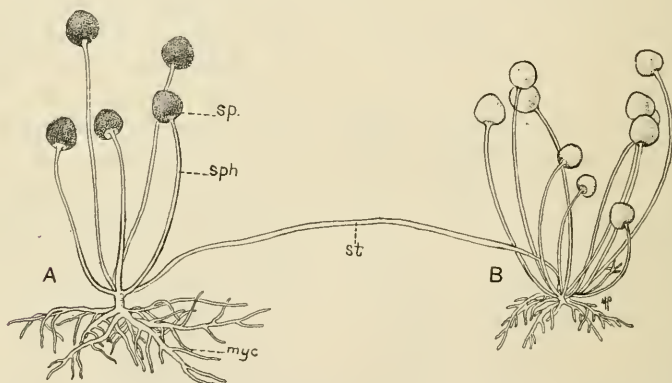

FIG. 31.—Black Mould, *Rhizopus nigricans*. A, Mature plant showing rhizoidal hyphae (*myc*); stoloniferous hypha (*st*); sporangiophores (*sph*); sporangia (*sp*). B, Younger cluster of sporangiophores and sporangia. (After Gager.)

borders are covered with many forked projecting hyphae known as suspensoria. Recently H. Burgeff¹ has studied the variability, sexuality and heredity of *Phycomyces nitens* and has brought his cultural investigations into line with the recent developments of cytology and genetics. His paper should be read by all students, who may be interested in the extension of the methods of genetics into an investigation of the lower plants.

The genus *Absidia* includes five species. In these fungi the suspensors are borne at the base of the two gamete cells which fuse to form the zygospore, which when mature is covered by a basket-like covering of

¹ BURGEFF, H.: Untersuchungen über Variabilität, Sexualität und Erbllichkeit bei *Phycomyces nitens* Kuntze. Flora, Band 108: 353-448; review by G. V. Ubisch (Dahlem) in Botanisches Centralblatt, Band 128, Nr. 23: 630-632, 1915.

straight appressoria, which hook together by their curved extremities, thus giving additional protection to the zygospore. *Sporodinia grandis*, the single species of another genus, lives on large fleshy fungi of the

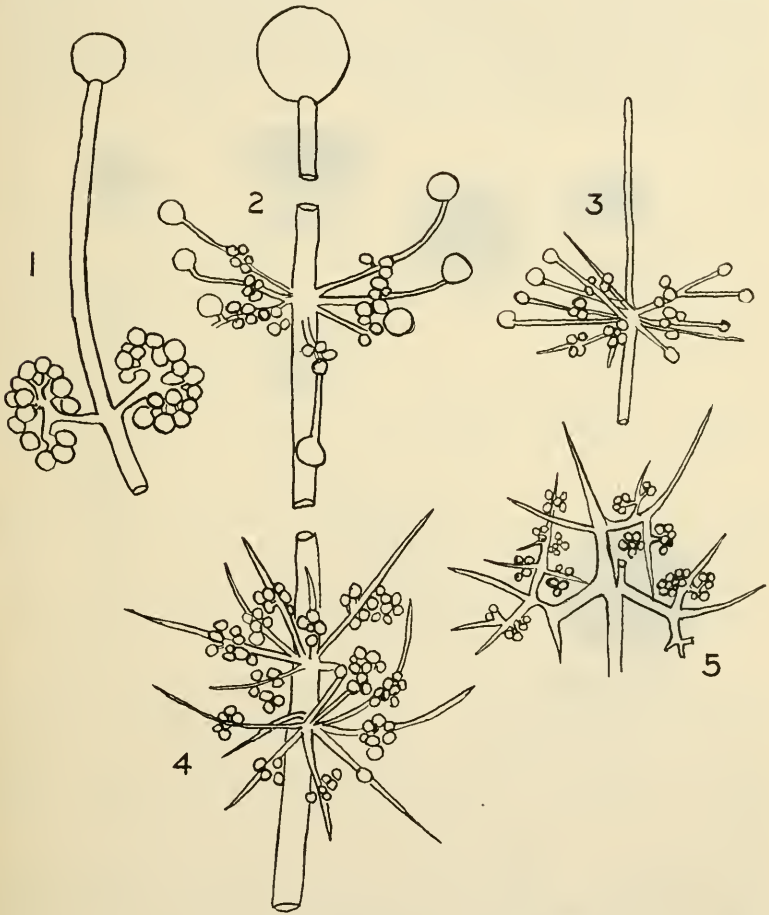

FIG. 32.—Sporangia of 1, *Thamnidium elegans*; 2, 3, 4, *Thamnidium chatocladoides*; 5, *Chatocladium Jonesii*. (After Brefeld.)

families (Fig. 28) AGARICACEÆ, BOLETACEÆ, CLAVARIACEÆ and HYDNACEÆ. Its sporangiophores 1 to 3 cm. high are finally brown in color and dichotomously branched. The sporangia are spheric with a deli-

cate sporangial wall, which soon disappears leaving the spores on a hemispheric columella. These spores are 11 to 70 μ broad. The 300 μ broad zygospores are produced from similar branches of a dichotomously branched zygosporangium. The mycelium of the species of *Thamnidium* enters the nutritive substratum. The large sporangia are terminal while the smaller secondary sporangia are borne on lateral branches in whorls below the terminal sporangium. This is typically seen in *Th.*

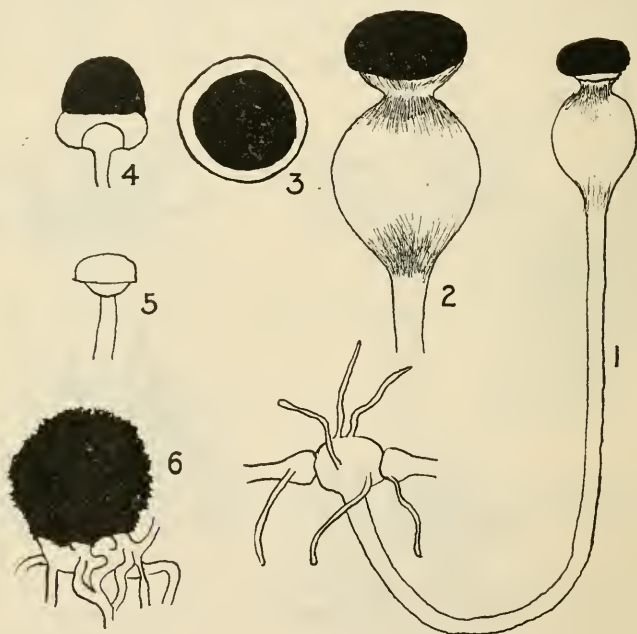

FIG. 33.—Details of sporangia and sporangiophores of *Pilobolus*. 1, *P. microsporus*; 2, *P. roridus*; 3, 4, 5, *P. anomalus*; 6, zygospore of *P. anomalus*. (After Brefeld.)

elegans (Fig. 32). A related species *Th. Fresenii* has an upright terminal sporangiophore, which is either sterile, or ends in a large terminal sporangium, while the smaller sporangia are as in *Th. elegans*. In *Th. amoenum*, the lateral smaller sporangia are borne at the end of coiled secondary sporangiophores. The secondary sporangia suffer reduction in *Th. chatocladoides* (Fig. 32) which in addition to having a straight terminal spine-like hypha in place of the terminal sporangia has some of the lateral microsporangia replaced by sterile branches. The

commonest species of *Pilobolus* (Fig. 33) is *P. crystallinus* which appears on horse dung. It has a few short feeding hyphæ and an upright sporangiophore swollen at the extremity by gas and water vapor and, therefore, under tension. It bears at its extremity a flat rounded sporangium filled with sporangiospores. An explosion of the sporangiophore causes the whole sporangium to be shot off a considerable distance.

FAMILY 2. MORTIERELLACEÆ.—This family consists of two genera *Mortierella* and *Herpocladiella*. The genus *Mortierella*, which is represented by a coprophilous species, *M. Rostafinski*, has a sporangium borne on a sporangiophore which arises in a definite way from a snare of hyphæ that are knotted into a rounded mass at its base. In *M. candelabrum*, the sporangiophore is branched candelabra-like. Brefeld mentions *Mortierella* and *Rhizopus* as examples of the carposporangiate ZYGOMYCETALES, where the sporangiophores appear always at predetermined places on the mycelium, and not at indefinite points, as in the majority of other moulds.

FAMILY 3. CHOANEPHORACEÆ.—Represented by a single genus *Choanephora* and a single species *infundibulifer* on flowers of *Hibiscus* in East Indies.

FAMILY 4. CHÆTOCLADIACEÆ.—This is a small family of one genus (*Chætocladium*) and two species, (*Ch. Jonesii* and *Ch. Brefeldii*) (Fig. 32) which live parasitically on *Mucor mucedo* and *Rhizopus nigricans*. The terminal sporangia of *Thamnidium* are never formed and secondary sporangia are reduced to the unisporous condition suggesting conidiospores with pointed branches between them.

FAMILY 5. PIPTOCEPHALIDACEÆ.—Three genera *Piptocephalis*, *Syncephalis* and *Syncephalastrum* are recognized in Die Natürlichen Pflanzenfamilien. The eight species of *Piptocephalis* are parasitic on the mycelia of *Mucor*, *Pilobolus* and *Chætocladium* species (Fig. 37). The haustorial hypha flattens itself disc-like on the outer surface of the host's hyphæ and sends five rhizoidal branches into the host cells. An erect dichotomously branched conidiophore bears conidiospores in globular clusters at the ends of its principal branches. Some species of *Syncephalis* are parasitic on other fungi; but *S. cordata* grows on manure, presumably as a saprophyte.

FAMILY 6. ENTOMOPHTHORACEÆ.—The mycelium of the fungi of this family is more or less richly developed and lives endozoically in animals, such as flies, mosquitoes, aphids, and seldom saprophytically as

Basidiobolus on the feces of frogs. Non-sexual reproduction is mainly by means of unicellular conidiospores which are discharged forcibly from the ends of tubular conidiophores. Sexual reproduction is by the conjugation of two gametes dissimilar in size, heterogamic and thus these fungi connect the ZYGOMYCETALES with the OOMYCETALES where oogamous reproduction is displayed. The zygospores formed in conjugation are spheric, while the azygospores formed on the mycelium without copulation are similar to the zygospores in structure and appearance. The family includes seven genera, includ-

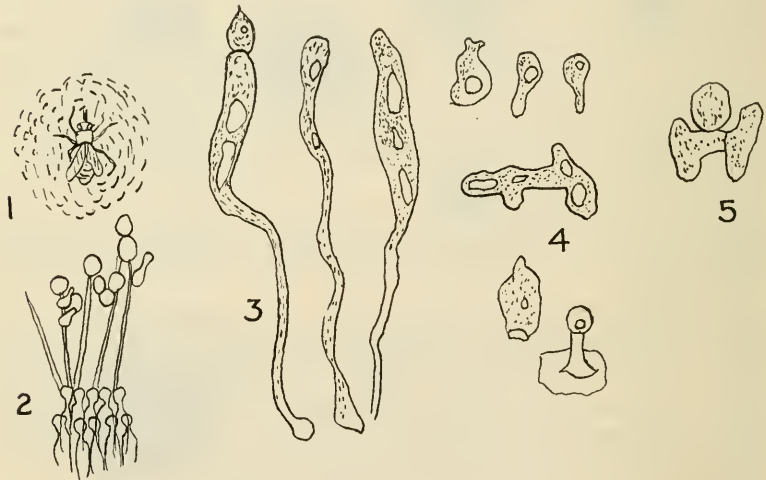

FIG. 34.—Fly cholera fungus (*Empusa muscæ*). 1, Fly enveloped in mycelium; 2, fungus between hairs of the fly; 3, conidiophores and conidiospores; 4, germination of spores; 5, formation of egg in *Empusa sepulchralis*. (After Thaxter.) See Henri Coupin, Atlas des Champignons, Parasite set Pathogenes de l'Homme et des Animaux, 1909.

ing *Empusa* and *Entomophthora*, which may be chosen as types for discussion.

The mycelium of *Empusa muscæ* (Fig. 34) is parasitic in the bodies of flies, destroying them in large numbers by an epidemic in the fall, known as fly-cholera. The short hyphæ frequently bud like yeast cells. The conidiophores break through to the surface of the insect's body, where the conidiospores 18 to 25 μ broad by 20 to 30 μ long are forcibly discharged. These spores bore their way through the chitinous covering of a healthy fly by means of a germ tube and the

hyphæ which enter the body of the fly bud like yeast cells, which are carried to all parts of the insect's body. Later the parasitic hyphæ arise from the gemmæ. Resting spores are unknown.

Entomophthora is a genus of fungi inclusive of thirty species found on various insects in Europe and North America. *Entomophthora sphaerosperma* has a richly branched nutritive mycelium, which grows through the body of insects. After the death of the host, the hyphæ break through the surface in connected strands part of which attach the larva, or insect's dead body, to the substratum and part form a thick white mantle over the surface.

The conidiophores are in branching bundles. The conidiospores are elongated ellipsoidal, 5 to 8 μ broad by 15 to 26 μ long. Secondary and tertiary conidia are found. The resting spores produced as azygospores are spheric and 20 to 35 μ broad with a smooth yellow wall. It grows on larvæ, especially frequent on the cabbage worm *Pieris brassicæ* in Europe and North America.

BIBLIOGRAPHY OF THE ZYGOMYCETALES

This is not intended to be a complete list of the works dealing in whole or in part with the mould fungi, but only a list of the works which may prove helpful to the student of mycology.

BAINIER, G.: Etude sur les Zygosporées des Mucorinées, Thèse présentée à l'École de Pharmacie. Paris, pp. 136, pls. 1-11; Observations sur les Mucorinées. Annales des Sciences naturelles, ser. 6, 1-15: 70-104, pls. 4-6. Sur les zygosporées des Mucorinées. Annales des Sciences naturelles, vi ser., I: 18, 1883; Nouvelles observations sur les zygosporées des Mucorinées, do., I: 19, 1884.

BLAKESLEE, ALBERT F.: Sexual Reproduction in the Mucorineæ. Proceedings American Academy Arts and Sciences, xl: 205-319 with 4 plates and bibliography; The Biological Significance and Control of Sex. Science, new ser. xxv: 366-384, March 8, 1907; Papers on Mucors (a review). Botanical Gazette, 47: 418-423, May, 1909; Heterothallism in Bread Mould, *Rhizopus nigricans*. Botanical Gazette, 43: 415-418, June, 1907; A Possible Means of Identifying the Sex of (+) and (-) Races in the Mucors. Science, new ser. xxxvii: 880-881, June 6, 1913; On the Occurrence of a Toxin in Juice Expressed from the Bread Mould, *Rhizopus nigricans*. Biochemical Bulletin II: 542-544, July, 1913; Conjugation in the Heterogamic Genus *Zygorhynchus*. Mycologisches Centralblatt II: 241-244, 1913; Sexual Reactions between Hermaphroditic and Dioecious Mucors. Biological Bull., xxix: 87-102, August, 1915; Zygosporées and *Rhizopus* for Class Use. Science, new ser. xlii: 768-770, Nov. 26, 1915.

BREFELD, O.: Botanische Untersuchungen über Schimmelpilze, Heft 1, Zygomyceten, pp. 1-64, Taf. 1-6, 1872; Untersuchungen aus den Gesamtgebiete der Mykologie, ix, 1891.

- BUCHANAN, ESTELLE D., and BUCHANAN, ROBERT E.: Household Bacteriology, 1914: 66-72.
- DE BARY, A.: Comparative Morphology and Biology of the Fungi and Bacteria, 1887: 144-160.
- ENGLER, A. and GILG, ERNST.: Syllabus der Pflanzenfamilien, 7th Edition, 1912: 37-38.
- GORTNER, ROSS A. and BLAKESLEE, A. F.: Observations on the Toxin of *Rhizopus nigricans*. American Journal of Physiology, xxxiv: 354-367, July, 1914.
- JÖRGENSEN, ALFRED: Microörganisms and Fermentation, 3d Edition, 1900: 97-115.
- KEENE, MARY L.: Cytological Studies of the Zygospores of *Sporidia grandis*. Annals of Botany, xxxviii: 455, 1914.
- KLÖCKER, ALB.: Fermentation Organisms, 1903: 170-186.
- LAFAR, FRANZ: Technical Mycology, II, part 1: 1-30, 1903.
- LENDNER, ALF.: Les Mucorinées de la Suisse. Matériaux pour la Flore Cryptogamique Suisse III, Fasc. 1: 1-177, 1908.
- SCHRÖTER, J.: Mucorinæ, Die natürlichen Pflanzenfamilien, I, Teil 1. Abt. 119-142, 1897.
- STEVENS, F. L.: The Fungi which Cause Plant Disease, 1913: 101-108.
- SWINGLE, DEANE B.: Formation of the Spores in the Sporangia of *Rhizopus nigricans* and of *Phycomyces nitens*. Bureau of Plant Industry No. 37, 1903 with 6 plates.
- UNDERWOOD, LUCIEN M.: Moulds, Mildews and Mushrooms, 1899: 24-28.
- VON TAVEL, F.: Vergleichende Morphologie der Pilze, 1892: 25-40.
- WETTSTEIN, RICHARD R. VON: Handbuch der systematischen Botanik, 1911: 160-164.

CHAPTER XII

OOSPORE-PRODUCING ALGAL FUNGI

ORDER II. OOMYCETALES

The fungi of this order were derived probably from some ancestor, or ancestors, which through the loss of chlorophyll became dependent on extraneous supplies of organic food. If we look for such an ancestral form among the algæ, we find that it must have been related to *Vaucheria*, if not identic with that filamentous siphonaceous green alga with reproductive organs, as oogonia and antheridia. *Vaucheria* is a unicellular filamentous sparingly branched cell with a thin cell wall and multinucleate. Hence it is sometimes called a *cænocyte*. Similarly, the structural features of the more primitive OOMYCETALES are like *Vaucheria*, but the absence of chlorophyll is distinctive. The formation of non-sexual sporangia with the formation of zoospores, or swarm spores, known as zoosporangia is a feature of the fungi of this order. As there is a pronounced difference between the male and female sexual organs, oogamous reproduction is the rule. The oogonium is comparatively large and contains one or more oospheres, which are fertilized by the sperm cell, which swim to it by cilia, creep to it, or are carried into the oogonium through a fertilization tube. Sexual reproduction in these fungi has been investigated cytologically by a number of students, and they have found that the nuclear changes concomitant with fertilization are characteristic. *Albugo candida*, *A. lepigoni*, *Peronospora parasitica*, *Plasmopara*, *Pythium* and *Sclerospora* show a single large central oosphere with a single nucleus, while the remaining nuclei pass from the gonoplasm into the periplasm. A process is sent into the oogonium from the antheridium and a single male nucleus passes into the oogonium. A cell wall is developed about the oospheres and the male and female nuclei unite, while the periplasm is used in the formation of the spore wall (episporium). The ripe oospore has a single nucleus in *Peronospora parasitica*, while in *Albugo*, it becomes multinucleate after nuclear division. A central oosphere (gonoplasm) surrounded by peri-

plasm occurs in *Albugo bliti* and *A. portulacæ* and the oosphere is multinucleate and the nuclei present fuse in pairs with a number of sperm nuclei which enter from the antheridium. The oospore which arises is multinucleate. This method is considered by mycologists to be the primitive one as displayed in these two species, the uninucleate oospheres of the first-named species having been derived from the multinucleate. An intermediate position is occupied by *Albugo tragopogonis*, where at first the oosphere is multinucleate but by the degeneration of all but one female nucleus becomes uninucleate. Claussen¹ finds that *Saprolegnia monoica* develops both antheridia and oogonia, the latter at first being filled with protoplasm and many nuclei which wander to the periphery and undergo degeneration with a few nuclei left over. These nuclei divide once mitotically. Around these daughter nuclei the protoplasm collects to form the egg cells. Each egg has a single nucleus near which is the cœnocentrum of Davis, but which Claussen thinks is a true centrosome. The simple or branched antheridia form germ tubes which enter the wall of the oogonium and a single male nucleus fuses with the nuclei of the egg cells to form the oospore. Claussen contrasts the life cycle, as determined by his investigations, with those of Trow in the following diagrammatic presentation:

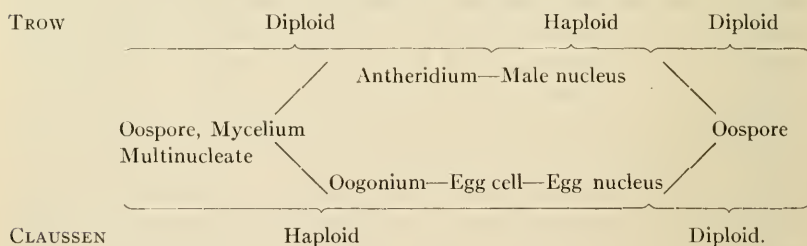

Strasburger considers that the superfluous nuclei in the oogonia and the antheridia are comparable with the superfluous egg nuclei of certain of the brown seaweeds belonging to the family FUCACEÆ. When the oospores germinate, they either produce directly a mycelium, or give rise to zoospores. The fungi of this order are essentially parasitic, being found in this condition as endophytic parasites, or as endozoic parasites on fishes and insects and *Euglena*.

¹ CLAUSSEN, P.: Ueber Entwicklung und Befruchtung bei *Saprolegnia monoica*. Festschrift der Deutsch. Bot. Gesellsch., xxvi; 144-161 with 2 plates, 1908.

KEY TO FAMILIES OF THE ORDER OOMYCETALES

A. Zoosporangia, oogonia and antheridia present; conidia absent.

(a) Mycelium well developed.

1. Antheridium forming motile spermatozoids, which enter the oogonium. Family 1. MONOBLEPHARIDACEÆ.
2. Antheridium not forming spermatozoids, fertilization through an antheridial tube, or beak. Family 2. SAPROLEGNIACEÆ.

(b) Mycelium poorly developed, sometimes represented by a single cell.

1. Fruit body as a single cell or by division forming a sporangial sorus; parasites on algæ, protozoans, rarely on flowering plants. Family 4. CHYTRIDIACEÆ.
2. Fruit body through division a chain of cells which develop sometimes into zoosporangia, sometimes into antheridia and oogonia. Family 5. ANCYCLISTACEÆ.

B. Conidia present. Family 3. PERONOSPORACEÆ.

The following descriptions of the above five families are presented in order to introduce the student to the characters which fundamentally distinguish them. Therefore, all generic keys are omitted because the introduction of them under each family would increase the size of the book unduly.

FAMILY 1. MONOBLEPHARIDACEÆ.—This family is represented by the genera *Monoblepharis* and *Gonapodya*. The genus *Monoblepharis* is represented by two species of which *M. spherica* is the most common. It is an aquatic fungus found growing saprophytically on dead animal and plant parts under water. The hyphæ of the mycelium are tubular, branched and unicellular. The swarm spores (zoospores), which are formed much as in *Saprolegnia*, have only a single flagellum. The oogonia are either terminal in position or interstitial and there is no differentiation of an outer periplasm, but the whole protoplasm of the oogonium contracts to form an oosphere. Later a pore appears at the apex of the oogonium through which the unciliate spermatozoids enter to fertilize the egg cell. The antheridium in *M. spherica* appears as a penultimate cell immediately below the oogonia. An opening is formed at the top through which the spermatozoids escape. The oosphere on fertilization becomes an oospore. Because of the aquatic

habit and formation of motile spermatozoids, Brefeld considers *Monoblepharis* to be the most primitive of the OOMYCETALES.

FAMILY 2. SAPROLEGNACEÆ.—The members of this family, as their name indicates, are saprophytes on both dead plants and animals in water with the exception of the fungus which causes the salmon disease and it is both a saprophyte and a facultative parasite. The hyphæ in the vegetative condition are relatively large, arising from delicate rhizoids which penetrate the substratum. Swarm spores which are biciliate are formed in terminal, long, tubular zoosporangia opening by an apical pore through which the zoospores crowd their way out into the water. Sometimes, as they escape, they collect into ball-shaped masses which are caused to slowly roll about by the activity of the cilia. The female sexual organs, the oogonia, are terminal on the branches of the thallus hyphæ. Several oospheres without distinction of periplasm are formed inside of a single oogonium, and sometimes, as many as thirty or forty are found. The antheridia, which are club-shaped, are formed on slender branches of the mycelium which also bear the oogonia, or which are distinct from those which are oogonial bearers. These antheridia approach the oogonia and an antheridial beak is formed which penetrates the wall of the oogonium and comes into contact with the oospheres by growing from one oosphere to another. Sometimes the antheridia, as in *Saprolegnia monilifera*, are not produced at all and the oogonia develop parthenogenetic oospores which germinate after a rest period of a few days to several months. The series representing reduction in sexuality begins with such forms as *Saprolegnia monoica* with an oogonium and an antheridium which develops a fertilizing process through *Achlya polyandra*, which forms antheridial branches which do not touch the oogonia, to *Saprolegnia monilifera* without any trace of antheridia. Androgynous forms are those in which the same hyphal branch develops both antheridia and oogonia and the diclinous species like *Saprolegnia dioica* and *Achlya oblongata* are those in which the antheridia and oogonia are borne on distinct branches.

Saprolegnia ferax usually attacks only fishes, tadpoles and the spawn of frogs. It appears on aquarium-kept fishes on the sides of the body at the tail end, or among the gills. In the latter place, if abundant, it frequently causes asphyxiation and before this state is final the fish turns over on its back and rises to the surface. In the

experience of the writer, immersion of the diseased fish in strong brine in many cases brings about a cure, if the growth of the fungus is not too great. Petersen¹ observed a sick bream in the lake of Fure Sö with a wound quite overgrown with *Saprolegnia* hyphæ and he has found frog eggs which were attacked, the hyphæ growing in the jelly around the eggs, penetrating into them. The fungus can be raised in the laboratory on dead fishes by allowing tap water to slowly flow over them in a jar. A few days are necessary to secure a copious growth. Frogs which die under the ice in winter for lack of oxygen float to the surface in the spring entirely covered by this fungus. It thrives best in the early stages of decay, for as putrefaction advances bacteria and infusoria increase to such an extent as to check the growth of the fungus. When air insects, such as gnats, fall into lake or pond water in great numbers, species of *Saprolegnia*, *Achlya* and *Aphanomyces* appear in great numbers and seem to form a gray felt on the surface.

The vegetable materials on which the SAPROLEGNIACEÆ mostly live are branches and shoots of trees, except *Salix*, owing to presence of salicin, which fall into the water. Second in importance are half-rotten rhizomes of *Calla*, half-rotten leaves and leaf stalks of *Nuphar* and *Nymphæa* and other parts of aquatic plants which float on the surface. Species of the genus *Achlya* are mostly associated with such materials. *Achlya polyandra* have been repeatedly found by me on the fruits of Osage oranges which have fallen into the pond at the University of Pennsylvania. The most favorable environmental conditions seem to be the absence of air about the hyphæ, quiet, still, pure water, that does not contain much iron and a relatively open light surface. Low temperature conduces to the formation of oogonia, which also keeps in check other competing organisms (Fig. 35).

FAMILY 3. PERONOSPORACEÆ.—This family is rich in parasitic forms which may be accounted as the cause of important diseases of cultivated plants. The hyphæ of the mycelia are irregularly and copiously branched and are found mainly in the intercellular spaces of the host tissue sending short branches called haustoria into the adjoining living cells. These haustoria may be globular (*Albugo* = *Cystopus*), club-shaped (*Peronospora corydalis*), branched (*Plasmopara*) (Fig. 36), or branched and snarled (*Peronospora*). Septa are absent except

¹ PETERSEN, HENNING E.: An Account of Danish Fresh-water Phycomycetes. *Annales Mycologici*, viii, No. 5, 1910.

when the reproductive organs are formed. Non-sexual spores, or conidiospores, are borne on conidiophores which may remain within the host (*Albugo = Cystopus*), or grow beyond the surface. They may be either simple or branched. These conidiospores either germinate, as in *Phytophthora infestans* and *Peronospora nivea* by means of zoo-

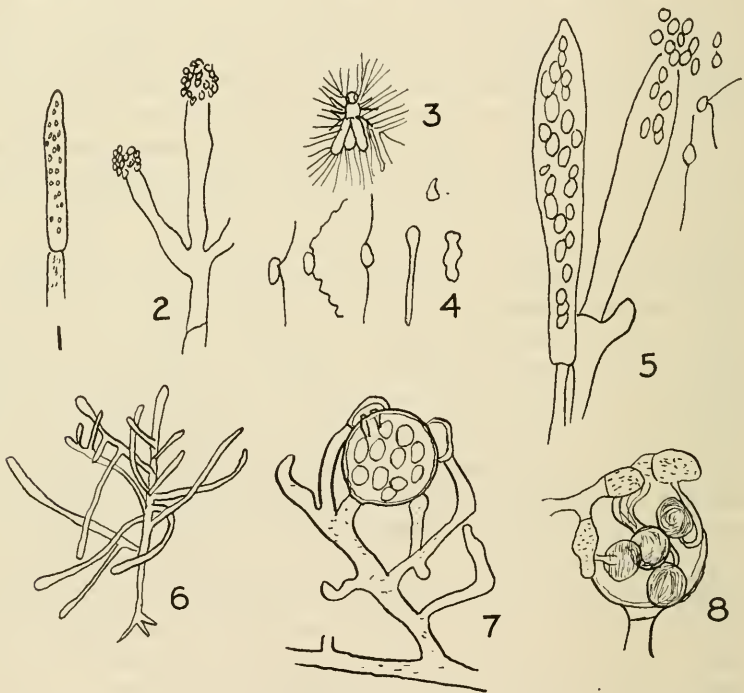

FIG. 35.—1, Zoosporangium of *Achlya racemosa*; 2, escape of zoospores; 3, fly-covered by mycelium; 4, zoospores of fungus; 5, *Achlya ferax* with zoosporangia and zoospores; 6, *Achlya prolifera*, 24 hours after germination of zoospores. 7, *Achlya monoica*, with antheridia and oogonia; 8, *Achlya contorta*. (After Henri Coupin, *Atlas des Champignons Parasites et Pathogenes de l'Homme et des Animaux*, pl. xviii, 1909.)

spores which escape or by the protoplasm escaping (*plasmatoparous*), as in *Peronospora densa*, or by germ tubes, which in some species (*Peronospora lactucae*) appear at the end of the spore (*acroblastic*), or at the side of the conidiospore (*pleuroblastic*), as in *Peronospora radii*. The oogonia and antheridia, which are also present, are formed in the

tissues of the host. The different kinds of nuclear fusion, which accompany fertilization, have been described previously. The oospore, which is formed, acts as a zoosporangium in some cases for it gives rise to numerous spores; or in other cases it produces a germ tube. In most of the forms, the oogonium contains a mass of protoplasm known as the oosphere. This is divisible into an outer clearer por-

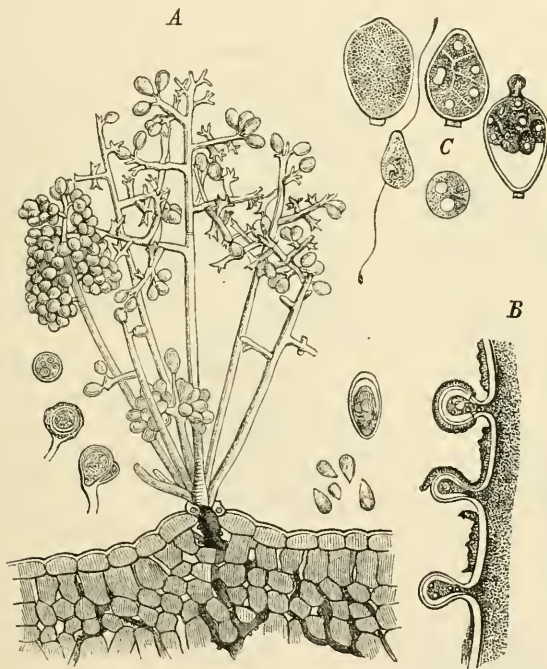

FIG. 36.—*Plasmopora viticola*. A, Conidiophore with conidiospores (nearby oospores); B, Haustoria; C, Swarmspore formation. A, 950/ μ ; B, C, 600/ μ . (After Millardet in *Die natürlichen Pflanzenfamilien* I. 1, p. 115),

tion, the periplasm, and a denser more granular central portion, the gonoplasm. After fertilization, the oospore develops a thick wall of two layers, an extine and intine, and becomes a resting spore. It accumulates fatty substances, which are utilized when the spore germinates in the spring after a long winter's rest. The family has had many revisions and in order to simplify matters *Pythium* and *Albugo* (Fig. 37), which are placed in separate families by some

authors, are placed in the family PERONOSPORACEÆ. Details of the important forms which cause plant diseases will be given in the third part of this book. These fungi will be referred to under each genus following the systematic generic key which is here given.

GENERIC KEY OF THE FAMILY. PERONOSPORACEÆ

Mycelium of these fungi parasitic or saprophytic in plant tissues; zoosporangia as distinct organs producing biciliate zoospores.

Zoospores formed out of protoplaem which escapes out of the conidia. 1. *Pythium*.

Zoospores formed within the zoosporangia.

2. *Pythiacystis*.

Zoospores elongate. 3. *Nematosporangium*.

Mycelial hyphæ branching non-septate usually coarse, of strictly parasitic habit.

Conidiophores short, thick, subepidermal, conidia in chains.

4. *Albugo*

Conidiophores longer superficial, simple or branched, conidia not in chains.

Conidiophores scorpioid cymosely branched conidiospores developing swarmspores.

5. *Phytophthora*.

Conidiophores simple, or branched monopodially; conidia sprouting as a plasma, or by swarm spores. Conidiophores regularly branched.

Conidiophores simple erect with a swollen end (basidia-like) bearing short sterigma-like branches of equal length.

6. *Basidiophora*.

Conidiophores with lateral branches developed normally of unequal length. Conidiophores stout, with few branches, oospore united to wall of oogonium.

7. *Sclerospora*.

Conidiophores slender, freely branched persistent; oospore free.

8. *Plasmopara*.

Conidiophores with forking branches; conidiospores sprouting with a germ tube. Upper end of conidiospore with a



FIG. 37.—White rust, *Cystopus (Albugo) portulacæ*, on purslane, *Portulaca oleracea*. (Cold Spring Harbor, L. I., July 24, 1915.)

papilla through which the germ tube grows (acroblastic).

9. *Bremia*.

Conidiospores without papilla; pleuroblastic. 10. *Peronospora*.

The most important species of these genera from the standpoint of the plant pathologist are the following enumerated below with their common English names where such have been given.

Scientific name	English name	Host plant
<i>Pythium de Baryanum</i>	Damping-off fungus.	Seedlings
<i>Pythiacystis citriophora</i>	Brown rot of lemon.	Lemon fruits
<i>Albugo (Cystopus) candida</i>	White rust of crucifers.	Cruciferous plants
<i>Albugo (Cystopus) portulacæ</i>	White rust of purslane.	<i>Portulaca oleracea</i>
<i>Phytophthora cactorum</i>	Mildew of succulents.	Cacti, etc.
<i>Phytophthora infestans</i>	Late blight of potato.	Potato
<i>Phytophthora phaseoli</i> (Fig. 44).	Downy mildew of beans.	Lima-bean
<i>Plasmopara cubensis</i>	Downy mildew of cucumber.	Cucumber
<i>Plasmopara Halstedii</i>	<i>Helianthus annuus</i> and <i>H. tuberosus</i>
<i>Plasmopara viticola</i>	Downy mildew of grape.	Grape vine
<i>Bremia lactuca</i>	Downy mildew of lettuce.	<i>Cynara, Cineraria, Lactuca</i>
<i>Peronospora effusa</i>	Mildew of spinach.	Spinach
<i>Peronospora parasitica</i>	Downy mildew of crucifers.	Cabbage
<i>Peronospora Schleideniana</i>	Onion mildew.	Onion

CHAPTER XIII

OOMYCETALES (CONTINUED)

FAMILY 4. CHYTRIDIACEÆ.—This family according to some authors is made to include six families which are here reduced to six subfamilies. It includes fungi of short vegetative duration, which may be a few days in length. The swarm spores quickly give rise to new generations. The resting period is represented in the case of the endophytic parasites by the time which elapses between the growth of two successive crops of the host plants. The majority of the species of the family are true parasites, partly endobiotic, partly epibiotic, and a few are saprophytes. Half of the plant parasites live in fresh-water algæ, nearly as many in flowering plants, some of which are in aquatic plants, some in swamp plants. About ten species are found on marine algæ. All species are microscopically small, yet they cause galls, dwarfing, dropsy and crusts of the host plants. The mycelium is absent or in the form of slender protoplasmic filaments, occasionally as distinct one-celled hyphæ. The cell, which produces the fruit body, frequently serves as the chief nutritive organ. Later, it divides to form zoospores. The true mycelium has weak development. The short germ tube merely serves as an organ by which the parasite gains entrance to the host cell, and in the endophytic forms, it disappears quickly, but in the epiphytic species, it serves as an haustorium, sometimes with rhizoidal extensions. In the better-developed forms of CLADOCHYTRIEÆ, the slender mycelium serves to carry the fungus from cell to cell of the host. The sporangia are always zoosporangia which develop swarm spores, or zoospores. They are thin-walled and quickly mature, or they are thick-walled and form resting sporangia. Sexual spores are formed in only a few types and the difference between antheridia and oogonia is morphologically little pronounced. The swarm spores have as a rule a single flagellum, rarely do they have no such locomotory appendages. The sexually produced oospores have the appearance of resting sporangia with the empty antheridium attached as an appendage. Few of these fungi attack our

cultivated plants, but where the attempt is made to grow algæ and other water plants, the fungi of this family occasionally do considerable damage.

As an example of the first subfamily OLPIDEÆ, may be chosen *Olpidium endogenum*, which lives in the cells of desmids and kills them. The zoosporangium found in desmid cells are oblate spheroids and develop a long tube which projects out of the desmid cell through which the zoospores with a single cilia escape into the water. *O. entophyllum* is parasitic in such filamentous algæ as *Vaucheria*, *Cladophora*, *Spirogyra*. *Olpidiopsis saprolegniæ* lives in the elongated cells of *Saprolegnia*, producing enlargements in the hyphæ of the fungous host. The swarm spore bores a hole in the cell wall of its host and swells out into a zoosporangium which develops a tube through which the biciliate swarm spores escape into the water.

The subfamily SYNCHYTRIEÆ includes most of the fungi which attack the higher plants. Such are *Synchytrium decipiens* on the hog peanut (*Amphicarpea monoica*); *S. fulgens* on the evening primrose (*Oenothera biennis*); *S. stellariæ* on *Stellaria*; *S. succisæ* on *Succisa pratensis*; *S. taraxaci* on dandelion; *S. vaccinii* causing a gall on cranberries, *Pycnochytrium globosum* on violet, wild strawberry, blackberry and maple seedlings. *P. myosotidis* occurs on certain members of the borage and rose families.

Cladochytrium tenue of the subfamily CLADOCHYTRIEÆ lives in the subaquatic tissues of the sweet flag, *Acorus calamus*, flag *Iris pseudacorus* and a grass, *Glyceria aquatica*. Its mycelium is widely distributed in the cells of its hosts. Spheric sporangia 18μ wide and sometimes 66μ are formed as intercalary enlargements of the mycelium, or they are formed at the end of the hyphæ, with a colorless supporting cell. They give rise to a short tube-like mouth which breaks out of the host cell. The zoospores are uniciliate.

Representing the OOCIYTRIEÆ is an interesting fungus first fully investigated by Nowakowski, namely, *Polyphagus euglenæ*, which attacks the cells of *Euglena*, a unicellular animal. Its mycelium consists of a central enlarged portion from which run out in a number of directions branches which end in extremely fine points which penetrate the cells of *Euglena*. The enlarged central portion develops a swollen tubular outgrowth into which its protoplasm wanders. The contents of this outgrowth then divide into numerous uniciliate swarm spores

which escape into the water. Under certain conditions a cyst appears in place of a zoosporangium. This is thick-walled and of a yellow color and enters a period of rest. After the rest period, the membrane of the cyst ruptures and a sporangium appears. Cysts may arise by a kind of sexual union where two unlike mycelia fuse and the protoplasm of both flows out to form a cyst between the original cells. *Urophlyctis pulposa* attacks leaves and stems of *Chenopodium* and *Atriplex* species. *U. alfalfa* grows in the roots of the alfalfa in South America and Germany.

FAMILY 5. ANCYCLISTACEÆ.—This is a small family consisting of fungi whose mycelium is very slightly developed and not easily distinguished from the fruit body. In one subfamily LAGENIDEÆ, the mycelium is entirely absent. In the ANCYCLISTEÆ, there is a rich development of the mycelium which forms lateral tube-like branches, which penetrate other cells. The fruit bodies are sac-like and give rise to zoospores. Sexual organs are present as antheridia and oogonia, the contents of the former passing over completely into the latter. The oospore, which is formed, is found free in the oogonium. All of the known members of this family are endophytic parasites and the different stages of their development are short-lived.

Lagenidium entophyllum lives in the zygosporangia of species of *Spirogyra*. *L. Rabenhorstii* parasitizes the cells of *Spirogyra*, *Mesocarpus*, *Mougeotia*. *L. pygmaeum* lives in the pollen grains of diverse species of *Pinus*.

BIBLIOGRAPHY OF OOMYCETALES

- ATKINSON, GEORGE F.: Damping Off. Bull. 94, Cornell University Agricultural Experiment Station, May, 1895; Notes on the Occurrence of *Rhodochytrium spilanthidis* Lagerheim in North America. Science, new ser., xxviii: 691-692, Nov. 13, 1908; Some Fungus Parasites of Algæ. Botanical Gazette, xlviii: 321-338, November, 1894.
- CLINTON, G. P.: Oospores of Potato Blight, *Phytophthora infestans*. Report Conn. Agricultural Experiment Station. Part x, Biennial Report of 1909-1910: 753-774; Oospores of Potato Blight. Science, new ser., xxxiii: 744-747, May 12, 1911.
- CLAUSSEN, P.: Ueber Eientwicklung und Befruchtung bei *Saprolegnia monoica*. Ber. d. Deut. Bot. Gesellsch., xxvi: 144, 1908.
- COKER, W. C.: Another New Achlya. Botanical Gazette, 50: 381-382, November, 1910.
- DAVIS, BRADLEY M.: Cytological Studies on *Saprolegnia* and *Vaucheria*. The American Naturalist, xlii: 616-620.

- DE BARY, A.: Comparative Morphology and Biology of the Fungi, Mycetozoa and Bacteria, 1887: 132-145.
- DUGGAR, BENJAMIN M.: Fungous Diseases of Plants, 1909: 135-173.
- ENGLER, ADOLF, and GILG, ERNST: Syllabus der Pflanzenfamilien, 7th Edition, 1912: 38-42.
- HOLDER, CHAS. F.: Methods of Combating Fungous Disease on Fishes. Bull. of the Bureau of Fisheries, xxviii: 935-936.
- JONES, L. R., GIDDINGS, N. J. and LUTMAN, B. F.: Investigations of the Potato Fungus, *Phytophthora infestans*. Bull. 168, Vermont Agricultural Experiment Station, August, 1912.
- KERNER, ANTON: The Natural History of Plants, 1895, ii: 668-672.
- MAGNUS, P.: Kurze Bemerkung über Benennung und Verbreitung der Urophlyctis bohemica. Centralblatt f. Bakteriologie, Parasitunkunde u. infektionskrankheiten, ix: 895-897, 1902; Ueber eine neue unterirdisch lebende Art der Gattung Urophlyctis. Ber. der Deutschen Bot. Gesellschaft., xix: 145-153, 1901; Ueber die in den Knolligen Wurzelschwämmen der Luzerne lebende Urophlyctis, do., xx: 291-296, 1902; Erkrankung des Rhabarbers durch *Peronospora Jaapiana*, do., xxviii: 250-253, 1910.
- MELHUS, I. E.: Experiments on Spore Germination and Infection in Certain Species of Oomycetes. Research Bull. 15, Agricultural Experiment Station, June, 1911.
- MIYAKE, K.: The Fertilization of *Pythium de Baryanum*. Annals of Botany, xv: 653.
- PETERSEN, HENNING E.: An Account of Danish Fresh-water Phycomycetes, with Biological and Systematical Remarks. Annales Mycologici, viii: 494-560, 1910.
- ROSENBAUM, J.: Studies of the Genus *Phytophthora*. Jour. Agric. Res. 8: 233-276, with pls. 7 and key, 1917.
- SPENCER, L. B.: Treatment of Fungus on Fishes in Captivity. Bull. Bureau of Fisheries, xxviii: 931-932, 1910.
- STEVENS, F. L.: The Fungi Which Cause Plant Disease, 1913: 66-101.
- TRONE, A. H.: On the Fertilization of Saprolegniæ. Annals of Botany, xviii: 541.
- VON TAVEL, F.: Vergleichende Morphologie der Pilze, 1892: 5-25.
- WAGER, H.: On the Fertilization of *Peronospora parasitica*. Annals of Botany, xiv: 263, 1900.
- WETTSTEIN, RICHARD R. V.: Handbuch der systematischen Botanik, 1911: 158-160.
- WILSON, GUY WEST: Studies in North American Peronosporales V. A Review of the Genus *Phytophthora*. Mycologia, vi: 54-83, March, 1914.
- ZIRZOW, PAUL: A New Method of Combating Fungus on Fishes in Captivity. Bull. of the Bureau of Fisheries, xxviii: 939-940, 1910.
- ZOPF, WILHELM: Die Pilze, 1890: 282-313.
- WAGER, H.: On the Structure and Reproduction of *Cystopus candidus*. Annals of Botany, x: 295, 1896.

CHAPTER XIV

HIGHER FUNGI

SUBCLASS MYCOMYCETES

The higher true fungi are characterized by a mycelium in which the hyphæ, as a rule, are permanently multicellular by the formation of transverse septa dividing the hyphal length into short cells. Some mycologists, among them Brefeld, think it important to call the fungi which are transitional between the PHYCOMYCETES and the MYCOMYCETES proper by the name MESOMYCETES, but the distinction between these intermediate forms and the higher fungi, being at times difficult to make, the writer has thought it best not to use the name MESOMYCETES, as that of a subclass. The student will see the justice of this viewpoint as the discussion proceeds.

Of unsatisfactory position in the fungous system are two families of fungi, which Brefeld includes in the subclass MESOMYCETES, which will illustrate his point of view as to transitional forms. Under HEMIASCINEÆ, as a suborder, he includes the families ASCOIDEACEÆ and PROTOMYCETACEÆ. Engler considers that these families have a doubtful systematic position. They show affinity to the PHYCOMYCETES, and yet, they have septate hyphæ and a sporangium, known as an ascus, which contains an indefinite number of spores, hence their closer affinity to the fungi of the order ASCOMYCETALES. The first family is represented by *Ascoidea rubescens* which lives on wounded beech tree trunks, particularly in the sap which flows from the wounds. It forms a brown felt-like growth. The richly septate hyphæ cut off laterally and terminally conidiospores and sporangia are formed in a series, so that as the numerous derby-hat-shaped spores are discharged and the sporangium is emptied of its contents a new sporangium forms inside of the walls of the old one, so that ultimately a sporangium may appear to arise out of a receptacle with a wall composed of three or four layers. In old cultures, the fruit-bearing hyphæ may be united to form *Coremia*. The genus *Dipodascus* belongs to this family. The

family PROTOMYCETACEÆ is represented by the genera *Protomyces*, *Monascus* and *Thelebolus*. *Protomyces* is a genus of fungi parasitic in the higher plants; for example, *P. macrosporus* lives in UMBELLIFERÆ, *P. pachydermus* in *Taraxacum*. The coprophilous fungus *Thelebolus stercoreus* lives on the excrement of rabbits. It has a large rounded sporangium surrounded by a cushion of hyphæ. Numerous spores suggestive of the moulds are formed within this sporangium.

ORDER III. ASCOMYCETALES.—The fungi of this order are characterized by a mycelium which lives either saprophytically, or parasitically, with animals or plants. It has with few exceptions a rank, or exuberant, development sometimes with apical growth. The hyphæ are septate and the cells are uninucleate, or plurinucleate. The reproduction of the majority of species is through endogenous spores known as ascospores, which are formed in definite numbers, usually eight, sometimes less (four, two, one), and sometimes more (sixteen, thirty-two, sixty-four, etc.) inside of a sporangium known throughout the order as an ascus (*ἄσκος* = wine-skin, water bottle). Frequently, they are called sac fungi, because of the sac-like ascus. The asci are found either isolated, or more generally, they are in fruit bodies where the asci are usually arranged along with the paraphyses between them in definite layers, which may be termed ascigeral. The paraphyses may assist in the discharge of the spores, but more usually their function is that of packing in which they serve also for the protection of the adjacent asci. The fruit body is an apothecium, when it is open with the ascigeral layer wholly exposed. Such apothecia may be platter-like, saucer-shaped, cup-shaped, or goblet-shaped, and either sessile, or stalked, the length of the stalks being a variable character. The perithecium is a closed fruit body sometimes produced under ground where it remains subterranean. It may be entirely closed with no opening (*cleistocarpous*), or it may open by a pore at the top. This pore may be borne directly at the top of the rounded perithecium, or the perithecium may be drawn out into a larger, or a shorter neck, so that it becomes flask-shaped, or bottle-like. A narrow canal may lead through the neck, which may be straight, or variously curved. Sometimes the paraphyses, which extend through the neck and out of the pore, are designated *periphyses*. As accessory fruit forms, we find the conidiospores, which are of various forms, and which are borne singly, or in chains, at the ends of vertical hyphæ (conidio-

phores), or they are inclosed fruit bodies with terminal pores known as pycnidia (pycnidium), and in such the conidiospores are termed pycnidiospores, or pycnospores. The hyphæ also break up into a disconnected series of spores known as chlamydospores, or the whole of the hypha set aside for reproductive purposes may break up into a connected series of spores, the oidiospores. Where the conidiophores are united together into strands, a coremium is formed. Sclerotia, or condensed masses of resting hyphæ, are not unusual in the order. Certain ascomycetous fungi are lichen fungi, as they are parasitic on green algæ and with them form the lichen thallus, which bears a certain nutritive relation with the organic or inorganic substratum, so that we may distinguish the crustaceous, foliose and fruticose kinds of lichen thalli. Where such lichen fungi and others of the order ASCOMYCETALES live on the surface of bark, they are *epiphloeidal*; where beneath the surface, *hypophloeidal*; where they live on rock surfaces, they are *epilithic*; in rock holes, *hypolithic*; and on the surface of the earth, they are *epigeic*; below the surface, *hypogeic*. The growth on the surface of animals is *ectozoic*, in animals *endozoic*. The growth on the surface of leaves and other plant parts is designated *epiphytic* or *epiphyllous*; inside the plant, as *endophytic*, or *endophyllous*. Zoospores are never formed in any of the fungi of the order. A few are aquatic.

That sexuality exists in forms of the ASCOMYCETALES has been determined only recently and these discoveries confirm the views of de Bary, who claimed that the process existed in this order, although Brefeld and his disciples claimed the contrary. Thanks to the epoch-making research of R. A. Harper, seconded by that of Claussen, J. P. Lotsy, Baur, Darbishire, Guillermond and others, the fact that sexuality exists has been proven indubitably. The first type displayed by *Pyronema*, *Boudiera* and related genera is where a multinucleate carpogonium with a trichogyne is fertilized by a multinucleate antheridium. A uninucleate antheridium unites with a uninucleate oogonium in the ERYSIPTACEÆ. The sexual organs are more or less reduced in many genera and in some of the ASCOMYCETALES, they are wanting completely. In the development of the sexual organs and in the behavior of the egg-cell, there is represented here a type of sexual reproduction which has its closest parallel in the red algæ (RHODOPHYCEÆ). There is a suggestive similarity between the structure of the sexual organs and the process of development

following fecundation in *Sphærotheca*, *Pyronema* and *Collema*, and in such red algæ as *Batrachospermum*, *Nemalion* and *Dudresnaya*. A sketch of the process will not be amiss. The antheridia and oogonia arise in *Pyronema* from the apical cells of thick hyphal branches, which arise vertically from the substratum. These organs stand side by side. Soon a trichogyne is formed on the oogonium, as a papillar outgrowth, and subsequently it is cut off from the oogonium proper by a transverse wall. The antheridium and oogonium are multinucleate from the start and a broad stalk cell is cut off from the base of the oogonium. The tip of the trichogyne curves over to meet the tips of the antheridium, and the wall between them is dissolved enough to form a pore by which the cytoplasm of one organ becomes continuous with the cytoplasm of the trichogyne in which the nuclei have already disintegrated. The antheridial nuclei migrate into the trichogyne, and while this is happening the nuclei of the oogonium move to the center, where they become collected into a dense, hollow sphere. Now the basal wall of the trichogyne breaks down and the antheridial nuclei pass into the oogonium and become mingled with those of the egg cell. The antheridia and carpogonial nuclei now become paired without fusing. Out of the oogonium grow ascogenous hyphæ and the paired nuclei pass into them. The young ascus develops from a penultimate cell of a bent ascogenous hypha with two nuclei which fuse, after the ascus has been formed and this fusion represents a sexual process. The end cell of the ascogenous hypha and the stalk cell are uninucleate, and these two cells may fuse to form a binucleate cell out of which a penultimate cell may arise. This single nucleus of the ascus then divides to form the series of eight ascospores usually found in the ascus. The synapsis stage of this single nucleus is immediately followed by a reduction division.

Claussen¹ has found that the formation of the ascus is not as simple a process, as described by Harper, and he has added materially to our knowledge by his reinvestigation of *Pyronema confluens* (Figs. 38, 39 and 40). He finds that the conjugate nuclei do not fuse in the ascogonium (carpogonium), nor in the ascogenous hyphæ, nor in the penultimate cell, nor when the tip cell of the ascogenous hook fuses with the stalk cell to form a binucleate cell. He finds that the penultimate

¹ CLAUSSEN, P.: Zur Entwicklungsgeschichte der Ascomyceten, *Pyronema confluens*. Zeitschrift für Botanik, 4, Jahrgang, Heft: 1-64 with 6 plates.

cell may proliferate a new hook with penultimate, tip and stalk cells and this another, and during this process of proliferation, the nuclei derived by descent from the antheridial nuclei remain distinct from those of the ascogonium (carpogonium). Even the two nuclei derived from the tip and stalk cells show this difference, and their descendants remain distinct with the proliferation of a new hook with stalk cell. The series of accompanying figures taken from the paper by P. Claussen will enable the student to understand the process better than a lengthy description.

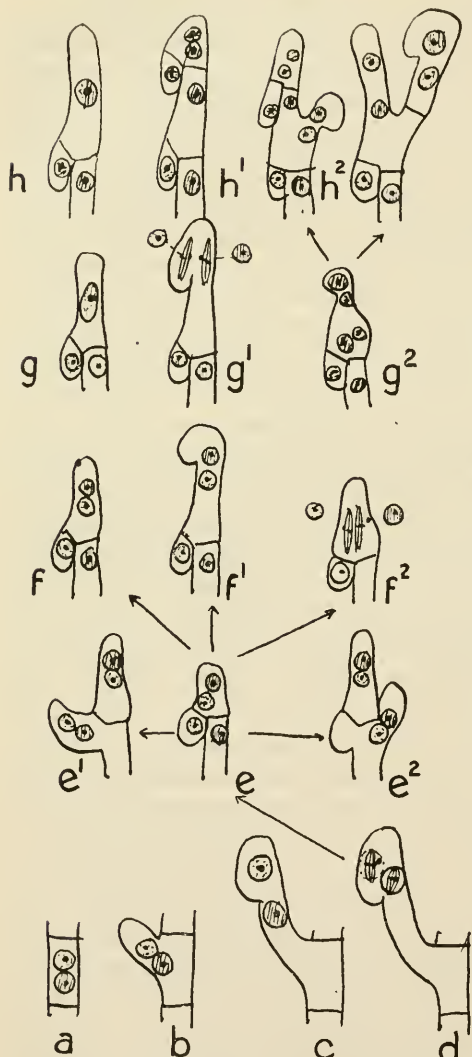

FIG. 38.—Diagrammatic representation of the observed methods of Ascus formation. (After Claussen, *Zur Entwicklungsgeschichte den Ascomyceten, Pyronema confluens*, *Zeitschr. für Botanik* 4 Jahrb., 1912.)

The antheridia and oogonia of *Sphærotheca* arise as lateral branches of neighboring mycelial filaments. The oogonium is cut off from the rest of the hypha by a transverse septa, and possesses a single nucleus. The antheridial branch appears quite near its base and grows upward pressed closely to the side of the oogonium. The antheridial cell with one nucleus is also cut off by a transverse septum. This nucleus now divides and one of the two nuclei passes into the attenuated end of the

The antheridia and oogonia of *Sphærotheca* arise as lateral branches of neighboring mycelial filaments. The oogonium is cut off from the rest of the hypha by a transverse septa, and possesses a single nucleus. The antheridial branch appears quite near its base and grows upward pressed closely to the side of the oogonium. The antheridial cell with one nucleus is also cut off by a transverse septum. This nucleus now divides and one of the two nuclei passes into the attenuated end of the

antheridium, which is cut off by a partition wall. The walls between the two organs are dissolved and the male nucleus passes through the opening formed wanders toward the egg nucleus with which it fuses. Immediately after fertilization, the oogonium begins steady growth, and some of the outer cells formed become the cover

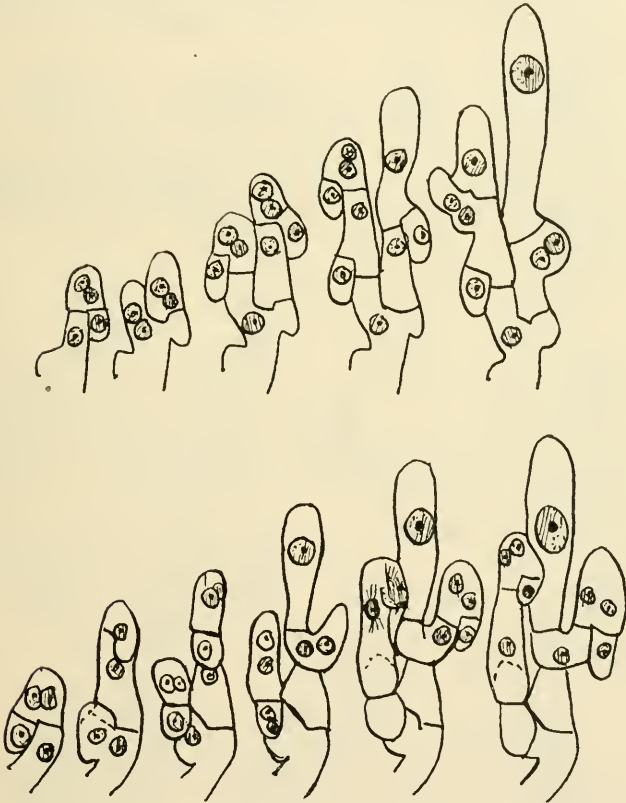

FIG. 39.—Diagrammatic representation of the development of the ascogenous hyphal system. (After Claussen.)

cells of the perithecium. But ascogenous hyphæ are formed, which contain two nuclei, then four nuclei by division with karyokinetic figures. Two of the nuclei wander to the curved side and this is cut off by two partition walls to form the binucleated penultimate cell, which becomes the mother cell of the ascus. The two nuclei of the

ascus now unite. The fusion or nucleus then divides to form those of the eight ascospores, and the walls of the perithecium grow to inclose the asci thus formed, including the paraphyses, which develop between the asci.

All of the typic ASCOMYCETALES have uninucleate hyphal cells, while the ascogenous hyphæ are binucleate, and in this case the nucleus has a double chromosome number. Hence is suggested an alternation of generations.

The life cycle of *Pyronema* may be displayed in a graphic form beginning with the ascospore and ending with its production again. The diploid, or twenty-four chromosome condition, may be represented by the double lines. This life cycle is contrasted with the well-known one of the fern where a well-marked alternation of generation is shown.

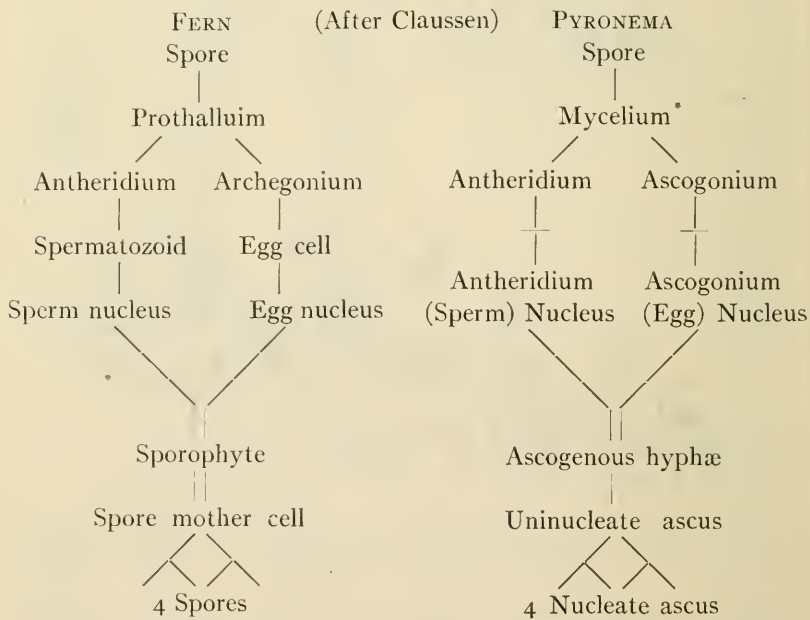

Brown, in his studies of *Leotia*, has shown that the asci are formed at the tips of the ascogenous hyphæ in several different ways (Fig. 41). In some cases, to quote him, "a hypha forms a typical hook,

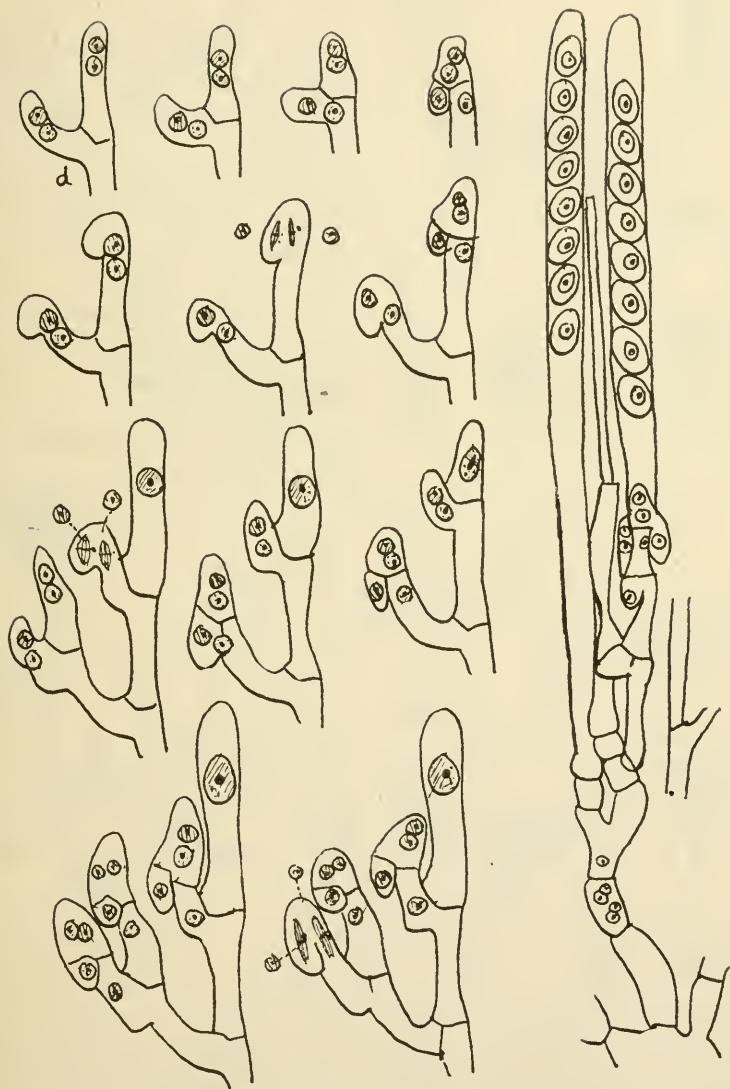

FIG 40.—Diagrammatic representation of the development of the ascogenous hyphal system and of the mature ascus. (After Claussen.)



FIG. 41.—9, Vegetative hyphae giving rise to storage cell; 10, paraphyses growing out from storage cells; 11–14, fusion of nuclei in storage cell; 15, 16, nucleus with two nucleoli in storage cell; 17, large storage cell with single very large nucleus; 18, storage cell with very irregularly shaped nucleus; 19, storage cell containing one large and two small nuclei; 20, an irregularly shaped storage cell; 21, 22, tip of asco-genous hypha with two nuclei; 23, two nuclei in tip of hypha have divided to four; 24, walls have come in, separating sister nuclei; 25, hook in which there is no wall cutting off uninucleate ultimate cell; 26, hook in which two nuclei have fused to

consisting of a binucleate penultimate and a uninucleate ultimate and antepenultimate cell. In this case, the two nuclei of the penultimate cell may fuse to form the nucleus of an ascus, or they may divide and give rise to four nuclei of another hook. The uninucleate ultimate cell usually grows down and fuses with the antepenultimate cell, after which the nuclei of the two cells may give rise to the nuclei of another hook or they may fuse to form an ascus. The walls separating the nuclei may fail to be formed without affecting the fate of the nuclei. In this process there is a conjugate division comparable to that in the rusts. Frequently the ascogenous hyphæ do not become markedly bent, and in this case, when the two nuclei in the tip divide, a wall may separate two pairs of sisters. Either of these pairs may divide and give rise to the nuclei of another hook or fuse to form the nucleus of an ascus. Any of the methods described above by which the number of asci is increased may be repeated many times. Large storage cells are formed in rows which give rise to the paraphyses. They are at first multinucleate but the nuclei fuse as growth proceeds. This process continues until often the cells contain a single very large nucleus many times the size of the largest nucleus in the ascus. The nuclei are very irregular."

BLACKMAN, V. H. AND FRASER, H. C., JR.: Fertilization in *Sphaerotheca*. *Annals of Botany*, 19: 567-569, 1905.

BROWN, W. H.: The Development of the Ascocarp of *Leotia*. *Botanical Gazette*, 50: 443-459.

CLAUSSEN, P.: Zur Entwicklung der Ascomyceten *Boudiera*. *Bot. Zeit.*, 68 (1905): Zur Entwicklungsgeschichte der Ascomyceten *Pyronema confluens*. *Zeitschrift für Botanik*, 4 Jahrgang, Heft 1: 1-64; Ueber neuere Arbeiten zur Entwicklungsgeschichte der Ascomyceten. *Ber. der. deutsch. Bot. Gesellschaft*. Jahrg., 1906, Band xxiv: 11-38 with complete bibliography.

ENGLER, A. AND GILG, ERNST.: *Syllabus der Pflanzenfamilien*, 1912: 47.

form nucleus of ascus, and tip has fused with stalk of hook; 27, ultimate cell has fused with antepenultimate; nucleus of latter has migrated into former, which is growing out to give rise to ascus or another hook; 28, two nuclei of penultimate cell have fused to form nucleus of ascus; ultimate cell has fused with antepenultimate and nucleus of latter has migrated into former, which has grown out to form another hook; 29, binucleate penultimate cell has given rise to hook; ultimate cell has fused with penultimate, and the two nuclei have fused; ultimate cell has not developed further; 30, binucleate penultimate cell has formed ascus, which fusion product of ultimate and antepenultimate has given rise to second ascus; 31, diagram illustrating multiplication of number of asci by method shown in 26-30; 9-20 \times 1400. 21-30 \times 2100. (After Brown, William H., *The Development of the Ascocarp of Leotia*. *Botanical Gazette*, 50: 443-359, Dec., 1910.)

- FRASER, H. C. J. AND WELSFORD, E. T.: Further Contributions to the Cytology of the Ascomycetes. *Annals of Botany*, xxii (1908).
- GUILLERMOND, A.: La quest. d.l. sex chez. l. Asc. et les. rec. trav. *Rev. gen. de Bot.*, xx (1908): *Recherches Cytologique Taxonomique sur les Endomycetes.* *Rev. gen. de Bot.*, 21: 353-39; 401-419 (1909) and a number of papers on the same subject in vol. 20.
- HARPER, ROBERT A.: Die Entwicklung der Peritheciiums bei *Sphærotheca Castagnei*, *Ber. d. Deutsch. Bot. Gesellsch.*, 13: 475-1895; Kernteilung und freie Zellbildung in Ascus *Jahrb. f. wiss. Bot.*, 30: 249-284, 1897; Cell Division in Sporangia and Asci. *Annals of Botany*, 13: 467-524, 1899; Sexual Reproduction in *Pyronema confluens* and the Morphology of the Ascocarp. *Annals of Botany*, 14: 321-400, 1900.
- MOTTIER, DAVID M.: Fecundation in Plants. Publ. 51, Carnegie Institution of Washington, 1904.
- SANDS, M. C.: Nuclear Structure and Spore Formation in *Microsphaera alni*. *Trans. Wisc. Acad. Sci.*, 15; 733-752; *Botanical Gazette*, 46:79.
- WARD, H. MARSHALL:: *Fungi*, *Encyclopedia Britannica*, 11th Edition.
- WETTSTEIN, RICHARD R.V.: *Handbuch der systematischen Botanik*, 1911: 169-172

CHAPTER XV

SAC FUNGI IN PARTICULAR (YEASTS, ETC.)

Suborder A. Protoasciineæ.—The fungi of this suborder are characterized by the absence of definite fruit bodies, that is the asci are not enclosed, but are free and at the ends of hyphæ. Usually they are of unequal length. Four is the typical number of ascospores in each ascus. These are one-celled and may increase in number by gemmation.

FAMILY 1. ENDOMYCETACEÆ.—This family is a small one of four genera of saprophytes and parasites. The two species of the genus *Podocapsa* are parasitic on MUCORACEÆ, *Eremascus albus*, the single species of that genus grows on spoilt malt extract. The genus *Endomyces* with five species is represented by the cosmopolitan *Endomyces decipiens*, which forms a snow-white parasitic growth on the toadstool *Armillaria mellea*. Its hyphæ are branched richly and the asci are pear-shaped and borne singly at the ends of the branches, each producing four helmet-shaped ascospores, 6 to 8 μ broad and 5 μ high. Conidiospores are more frequently formed than ascospores. Oidiospores are also found, as well, as chlamydospores. *Oleina nodosa* and *O. lateralis* are the two species of the fourth genus. The first grows in olive oil.

FAMILY 2. EXOASCACEÆ.—This family includes parasitic fungi which cause abnormalities of more or less marked character of the leaves, fruits and branches of mostly woody plants. The malformations are in the nature of witches' brooms of the smaller branches, leaf curls, and deformed fruits, such as the plum pocket. Stone fruits are especially subject to attack and in some cases the stone formation is suppressed entirely. The mycelium may be deep-seated and perennial, or it may be subcuticular, or sometimes found growing between the epidermal cells, as in *Magnusiella flava*, while in other forms, the hyphæ may be below the epidermis and grow throughout the leaf tissue. The asci are generally formed on the surface of the host breaking through from the more deep-seated mycelium beneath. They are generally stalkless and arranged in close proximity to each

other without paraphyses, so that they form a velvety layer on the surface of the host plant. Eight ascospores are generally found, as in the genus *Exoascus*, but in *Taphrina* (*Taphria*) the number may be increased considerably by budding, so that the whole ascus will be



FIG. 42.—*Exoascus* and *Taphrina*. A–F, *Exoascus pruni*, A. Appearance on diseased twig; B, cross-section of diseased fruit; C, mycelium in tissues of host; D, young asci; E, mature ascus with spores; F, germination of spores; G, E, *Exoascus alnitorquus*; H, *Taphrina aurea*, ripe and unripe asci; J, *Taphrina Sadebeckii*. See *Die natürlichen Pflanzenfamilien I. 1*, p. 159.

crammed full of them (Fig. 42). The ascospores are generally ellipsoidal and always one-celled with colorless, yellow, or orange contents.

The perennial mycelium is responsible for the formation of witches' brooms in a variety of trees and woody plants. Most of them are the

result of the parasitism of species of *Exoascus*. The "hexenbesen" are brush-like, or tufted masses of branches, which suggest the presence of other plants (like the mistletoe) parasitically or epiphytically growing. They result mainly by the infection of a bud which develops a branch with increased growth. On this branch, all dormant buds are stimulated to activity and the whole infected system of branches consists of negatively geotropic branches. These brush-like excrescences are called the thunder-bushes, and are sometimes nest-like in appearance. An anatomic study shows that the parenchymatous tissues—pith, hypodermis, etc.—are greatly increased; wood and bark are traversed by abnormally broad medullary rays, the ducts have short members, the wood fibers wide lumina, which are sometimes thin-walled and septate. The bast fibers are few, or entirely wanting. The cork cells are enlarged and retain their protoplasmic contents a longer time. The form of the witches' brooms are various. Many of them are pendent, some are nest-like, owing to the death of some of the branches. In some the branches are elongated, while some have short twigs. The end of the original branch from which the lateral branches developed usually dies and its food substances are absorbed by the hypertrophied branches. The family includes three genera, distinguished, as follows:

A. Asci found at the end of intercellular mycelial branches.

1. *Magnusiella*.

B. Asci developed on a more or less subcuticular ascogenous mycelium.

(a) Asci eight- (exceptionally four-) spored. 2. *Exoascus*.

(b) Asci many-spored by gemmation of the spores. 3. *Taphrina*.

The genus *Magnusiella* comprises five species, four of which are found in Europe and two in America. *Magnusiella flava* forms small pale yellow specks on the leaves of the gray birch, *Betula populifolia* in North America. The genus *Exoascus* includes about thirty species arranged in two subgenera, the first of which includes those species which deform fruits, which form witches' brooms, and the second those which cause a spotting of the leaves of various plants. It would lengthen this book unduly to enumerate all of the species of *Exoascus* with an account of the deformities of branches and fruits which they produce. Only a few of the more important species will be enumerated here,

and the diseases which they cause will be described later. *Exoascus pruni* (Fig. 42) is the cause of an important disease of plum trees, producing the so-called plum pockets. It also attacks *Prunus domestica* and *P. padus* in middle Europe, and *P. domestica* and *P. virginiana* in North America. *Exoascus communis* attacks the fruits of several American species of *Prunus* among them *P. maritima*. *Exoascus alnitorquus* infests the pistillate spikes and cones of species of alder (*Alnus*), such as *Alnus glutinosa* and *A. incana* in middle Europe, and *A. incana* and *A. rubra* in North America, causing an enlargement of the fruit scales into twisted, tongue-like, reddish outgrowths. *Exoascus deformans* is the cause of peach-leaf curl. *Exoascus cerasi* is responsible for the formation of witches' brooms on the cherry. The genus *Taphrina* causes witches' brooms and leaf spots. *Taphrina purpurascens* attacks the leaves of a North American sumac, *Rhus copallina*, causing a puckering of the leaves with the formation of a reddish-purple color. *T. aurea* (Fig. 42) forms yellow blotches on the leaves of several European and North American poplars, viz., *Populus nigra* and *P. italica* of Europe, and *P. Fremontii*, *P. grandidentata* and *P. deltoides* of North America. *T. Laurencia* causes witches' brooms on a fern in Ceylon, *Pteris quadriaurita*.

Suborder B. Saccharomycetiineæ.—A true filamentous mycelium is absent in the fungi of this suborder. The plants are single-celled and reproduce by budding, or gemmation. Occasionally under experimental treatment where the culture media are varied, the cells develop into hyphæ and together form a mycelioid growth. Spore formation consists in a single cell, developing one to eight spores. It, therefore, may be looked upon as an ascus and the spores are ascospores. Many of them cause fermentation.

FAMILY I. SACCHAROMYCETACEÆ.—Many species of the genus *Saccharomyces* are called generically yeasts, and are of economic importance, because they induce the alcoholic fermentation of carbohydrate substances. The action is accomplished through a soluble enzyme formed in the protoplasm of the yeast cell, and first isolated by Buchner by grinding the yeast cells in sand and extracting the ferment zymase. The general shape of yeast cells is oval, ellipsoidal, and pyriform (Figs. 43, 44). The cell wall is well defined and consists of modified forms of cellulose which may be called fungous cellulose, because it does not react to the reagents used for true cellulose. This

much can be said that the wall consists of a carbohydrate, probably some isomer of cellulose. Lining the inner surface of the cell wall is a layer of protoplasm which may be called the ectoplasm, which probably serves as an osmotic membrane. The cytoplasm fills the rest of the cell with the exception of spaces occupied by the vacuoles of glycogen, nuclear vacuoles, oil globules, the nucleus and nuclear granules. The glycogen is gradually used up as it probably serves as reserve food, the same as starch in the higher plants. These glycogen vacuoles generally coalesce until one large vacuole may almost fill the cell,

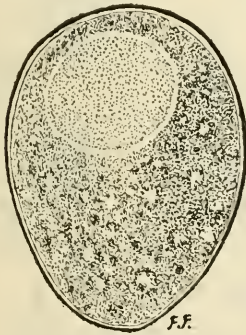

FIG. 43.

FIG. 43.—Yeast cell, *Saccharomyces cerevisiae*. (After Marshall.)

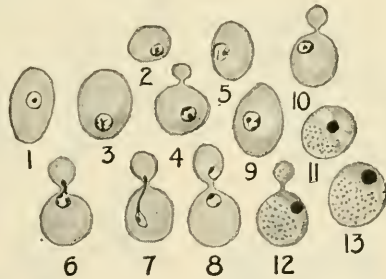

FIG. 44.

FIG. 44.—Yeast, *Saccharomyces cerevisiae*. 1-10, Young cells with nucleus, showing its structure; 6-8, division of nucleus; 11-13, cells after twenty-four hours' fermentation with large glycogenic vacuole filled with lightly colored grains. (After Marshall, *Microbiology*, Second edition, p. 62.)

the cytoplasm and nuclear bodies being pressed against the cell wall and forming a thin protoplasmic lining to the inner cell wall surface. Wager¹ in 1898 demonstrated the nuclear apparatus in a number of yeast species. The nuclear apparatus consists in the earliest stages of fermentation of a nucleolus in close touch with a vacuole (Fig. 44, No. 4) which includes a granular chromatin network suggesting a similar structure in the higher plants. The vacuole may disappear and then the chromatin granules are scattered through the protoplasm, or are gathered around the nucleolus, which is present in all of the cells, as a perfectly homogeneous body. Numerous chromatin vacuoles are often found

¹ WAGER, HAROLD: The Nucleus of the Yeast Plant. The Annals of Botany xii: 400-539.

in young cells and these ultimately fuse to form a single vacuole which occurs in the cells during the earlier and the later fermentation. The process of budding is associated with the stretching of a network of nuclear granules and its final constriction in the neck between the mother and the daughter cell. The nucleolus moves to the constriction where it becomes dumbbell-shaped, one half pressing into the daughter cell (Figs. 44 and 45). There are no stages of karyokinesis displayed, but by the simple process described above the daughter cell receives approximately one-half of the nuclear substance of

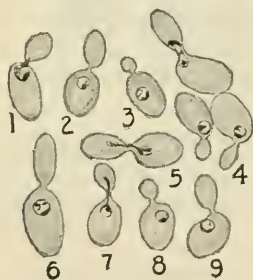

FIG. 45.

FIG. 45.—Young yeast cells, *Saccharomyces ellipsoideus*, with nuclei and division of nuclei. (After Marshall, *Microbiology*, Second edition, p. 64.)



FIG. 46.

FIG. 46.—Yeast, *Saccharomyces cerevisiae*, the variety known as brewers' bottom yeast; a, spore formation; b, elongated cells. (After Schneider, *Pharmaceutical Bacteriology*, p. 144.)

the mother cell. In spore formation, the chromation which is scattered through the cytoplasm is absorbed more or less completely into the nucleolus which elongates and divides by a constriction in its middle part. Subsequent divisions result in the formation of four nucleoli around which protoplasm collects and thin membranes which become the walls of the ascospores which remain at first small, but later increase in size (Fig. 46). The formation of spores can be secured by taking

a sterile block of plaster of Paris with a saucer-shaped hollow on top. This block is placed in sterilized water and the top is seeded with vigorous, young well-nourished yeast plants which develop spores if kept at 25°C., in from twenty-four to forty-eight hours. The temperature at which spore formation occurs and the time which it takes for sporulation are points which have been obtained by experimentation for all the more important species of yeasts. The data which has been obtained is used in the physiologic diagnosis, or identification of the various kinds of SACCHAROMYCETACEÆ, which react differently under experimental treatment. Film formation is also of diagnostic importance, where economic yeasts form floating films on the nutrient liquid media in which they are grown. The time required for the development of the film differs, other conditions being equal, with the species of the yeast and is longer the lower the temperature of the culture. Hansen obtained the following data for *Saccharomyces cerevisiæ*;

Film formation takes place at:

- 33° to 34°C. in about 9 to 18 days.
- 20° to 28°C. in about 7 to 11 days.
- 13° to 15°C. in about 15 to 30 days.
- 6° to 70°C. in about 2 to 3 months.

No formation of film occurred above 34°C. or below 5°C. Another point of importance is that species of *Saccharomyces* form films so that this process is not entirely associated with the fungi belonging to the so-called genus *Mycoderma*. In fact some authors recognizing that *Saccharomyces cerevisiæ* (Fig. 47) produced films have named that yeast, *Mycoderma cerevisiæ*, and have thus confused its identity.

Hansen in a paper published in 1888 classified the yeasts essentially, as follows:

1. Species which ferment dextrose, maltose, saccharose: *Saccharomyces cerevisiæ* I, *S. Pastorianus* I, *S. Pastorianus* II, *S. Pastorianus* III, *S. ellipsoideus* I, *S. ellipsoideus* II.
2. Species which ferment dextrose and saccharose, but not maltose: *Saccharomyces Marxianus*, *S. exiguus*, *S. Ludwigi*, *S. saturnus*.
3. Species which ferment dextrose, but neither saccharose nor maltose: *Saccharomyces mali Duclauxii*.

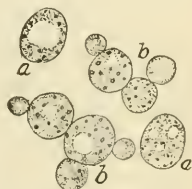

FIG. 47.—Yeast, *Saccharomyces cerevisiæ*, showing reproduction by germination, or budding; a, single cells; b, budding cells. (After Conn, *Agricultural Bacteriology*, p. 8.)

4. Species which ferment dextrose and maltose, but not saccharose *Saccharomyces* n. sp. obtained from stomach of bee by Klöcker.

5. Species which ferment neither maltose, dextrose nor saccharose: *Saccharomyces anomalus var belgicus*, *S. farinosus*, *S. hyalosporus*, *S. membranifaciens*.

The general chemic phenomena associated with the formation of alcohol by fermentation out of sugar may be expressed by the formula:



The carbon dioxide passes off in bubbles as a gas, while the alcohol remains in solution.

The most important yeast is the beer yeast *Saccharomyces cerevisiæ* which is a unicellular plant of spheric or elliptic shape 8 to 12 μ long and 8 to 10 μ broad. Sometimes the cells formed by budding remain connected to form a chain consisting of the mother, daughter, granddaughter and great-granddaughter cells. Spore formation is characteristic and the size of the spores varies from 2.5 to 6 μ . There are usually four spores in each cell. The following gives the temperature conditions of spore formation in this species:

At 9°C. no spores develop.

At 11° to 12°C. the first indications are seen after 10 days.

At 30°C. the first indications are seen after 20 hours.

At 36° to 37°C. the first indications are seen after 29 hours.

At 37.5°C. no spores develop.

The temperature limits for film formation are 33° to 34°C. and 6° to 7°C. There are a number of races of the common beer yeast, which may be separated into the bottom yeasts and the top yeasts. The bottom yeasts are those which live within the liquid and mostly at the bottom even from the start. Some of these yeasts form spores with difficulty. The top fermentation yeasts are those which grow on the surface of the liquid and cause a brisk fermentation with a large amount of froth, or head, as exemplified by the Munich lager-beer yeasts. Yeasts are among the oldest of cultivated plants, as in biblical times leavened (yeast-raised) and unleavened bread were known. The leaven was a lump of dough kept from one baking to the next. Unleavened bread was simply flour mixed with water and baked, and as a result, a hard tough bread was obtained. The use of yeast as a

starter began in Roman times, but the art was lost until the seventeenth century, when it was regained. One of the earliest methods of obtaining yeast was salt raising, which consisted in adding to a quantity of milk a little salt sufficient to delay the growth of bacteria, while the yeast found entrance to the milk through the air and grew rapidly. This milk was then mixed with dough for the raising process. Bakers also sometimes used a brew called barm. Scotch barm was prepared by taking hops and flour with other ingredients which were allowed to



FIG. 48.—*Saccharomyces ellipsoideus*. A common yeast in jams, jellies, etc. Budding process is shown in many of the cells as also the vacuoles. Fig. 66, p. 145, Schneider, *Pharmaceutical Bacteriology*, 1912.

ferment spontaneously, and the fermented material was used in bread baking (see page 667).

Saccharomyces ellipsoideus (Fig. 48) is known as the wine yeast and may be classed as a wild species, while the beer yeast is found only in cultivation. The vegetative cells are ellipsoidal 6μ long, single, or united into a row of loosely connected cells. The cells are two- to four-spored. The spores are spheric 2 to 4μ broad. It is important in the fermentation of grape juice, gaining entrance from the skin of the grape fruit upon which it lives. In the spore form, it overwinters in the soil, being blown as dust to the developing grape fruits. The

bouquet, or flavor of the wine seems to be due to the variety of wine yeast used in the fermentation of the juice, for every wine-producing region seems to have its especial form of wine yeast and the growth is different. Some yeasts, such as those of Burgundy and Champagne, form a compact sediment, which quickly settles leaving the liquid clear, while others remain for a long time suspended and settle slowly. *Saccharomyces ellipsoidus II* is a very dangerous disease yeast, producing turbidity in the liquid of bottom fermentation breweries.

Saccharomyces Pastorianus I was first discovered in the dust of a Copenhagen brewery and also in diseased beer. Its growth in wort consists of sausage-shaped cells. *S. Pastorianus II* produces a feeble top fermentation. *S. Pastorianus III* was found in bottom fermentation beer affected with yeast turbidity.

Saccharomyces ilicis and *S. aquifolii* were found on the fruits of the holly, *Ilex aquifolium*.

Saccharomyces Vordemanni is similar in appearance to wine yeast, its cells being onion-shaped, or pear-shaped. It is present in Raggi, which is employed in Java in the manufacture of arrack. It forms 9 to 10 per cent. alcohol.

Saccharomyces pyriformis was discovered by H. Marshall Ward to be active in the formation of ginger beer in conjunction with *Bacterium vermiforme*, for when these organisms are added to a sugar solution containing ginger, an acid beverage with considerable head is formed known as ginger beer.

Saccharomyces exiguus occurs in pressed yeast, and it is capable of developing considerable alcohol from dextrose and saccharose solutions. *Saccharomyces anomalus* has been found in impure brewery yeast in Hungary, also in Belgian beer, on green malt, on bran, in syrup of *Althæa*, in soil, and on plum fruits. It ferments wort readily forming a gray film, a turbidity in the liquid, and an odor like fruit ether. The spores are helmet-shaped, suggesting those of *Endomyces decipiens*, which is parasitic on the caps of *Armillaria mellea*, a toadstool. *Saccharomyces membranifaciens* grows in a gelatinous mass on the injured roots of elm trees, in polluted water, and in white wines, where it destroys the bouquet of the wine. It completely consumes acetic and succinic acids, and quickly forms gray corrugated films on the surface of wort. The organisms of Kefir are *Saccharomyces cartilagenosus* and *S. fragilis*. Kefir is a beverage prepared originally in the Caucasus region by fer-

menting milk. Kefir grains, which include the above yeasts, a *Torula*, and 3 bacteria (*Bacillus caucasicus*, etc.) are added to the milk as a starter. The fermentation of the milk results in the formation of alcohol lactic acid and carbonic acid. Mazum (Matzoon) an Armenian drink, is prepared by adding a white, fatty cheese-like mass, to milk. The starter includes colored yeasts *Oidium lactis*, mould fungi, a yellow *Sarcina*, *Bacillus subtilis*, some cocci, *Bacterium acidi lactici* and *Saccharomyces anomalus*. The only species of yeast, which can be recognized immediately by microscopic examination, is *Saccharomyces Ludwiggii*, with its lemon-shaped vegetative cells, on the point of which a wart makes its appearance, which is cut off by a septum from the rest of the cell. This species is transitional to those included in the genus *Schizosaccharomyces*. The form of *Saccharomyces Ludwiggii* suggests *S. apiculatus*, which is unequally dumbbell-shaped. The genus *Torula* according to Hansen includes yeasts similar to *Saccharomyces*, but which do not form endospores, a typical mould growth, and which produce alcohol in all percentages. They are widely distributed in nature.

Schröter in Engler's "Die natürlichen Pflanzenfamilien" recognizes only two genera in the yeast family, namely, *Saccharomyces* and *Monospora*. The reproductive cells of the former have two to eight (seldom one to three) spores and the spores are spheric, or ellipsoidal, while the needle-shaped spores of *Monospora* are borne singly in reproductive cells, or asci. Hansen¹ considers *Monospora* to be a doubtful form of yeast (*Saccharomyces douteux*), as also the genus *Nematospora*. He recognizes the following genera: *Saccharomyces*, whose spores have a single membrane and the cells reproduce by budding; *Zygosaccharomyces*, where the asci are associated with conjugation; *Saccharomycodes*, whose spores have one membrane and sprout into a promycelium; *Saccharomycopsis*, whose spores have two membranes; *Pichia* with hemispheric or angular spores and *Villia* with citron-shaped spores. Lafar in his book on "Technical Mycology" (II, part 2, page 274) gives an analytic summary of the genera which he believes should be recognized. The position of such genera as *Zygosaccharomyces*, *Saccharomycopsis*, *Schizosaccharomyces* with respect to nearly related fungi is presented and discussed with a diagrammatic scheme of relationship by

¹ HANSEN, E. CHR.: Grundlinien zur Systematik der Saccharomyceten. Centr. f. Bak., 1904.

Guillermont,¹ who suggests the probable evolution of such forms from *Eremascus* and *Endomyces*. Dr. H. Will discusses in Lafar's book the family TORULACEÆ, species of which are widely disseminated on field and garden fruits and on plants of all kinds finding suitable conditions for their growth during the decay of these fruits, and during the technic processes of fruit preservation, such as the making of pickles and sauerkraut. A number of them will no doubt prove to be budding stages of other fungi for our knowledge of them is decidedly imperfect. The character of the so-called pink yeast, red yeast, and black yeast is even less well known. As they are budding fungi, some have even classed them with the genus *Saccharomyces*. The genus *Mycoderma* was created to include the budding fungi, which form true films and which are formed rapidly on nutrient liquids, particularly on beer and wine with air between the cells, which are usually short and sausage-shaped. They are strongly aerobic and form, when exposed to the air, a wrinkled skin on the surface of the liquid. Like the true wine yeasts, these various species of *Mycoderma* have their natural habitat in the soil and they are carried to their appropriate nutrient substances by insects, rain or wind. They are probably not true yeast plants, but may represent growth conditions of other fungi, as related to certain nutrient materials. Curious chemic activities are possessed by species of *Mycoderma*, for example, the formation of acids and their destruction both at the same time. Citric and succinic acids for example are consumed by them.

¹ GUILLERMOND, M. A.: Recherches Cytologiques et Taxonomiques sur les Endomycetes. Revue Generale de Botanique, 21: 401-419, 1909.

CHAPTER XVI

SAC FUNGI CONTINUED

Suborder C. Plectasciineæ.—This suborder includes fungi with a well-developed mycelium on which are developed either on the surface of the substratum or within it; as in the subterranean forms, closed perithecia without an opening at the top. The wall of the perithecium is sometimes called the peridium. The asci are developed on hyphæ of irregular branching, and in considerable numbers, forming irregular layers of the perithecial interior. Each ascus is rounded and three- to eight-spored. The spores are one- to many-celled. Conidiospores occur in a few of the forms, such as *Aspergillus*, *Meliola* and *Penicillium*. Many of the fungi of this suborder are saprophytic, but some are decidedly parasitic, as *Thielavia basicola*, which destroys the roots of pea plants by its parasitic growth and species of the families TERFEZIACEÆ and ELAPHOMYCETACEÆ, the mycelia of which form mycorrhiza with roots of flowering plants. Economically, the suborder is interesting, because it includes the common blue and green moulds and species of *Aspergillus* used in the fermentation industries. The fruit bodies of several kinds of *Terfezia* are used as food by the Arabs of North Africa, Arabia, Syria and Mesopotamia.

FAMILY 1. GYMNOASCACEÆ.—The fungi of this family are of interest, because of the structure of their fruit bodies. In the genus *Gymnoascus*, the spheric asci arise on short lateral branches of hyphæ which form a dense rounded mass inclosed by loosely branching hyphæ, which form a basket-like inclosure of the ascus-bearing portion *Gymnoascus Reesii* is coprophilous. Some of the shorter branches of this outer envelopment are sharp-pointed and spiny. *Ctenomyces serratus*, the single representative of its genus, grows on decaying bird feathers. It has branches with short hook-like extremities. The fruit body in this fungus is similarly rounded and covered with hyphæ that form an open basket-like peridium.

FAMILY 2. ASPERGILLACEÆ.—This family includes fourteen genera, the most important of which are *Aspergillus*, *Penicillium* and

Thielavia. The perithecia are never subterranean. They are usually small, spheric, usually closed, and their walls are made up of pseudo-parenchymatous hyphæ. They rarely open by a pore, more usually they break up at maturity to allow the escape of the ascospores. The inclosed asci are spheric to pear-shaped and two- to eight-spored.

The moulds of the genus *Aspergillus* (Figs. 49 and 50) are usually saprophytic, and are found upon decaying vegetables, moldy corn and other cereals. After the conidiospores are formed, the color of the mould develops and various shades of green, white, blackish-brown, brownish-yellow, brown and reddish are found in the different species of the genus. The recognition of this genus is made easy by the shape of the conidiophores, which are elongated unicellular (unseptate) and terminate in a globular swelling, the top of which is covered with a large number of closely set stalks, or sterigmata, of variable length and shape on which the conidiospores develop. In the related genus *Sterigmatocystis*, the sterigmata are branched (Fig. 51). The conidiospores are spheric, or ellipsoidal, always unicellular with smooth or granular walls, and are formed in long chains (concatenation) from each sterigma imparting the characteristic color to the whole growth. The perithecia are fragile spheres with thin walls which may be yellow (*A. herbariorum*) dark red (*A. pseudo-clavatus*), or even black (*A. fumigatus*) in color. The perithecia and asci are unknown in many of the species, so that the classification of the species cannot be based on the characters of that organ and of the ascospores. Only about six to ten species are known to have perithecia out of a possible total number of 120 species included in the genus. This number will probably be considerably reduced when these moulds are better known. The accompanying figures show some of the specific differences of the conidiophores and conidiospore production. The common green mould, *Aspergillus herbariorum* (= *Aspergillus glaucus*, *Eurotium Aspergillus glaucus*) grows on many substances such as dried plants in the herbarium, (hence its specific name), on old black bread (pumpernickel), on jellies, on jams, on old leather, on herring pickle and other objects of domestic use. At first the mycelium is white and as the young conidiospores begin to form it turns to a pale green, later becoming a dirty grayish green, while the feeding hyphæ change color to a pale yellow and finally a brown color by the deposit of pigment granules. The globular part of the conidiophore is 60 μ across and crowded with simple sterigmata

(7μ by 14μ), bearing prickly, spheric conidiospores 7 to 30μ in diameter which are larger than any other well-known species. It produces perithecia also with readiness and in abundance. The at first pale brown-yellow perithecia, later brown, are about 100 to 200μ in diameter in closing numerous asci which contain five to eight colorless smooth ellipsoidal spores, exhibiting a furrow directed longitudinally and 5 to 8μ broad by 7 to 10μ long. The perithecium develops gradually from spirally coiled hyphæ. The hyphæ of the screw are divided

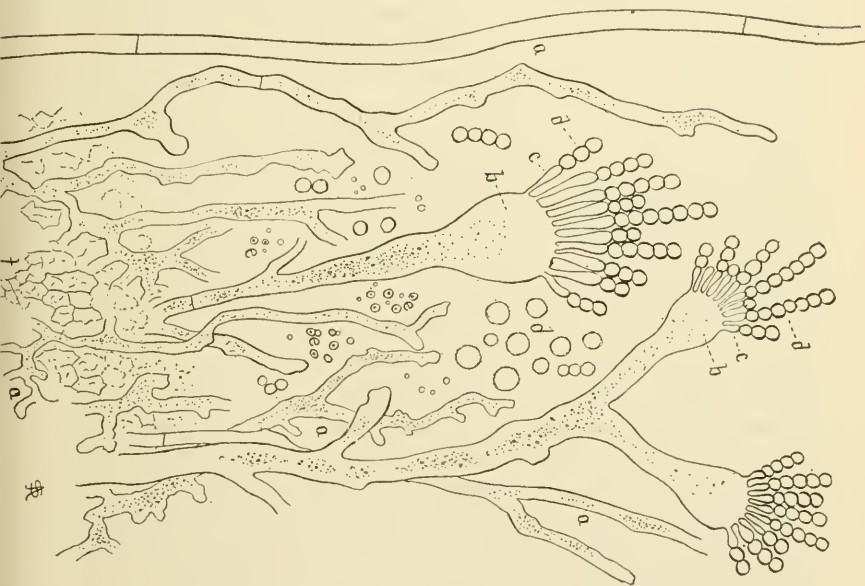

FIG. 49.—*Aspergillus oryzae* associated with yeasts in the making of the Japanese beverage Saké. Vegetative hyphæ (a) and spore-forming hyphæ (b, c, d) are shown. Fig. 71, p. 152. (Schneider, *Pharmaceutical Bacteriology*, 1912, 19.)

transversely into as many cells as there are turns of the screw. The bottom hyphal cells of the screw send up two or three branches of irregular thickness which grow toward the apex. One of these branches looked upon as an antheridium grows more rapidly than the others and its contents serve to impregnate the inclosed carpogone. These outer erect hyphæ then branch copiously to completely envelope the carpogone and the perithecial wall is thus formed. From the carpogone are now formed the numerous ascogenous hyphæ, which branch plenti-

fully and bear terminally asci of a pyriform shape. These contain eight grooved ascospores. *Aspergillus herbariorum*, as a domestic and industrial fungus, is selective. It does not thrive on liquid saccharine media with mineral salts and inorganic nitrogenous food, while black bread and wort gelatin are suitable media. Moderate temperatures (8 to 10°C.) are best for its growth, and it ceases growth entirely at blood temperatures. The temperature limits are 7° to 30°C. with optimum at 20 to 25°. It grows on tobacco, cigars, hops, cotton-seed meal, acid pickles, and smoked meats. It causes the blackening and spoiling of chestnuts and is found on the kernels of various nuts even before they are removed from the shell (see Appendix VII, pages 702 to 721).

The rice mould, *Aspergillus oryzae* (Fig. 40), is of practical importance as a saccharifying fungus, and it has been cultivated for centuries by the Japanese and used by them in the preparation of the rice mash for Saké, as well as in the production of Miso and Soja sauce. It grows luxuriantly and is usually yellow-green in color turning brown with age with large closely set tough conidiophores about 2 mm. tall. The tops of its conidiophores are obovate, or spheric. The sterigmata are radially arranged producing yellowish-green spheric conidiospores (6 to 7 μ) in chains. The sterigmata are larger than in *A. herbariorum* 4 to 5 μ by 12 to 20 μ . No perithecia have yet been observed. This mould secretes a very active diastase and it has been used in the making of pharmaceutic preparations, such as Taka diastase, which is used in the dose of 2 to 5 grains either in tablet, capsule or solution in cases of indigestion immediately after meals. It converts the starchy food into dextrin and sugar. The discovery of this diastase in *Aspergillus* was made by Takamine, a Japanese zymologist, and his product has been used over the civilized world.

Aspergillus Wentii, which is readily kept in culture on glucose or beerwort agar, is used in the preparation of Tas Gu in Java. It appears spontaneously on boiled soy beans that have been covered with leaves of *Hibiscus* and it causes a loosening and disintegration of the firm tissues of the bean. The growth of this species is of a pale coffee color with conspicuous conidiophores about 2 to 3 mm. in height, their thick brown heads up to 200 μ in diameter are on pale smooth stalks. The end of the conidiophore is globular 75 to 90 μ in diameter and is covered with slender simple sterigmata (4 μ by 15 μ) which bear small globular to elongated conidiospores, 4 to 5 μ diameter. The mycelium at first

is snow-white; later it becomes reddish brown. The discovery of perithecia is yet to be made.

Aspergillus flavus plays an important part in the cocoon disease of silkworms. The stipe portion of its conidiophore is roughened by colorless granules.

Aspergillus luchuensis, according to Inui, is used in the preparation of a beverage Awamori, which resembles whisky and is used in the Loochoo islands.

Aspergillus tokelau is found in Tokelau, or Samoan disease, attacking the natives of certain of the Pacific islands. An important pathogenic species, which causes an epidemic disease of pigeons and lives in the human ear and the lungs of various birds, is *Aspergillus fumigatus*, which was the cause of a false tuberculosis of a calf in Philadelphia. An autopsy by Ravenel and the writer showed the lung tissue of the calf penetrated by the mycelial hyphæ of the fungus, and its conidiophores bearing the conidiospores in a fan-like manner were seen projecting into the lung cavities almost completely filling them. It, therefore, grows well at blood temperature, and if its conidiospores are introduced into the arterial circulation of animals they germinate and produce serious illness, which may terminate fatally. It also acts injuriously in certain fermentation processes carried on at high temperatures as certain lactic acid fermentations. It attacks tobacco, decaying potatoes, bread, malt and beerwort. It has dwarf conidiophores 0.1 to 0.3 mm. long, with club-shaped globules 10 to 20 μ thick, upright sterigmata 6 to 15 μ long and with long chains of conidiospores (2 to 3 μ). Nut-brown globular perithecia are found, 250 to 350 μ in diameter, inclosing oval thin-skinned asci (9 to 14 μ) with eight red lenticular tough-walled spores (4 to 4.5 μ). As a parasite of the human skin it was called *Lepidophyton*. The green mould, which usually grows on malt, is *Aspergillus clavatus* causing a moulding of the substratum. The largest species of the group is *Aspergillus giganteus*, which looks at first superficially like a *Mucor*, but later owing to its grayish-green conidiospores it is readily separable from the mucor vegetation. Its sterigmata seem to be hollow, communicating with a pore-like opening with the center of the conidiophore. No perithecia have been found. Other species are *A. nidulans* (Fig. 50), which can be cultivated readily, *A. varians* and *A. ostianus*, the latter distinguished by an ochraceous pigment. The black mould *Aspergillus niger* more properly *Sterigmatocystis niger*

(Fig. 51) has a copious literature. Laffar cites forty workers of recent date, who have studied it. The physician finds it as an occupant of

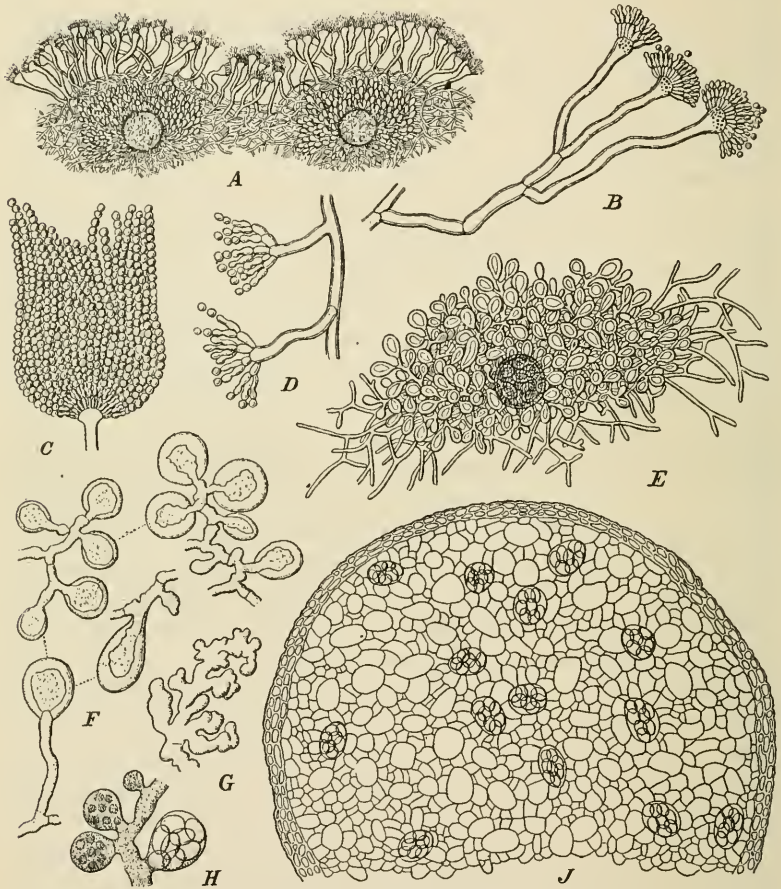

FIG. 50.—*Aspergillus nidulans*. A, Mycelium with conidiophores; B, branched conidiophore; C, spore chains at end of conidiophore; D, small conidiophores; E, young fruit showing development of covering; F, hyphæ with swollen ends; G, hypha from interior of fruit-body; H, hyphæ with young asci; J, developing perithecium. (See *Die natürlichen Pflanzenfamilien* I. 1, p. 302.)

the human ear in a disease otomycosis. It is associated with the cork disease which imparts a taste to bottled wine. It grows well in acid substrata, as gall-nut extract, tannic acid and has a decided capacity

for producing oxalic acid. It has stiff slender conidiophores several millimeters in height. The terminal part can be studied only after the bleaching or removal of the dark masses of conidiophores.

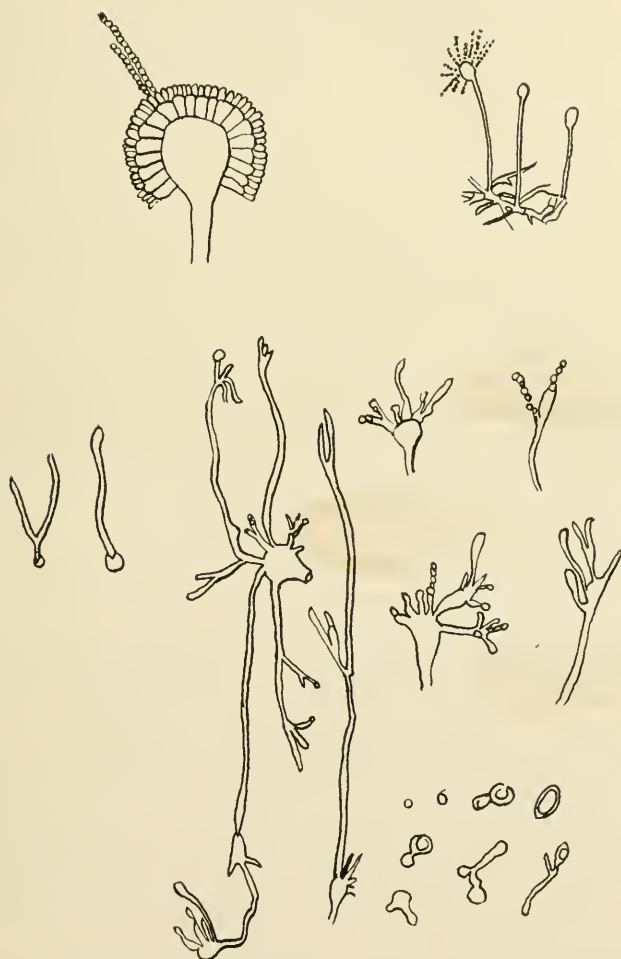

FIG. 51.—*Sterigmatocystis niger* (*Aspergillus niger*) showing conidiophores and conidiospore formation with stages in germination of spores. (After Henri Coupin.)

The genus *Thielavia* is represented by a common pathogenic species, *T. basicola*, whose life history and pathogenic character will be de-

scribed later. It attacks the roots of a large series of plants including the tobacco, at least 105 species of plants being attacked according to the latest account.¹ The parasitic mycelium is intercellular, abundantly septate and hyaline. It produces conidiospores, which are abjoined acrogenously from the conidiophore, and are not as was supposed formerly endospores formed by free cell division within an endoconidial cell. The first conidiospore is liberated by the differentiation of its walls into an inner wall and a sheath and by the rupture of the latter at its apex. The later conidiospores grow out through the sheath of the first and are freed by a splitting of their basal walls.² This same process is probably that of all "endoconidia" in fungi.

FAMILY 3. ELAPHOMYCETACEÆ.—The fruit bodies of the fungi of this family are subterranean with a distinct, mostly thick peridium whose surface is marked by a more or less strongly developed rind. The asci borne within the closed fruit body are irregularly arranged and united into large groups, which are separated by radially arranged vein-like masses of sterile hyphæ. The asci are spheric, or pyriform, and mostly eight-spored. The whole spore-bearing interior of the fruit body, when ripe, is transformed into a powdery mass with the sterile hyphæ remaining as a number of capillitia-like threads. There is no spontaneous opening of the fruit body at maturity. The family includes a single genus, *Elaphomyces*, which comprises about twenty-two species, found mostly in northern Italy, in Germany and France, a few in England, northern Europe and North America. Such species, as *Elaphomyces papillatus*, *E. atropurpureus* from the oak and chestnut woods of northern Italy, *E. mutabilis* with a silvery-white mycelium growing in the oak, beech and birch woods of northern Italy, France and Germany, *E. citrinus* with an orange-yellow mycelium, also from northern Italy, all have delicate thin rinds which become wrinkled when dry, and belong to the section *Malacodermei*. The section *Sclerdermei* includes those species with compact brittle rind, which is not wrinkled when dry. Here belong *E. maculatus* with strongly developed, green mycelium, surface of fruit body blackish brown with greenish markings, found in the oak forests of northern Italy, French

¹ JOHNSON, JAMES: Host Plants of *Thielavia basicola*. Journ. Agric. Res., vii: 289-300, Nov. 6, 1916.

² BRIERLEY, WILLIAM B.: The Endoconidia of *Thielavia basicola*; Zopf, W., Vnals of Botany, xxix: 483-491, with 1 plate, October, 1915.

Jura and the Tyrol. *E. cervinus*, which is found under oaks, beeches and pines in Europe and North America, has a fruit body the surface of which is brownish yellow, or reddish brown, and is covered with numerous pyramid-shaped projections. The inner layer of the peridium of this species is not veined like *E. variegatus*, another widely distributed species throughout Europe. The fruit bodies of the last two species are frequently parasitized by *Cordyceps ophioglossoides* and *C. capitatus* (see ante, Fig. 21).

FAMILY 4. TERFEZIACEÆ.—The fruit bodies of the fungi of this family are more or less deeply subterranean, tuber-like, infrequently galleried (*Hydnobolites*). The fruit bodies differ from those of the preceding family in that the interior spore-bearing portion does not break down into a powdery mass, hence there is no so-called capillitium, and as in that family the fruit body does not open spontaneously. The terfas, or kames, of arid Mohammedan countries belonging to the genera *Terfezia* and *Tirmania* were known to the Greeks and Romans. The species of *Terfezia* are found under and associated with the roots of the herbaceous or shrubby forms of *Artemisia*, *Cistus* and *Helianthemum*. A North African terfa, *Terfezia conis*, is found in the mountain forests of pine and cedar and in the sands of Sardinia from March to April. The desert terfas include *T. Boudieri*, *T. Claveryi*, *T. Hafizi* and *Tirmania ovalispora*. Duggar,¹ an American mycologist, has gathered these fungi at the base of *Artemisia herba-alba* found growing in the sandy soil of small oueds, or stream beds, in southwestern Algeria. They are located by the breaking of the soil surface and are dug out by the Arabs with a pointed stick. They form a valuable food, as they are rich in protein.

FAMILY 5. TUBERACEÆ.—General reference has been made to the members of this family in a description of the special ecology of the EUMYCETES. The mycelium of the truffles is well developed and septate, producing mostly subterranean, tuber-like fruit bodies, which have more or less numerous chambers lined with the ascigeral tissue supported by sterile hyphæ. The asci, which are arranged irregularly in the ascigeral tissue, are one to eight-spored. The ascospores are unicellular, and in the truffles (*Tuber*) usually spiny. The mycelium is subterranean and is connected with the roots of coniferous and broad-leaved trees forming the so-called mycorrhiza. The simplest

¹ DUGGAR, B. M.: Mushroom Growing, 1915: 207-217.

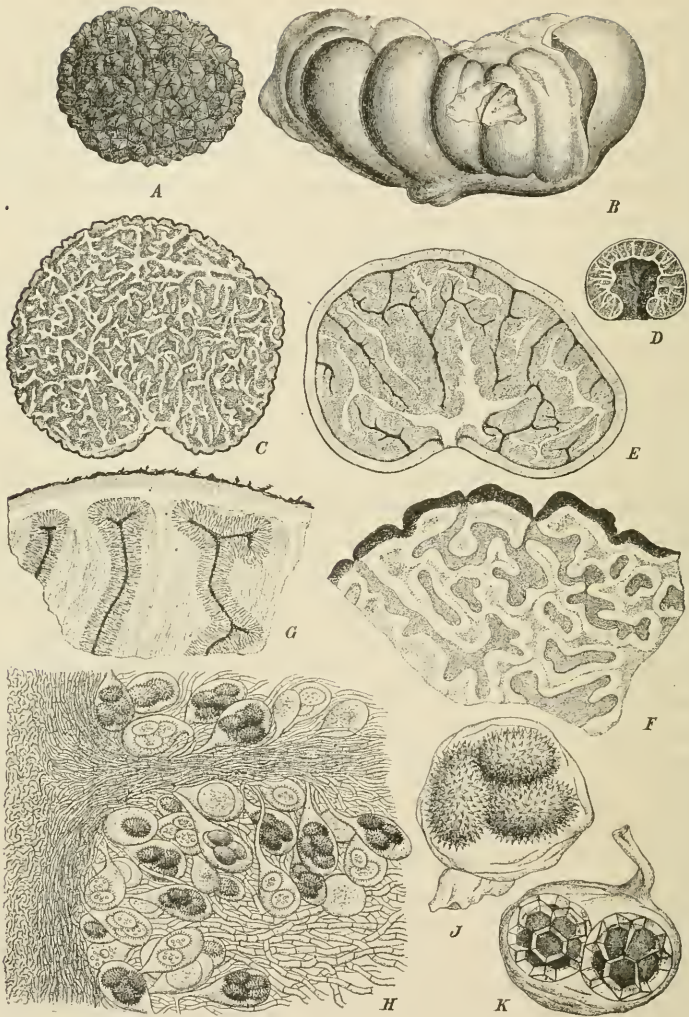

FIG. 52.—A, *Tuber aestivum* fruit-body; B, *Tuber magnatum* fruit-body; C, *Tuber brumale* f. *melanosporum*, section through fruit-body; D, *Tuber excavatum*, section of fruit-body; E, *Tuber aestivum* f. *mesentericum*, piece of fruit-body near peridium enlarged; G, piece of *Tuber excavatum* enlarged; H, *Tuber rufum*, fruit-body magnified showing asci and ascospores; J, *Tuber brumale*, ascia with spores; K, *Tuber magnatum*, ascus with spores. (See *Die natürlichen Pflanzenfamilien* I. 1, p. 287.)

fruit body in the subfamily EUTUBERINEÆ is found in *Genea hispidula* where it forms a hollow sphere with definite opening. Generally, it is provided with a system of tubes, passageways or galleries, which vary in their arrangement in the different genera. These galleries are hollow in some, in others filled with hyphæ, constituting the *venæ externæ*. The sterile supporting hyphæ between these passageways constitute the *venæ internæ*. In the subfamily BALSAMINACEÆ, the fruit body has a single, hollow chamber, or numerous hollow closed cavities. The ascigeral layers constitute the walls of these chambers.

The fungi of the genus *Tuber* (Fig. 52) are of the most interest economically, as several species, such as *T. æstivum* (Spring), *T. brumale*, *T. melanosporum* (Winter), *T. uncinatum* (Autumn), *T. rufum* are edible, and are known as truffles (Fig. 52). These species occur in deciduous woods of north Italy, France and Germany and elsewhere in Europe. They are gathered for food by men (rabassier), who make a livelihood by selling the truffles for immediate use, or for canning purposes. As the fruit bodies emit a characteristic odor, they are located by the aid of specially trained dogs, and pigs, whose keen scent enables them to find the underground fruit bodies. As they are dug up, the animal is rewarded by his master with some other attractive morsel of food, and the newly discovered truffle is placed in a leathern pouch slung over the shoulder of the rabassier. The tin cans in which the truffles (*Tuber melanosporum* in Perigord mainly) are preserved for shipment to all parts of the world are usually labeled with a statement as to the contents of the can, and with a hunting scene, where the man and his truffle dog prominently figure.

Near here should be placed the family MYRIANGIACEÆ represented by the genus *Myriangium* with three species of wide distribution. This family has been monographed by von Hönel.¹

¹VON HÖNEL: Sitzungsber. Math. Naturw. Klasse k. Akad. Wiss. Wien., 118, Abt. 1: 349-376, 1909.

CHAPTER XVII

MILDEWS AND RELATED FUNGI

Suborder D. Perisporiineæ.—The mycelium of the fungi which belong to this suborder is filamentous, superficial, light- or dark-colored, rarely forming a stroma. The fruit bodies are superficial, spheric to egg-shaped without a pore and break up irregularly. Perithecia are usually dark-colored and in many cases surrounded by accessory hyphæ, or suffulcra. The asci are spheric, egg-shaped, or elongated, and range within the closed perithecia from one to many in number. Paraphyses are usually absent. The following families are recognized:

A. Perithecium spheric, poreless or breaking irregularly at the top.

(a) Aerial mycelium white, perithecium with appendages or suffulcra; accessory spores belonging to the genus *Oidium*.

1. ERYSIPTACEÆ.

(b) Aerial mycelium absent, or dark-colored, perithecia without appendages or suffulcra, accessory spores not belonging to *Oidium*.

2. PERISPORIACEÆ.

B. Perithecium peltate flat, opening at top by a round pore.

3. MICROTHYRIACEÆ.

FAMILY 1. ERYSIPTACEÆ.—The fungi of this family are popularly called “white” or “powdery mildews.” During the summer their conidial fructifications (*Oidium*) are found on hops, maples, peas, roses and vines imparting to the surface of the host a dusty appearance, due to the white conidiospores. Later in the summer, the globular dark brown, or black, perithecia appear and these are provided usually with appendages, or suffulcra, which are frequently branched in a way characteristic of the different genera of the family. The white mycelium upon which the fruit bodies arise is truly parasitic, for short haustoria are formed which pierce the wall of the epidermal cells, and swell out into a bladder-like form for absorptive purposes. The haus-

toria are confined to the epidermal cells in all of the genera of the family except *Phyllactinia*, which forms special hyphal branches which enter the stomata, penetrate the intercellular spaces of the leaves and finally send haustoria into the cells of the loose parenchyma. With the exception of these haustoria, the mycelium of the "powdery mildews" is entirely superficial. The conidial forms of the different fungi of the family were classified formerly under the name of *Oidium*, but with a more detailed knowledge of their life history, this name has been relegated to the synonymy. The conidiospores, which are formed in great numbers, are carried by the wind, or by snails in the case of *Erysiphe polygoni* on plants of *Aquilegia* and are capable of immediate germination on reaching the epidermis of a suitable host plant, the germ-tube penetrating the outer wall of some epidermal cell. True sexual reproduction has been discovered in some of the mildews by R. A. Harper, thus verifying the earlier observations of de Bary. *Sphaerotheca Castagnei* serves to illustrate the process. The oogonium and antheridium, which are formed where two neighboring hyphæ approach, each contains a single nucleus. The cell wall between these organs is dissolved at the time of fertilization and the male and female nuclei unite and a fresh wall is laid down between the two organs. Now the wall of the future perithecium begins to form by the development of a number of upright hyphal branches around the oogonium, forming a pseudo-parenchymatous tissue, while other branches later absorbed grow into the interior of the developing perithecium, while the outer wall cells become flattened and darker in color. The following growth takes place in *Sphaerotheca*, which develops only a single ascus. The carpogonium elongates, divides and a curved row of five or six cells is formed. The penultimate cell of this row contains two large nuclei, while the other cells of the row have one nucleus each. The young ascus develops from this penultimate cell in which the two nuclei fuse followed by a rapid increase in size of the ascus, which presses against the inner wall cells of the perithecium and absorbs them. The nucleus of the ascus finally divides three times, producing the nuclei of the eight ascospores, which subsequently are formed by free cell formation. From the half-grown perithecium there arise apical, equatorial or basal hyphæ which grow out as the appendages, or suffulcra, which in *Phyllactinia* are acicular and bulbous at the base (Fig. 53), in *Uncinula* hooked at the apex and in *Podosphæra* and *Micro-*

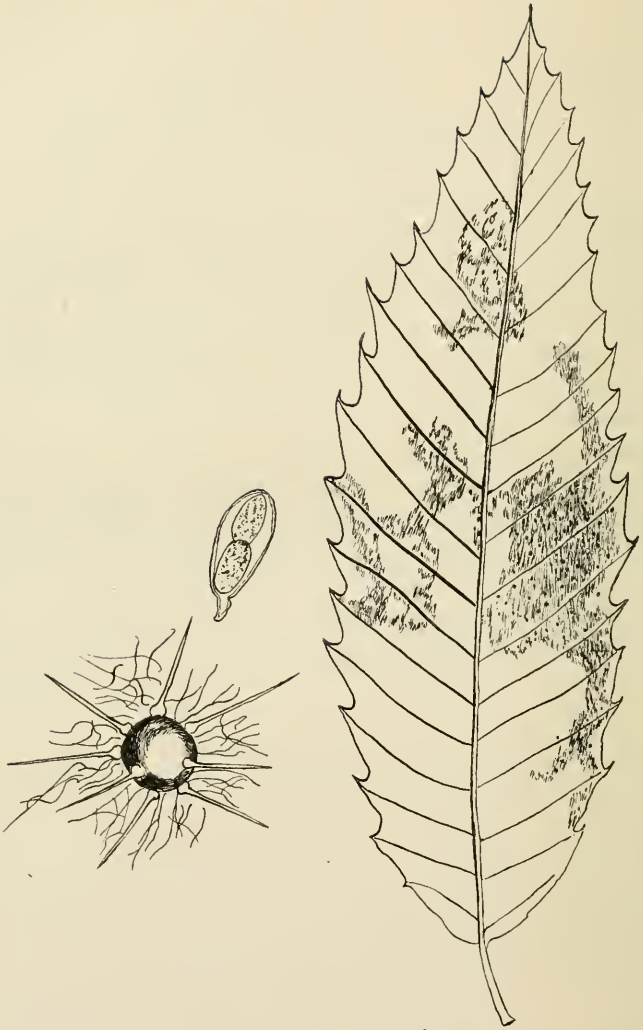

FIG. 53.—Mildew of chestnut leaves due to *Phyllactinia corylei* with ascus and perithecium to left. (Martic Forge, Pa., Nov. 2, 1915.)

sphæra (Fig. 54) dichotomously branched. These appendages probably assist in the distribution of the perithecium, serving to attach the perithecia to plants, if wind-borne, or to the bodies of insects by which they are carried to other plants. The number of asci found in a perithecium and the number and character of the spores in the asci vary generically (see Appendix VIII, pages 721-726).

As the fungi of this family are especially suitable for systematic study, a key is given not only of the principal genera, but also of the

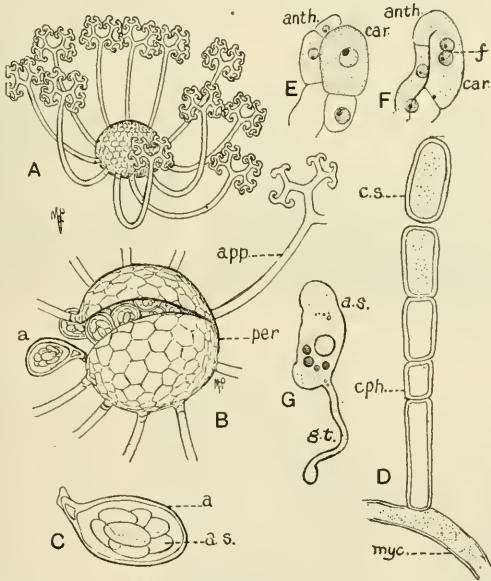

FIG. 54.—Lilac mildew, *Microsphaera alni*. A, Perithecium with appendages; B, perithecia showing asci (a); C, ascus with ascospores; D, conidiophore (cph), bearing conidiospores (c.s.); E, beginning of fertilization; anth, antheridium; car, carogonium; F, later stage of fertilization showing the fusion of two nuclei (f). (From Gager with E and F after R. A. Harper.)

principal species of the different genera. These keys (p. 721) have been taken from a monograph of the ERYSIIPHACEÆ by Ernest S. Salmon, published in 1900, as vol. ix of the Memoirs of the Torrey Botanical Club, to which the mycologic student is referred for detailed descriptions of the various species. The material for the systematic study is easily kept in the dry condition and the perithecium can be studied *in situ* on the dried leaf or other plant parts, and later treated with weak alcohol

to remove the air, washed and mounted permanently stained, or unstained in acetic acid with a ring of asphalt, or in glycerine jelly for a study of the asci and ascospores. For a study of the distribution of the haustoria and for a detailed examination of the sexual organs,¹ small pieces (2 by 4 qcmm.) of hop leaves on which mycelia of the mildew (*Sphærotheca*) are found in various stages of development should be fixed in weaker Flemming's solution, as described by Zimmermann on page 178 of his "Botanical Microtechnique," and then hardened in alcohol and carried through to paraffin. The sections should be cut 5 to 7.5 μ thick stained with safranin (one to one and one-half hours), gentian-violet (one-half to one hour), and orange G. (quickly), then treated with absolute alcohol, cleared in oil of cloves and mounted in balsam.

The material for systematic study should be handed to members of the class in mycology, mounted and then studied as unknowns by the use of the generic and specific keys given in Appendix VIII, pages 721-726.

FAMILY 2. PERISPORIACEÆ.—The aerial mycelium of these fungi is superficial black, filamentous, or wanting, or rarely as a firm stroma. The perithecia are situated on the aerial mycelium, or on the stroma. They are black, \pm spheric, rarely elongated, poreless, or weathering irregularly at the apex and without appendages. The wall is mostly membranous, or brittle. The asci are clustered and mostly elongated. The shapes of the spores are various. Paraphyses are usually wanting, and are present in only a few cases.

The genus *Scorias* has been described incidentally in a foregoing page (72). It is represented in America by a single species, *spongiosa*, which lives on beech twigs and leaves associated with some species of wooly aphid, or on the ground where the droppings of the aphid in the form of honey-dew have collected. Its mycelium is greenish-black, much-branched, rigid, septate and the hyphæ are glued together by an abundant mucilaginous substance forming a loose spongy mass, bearing an abundance of pyriform, coriaceous perithecia, which enclose narrow, thick-walled, eight-spored asci. Elongate pycnidia and perithecia are also frequently seen.

FAMILY 3. MICROTHYRIACEÆ.—The mycelium of the fungi of this family is superficial and dark in color. The perithecia are superficial

¹ HARPER, R. A.: Die Entwicklung des Peritheciums bei *Sphærotheca Castagnei*, Bericht. der Deutsch. Bot. Gesellsch., xiii, Heft. 10: 475-481, 1895.

shield-shaped, unappendaged, black, membranous to carbonous formed of radiating chains of cells. The asci are four- to eight-spored, short and associated with paraphyses. Two fungi which attack the coffee plant are the most important pathogenic species of the family:

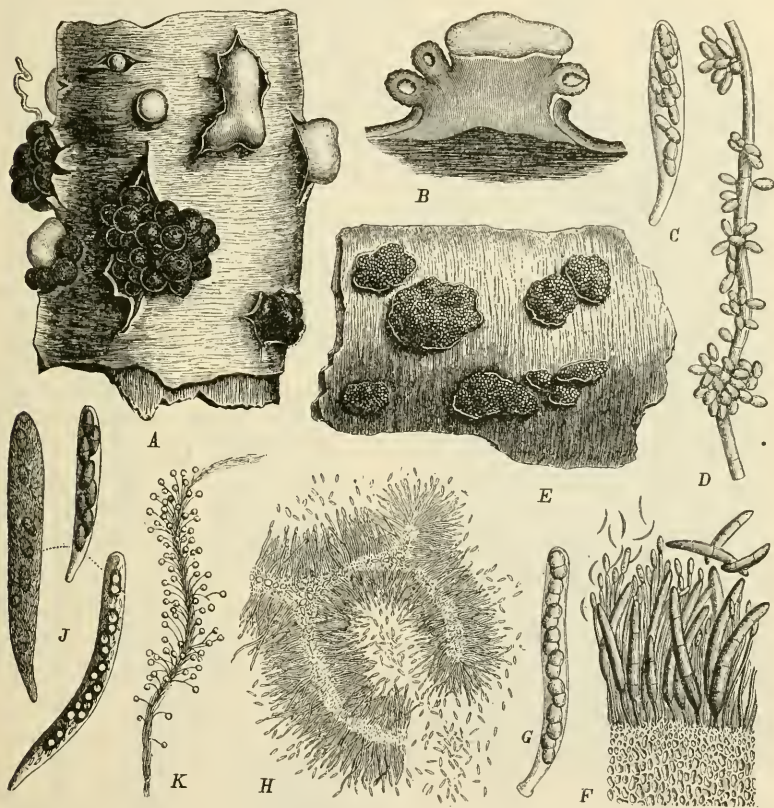

FIG. 55.—A-D, *Nectria cinnabarina*. A, Stroma of conidia and fruit-bodies of fungus; B, stroma in section; C, ascus; D, mycelium with conidiospores; E, F, *Nectria ditissima*; F, conidia layer; G, H, *Nectria sinaptica*; G, ascus; H, pycnidia-like layer. J, *Nectria inaurita*; K, *Nectria oropensoides* coremium. (See *Die natürlichen Pflanzenfamilien* I. 1, p. 357.)

Scolecopeltis aeruginea and *Microthyrium coffæ*. There are twenty-one genera, and more than 300 species not well understood.

Suborder E. Pyrenomycetiinæ.—The mycelium is always present in these fungi. The perithecia are either located upon the substratum,

or in the substratum, and are mostly spheric. A wall (peridium) is present inclosing the clustered eight-spored asci which arise from the interior basal part of the perithecium. The perithecium opens by an apical mouth or pore and is either isolated or imbedded in a stroma which takes manifold forms. The formation of conidiophores and conidiospores varies in the different families and genera. Sometimes

a distinct conidial layer is formed; at other times the conidiospores are formed in pycnidia. The suborder includes many saprophytic and parasitic fungi found upon plants and animals.

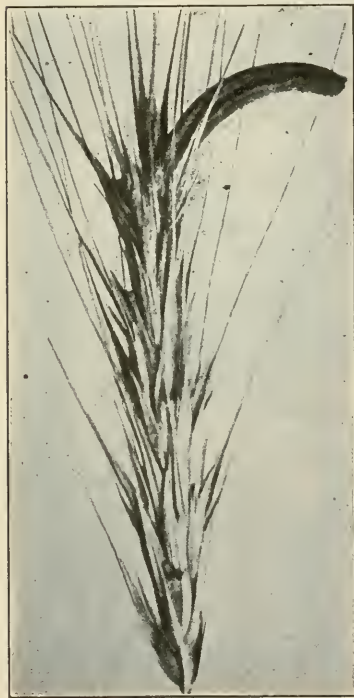

FIG. 56.—Ergot (*Claviceps purpurea*) on rye head. (After Clinton, G. P., Rep. Conn. Agric. Exper. Stat., 1903.)

FAMILY I. HYPOCREACEÆ.—The perithecium of these fungi is spheric and opens terminally by a definite pore. In color, it may be pale, sprightly colored, or colorless, never black. *Hypomyces* with sprightly colored perithecia arises from a thick crust-like stroma. It lives parasitically on a number of different fleshy fungi. For example, *Hypomyces lactifluorum* transforms a species of *Lactarius* into a cinnabarred growth roughly resembling a toadstool and without gills, while the original color of the host is completely lost in the higher color produced by the parasite. *Nectria* without stroma has its perithecia developed on the surface of the substratum. *N. cinnabarina* is a parasite on various deciduous trees (Fig.

55). Its conidial form known as *Tubercularia vulgaris* produces flesh-colored eruptions through the bark of various host plants. *Nectria ditissima* grows on the beech. *Polystigma* has a crust-like stroma on the leaves of trees of the genus *Prunus*, while *Epichloe typhina* confines its parasitic attack to grasses upon which it develops orange-yellow stroma. The genus *Cordyceps* consists of species which live



FIG. 57.—A, *Balansia claviceps* on ear of *Paspalum*; B–L, *Claviceps purpurea*; B, sclerotium; C, sclerotium with *Sphacelia*; D, cross-section of sphacelial layer; E, sprouting sclerotium; F, head of stroma from sclerotium; G, section of same; H, section of perithecium; J, ascus; K, germinating ascospore; C, conidiophores produced on mycelium. (See *Die natürlichen Pflanzenfamilien* I. 1, p. 371.)

parasitically on insects and their larva and some in subterranean fungi. The mycelium kills the insect or larva and mummifies it. Out of the host grow conidiophores (*Isaria*) in early stages of development, and later stalked stroma, in which on enlarged terminal portions the perithecia with asci and ascospores are found. *C. militaris* and *C. cinerea* occur on insects, or insect larvæ. *C. sinensis* is found on caterpillars in eastern Asia, while *C. ophioglossoides* grows on the fruit bodies of species of *Elaphomyces* (see *ante*, page 70) (Fig. 21). *Claviceps* is a genus of fungous parasites found in the developing caryopses of various grasses. Its conidial stage was formerly known as *Sphacelia*. *Claviceps purpurea* and *C. microcarpa* are important species and their life histories will be described in the third part of this book. As ergot, the sclerotia of *Claviceps purpurea* are used in medicine (Figs. 56 and 57). Fifty-seven genera and three doubtful ones are recognized and described in Engler's *Die natürlichen Pflanzenfamilien*.

FAMILY 2. DOTHIDEACEÆ.—This family comprises twenty-four genera among the most important of which is *Plowrightia* (Fig. 22) and *Phyllachora*. The fruit bodies of these fungi is spheric with definite mouth and without distinct peridium, as they are found imbedded in a black stroma. *Plowrightia* includes twenty species of fungi, which form stroma in the interior of host plants, and which break through to the surface, and form pimples in the center of which the opening to the perithecium is found. The spores are egg-shaped, two-celled, hyaline, or bright-greenish. *Plowrightia ribesia* is found on dried twigs of species of currants *Ribes* in Europe and North America. *P. virgultorum* occurs on brick in northern and middle Europe, *P. Mezerei* grows on dead branches of *Daphne* in middle Europe and Italy. *P. insculpta* is found on dried branches of *Clematis vitalba* in Belgium, France, Germany and Italy and *P. morbosa* is the cause of black-knot of the cherry and plum (*Prunus*) and will be described subsequently. *Phyllachora* is a large genus of some 200 species found mostly on the leaves of various plants; *P. graminis* is the commonest species of cosmopolitan distribution on grasses and sedges. The warty spot of clover is *Phyllachora trifolii*.

FAMILY 3. SORDARIACEÆ.—The perithecia in this family are superficial, or deeply sunken in the substratum and often break through at maturity. The stroma is usually absent, but when it occurs the perithecia are sunken with projecting papilliform beaks. The perithecia

are thin and membranaceous to coriaceous, slightly transparent to black and opaque. The asci are usually very delicate, surrounded by long paraphyses, or intermingled with them. The dark-colored spores are one- to many-celled, surrounded by a hyaline gelatinous envelope, or ornamented with hyaline gelatinous spicula. The SORDARIACEÆ are entirely saprophytic and grow on manure, hence, they are coprophilous fungi. Special mechanical devices are shown by the asci for eruptive spore discharge and the distance to which the spores are shot may be between 5 and 9 cm.¹

FAMILY 4. CHÆTOMIACEÆ.—This is a small family of two genera, *Chætomium* and *Bommerella*, which are found on waste paper, manure and on small living fungi, which resemble the fungi of the family *Perisporiaceæ*, if the mouth to the perithecium is wanting. *Bommerella* has three-cornered ascospores. The perithecia of such forms as *Chætomium spirale* and *C. crispatum* are provided apically with masses of spirally wound hairs.

FAMILY 5. SPHÆRIACEÆ.—This important family includes parasitic, or saprophytic fungi showing exceptional diversity on dead parts. They have rounded perithecia with definite opening. The peridium is evident, mostly dark-colored, membranous to leathery never fleshy, usually free from the substratum, or more or less depressed. A stroma may or may not be present. Some authors include a number of families which perhaps may be subordinated here and ranked as subfamilies. *Rosellinia quercina* is a disease of oak seedlings. *Mycosphærella fragariæ* is the cause of leaf spot of strawberry; *M. strati-formans* produces leaf-splitting blight of sugar cane. *Guignardia Bidwellii* is a most important parasite, being responsible for the black rot of the grape and *G. vaccinii* causes cranberry scald. Apple scab and pear scab are due to the attack of *Venturia pomi* and *Venturia pyrina*. A serious disease of sycamore leaves in the spring known as anthracnose is caused by *Gnomonia veneta*.

FAMILY 6. VALSACEÆ.—The stroma of these fungi is black and is formed in the substratum which is more or less altered. The perithecia have a regular border and take various forms in the different genera. The asci are cylindric and long-stalked, alternating with paraphyses. Pycnidiospores are formed in pycnidia and conidiospores

¹ GRIFFITHS, DAVID: The North American SORDARIACEÆ. Memoirs of the Torrey Botanical Club, xi, No. 1, May 7, 1901.

on definite conidiospores. Of the ten genera of the family, the genera *Valsa* and *Diaporthe* are the most important. Both genera include about 400 species, which are most saprophytic in wood and the bark of woody plants. *Valsa oxystoma* is the cause of the disease and death of the branches of *Alnus viridis* in alpine regions; *Diaporthe farinosa* grows on the branches of the linden, *Tilia americana* in North America and *D. eucalypti* on *Eucalyptus globulus* in California.

FAMILY 7. MELOGRAMMATACEÆ.—The stroma are mostly like those of the genus *Valsa* and rarely like those in *Diatrype*. They are hemispheric and are formed beneath the bark and later break through to the surface, where they are more or less isolated. The perithecia are imbedded in the stroma. Conidial fructifications are formed on the surface of young stroma, or pycnidiospores are produced in pycnidia. The most important genus of this family is *Endothia*, which is represented by the Chestnut-blight fungus *E. parasitica*, which lives in the cambium and inner bark of chestnut trees causing a final girdling of the branch and the death of the part beyond the girdled area. It has caused untold injury to the forest groves of America, where the chestnut tree abounds, and its morphology and its ravages will be described subsequently.

FAMILY 8. XYLARIACEÆ.—The stroma of these fungi is developed strongly and is frequently upright and branched. The perithecia are borne in the branched club-shaped portions of the fruit bodies. Early in their growth the surface is covered with conidiospores. The ascospores are unicellular and blackish-brown. The genus *Nummularia*, which includes forty species, is represented typically by *N. Bullardi*, which causes black charcoal-like eruptions on thick branches of the beech, *Fagus*. *Ustulina*, with nine species, includes *U. vulgaris* found on old stems of broad-leaved trees and *Hypoxylon* with about 200 species is confined mostly to damp wood and old tree stumps. *Xylaria digitata*, one of the 200 species of that genus, grows on old wood, and *X. polymorpha* on old tree stumps. This family completes the list of pyrenocarpous fungi.

Suborder F. Discomycetiinæ.—The discomycetous fungi have a filamentous mycelium. Reproduction is by the union of two hyphal branches either of similar size, or differentiated into oogonia and antheridia. The fertilized egg cell either develops directly into an ascus, or it develops ascogenous hyphæ from which the asci are formed.

The apogamous formation of fruit also occurs in this suborder. The asci are united into definite, usually flat layers, which are in open fruit bodies known as apothecia. Conidiospores are also found in some of the forms and the conidiophores are of diverse character. The asci are usually eight-spored. The fungi of this suborder are either parasitic, or saprophytic in habit, and a few of the fleshy members of the family PEZIZACEÆ are edible.

FAMILY 1. HYSTERIACEÆ.—The apothecium is elongated and the opening is a long wide cleft between the approaching walls of the apothecium, so that the ascigeral layer is exposed at the time of the spore discharge.

Some species of the genera *Lophodermium* and *Hypoderma* are dangerous parasites of leaves; for example, *L. pinastri* attacks pine leaves; *L. nervisequum* attacks the spruce tree; while *Hypoderma brachysporum* is found on the white pine, *Pinus strobus*. Such genera as *Lophium*, *Hysterium*, and *Glonium* include species which are saprophytic on bark and wood.

FAMILY 2. PHACIDIACEÆ.—The apothecium is rounded, seldom elongated and its walls are separated through a star-shaped opening, rarely a cleft-like opening, so that the ascigeral layer is fully open at maturity. The family includes such parasites as *Nemacyclus niveus* on coniferous needles; *Rhytisma acerinum*, which produces black tar-like blotches on maple leaves; and *R. salicinum*, which causes similar black areas on willow leaves. Several species of *Trochila* are found on the leaves of different plants.

FAMILY 3. PYRONEMACEÆ.—The fruit body is placed on fine hyphæ or on a felt-like cushion of hyphæ. At first it is spheric; later, it is flatly expanded. The hypothecium is occasionally feebly developed, at other times it is strongly so. The peridium is poorly formed, or entirely absent. The most interesting genus is *Pyronema*. *P. confluens* has a fruit body 1 mm. across, and of a yellow or reddish color. It is often found in spots where fires have been kindled in the woods. The structure of the apothecium and the method of its formation following the sexual union of an antheridium and oogonium have been described by Harper¹ and the essential details have been given on a former page of this book (*ante*, pages 123 and 126).

¹HARPER, R. A.: Sexual Reproduction in *Pyronema confluens* and the Morphology of the Ascocarp. *Annals of Botany*, 14: 231-400, 1900

FAMILY 4. ASCOBOLACEÆ.—The apothecia of the fungi of this family are unstalked. They are superficial and grow up on manure. The peridium is mostly thin, or wanting, and the hypothecium, which is well developed, consists of rounded parenchyma-like cells. In *Ascobolus*, the ascospores are discharged from the asci by a squirting

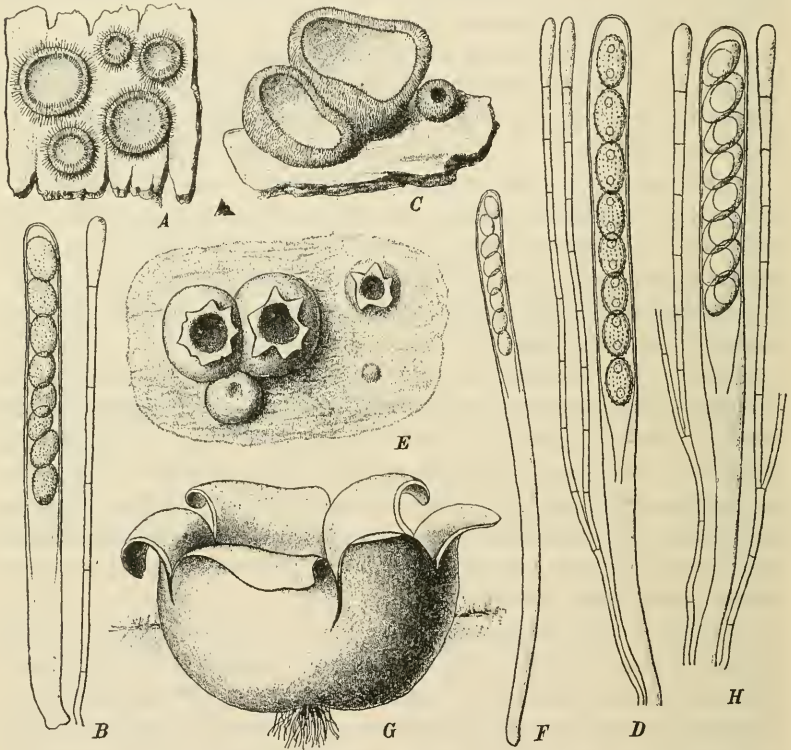

FIG. 58.—A, B, *Lachnea scutellata*. A, Habit; B, ascus with paraphysis; C, D, *Lachnea hemisphaerica*; C, habit; D, ascus with paraphysis; E, *Sarcosphæra arenosa* habit; F, G, *Sarcosphæra coronaria*; F, ascus; G, habit; H, *Sarcosphæra arenicola* ascus with paraphysis. (See *Die natürlichen Pflanzenfamilien* I. 1, p. 181.)

action, and this is accomplished probably by the pressure of the cell wall upon the cell sap. The end of the ascus breaks open suddenly, the ascus collapses, and the eight spores are discharged simultaneously along with the cell sap. In *Ascobolus*, which is related to *Pyronema*, the ascogonium is at first multicellular, but all the cells empty their

contents into a single large one, from which the ascogenous hyphae then arise.

FAMILY 5. PEZIZACEÆ.—The apothecia of this family are saucer- or cup-shaped, sessile or stalked, arising from a mycelium which is found in the substratum. The peridium and hypothecium consists of rounded cells and they are of fleshy, or leathery consistency. The asci, which are usually eight-spored, are separated by distinct paraphyses. The spores are usually hyaline. *Lachnea* and *Peziza* are the most important genera. *Lachnea scutellata* (Fig. 58) has a scarlet to vermilion-red cup, whose margin is beset with a fringe of

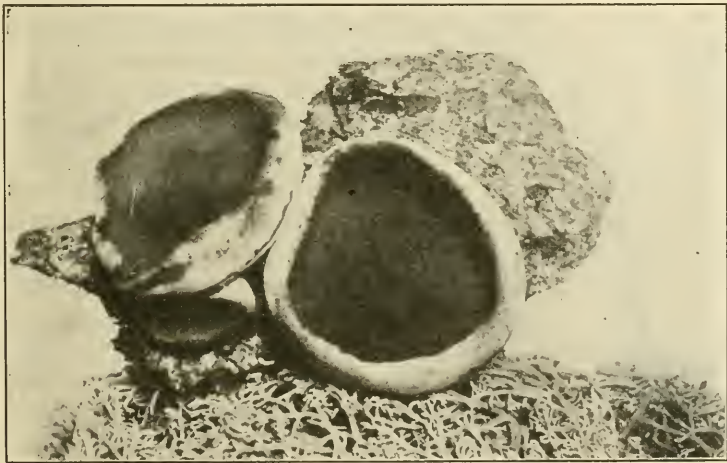

FIG. 59.—Saucer-shaped fruit-bodies of *Peziza repanda*. (Photo by W. H. Walmsley).

large brown bristles. It grows on wet sticks and logs in damp, or wet places, especially at the water's edge. *L. hemisphærica* has a cup 1 to 4 cm. wide with a bluish-white to gray disk and with brownish outside bristles which fringe the margin of the apothecium. It grows on much-decayed wood. *Peziza aurantia*, which is found in the fall in woods, and is edible, has a bright orange cup 1 to 5 cm. wide, powdery outside. At first, it is cup-shaped, then saucer-shaped and irregular. It is stemless, or nearly so. The spores are clear, elliptic and strongly netted. A woodland form, *P. coccinea*, is scarlet in color and suggests a wine glass in its stalked apothecium. *P. badia* grows on the ground in grassland and woodland, and is also edible. It has a

dark brown to paler brown apothecium, 1 to 4 cm. across and almost stemless. *P. aruginosa* is a stalked, green form whose mycelium penetrates the wood of beeches and oaks and imparts to them a copper-green color, which makes it valuable for the manufacture of the famous "Tunbridge ware." The attempt has been made to extract the pigment, or to manufacture it synthetically for use as a shingle stain, but without much success. *P. Willkommii* produces on larch trees a disease known as larch canker. Other species of *Peziza* grow on bark (Fig. 59), horse and cow manure, and are, therefore, typically coprophilous.

FAMILY 6. HELOTIACEÆ.—The apothecia in these fungi are superficial from the beginning and rarely arise by breaking through the substratum. Sometimes they develop from a sclerotium (*Sclerotinia*). In texture, they are waxy, leathery and thick, and stalked, or unstalked, smooth or hairy.



FIG. 60.—*Sclerotinia sclerotiorum*. (After Brefeld.)

The asci are eight-spored. The spores are round, elongated, or filamentous, and one to eight-celled, hyaline. The paraphyses are filamentous. The fringe cup, *Sarcoscypha floccosa*, has a slender, white, hairy stem, 1 to 3 cm. long by 2 to 3 mm. wide, and bearing an apothecium 4 to 10 mm. wide with a scarlet disk, so that the whole fruit body is goblet-shaped. The outside of the cup is covered densely with long white hairs forming a fringe at the margin. The spores are clear and elliptic 20 by 11 μ .

The fringe-cup fungus grows on decaying twigs from spring to autumn. *Sclerotinia* is the most important genus economically. It includes about forty species. The apothecium arises from a sclerotium. *Sclerotinia baccarum* forms sclerotia in the fruits of *Vaccinium myrtillus*; *S. urnula* (Fig. 71) in those of *Vaccinium vitis-idaea*. *Sclerotinia Fuckeliana* forms sclerotia on the grape-vine. Its conidial form was long known as *Botrytis cinerea*. *Sclerotinia sclerotiorum* (Fig. 60) is parasitic and pathogenic on a number of cultivated plants, such as beets, and bears its sclerotia forming on the, subterranean parts of these host plants. The black disease of hyacinth bulbs is connected with the growth of *Sclerotinia bulbosum*. Apples, pears and stone fruits are attacked by *S. fructigena*. *S. libertiana* causes lettuce drop. *S. trifoliorum* is responsible for the stem rot of

clover. Other fungi without sclerotia are parasitic and destructive. Such are *Dasyscypha Willkommii*, the cause of larch canker. *D. Warburgiana* is parasitic on cinchona in the tropics. Such genera as *Coryne*, *Helotium*, *Lachnum* and *Rutstræmia* are saprophytic on wood.

FAMILY 7. MOLLISACEÆ.—The fungi of this family differ from those of the preceding largely in texture, the former being tougher with hyphal cells modified in a fibrous manner. The spores are hyaline. *Pseudopeziza* is the only important germs with its apothecium formed beneath the epidermis, which is subsequently ruptured with the protrusion of a shallow fruit body. The asci show eight unicellular spores.

Pseudopeziza medicaginis is the cause of alfalfa leaf spot. *Ps. ribis* causes anthracnose of currants.

The remaining families of the suborder are Family 8, CELIDIACEÆ, Family 9, PATELLARIACEÆ, Family 10, CENANGIACEÆ.

Suborder G. Helvelliineæ.—This suborder includes fungi with a well-developed mycelium which is filamentous and largely functional for nutritive purposes. From this mycelium, which penetrates the substratum, arises a fleshy, waxy or gelatinous fruit body, which usually possesses a stalk upon which is raised an expanded portion; sometimes club-like, in other forms constituting a distinct pileus. The expanded part, which may be smooth and gelatinous, wrinkled or with variously contorted folds, or of deep pits separated from each other by anastomosing ribs, is covered with the ascigeral layer, which consist of asci and paraphyses standing on end-like palisade tissue. The asci are typically eight-spored, rarely, two-spored, and open at the apex through the removal of a lid, or through a tube-like mouth. The ascospores are unicellular, or multicellular.

FAMILY 1. GEOGLOSSACEÆ.—The fruit body is fleshy, waxy, or gristly, and is separable into a stalk, or stipe, and an enlarged fertile portion, the pileus, which is club-shaped or knobbed, and its color is some shade of yellow, green, or black. The asci are club-shaped, opening by a pore at the apex. This family includes twelve genera, and it has been carefully monographed by Masee.¹

Geoglossum hirsutum is an American ground form with pileus flat and black, 2 to 3 cm. long and 1 to 2 cm. wide. It is wrinkled and hairy (Fig. 61). The stem is 6 to 8 cm. tall, black solid and hairy.

¹ MASSEE, GEORGE: A Monograph of the Geoglosseæ. *Annals of Botany*, ii; 225-306 with 2 plates, 1897.

The spores are brown, very long and many-celled, 100 to 120 by 4 to 7 μ . *G. glutinosum*, another American species, grows on the ground among the grass. It is black and smooth with the ascigerous portion one-third the entire length of the fruit body and in shape oblong-lanceolate, slightly viscid. The upper portion passes imperceptibly into the stalk. The spores are eight in number, arranged parallel to each other with obtuse ends and three-septate, 65 to 75 by 5 to 6 μ , and brown in color.

Leotia chlorocephala is a fungus found in West Virginia, New Jersey and Pennsylvania. It is cespitose in habit and grows in mixed woods on moist ground, from July until late frosts. It is green and has a gelatinous appearance. The pileus is depressed globose, more or less wavy and with an incurved border, in color a dark verdigris-green. It is edible. Another species, *L. lubrica*, is found on the ground in woods from North Carolina and Minnesota to Massachusetts. It is yellowish, olive-green with an irregular hemispheric, inflated, wavy cap.

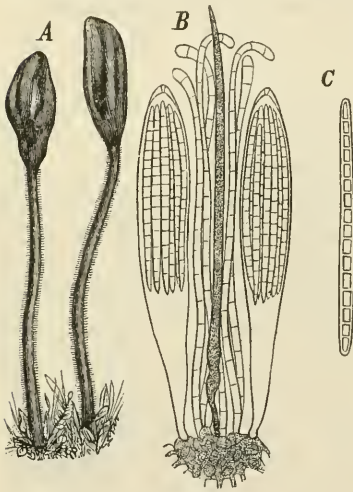

FIG. 61.—*Geoglossum hirsutum*. A, Appearance of fungus; B, asci with paraphyses; C, spore. A, natural size; B, 300/1; C, 400/1. (*Die natürlichen Pflanzenfamilien* I. 1, p. 165.)

FAMILY 2. HELVELLACEÆ.—The fruit body in these edible fungi is fleshy and divided into a hollow stalk and ascigerous expanded portion. The upper part is cap-like and covered externally by the ascigeral layer. The asci are club-shaped and open by the lifting off of a distinct lid. The spores are ellipsoid, colorless, or bright yellow and smooth. Five genera are included in the family: *Morchella*, *Gyromitra*, *Verpa*, *Cidaris* and *Helvella*. This family includes the largest of the sac fungi. Some species of *Gyromitra* weigh over a pound and forms of *Morchella* may grow a foot tall. The cap of *Morchella* is more or less deeply ridged, crosswise and lengthwise and has a delightful odor. The broad stem Morel, *Morchella crassipes*, has a cap 4 to 10 cm. tall and 3 to 6 cm. wide at the base, in color tan to tan-brown, with deep pits and wavy to

irregular ridges, the whole cap being more or less conic. The stem is 3 to 12 cm. by 2 to 6 cm., white and hollow. The spores are elliptic, clear, smooth, 20 to 22 by 10 to 12 μ . *M. esculenta*, the common Morel, has a cap 3 to 7 cm. tall and 2 to 4 cm. wide, of a yellowish-brown to brown color, covered with very regular ribs with a blunt edge. The spores are smooth, elliptic, clear, 14 to 22 μ by 8 to 14 μ . It grows on the ground in woods and forest openings, and is a delicious morsel.

Gyromitra has a more irregular cap more or less inflated and folded, the edge united in places with the stem. *G. esculenta* has a rounded lobed pileus, irregular, gyrose-convolute, smooth and bay-red. Its stem is stout, stuffed, or hollow. The ascospores are elliptic, yellowish, 20 to 22 μ long. It grows in wet ravines, or springy places in the vicinity of pine groves, or pine trees. *G. brunnea* is brown in color and is figured by Clements in his "Minnesota Mushrooms," page 143.

Verpa digitaliformis grows on ground in woods. It has a brown, or dark brown, smooth, bell-shaped cap with a long finger-like stem, beneath, hence the specific name. *Verpa bohemica* is the "ribbed verpa" and is delicious eating.

The cap in the genus *Helvella* hangs loosely over the stem and it is saddle-shaped more or less lobed. The stem is ribbed. The ascigeral layer is confined to the upper side of the cap. All of the species are edible. *Helvella crispa* is a common species and has been collected in West Virginia, Pennsylvania and New Jersey. It is white or whitish in color, while *H. lacunosa* is gray to almost black.

FAMILY 3. CYTTARIACEÆ.—This family is represented by the single genus *Cyttaria* with a tuber-like stroma in which the apothecia are sunken. The stroma, which arises on the antarctic beech, *Nothofagus*, in South America and Tasmania, is stalked. The asci are cylindrical and eight-spored. The spores are ellipsoidal and hyaline. The paraphyses are filamentous, breaking down into mucilage. The cylindrical asci bear elliptic hyaline spores. Six species have been described from Patagonia, Tasmania and Terra del Fuego.

FAMILY 4. RHIZINACEÆ.—The fruit bodies of the fungi of this small family are stalkless and they are fleshy and waxy in consistency. Four genera are included.

Suborder H. Laboulbeniineæ.—We owe our knowledge of these eccentric or singular fungi to four botanists: J. Peyritsch, G. Lindau,

Roland Thaxter and J. Faull. They are parasitic on insects, mostly beetles, which live in moist situations and are long-lived and hibernating. They are often highly specialized, as to the parts of the insect on which they grow, occurring only on certain joints of the legs and on certain legs of the host. The vegetative mycelium is very much reduced, consisting of one to a few cells, which are attached to the body of the insect and their usually minute size renders them difficult of study. The host is not destroyed nor even inconvenienced by these fungi which appear as minute, usually dark-colored, yellowish bristles or bushy hairs projecting from the chitinous integument of the insect.

Stigmatomyces Bæri lives parasitically on house flies. The bicellular spore with its mucilaginous coat becomes attached at its lower end. The upper cell develops an appendage which bears a number of unicellular flask-shaped antheridia from which the naked spermatia are shed. The lower cell divides into four cells which represent the female reproductive organ, where the carpogonium, or egg cell develops a trichogyne to which the spermatia become attached. The three fundamental parts of which these plants are composed are a main body, the receptacle; one or more spore-producing portions, the perithecia; and lastly, one or more appendages which, in the majority of cases, are associated with the formation of the male sexual organs. The receptacle is that portion of the fungus on which the appendages together with the perithecia, or their stalk cells, are inserted. The sterile appendages, which form dense tufts and sometimes are more conspicuous than the main plant itself, serve to protect the delicate trichogyne which is subsequently developed. Sometimes, the primary appendage develops a spine-like process. The male organs and male elements in the LABOULBENIACEÆ may be designated as antheridia and antherozoids, the former consisting of a single antheridial cell or a group of such cells, the latter of a single naked, or thin-walled cell, so that the antherozoids are produced either endogenously or exogenously. Among the antheridia which produce endogenous antherozoids we may distinguish the simple and the compound. A simple antheridium discharges its antherozoids through its special pore or opening, the compound antheridium consists of several antheridial cells each of which discharges its contents into a common cavity from which they escape. The female organs are formed from a segment of the lower cell of the receptacle rarely from the terminal cell. The perithe-

cium, as in many other Ascomycetales, originates from a cell of the receptacle situated below the female organ. The procarp consists of three distinct parts: the trichogyne, the trichophoric cell and the part lowest the carpogenic cell, which is fertilized and undergoes further development. Faull¹ has shown in two species of *Laboulbenia* that after the procarp is mature the carpogonium and trichophoric cell become continuous. Meanwhile, the nucleus of the carpogonium is succeeded by two which are apparently daughters of the carpogonial nucleus, and almost simultaneously the trichophoric nucleus undergoes division. Later, a uninucleate trichophoric cell and a uninucleate inferior supporting cell are septated off from the now four-nucleated fusion cell. After further nuclear divisions a binucleate superior supporting cell and sometimes a binucleate inferior supporting cell are cut off. The binucleate ascogonium now begins to bud off asci, or divides into two ascogonic cells, each of which contains a pair of nuclei. Up to this stage no nuclear fusions have been observed. The nuclei of an ascogonic cell divide conjointly, a daughter of each passing into a young ascus. This process is repeated at the birth of every ascus. The pair entering the ascus soon fuse. The fusion nucleus divides by a reduction mitosis after a period of growth and the number of chromosomes is the same as in other mitoses. There are two other mitoses prior to spore formation, and both are homotypic. The spores are delimited by the method characteristic of the ordinary sac fungi. Each ascus in *Stigmatomyces Bæri* produces four spindle-shaped bicellular spores. In other genera eight two-celled spores are formed. It is to be noted in closing that the sexual organs of these curious fungi are similar to those of the red seaweeds, FLORIDÆ. Thaxter² has done more than any other botanist to make this order known systematically.

Phylogeny of Ascomycetales.—Atkinson in a philosophic discussion of the phylogeny of the Ascomycetales suggests six series or lines of development and his suggestions are incorporated in the accompanying chart.

1. Apocarp line from *Dipodascus*-like forms and by reduction.

¹ FAULL, J. H.: The Cytology of the Laboulbeniales. *Annals of Botany*, xxv: 649-654, July, 1911. The Cytology of *Laboulbenia chætophora* and *L. gyridarum*. *Annals of Botany*, xxvi: 355-358, with 4 plates, April, 1912.

² THAXTER, ROLAND: Contributions toward a Monograph of the Laboulbeniaceæ part I, 1896; part II, 1908, *Mem. Amer. Acad. of Arts and Sci.*

2. Plectocarp line from *Dipodascus*-like forms, perhaps similar to *Monascus*.

3. Perispore line arising from *Monascus*-like prototype, before splitting of archicarp, or from ASPERGILLACEÆ.

4. Pyrenocarp line arising near *Monascus*-like prototype, LABOULBENIALES side near base, and some of the MYCOTHYRIALES as reduced from SPHÆRIALES.

Those who adhere to the belief that the ASCOMYCETALES have descended from the red algæ interpret their belief in three ways: *first*, sac fungi with highly developed trichogyne of the *Collema* type with certain red algæ of existing forms; *second*, sac fungi with highly developed trichogyne of the *Polystigma* type with hypothetic algæ with trichogyne representing the common original stock of both groups; and *third*, sac fungi with simple generalized copulating gametes of the *Gymnoascus* type with hypothetic algæ having a simple procarp representing the stock from which both groups started. It will be noted that Atkinson believes that the fungi of the ASCOMYCETALES have been derived from the simple PHYCOMYCETES, and that the PROTOASCOMYCETES are derived by descent and degeneration from such a primitive form as *Dipodascus*, *Endomyces Magnusii* being the nearest known form to the generalized condition seen in *Dipodascus*. The EUASCOMYCETES are derived from fungi similar to *Monascus* and *Gymnoascus* with generalized archicarp. Six distinct lines as previously noted arise from these primitive forms. Atkinson gives a chart which is purely provisional, and which suggests the probable relationship of the principal groups to each other and to a probable common ancestor.

GENERAL BIBLIOGRAPHY OF THE ASCOMYCETALES

- ATKINSON, GEO. F.: Phylogeny and Relationships in the Ascomycetes. *Annals of the Missouri Botanical Garden*, ii: 315-376, February-April, 1915.
- BARKER, B. T. P.: The Morphology and Development of the Ascocarp in *Monascus*, with 2 plates. *Annals of Botany*, xvii: 167, 1903.
- BLACKMAN, H. H. and WELSFORD, E. J.: The Development of the Perithegium of *Polystigma rubrum*. *Annals of Botany*, xxvi: 761, 1912, with 2 plates.
- BROWN, HORACE T.: Some Studies in Yeast. *Annals of Botany*, xxviii: 197, 1914.
- CARRUTHERS, D.: Contributions to the Cytology of *Helvella crispa*, with 2 plates. *Annals of Botany*, xxv: 243, 1911.
- CLEMENTS, F. E.: *Minnesota Plant Studies*: iv, *Minnesota Mushrooms*, 1910: 138-151.

- CONN, H. W.: Bacteria, Yeasts and Moulds in the Home, 1903, with 293 pages.
- DUGGAR, B. M.: Mushroom Growing, 1915, pages 188-224, dealing with European Truffles, Terfas and Morels.
- ELLIS, J. B. and EVERHART, B. M.: The North American Pyrenomycetes, 1892, pages 793, with 41 plates.
- ENGLER, A.: Die Natürlichen Pflanzenfamilien, I. Teil, 1. Abt.: 142-505 with separate parts by Ed. Fischer, G. Lindau and J. Schroeter.
- FAULL, J. H.: The Cytology of the Laboulbeniales. *Annals of Botany*, xxv: 649-654, July, 1911.
- FAULL, J. H.: The Cytology of *Laboulbenia chætophora* and *L. Gyrinidarum*. *Annals of Botany*, xxvi: 325-355, with 4 plates, April, 1912.
- FRASER, H. C. I. and ULLSFORD, E. J.: Further Contributions to the Cytology of the Ascomycetes, with 2 plates. *Annals of Botany*, xxii: 331, 1908.
- FRASER, H. C. I. and BROOKS, W. E. St. T.: Further Studies on the Cytology of the Ascus. *Annals of Botany*, xxiii: 537, 1909.
- FRASER, H. C. I. and GWYNNE-VAUGHAN MRS. D. T.: The Development of the Ascocarp in *Lachnea Cretea*, with 2 plates. *Annals of Botany*, xxvii: 553, 1913.
- GRANT, JAMES: The Chemistry of Bread Making, 1912: 125-152.
- GRIFFITHS, DAVID: The North American Sordariaceæ. *Memoirs Torrey Botanical Club*, xi, 1901.
- JORGENSEN, ALFRED: Microorganisms and Fermentation, transl. 3d Edition by Alex. K. Miller and A. E. Lennholm, 1900, with 318 pages.
- KOHL, DR. F. G.: Die Hefepilze ihre Organisation, Physiologie, Biologie and Systematik ihre Bedeutung als Gärungsorganismen, 1908.
- KLOCKER, ALB.: Fermentation Organisms: A Laboratory Handbook, transl. by G. E. Allan and J. H. Millar, 1903, with 391 pages.
- LAFAR, DR. FRANZ: Technical Mycology, transl. by Charles T. C. Salter. II, Part I: 99-189: Part II: 191-481.
- MASSEE, GEORGE: A Revision of the Genus *Cordyceps*. *Annals of Botany*, ix: 1, with 2 plates.
- MASSEE, GEORGE: A Monograph of the Geoglosseæ. *Annals of Botany*, 11: 225-301, 1897.
- MASSEE, GEORGE: The Structure and Affinities of the British Tuberaçæ, with 1 plate. *Annals of Botany*, xxiii: 243, 1909.
- MASSEE, GEORGE: Text-book of Fungi, 1906: 261-313.
- SALMON, E. S.: On Endophytic Adaptation Shown by *Erysiphe graminis*. *Annals of Botany*, xix: 444.
- SALMON, E. S.: On *Oidiopsis taurica*, an Endophytic Member of the Erysiphaceæ. *Annals of Botany*, xx: 187, 1906.
- SALMON, ERNEST S.: A Monograph of the Erysiphaceæ. *Memoirs Torrey Botanical Club*, ix, 1900, pages 287, with 9 plates.
- STEVENS, F. L.: The Fungi Which Cause Plant Disease, 1913: 113-297, with bibliography.
- THAXTER, ROLAND: Contributions toward a Monograph of the Laboulbeniaceæ, part I, *Mem. Amer. Acad. Arts & Sci.*, 1896; part II, do., 1908.

- THON, CHARLES: Cultural Studies of Species of *Penicillium*. Bull. 118, U. S. Bureau Animal Industry, 1910.
- WAGER, HAROLD: The Nucleus of the Yeast Plant. *Annals of Botany*, xii: 499-540, with 2 plates, 1898.
- WETTSTEIN, DR. RICHARD R. VON: *Handbuch der Systematischen Botanik* (2d Edition), 1911: 168-192.

CHAPTER XVIII

BASIDIA-BEARING FUNGI (SMUTS)

ORDER BASIDIOMYCETALES

The fungi of this order have mostly a strongly developed mycelium, multicellular and at times with apical growth. Sexual reproduction is entirely absent, yet in the rusts, we find certain nuclear fusions which are looked upon by some mycologists as of a sexual nature. The characteristic method of reproduction is non-sexual by means of conidia, which in the most primitive forms are of indefinite number, while in the most highly differentiated forms the conidiospores are definite in number two to eight, and are borne on special conidiophores known as basidia (basidium-ia). In many forms, the basidia are arranged in definite parts of fleshy fruit bodies and in special layers known as hymenia (hymenium-ia). Besides the conidiospores other kinds of spores, known as chlamydospores, are formed. Zoospores are entirely absent. The fungi of the order are either saprophytes, or parasites, and occasionally, they are facultative saprophytes, or facultative parasites. None of them live in the water (nicht wasserbewohnend).

The Basidiomycetales do not follow the Ascomycetales in the direct line of evolution of the fungi. They may be considered to parallel the sac fungi. The group is supposed, in this regard, to represent the results of extreme simplification; the sexual organs, if ever present, have in the phylogenetic history of these fungi long since disappeared and simple nuclear fusions function in all probability in lieu of the sexual act.

KEY TO SUBORDERS OF THE BASIDIOMYCETALES (AFTER STEVENS)

Chlamydospores at maturity free in a sorus, produced intercalary, from the mycelium; basidiospores borne on a promycelium and resembling conidiospores. 1. **Hemibasidii.**

Chlamydospores absent, or when present, borne on definite stalks.

Basidia septate, arising from a resting spore, or borne directly on a hymenium. 2. **Protobasidii.**

Basidia non-septate, borne on a hymenium. 3. **Eubasidii.**

Suborder Hemibasidii.—The conidiophore, or more correctly the basidium, arises from the chlamydospore and bears an indefinite and usually large number of basidiospores. All cells of the mycelium and the spores, as far as known, are unicellular. The position of this suborder in the family tree of the fungi is uncertain. The majority of the funguses are strictly parasitic on the higher plants, and their mycelia live in the tissues of the same, mostly as intercellular parasites, certain hyphæ known as *haustoria* penetrating the interior of the host cells. Infection of the host takes place, as a rule, very early and in some cases at the time of seed formation, so that the parasitic mycelium keeps pace with the growth of the host plants and at definite times and places, such as anthers, ovaries and the like, which are mostly deformed, the spore-bearing portion of the fungous parasite appears. The spores, which are formed in such places, are known as chlamydospores, and the mass of spores and diseased host parts are mostly black and soot-like. The chlamydospores give rise to a promycelium, which cuts off basidiospores. The basidiospores give rise either to conidiospores, or they infect some host plant, if deposited upon it at the susceptible time. Brefeld first suggested the name **Hemibasidii** for the **USTILAGINACEÆ** and **TILLETIACEÆ** which he considered as representing the link connecting the lower fungi and the true **BASIDIOMYCETALES**. Two families are recognized by mycologists, viz., **USTILAGINACEÆ** and **TILLETIACEÆ**.

FAMILY I. USTILAGINACEÆ.—The fungi of this family are all parasitic. They can be recognized readily by the outbreaks of dusty material that they produce on certain parts of their hosts, when they reach their reproductive stage. An important genus, *Ustilago*, the type genus of the family, derives its name from *ustio*, a burning. The smut of wheat is called locally in England “bunt ear,” “black ball,” “dust brand” and “chimney sweeper.” All of these names are indicative of the sooty-black character of the spores. There are two chief phases in the development of a smut fungus, the mycelial phase and the spore phase. The hyphæ of the mycelium mostly push between the cells through the intercellular spaces and form short special branches, or *haustoria*, which enter the host cells and absorb from them nutritive material. The mycelium may be localized, or it may be spread generally throughout the host. Where the mycelium gains entrance to the host through the germinating seeds, it remains in the vegetative

condition and without external manifestation of infection until in its fruiting stage, when it breaks through the tissues of the host, appearing at the surface. In perennial plants, the mycelium may live in the perennial parts, each year extending into the new growth. Eventually, the mycelium becomes conspicuous in certain organs of the plant. It may develop abnormal growths, or cause swellings in the stem leaves, flowers (anthers, ovaries), or fruits of the host. Here the hyphæ break up into chains of spores, which develop thicker walls than the hyphal cells from which they arose and are known as chlamydospores ($\chi\lambda\alpha\mu\acute{\upsilon}\varsigma$, $\chi\lambda\alpha\mu\acute{\upsilon}\delta\omicron\varsigma$ = a cloak + $\sigma\pi\omicron\rho\acute{\alpha}$ = a seed). The hyphal cells between the spores undergo almost complete gelatinization, which gelatinized cells are used probably to nourish the developing spores, as at maturity the spores lie loosely surrounded in part by the diseased cells of the host ready to be discharged as the adjoining hyphal and host cells dry up and completely disappear. The chlamydospores, which make up the smutty, or sooty masses, are usually thick-walled and, being small, 4 to 35 μ , they are easily disseminated. They are usually spherical, or spheroidal, but may be ovoid, ellipsoidal or even oblong. They are simple, *i.e.*, consisting of single cells, but they may be united into spore balls, which may have an external coating of sterile cells. The galls of the chlamydospores may be smooth, or echinulate, or reticulate with a network of ridges, or wings. Their color may be yellowish, reddish or olive-brown, violet, or purplish, and the dark-colored spores in mass may appear to be black or dark amber-brown. Sori are masses of the spores that break out singly, or in clusters, on the various organs of the hosts. These clusters are protected by their coverings of the tissue of the host. The sori may be dusty and easily broken up, while in other species, they may be hard and the spore mass is gradually disintegrated.

The wind is undoubtedly one of the principal agents in the dissemination of the smut spores, but it was found that no smut spores could be demonstrated in spore traps set up at the University of Manitoba by Buller farther distant from the infected fields than 250 yards. Man distributes the spores through unclean agricultural methods, such as using old grain bags over and over again, and in sowing seed to which the smut spores are attached. The threshing machine is an active agent in the spread of smut spores, and the farmer should see that his machine is carefully cleaned from one operation to another.

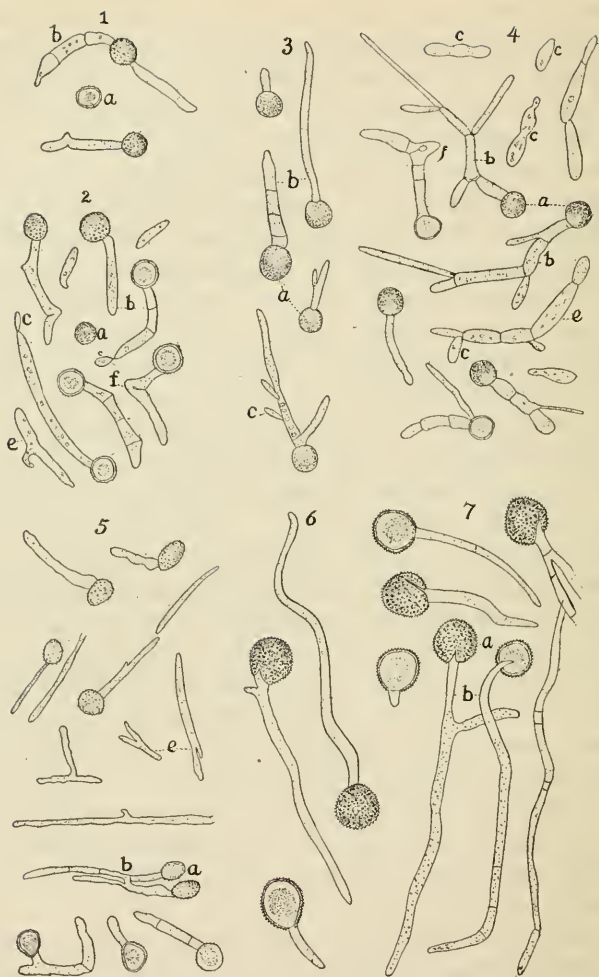

FIG. 62.—Germination of smut spores. *a*, Chlamydospores; *b*, basidium; *S*, basidiospores; *d*, infection threads; *e*, detached pieces of mycelia; *f*, knee-joints. 1. Germination of *Ustilago avenae* in 1/50 per cent. acetic acid 24 to 48 hours after being placed in liquid. 2. Same as in 1 but in distilled water. 3. Germination of *Ustilago levis* in Cohn's modified solution at end of 24 hours. 4. Same as 3 but at end of 2 or 3 days. 5. Germination of *Ustilago tritici* in Cohn's modified solution. 6. Germination of *Ustilago striiformis* from red top in 1/50 per cent. acetic acid at end of 2 days. 7. Same as 6 except in Cohn's modified solution. (After Bull. 57, Univ. Ill. Agric. Exper. Stat., March, 1900.)

Experiments to determine the vitality of smut spores have shown that those of the stinking smut of wheat, covered smut of barley and oat smut are long-lived under favorable conditions for seven, or eight years, and in a dry condition are resistant to frost. Where vegetative reproduction occurs, as in the loose smuts, the spores lose their vitality after five to six months. It has also been determined that stinking smut spores passing through the bodies of animals lose their power of germination in a great majority of cases. Only those passing through pigs retain their vitality a longer time. The presence of occasional viable spores in the manurial offal of animals suggests a danger of the spreading of smut diseases through manure applied to fields as fertilizers.

Germination (Fig. 62).—The spores, when placed in a drop of water, send out a single hyaline thread several times the length of the spore, and this thread, or promycelium, becomes divided into four cells by cross-partitions, or septæ. Usually the apex of these four cells produce one or more elongated thin-walled spores, the basidiospores, or sporidea. These basidiospores are pinched off at the base, and others are formed to take their place. When the basidiospores reach the proper host, whether in the seed, seedling, partly grown or mature condition, it forms on germination an infection hypha, which bores through the surface and enters the interior of the host. Once inside a mycelium is formed.

MODES OF INFECTION.—(1) Certain smut spores, as those of the stinking smut of wheat, covered smut of barley, naked and loose smuts of oats and others, adhere to the outside of the grains and are sown along with the grain. In the soil germination takes place and the spore produces a short stout mycelium, which develops secondary, or even tertiary spores, which by means of infection threads attack the young grain seedlings as they grow upward through the soil. This mode of infection is called seedling infection. (2) In the so-called loose smuts of wheat and barley, the chlamydospores, which are mature at the time of flowering of these commercial grasses, fall upon the female organs of the wheat, or barley, and germinating the infection hypha pushes its way into the developing grain where it remains dormant as a delicate mycelium. The normal development of the grain is not inhibited, so that when it is planted as seed, the mycelium begins to grow with the seedling and keeps pace with the future growth of its host until

the maturity of the spores at the time the wheat, or barley, come into bloom. This mode of infection is known as flower infection. A third method is shown by the corn smut which may infect its host at any time by entering the young and tender parts of the plant. A knowledge of these facts is important, for the treatment of seeds will be efficacious with smuts, which infect seeds, while it would be useless with infection accomplished by the second and third methods.

Grain smuts cause a considerable loss to the farmer every year. Oat smut, it has been estimated, causes a loss of \$10,000,000 per annum in the United States. Smut explosions have been recorded recently.¹ In the wheat-growing regions of the Pacific Northwest in the summer of 1914, 300 threshing machines were blown up or burned by smut explosions. Passing into the cylinder of the threshing machine, the smut balls were broken up and the highly combustible smut dust oily and dry filled the interior of the separator. It is when this condition obtains, that the explosions and flames occur. The smut dust was probably ignited by static electricity in the cylinder of the threshing machine. The drier the conditions, the more static electricity is formed, and the easier it is to ignite the smut.

The family USTILAGINACEÆ includes eleven American genera. Only three genera out of the seven will be considered in this book. They are *Ustilago*, *Sorosporium* and *Tolyposporium*. The genus *Ustilago*, of which there are about seventy-two American species, is distinguished from the other two less important genera by its single spores which form dusty masses at maturity without any kind of inclosing membrane. *Sorosporium* has its spores agglutinated into balls which form more or less dusty masses. The spore balls are usually evanescent and the spores are very dark. The spores are agglutinated into balls in *Tolyposporium*, forming more or less dusty spore masses. The spore balls are rather permanent, the spores adhering by folds, or thickenings of the outer coat.

FAMILY 2. TILLETIACEÆ.—The name *Tilletia* which is that of an important genus (Fig. 63) of the family is derived from Matthieu Tillet, who published a book in Bordeaux, France, in 1755. The sori form dusty spore masses, which break out to the surface, or are imbedded permanently in the plant tissues, often without causing any malforma-

¹ ASHLOCK, J. L.: Smut Explosions. The Country Gentleman, April 10, 1915, p. 703.

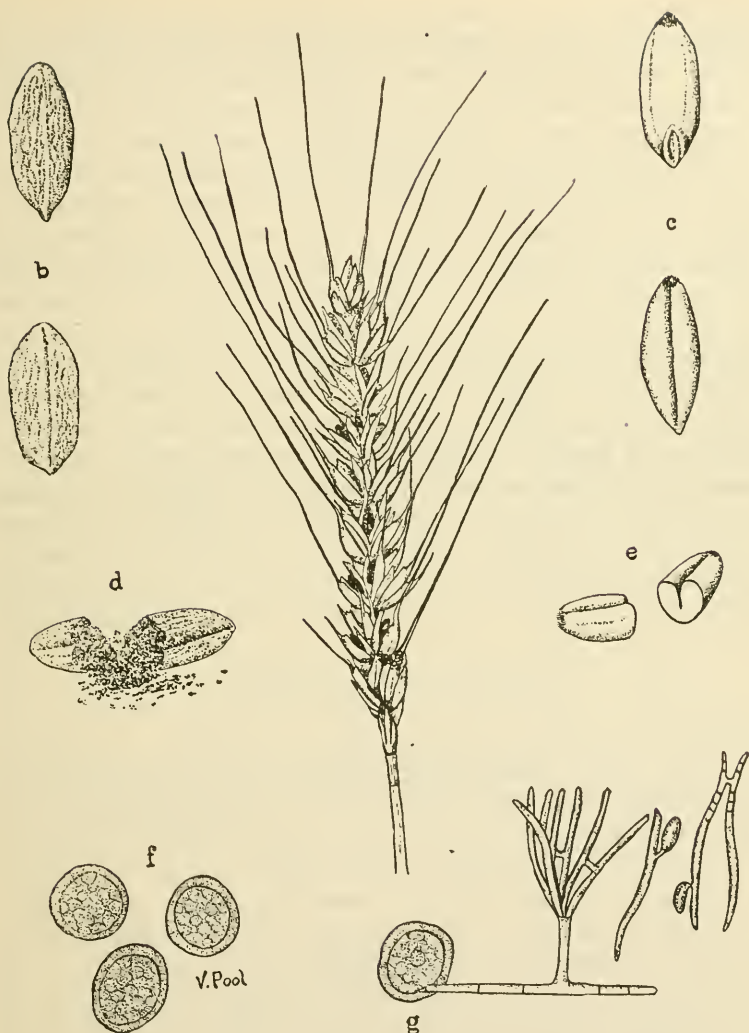

FIG. 63.—Bunt or stinking smut of wheat (*Tilletia tritici*). *a*, Whole head affected with smut; *b*, smutted grains; *c*, normal grains; *d*, smutted grain broken to show spores; *e*, normal grain divided in the middle; *f*, chlamydospores enlarged; *g*, germination of a spore. (Drawings by Pool, Venus A., from Bull. 135, Sci. Ser. 141, Univ. of Tex., Nov. 15, 1909.)

tion of these parts. In germination, a promycelium is formed, which usually gives rise to a terminal cluster of elongated basidiospores, or sporidia, which sometimes bear whorls of secondary basidiospores. Sometimes the primary sporidia fuse in pairs, and these with or without fusing may give rise to infection hyphæ; or in nutrient media to a mycelium bearing dissimilar secondary sporidia (aerial conidia). As in the preceding family the hyphæ break up into chlamydo-spores which break through the host tissue, as a sooty mass of dust. When these chlamydo-spores germinate, they give rise to an undivided basidium with basidiospores borne at the apex not on the side, as in the preceding family. This is the principal morphologic difference, as the two groups of smut fungi approach each other so closely that in external appearance they resemble each other. Brefeld described the structure and life history of *Tilletia tritici* (*T. caries*), the bunt of wheat very carefully. In England, this disease of the wheat plant is called in various districts pepper brand, smut balls, bladder brand, stinking smut, stinking rust (Fig. 63). In the fields, it is difficult to distinguish diseased from sound wheat, as there is little to indicate the presence of the hidden parasite, but it excites an abnormal development of chlorophyll, so that the spikes of the affected plants are usually greener than the healthy ones. The brand spores are found in all the grains of a single ear. The burst grains are shorter and wider than healthy ones and pointed toward the base. When cracked, a black dust is discharged, which under the microscope is seen to consist of reticulate-walled spores of an olive-brown. They germinate readily and even after eight and a half years, they have been known to grow. On rubbing the black powdery mass between the fingers, the smell of herring brine is given off, and this decayed fish odor has originated one of the common names, that of stinking smut. A curved unicellular basidium arises from the chlamydo-spore on its germination. This produces a bundle of elongated conidiospores, or basidiospores, according to one's bias. Sickle-shaped secondary conidiospores arise from the primary kind. The primary conidiospores may unite by bridge-like connections so that two united spores look like the letter H. Wheat becomes infected in the seedling state, the spores being sown with the grain, and the infection hypha which enters the host forms a mycelium which grows along with the host until the spores break out again.

Tilletia is the most important genus. In it the sori may occur in

various parts of the host, usually in the ovaries, where are formed a dusty dark spore mass. The spores are simple, separate and originate singly at the ends of special hyphæ, which almost disappear through gelatinization. The spores varies in size from 16μ to 35μ . Fifteen out of the fifty-three species recorded by Saccardo have been found in North America. The important species are *Tilletia setens* bunt or stinking smut of wheat; *Tilletia tritici* on wheat; *Tilletia horrida* in the ovaries of cultivated rice; *Tilletia anthoxanthi* in the ovaries of the sweet vernal grass, *Anthoxanthum odoratum*; and *Tilletia Maclagani* on a wild grass, *Panicum vigatum*. *Urocystis cepulæ* is the onion smut; *Urocystis occulta* on the stems and sheaths of rye; *Urocystis violæ* on the stems, rootstocks, petioles and leaves of violets, *Entyloma crastophilum levis* on such grasses as *Agrostis*, *Poa*, *E. Ellisii* forms pale white spots on spinach leaves in New Jersey. *Entyloma lineatum* grows on wild rice, *Zizania aquatica*; *Entyloma thalictri* on the meadow rice, *Thalictrum polygamum*; *Entyloma lobeliæ* or *Lobelia inflata*; *Entyloma nymphææ* on the leaves of *Nuphar advena* and *Nymphæa odorata*.

The species of *Doassansia* mostly grow on plants, such as: *Sagittaria*, *Potamogeton*, etc., growing in moist situations. Ten species occur in North America.

BIBLIOGRAPHY OF THE SMUTS

- ARTHUR, J. B.: Rapid Method for Removing Smut from Seed Oats. Bull. 103, vol. xii, Agric. Exper. Stat. Purdue University, March, 1905.
- CLINTON, G. P.: The Smuts of Illinois Agricultural Plants. Bull. 57, Agric. Exper. Stat. Urbana, March, 1900.
- CLINTON, G. P.: North American Ustilagineæ. Journal of Mycology, 8: 128-156, October, 1902.
- CLINTON, GEORGE P.: North American Ustilagineæ, Proceedings Boston Society of Natural History, 31: 504, 1904.
- CLINTON, GEORGE P.: The Ustilagineæ, or Smuts, of Connecticut. Bull. 5, State Geological and Natural History Survey, 1905.
- CLINTON, GEORGE P.: Ustilaginales (Ustilaginaceæ, Tilletiaceæ). North American Flora, 7, part I: 1-82, Oct. 4, 1906.
- DIETEL, P.: Hemibasidii. Die natürlichen Pflanzenfamilien, I. Teil, Abt. 1, 1900: 2-24.
- DUGGAR, B. M.: Fungous Diseases of Plants, 1909: 370-383.
- ERIKSSON, JAKOB: Fungoid Diseases of Agricultural Plants, 1912: 44-62.
- GARRETT, A. O.: The Smuts and Rusts of Utah. Mycologia, II: 265-304, November, 1910.

- GÜSSOW, H. T. Smut Diseases of Cultivated Plants. Their Cause and Control, Bull. 73, Division of Botany, Central Experimental Farm, Ottawa, Canada, March, 1913.
- HENDERSON, L. F.: Smuts and Rusts of Grains in Idaho. Bull. 11, Agric. Exper. Stat., Idaho, 1898.
- HITCHCOCK, A. S. and NORTON, J. B. S.: Corn Smut. Bull. 62, Exper. Stat., Kansas State Agricultural College, December, 1896.
- MASSEE, GEORGE: Text-book of Fungi; 1906: 313-325.
- MASSEE, GEORGE and IVY: Mildews, Rusts and Smuts: a Synopsis of the Families, Peronosporaceæ Erysiphaceæ, Uredinaceæ and Ustilaginaceæ, 1913: 182-205.
- SMITH, WORTHINGTON G.: Diseases of Field and Garden Crops, 1884: 245-262.
- STEVENS, F. L.: The Fungi Which Cause Plant Disease, 1913: 298-323.
- SWINGLE, WALTER T.: The Grain Smuts: How They Are Caused and How to Prevent Them. U. S. Farmers' Bull. 75, 1898.
- UNDERWOOD, L. M.: Moulds, Mildews and Mushrooms, 1899: 81-85.
- VON TAVEL, F.: Vergleichende Morphologie der Pilze, 1892: 109-120.
- VON TUBEUF, K.: Pflanzenkrankheiten, 1895: 289-340.
- VON WETTSTEIN, RICHARD R.: Handbuch der Systematischen Botanik, 1911: 193-195.

CHAPTER XIX

RUST FUNGI

SUBORDER UREDINEÆ.—Usually in systematic works placed as ORDER UREDINALES. The fungi belonging to this suborder are characterized by basidia which are divided either by transverse or longitudinal septæ. In this character, they are contrasted with the EUBASIDII, which have unseptate basidia. Including the rusts this suborder embraces some of the most important disease-producing fungi, the study of which concerns the mycologist.

The uredineous fungi are those which are strictly parasitic and which in some cases are so specialized, that their growth is confined to the species of a single host. Those fungi in which the different stages of the life cycle are passed on the same host are known as autoëcious, while those which grow on two or more hosts are known as heteroëcious. The plant on which the final stage is passed is called the final host, while the other plant on which some of the stages occur is designated the alternate host. So specialized is the nutrition of the rust fungi, that they never have been grown on culture media off the host plants on which they live. Hence, they are obligate parasites. The mycelium is septate, much-branched, usually ramifying between or in the walls of the cells and sending haustoria into the cell cavities. The reproductive spores are borne in more or less definite clusters, or sori, below the surface of the host, or rarely singly, and the spores are set free by the breaking open of the overlying tissues of the hosts.

Five different kinds of spores may be found in the uredineous fungi, but they are not all present in every genus (Fig. 64). The final spore form is known as the teliospore, or teleutospore, which determines the name which is to be applied to the parasite. Such spores are borne in a sorus known as a telium. When these teliospores germinate, they produce a four-celled promycelium known as a basidium, and this abstricts sporidia, or more properly basidiospores, which are minute, thin-walled spores without surface sculpturings. These are succeeded by spermogonia (spermogonium), which are now called by most

American mycologists, pycnia (pycnium), in which spermatia, or pycniospores, are formed. Pycnia indicate the nature of the life cycle and furnish positive characters for identification. Arthur has shown that if pycnia and urediniospores are found arising from the same mycelium, æcidia do not occur in the cycle; and if pycnia and teliospores are found there are neither uredinia nor æcia in the life cycles. These pycniospores are accompanied or succeeded by æciospores (æcidiospores), which appear in the cluster cups, or æcia in long chains. The peridia of the different kinds of æcia are variable, and hence

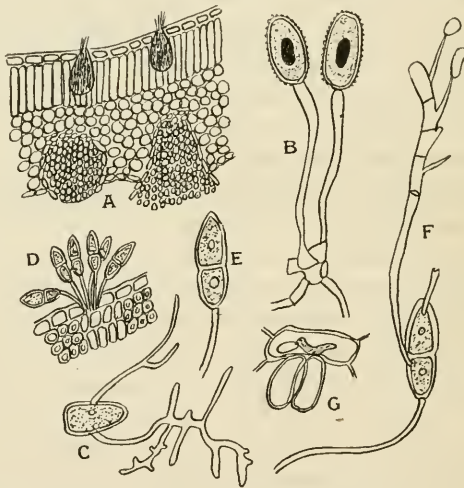

FIG. 64.—Spore forms of wheat rust, *Puccinia graminis*. A, Section through barberry leaf showing pycnia on upper surface and æcia on lower; B, two urediniospores; C, germinating urediniospore; D, teliosorus showing several teliospores; E, single two-celled teliospore; F, germinating teliospore with four-celled basidium and two basidiospores; G, basidiospore growing on barberry leaf. (Adapted from deBary.)

mycologists have described four different kinds of form genera: *Cœoma* = peridium absent; *Æcidium* = cup-shaped and peridium toothed; *Ræstelia* = peridium elongate and fimbriate; *Peridermium* = peridium irregularly split and broken. Urediniospores (uredospores) succeed the æciospores and they appear in sori known as uredinia (uredinium). Amphispores are special forms of urediniospores formed in arid, or semi-arid climates and usually have a thick cell wall and a persistent pedicel. They are in the nature of a resting spore. Mesospores are exactly of the same nature as the two-celled teliospores, but they arise merely by the omission of the last nuclear division, and hence,

have only one cell. These different kinds of spores, representing stages in the life histories of the different genera and species of rusts are designated, as follows: O = pycnium; I = æcium; II = uredinium; III = telium. The determination of the presence or absence of these spores in the various life histories has been made for a large number of rusts, and we are now in a position to tabulate the results of this study and to give names to the different forms of rust life cycles which have been found. We call a fungus possessing:

O I II III	an Eu-form	{ Auteu-form, if all four kinds are found on one plant (Ex. <i>Puccinia Asparagi</i> on <i>Asparagus officinalis</i>). Hetereu-form, if O, I occur on one species and II, III on another (Ex. <i>Puccinia graminis</i> is on wheat and barberry).
O I III	an opsis-form	
O II III	a Brachy-form	(Ex. <i>Puccinia suaveolens</i> on Canada thistle).
[O] III	a Micro-form	pycnia (spermogones) sometimes absent (Ex. <i>Puccinia ribis</i> on currant).

A Lepto-form is one, of whatever kind, in which the teliospores grow as soon as mature without any period of rest, as *Puccinia malvaearum* on hollyhock. W. B. Grove in his "British Rust Fungi," page 40, gives a diagram which represents all of the possible life cycles of the different forms of rust fungi. It is reproduced here (Fig. 65).

As a fungus which shows a complete life history passed on two distinct host plants, we will take the black rust of cereals, *Puccinia graminis* (Fig. 64), first carefully studied by the German botanist, Anton de Bary, in 1864-65. It infests all the common cereals, wheat, rye, barley and oats, also many grasses. It appears on the wheat plant, when the host is about ready to produce its spikes of flowers. It appears on the leaves and culms of the wheat plant, as orange-red lines, which represent cracks in the epidermis of the host exposing the sori, or uredinia filled with rust-red spores, urediniospores. These summer spores are yellowish and their surface spinulose with four equatorial germ pores. These urediniospores may follow each other on several crops during the early summer. This summer stage is succeeded by the autumn stage in which the sori become filled with stalked, two-celled, dark-colored spores with thick walls. The common name of this stage is "black rust." Wintering in the open these two-celled teliospores germinate. Each of the two cells may sprout out a promycelium, or only one may do so. This basidium (promycelium) is

upright and divided transversely into four cells, each of which cuts off a basidiospore. These basidiospores are blown to the leaves, twigs, or fruits of the barberry where a mycelium is formed. Later pycnia (spermogonia) appear on the upper side of its leaf. These are accompanied by round, fringed depressions, the cluster cups or æcia, which appear in the spring on the lower side of the leaves. The æciospores are arranged in chains. These spring spores, æciospores, are carried to the wheat plant where they induce the characteristic rusted appearance

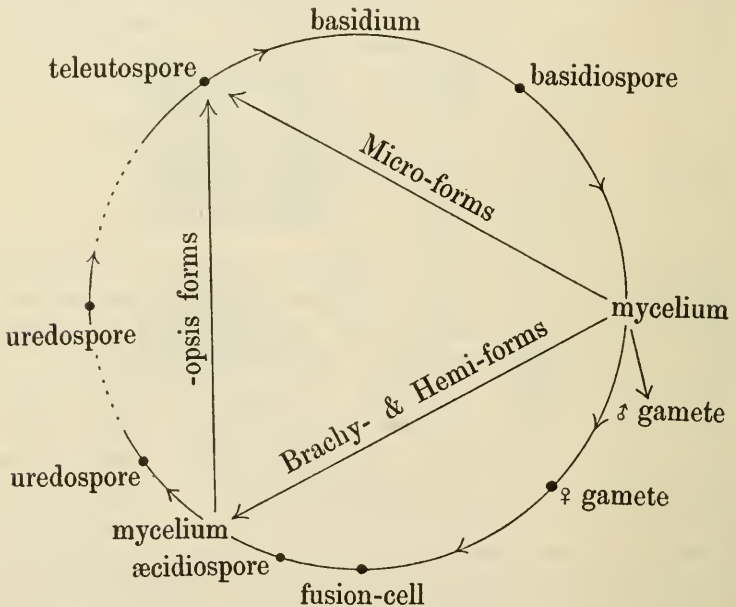

FIG. 65.—Relations of various spore forms of rusts to each other. (After Grove, W. B., *The British Rust Fungi*, 1913, 40.)

of the cereal. The wheat plant is not killed by the attack of the fungus which, however, prevents the reserve foods from being properly stored in the grains; hence, they are mushy and unfit for storage, or for bread-making purposes. It has been recently shown that in Australia and the plains of India, where the barberry is unknown, the black rust of wheat does serious damage. Three methods are open to the wheat rust to winter over: (1) The fungus may winter by its urediniospores, (2) by a perennial mycelium, (3) by Eriksson's mycoplasm. Arthur, in America, and others have shown that it winters by its urediniospores, or

amphispores, as they have been termed by some, but in conversation with Arthur he insisted that the perennating spores are typical urediniospores, so that the postulation of a perennial mycelium, or a hibernating fungous protoplasm in the cells of the grain (mycoplast) is unnecessary. Eriksson has proved that in Sweden six forms of *Puccinia graminis* may be distinguished; which he enumerates as follows:

A. Not distinctly fixed (occasionally going over to other forms of grass): (1) f. sp. **tritici** on wheat (seldom on rye, barley and oats).

B. Distinctly fixed (firmly confined to the indicated species): (2) f. sp. **secalis** on rye, barley and on couchgrass, *Agropyron repens*, *Elymus arenarius*, *Bromus secalinus* and others; (3) f. sp. **avenæ** on oats and on *Avena elatior*, *Dactylis glomerata*, *Alopecurus pratensis*, *Milium effusum* and others; (4) f. sp. **poæ** on *Poa compressa* and *P. pratensis*; (5) f. sp. **airæ** on *Aira cæspitosa* and *A. bottnica*; (6) f. sp. **agrostis** on *Agrostis canena* and *A. stolonifera*. An oat plant infected with this rust can in its turn infect wheat, rye, barley and so forth. The black rust of cereals is the classic example of an heterœcious rust.

The asparagus rust, *Puccinia asparagi*, may be used to illustrate the life history of an autœcious species. All the spore forms are produced on stems and twigs. The æcia appear in long, light green cushion-like areas, which are short cylindrical with a white peridium. The æciospores are orange-colored and the wall is hyaline. The pycnia appear in yellow clusters followed by the æciospores in early summer. The uredinium is filled with yellowish-brown, thick-walled urediniospores with three or four germ pores. The black rust stage (telium) appears later in the season, when the two-celled stalked teliospores push out from beneath. The whole life cycle is passed on the asparagus plant.

CYTOLOGY OF THE RUSTS.—According to the earlier researches of V. H. Blackman (1904), A. H. Christman (1905), O. H. Blackman and Miss H. C. Fraser (1906), Edgar W. Olive (1908), Kurssanow (1910) and Dittschlag (1916), supplemented by the research of other botanists, a flood of light has been thrown on the nuclear behavior in the rusts, and accordingly on their sexuality, or non-sexuality. Blackman discovered in *Phragmidium violaceum* (Fig. 66), that in the formation of the æcidium, there was a fusion of two cells by which the nucleus of one passed over into the adjoining cell. In the formation of spores the paired nuclei of the fusion cell divide side by side and simultaneously (conjugate division) so that we find that the basal cell, the æcio-

pores and intercalary cells all have two nuclei, which are not sister nuclei. The upper cell, cut off from the fusion cell, is the æciospore mother cell; the lower grows a little longer and then divides again in the same way, and thus a vertical series of æciospore mother cells is formed, the oldest at the top. Each of the æciospore mother cells,

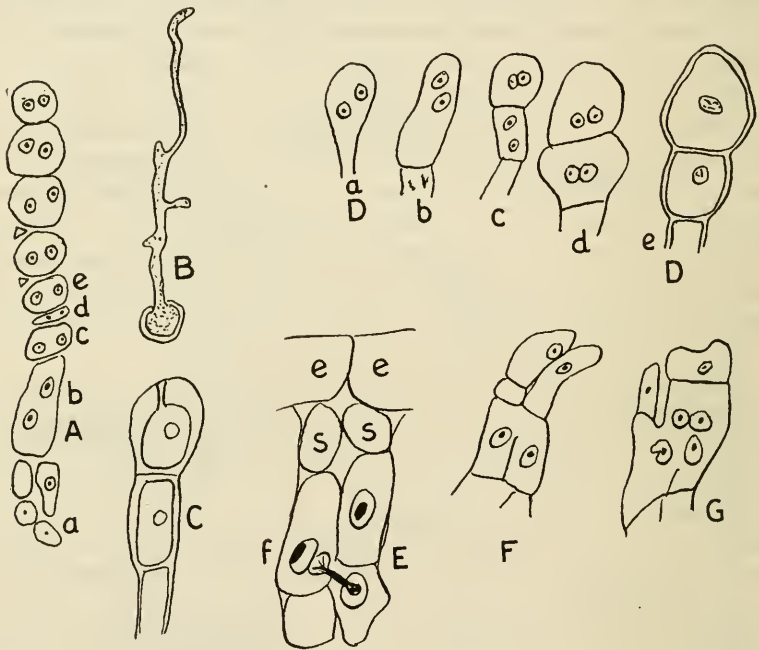

FIG. 66.—A, Chain of young æciospores of *Puccinia caricis*; a, fusion tissue; b, basal (fusion) cell with conjugate nuclei; c, æciospore mother-cell; d, intercalary cell; e, young æciospore; B, germinating æciospore of *P. caricis*; C, teliospore of *P. caricis*; D, formation of teliospores of *P. falcaria* (after Dittschlag); E, development of æcium (after Blackman) of *Phragmidium violaceum*; e, epidermal cell; s, sterile cell; below these cells a nucleus is seen migrating into the adjacent cell f; F and G, conjugation of two female cells to form basal cell of æciospore chain (after Dittschlag). In G the first conjugate division is just completed. (Adapted from Grove, *British Rust Fungi*.)

as soon as it is formed, cuts off by conjugate division a small cell below, called the intercalary cell; this soon disorganizes and disappears, while the other portion remains as the æciospore. The succeeding urediniospores have two nuclei in the conjugate condition and this is continued over into the cells of the young teliospores (Figs. 67 and 68). Before

the teliospore reaches maturity, the nuclei fuse, and the uninucleate condition then continues again until the formation of the aecia. In the *micro-* and *lepto-*forms, which have no aecium or uredinium, we find that the association takes place at points in the ordinary mycelium, but

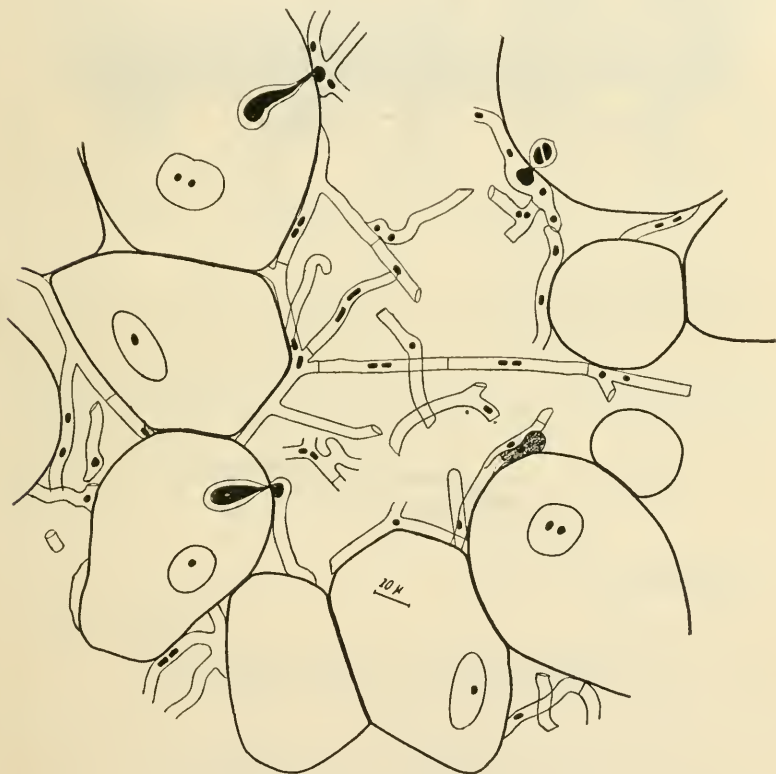

FIG. 67.—Portion of a section of cedar apple about 5 mm. below a teliosorus. NOTE (1) Binucleate intercellular mycelium; (2) the haustoria in various stages of development; (3) the doubling of nucleoli in the nuclei of some of the parenchyma cells of the host. Material collected on March 31. (After Reed, H. S., and Crabill, C. H., *Techn. Bull.* 9, Va. Agric. Exper. Stat., May, 1915.)

always before the formation of the teliospores. Whether the association of nuclei in the ordinary mycelium takes place by the migration of a nucleus from one cell to another, or whether two daughter nuclei become conjugate in one cell has not been settled definitely. The pycnospores are probably abortive male cells. They have never

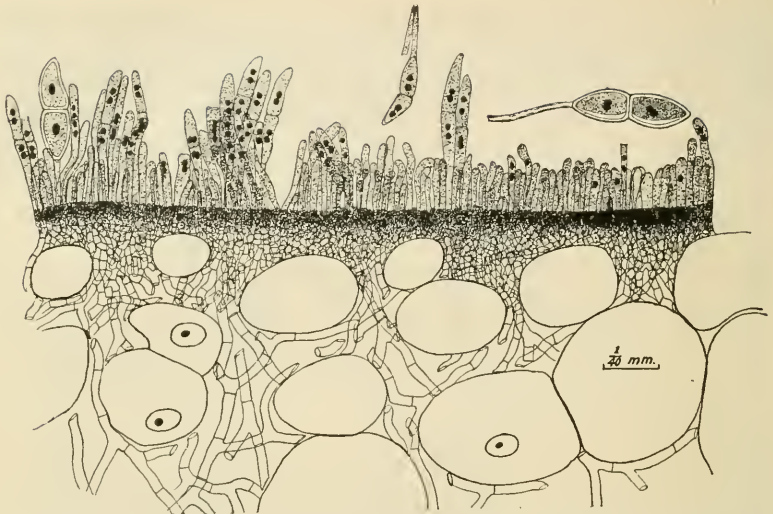

FIG. 68.—Portion of a teliosorus of cedar apple in February showing mycelia stroma and the binucleate condition of the cells of young teliospores. (After Reed, H. S., and Crabill, C. H., *Techn. Bull.* 9, Va. Agric. Exper. Stat., May, 1915.)

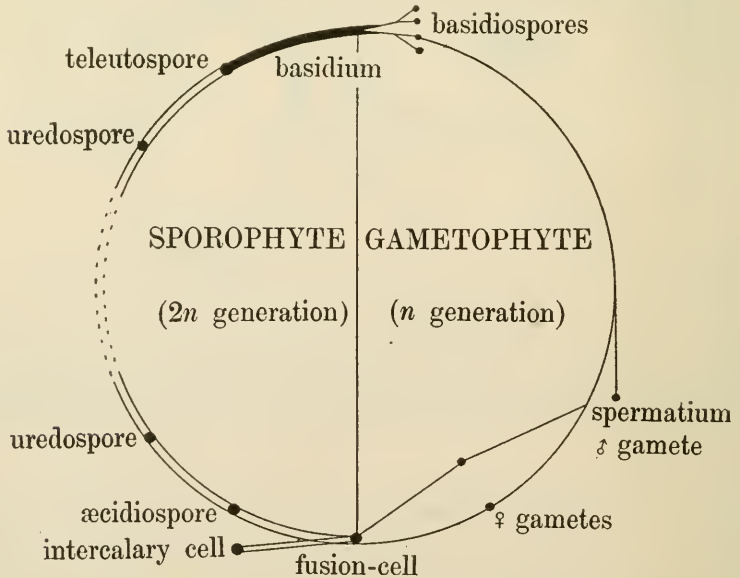

FIG. 69.—Diagram of the alternation of generations of a typical rust. (After Grove, W. B., *The British Rust Fungi*, 1913, 27.)

been known to germinate, and the large size of their nuclei suggests that we are dealing with male cells.

The mature teliospore, which may be looked upon as a spore mother cell, has a single fusion nucleus. "The fusion nucleus is large, round and (when unstained) perfectly clear and homogenous, but for its nucleolus, so that it looks like a vacuole; it occupies almost invariably the middle of a cell. The dense chromatin mass is loosened out into a kind of spireme which becomes shorter and thicker; the nuclear membrane then disappears, and the spireme thread splits longitudinally, though the splitting is often indistinct. It then divides transversely into segments which become arranged, or strung out, on a spindle (sometimes, but more rarely, in an equatorial plate); then the daughter nuclei are formed at the poles, and the next division, which is homotypic, follows immediately" (Harper and Holden, 1903; Blackman, 1904). These nuclei are found in each of the four cells which form the basidium, and ultimately, they pass into each of the four basidiospores which are uninucleate and haploid.

The alternation of generations which has thus been determined by the various cytologic studies of recent years may be displayed in a diagram adapted from Grove (Fig. 69).

The same life cycle may be represented in another way.

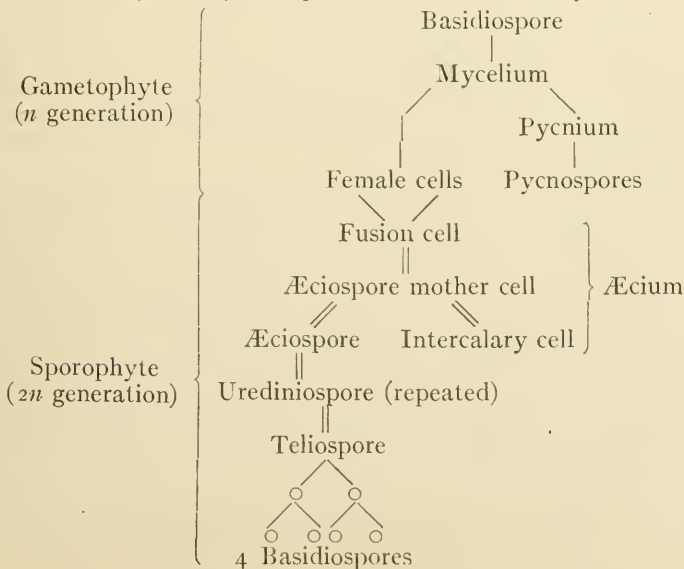

Endophyllum sempervivi which attacks the house leek, *Sempervivum*, and causes its rosette of normally spreading leaves to stand erect, shows a somewhat different condition, which has led to the supposition that it represents the primitive life cycle of the higher ure-dineous fungi. Its life history has been investigated by Hoffman (1911). The spores mature on the house-leek leaves in April and May. They germinate at once in the æcidoid telium and a four-celled basidium is formed; hence, the spore looks like an æciospore and partakes of the nature of a teliospore and may be called an æcio-teliospore. Each basidium produces four basidiospores on long sterigmata, and they are blown to the leaf of a house leek, where they begin growth at once by boring through the cuticle, and the mycelium then grows through the intercellular spaces of the host sending haustoria into the cells, growing down to the base of the leaf and into the axis up to the growing point, where it perennates until the following spring, when it enters the freshly formed leaves, which become yellow, longer and more erect.

Pycnia are formed in March and April followed by æcio-telia, which repeat the cycle. Hoffman has established the most interesting point about this rust, that the æcio-teliospore chain arises from a cell produced by the fusion of two adjacent cells of the spore bed after the manner described by Christman except the conjugating cells were not in any definite plane. The binucleate æcio-teliospores then become uninucleate by the fusion of the conjugate nuclei. The formation of the basidiospores from these æcio-teliospores probably follows a reduction division.

Kunkel (1914) has shown that a study of the binucleate æciospores of *Cæoma nitens* during germination shows that they become uninucleate previous to the production of the promycelia. The normal germination of the æcio-teliospore consists in the pushing out of a germ tube into which the protoplasmic contents of the spore passes. The nucleus which travels out into the tube divides producing two nuclei which may divide again immediately and cell division may follow at once, but in other cases the four nuclei of the promycelium (basidium) may be present before cross walls are formed. Ultimately, four cells are found filled with protoplasm and uninucleate. The basidiospore arises as an enlargement of the sterigma and the nucleus enters when it is one-half developed. *Cæoma nitens* although like *Endophyllum sempervivi* in some respects is more primitive, since it possesses a simpler æcium.

PHYLOGENY OF THE UREDINEÆ (UREDINALES)

In looking for the primitive types of rust fungi, it has been assumed by some mycologists, that, as the rusts are a specialized group of parasites, the most primitive forms will be found on hosts which are lowest in the phylogenetic scale of the higher plants. This consideration would place *Uredinopsis*, which grows upon ferns, as one of the primitive rusts, while many of the more advanced types of *Puccinia* are found upon the COMPOSITÆ. The absence of a germ pore is considered primitive, as instance its absence in the æcio-teliospore of *Endophyllum*. When these first appeared, they were numerous and indefinitely scattered, while in the higher rusts, they are reduced in number and restricted to a definite part of the cell wall. The formation and germination of teliospores approaches that of the smuts a more primitive group, hence the formation of a basidium and basidiospores must have been inherited by both from their ancestors. Now among the red algæ, such as *Griffithsia*, the sporophyte bears tetraspores, these develop into a thallus which bears the gametes. Hence one would look for the ancestors of the UREDINEÆ among red algæ. Again, it has been suggested that the female cells of the æcium have a trichogyne, such as the red seaweeds (Florideæ) possess. In the rusts, it has become abortive.

The ENDOPHYLLACEÆ are considered by Grove to constitute the starting point from which the varied forms of the PUCCINIACEÆ have been derived. In *Endophyllum*, we have seen that the æciospore, which is the product of the fusion cell, is also the teliospore from which the basidium and basidiospores arise. The æcium is accompanied by the pycnium here. The first stage of evolution was the separation of this spore form into two: one the æciospores, germinating like conidiospores; the other, the teliospore, germinating with the formation of a basidium and basidiospores. *Pucciniopsis* suggests these stages. The summer spores are probably modified æciospores formed as a device for repeating the spore generations without the intervention of another fusion cell. The fusion of the two nuclei in the teliospore is from a cytologic standpoint paralleled by a similar fusion in the BASIDIOMYCETALES, for a division into four basidiospores follows in both cases, although the mechanism is different. The paired condition of the nuclei found in the ascogenous hyphæ of the ASCOMYCETALES, such as *Pyronema confluens* investigated by Claussen (1912), and in the

formation of the ascus, the two non-sister nuclei fuse after which the fusion nucleus divides, the first division being heterotypic (meiotic, reducing, possessing synapsis and diakinesis stages), and the two following ones, which result in the formation of eight ascospores, are homotypic. From this point of view, the ascus is a spore mother cell comparable to the teliospore of the rust fungi, but forming an octad, not a tetrad of spores. The probable phylogeny and relationship of the UREDINEÆ to the other groups has been set forth in a family tree by Grove.

Arthur, who has studied the rusts carefully for many years, proposed at the International Congress of Botanists held in Vienna in 1905 an arrangement of the families, genera and species of the rusts, which differs materially from the older classifications.

As this classification of Arthurs has not been elaborated in detail, it has been considered best to follow the arrangement of families, sub-families and genera given in *Engler and Gilg's* "Syllabus der Pflanzenfamilien" (7th Edition, 1912) as following the conservative and older treatment.

FAMILY ENDOPHYLLACEÆ.—The teliospores are abstricted successively in long rows and are surrounded by a peridium which is formed like that of a typic æcidium of *Puccinia* from the peripheral cell rows, but is sometimes less strongly developed. These teliospores are perhaps more correctly called æcio-teliospores, as they are separated from each other by intercalary cells like true æciospores and arise from a fusion cell, but they germinate by the formation of a basidium and basidiospores like true teliospores. The germ pores are imperceptible and the spore wall is colored. Pycnia are present and both kinds of sori are subepidermal.

Endophyllum sempervivi lives parasitically on the house leek, *Sempervivum tectorum*, and several other species of *Sempervivum* in Europe from April to August. It has been proved by de Bary, Hoffmann and others, that the basidiospores produced by the æcio-teliospores infect the leaves of the house leek and from them arises a mycelium which lives over the winter in the stem. The following spring, it forms pycnia and æcio-teliospores and the affected leaves are more erect than normal ones, twice as long, narrower and yellowish at the base.

FAMILY MELAMPSORACEÆ.—The teliospores are unstalked, one- to four-celled, but placed singly on dilated hyphæ in the tissues of the

host, or arranged side by side in flat crusts. Germination of the teliospore results in the formation of a four-celled basidium, each cell of which forms a single basidiospore. The æcium is typically without a peridium, hence, a cœoma and the urediniospores appear in long chains without a peridium, or arising singly, and then mostly surrounded by the peridium, or mixed with paraphyses.

The genus *Melampsoropsis* includes fungi whose teliospores are in cushion-like layers, which break through the epidermis of the host. *M. ledi* has its teliospores on *Ledum* and its æcia on the spruce, *Picea excelsa*, in Europe, and on *P. rubra* in this country. The æcia of *Cronartium* have a broad, inflated irregularly torn peridium. The uredinium is enclosed in a hemispheric peridium, which opens at the summit by a narrow pore. Its teliospores are abstricted in long chains and remain united into cylindric columns, which are horny when dry. The European *C. asclepiadeum* has its æcia on the branches of *Pinus silvestris* in May and June, and its urediniospores and teliospores on *Pæonia officinalis* in gardens, as also on *Vincetoxicum*, *Cynanchum* and *Verbena*. *C. quercuum* has its æcia on *Pinus* and its urediniospores and teliospores on at least twenty species of oak in North America. *C. ribicola* is a dangerous parasite called the white pine blister rust and against it the United States Government has an active quarantine. Its æcium is confined to the five-leaved pines, one of which is *Pinus strobus*, our eastern white pine. These are found in the months from March to June. The urediniospores and teliospores grow on the currants, *Ribes nigrum* and *R. rubrum*. The fungi of the genus *Melampora* are mostly heterœcious. There are seven species recorded for North America. Of these *Melampora medusæ* causes the poplar rust. The æcium occurs on the larch, *Larix*, and its urediniospores and teliospores on *Populus deltoides*, *P. tremuloides* and *P. balsamifera*. *Calyptospora* is a genus of rusts, the life history of which has been investigated by Hartig, Kuhn and Bubák. In July to September, the teliospores appear on the stems of *Vaccinium vitis-idaea*, where the stem becomes swollen and elongated and at first of a pink color passing to brown. It occurs on other species of *Vaccinium*, including *V. pennsylvanicum* in the United States. The æcia are found in Europe on leaves of *Abies pectinata* and in America on *A. balsamea*.

FAMILY COLEOSPORIACEÆ.—The æcium in this family has a peridium. The flattish, linear pycnia are subepidermal dehiscing by a

slit. The teliospores consist of four superimposed cells. There is a North American species of this family, *Gallowaya pini* (formerly *Coleosporium pini*), which has teliospores only and these on the leaves of *Pinus inops*, i.e., on trees of the same order on which *Coleosporium* has



FIG. 70.—A-D, *Uromyces pisi*. A, Ascidia on deformed leaves of *Euphorbia cyparissias*; B, ascidia enlarged; C, teliosori on leaves of *Pisum sativum*; teliosori enlarged; E and F, *Uromyces trifolii* on *Trifolium hybridum*. (After Dietel, Die natürlichen Pflanzenfamilien I. 1A**, p. 55.)

its æcia. In *Coleosporium*, the teliospores are adherent closely with a rounded, thickened, gelatinizing pore. The long sterigmata bear large, ovate, flattened sporidia. The orange rust of asters and golden rods, *C. solidaginis* is reported to cause a sickness of horses, some-

times resulting in the death of the animals. Its urediniospores and teliospores are on compositous plants and its æcial stage on the pitch pine, *Pinus rigida*, this stage being known in the older books as *Peridermium acicolum*. The species of the genus are all heterœcious, and æcial stages, whenever found, occur on species of *Pinus* and are referable to the form genus *Peridermium*. Arthur and Kern enumerate twenty-seven species of *Peridermium*, ranging from Mexico to Alaska, and from the Atlantic to the Pacific coasts. The species are all æcia of species belonging to telial genera, but they cannot be always satisfactorily assigned because of incomplete knowledge regarding them. The genus *Peridermium* embraces all æcial forms possessing peridia, inhabiting the PINACEÆ and GNETACEÆ. Only three of the twenty-seven American species have been associated with telial forms as follows:

Peridermium pini connected with *Coleosporium campanulæ* on *Campanula*.

Peridermium cerebrum connected with *Cronartium* on oak.

Peridermium elatinum connected with *Melampsorella cerastii*.

FAMILY PUCCINIACEÆ.—In this family, the teliospores usually consist of a single cell, or a vertical row of superimposed cells sometimes united into a small bead-like cluster. The teliospores are borne on a simple, or a compound pedicel. The urediniospores are single, on hyaline, deciduous stalks. The æcia usually have a peridium. The most important genera of the family are: *Uromyces*, *Puccinia*, *Gymnosporangium*, *Gymnoconia* (Fig. 71) and *Phragmidium*.

The rusts belonging to the genus *Uromyces* have one-celled winter, or teliospores, which are egg-shaped, individually separated and massed in small, open spore groups. The important pathologic species are the clover rust, *Uromyces trifolii*; the rust of beans, *U. appendiculata*; beet rust, *U. betæ*; carnation rust, *U. caryophyllinus* (Fig. 70). The largest genus of the rusts, *Puccinia*, has usually two-celled teliospores, although unicellular ones may occur in some species. The principal cereal or grain rusts may be enumerated first, as they are fairly well known, owing to the researches of Eriksson and others:

Black Rust of Cereals, *Puccinia graminis* (Fig. 64) with its æcium on the barberry, *Berberis vulgaris*. Six forms of this species may be distinguished: (1) f. sp. *tritici* on wheat (seldom on rye, barley and oats); (2) f. sp. *secalis* on rye, barley and couch grass, *Agropyron*

repens, *Elymus arenarius*, *Bromus secalinus* and others; (3) f. sp. *avenæ* on oats and *Avena elatior*, *Dactylis glomerata*, *Alopecurus pratensis*, *Milium effusum*, etc.; (4) f. sp. *poæ* on *Poa compressa* and *P. pratensis*; (5) f. sp. *airæ* on *Aira cæspitosa* and *A. bottnica*; (6) f. sp. *agrostis* on *Agrostis canina* and *A. stolonifera*.

Brown Rust of Rye, *Puccinia dispersa*, with its cluster cups on *Anchusa arvensis* and *A. officinalis*.

Crown Rust of Oats, *Puccinia coronifera*, with its æcium on the buckthorn, *Rhamnus cathartica*. Of this species there are eight

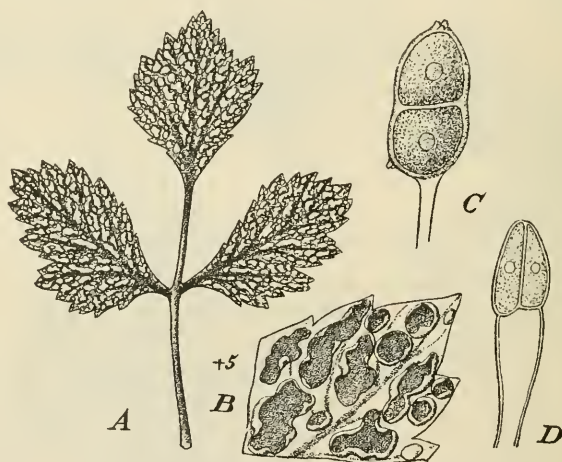

FIG. 71.—A-C, *Gymnoconia interstitialis*. A, Aecidia on leaf of *Rubus canadensis*; B, piece of leaf enlarged; C, teliospore; D, teliospore of *Sphenospora pallida*, 500/1. (After Dietel: *Die natürlichen Pflanzenfamilien* I. 1A**, p. 70.)

specialized forms, as follows: (1) f. sp. *avenæ* on oats; (2) f. sp. *alopecuri* on *Alopecurus pratensis*; (3) f. sp. *festucæ* on Festucas; (4) f. sp. *lolii* on rye grass, *Lolium perenne*; (5) f. sp. *glyceriæ* on *Glyceria aquatica*; (6) f. sp. *agropyri* on *Agropyron repens*; (7) f. sp. *epigæi* on *Calamagrostis epigeios*; (8) f. sp. *holci* on *Holcus lanatus*.

Crown Rust of Grasses, *Puccinia coronata*, with its æcium on *Rhamnus frangula*. Three special forms of this rust are known: (1) f. sp. *calamagrostis* on *Calamagrostis arundinacea*; (2) f. sp. *phalaridis* on

¹ ARTHUR, J. C. and KERN, F. D.: North American Species of Peridermium. Bull. Torr. Bot. Club, 33: 403-438, 1906.

Phalaris arundinacea; (3) f. sp. *agrostis* on *Agrostis vulgaris* and *A. stolonifera*.

Yellow Rust of Wheat, *Puccinia glumarum*, without any known æcial stage. It has according to Eriksson the following specialized forms: (1) f. sp. *tritici* on wheat; (2) f. sp. *secalis* on rye; (3) f. sp. *hordei* on barley; (4) f. sp. *Elymi* on *elymus arenarius*; (5) f. sp. *agropyri* on couch grass, *Agropyron repens*.



FIG. 72.—Hollyhock rust, *Puccinia malvacearum*. (Nantucket, August 19, 1915.)

Brown Rust of Wheat, *Puccinia triticina*, with æcia unknown.

Dwarf Rust of Barley, *Puccinia simplex*.

Timothy Rust, *Puccinia phlei-pratensis*. Experiments to get this form to infect barberry leaves have met with indifferent success.

Chrysanthemum Rust, *Puccinia chrysanthemi*, on leaves of *Chrysanthemum sinense* in greenhouses all the year round.

Dandelion Rust, *Puccinia taraxaci*, on the dandelion *Taraxacum officinale*, rather common in Europe, North America, Japan and the East Indies.

Reed Grass Rust, *Puccinia phragmitis*, with æcia on *Rumex crispus*, *R. obtusifolius* and urediniospores and teliospores on reed grass *Phragmites communis*.



FIG. 73.—*Roestelia aurantiaca* on fruit of *Amelanchier intermedia* corresponding to *Gymnosporangium clavipes* on red cedar. (Shelter Island, New York, July 16, 1915.)

Ash Rust, *Puccinia fraxinata*, on leaves and petioles of ash and urediniospores and teliospores on salt grass, *Spartina Michauxiana*.

Asparagus Rust, *Puccinia asparagi*, develops all of its spore forms on the cultivated asparagus.

Violet Rust, *Puccinia violæ*, is parasitic on about forty-six different

species of violets in Asia, Europe, North and South America. It is autoecious.

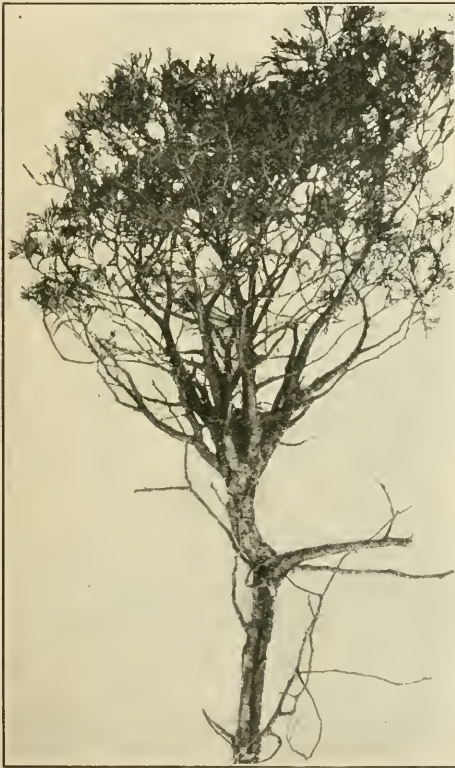

FIG. 74.—Witches' broom caused by *Gymnosporangium Ellisiai*. (After Harshberger, *Proc. Acad. Nat. Sci. Phila.*, May, 1902.)

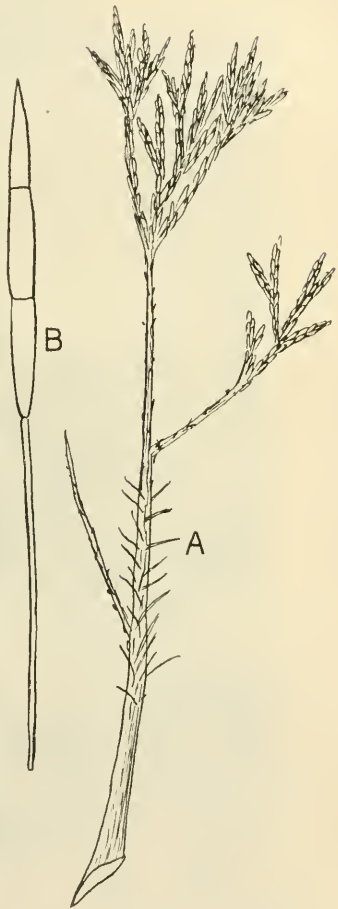

FIG. 75.—A, Protruding fili-form horns of the rust fungus, *Gymnosporangium Ellisiai* on white cedar; B, teliospore. (May 27, 1916.)

Mint Rust, *Puccinia menthæ*, is also an autoecious rust.

Maize Rust, *Puccinia sorghi*, is widely distributed in maize-growing countries. Its æcia are less common on various species of *Oxalis*.

Rust of Stone Fruits, *Puccinia pruni-spinosa*, occurs on various species of the genus *Prunus* in the southern and central United States.



FIG. 76.—Fully expanded cedar apple on red cedar. Long yellow teliosori as finger-like projections are seen. (After Jones and Bartholomew, Bull. 257, Agric. Exper. Stat., Univ. Wisc., July, 1915.)

The æcial stage occurs on *Anemone* and *Hepatica*, and is known as *Æcidium punctatum*.

Hollyhock Rust, *Puccinia malvacearum* (Fig. 72), is found over the world, where the hollyhock, *Althæa rosea*, is grown.

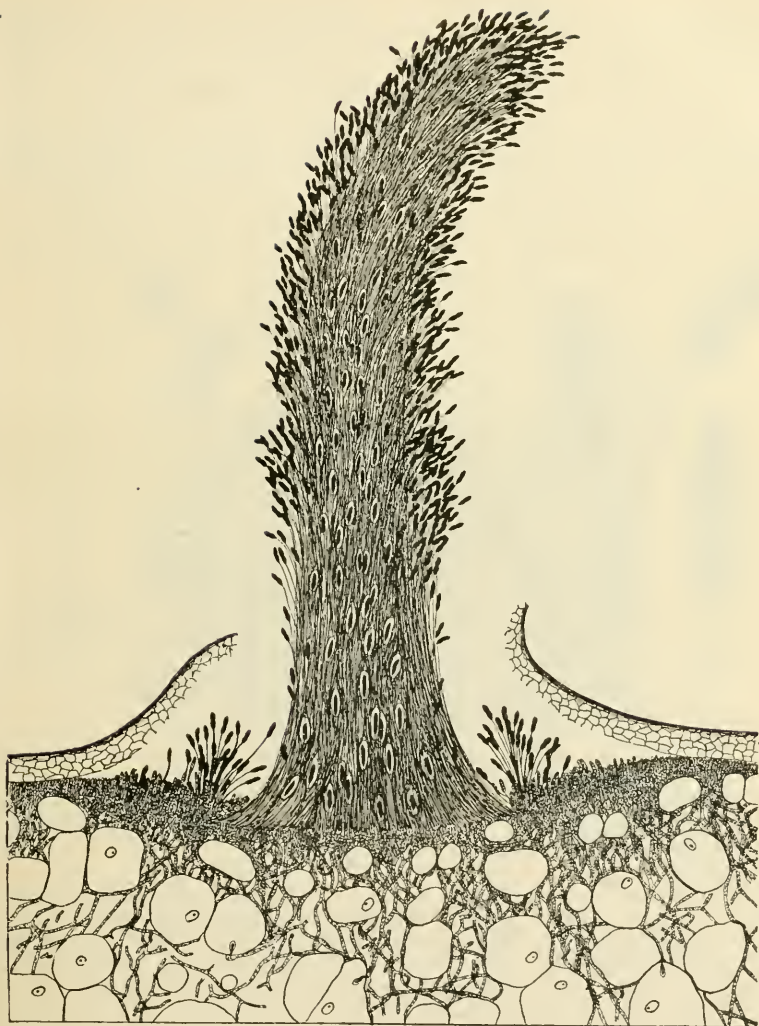

FIG. 77.—Longitudinal section of a partly gelatinous teliosorus after the extension of the tentacles. (After Reed, H. S., and Crabill, C. H., *Techn. Bull.* 9, Va. *Agric. Exper. Stat.*, May, 1915.)

Belonging to the genus *Gymnoconia* (Fig. 92) is the orange rust of raspberry and blackberry which is found throughout the United States and Canada. It is also widely distributed in Europe and Asia.

The genus *Phragmidium*, which is confined entirely to plants of the rose family, is autœcious. Warts are formed on the teliospores by the contraction of an outer gelatinous layer which with a rigid middle lamina and the arrangement of the germ pores distinguishes *Phrag-*



FIG. 78.—Teliospores of cedar apple showing germination with formation of basidia (promycelia) and basidiospores (sporidia). (After Reed, H. S., and Crabill, C. H., *Techn. Bull.* 9, *Va. Agric. Exper. Stat.*, May, 1915.)

midium from neighboring genera. The teliospores are two- to several-celled by transverse septa. An important species is the Rust of Roses, *Phragmidium subcorticium*, which has a spindle-shaped teliospore with six to eight cells.

Gymnosporangium is a genus of heterœcious rusts the æcia of which occur on ROSACEÆ (except one on HYDRANGEACÆ and one on MYRI-

CACEÆ) while the three-, four or five-celled teliospores are found on CUPRESSINEÆ (*Chamæcypris*, *Cupressus*, *Juniperus*, *Libocedrus*). One autæcious species is *G. bermudianum* which produces both its æcia and telia on junipers (*J. bermudianum*). Kern gives thirty-two species as the number for North America and in vol. 7, North American Flora, part 3, pages 188-190, gives a useful key for the identification of the species.

Gymnosporangium botryapites causes fusiform swellings on the white cedar, *Chamæcypris thyoides*, on which swellings the two- to four-

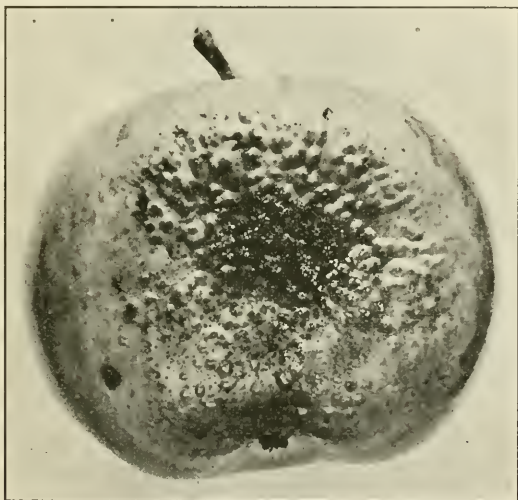

FIG. 79.—Cedar rust on apple, roestelia stage with pustules. (After Jones and Bartholomew, Bull. 257, Agric. Exper. Stat., Univ. Wisc., July, 1915.)

celled teliospores are formed. The æcia occur on two species of shad bush: *Amelanchier canadensis* and *A. intermedia* (Fig. 73).

In *Gymnosporangium nidus-avis*, the telia arise from a perennial mycelium which often dwarfs the young shoots and causes bird's-nest distortions in which usually there is a reversion of the leaves to the juvenile form, sometimes causing gradual enlargements in isolated areas on the larger branches of *Juniperus virginiana* with æcia on several species of *Amelanchier* (Fig. 73).

Juniperus communis is the host of the telial stage of *G. clavariæforme*, which appears on long fusiform swellings of various-sized branches,

scattered, or aggregated and its æcia on seven species of *Amelanchier*, one each of *Aronia* and *Cydonia*.

Gymnosporangium Ellisii (Figs. 74 and 75) in its telial form distorts the younger branches of the white cedar, *Chamæcyparis thyoides*, pro-



FIG. 80.—*Roestelia*, or æcia on apple leaf. (After Giddings and Berg, *Bull.* 257, *Agric. Exper. Stat. Univ. Wisc.*, July, 1915.)

ducing numerous fasciations. The æcia and pycnia of this fungus are on *Myrica*. *Gymnosporangium globosum* is remarkable in forming æcia on eighty-five different species of hawthorn, *Cratægus*, while its

teliospores appear on irregular spheric swellings or excrescence on *Juniperus virginiana*.

The mycelium of *G. juniperi-virginianæ* is annual, or biennial, producing globose swellings known as cedar apples on the leaves of the

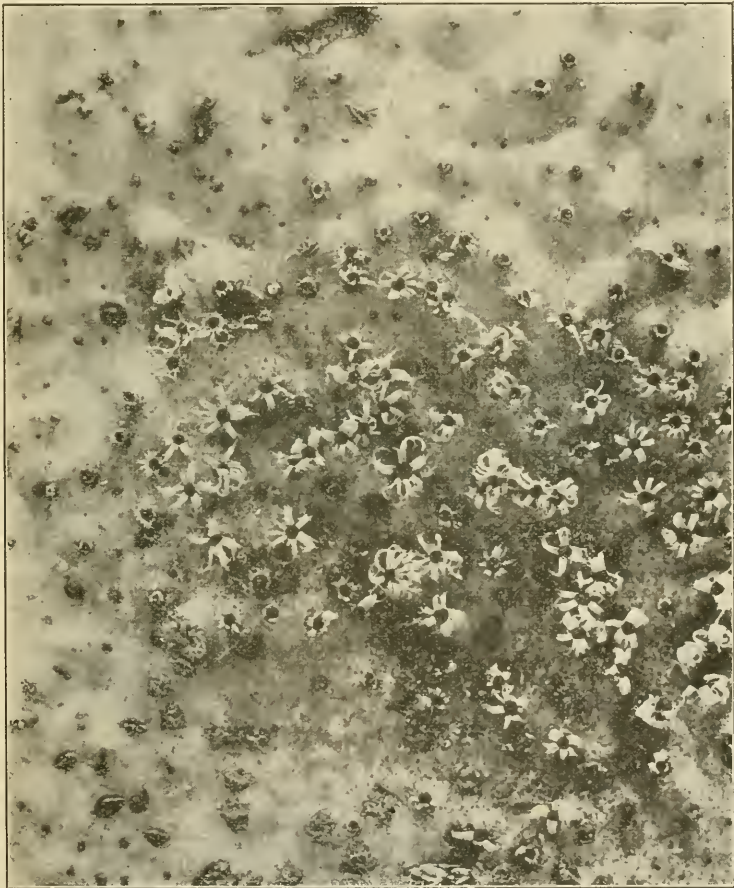

FIG. 81.—Magnified view of apple rust roestelia, or æcia. (After Jones and Bartholomew, Bull. 257, Agric. Exper. Stat. Univ. Wisc., July, 1915.)

red cedar, *Juniperus virginiana*. The cluster cups appear on the leaves of native species of apples (*Malus*).

The most important publication dealing with this disease and giving

a copious bibliography is one by Howard L. Reed and C. W. Crabill issued as Technical Bulletin 9 (May, 1915) by the Virginia Agricultural Experiment Station. The 106 pages of text are devoted to a careful consideration of all aspects of the disease, which is prevalent throughout the geographic range of the red cedar. The æcia are found on the apple and were originally described as *Roestelia pyrata* (Schw.) Thaxter, and frequently the apple stage is known as the *Roestelia* stage (Fig. 81). Infection of the leaves (Fig. 80) and fruit is only possible during their undeveloped condition and not all varieties of apple are susceptible. Some are rust free. Such are Early Harvest, Golden Pippin, Winesap, while the badly affected varieties are Grimes Golden, Smokehouse and York Imperial. The æciospores are dark brown,

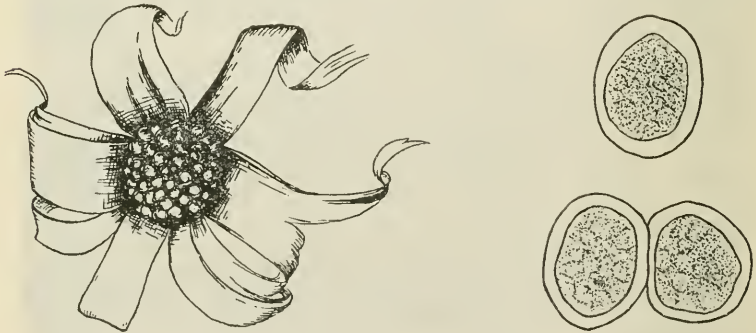

FIG. 82.—Diagram (left) of æcium (roestelia) of apple rust; right, three æciospores from the cup highly magnified. (After Jones, L. R., and Bartholomew, E. T., *Bull.* 257, *Agric. Exp. Stat., Univ. Wisc.*, July, 1915.)

minutely pitted and almost spheric with thick walls and granular contents. The first æcia (Figs. 81 and 82) become mature during the month of July and viable spores are produced in large numbers during this and the following two months (Fig. 83). This is the period of infection of the red cedar, and the mycelium formed from these spores remains dormant in the cedar leaves until the following spring, when the cedar apple (Fig. 76), or gall, is formed out of the parenchyma of the red cedar leaf (Fig. 161). Into the gall a vascular strand extends. The surface of the galls becomes papillate and in May these papillæ enlarge into gelatinous horns, or teliosori (Fig. 77), made up of the agglutinated stalks of numerous teliospores (Fig. 77), which are two-celled and measure 46 to 63 μ by 15 to 20 μ (Fig. 78). These telio-

spores on germination produce a four-celled basidium (Fig. 78), or promycelium, from which are cut off basidiospores, which infect the

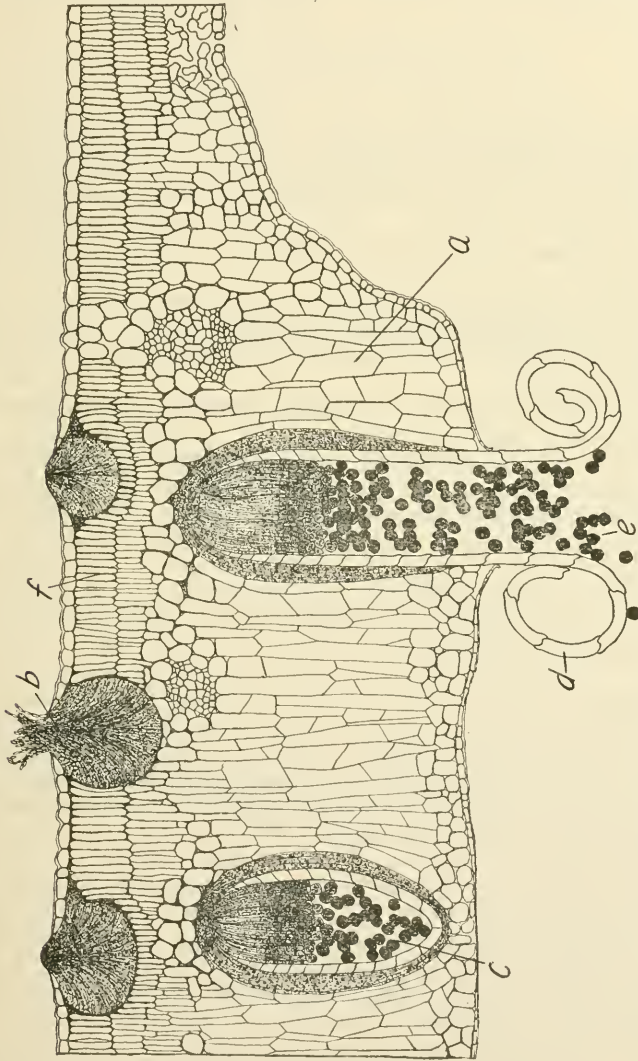

FIG. 83.—Section of a rust lesion on apple leaf thickened by hypertrophy. *b*, Pycnia; *c*, acia (developed and undeveloped) with aeciospores; *d*, peridium. (After Reed, *H. S., and Crabill, C. H., Tech. Bull. 9, Va. Agric. Exper. Stat., May, 1915.*)

partially developed apple leaves, or apple fruits (Fig. 79). The disease apparently does little damage to the red cedar trees, but the

acial stage devastates the apple orchards found in proximity to red cedar trees infected with the rust. Destroying the red cedar trees seems to be the only feasible plan of combating the disease.

BIBLIOGRAPHY OF THE RUSTS

- ARTHUR, J. C.: Cultures of Uredineæ. I (1899), *Botanical Gazette*, 29: 268-276; II (1900 and 1901), *Journal of Mycology*, 8: 51-56; IV (1903), *Journal of Mycology*, 10: 8-21; V (1904), *Journal of Mycology*, 11: 50-67; VI (1905), *Journal of Mycology*, 12: 11-27; VII (1906), *Journal of Mycology*, 13: 189-205; VIII (1907), *Journal of Mycology*, 14: 7-26; IX (1908), *Mycologia*, 1: 225-256; X (1909), *Mycologia*, 2: 213-240; XI (1910), *Mycologia*, 4: 7-33; XII (1911), *Mycologia*, 4: 49-65; XIII (1912, 1913 and 1914), *Mycologia*, 7: 61-89; XIV (1915), *Mycologia*, 8: 125-141.
- ARTHUR, J. C. and HOLWAY, E. W. D.: Description of American Uredineæ. *Bull. Lab. Nat. Hist. of State Univ. of Iowa*, I, 3: 44-57; II, 4: 377-402; III, 5: 171-193; IV, 5: 311-334.
- ARTHUR, J. C.: Clue to Relationship among Heterœcious Plant Rusts. *Botanical Gazette*, 33: 62-66, January, 1902.
- ARTHUR, J. C.: The Uredineæ Occurring upon Phragmites, *Spartina* and *Arundinaria* in America. *Botanical Gazette*, 34: 1-20, July, 1902.
- ARTHUR, J. C.: Problems in the Study of Plant Rusts. *Publ. 22, Botanical Society of America*, Dec. 31, 1902, 1-182.
- ARTHUR, J. C.: Taxonomic Importance of the Spermogonium. *Bull. Torr. Bot. Club*, 31: 125-159, March, 1904.
- ARTHUR, J. C.: Terminology of the Spore Structures in the Uredinales. *Botanical Gazette*, 39: 219-222, March, 1905.
- ARTHUR, J. C.: Amphispores of Grass and Sedge Rusts. *Bull. Torr. Bot. Club*, 32: 35-41, 1905.
- ARTHUR, J. C. and KERN, F. D.: North American Species of *Peridermium*. *Bull. Torr. Bot. Club*, 33: 403-438, 1906.
- ARTHUR, J. C.: Eine auf die Struktur und Entwicklungsgeschichte begründete Klassifikation der Uredineen. *Rusultats Scientifique du Congres international de Botanique Wien*, 1905: 331-348, 1906.
- ARTHUR, J. C.: New Species of Uredineæ. *Bull. Torr. Bot. Club*, I, 23: 661-666, December, 1901; II, 24: 227-231, April, 1902; III, 31: 1-8, January, 1904; IV, 33: 27-34, 1906.
- ARTHUR, JOSEPH C.: Uredinales. *Coleosporiaceæ, Uredinaceæ, Æcidiaceæ (pars)*. *North American Flora*, 7, part 2, 1907; *Æcidiaceæ (continuatio)*, 7, part 3, 1912.
- ARTHUR, J. C.: On the Nomenclature of Fungi Having Many Fruit Forms. *The Plant World*, 8: 71-76; 99-103.
- BLACKMAN, H. V.: On the Fertilization, Alternation of Generations, and General Cytology of the Uredineæ. *Annals of Botany*, xviii: 323-373, 1904.
- BLACKMAN, H. V. and FRASER, MISS H. C.: Further Studies on the Sexuality of the Uredineæ, with 2 plates. *Annals of Botany*, xx: 35-47, 1906.

- CARLETON, MARK A.: Investigations of Rusts. U. S. Dept. Agr., Bureau of Plant Industry Bull. 63, 1904.
- CARLETON, MARK A.: Lessons from the Grain Rust Epidemic of 1904. U. S. Dept. Agr., Farmers' Bull. 219, 1905.
- CHRISTMAN, A. H.: Sexual Reproduction in the Rusts. Botanical Gazette, xxxix: 267-274, 1905.
- CHRISTMAN, A. H.: Observations on the Wintering of Grain Rusts. Trans. Wisc. Acad. Sci., 15: 98-107, 1905.
- COONS, G. H.: Some Investigations on the Cedar Rust Fungus, *Gymnosporangium juniperi-virginianæ*. Ann. Rep. Neb. Exp. Sta., 25: 217-245, pls. 1-5, 1912.
- DE BARY, ANTON: Comparative Morphology of the Fungi Mycetoza and Bacteria, 1887: 274-286.
- DIETEL, P.: Uredinales. Die natürlichen Pflanzenfamilien I, Teil 1, Abteilung **: 24-81, 1900.
- DUGGAR, BENJAMIN M.: Fungous Diseases of Plants, 1909: 384-438.
- ERIKSSON, JAKOB: Fungoid Diseases of Agricultural Plants, 1912: 63-89.
- ERIKSSON, JAKOB: On the Vegetative Life of Some Uredineæ. Annals of Botany, xix: 55.
- FREEMAN, E. M.: A Preliminary List of Minnesota Uredineæ. Minn. Bot. Studies, 2, part 4: 407, 1901.
- GROVE, W. B.: The British Rust Fungi (Uredinales): Their Biology and Classification, 1913, pp. i-x + 1-412.
- HEALD, F. D.: The Life History of the Cedar Rust Fungus *Gymnosporangium juniperi-virginianæ*. Ann. Rep. Neb. Agric. Exp. Sta., 22: 105-113, pls. 1-13, 1909.
- HOFFMANN, A. W. H.: Zur Entwicklungsgeschichte von *Endophyllum sempervivi*. Centralbl. für Bakteriologie, 2, abt. 32: 137-158, 1912.
- HUME, H. HAROLD: Some Peculiarities in *Puccinia Teleutospores*. Botanical Gazette, 1899: 418-423.
- KERN, FRANK D.: A Biologic and Taxonomic Study of the Genus *Gymnosporangium*. Bull. N. Y. Bot. Gard., 7: 391-494, pls. 151-161, 1909-1911.
- KERN, FRANK D.: *Gymnosporangium*. North American Flora, 7, part 3: 188-211.
- KLEBAHN, H.: Die wirtswechselnden Rostpilze, 1904.
- KUNKEL, LOUIS OTTO: Nuclear Behavior in the Promycelia of *Cæoma nitens*. Burrill and *Puccinia Peckiana*. Howe Amer. Jour. Bot., i: 37-47, January, 1914.
- KURSSANOW, L.: Zur Sexualität der Rostpilze. Zeits. Bot., 2: 81-93, 1910.
- MAGNUS, P.: Weitere Mittheilung über die auf Farnkräutern auftretenden Uredineen. Berichten der Deutschen Botanischen Gesellschaft, xix, Heft 10: 578-584, 1901.
- MAGNUS, P.: Ueber eine Function der Paraphysen von Uredolagern, nebst einen Beitrage zur Kenntniss der Gattung *Coleosporium*. Berichten der Deutschen Botanischen Gesellschaft, xx, Heft 6: 334-339, 1902.
- MASSEE, GEORGE: Diseases of Cultivated Plants, 1910: 289-338.
- MASSEE, GEORGE and IVY: Mildews, Rusts and Smuts, 1913: 52-182.
- MCALPINE, D.: The Rusts of Australia. Dept. Agric. Victoria, 1906.

- OLIVE, EDGAR W.: Sexual Cell Fusions and Vegetative Nuclear Divisions in the Rusts. *Annals of Botany*, xxii: 331-360, 1908.
- OLIVE, EDGAR W.: Origin of Heteroecism in the Rusts. *Phytopathology*, i: 139-149, October, 1911.
- OLIVE, EDGAR W.: Intermingling of Perennial Sporophytic and Gametophytic Generations in *Puccinia Podophylli*, *P. obtogens* and *Uromyces Glycyrrhizæ*. *Annales Mycologici*, ii: 297-311, August, 1913.
- PRITCHARD, F. J.: A Preliminary Report on the Yearly Origin and Dissemination of *Puccinia graminis*. *Botanical Gazette*, 52: 169-192, 1911.
- REED, HOWARD S. and CRABILL, G. E.: The Cedar Rust Disease of Apples Caused by *Gymnosporangium juniperi-virginianæ*. *Tech. Bull. 9, Virginia Agric. Exper. Stat.*, 1915.
- SAPPIN-TROUFFY, P.: Recherches histologiques sur la famille des Uredinées. *Le Botaniste*, 5: 59-244, 1896.
- STEWART, ALBAN: An Anatomical Study of *Gymnosporangium* Galls. *Amer. Journ. Bot.*, 2: 402-417 with 1 plate, October, 1915.
- SYDOW, PAUL H.: *Monographia Uredinearum seu-specierum omnium ad hunc usque diem descriptio et adumbratio systematica auctoribus*, 1904.
- TULASNE, L. R.: Second Memoire sur les Uredinées et les Ustilaginée. *Ann. Sci. Nat.*, iv. 2: 77, 1854.
- VON TAVEL, DR. F.: Vergleichende Morphologie der Pilze, 1892: 123-133.
- VON TUBEUF, DR. KARL F.: *Pflanzenkrankheiten*, 1895: 340-434.
- WARD, H. MARSHALL: Illustrations of the Structure and Life History of *Puccinia graminis*. *Annals of Botany*, ii: 217 with 2 plates.
- WARD, H. MARSHALL: On the Relation between Host and Parasite in the Bromes and their Brown Rust, *Puccinia dispersa*. *Annals of Botany*, xvi: 233, 1902.
- VON WETTSTEIN, DR. RICHARD R., *Handbuch der Systematischen Botanik*, 1911: 196-202.

SUBORDER AURICULARINÆ.—FAMILY AURICULARIACEÆ.—The fungi of this family are saprophytes, or wood-inhabiting parasites. The basidia are borne directly on the mycelium, or in variously formed fruit bodies in which the basidia form a layer. The basidia are transversely divided into four cells. *Auricularia* includes about forty species of which the best known is *Auricularia (Hirneola) Auricula Judæ*, the Jew's ear fungus, which develops its fruit body on rotten wood. When wet, it is gelatinous; when dry, it appears as a dry crust. It is a rather gelatinous, flabby-looking, thin expanded cup or saucer-shaped fungus of a brownish color when expanded smooth inside, veined and plaited so as to have the resemblance to a human ear. It grows on a variety of trees: elm, maple, hickory, balsam, spruce and alder and up to 1900, it had been collected in Ohio, Maryland, Indiana, New Jersey, Pennsylvania and West Virginia. Outside it is velvety and grayish-olive.

Auricularia (Hirneola) polytricha is the "Mu-esh" of the Chinese, who gather it as an article of food, in fact oak boughs are cut and allowed to decay to raise the fungus.

FAMILY PILACRACEÆ.—This is a small family of two genera, *Pilacrella* and *Pilacre*, with spheric stalked fruit bodies. The basidia are in capitate clusters and surrounded at first by a peridium-like wall, which breaks at maturity.

SUBORDER TREMELLINEÆ.—FAMILY TREMELLACEÆ.—This family includes twelve genera, of which *Tremella* is the most important. The majority are widely distributed and live saprophytically on wood, where they appear as soft, trembling, gelatinous masses, when moist, becoming rigid and horny when dry. The basidia are longitudinally divided by two septa. The four portions thus formed each bear a terminal basidiospore. Some species of *Tremella* produce conidiospores. *Tremella frondosa* has been used as food, but as such is unsatisfactory. *Tremella foliacea* is of a smoky-brown color, cold, clammy and trembles in the hands. When stewed, it becomes a slimy mess relished only by the Chinese. *Tremella mesenterica* is brain-like in its convolutions, gelatinous in texture and usually the size of a walnut, and of an orange-red color.

CHAPTER XX

FLESHY AND WOODY FUNGI

SUBORDER EUBASIDIUM.—The fungi of this suborder are characterized by the undivided (unseptate) basidia, more or less club-shaped with generally four, rarely six, eight, or two apical sterigmata each of which bears a basidiospore (Fig. 92). These fungi are usually fleshy and the spores are borne openly on wrinkles, ridges, gills, in pores, on spines, or in closed fruits, which open regularly, or irregularly, by splitting. Many of the forms are edible, some are inedible, because of toughness, or woodiness, while others are poisonous.

CYTOLOGY.—Recent studies by Juel (1897), Maire (1900), Ruhland (1901), Harper (1902), Levine (1913) have shown that as a general thing the hyphal cells of the mycelium in the HYMENOMYCETES and GASTEROMYCETES are binucleate, and sometimes, as in *Coprinus radiatus*, uninucleate. The cells of the young carpophore are binucleate, but as the fruit body matures, the majority of the cells in the stipe and pileus are multinucleate, but this condition arises from the amitotic fragmentation of the two nuclei originally present in each cell. The subhymenial cells from which the basidia spring and the paraphyses are always binucleate. All the cells, which are concerned directly with the production of basidiospores, are binucleated throughout their development. The multinucleated condition above noted arises in cells of strictly limited development and are found in the organs of nutrition, support, transportation, etc. Maire found that the pairs of nuclei divide simultaneously, as conjugate nuclei, so that in the successive cell generations which arise in the development of the carpophore the two nuclei in each cell are of widely separated nuclear ancestry, duplicating exactly the condition found in the rusts previously described. The young basidium contains only two nuclei just as in the teliospore of the rust. These two nuclei fuse to form the primary nucleus of the basidium which then divides twice to furnish the nuclei for each of the typically four basidiospores. Levine (1913) who has studied this nuclear division in a number of species of *Boletus*, finds the

long axes of the spindles in both divisions are commonly transverse to the long axis of the basidium. The spores in all of the forms studied by him are uninucleate at first. Just when the mycelial cells become regularly binucleate has not been certainly ascertained except in a few forms. Presumably in *Coprinus radiatus* the uninucleate spores give rise to uninucleate hyphal cells, but Levine finds in his *Boletus* studies that the primary spore nucleus divides at once to form two nuclei. Presumably, the nuclear division in other forms may be delayed, until the primary mycelium has arisen. An alternation of generations comparable to that of the rusts is also present in the HYMENOMYCETES and GASTEROMYCETES. The sporophyte begins at some indefinite point in the mycelium and extends through the development of the carpophore.

A. Hymenomyces.—The undivided basidia of these fungi bear four basidiospores perched on corresponding points, or sterigmata. These basidia spring directly from the mycelium in the primitive forms, but in the more highly evolved types, the basidia are borne on definite layers (hymenial layers) together with the paraphyses and cystidia characteristic of some of the forms. The hymenia are carried by special fruit bodies which differ structurally in the different families. These fruit bodies arise from a profusely branched mycelium, which radiates through the organic substratum, which may consist of leaf mold, rotten wood, dying tree trunks, and manurial waste. The hyphal cells are frequently united by clamp connections which probably give greater strength to them. Such are the saprophytes. Some of the hymenomycetous fungi are parasites and live in the bark and wood of trees, and some few are parasitic on the woody parts, leaves, flowers and developing fruits of certain shrubs. Sometimes, as in *Armillaria mellea*, the hyphæ become united in strands with apical growth. These strands are known as rhizomorphs and serve in part as the resting organs. True sclerotia are also formed. The fruit bodies take various forms. The most highly developed types with stalk, cap and gills are known as toadstools. Some of the simple forms are club-shaped. Others have spines and pores instead of gills over which the hymenia are spread.

FAMILY I. DACRYOMYCETACEÆ.—The fruit body is gelatinous, or cartilaginous, and of different shapes. The whole surface of the fructification is covered with a palisade-like layer of long club-shaped basidia which bear two-forked basidia, each fork with a basidiospore. Conidiospore formation occurs in a number of forms. The important genera

are *Dacryomyces*, *Guepinia*, *Calocera*. *Dacryomyces deliquescens* forms gelatinous, or gristly, lumps on tree stumps. *Guepinia peziza* is saprophytic on oak stumps. *Calocera viscosa* is a branched upright form suggesting the true coral fungi.

FAMILY 2. EXOBASIDIACEÆ.—The mycelium of the fungi of this family lives parasitically in the chlorenchyma of many shrubs. The fruit body is a thin basidial layer, which breaks out of the tissues of the



FIG. 84.—Floral gall produced on flowers of huckleberry, *Gaylussacia resinosa*, by *Exobasidium vaccinii*. Note enlarged and swollen calyx. (Pine Barrens, Shamong, N. J., May 27, 1916.)

host. Each basidium develops four basidiospores; rarely 5 to 6 are formed. Some of the species form galls on the stems, leaves and flowers of ericaceous shrubs, such as species of *Vaccinium*, *Rhododendron*, *Azalea*, *Andromeda*, etc. There are two genera: *Exobasidium* (Fig. 84), with eighteen species; and *Microstroma*, with two species. *Exobasidium vaccinii* (Fig. 84) develops swellings on the leaves of species of *Vaccinium* of a whitish-red color. Its basidia are club-shaped with four sterigma and four basidiospores. The basidiospores are spindle-shaped, 14 to 16 μ long by 2 to 3 μ broad, colorless and smooth. *Exobasidium rhododendri* forms enlargements of the leaves of species of *Rhododendron* of greater or less size; colored white, or flesh-colored. *Exobasidium ledi* occurs on *Ledum* in Finland. *Exobasidium andromedæ* grows on leaves and twigs of species of *Andromeda* in Europe and America. *Exobasidium Azaleæ* is found on species of *Azalea* in North America. *Exobasidium lauri* forms widely spread, yellow

then brownish, horny, or club-like galls on the stems of the laurel in Italy, Portugal and the Canary Islands. *Exobasidium Warmingii* attacks the living leaves of *Saxifraga aizoon* in Greenland, Tyrol and north Italy.

FAMILY 3. HYPOCHNACEÆ.—The hymenium is cobwebby. The basidia have two, four or six sterigmata. Cystidia are sometimes present. *Hypochnuus* occurs on old stumps, on leaves and on mosses. *Tomentella* is another genus.

FAMILY 4. THELEPHORACEÆ.—Fruit bodies of a simple type are found in this family. They form on three trunks, either flat leathery crusts with the hymenium on the smooth upper surfaces, or the flat fructifications are raised above the substratum and have bracket-like outgrowths, which show an overlapping arrangement with the hymenial layer on the under side. The important genera are *Corticium*, *Stereum* and *Thelephora*. In *Corticium*, the fructification is leathery, membranous, fleshy, rarely wholly gelatinous, crust-like, growing resu-

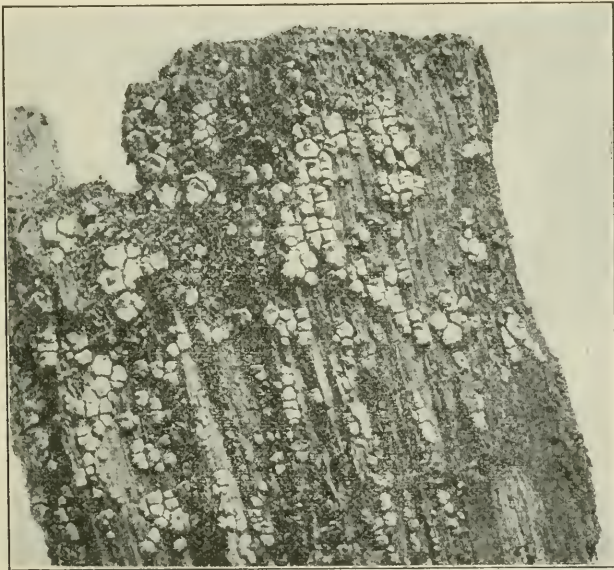

FIG. 85.—A piece of old oak timber rotted by *Stereum frustulosum* showing scattered fruiting bodies. (After von Schrenk, Hermann, Bull. 149, U. S. Bureau of Plant Industry, 1909.)

pinate. The hymenium is smooth, or pimply, and consists of club-shaped basidia with four basidiospores. The species are mostly found on wood. *C. vagum-solani* in its sterile form is known as *Rhizoctonia*, which apparently has been found on sugar beet, bean, carrot, cabbage, potato, egg plant and a number of other hosts. The hymenophore of this species is white with short basidia and elliptic spores. It frequently entirely surrounds the green stems of its host near the ground. The persistent hymenophore of *Stereum* is leathery, or

woody, attached laterally, or centrally, sometimes as a bracket with a smooth hymenium. *Stereum hirsutum* attacks oak trees in which the wood becomes brownish at first and in longitudinal section, white or yellow streaks are found, hence the common name white-piped, or yellow-piped oak. In the cross-section, these streaks are white specks, and another name, that of "fly wood," is apropos. Further decomposition follows. The rot of woods, known as partridge wood, where the timber becomes speckled with white, is due to *Stereum frustulosum*

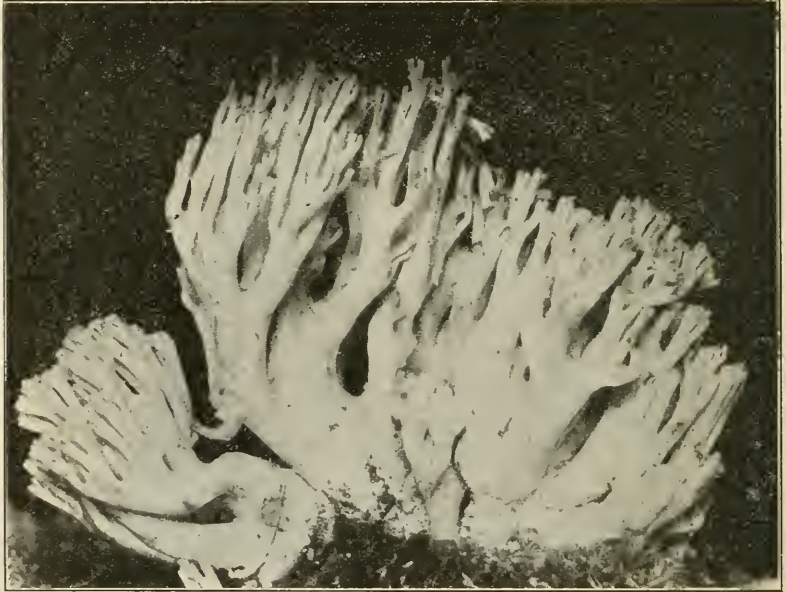

FIG. 86.—Coral-like fruit-bodies of *Clavaria flava*. (Photo by W. H. Walmsley.)

(Fig. 85). The fruiting bodies are hard and crust-like, light brown to grayish in color. The smothering fungus of seedlings is *Thelephora terrestris* and *T. laciniatum*. Soft leathery masses are found at the base young trees of the hard maple. These are numerous, shelf-like fruit of bodies, hemispheric in shape and in mass may completely surround and smother the small tree. *Hymenochæte noxia* attacks tropic plants, such as cocoa, tea, bread fruit, camphor and the like.

FAMILY 5. CLAVARIACEÆ.—The fairy clubs, or coral fungi belong here. The simple, or branched, club-shaped or antler-like hymeno-

phores are fleshy, leathery, cartilaginous, or waxy. The basidia are clavate, interspersed with cystidia and bear one to four sterigmata.

Pistillaria, *Typhula*, *Clavaria* and *Sparassis* are important genera. Many of the species of *Clavaria* are edible (Fig. 86), but some of them are tough and leathery. The color varies, as noted in the enumeration of common American species given below:

Clavaria flava (pale yellow) (Fig. 86).

Clavaria aurea (golden).

Clavaria botrytes (red-tipped).

Clavaria cristata (crested).

Clavaria cinerea (ashen).

Clavaria aurantio-cinnabarino (orange-red).

Sparassis crispa, a common species, has its hymenial ridges projecting and much convolute, suggesting a mammalian brain. It is too tough to be edible.

FAMILY 6. HYDNACEÆ.—The highest forms of this family possess the form of a mushroom, while others are sessile and are resupinate, others without a distinct cap are effused. The hymenium is spread over with persistent bristles, teeth, tubercles or spines. The most important genera are *Phlebia*, *Radulum*, *Grardinia Irpex* and *Hydnum* (Fig. 87). The edible forms are included in the last two genera. The forms of *Hydnum* are extremely variable. The highest forms, such as *Hydnum repandum*, have a cap with a central stipe, while in other forms it is lateral, or absent. In some of the lower forms, the pileus is resupinate. Projecting spines are covered with the hymenial surfaces. A rot of hardwoods in America is due to *Hydnum coralloides*. *H. diversidens* with its yellowish-white sporophore takes the form of an incrustation, or bracket with downward-projecting spines of unequal length. The hymenium renews itself by a new hymenium growing through the old one. It causes a decay of timber known as white rot. Hartig gives a careful description of it, as it occurs in Europe. *H. caput-ursi* is a bracket form growing as excrescences on living oak trees with its pendulous spines at first white, then becoming yellowish and brownish. *H. caput-medusæ* has pendulous tufts of white to gray spines and is found on elms and oak trees. The spiny character of *H. erinaceum* (Fig. 87) suggests a hedgehog, hence its specific name. The last three are fleshy and edible. *Irpex* differs from *Hydnum* in having the spines connected at the base, and in

in their being less awl-shaped and pointed. *I. obliquus* on stumps, *I. carneus* on tulip poplar, *I. fusco-violaceus* on pine trunks are American species.

FAMILY 7. POLYPORACEÆ.—The fruit body of the fungi of this family are of various substance and shape. The hymenium lines the inner surface of pores, or grooves, or is spread over the under surface of the fruit body. The depressions are either united vein-like grooves, tubes, or honeycombed cells, or twisted passages. Concentrically

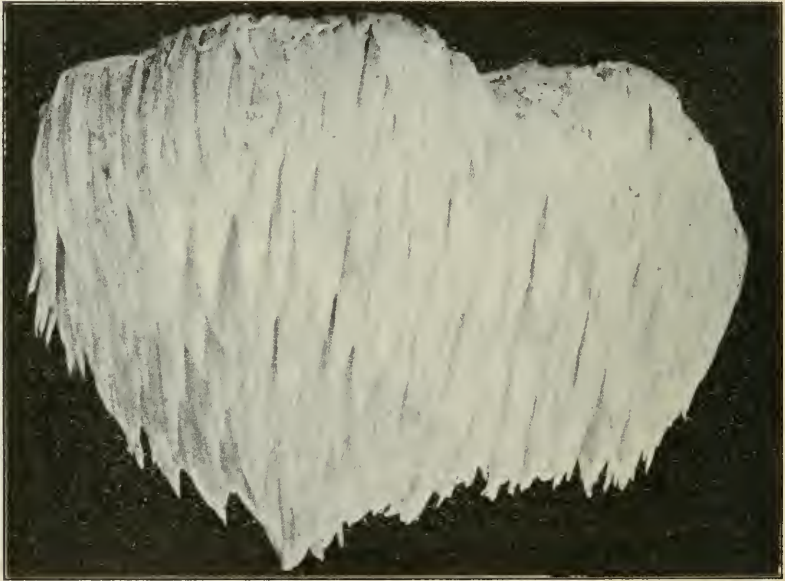

FIG. 87.—Fruit-body of *Hydnum erinaceum*. (After Patterson, *Flora W.*, and Charles, Vera K., *Bull. 175, U. S. Dept. Agric., pl. xxxii, Apr. 29, 1915.*)

formed lamellæ are found rarely. The consistency of the fruit bodies of these fungi is leathery, fleshy and succulent, while in some the fruit bodies are woody and perennial. The family is naturally divided into four subfamilies, as follows: MERULIOIDÆ, POLYPOROIDÆ, FISTULINOIDÆ, BOLETOIDÆ. Each of these subfamilies includes fungi which are important economically.

MERULOIDÆ.—This subfamily includes two genera of interesting fungi: *Merulius* and *Mycodendron*. *Merulius* is represented by sixty-

three species of which *M. lacrymans*, the dry-rot fungus, is most important. This fungus is of world-wide distribution, where it attacks structural wood work and timbers. It has been so long associated as a destructive agent with the structural wood work of men, that it was supposed to be an entirely domesticated form and not known to exist in the wild form. Recent investigations have shown that it occurs on living trees, which when used for structural purposes furnish wood which is liable to destruction later on. The mycelium of *Merulius lacrymans* (Fig. 88), usually gains access to dressed boards, joists, or

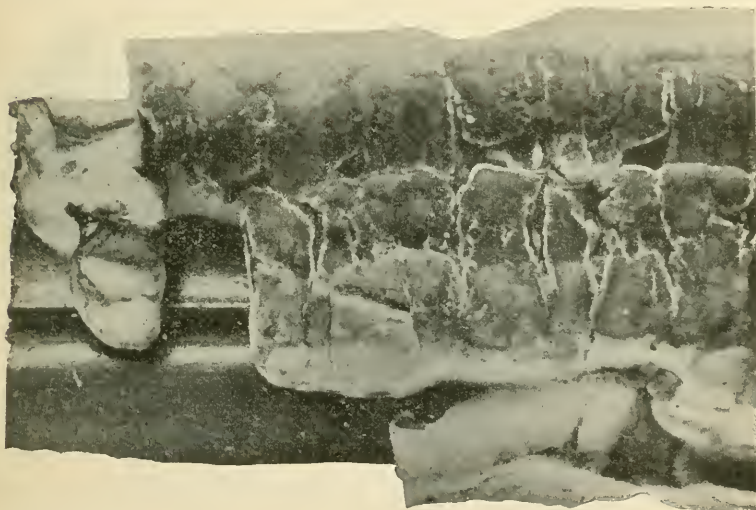

FIG. 88.—Immature fruiting stage of dry-rot fungus (*Merulius lacrymans*) developing on the front of a board. (After Clinton, G. P., *Rep. Conn. Agric. Exper. Stat.*, pl. xxviii, 1906.)

rafters by the germination of one of its spores at a point where the beam may be in contact with a damp wall. Its mycelium penetrates the wood and usually grows lengthwise at first, the water for its extension being supplied by larger more tube-like hyphæ known as the conductive hyphæ, which carry water to the extreme end of the mycelial growth. The presence of the fungus results in a decay of the wood, which is reduced to a brown punky mass, that crumbles between the fingers. When the mycelium comes to the surface of the wood, it forms a white felt-like covering studded with water drops, hence the specific name *lacrymans* referring

to the tear-like drops of water pressed out of the living hyphal cells. The mature sporophore is an amber-brown color covered with anastomosing wrinkles (Fig. 89) over the surface of which the basidia bearing basidiospores are borne. Two basidiospores are borne on pointed sterigma by each basidium. As the fungi by means of its conducting hyphæ is independent of local water supplies, it can grow in wood, even if protected by an external coat of paint, or varnish, and the builder is chagrined to find such wood work crumble away beneath the coats of paint. *Mycodendron* is a curious fungus with a fruit body which suggests a muffin stand, or a pagoda with superimposed, rounded,

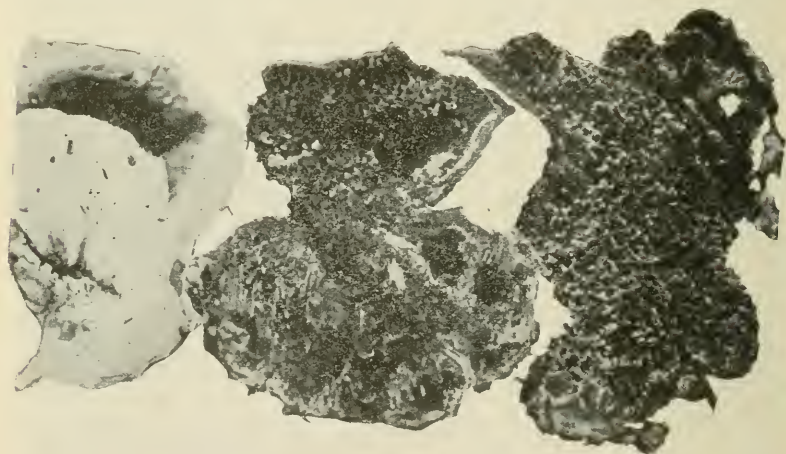

FIG. 89.—Fruiting stage of dry-rot fungus (*Merulius lacrymans*). (After Clinton, G. P., Rep. Conn. Agric. Exper. Stat., pl. xxviii, 1906.)

spore-bearing shelves through which the central stalk runs from one-half to the next above. *Mycodendron paradoxum* has been collected on wood in Madagascar.

POLYPOROIDEÆ.—This subfamily includes tough or woody fungi found generally on wood as bracket-like fruit bodies of different forms and sizes. The spore-bearing surface, a hymenium, consists of furrows, or tubes. In the perennial-fruited forms, the tubes are often found in layers. Mycologists have made a natural division of the different forms of fruit bodies into those which are resupinate, the annual peroid species, the perennial peroid forms and those species which are like the agarics. The various forms are of interest to the scientific my-

coligist, but to the mycophagist they are of use as food. Only one poisonous form is known, and that is the medicinal one, *Fomes laricis*, but it is so bitter and unattractive, as not to be tempting. Some of them are destructive to living trees, to timber used for mine props, and structural purposes, and to wood exposed to the weather, or in contact with the soil.

The ease with which the polypores are collected and preserved makes them especially suitable for systematic study in the classroom. Besides, they retain their characters when dried, so that the keys used for their identification can be readily followed. Fortunately also we have several manuals which cover the different sections of our country. They are reasonable enough in price to be furnished for use in the classroom. It is suggested that boxes of the different kinds used for this purpose be filled with enough specimens to furnish each member of the class in mycology with one specimen of each kind. There should be a sufficient number of manuals of the region, where the botanic institute is situated, to supply every two members of the class with one, so that the students may use them in groups of two. The advertisement of the books is here reproduced for the use of teachers of mycology.

MANUALS OF POLYPORES AND BOLETES

By WILLIAM A. MURRILL, A. M., PH. D., Assistant Director of the New York Botanical Garden, Editor of "Mycologia," and Associate Editor of "North American Flora."

Northern Polypores, *November*, 1914. Including species found in Canada and the United States south to Virginia and west to the Rockies.

Southern Polypores, *January*, 1915. Including species found in the United States from North Carolina to Florida and west to Texas.

Western Polypores, *February*, 1915. Including species found in the states on the Pacific coast from California to Alaska.

Tropical Polypores, *March*, 1915. Including species found in Mexico, Central America, southern Florida, the West Indies, and other islands between North America and South America.

American Boletes, *November*, 1914. Including all the species found in temperate and tropical North America, both on the mainland and on the islands, south to South America.

As satisfactory keys of the different genera and species of the polypores and boletes are given in these manuals, and as it is presupposed that their use will be adopted, keys of the more common genera and

species are not given space in this book. It should be stated, however, that Murrill classifies his genera and species differently from the authors that have preceded him where many of the new genera were classified under the genera *Polyporus* and *Boletus* (Fig. 90). The arrangement of Murrill seems to be a more satisfactory presentation of these groups than those systems which have gone before and is founded on more natural characters. The nomenclature which this author adopts in the several recommended manuals was foreshadowed in vol. 9, part 1

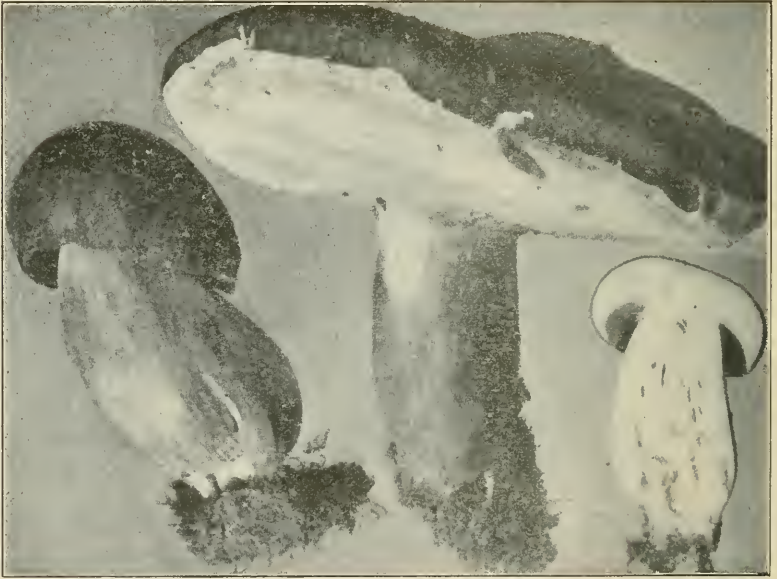

FIG. 90.—*Boletus felleus* in three stages of development. (After Patterson, *Flora W.*, and Charles, *Vera K.*, *Bull.* 175, *U. S. Dept. Agric.*, pl. xxxi, Apr. 29, 1915.)

(1907), and part 2 (1908) of the "North American Flora," where keys will also be found with the synonymy which has been omitted from the manuals. To connect satisfactorily, the old and the new generic and specific names, the treatment of the POLYPORACEÆ in the "North American Flora" should be consulted.

Trametes robiniofila is found on decayed spots of living trunks of *Robinia pseudacacia* from Pennsylvania to Virginia and Missouri, and it doubtless causes decay of the wood. *T. suaveoleus* is found on willow trees, where it causes serious decay. It has an agreeable odor. *T.*

subnivos is occasional on dead deciduous wood in Florida, Louisiana and Mississippi. At New Orleans, it was collected on living water oak and at Eustis, Fla. on cypress. The species become more abundant in tropic America where nine have been found. *T. jalapensis* was collected on a railway tie near Jalapa, Mexico. The species of *Coriolus* are annual. It includes *Coriolus (Polyporus) versicolor* found on all

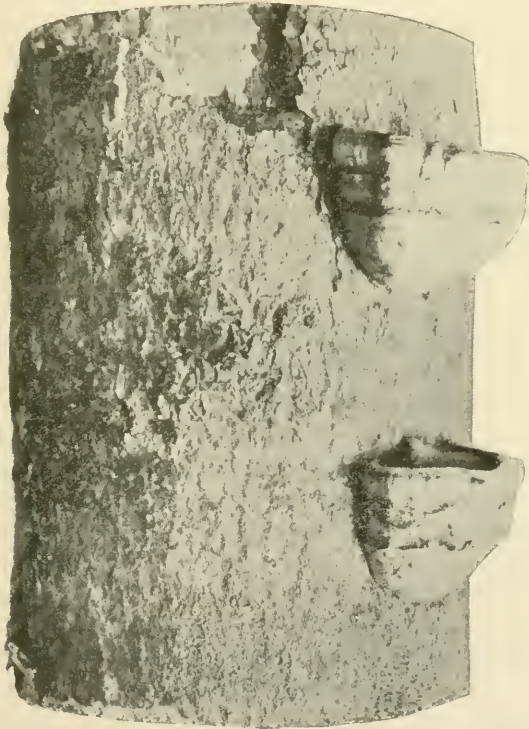

FIG. 91.—Piece of dead wood with sporophores of *Fomes fomentarius*. (After von Schrenk, Hermann, Bull. 149, U. S. Bureau of Plant Industry, pl. viii, 1909.)

kinds of dead wood. It causes root rot in many trees and becomes a wood parasite of *Catalpa*. It has a leathery, thin and rigid hymenophore depressed at the point of attachment. The surface is velvety and variegated with two-colored zones. The pores are minute rounded with ragged edges, white then yellowish. *Polyporus arcularius* is common in the eastern United States on dead branches and trunks of vari-

ous trees. *P. caudicimis* is one of the most dangerous enemies of shade trees in Europe but, fortunately, it is rare in America.

The genus *Fomes* includes the fungi with corky, woody, or rarely punky hymenophore, which is sessile, hoof-shaped, or applanate (Fig. 91). The substance of the fruit body is white, flesh-colored, or wood-colored. The tubes are cylindrical and usually thick walled. *Fomes annosus* will live on trunk and roots of coniferous trees, *Fomes* (*Pyropolyporus*) *igniarius* causes serious heart rots of trees. It was formerly the source of tinder. *Dædalea quercina* (Fig. 202) is a corky, or woody, species common on oak and chestnut trees. It is at first porous, but these pores coalesce to form slits with blunt partitions. It is very common about Philadelphia. *Lenzites betulinus* is common on dead deciduous wood.

FISTULINOIDEÆ.—The most important genus of this subfamily is *Fistulina*, which comprises about six species. *F. hepatica* is the commonest form, and is known by its English name beefsteak fungus or, in French, *langue de boeuf*. The tongue-shaped fruit body projects from the tree and is six to ten inches across with a liver-colored and sticky gelatinous surface. The mouths of the tubes are closely packed. It is edible, when fully mature, its flavor resembling beefsteak.

BOLETOIDEÆ.—The members of this subfamily are tube-bearing fungi differing from the POLYPOROIDEÆ in their fleshy substance and terrestrial habit. They have a cap and stipe like a mushroom, but porous tubes instead of gills on the under cap surface. They occur usually in forested tracts during summer and autumn. The annual hymenophore is usually centrally stipitate. Many of the best edible fungi (few of them poisonous) are found in this subfamily, which includes, according to Murrill in North America, Central America and the West Indies, as far as Trinidad, eleven genera.

Boletus (*Tylopilus*) *felleus* (Fig. 90) is common in woodlands. It is discarded as an edible form, because of its bitter taste. Forty-eight species of *Ceriumyces* are listed by Murrill for America. The genus *Boletus* proper is made to contain only five species, while *Strobilomyces strobilaceus* still retains its old name. This rough shaggy form is regarded as edible.

CHAPTER XXI

MUSHROOMS AND TOADSTOOLS

FAMILY 8. AGARICACEÆ.—The mycelium of the fungi of this family lives in the substratum, which may be the soil, leaf mould, rotten wood, old stumps, dead tree trunks, or living trees, as far as the natural environment is concerned, and in manures, in the decay of agricultural plants in the fields, offal, spent tan bark and rubbish heaps, as far as man has influenced the environment. The hyphæ may be delicate and cobwebby, thread-like, cord-like, or in strands (rhizomorphs). They are always septate, sometimes with clamp connections and their color may vary from white to yellow, or brown (*Armillaria mellea*). The fruit bodies are mostly fleshy, rarely of membranous, or leathery, consistency. Usually of an umbelloid form, they may have a sessile cap, or pileus, or the stalk, if present, may be attached laterally, although it is placed centrally as a general rule. The hymenophore consists of radiately arranged veins, folds, or gills (lamellæ), which are generally free from each other, seldom anastomosing, or dichotomously branched. As the popular name toadstool is suggestive of the commonest form of these fleshy fungi, a few words of explanation with regard to the general structure will be apropos. Attached to the spreading mycelium we find arising vertically the stalk, or stipe. The height of this varies in the different genera and species. Sometimes it is enlarged at the base, at other times, the stalk is perfectly cylindrical. The surface of the stipe may be smooth, rough, reticulate, or stringy, and its center may be solid, stuffed, or hollow, as the case may be. An annulus, such as is present in the common mushroom, may in other forms be absent, or well developed. Placed on the stem, or stipe, above we find the cap, or pileus, which is expanded horizontally. It has a domed, convex upper surface sometimes with a projecting boss, or umbo; in other forms it is depressed (crateriform, umbilicate, etc.). The gills, or lamellæ, are attached to the lower surface of the pileus. They may run from the stipe to the margin, or they may run only part way, so that frequently there are secondary gills alternating with

the primary ones. The gills may be free from the stipe, adnexed, or even decurrent.

A section of a mature gill shows the following disposition of the hyphal layers. The central part of the gill consists of parallel, downward directed hyphæ, that form the trama. Running out obliquely from the trama are shorter cells which constitute the subhymenium. The basidia, together with their accompanying paraphyses and cystidia, form a palisade-like layer (the hymenium) whose cells stand at right angles to the tramal hyphæ.

The basidia are furnished with sterigma, which bear the basidiospores (Fig. 92). In such forms as the common mushroom, the gill chamber is at first closed by a veil known as the partial veil, or *velum partiale*, which ruptures when the pileus expands. The part of this membrane attached to the stipe becomes the annulus, while the other part remains attached in a shreddy condition to the edge of the cap. The species of *Amanita* have a universal veil which covers the whole fruit body, and as this enlarges the *velum universale* is torn transversely, the lower part forming the death cup, or volva, and the upper part sometimes remaining in the form of flaky pieces, which

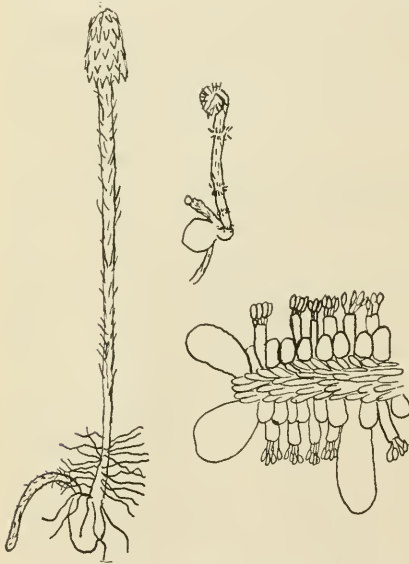

FIG. 92.—*Coprinus stercorearius* with young and mature sporophores with gills, basidia and basidiospores and cystidia. (After Brefeld.)

are distributed irregularly over the upper surface of the cap (Fig. 93).

A frill-like annulus is also found at the top of the stipe in the *Amanitas*. It does not represent a portion of the partial veil in the *Amanitas*, but is a membrane which is formed from a thick, loosely felted layer, which separates as elongation proceeds from the surface of the stipe, retaining its connection with the stipe where the stalk joins the cap. It is pulled away from the stipe by retaining its connection with the edges of the pendant gills as a continuous membrane, which covers

the gills. As the pileus expands the membrane becomes detached first at the margin of the cap, and it falls down around the stipe, as a frill, plaited in delicate folds, corresponding to the former lines of contact with the lamellæ and is now known as the *annulus superus*, frill, or armilla. Special milk tubes are found in such forms as species of *Lactarius* for when these toadstools are wounded a milky fluid oozes out in drops. Each basidium usually bears four basidiospores, sometimes there are two. The color of these spores is distinctive, and is used in



FIG. 93.—Deadly amanita (*Amanita muscaria*) showing volva at base of stem and frill, like stem ring. (After Chestnut, V. K., *Bull.* 175, *U. S. Dept. Agric.*, pl. i, *Apr.* 29, 1915.)

the classification of the genera of the family. We distinguish the white-spored, rosy-spored, ochre-spored (yellow or brown), brown-spored, black-spored agarics.

Buller in his "Researches on Fungi" (1909) has carried on detailed studies with numerous species of gill fungi and has studied the physiology and mechanics of spore discharge and fall. The disposal of the hymenium beneath a pileus on gills, the rigidity of the fruit body, the growth movements of the fruit body, all facilitate the distribution of the discharged basidiospores. The spores liberated from a pileus in per-

fectly still air placed above a horizontal sheet of paper fall vertically downward and produce a spore print of radiating lines of spores corresponding to the interlamellar spaces. The number of spores liberated in *Agaricus (Psalliota) campestris* (Fig. 94), 8 cm. in diameter, was 1,800,000,000 spores. *Coprinus comatus* formed 5,000,000,000 spores. Such discharge under normal conditions is continuous, but by exposing the gills to ether, or chloroform vapor, it ceases. Buller determined that the four spores on each basidium are discharged successively leaving the sterigmata a few seconds or minutes of one another, so that an entire mushroom will discharge in total about a million spores a minute

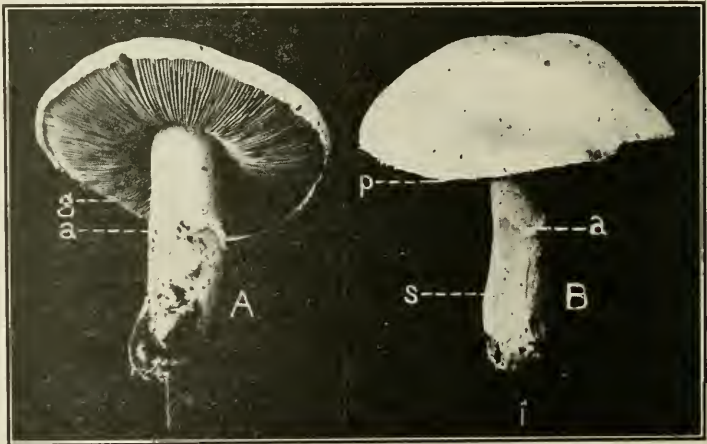

FIG. 94.—Meadow mushroom, *Agaricus campestris*. A, View of under surface; a, annulus; g, gills; B, side view; s, stipe; p, pileus or cap. (From Gager, after W. A. Murrill.)

for two or more days. The rate of fall of hymenomycetous spores ranges from 0.3 to 6.0 mm. per second; those of the mushroom shortly after they have left the gills fall at a speed approximately 1 mm. per second. The path described by a spore in its fall has been called a sporabola. Buller has divided the fruit bodies of the AGARICACEÆ into two types, the *Coprinus comatus* type and the *Agaricus campestris* type. The deliquescence in the first type is an autodigestion, which renders important mechanic assistance in the process of spore discharge, where the process proceeds in succession from below upward, so that autodigestion removes those parts of the gills from which the spores have been

discharged, and permits the spores to fall more easily past the neighboring gill surfaces.

Development of the Fruit Bodies.—Atkinson¹ has studied the development of the mushroom (*Agaricus (Psalliota) campestris*) (Fig. 94).—The youngest stage is the homogeneous primordium of the carpophore composed of slender, uniform, dense hyphæ, intricately interwoven, and surrounded by a thin layer of hyphæ of a looser arrangement. This layer is the universal veil which grows until the form of the fruit appears when it is torn into white floccose patches on the pileus. In the very young primordium then there is no evidence of a differentiation into stem and pileus and at this stage stained longitudinal sections show two small deeply stained internal areas near the upper end of the young fruit body and some distance from the surface. The hyphæ here are richer in protoplasm and form an annular area within the fruit body. This area now increases in extent and many hyphæ grow from its upper portion downward to form the primordial layer of the hymenium. These downward growing hyphæ are slender and terete and taper pointed, which enables them to push between the surrounding hyphæ. Soon after these hymenial hyphæ grow downward there is a cessation of growth. Just below this area which results in the rupture and separation of the hyphæ at this point in a corresponding internal annular area, forming the well-known "gill cavity" which at first is very minute.

With the formation of this annular primordium of the hymenium the primordia of the stem, veil and pileus are differentiated. The period of elongation of the parts after they have been organized follows in succession. The marginal veil completes its period of elongation first, then the stem, followed by the pileus, and finally, the hymenium where in examples studied Atkinson secured two-spored basidia.

A somewhat similar development takes place in *Agaricus Rodmani*, a form which grows in grassy ground and paved gutters in cities from May to July. The sequence of events in the growth of the fruit body is given by Atkinson.² He finds that the primordium of the fruit body is oval in form and homogeneous in structure, consisting of intricately woven hyphæ. The hymenophore primordium arises as an internal

¹ ATKINSON, GEORGE F.: The Development of *Agaricus campestris*. Botanical Gazette, 42: 215-221, September, 1906.

² ATKINSON, GEORGE F.: Morphology and Development of *Agaricus Rodmani*. Proceedings American Philosophical Society, 1915: 309-343, with 7 plates.

annular zone of new growth toward the upper part of the young fruit body (basidiocarp) and with its origin the four primary parts of the basidiocarp, pileus, stem, marginal veil and hymenophore are differentiated. By the continued growth and multiplication of hyphæ rich in protoplasm, which are parallel and directed downward, the hymenophore primordium becomes more compact to form a level palisade zone, and as the ground tissue beneath lags behind in growth, the more rapid growth of hymenophore causes a rupture of the ground tissue beneath and an annular gill cavity arises. The lamellæ project into this cavity, as downward-growing radial salients of the level palisade zone, beginning next to the stem and proceeding in a centrifugal direction.

Cultivation of the Mushroom.—The commercial growing of mushrooms has been placed upon a sure financial basis within recent years and around Philadelphia, notably in Chester County, there are large concerns which make the culture of mushrooms a specialty. Mushroom cultivation is an important business in Europe, especially in France where certain of the grades are canned and bottled for export trade. Mushrooms are grown in America in long mushroom houses, or sheds especially constructed and heated for the purposes of the trade. Cellars are also devoted to the industry. Sometimes they are grown under the benches of greenhouses devoted to the raising of other plants. The beds are so constructed of boards that they rise in tiers of four, or five with a central aisle, or in the larger houses there are tiers of beds along the walls and in the center of the house with two aisles running lengthwise with a cross aisle at the far end or in the middle of the house.

Stable manure is used as the compost for commercial mushroom culture. Bedding straw should also be included with the manure in the compost. The manure should be the best that can be obtained. It should be thrown into piles about four feet high and forked over occasionally to assist the fermentation process, which is assisted further by wetting the fermenting mass occasionally until the fermentation is completed, which is usually at the end of three weeks. During this time all objectionable odor should be lost and the temperature should decline to 120° or 130° F. Out of this compost the beds are constructed by compressing the mass with blows of a spade, or by a compressing board. Growers cover the manure bed with a thin layer of garden soil one to one and a half inches deep. This operation is known as casing, and is performed after the spawning operation has been completed.

Spawning consists in breaking up the bricks of spawn into about ten pieces and one piece of spawn, which consists of hard manure penetrated by the mushroom hyphæ, is used for each square foot of bed space. The piece of spawn should be covered by about one inch of compost which should have a temperature of 70° to 75° F. The casing soil should be well moistened by repeated sprinkling, and not by a sudden drenching. Under favorable conditions, such a bed should come into bearing in from six to eight weeks after spawning, and during the period of production constant care in the matter of watering is necessary to keep the beds up to the maximum conditions of production. The making of spawn is an art in itself and the process is fully described in a recent book by B. M. Duggar on "Mushroom Growing," published in 1915 by Orange Judd Company, New York. Duggar also ascertained in his studies of the mushroom that fragments of growing mushrooms obtained under aseptic conditions could be made the starting point for pure cultures of spawn. This is based on the fact, that a small piece of the inner stipe tissue of a fresh mushroom will, when placed on any suitable sterile nutrient medium, promptly develop a mycelium. The method of making pure cultures is described in Bulletin 85, Bureau of Plant Industry, United States Department of Agriculture and in Duggar's "Mushroom Growing" and need not be repeated here.

CHEMISTRY AND TOXICOLOGY OF MUSHROOMS.—With the increase in the cost of living and in our population, which is beginning to feel the shortage of food supplies, earnest attention has been directed to foods, such as the edible wild fungi, which are frequently abundant during the summer months. One phase of this study has been the investigation of the food value of mushrooms and toadstools. Chemical analyses have been made to ascertain what they contain. It has been found, that such a fungus as *Polyporus sulphureus*, has over 70 per cent. of water, while species of *Agaricus* and *Coprinus* have fully 90 per cent. of water. As to nitrogen, although the proportion of this element in the dry matter of different fleshy species varies from 2 to 6 per cent., it has been found that much of the nitrogen is present in the form of non-protein substance of a very low food value and some of it enters into the composition of a substance closely related to cellulose. Thus, notwithstanding the fact that *Coprinus comatus* contains 5.79 per cent. of nitrogen, we find only 0.82 per cent. as available (digestible) proteins,

so that the food value of this form is less than had formerly been supposed. The fatty substances soluble in ether are present to the amount of 4 to 8 per cent. The carbohydrates (cellulose, glycogen, trehalose, mannite, glucose, etc.) make up the largest part of the dry matter of the mushroom. Starch usually present in higher plants is absent in these fungi. The ash varies greatly, varying from 1.08 to 15 per cent.



FIG. 95.—Deadly amanita, *Amanita phalloides*, showing death cup, or volva, at base of stipe. (From Gager, after E. M. Kittredge.)

with potassium as the most abundant element. Sulphuric acid occurs in the ash of all fungi, with 1.58 per cent. in the ash of *Helvella esculenta*.

The poisonous substances are alkaloids, such as choline, found in *Amanita muscaria*, *Helvella esculenta* and other fungi, neurin (deadly), muscarin, the most dangerous alkaloid found in toadstools, as in *Amanita muscaria* (Fig. 93). Phallin, a deadly poison, found in *Amanita phalloides*, is albuminous in nature. Helvellic acid, a deadly poisonous substance, occurs in *Helvella esculenta*, especially in old decaying specimens. The symptoms of poisoning with muscarin are long delayed. They may be summed up in the words of Mr. V. K. Chestnut (Circular No. 13 Division of Botany, United States Department of Agriculture): "Vomiting and diarrhoea almost

always occur, with a pronounced flow of saliva, suppression of the urine, and various cerebral phenomena beginning with giddiness, loss of confidence in one's ability to make ordinary movements, and derangements of vision. This is succeeded by stupor, cold sweats, and a very marked weakening of the heart's action. In case of rapid recovery, the stupor is short and usually marked with mild delirium.

In fatal cases, the stupor continues from one to two or three days, and death at last ensues from the gradual weakening and final stoppage of the heart's action." Fortunately an antidote has been found in the hypodermic injection of atropine in doses of one-hundredth to one-sixtieth of a grain. Strong emetics should also be used to rid the stomach of the offending food. The action of phallin from *Amanita phalloides* (Fig. 95) for which no antidote is known except the administration of emetics and the transfusion of blood into the patient, which may be of little avail is best summed up in Chestnut's account: "The fundamental injury is not due, as in the case of muscarin, to a paralysis of the nerves controlling the action of the heart, but to a direct effect on the blood corpuscles. These are quickly dissolved by phallin, the blood serum escaping from the blood-vessels into the alimentary canal, and the whole system being drained rapidly of its vitality. No bad taste warns the victim, nor do the preliminary symptoms begin until nine to fourteen hours after the poisonous mushrooms are eaten. There is then considerable abdominal pain and there may be cramps in the legs and other nervous phenomena, such as convulsions and even lock-jaw, or other kinds of tetanic spasms. The pulse is weak, the abdominal pain is followed rapidly by nausea, vomiting, and extreme diarrhoea, the intestinal discharges assuming the rice-water condition characteristic of cholera. The latter symptoms are maintained persistently, generally without loss of consciousness, until death ensues, which happens in from two to four days."

B. GASTEROMYCETES.—The fungi known as the Gasteromycetes ($\gamma\alpha\sigma\tau\eta\rho$ = belly, sac + $\mu\acute{\upsilon}\kappa\eta\varsigma$ = fungus) have the basidial layers, or hymenium, enclosed within a peridium, as in the common puff-ball. The shell or hull enclosing the masses of spores is called the peridium, which is a simple uniform layer in some genera (*Scleroderma*), or it consists of two distinct layers, the exoperidium and the endoperidium. The earth-star (*Geaster*) has a thick outer peridium, which splits in a stellate manner, later becoming reflexed. The exoperidium in such genera as *Bovista* and *Lycoperdon* is a loose pliable coat often having spines and warts. Many of the genera are stalkless, but other genera, such as *Tylostoma*, are stalked. Inside of an unripe puff-ball, we find a white fleshy mass of soft cellular matter, the gleba. As the fruit bodies grow they become chambered. The chambers, in countless numbers, are narrow, irregularly curved and branched, separated from

each other by curved plates of tissue which anastomose in every direction. The walls of the chambers consist of layers of branched hyphæ bearing the basidia which line the interior walls of the cavities and constitute the hymenium. Each basidium usually bears four spores. The way the spores are borne on the basidia is characteristic. They are almost sessile in *Geaster*, in *Bovista* they are found on long sterigmata. *Mitremyces* may have as many as a dozen basidiospores, which are sessile and lateral.

When the puff-ball reaches full size and ripens, the tissues become moist, deliquesce and change in color. The tissues are absorbed and disappear and the whole mass dries up, leaving the interior surrounded by the peridium filled with a dry dusty mass usually consisting of slender threads (the capillitium) and countless multitudes of ripe spores. The threads of the capillitium are absent in many genera, but when present they are characteristic and used as important points in the classification. There are two distinct kinds of capillitial threads. In one kind, the threads are long hair-like strands, simple, more or less branched and interwoven, proceeding from the inner walls of the peridium, or from the centrally placed columella. The second type, characteristic of *Bovista*, *Bovistella* and *Mycenastrum*, has relatively short and branched threads entirely separate and distinct from each other and are not connected with the peridium nor the columella. The bird-nest fungi are characterized by the thickening of the walls of the glebal chambers to form separate little seed-like bodies enclosing the spores. These are known as peridioles. The ripe spores in some are smooth, some are spinulose, while in shape they are globose, oblong or oval.

The most primitive forms of these fungi are probably the subterranean forms included in the family HYMENOGASTRACEÆ. In one classification of the GASTEROMYCETES, the division of the families is based on whether the sporophore is borne above or below the ground. The family HYMENOGASTRACEÆ with subterranean fruit bodies belongs to one division, all of the other families to the other division.

FAMILY I. HYMENOGASTRACEÆ.—The subterranean fruit bodies of these fungi suggest those of the families TERFEZIACEÆ and TUBERACEÆ among the ASCOMYCETALES, but the spores of the two latter families are borne in asci, and are known as ascospores, while those of the former family are borne on basidia and are known as basidiospores.

Most of the forms are irregularly globose and grow under trees, sometimes their association with certain kinds of trees suggesting a parasitic attachment. They are often found in sandy places, where they are exposed frequently by rain erosion. The mycelium of these fungi is filamentous, or cord-like. The gleba is richly chambered and the walls of the glebal chambers are lined with the hymenium. Cystidia are often found between the basidia. The fruit bodies are variously shaped. In *Lycogalopsis*, they are hemispheric; in *Phyllogaster*, pear-shaped; in *Cauloglossum*, club-shaped; some are stalked and suggest the shape of the AGARICACEÆ.

Very few of the forms are known commonly, and of the dozen Californian species, many are known imperfectly by a single collection. *Gautieria* and *Sclerogaster* have each a single species in California; *Hymenogaster* and *Octaviana* are represented by two Californian species, while *Hysterangium* and *Melanogaster* have three species in California. Two species of *Rhizopogon* and one of *Melanogaster* are found in South Carolina. The climate probably has something to do with this distribution.

FAMILY 2. TYLOSTOMACEÆ. At first, the fruit body is subterranean, later as in *Tylostoma mammosa*, a form found in heathland, it is raised on a stalk not prolonged as an axis. The peridium is double, the outer one falling off at maturity, the inner one is thin. The unchambered gleba possesses well-developed capillitial threads, which are connected with the inner wall of the endoperidium. The basidia in *Tylostoma* are unicellular, club-shaped and bear four laterally placed spores, one above the other on well-developed sterigmata, thus differing from the other two basidiomycetous fungi.

FAMILY 3. LYCOPERDACEÆ.—The fruit body from the beginning is epigæic. Its gleba is chambered richly and the inner walls of each chamber are lined with a hymenium. The peridium is differentiated into an outer and an inner peridium. The gleba, when ripe, breaks down into powdery spores and richly branched capillitial threads. This family contains some of our most delicious and important food species, if they are taken before fully mature. The genus *Lycoperdon*, in which the true peridium opens by an apical mouth, includes over one hundred species, which in America can be divided into the purple-spored series, and the olive-spored series. *Lycoperdon atropurpureum* is found in sandy pastures, woods and bushy places commonly in the months from August

to October. It is an extremely variable species, *Lycoperdon gemmatum*, an olive-spored species, has a turbinate shape, its outer peridium being marked with long, thick, erect spines, or warts of irregular shape with intervening smaller ones, whitish, or gray in color. The larger spines fall away first imparting to the surface of the peridium a reticulate appearance. It often grows cespitosely on the ground, or rotten tree trunks in woodlands. *Lycoperdon pyriforme* is another common species found in woods and clearings on the ground, or on decaying wood. It is edible, tender and of second-class flavor when young.

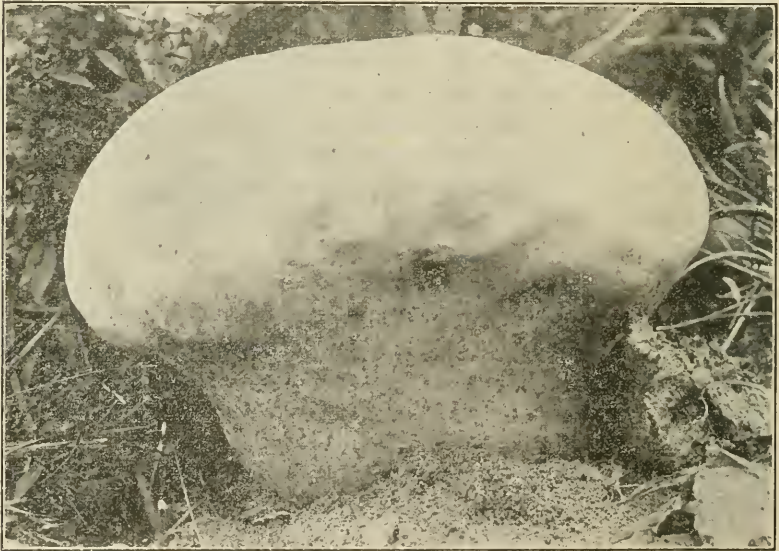

FIG. 96.—Fruit-body of *Calvatia cyathiformis*. (Photo. by W. H. Walmsley.)

The largest puff-balls are included in the genus *Calvatia* (Fig. 96), which differs from *Lycoperdon* in the absence of an apical mouth and a regular dehiscence. The fruit bodies are globose, or top-shaped, arising on the surface of the ground from subterranean, cord-like hyphæ. *Calvatia cyathiformis* (Fig. 96) which is edible, if eaten when white inside, grows in open grassy fields and lawns and reaches a diameter of three to six inches. *Calvatia gigantea*, the giant puff-ball, grows in pastures and meadows. Usually the fruit bodies are ten to twenty inches in diameter and even larger. The genus *Bovista* has a fragile

exoperidium, and in the absence of a sterile base and the fact that the fruit body separates easily from the place of attachment it is distinguished from *Lycoperdon*. Because they are readily detached and



FIG. 97.—Specimen of *Geaster fornicatus* from Carleton Rea, England. (After Lloyd, *J. U.*, and *C. G.*, *Bull.* 5, *Lloyd Library*, June, 1902, *Mycological Series* No. 2.)

readily blown about, they are called “tumblers.” *Catastoma* has an outer peridium which splits by a circular line of cleavage, so that the upper part is dislodged carrying along with it the inner peridium which

opens by a mouth that is situated at the actual base of the plant as it grows. The lower part remains as a saucer-shaped body in the soil. A capillitium is present. *Catastoma circumscissum* is the common species.

The earth stars are included in the genus *Geaster*, where the peridium consists of three persistent coats, the two outer adhere and split into leathery, stellate divisions exposing the parchment-like inner peridium, which opens by an apical pore (Fig. 97). It has a columella. The spores are dark brown and mixed with the simple capillitial threads. *Geaster hygrometricus* is the common species. It grows in sandy soil and in dry weather its segments are strongly recurved, but in wet weather they expand, hence the plant is sometimes dubbed poor man's weather glass. *Astræus*, which resembles *Geaster*, is distinguished by the absence of a columella and by the long capillitial threads which are much branched and interwoven.

FAMILY 4. NIDULARIACEÆ.—The following account of the family of bird's-nest fungi is taken from Bulletin 175, United States Department of Agriculture, on "Mushrooms and Other Common Fungi" by Flora W. Patterson and Vera K. Charles. Dried material of these fungi might be kept for use by the class in the systematic study of the higher fungi with the following key at hand. The types should be used as unknowns.

Members of the family NIDULARIACEÆ are represented by small, leathery, cup-shaped plants growing on old sacking, manure, earth, and decaying or dried wood. The common name is suggested by the form of the peridium, which is cup-shaped and contains many small, lenticular bodies (peridiola) resembling eggs. The mouth of the peridium is at first covered by a membrane (epiphragm), which later becomes ruptured and exposes the peridioles. In *Cyathus* and *Crucibulum*, the peridioles are attached to the inner wall of the peridium by elastic cords called funiculi. The spore-bearing tissue and spores are never resolved into a dusty mass, as in many GASTEROMYCETES, but persist in the form of peridiola which contain the spores, which are hyaline and ellipsoidal to subglobose.

KEY TO NIDULARIACEÆ

Peridium with several to many sporangioles:

Peridium torn at the apex in opening—

Sporangioles not attached to the inner wall of the peridium. *Nidularia*.

Peridium opening by a deciduous membrane—

Sporangioles attached to the inner wall of the peridium—

Peridium of three united layers and spores mixed with filaments..... *Cyathus*.

Peridium of a single layer and spores not mixed with filaments..... *Crucibulum*.

CYATHUS

In *Cyathus* the peridium is cup-like and composed of three layers. The apex is covered by a white membrane, which bursts, disclosing egg-like bodies, the peridiola, which usually fill about one-half of the cup. The peridiola are attached to the inner wall of the peridium by an elastic cord, which is attached to each peridiolum in a depression on one side.

Cyathus stercoreus

Peridium cylindrical, campanulate to infundibuliform, sessile or with an elongated base, light brownish, at first with shaggy, matted hairs which disappear in age, interior smooth and nonstriate; peridiola black.

Cyathus stercoreus is an exceedingly common species and is to be found growing on manure or in heavily manured places. It is subject to considerable variation in size and form.

Cyathus striatus

Peridium obconic, exterior even, brownish, hairy, interior striate, lead-colored; apex truncate, covered by a white membrane, which is at first strigose; peridiola compressed, subcircular.

Plant one-half to three-fourths inch in height and about three-eighths inch in diameter.

Cyathus vernicosus

Peridium bell-shaped, subsessile, base narrow, broadly open above, exterior at first brownish, silky tomentose, becoming smooth, interior dull lead color, smooth. Differs from *Cyathus striatus* in the even, non-fluted inner surface of the peridium and in the larger peridiola.

Plant about one-half inch in height and about three-eighths inch in diameter.

CRUCIBULUM

In *Crucibulum* the peridium is cup-shaped and consists of one thick fibrous layer, lined by a very thin, smooth, and shining layer. The

mouth when young is covered with a yellowish tomentose membrane, the peridiola are more numerous than in the preceding genus, and each is attached to the peridium by an elastic cord which springs from a projection on the peridiolum. The plants are smaller than in the genus *Cyathus*.

Crucibulum vulgare

Peridium yellowish-brown, becoming paler with age, outer surface when young velvety tomentose, inner surface smooth and shining; mouth at first closed by a yellowish membrane, which ruptures and exposes the peridiola. Peridiola biconcave, with a projection on one side from which originates the elastic cord which attaches the peridiola to the peridium.

Plant about one-fourth inch in height and about the same in diameter.

FAMILY 5. SCLERODERMACEÆ.—The fruit bodies of the fungi included in this family are subterranean, or epigeic, globose, sessile, or occasionally with a root-like stalk. The peridium is generally simple, thick, rough, warty, or scaly, opening irregularly at maturity. The gleba consists of rounded basidia-bearing parts, which are separated by sterile veins or strands of hyphæ. The individual basidia are pear-shaped to club-shaped with spores which are often lateral in position. The capillitium is rudimentary. *Scleroderma* is the most common genus with sessile fruit bodies and thick, hard, leathery peridium, frequently warty. It usually bursts at the apex into stellate lobes. *Scleroderma geaster* grows in sandy woods, banks or along roadsides. *S. vulgare* is common in dry situations, or hard ground, along cinder paths and gravel walks.

FAMILY 6. SPHÆROBOLACEÆ.—The fruit body is on the surface of the ground. The periphery of the gleba is furnished with a palisade-like layer of radially arranged turgescient cells. The basidia-bearing portion of the gleba is penetrated by sterile veins, or hyphal strands. When ripe the gelatinous gleba is forcibly ejected from the fruit body by the inversion of the palisade-like layer. The family includes a single genus, *Sphærobolus*, of five species. The best-known species is *S. carpobolus* of cosmopolitan distribution.

C. PHALLOMYCETES.—The carrion fungi, stink-horn fungi, or dead-men's fingers, resembles the button stage of the *Amanitas*, and the puff-balls when still young, but later the outer wall is ruptured and the stem elongates carrying upward the sporogenous tissue as a terminal cap, or enlargement. The subterranean mycelium is cord-like and from it the

fruit body arises which has a peridium of two or three layers. The outer peridium is leathery and tough, while the inner peridium is gelatinous at maturity. The outer peridium remains at the base, as a cup called the volva. The sporophore, pileus, or cap, is raised up on the end of a stalk, or stipe, which is usually spongy in character. The sporophore takes a variety of forms, but in all cases, its outer surface at



FIG. 98.—*Clathrus cancellatus*, fully mature fruit-body, natural size. (After Ed. Fischer, *Die natürlichen Pflanzenfamilien* I. 1A**, p. 282.)

first represents the hymenium which deliquesces at maturity, so that the minute spores are imbedded in a greenish, fetid slime, which gives off a penetrating, nauseating odor, attractive to blue-bottle flies, that lick off the malodorous slime with evident enjoyment and are the agents by which the spores are distributed. In fact, it has been proved that the basidiospores germinate better after passage through the alimentary

canals of flies. The gleba is the fruiting portion of the phalloid and its bulk appears considerable in the early egg-shaped stage of the fruit body. As the carrion fungus matures, it forms proportionately less of the fruit body, for it is converted into the greenish, mucilaginous mass which is removed by the flies. Some forms like *Dictyophora* have a veil that hangs under the pileus and spreads out as a net around the stem. Although it is called the veil, it is more correctly the indusium. The sporophore in genera like *Clathrus* (Fig. 98) takes the form of a hollow sphere, or of a basket-like lattice, while in other genera it resembles the open iron framework of a lantern, a brazier, a crinoid, or stone-lily, an octopus, or even a sea-anemone. One tropic form of Brazil has been called Pilzblumen by the Germans. The species are not common in temperate regions, but in the tropics they are richer in forms and more abundant; for example, in Florida the species of *Clathrus* are common, the writer finding four specimens within a quarter of a mile along a road across the sand dunes at Ormond.

Development of the Carrion Fungi.—Several authors have studied the development of several forms of the PHALLOMYCETES, notably Burt and Atkinson. Burt¹ has contributed three papers dealing with the genera *Anthurus*, *Clathrus* and *Mutinus*, while Atkinson's studies¹ are concerned with *Ithyphallus* and *Dictyophora*.

Burt finds in the CLATHRACEÆ that the egg consists of cortical and medullary systems continued upward from the mycelial strand in the earliest stage. The cortical layer gives rise to the outer layer of the volva, the cortical plates and the pseudoparenchyma of the receptaculum. The medullary portion gives rise to the gelatinous masses of the gelatinous layer of the volva, to the gleba, and to the gelatinous tissue of the chambers of the receptaculum. The elongation of the receptacle in *Clathrus columnatus* (Fig. 98) begins at the base and after its elongation the gleba hangs suspended from the arch of the receptaculum by medullary tissue constituting the chamber masses of the receptacle.

In the earliest recognizable stage of *Mutinus caninus*, the egg consists of the cortical and medullary tissues of the mycelial strand,

¹ BURT, EDWARD A.: A North American Anthurus: Its Structure and Development. *Memoirs Boston Soc. of Nat. Hist.*, 3: 487 (1894); The Development of *Mutinus caninus*. *Annals of Botany*, 10: 343 (1896); The Phalloidæ of the United States. *Development of the Receptacle of Clathrus columnatus*.

ATKINSON, GEORGE F.: The Origin and Taxonomic Value of the Veil in *Dictyophora* and *Ithyphallus*. *Botanical Gazette*, 50: 1-20, January, 1911.

continued directly upward from the strand. Of these tissues, the medullary bundle spreads out at its upper end and forms a dense sheaf-like head by repeated branching and anastomosing. The cortical layer of tissue becomes the outer wall of the volva; the sheaf-like head gradually differentiates into all the other parts of the older egg. In such differentiation the central column first appears. The formation of the gelatinous layer of the volva now begins in the periphery of the head. A dense dome-shaped mass arises. Along the inner surface of the dense zone and next to the intermediate tissue, the rudiment of the gleba arises from the clustered swollen ends of lateral branches of the tramal tissue. These hyphal ends take position in a palisade layer facing the intermediate tissues and by the crowding in of new hyphal ends (basidia) the surface of this layer becomes greatly enlarged and thrown into folds and torn from the intermediate tissue. The rudiment of the stipe arises in the intermediate tissue lying next to the central column by the formation of deeply staining tissue rich in protoplasm. Somewhat later, masses of tissue in the dense and intricately interwoven rudiment of the stipe show a tendency toward gelatinization. These masses mark the position of the later chamber-cavities in the wall. Toward the upper end of the stipe, such masses are in contact with the central column, and they mark the position of the pits which open into the main central cavity of the stipe in mature stages of *M. caninus*.



FIG. 99.—Mature stinkhorn, *Dictyophora duplicata*. (Photo by W. H. Walmsley.)

The chamber walls are thrown into folds through a more rapid growth of the pseudoparenchyma than that of other parts of the egg. Final elongation of the stipe and elevation of the gleba is brought about through the straightening out of the folds in the chamber walls.

The studies of Atkinson deal with the origin of the veil of *Dictyo-*

phora (Figs. 99 and 100), and *Ithyphallus*. From such studies, he confirms the making of two genera out of them. His plates show

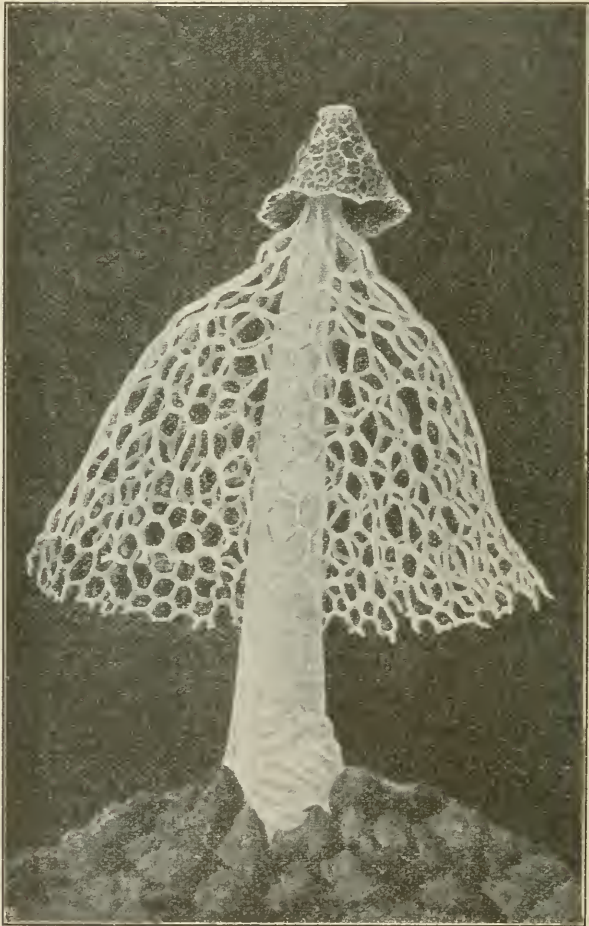

FIG. 100.—*Dictyophora phalloidea*. Fully developed fruit-body with veil $\frac{2}{3}$ natural size. (After Alf Möller in *Die natürlichen pflanzenfamilien* I. 1A**, p. 294.)

that three common forms were examined, viz., *Ithyphallus impudicus*, *Dictyophora duplicata* and the *Phallus Ravenellii*.

Two families are distinguished: CLATHRACEÆ and PHALLACEÆ which may be distinguished as follows:

Receptacle latticed or irregularly branched, sessile or stalked; gleba inclosed within the receptacle. FAMILY 1. CLATHRACEÆ.

Receptacle tubular or cylindric, capitate, with the gleba external. FAMILY 2. PHALLACEÆ.

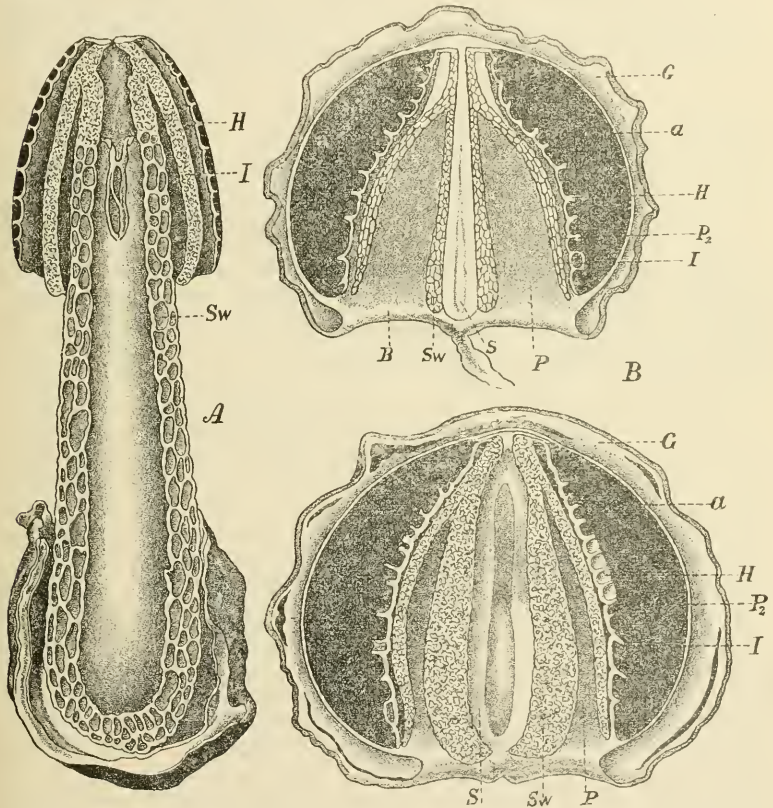

FIG. 101.—A, B, *Dictyophora phalloidea*. A, Longitudinal section of a fruit-body fully stretched beyond volva (natural size); B, longitudinal section of a young fruit-body (twice enlarged); G, volva mucilage; a, gleba; H, cap; I, indusium; Sw, stipe; P₂, primordial layer between cap and indusium; P₁, primordial layer between indusium and stipe; S, S, tissue of stem; B, tissue of base of fruit-body. (After Ed. Fischer in *Die natürlichen Pflanzenfamilien* I. 1A**, p. 295.)

The first family, according to “*Die natürlichen Pflanzenfamilien*,” comprises eleven genera of which *Clathrus* (Fig. 98), *Simblum*, *Anthurus* are North American. Three species of *Clathrus* have been collected in this country. *Simblum rubescens* was collected originally on

Long Island and later in Nebraska, while *Anthurus borealis* has been found in New York, Massachusetts and Pennsylvania.

The family PHALLACEÆ is represented in the eastern United States by three important and interesting genera, viz., *Mutinus*, *Ithyphallus*, *Dictyophora* (Figs. 99, 100, 101). *Mutinus* is the simplest form with the gleba borne on the upper portion of the stipe without the hanging cap. *Mutinus caninus* has a hollow, perforate stipe reddish in color bearing the greenish bad-smelling spore slime over its upper end. *Ithyphallus impudicus*, our commonest species, has a globose volva, cylindric, hollow spongy stalk bearing a campanulate pileus, the spore-bearing surface being reticulate pitted. *Dictyophora duplicata*, which resembles the Brazilian Pilzblumen, *D. phalloidea* in (Figs. 100, 101) the possession of a long white indusium, which hangs down beneath the cap like a spread-out hoopskirt. The terminal cap is campanulate and after the removal of the malodorous greenish spore slime appears reticulate-pitted. The volva is prominent.

BIBLIOGRAPHY OF THE EUBASIDII

- ALLEN, C. L.: The Development of Some Species of *Hypholoma*. *Ann. Myc.*, 4: 387-394, 1906.
- AMES, ADELINE: A Consideration of Structure in Relation to Genera of the Polyporaceæ. *Ann. Myc.*, 11, No. 3, 1913.
- ATKINSON, GEO. F.: Studies and Illustrations of Mushrooms. *Bull.* 138, Cornell Univ. Agric. Exper. Stat., September, 1897.
- ATKINSON, GEO. F.: Mushrooms Edible, Poisonous, Etc., 1900: i-vi+1-275, with 223 figures.
- ATKINSON, GEO. F. AND SHORE, ROBERT: Mushroom Growing for Amateurs. *Bull.* 227, Cornell Univ. Agric. Exper. Stat., March, 1905.
- ATKINSON, GEO. F.: The Development of *Agaricus campestris*. *Botanical Gazette*, 42: 215-221, September, 1906.
- ATKINSON, GEO. F.: A Remarkable *Amanita*. *Botanical Gazette*, 48: 283-293, October, 1909.
- ATKINSON, GEO. F.: The Origin and Taxonomic Value of the Veil in *Dictyophora* and *Ithyphallus*. *Botanical Gazette*, 50: 1-20, January, 1911.
- ATKINSON, GEO. F.: The Development of *Agaricus arvensis* and *A. comtulus*. *Amer. Journ. Bot.*, 1: 3-22, 1914.
- ATKINSON, GEO. F.: Morphology and Development of *Agaricus Rodmani*: *Proc. Amer. Philos. Soc.*, liv: 309-342, with 7 plates, 1915.
- ATKINSON, GEO. F.: Origin and Development of the Lamellæ in *Coprinus*. *Botanical Gazette*, lxi: 89-130, with 8 plates and 6 diagrams in the text, February, 1916.

- BANKER, HOWARD J.: A Contribution to a Revision of the North American Hyd-naceæ. *Memoirs Torr. Bot. Club*, xii, No. 2, June, 1906.
- BEER, R.: Notes on the Development of the Carpophore of Some Agaricæ. *Annals of Botany*, 25: 683-689, 1911.
- BERNARD, N.: Phénomènes reproducteurs chez les Champignons supérieurs. *Bull. Mens. Assoc. fr. Avanc. Sc.*, 1905; *Abstract Bot. Centralb.*, cl: 394, 1906.
- BOUDIER, ÉMILE: *Icones Mycologicæ*, 4 vols., Paul Klinsieck, Publisher.
- BREFELD, O.: *Untersuchungen aus dem Gesamtgebiete der Mycologie*, xiv, 1908: 246-256.
- BULLER, A. H. REGINALD: *Researches on Fungi*, 1909; 1-287, with 5 plates and 83 figures.
- BULLER, A. H. R.: The Relations of the Fruit Bodies of *Lentinus lepideus* to External Stimuli. *Annals of Botany*, xix: 427.
- BURT, E. A.: The Development of *Mutinus caninus*. *Annals of Botany*, x: 343, 1896.
- BURT, EDWARD A.: The Phalloideæ of the United States. I. The Development of the Receptaculum of *Clathrus columnatus*, *Bosc. Botanical Gazette*, 22: 273-292; II. Systematic Account, *do.*, 22: 379-391, III. *do.*, 24: 73-92, 1897.
- BURT, EDWARD A.: Key to the Genera of Basidiomycetes of Vermont. *Contrib. to Botany of Vermont*, VI. Middlebury, 1899; reprinted 1900.
- BURT, E. A.: The Thelephoraceæ of North America. *Annals of Missouri Botanical Garden*, I: 185-228; 327-350; 357-382; II: 627-658; 731-770, November, 1915.
- CLEMENTS, FREDERIC E.: *Minnesota Mushrooms*. *Minnesota Plant Studies*, iv, 1910.
- COOKE, M. C.: *Illustrations of British Fungi*, 8 vols., pls. 1-1198, London, 1881-1891.
- COOKE, M. C.: *British Edible Fungi: How to Distinguish and How to Cook Them*, London, 1891: 1-237.
- COVILLE, FREDERICK V.: Observations on Recent Cases of Mushroom Poisoning in the District of Columbia. *Circular 13*, Div. of Bot., U. S. Dept. Agric.
- DALLAS, ELLEN M. and BURGIN, CAROLINE A.: *Among the Mushrooms: A Guide for Beginners*, 1900: i-xix, 1-175.
- DANGEARD, P.: La sexualité chez les Champignons. *Revue Scientifique*, 5e série T. iv, 1905. *Abstract in Botanisches Centralblatt*, Bd. cii, 1906: 378.
- DUGGAR, B. M.: The Cultivation of Mushrooms. *Farmers' Bull.* 204, U. S. Dept. Agric., 1904.
- DUGGAR, B. M.: The Principles of Mushroom Growing and Mushroom Spawn-Making. *Bull.* 85, Bureau of Plant Industry, U. S. Dept. Agric., 1905.
- DUGGAR, B. M.: *Mushroom Growing*, 1915: i-viii + 1-250.
- FARLOW, W. G.: Some Edible and Poisonous Fungi, *Bull.* 15, Div. of Veg. Physiol. and Pathol., U. S. Dept. Agric., 1898.
- FARLOW, WILLIAM G.: *Bibliographical Index of North American Fungi*, vol. i, part 1, *Abrothallus to Badhamia*, Publ. 8, Carnegie Institution of Washington, 1905.
- FAYOD, V.: *Prodrome d'une histoire naturelle des Agaricinées*. *Ann. Sci. Nat. Bot.*, vii, 9: 181-411, 1889.

- FERGUSON, MARGARET C.: A Preliminary Study of the Germination of the Spores of *Agaricus campestris* and other Basidiomycetous Fungi. Bull. 16, Bureau of Plant Industry, U. S. Dept. Agric., 1902.
- FISCHER, C. C. E.: On the Development of the Fructification of *Armillaria mucida* Schrad. Annals of Botany, 23: 503-507, 1909.
- FISCHER, C. C. E.: The Biology of *Armillaria mucida* Schrod. Annals of Botany, 23: 515-534, 1909.
- FISCHER, ED.: Zur Morphologie der Phalloideen. In Beitrage z. Morph. u. Physiol. der Pilze Abhandl. d. Senkenb. Naturf. Ges., v: 204, 1864.
- FISCHER, ED.: Versuch eine systematischen Uebersicht über die bisher bekanntem Phalloideen. Jahrb. bot. Gartens zu Berlin, 4: 1-92, pl. 1, 1886.
- FISCHER, ED.: Untersuchungen zur vergleichenden Entwicklungsgeschichte und Systematik der Phalloideen. Denkschr. Schw. naturf. Gesellsch., 32: 1-103, pl. 1-6, 1890.
- FISCHER, ED.: Neue Untersuchungen zur vergleichenden Entwicklungsgeschichte und Systematik der Phalloideen. Denkschr. Schw. naturf. Gesellsch., 33: 1-51, pls. 1-3, 1893.
- FISCHER, ED.: Phallineæ, Plectobasidiineæ. Die natürlichen Pflanzenfamilien, I Teil, Abt. 1**, 1900.
- GERARD, W. R.: List of United States Phalloidei. Bull. Torr. Bot. Club, 7: 11, 1880.
- HARPER, R. A.: Binucleated Cells in Certain Hymenomycetes. Botanical Gazette, 33: 1-23, 1902.
- HENNINGS, P.: Exobasidiineæ, Hymenomycetineæ. Die natürlichen Pflanzenfamilien, I Teil, Abt. 1**, 1900.
- HERBST, WILLIAM: Fungal Flora of the Lehigh Valley, Pa., 1899: 1-229.
- LEVINE, MICHAEL: Studies in the Cytology of the Hymenomycetes, Especially the Boleti. Bull. Torr. Bot. Club, 40: 137-181, 1913.
- LEVINE, MICHAEL: The Origin and Development of the Lamellæ in *Coprinus micaceus*. Amer. Journ. Bot., 1: 303-322; July, 1914.
- LLOYD, C. G.: The Genera of Gastromycetes, 1902: 1-24.
- LLOYD, C. G.: The Geastreae, 1902: 1-44.
- LLOYD, C. G.: The Lycoperdaceæ of Australia, New Zealand and Neighboring Islands, illustrated with 15 plates and 49 figures, 1905: 1-42.
- LLOYD, C. G.: The Genus *Lycoperdon* in Europe. Mycological Notes, No. 19, May, 1905.
- LLOYD, C. G.: The Lycoperdons of the United States. Mycological Notes, No. 20, June, 1905.
- LLOYD, C. G.: The Tylostomeæ, illustrated with 12 plates and 6 figures, 1906: 1-28.
- LLOYD, C. G.: The Genus *Bovistella*. Mycological Notes, No. 23, August, 1906.
- LLOYD, C. G.: The Nidulariaceæ, or Birds-Nest Fungi, illustrated with 10 plates and 20 figures, 1906: 1-32.
- LLOYD, C. G.: The Phalloids of Australasia, 1907: 1-24.
- LLOYD, C. G.: Concerning the Phalloids. Mycological Notes, No. 26, 325-337, pls. 112-121, figs. 160-163, 1907.
- LLOYD, C. G.: Concerning the Phalloids. Mycological Notes, No. 24, December,

1906; No. 26, May, 1907; No. 28, October, 1907; No. 29, January, 1908; No. 30, February, 1908.

LLOYD, C. G.: *Polystictus* (Section *Pelloporus*). *Mycological Notes*, Polyporoid Issue, No. 1, February, 1908.

LLOYD, C. G.: The Genus *Favolus*. *Mycological Notes*, Polyporoid Issue, No. 2, August, 1909.

LLOYD, C. G.: Synopsis of the Genus *Hexagona*, 1910: 1-46.

MAGNUS, P.: Die verderblichste Champignonkrankheit in Europa. *Naturwissenschaftliche Rundschau*, xxi:

MARSHALL, NINA L.: The Mushroom Book, New York, Doubleday, Page & Co., 1902: i-xxvi + 1-167.

MASSART, JEAN: Sur les Ronds de Sorcière de *Marasmius oreades* Fries. *Annales au Jardin Botanique de Buitenzorg*, 2e ser., suppl. iii: 583-586, 1910.

MASSEE, GEORGE: A Revision of the Genus *Coprinus*. *Annals of Botany*, x: 123-184, 1896.

MASSEE, GEORGE: A Monograph of the Genus *Calostoma* Desv. *Annals of Botany*. II: 25.

MASSEE, GEORGE: A Monograph of the British *Gastromycetes*. *Annals of Botany*, iv: 1, with 4 plates.

MCILVAINE, CHARLES: The Rights and Wrongs of Toadstools. *New Science*, Review, i: 106-112, July, 1894.

MCILVAINE, CHARLES: Edible and Non-Edible Mushrooms and Fungi. *American Journal of Pharmacy*, 68: 648, December, 1896.

MCILVAINE, CHARLES: One Thousand American Fungi, 1900 pages, i-xxxvii + 1-704.

MENDEL: The Chemical Composition and Nutritive Value of Some Edible American Fungi, *Amer. Journ. Physiol.*, i: 225-238, 1898.

MICHAEL: Führer für Pilzfreunde, 12 mo, 55 plates, Zwickau, 1897.

MÖLLER, ALFRED: Brasilische Pilzblumen, Heft 7, *Botanische Mittheilungen aus den Tropen*, 1895; 1-152, with 8 plates.

MORGAN, A. P.: North American Fungi: The *Gastromycetes*. *Journal Cincinnati Society Natural History*, 1889: 141-149.

MURRILL, WILLIAM A.: (Agaricales) *Polyporaceæ* (pars). *North American Flora*, vol. 9, parts 1 & 2, conclusio.

MURRILL, WILLIAM A.: (Agaricales) *Agaricaceæ* (pars). *North American Flora*, vol. 10, part 1, July 28, 1914.

MURRILL, WILLIAM A.: Northern Polypores. Including species found in Canada and the United States south to Virginia and west to the Rockies, November, 1914.

MURRILL, WILLIAM A.: Southern Polypores. Including species found in the United States from North Carolina to Florida and west to Texas, January, 1915.

MURRILL, WILLIAM A.: Western Polypores. Including species found in the States on the Pacific coast from California to Alaska, February, 1915.

MURRILL, WILLIAM A.: Tropical Polypores. Including species found in Mexico,

- Central America, southern Florida, the West Indies, and other islands between North America and South America, March, 1915.
- MURRILL, WILLIAM A.: American Boletes. Including all the species found in temperate and tropical North America, both on the mainland and on the islands, south to South America, November, 1914.
- MURRILL, WILLIAM A.: Edible and Poisonous Mushrooms. A Descriptive Handbook to Accompany the Author's Colored Charts of Edible and Poisonous Mushrooms. 1-76 pages, New York, 1916.
- NEUMAN, J. J.: The Polyporaceæ of Wisconsin, Bull. xxxiii, Wisconsin Geological and Natural History Survey, Scientific series No. 10, 1914: 1-206, with 25 plates.
- NICHOLS, MISS S. P.: The Nature and Origin of the Binucleated Cells in some Basidiomycetes, Trans. Wisc. Acad. Sci., Arts and Letters, xv: 30-70, 1904.
- OVERHOLTS, L. O.: The Known Polyporaceæ of Ohio. The Ohio Naturalist, June, 1911; Annals Mo. Bot. Gard., i: 81-155.
- OVERHOLTS, L. O.: Comparative Studies in the Polyporaceæ. Annals Mo. Bot. Gard., ii: 667-730, November, 1915.
- PATTERSON, FLORA W., and CHARLES, VERA K.: Mushrooms and other Common Fungi. Bull. 175, U. S. Dept. Agric., 1915.
- PECK, CHARLES: Reports of the State Botanist of New York in the Regents' Reports of the State Museum of Natural History.
- PECK, CHARLES: Boleti of the United States. Bull. New York State Museum No. 8, 1888.
- PENZIG, O.: Ueber javanische Phalloideen. Ann. Jard. Bot. Birtenzorg, 16: 133-173, pls. 16-25, 1893.
- ROSSMANN, J.: Beitrag zur Entwicklungsgeschichte des Phallus impudicus L. Botanische Zeitung, 11: 185-193, pls. 4, 1853.
- RUHLAND, W.: Zur Kenntniss der intracellularen Karyogamie bei der Basidiomyceten, Botanische Zeitung, 1901, Abt. i: 187-204.
- SPAULDING, PERLEY: Fungi of Clay Mines, 21 Report Mo. Bot. Gard, 189-195.
- STOVER, WILMER G.: The Agaricaceæ of Ohio. Proc. Ohio State Acad. Sci., vol. v, part 9: 462-577, 1912.
- UNDERWOOD, L. M. and EARLE, T. S.: The Distribution of the Species of Gymnosporangium in the South on Juniperus virginiana] Botanical Gazette, 22: 255-258, 1896.
- UNDERWOOD, LUCIEN M.: Moulds, Mildews and Mushrooms. A Guide to the Systematic Study of the Fungi and Mycetozoa and Their Literature, New York, 1899.
- VERRILL, A. E.: A Recent Case of Mushroom Intoxication. Science, new ser., xl: 408-410, Sept. 18, 1914.
- VON TAVEL, DR. F.: Vergleichende Morphologie der Pilze, 1892: 140-185.
- WEMYSS, FULTON T.: The Dispersion of Spores by the Agency of Insects, with Special Reference to the Phalloideæ. Annals of Botany, iii: 207.
- WHITE, EDWARD A.: A Preliminary Report on the Hymeniales of Connecticut. Bull. 3, State Geological and Natural History Survey, 1905.



FIG. 102.—*Phyllosticta paviae* on horse-chestnut leaves. (Cold Spring Harbor, L.I., July 28, 1915.)

strands, which suggest the inflorescences of flowering plants. One can separate these into monopodial, or sympodial forms. A bundle of conidiophores is known as a *coremium* (κόρημα = broom). If the conidiophores are arranged side by side, they form a conidial layer, which arises on the upper surface of a stroma. Such a conidial layer may be folded, or it may be chambered, the irregular chambered spaces being lined with the conidial layer. Finally, the conidial layer may be enclosed in receptacles called pycnidium, which correspond to those of the PYRENOMYCETINEÆ. The conidiospores are of different sizes, hence one can distinguish them as a *micropycnidia* and as *macropycnidia*, and the spores as micro- and macropycnosporos. Stylospores are those spores borne on a filament (στῦλος = a column). This term is also superfluous. The number of fungi imperfecti surpasses the ASCOMYCETALES.

Systematic Position.—Fuckel includes all those fungous forms as fungi imperfecti which have no final fruit forms, such as asci and basidia. The name DEUTEROMYCETES of Saccardo is less fortunate than that of Fuckel. That many fungi imperfecti represent accessory fruit forms of ASCOMYCETALES is known, so that the group is not a permanent systematic entity. It is a motley assemblage of heterogeneous forms. As with the large group, so it is with the genera. Some of the genera inclose not always related forms, that is of the same phylogenetic series. Schroeter calls such genera Formgattungen (= form genera). In the following classification of them, this point of view must be kept prominently in view, for a natural classification of Fungi Imperfecti is in the nature of things an impossibility. The greatest number are saprophytes, useful in the destruction of dead plant parts. Many are parasites and produce dangerous diseases in cultivated plants.

- A. Conidia in pycnidia, or chamber-like hollows. I. SPHÆROPSIDALES.
- B. Conidia in conidial layer formed ultimately wholly free. II. MELANCONIALES.
- C. Conidia on conidiophores. Single or in coremia. III. HYPHOMYCETALES.

I. SPHÆROPSIDALES.—The conidia are formed in pycnidia. The receptacles are closed or open by a pore, or by a slit suggesting

groups of ASCOMYCETALES. Four families are included in this order, and these families include a considerable number of important genera of fungi, which specifically are the cause of important plant diseases. *Phyllosticta* is a genus, the species of which are confined to leaves, and they produce characteristic leaf spots on a great variety of plants. The specific name of the fungus is usually derived from that of the host plant attacked, as for example, *Phyllosticta catalpæ*, which

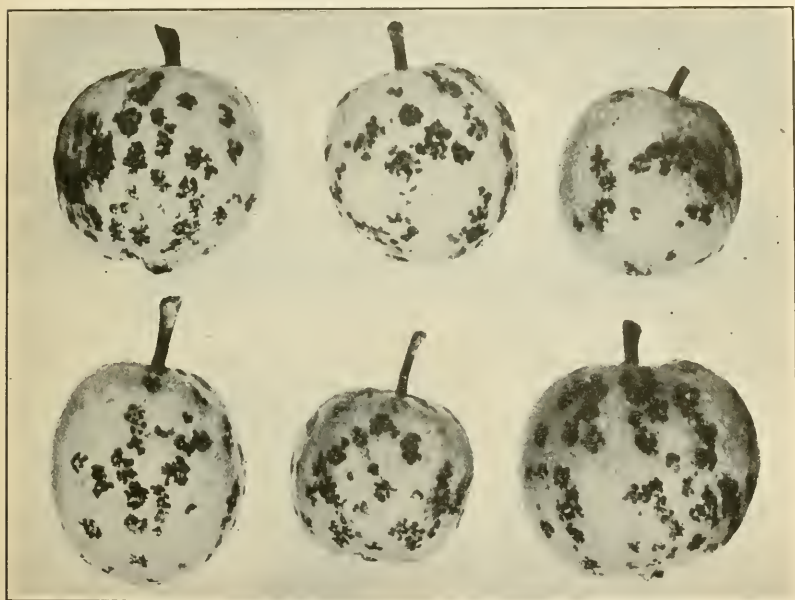

FIG. 103.—Six Ben Davis apples showing apple blotch (*Phyllosticta solitaria*). (After Scott, W. M., and Rorer, J. B., Bull. 144, U. S. Bureau of Plant Industry, March 6, 1909.)

grows on the leaves of the catalpa. The group has been monographed systematically by J. B. Ellis. The spores are small, egg-shaped or elongated, unseptate and in color pale green, or hyaline, produced in pycnidia. The most important species of this genus are *Phyllosticta ampelopsidis* on the Virginia creeper (*Ampelopsis*); *catalpæ* on catalpa leaves; *labruscæ* on the leaves of the grape; *paviæ* on horse chestnut leaves (Fig. 102); *Phyllosticta solitaria* E. and E. (Figs. 103 and 104) is the cause of apple blotch, and *violæ* on violets. The conidio-

spores in *Phoma* are colorless and unicellular. The pycnidia are black with a terminal pore and depressed in the tissues of the host. The genus is arbitrarily limited to those species in which the spores are less than 15μ , for the larger spored forms have been placed in the genus *Macrophoma*. The most important species from the pathologic viewpoint are out of the 1100 species recognized the following: *Phoma betæ* is the cause of the heart rot and blight of beets. *Phoma batatae* produces a dry rot of sweet potato; while *Phoma solani* behaves much

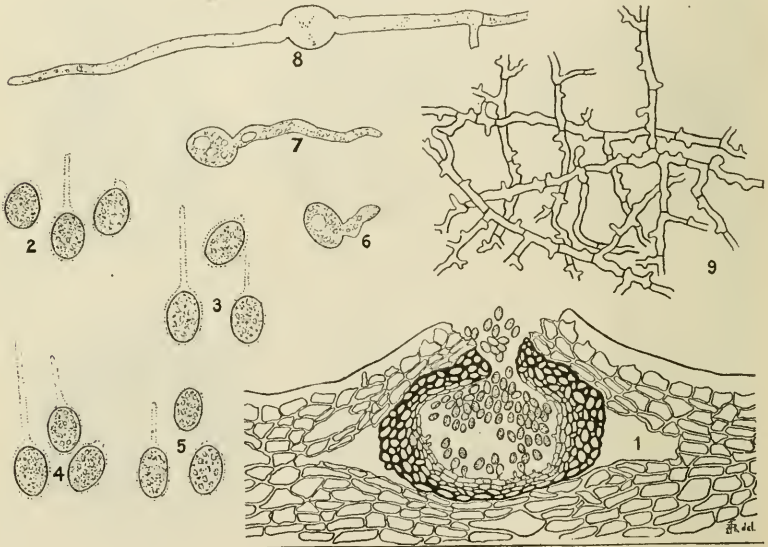

FIG. 104.—Microscopic characters of apple blotch fungus (*Phyllosticta solitaria*). 1, vertical section of pycnidium showing pycnospores; 2, 3, 4, 5, mature pycnospores; 6, 7, 8, germinating spores; 9, mycelium. (After Scott, W. M., and Rorer, J. B., Bull. 144, U. S. Bureau of Plant Industry, pl. iii, March 16, 1909.)

like the damping-off fungus, attacking seedling egg plants near the surface of the ground. The most destructive fungus of the genus *Sphaeropsis* is *S. malorum* which causes the decay of apples, quinces and pears and attacks the stem of the apple tree producing characteristic cankers. The genus includes about 180 species. The 150 species of the genus *Coniothyrium* are widely spread geographically. The blight of raspberry canes is due to *Coniothyrium Fuckelii*, which has only recently come into prominence in the United States. The genus *Septoria* in-



FIG. 105.—Septoria leaf spot disease of celery, or celery blight. (After Coons, G. N., and Levin, Ezra, *Spec. Bull.* 77, *Mich. Agric. Coll. Exper. Stat.*, March, 1916.)

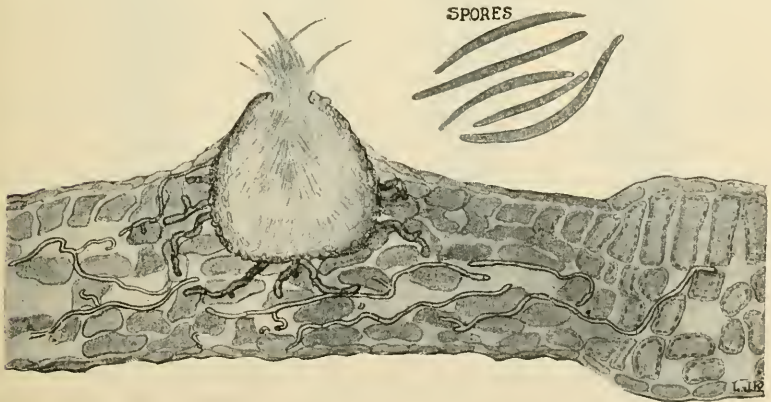

FIG. 106.—Section through leaf spot of celery blight (*Septoria*) showing hyphae in leaf tissue and pycnidium with exuding pycnospores. (After Coons, G. H., and Levin, Ezra, *Spec. Bull.* 77, *Mich. Agric. Coll. Exper. Stat.*, March, 1916.)

cludes the fungi which cause the leaf spot of the pear, *Septoria pyricola*, the late blight of the celery *S. petroselini* (Figs. 105 and 106), the leaf blight of the tomato *S. lycopersici* and the leaf spot of currants, *S. ribis*. The pycnidia in this genus develop under the epidermis of the host producing leaf spots. The center of the leaf spot is occupied by the pore of the spheric, black pycnidium. *Leptothyrium pomi* is an imperfect fungus responsible for the sooty blotch of the apple and other plants. According to Floyd the same fungus causes the fly speck of apples. The genus *Entomosporium* is a small one with closed half-spheric, black pycnidia. The spores suggest an insect in being four-celled, the cells being arranged cross-like with attenuated extremities and swollen bases. *Entomosporium maculatum* is the cause of the leaf blight of the pear and quince.

II. MELANCONIALES.—The mycelium is formed in the interior of the host plants. The fruit is in the form of a conidial hymenium, which is produced below the epidermis of the host, breaking through clefts in the surface of the host as bright or black spots. The conidiophores stand closely together and are simple, or rarely branched, hyaline, or rarely dark-colored. Pycnidia are unknown in this group of imperfect fungi. The spores are of different shapes, single or in chains. The order includes both parasites and saprophytes. The pustule, or acervulus, which produces spores in *Gleosporium* may be extensive. The short conidiophore arise from or are inclosed within a cushion, or stroma, of fungous tissue. The rupture of the epidermis of the host is accomplished by the opening of the stroma. The ovoidal, fusiform, slightly curved hyaline spores are discharged with the opening of the stroma. Some species of *Gleosporium* are connected with other genera, viz., *Glomerella (rufomaculans)*, *Gnomonia* and *Pseudopeziza* the imperfect stages of which were placed as species under the form genus *Gleosporium*, which is the important form pathologically speaking. As examples of the form genus *Gleosporium*, we have *G. ampelophagum* which causes the anthracnose of the grape; *G. venetum* which is responsible for the anthracnose of blackberry and raspberry, while other species attack the linden, walnut, pine and Norway maple.

In *Colletotrichum* (Fig. 107) the conidial cushions have a bristly border, while the conidiospores are in chains. *Colletotrichum Lindemuthianum* causes anthracnose of bean, an important disease in gardens and fields (Fig. 107). The cotton is attacked by *C. gossypii*, citrus fruits by

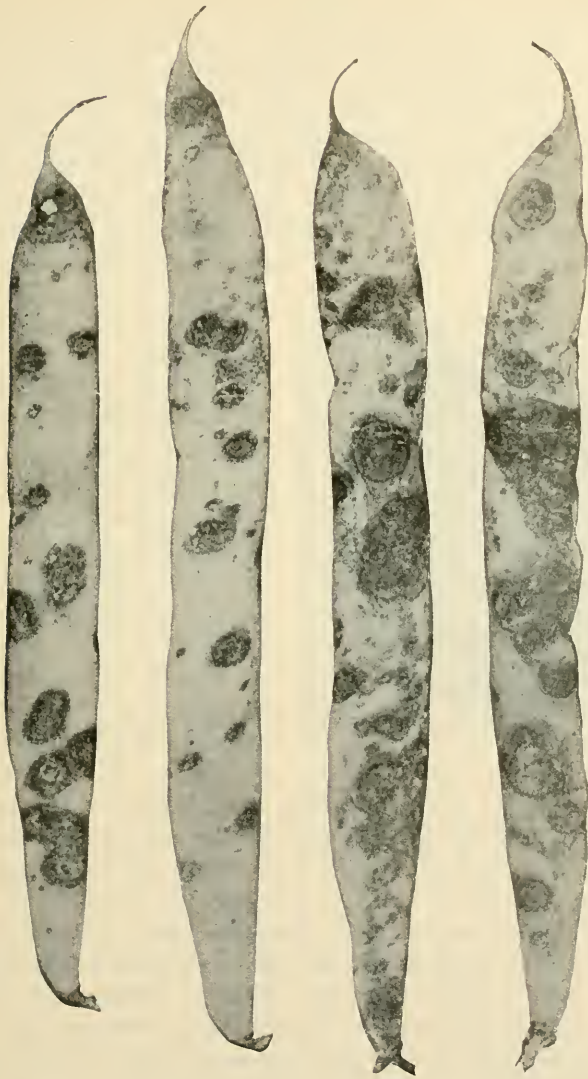

FIG. 107.—Anthracose cankers on bean pods (*Colletotrichum Lindemuthianum*)
(After Whetzel, H. H., Bull. 255, Cornell Agric. Exper. Stat.)

C. glaucosporioides, clovers and alfalfa by *C. trifolii* and the snapdragon by *C. antirrhini*. Usually the diseases on these plants induced by species of *Colletotrichum* are known as anthracnose (Fig. 107). *Coryneum Beijerinckii* is a destructive fungus causing the peach blight. *Pestalozzia Guepini* var. *vaccinii* is a fungus often found upon the cranberry leaves and fruits. The conidiospores are three-celled, the terminal cells with filiform appendages. The shot-hole disease of plum and cherry is due to *Cylindrosporium padi*. The formation of the acervuli is followed by the falling out of the disease areas of the leaf resulting in the formation

of the characteristic shot-hole. The fruit spot of apples is caused by *C. pomii*.

III. HYPHOMYCETALES.

—The hyphæ are septate, branched in or on the substratum. They are dark, or hyaline, separate, or bound into coremia, or layer-like cushions. The conidiospores may exist as oidiospores through the separation of the hyphæ. The conidiophores are simple, or branched. The conidiospores of different shapes and colors are borne in a variety of ways on the conidiophores or their branches. The genera may be arranged in three series.

A. Mycelium and spores light-colored: *Oospora*, *Monilia*,

Oidium, *Sporotrichum*, *Botrytis*, *Cephalothecium*, *Ramularia*, *Cercospora*, *Piricularia*. B. Mycelium dark-colored at least with age; spores generally dark: *Fusicladium*, *Polythrincium*, *Scoletotrichum*, *Cladosporium*, *Helminthosporium*, *Macrosporium*, *Alternaria*, *Cercospora*, C. Conidiophores in the form of a tuberculate mass, or sporodochium: *Volutella*, *Fusarium*. As examples of common disease producing forms of the above genera without enumerating all of the more important species may be mentioned the potato scab fungus, *Actinomyces chromogenes*, the early blight of potato fungus, *Macrosporiums olani*; the



FIG., 108.—Sweet-potato stem rot (*Fusarium batatas*). Section through sweet potato showing blackened ring just below surface caused by the stem-rot fungus. (After Harter, L. L., U. S. Farmers' Bull. 714, March 11, 1916.)

fungus which causes leaf spot of beets, *Cercospora beticola*. The form genus *Fusarium* (Fig. 109), established by Link in 1809, is one which has come into prominence recently as associated with the production of serious plant diseases. At least eleven species are found on the sweet potato (Fig. 108), and these have been investigated by H. W. Wollenweber¹ and other mycologists. He finds that the genus has a number of vegetative and spore stages the variability of which has caused confusion, as transfers of mycelium produce a growth quite different in general appearance from that derived from spores from the

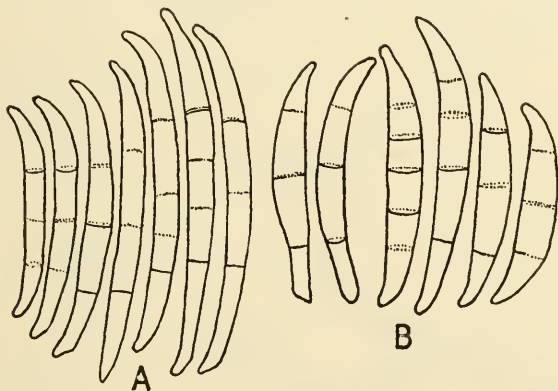

FIG. 109.—Spores of two stem-rot organisms. A, *Fusarium batatatis* and B, *F. hyperoxysporum*, $\times 500$. (After Harter, L. L., U. S. Farmers' Bull. 714, March 11, 1916.)

same medium under conditions otherwise identic. Wollenweber and Appel² have published a monograph of *Fusarium* and later Wollenweber has studied the *Fusarium* problem and similar studies should be made of each one of the form genera of the FUNGI IMPERFECTI. The genus *Fusarium* is divisible into sections not only by physiologic characters (p athogenicity) but also by morphologic characters (conidiospores, chlamydospores). The section, *Elegans*, comprises the vascular parasitic *Fusaria*, which are serious enemies of plants, causing

¹ WOLLENWEBER, H. W.: Identification of Species of *Fusarium* occurring on the Sweet Potato, *Ipom ea batatis*. Journal of Agricultural Research, II: 251-286 July 15, 1914.

² APPEL, OTTO, AND WOLLENWEBER, H. W.: Grundlage einer Monograph der Gattung *Fusarium* Link Arb. Biol. Anst. f. Land. u. Forst., Bd. 8, Heft. 1, pp. 1-207; Phytopathology III: 24-50.

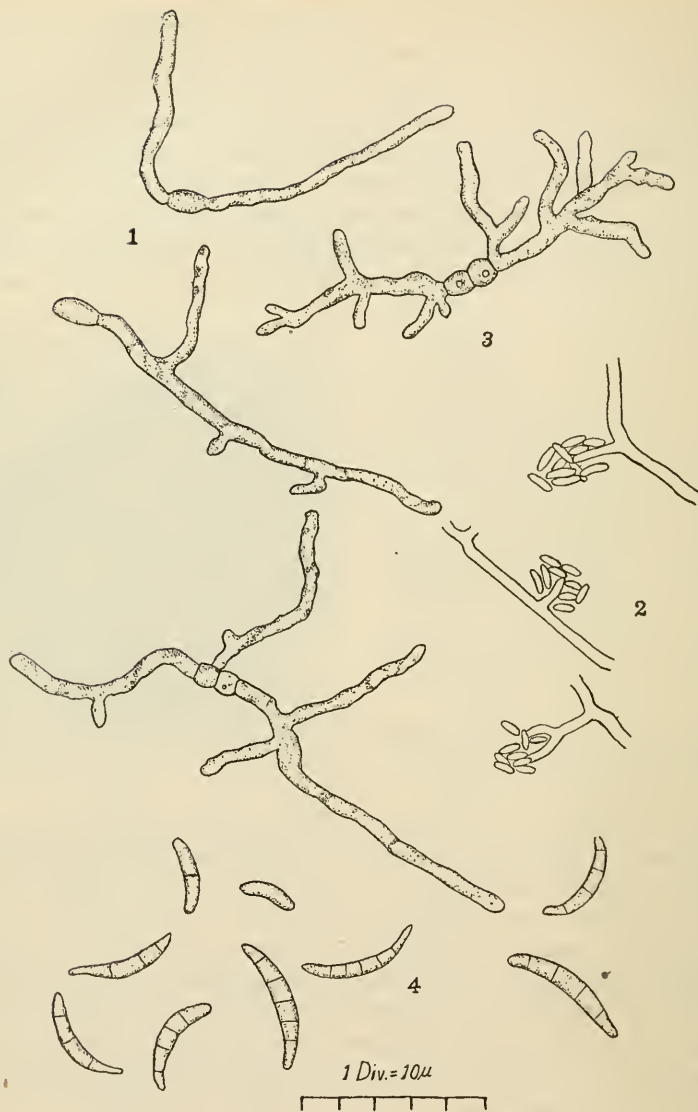

FIG. 110.—Violet leaf spot (*Fusarium violae*). 1, Germination of microconidiospores; 2, formation of microconidiospores in hanging drop cultures; 3, germination of macroconidia; 4, various forms of macroconidia. (After *Mycologia*, 2: 19-21, pl. xviii, January, 1910).

especially wilt diseases. *Fusarium oxysporum* and *T. trichorthecoides* can produce both tuber rot and wilt of the potato plant. *Fusarium violæ* causes violet leaf spot (Fig. 110). *Fusarium batatatis* is responsible for sweet potato stem rot (Figs. 108 and 109).

The sterile fungus *Rhizoctonia*, represented in America by two parasitic species *Rhizoctonia solani*, which is found on at least 165 different hosts, and *R. crocorum* with a limited distribution on alfalfa and potato tubers has through the discoveries of Rolfs and Burt been connected with a basidiomycetous fungus, *Corticium vagum* var. *solani*.¹

¹ PELTIER, GEORGE L.: Parasitic Rhizoctonias in America. Bull, 189, Agri. Exper. Stat. University of Illinois, June, 1916.

PART II

GENERAL PLANT PATHOLOGY

CHAPTER XXIII

GENERAL CONSIDERATION OF PLANT DISEASES

The student who would become acquainted with the general pathology of plants must have some previous knowledge of other subjects, especially those which are concerned with the life of the plant. To appreciate diseased conditions the normal state of the plant must be understood. A study of phytopathology, which as a department of scientific inquiry concerns itself with plant diseases, therefore, presupposes that the would-be phytopathologist is acquainted with plant morphology, systematic botany (fungi and flowering plants) histology, cytology, embryology, genetics, physiology, with bacteriology, zoology (especially entomology) chemistry and physics,¹ as well as meteorology. Plant morphology deals with the general form and gross structure of plant parts, such as roots, stems, leaves, flowers, fruits and seeds. The student should know the common fungi (see part I), the technique of their study (see part IV), as well as the flowering plants, which act as hosts to the bacteria and fungi causing disease. Histology is concerned with the microscopic details of plants, while cytology treats of cell structure and organization. Embryology, as a distinct subject of inquiry, embraces a study of their productive cells and organs. Genetics is a new branch of inquiry. As Walter tersely put it, "The study of the origin of the individual, which has grown out of the more general consideration of the origin of species, forms the subject matter of heredity, or, to use the more definitive word of Bateson, of genetics." The functions of a plant are considered when we study physiology and the chief divisions of that subject treat of the nutrition, growth and

¹ Along these lines see suggestive papers by ERNEST SHAW REYNOLDS: *Plant Pathology in its Relations to other Sciences*. *Science*, new ser., xxvii: 937-940; June 19, 1908.

irritability of the living plant organisms. A knowledge of insect life is essential, as also the chemistry of the plant, of the soils, of the fertilizers, of the insecticides and fungicides. The physics of sap ascent, of osmosis, of turgescence, and of the soil must be studied.¹

The investigation of malformed organs and cells may be classified under the head of Pathologic Morphology, and if the microscope is used, it may include Pathologic Histology and Pathologic Cytology. Disturbed conditions of the reproductive cells and organs bring about anomalies in the offspring, so that genetically speaking freaks, bizarre forms, or chimeras arise. Diseased conditions may be traceable to disturbed nutrition, to excessive or retarded growth and to abnormal irritability. Therefore to be a successful pathologist, one must be a good morphologist, histologist, geneticist and physiologist.

Phytopathology is that phase of botanic inquiry which treats of the diseases of plants. Its history dates from about 1850. Disease may be looked upon as an unwholesome condition, derangement of, perversion of, or departure from the normal in structure, in function, or in both combined. It is a morbid state. One who studies phytopathology is concerned with the characteristic symptoms of disease (Symptomatology), the interpretation of symptoms (Diagnosis), with the causes of diseases (Etiology) and with the remedies (Therapeutics) and prevention of disease (Prophylaxis). Recently considerable attention has been given prophylaxis, following out the old adage that an ounce of prevention is worth a pound of cure. Curative agents are therapeutic agents.

ETIOLOGY.—At the outset it is important to consider the causes of disease. These may be considered under two heads, predisposing and determining.

PREDISPOSING CAUSES OF DISEASE.—The normal plant can to a certain extent ward off the attack of disease, but the power to do so varies within wide limits, which may be conditioned upon racial, or individual characteristics of resistance. The degree of this resistance determines the degree of the immunity of the plant organism. It is well known that the normal constitution of plants varies considerably in individuals of the same variety and among different races and varieties of the same species. Some individuals and varieties are constitutionally weak, others are strong and resistant to external influences of every descrip-

¹ APPEL, O.: The Relations between Scientific Botany and Phytopathology. *Annals Mo. Bot. Gard.*, 2: 275-285, February, April, 1915.

- WHITE, EDWARD A.: Second Report on the Hymeniales of Connecticut. Bull. 15, State Geological and Natural History Survey, 1910, pp. 70, pls. 28.
- WHITE, V. S.: The Tylostomaceæ of North America. Bull. Torr. Bot. Club, 28: 421-444, August, 1901.
- YATES, HARRY S.: The Comparative Histology of Certain California Boletaceæ. University of California Publications in Botany, 6: 221-274, pls. 21-25, Feb. 25, 1916.

CHAPTER XXII

FUNGI IMPERFECTI (DEUTEROMYCETES)

The life histories of the fungi belonging to this group are imperfectly known, and hence, it happens that when it has been established, the type is removed from the fungi imperfecti and properly classified with some other group. The name DEUTEROMYCETES, also applied to the imperfect fungi, is derived from the Greek, *δευτερος* = second. Many important parasites are included here, and hence, it has been considered important by mycologists to give the characters by which the fungi imperfecti are distinguished.

General Characters.—The mycelium consists of septate, hyaline, or pigmented hyphæ, or only of chain of yeast-like cells. The hyphæ are diffuse, or plectenchymatous (*πλεκτὸς* = woven). Stromata are frequently present. The fructification is a single conidiophore, a layer of conidiophores, or a conidial fructification (pycnidium). The Fungi Imperfecti represent the accessory fruit forms of the ASCOMYCETALES, rarely those of other orders. The mycelium is practically the same as found in the sac fungi. The septate hyphæ spread over the substratum, or penetrate its interior, and the fungi live saprophytically, or parasitically. The arrangement of the hyphæ in various ways has suggested the segregation of species and genera. The under layer (subiculum = felted stratum of hyphæ) is of loose, entangled threads, or disc-like bodies, or radially stretching fibrils, aggregated loosely. The stroma on the contrary represents compact tissue, corresponding to similarly named structures in the ASCOMYCETALES. The fruit layer originates in or on the stroma.

Reproduction is dependent on exogenously produced spores, known as conidiospores. In the simplest cases, the mycelium gives rise at indefinite places to outgrowths, which are separated as spores. There arise from the mycelium, erect conidiophores which form conidiospores in the different species. With an unbranched conidiophore, the conidiospores arise at its apex followed by a second, a third, etc. When the end of the conidiophore is globular, the spores arise on the ends of sterigma. By the branching of the conidiophores originate conidial

tion. Such plants are designated as cast-iron, or hardy, while the others are tender and need constant care and attention on the part of the cultivator. Such weakness of constitution, of histologic structure, or absence of protecting chemical bodies in the cells of the plant may be looked upon, other things being equal, as predisposing causes of diseases. Such depend on the hereditary character of the plant, and in case of varieties susceptible to disease may be designated hereditary predisposition. Immunity, on the other hand, may be hereditary, as in the case of the plants of strong constitution, or acquired. Resistance on the part of certain plants may be due to the hereditary resistance of the protoplasm, it may be due to histologic structure, such as the presence of a thick cuticle in the resistant form and its absence in the susceptible form, for Sorauer has found that the resistance of different carnations was due to the thickness of the cuticle. The habit of earliness, or lateness, may be the determining factor in resistance. A late variety might be attacked, because of its growth in relation to the life history of some insect, or fungous parasite, while for this reason an early variety might remain healthy. Morphologic peculiarities may be effective, for the investigations of Hecke and Brefeld have shown that in the varieties of wheat with closed flowers, and which are close pollinated, therefore, the spores of the loose smut fungus carried by the wind are unable to reach the stigmas, and hence, infection does not take place. Such varieties would be smut proof for the simple morphologic reason that their stigmas are not exposed to the smut spores. Osterwalder has indicated that varieties of pears without an open channel from the calyx to the carpels are protected against infection by *Fusarium putrefaciens*, while those varieties with an open channel from calyx to the carpels are susceptible. The habit of a plant, as to drying after a rain, may influence its disease resistance, as shown by Appel.¹ Infection of potatoes by the spores of late blight, *Phytophthora infestans*, is due to the wind carrying the spores to healthy plants where in the raindrops on the surface of the leaves zoospores are formed.

The leaves of some varieties dry within half an hour after a rain, while on others the leaves do not dry for several hours. Quick-drying varieties are less susceptible than the slow-drying ones. In some members of the pea family, the seeds are imbedded in a woolly outgrowth of

¹ APPEL, O.: Disease Resistance in Plants. Science, New ser., xli: 773-782, May 28, 1915.

the inner epidermis of the pod. It has been found that infection of the seeds with *Ascochyta pisi* is facilitated by the presence of the hairs, for the fungus grows, as in a culture medium, and infects every seed, while in the hairless forms infection takes place only where the seed actually touches the infected spot of the pod.

The presence of certain chemic substances may explain immunity, for the disease resistance of *Vaccinium vitis idæa* is supposed to be due to the presence of benzoic acid. So, too, the presence of tannins may increase the power of resistance to fungus and insect diseases, as indicated by Cook and Taubenhau.¹ Enzymes also play an important rôle in the production of chemic substances, which increase disease resistance. Such hereditary disease resistance may be made to play an important part by breeding and growing the varieties which have been proved to be disease resistant.

Immunity may be acquired by growing the susceptible form at a different season of the year from its accustomed one. Grafting has been used with success. The method is to graft a non-resistant variety on a resistant one, as in the case of the European vine on the American vine, which resists the attack of the Phylloxera insect, which devastated the European vineyards until this method was adopted. Crossing has been resorted to as a second means of increasing disease resistance. The weak variety is crossed with a disease resistant form to increase its immunity. The third way to obtain immune forms is to select resistant individuals and from them breed pure strains. This has been accomplished with some degree of success by Orton with cotton, by Bolley with flax, by L. R. Jones with cabbage. It should be emphasized that the inheritance of the unit characters and their behavior in the next generation is one of the fundamentals of breeding resistant races.

Determining Causes.—Having considered the general reasons for the predisposition of plants to diseases and the immunity of others, it is important to describe next the causes which determine disease. These may be divided into those of external origin and those of internal. The external factors of disease are the chemical conditions of the soil, as a determining cause, also the physical character of the soil. The influence of a superabundance of water, or its absence, is important. Cli-

¹ COOK, MEL T. AND TAUBENHAUS, J. J.: The Relation of Parasitic Fungi to the Contents of the Cells of the Host Plants. 1. The Toxicity of Tannin, Bull. 91, Delaware College Agric. Exper. Stat., Feb. 1, 1911.

matic and meteorologic conditions may be influential, when these disturb the normal life of the plant. Light, heat, cold, rain, dew, hail, frost, wind and lightning play an important rôle. The gaseous emanations from gas pipes, smelter works, smokestacks, including soot, dust from cement works, acids, poisons, and dye stuffs, which pollute streams, all are determining causes of disease. Traumatism or mechanic injury may be of various sorts and the effects are dependent upon the form and severity of the injury, or wound.

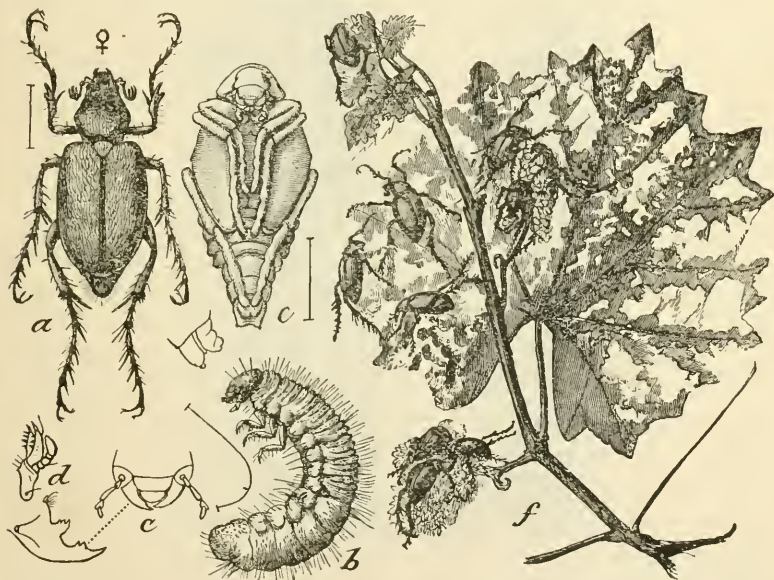

FIG. 111.—Rose-chaffer (*Macrodactylis subspinosus*). *a*, Adult or beetle; *b*, larva; *c*, *d*, mouth parts of same; *e*, pupa, *f*, injury to leaves and blossoms of grape with beetles at work. (From Marlatt in Quaintance, A. L. and Shear, C. L., *U. S. Farmers' Bull.* 284, 1907.)

Living organisms, whether animal or vegetal, may be the cause of disease. All groups of animals may be considered, but the mammals, worms and insects (Fig. 111) are of most importance and interest. Insect depredations of plants are notorious and insects occupy first place in their destructive effects on plants (Fig. 112). Various parasitic flowering plants are known, as well, as the bacteria and fungi, for their disease-producing powers.

As an internal determining cause, the formation of enzymes under abnormal conditions must be reckoned as causal, as well, as nutritive disturbances which produce monstrosities and the like.

Having classified the chief causes of disease, a more detailed description of these factors should be put in a form available for student use. Much of the information is scattered, and part of it is buried in foreign botanic and pathologic journals, which can be consulted only in the largest scientific libraries at home and abroad.

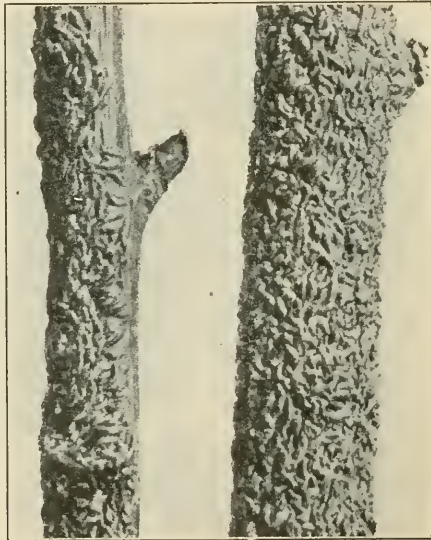

FIG. 112.—Oyster-shell scale (*Lepidosaphes ulmi*. After Quaintance, A. L., U. S. Farmers' Bull. 723, Apr. 26, 1916.

The chemic condition of the soil, as a determining cause of disease, may be considered from the standpoint of the normal influence of the important soil ingredients, as contrasted with the absence or deficiency of such elements. Potassium is usually found in young tissues and disappears in the older ones. It is associated in some way with the formation of carbohydrates in the plant such as starch, sugar and cellulose. The absence of potassium in the soil causes a cessation of growth, the leaves fail to develop the power of forming starch within the green coloring bodies, or chloroplasts. A plant which has failed to grow for months will recover in a few days after potassium salts have been added

and after a few hours the formation of starch in the chloroplasts will be detected.¹ The storage of reserve materials is, therefore, inhibited, and one finds in such plants, as the cereals, that the formation of green parts is at the expense of the grain, and in the beet, the vegetative part of the plant is at the expense of the fleshy roots. Potassium hunger causes in the potato and buckwheat a shortening of the internodes and a convex bending of the leaf blades, which are spotted with yellow blotches. Calcium is abundant in nature in the form of the carbonate which forms the rocks known as marble and limestone. It is chiefly concerned in the strengthening of the cell wall, where in such plants as *Chara* it is deposited. It plays an important rôle in fixing the calcium oxalate formed in the metabolism of the plant. Ecologists in Europe classify many plants either as calciphile (calcium-requiring), or calciphobe (calcium-hating). The application of calcium to soils under certain conditions promotes apparently the disease of beets called heart- or dry rot. The chlorosis, or icterus, of the grape vine seems to be increased in soils with a high calcium content. The accumulation of oxalic acid in the absence of its fixation by calcium poisons the plant. The formation of brown blotches on leaves, the yellowing, or browning of pine needles, the death of the root tips of water plants is associated with the absence of calcium.

Magnesium is chemically allied to calcium, but it cannot replace calcium in the economy of the plant. It apparently works together with nitrogen in the formation of protoplasm, and has an influence in the formation of chlorophyll, for plants grown without magnesium have yellowish-green chloroplasts, and new cell formation does not proceed readily. The absence of magnesium is shown in the pale-green color of the chloroplasts, the yellow to orange-yellow blotches on the leaves, and the brown spots on the stems. The amount of starch formed by the chloroplasts is reduced, the internodes are shortened, the young leaves do not unfold. These are symptoms associated with a deprivation of magnesium.

Iron is necessary in the formation of chlorophyll, for if the plant is grown in an iron-free solution, it remains permanently etiolated (blanched). The diseased condition which arises through the lack of the requisite amount of iron is called chlorosis. Too much iron in the soil acts poisonously.

¹HARTWELL, B. L.: Bull. 165, R. I. Agric. Exper. Stat., May, 1916.

Sulphur and phosphorus are of some value in the production of albuminous substances by the plant, and in the soil they exist mainly as calcium sulphate and calcium phosphate. Phosphorus is in some way associated with the formation of the crystalloids, globoids and aleurone grains of the plant. Some soils are poor in phosphorus, so that the agriculturist must supply phosphates. The deficiency of phosphorus is seen in the production of a red coloration in plants. The leaves are blotched with red and later the spots become dark brown. The formation of flowers and seeds is partially inhibited. The absence of sulphur is manifest in the poor development of the whole plant and in the reduction in the amount of fruit produced.

Nitrogen enters largely into the living substance of the plant, protoplasm. It is stored in the form of protein granules and aleurone grains. In the life of the plant, it is concerned in the building of young tissues, and in the metabolism of plants, it appears in the form of asparagin which in the soluble state is conducted through the bast portions of the vascular bundles from one part of the plant to another part. Some plants have a peculiar relationship to nitrogen. Such are the leguminous plants, which are provided with root nodules, where there are nests of bacteria. These bacteria can utilize free atmospheric nitrogen and later in the involution form as bacteroids, they are absorbed by the green plant which is thus enriched with nitrogen. During the period of entrance of bacteria into the root hairs, the young seedling goes through a period of nitrogen starvation, when it appears to flag, but later, it regains its active growth and vitality when the nodules have been formed. Contrasted with the same leguminous species without nodules and when the root systems alone take up nitrogen in the form of nitrates, the nodulated plant is larger and stronger in every respect.

A deficiency of nitrogen in the soil can be detected in the case of Indian corn and other agricultural plants by a general paling of the green color, so that in some cases the plant becomes yellowish-green. Klebahn¹ indicates that the leaves of beets, buckwheat and potatoes assume a yellowish color with a deficiency of nitrogen, and as the leaves dry, they become yellowish-brown. The prothallia of ferns in a nitrogen-free nutritive solution do not form meristem or archegonia. Excessive supplies of nitrates in their application to cultivated fields stimu-

¹ KLEBAHN, PROF. D. H.: *Grundzüge der Allgemeinen Phytopathologie*, 1912: 11.

lates in the case of the crops grown upon such fields the development of the vegetative organs and, therefore, delays the formation of flowers and fruit and the ripening of seeds. Such delay may mean the attack of parasitic fungi. For example, a large field of winter wheat which had been sown about the end of October was much attacked by stinking smut (60 per cent.), while the adjacent fields belonging to the same farmer, under the same variety of wheat and treated in a similar manner, but sown early in October showed no sign of infection. With fruit trees, one notices greater frost susceptibility in those plants which have received an excessive nitrogen supply. Lipman (*Science*, new ser. xxxix: 728-730, May 15, 1914) has suggested that the poor nitrifying power of soils is a possible cause of "die-back" (exanthema) in lemons. It has been a serious disease with the citrus growers of Florida and California.

Physical Character of the Soil.—The physical character of the soil is of great importance as a determining cause of disease. When we speak of the physical character of the soil, we refer to the size of its particles, the relation of these particles to each other, the presence of colloidal bodies, the presence of air spaces associated with the air content, the distribution of the water through the soil, the presence or absence of organic matter, or humus, the color and temperature of the soil. Of greatest importance to the life of the plant is the water which is available for the needs of the plant.¹ A too plentiful supply of water causes the formation of a wet ball of roots with the formation of alcohol. Frequently gardeners fearing that the soil is dry, water potted plants with more water than the plants actually need, so that the lower part of the soil is continuously saturated with water. Alcohol is formed and decay of the roots sets in, because they are gradually suffocated. Too little water on the other hand causes a drooping or wilting of the plant, and if water is not supplied in time permanent wilting and death of the foliage results. But a diminished water supply may be decidedly beneficial to plants, as it has been found that the formation of flower buds is best initiated by preserving a period of rest following a diminished water supply. Different plants have different water requirements and these requirements vary with the season of the year and the development of

¹ Cf. SORAUER, PAUL, LINDAU, G. AND REH, L., transl. by DORRANCE, FRANCES: *Manual of Plant Diseases*, vol. i, parts 1 and 2.

the plant. As an illustration of this may be cited the planting of the Carolina poplar on the open porous sandy soils of New Jersey. About Philadelphia, where the tree is largely planted, it grows rapidly with a dense crown of dark-green, foliage leaves. In New Jersey, it grows less rapidly, its crown is more open by a wider spacing of the branches and the leaves have a greenish-yellow appearance and drop off earlier in the autumn than similar trees on the Pennsylvania side of the Delaware River. This difference is without doubt associated with the water requirements of the tree, for on the Pennsylvania soils, it can secure abundance of water during the growing season, while in the New Jersey sands, owing to their porosity and the rapid drainage of water through them, the Carolina poplar does not receive sufficient amounts of water for its most vigorous growth.

The experiments of Münch¹ throw important light on the content of water and air in the tissues as a determining factor of disease of woody plants, such as on forest and fruit trees. He has shown that the greater number of the wood-destroying fungi require a large amount of air and are able to grow only when a maximum amount is present. The air content of the tissues is dependent on the water supply and trees with narrow annual rings are more resistant than those with broad ones, because the former contain more water and less air relatively. Different annual rings of the same tree may be attacked differently.

The decayed rings of wood in such trees are always the broad ones. The tissues of vigorous branches are rich in water and poor in air and infections do not always penetrate to such regions. The healthy bark of beech trees in winter-rest contains 19 to 20 per cent. of air and at the time of budding the air diminishes to 11 per cent., rising afterwards. This is correlated with the canker disease, *Nectria ditissima*, which in Europe does its damage during the winter months, while during the vegetative period it ceases. Hence, we have opened here a very profitable line of investigation to determine the relative amounts of air and water with respect to immunity, or its absence. Again, in the irrigated districts of America, the fruit trees have only a few diseases due to species of *Valsa* and other species of fungi. Defective irrigation may bring about the prevalence of the die-back diseases, which may be reme-

¹ MÜNCH, E.: Untersuchungen über Immunität und Krankheitsempfänglichkeit der Holzpflanzen. Naturwiss. Zeitsch. f. Forst. und Landw., 7: 54-75, 87-114, 129-160, 1909; APPEL, O.: Phytopathology & Scientific Botany, *loc. cit.*

died by changing the system of irrigation. The land should be irrigated at the time when the trees contain small amounts of water and much air, so as to prevent an excessive decrease of water in the tissues.

The condition of the humus has a rather remarkable influence on the growth of plants. Ericaceous plants, such as the trailing arbutus (*Epigæa repens*), wintergreen (*Gaultheria procumbens*), bearberry (*Arctostaphylos uva-ursi*), blueberry (*Vaccinium corymbosum*) flourish in an acid humus and if the attempt is made to grow such plants under other conditions, they languish and die. Other species like Indian turnip (*Arisæma triphylla*), blood root (*Sanguinaria canadensis*), rue anemone (*Anemonella thalictroides*) grow best in a leaf-mould humus which is neutral or slightly alkaline. Reverse the reaction of the soils about these plants and they gradually die.

The presence of an impervious hard pan below the surface soil is a condition which prevents the normal development of trees, as I have shown in my book on the "Pine Barren Vegetation of New Jersey," where in the region known as the Plains, the pitch-pine trees are kept dwarf owing to an impervious subsoil layer. There the trees flourish for a number of years, then begin to suffer until unable to penetrate the deeper layers of the soil, they finally succumb to be replaced by younger trees which meet the same fate.

CLIMATIC AND METEOROLOGIC FACTORS.—The most important climatic factors, which may be looked upon as in any way related to disease production, are light, heat, precipitation (rain, dew, frost, snow, hail and ice) wind and electricity (lightning, etc.).

Light is essential for the life functions of all green plants. Carbon dioxide and water are united by the energy of sunlight to form starch. The synthesis takes place in the chloroplast, starch being formed as the first visible product. Ordinary sunlight of a bright, clear day may under certain conditions of plant growth be too intense and it acts prejudicially. The writer has frequently noted, that garden plants suffer, if after a wet, cloudy spell during the rapid period of growth, they are exposed to a bright sun without protection. It takes a few days of bright light to sun-harden the plants. Trees, especially with a smooth bark, which have grown in a very dense wood, and then suddenly isolated in later life, suffer from scorching of the cortex. They are sunburned. Plants grown in greenhouses, which have been painted with whitewash to reduce the intensity of the rays of light, have

their leaves burned if part of the whitewash is removed. The light passes through the opening thus made and the leaves on which it is concentrated are scorched.

Several diseases of plants are caused by too brilliant sunlight. Such are sunscald, sunscorch and bronzing.¹ Sunscald may follow as a result of too intensive sunlight, as, for example, when certain fruit trees are stripped of their foliage in summer, such as sometimes results from the ravages of the gypsy moth. In such instances the new unripened wood sunscalds badly. Sometimes it is associated with severe and abrupt changes in temperature on non-ripened wood. "Sunscorch" is a term applied to the burning of foliage in summer during periods when the soil is dry, and is also common to evergreens during warm windy days in spring before the frost is out of the ground. Any defects in the root system which prevent root absorption may cause sunscorch. "Bronzing" of leaves is a form of sun scorch characterized by the occurrence of a reddish-brown or bronze color of the leaf. It is caused by a lack of soil moisture, or defective root absorption during dry, hot periods.

Too much shade is also detrimental to plants, as is seen under the dense canopy of beech trees on a lawn, where nothing will grow, not even a blade of grass. The grasses, etc., die of inanition. The condition known as etiolation originates where a plant is grown in the dark, or in subdued sunlight. Growth in darkness leads to important modifications in the general habit and structure of a plant. If we take a potato plant and raise it in the dark, we find the etiolated shoot has a white stem and leaves which are at first pinkish, and subsequently pale yellow, and the absence of chlorophyll is noteworthy. The internodes are long and slender and the leaves are small compared with the green plant and there are corresponding anatomic differences. Morning glories raised in greenhouses in the winter do not twine. They grow from four to five inches tall and have only one to two flowers.

Heat as a factor in the growth of plants is well known. Each plant has its minimum, maximum and optimum degree of heat. The distribution of plants over the larger stretches of the earth's surface is associated with the amount of heat that the different plants receive. The absence of heat, where the plant is exposed to a temperature below

¹ STONE, GEORGE E.: Injury to Vegetation Resulting from Climatic Conditions. Monthly Weather Review, 44: 569-570, October, 1916.

freezing, is noteworthy. The death of cells rich in water, when exposed to low temperatures, seems to depend upon the conversion of the water extruded into the intercellular spaces into ice. The parenchymatous tissues are ruptured and crystals of ice are formed. The water, therefore, which is in the cell reaches the surface and the cell sap diminishes in amount and there may be chemic changes in the cell as a result of freezing, for in some cases the leaves assume a leathery brown color. Long exposure to cold may lead to the actual disorganization of the protoplasm. It, however, does not always follow that the formation of ice in the intercellular spaces necessarily involves death. Slow thawing may be followed by a return of the water to the cells until the normal equilibrium is restored and the cells continue to live. A rapid thawing, however, causes death of the cells, because the water is not reabsorbed. Frost-killed twigs and branches are more susceptible to the entrance of saprophytic fungi such as species of *Nectria*, *Dasy-scypha*, and *Valsa*. The exposure of roots during a snowless winter may lead to their disturbance by freezing. The anatomic changes induced by freezing are frost blisters, such as appear on the leaves of fruit trees and cereals, and frost cracks, which may ultimately heal over, producing an external ridge or enlargement. The fruit-grower can distinguish four kinds of winter injury to his trees. First, the frosting of the blossoms after they begin to open; second, the freezing of the buds in winter; third, the freezing of the twigs and branches; fourth, root freezing. It may happen that early in the spring the peach trees come into bloom. Then on a cold cloudless night with no wind the temperature sinks below freezing and the partially open flower buds are nipped by the frost. About twenty years ago the upper Mississippi Valley was visited by an unusual cold wave. The frost penetrated to great depths and the cold was so intense that the tree roots were actually frozen in the soil.¹

The formation of ice fringes upon plants has been investigated exhaustively by Coblentz,² with the dittany, *Cunila mariana*. He

¹ Consult WAUGH, FRANK A.: Jack Frost's Tricks. The Country Gentleman, Feb. 6, 1915, p. 213. WILSON, WILFORD M.: Frosts in New York. Bull. 316, Cornell University Agri. Exper. Stat., June, 1912. CHANDLER, W.H.: The Killing of Plant Tissue by Low Temperatures. Research Bull. 8, Coll. of Agric., Univ. of Mo., Dec., 1913.

² COBLENTZ, WM. W.: The Exudation of Ice from Stems of Plants. Monthly Weather Review, 42: 490-499, August, 1914.

found that the ice fringes are formed when the temperature falls to freezing. They are formed on the outer surface of the plant. The growth of the ice fringe ceases when the ground is frozen to a depth of 2 to 3 cm. and when the moisture in the stem is frozen. The dimensions of the fringe depend upon the rate of evaporation of water from the stem up which it rises by capillary action and upon the amount of moisture in the ground. Clouds and fogs in some regions have an important effect on vegetation.¹ The two forms of foliage leaves on the branches of the redwoods of California are conditioned upon the height of the fogs which drift in from the Pacific Ocean. The leaves on the fog-exposed branches are flat and divergent, while those on the sun-exposed branches above the fog level are scale-like and appressed. The London fogs work detrimentally to outdoor and greenhouse plants, and in Egypt, the cotton capsules long exposed to fog are more infested with black moulds. Dew, which lodges on the margins of leaves, is responsible for the entrance of fungi by their spores lodging in the dewdrops and germinating there.

The weight of snow and ice breaks off the limbs of trees, breaks down herbaceous plants, and this opens up the way for the entrance of various parasitic fungi. Ice or sleet storms are especially severe at times to trees. The year 1902 was noted for two exceptionally destructive ice storms which visited the Philadelphia region. One of these storms occurred on Friday, Feb. 21, and the other on Saturday, Dec. 13.² The storm of Feb. 21 was accompanied by high winds and did an irreparable damage to the fruit, forest and shade trees. Meteorologically speaking, regions of strongly variable temperature are subject to occasional winter storms in which the precipitation occurring as rain, freezes as soon as it touches any solid body, such as the branches of trees, telegraph wires or the ground. This happens when the ground and the lower air have been made excessively cold during a spell of clear anticyclonic weather, when a moist upper current in advance of an approaching cyclone brings clouds and rain. All our meteorologists prefer to call such storms ice storms; locally near Philadelphia they are denominated sleet storms. The weight of ice which such limbs carry is astounding.

¹ WEISS, F. E., IMMS, A. D., ROBINSON, W.: *Plants in Health and Disease*, 1916; 54-56.

² HARSHBERGER, JOHN W.: *Relation of Ice Storms to Trees*. *Contrib. Bot. Lab. Univ. of Penna.*, II: 345-349, 1904.

The author found the weight of a branch of *Liriodendron tulipifera* with ice upon it to be 50 grams, without ice 9 grams; so that the ice weighed 41 grams, giving a ratio of 1:4.5. *Juniperus virginiana* with its ice load weighed 310 grams, without ice 13 grams, making the weight of ice 297, a ratio of 1:23. Beginning with Dec. 5, 1914, a combination rain, snow and ice storm swept across the Eastern States doing much

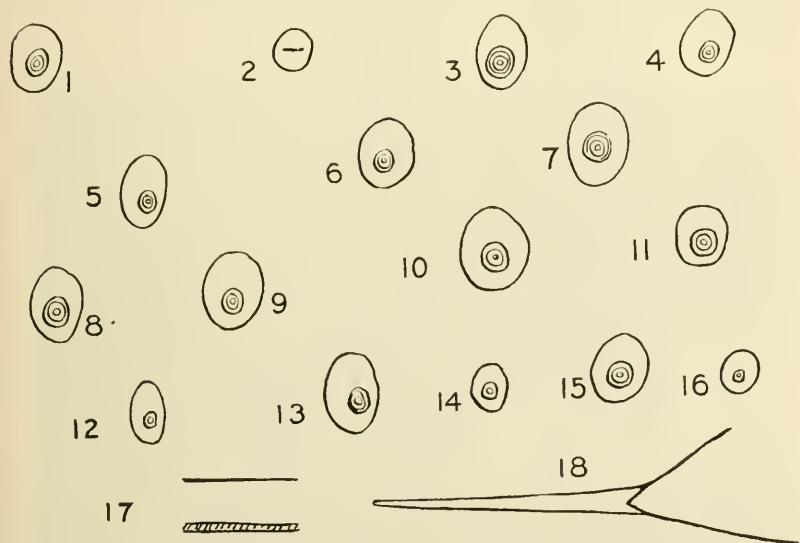

FIG. 113.—Sectional view of twigs and leaves of various plants showing load of ice carried during the ice storm of Feb. 12 and 13, 1916. 1, *Acer platanoides*; 2, blade of grass; 3, *Chionanthus virginicus*; 4, *Diervilla florida*; 5, *Forsythia suspensa*; 6, *Ligustrum vulgare*; 7, *Liriodendron tulipifera*; 8, *Platanus orientalis*; 9, *Populus alba*; 10, *Populus deltoides*; 11, *Quercus palustris*; 12, *Syringa vulgaris*; 13, *Tilia americana*; 14, *Tecoma radicans*; 15, *Xanthoceras sorbifolia*; 16, *Spiraea Thunbergii*; 17, leaf of *Rhododendron maximum*; 18, icicle on tip of *Rhododendron maximum*, leaf hanging down.

local damage¹ and again on Friday, Dec. 31, a severe ice storm visited the mountain region of Pennsylvania contiguous to the Juniata Valley and Susquehanna River. During the afternoon of Saturday, Feb. 12, 1916, a cold rain began which continued well into the night, coating the pavements, streets, and trees with hard ice. On Sunday morning, Feb. 13, men, boys and girls took advantage of the icy streets to skate

¹ ILLICK, J. S.: A Destructive Snow and Ice Storm. *Forest Leaves*, xv: 103-107, February, 1916.

upon them and this unusual sight was stopped by a snow storm, which followed on Sunday morning. The trees were loaded to the breaking point. During the continuance of the storm, small branches were taken off thirteen trees and shrubs and a blade of grass growing in West Philadelphia, and the thickness of ice upon them measured with a pair of compasses. The accompanying figures drawn life size show the relative thickness of the load of ice borne by the twigs, whose thickness is shown in the drawings (Fig. 113).



FIG. 114.—Happy white elm, *Ulmus americana*, plentifully supplied with ground water near the surface in a depression of the glacial outwash plain at Westbury, L. I., July, 1915.

The fall of hail stones may, if they are large enough, cause the decortication of twigs, or the abrasion of other plant parts, thus permitting the entrance of destructive bacteria and fungi to the interior of the plants.

Wind is an active agent in the breaking off of buds and limbs and the formation of dangerous wounds. In such situations, as high mountains, sand dunes and rocky shores, where trees are exposed to the forcible action of the wind, they assume a windswept, bisected, or prostrate form, which is characteristic and picturesque (Fig. 16).



FIG. 115.—Unhappy vase-shaped white elm, *Ulmus americana*, 100 yards south of a happy larger elm both growing on the outwashed plain, Westbury, L. I., July, 1915.



FIG. 116.—Wind-swept white poplar, *Populus alba*, Nantucket, Mass., August, 1915.

Strong winds increase the amount of transpiration, so that frequently we find there is a balance established between the absorbing root system and the transpiring leaf system, so that the amount of foliage is determined accordingly. If the amount of water lost by transpiration exceeds the amount absorbed by the roots the plant usually succumbs. Happy trees are those in which the amount of water available exceeds the amount transpired, while unhappy trees are suffering physiologic drought through the action of the wind in moving water faster than it can be supplied (Figs. 114, 115, 116). Such trees are seen in planted specimens in Long Island, Nantucket and along our seacoasts. With tornadic winds, trees are uprooted in general and irreparable damage is done.

The effect of lightning is a marked one, as a determining factor in disease. Recently Jones and Gilbert¹ have published a paper on the lightning injury to potato and cotton plants. One case occurred in a field at Monetta, S. C. in the summer of 1913. The cotton plants were fully grown and after a severe electric storm on Aug. 3, all the cotton plants were killed over an area three rods in diameter. The leaves wilted, died and blackened, but remained attached to the plants. The most pronounced effect, however, was on the stem and root system. Other cases are cited of a similar nature in Europe and America.

The action of lightning on trees is variable. The tree may be scorched, it may be stripped of its leaves, it may be cleft longitudinally, or, more rarely, severed horizontally. Sometimes the bark is stripped from only one side, occasionally without a trace of burning: at other times, it may be riddled, as by worms, with a multitude of little holes. The lightning furrows may be single, double, oblique or spiral. If the tree is inflammable a fire may be started. Such tall trees, as the big trees of California, have been struck repeatedly by lightning and their leaders broken and their tops stunted as a consequence. From early times, there has been a current belief that certain trees attract the lightning, that others are not struck. The elder Pliny believed that "Light-

¹ JONES, L. R. AND GILBERT, W. W.: Lightning Injury to Potato and Cotton Plants. *Phytopathology*, 5: 94-101, with plate, April, 1915; JONES, L. R.: Lightning Injury to Kale. *Phytopathology*, 7: 140-142 with 1 fig., Apr., 1917; STONE, GEORGE E.: Electrical Injuries to Trees. *Bull.* 156, Mass. Agric. Exper. Stat., Oct., 1914.

ning never strikes the laurel." In certain parts of the United States, it is held that the beech tree is never struck.

"Avoid the oak, flee from the spruce, but seek the beech," yet in the Garden Magazine for January, 1916, is given a photograph and an account of a fine beech tree which was struck by lightning in Pennsylvania about the middle of June. Plummer¹ sums up his investigations on the relation of lightning and trees, as follows:

1. Trees are the objects most often struck by lightning because: (a) they are the most numerous of all objects; (b) as a part of the ground, they extend upward and shorten the distance to a cloud; (c) their spreading branches in the air and spreading roots in the ground present the ideal form for conducting an electrical discharge to the earth.

2. Any kind of tree is likely to be struck by lightning.

3. The greatest number struck in any locality will be of the dominant species.

4. The likelihood of a tree being struck by lightning is increased: (a) if it is taller than surrounding trees; (b) if it is isolated; (c) if it is upon high ground; (d) if it is well (deeply) rooted; (e) if it is the best conductor at the moment of the flash; that is, if temporary conditions, such as being wet by rain, transform it for the time from a poor conductor to a good one.

5. Lightning may bring about a forest fire by igniting the tree itself, or the humus at its base. Most forest fires caused by lightning probably start in the humus.

Experiments on the electric conductivity of various woods shows that this conductivity depends upon the water content of the wood. When absolutely dry none of the specimens showed conductivity, but the resistance of all was practically infinity.

Effect of Smoke, Soot, Gases and Smelter Fumes on Plants.—The smoke, which is destructive to vegetation under our modern conditions, is derived from four sources of supply: (1) smoke from manufacturing plants, or from large buildings; (2) smoke from special concerns, such as the electric power plants of electric trolley lines; (3) smoke from railroad locomotives; (4) smoke from the chimneys of dwelling houses. Smoke belts have been drawn by students of the problem to determine the area influenced by the smoke. From a survey made for the City

¹ PLUMMER, FRED G.: Lightning in Relation to Forest Fires. Bull. 111, U. S. Forest Service, 1912.

of Des Moines, Iowa, by A. L. Bakke,¹ it has been found that conifers are more susceptible than deciduous trees. The direct injury is seen in the deposit of the tarry matters of the smoke in the stomata of nearby plants; leaves and leaflets are shed, or assume abnormal shapes, and the formation of foodstuffs is hindered. The sulphur dioxide and acetylene as constituents of smoke act toxically upon the plant. The work which has been done in the United States may be summed up as follows: Burkhart states that injury from gases is the result of the chemical constituent of the smoke and is not due to the clogging of the stomata. The investigation of J. K. Haywood³ in the vicinity of the famous smelter at Anaconda, Mont., is of importance. He finds that trees are injured at a considerable distance; that very small amounts of SO₂ are toxic to plant growth; that water used for irrigation purposes often has sufficient copper in it to be toxic to plant growth and that certain trees, as the juniper, are more resistant than others.⁴ Officials of the Forest Service are watching with interest the developments in the matter of the fumes from copper smelters in the southern Appalachian Mountains. The service has been interested for years, but since the acquirement of land in that section under the Weeks law for forestry and watershed protection purposes, it has been felt that the destruction of forests by the action of the fumes should be stopped.

W. L. Hall, forest supervisor of the seventh forest district, has recently submitted to the bureau a report upon the subject. It seems that one or more of the purchase areas established in the southern Appalachians are endangered by the fumes, which are of a sulphuric nature.

¹ BAKKE, A. L.: The Effect of City Smoke on Vegetation: Bull. 145, Agric. Exper. Stat. Iowa State Coll. Agric. & Mech. Arts., October, 1913; The Effect of Smoke and Gases on Vegetation. Proc. Iowa Acad. Sci., xx: 169-187, with bibliography; also ANDERSON, PAUL J.: The Effect of Dust from Cement Mills in the Setting of Fruit. The Plant World, 17: 57-68, March, 1914.

² Die Beschädigung der Vegetation durch Rauch. Handbuch zur Erkennung und Beurteilung von Rauchschäden von PROFESSOR DR. E. HASELHOFF, Vorsteher der landwirtschaftlichen Versuchsstation in Marburg i. H., und PROFESSOR DR. G. LINDAU, Privatdozent der Botanik und Kustos am Kgl. Botanischen Garten in Dahlem. Mit 27 Textabb.

³ HAYWOOD, J. K.: Bull. 89, Bureau of Chem., U. S. Dept. Agric., 1905; Injury to Vegetation and Animal Life by Smelter Wastes. Bull. 113 revised, Bureau of Chem., U. S. Dept. Agric., 1910.

⁴ The Southern Lumberman, xxix: 27, Nov. 6, 1915.

The fumes are apt to destroy any vegetation within a radius of several miles of the southern copper smelters. They are also working destruction in the forests of Montana, California and other states. The action of the fumes is peculiar and variable. Some trees succumb quickly to their deadly effects, notably white pine. Other trees are more resistant, including spruce, it is said. Nor does the gas act uniformly. Its effects vary with topographic conditions. The fumes will travel long distances up a canyon or narrow valley, destroying the woods in it, but leaving trees uninjured on either side. Again, it is said, the sulphur fumes collect in globular form something like soap bubbles, and drift away, doing no damage until the globular mass disperses, sometimes at quite a distance. To a greater or less extent, forests at a distance of several miles from copper smelters may be damaged by the fumes.

It is admitted that the fumes can be controlled by condensation or consumption, but the commercial practicability of the process is the pending question. The fumes can be and are to a certain extent converted into sulphuric acid, but the smelter people claim that the market for this product is limited, and that it does not pay to produce more than a certain quantity of it, as an oversupply sends the price down, which would make it not worth while to control the fumes further.

Just now considerable trouble is being experienced in Tennessee and Georgia on account of the sulphur fumes from copper plants. In 1905 the State of Georgia took action against these companies, alleging that they permitted a discharge of gases, which destroyed vegetation, including forest trees, in that state. The companies were forced to install plants to utilize a considerable percentage of the sulphuric acid gas. These plants, however, have been unable to utilize a sufficient quantity of the gas, and last spring the supreme court decided to have a special expert ascertain the amount of gas released, and the amount which ought to be utilized in order to make the fumes harmless.

The time is close when the pathologist will have to take up this question of fume damage, since large sections of the Cherokee area are subject to such damage, and it is reported that the injury has extended to the Georgia area.

The injurious effect of illuminating gas and ethylene upon flowering carnations has been investigated by Crocker and Knight.¹ The best

¹ CROCKER AND KNIGHT: *Botanical Gazette*, 46: 256-276, 1906.

work in Italy has been done by Brizi, in England by Crowther and Ruston.¹ Recently in America J. F. Clevenger has published a bulletin (No. 7), on "Smoke Investigation" for the Mellon Institute of Industrial Research and School of Specific Industries, University of Pittsburgh, 1913, with plates showing the effect of the smoke on the structure of the woody specimens examined by him.

Illuminating gas absorbed by the soil from nearby gas pipes is injurious to trees and has frequently killed them outright, as instance a group of street trees in Merchantville, N. J., a few years ago, which were killed in this way, and for which the owner, Edwin C. Nevin, received damages from the gas company for \$1500, as a result of a successful lawsuit. All the ordinary gases used for lighting and heating are injurious and act much in the same way. Such are water gas, coal gas, gasoline, acetylene and others. The first effects of gas poisoning, may be seen in the foliage. The leaves turn yellow and in some cases drop off, while the leaves of other trees fall while still green. The water containing the gas in solution passes into the stem and the wood and the cambial portion becomes abnormal. The underlying tissues, cortex, bast and cambium die. Soon various species of fungi gain access to the tree and cause its decay. With the Carolina poplar especially, the bark, cortex, etc., on the trunk towards the source of absorption showed three or four vertical cracks, or lesions, one-half to two and a half feet long. The bark on the sides of these cracks bulged out considerably, and an investigation showed a thick layer of soft parenchymatous tissue extending to the wood and derived from the cambium zone. Later this tissue turned brown, disintegrated and became slimy in appearance, the slime exuding from the cracks. Illuminating gas dissolved in water in which willow cuttings were kept stimulated the opening of the foliage buds several days earlier than plants grown in water not charged with the gas. Stone² found that the effect of gas on lenticels was to increase their size, especially under water charged with the gas. This appears to be a general response on the part of the plant tissue to a demand for oxygen.

That the trees, shrubs and flowering plants in our large cities and

¹ Journal of Agricultural Science, 4: 25, 1911.

² STONE, G. E.: Effects of Illuminating Gas on Vegetation; 25th Annual Rep. Mass. Agric. Exper. Stat., January, 1913; Shade Trees, Characteristics, Adaptation, Diseases and Care. Bull. 170, Mass. Agric. Exper. Stat., Sept., 1916, p. 220.

in the country along our trunk-line railroads are subjected to conditions which cause unhealthy growth and disease has been proven abundantly. Large factories, power plants and railroad locomotives are pouring out volumes of smoke, which alone is highly injurious, but in addition the acid which is formed in the combustion of coal, when dissolved in rain water, has injurious effect upon foliage and other plant parts. Its action is seen in the corrosion of tin roofs, rain pipes and ornamental iron work about city houses.

The following note is of interest to the plant pathologist and plant physiologist.¹ During the night of Sept. 19, 1913, a light rain fell, followed by a fine drizzle in the early morning of Sept. 20. The wide-open campanulate flowers of the common morning glory (*Ipomœa purpurea* Roth), growing on a lot in West Philadelphia, four or five blocks from the Pennsylvania Railroad, had their usual quota of raindrops studded over the upper, inner surface of the purple corollas. Wherever the drops touched the surface of the corolla, the purple color was changed to a pinkish red, and in the process of evaporation of the raindrops the acid of the drops was concentrated, so that after the complete disappearance of the drops a brown spot was left in the center of the pinkish red circles of discoloration. The explanation of the alteration of color is found in the change of the sap of the corolla cells, where touched by the acid raindrops, from an alkaline to an acid reaction. A similar change can be induced in blue violet petals by bruising them slightly and placing them in an acid liquid. The petals change, like blue alkaline litmus paper, from blue to red, and this reaction with violet petals has proved useful in the physiologic laboratory in the absence of litmus paper. In nature a reverse change, which illustrates the same chemic principle, takes place in many flowers of plants belonging to the family Boraginaceæ. For example, in *Symphytum* and *Mertensia*, the red flower buds, the cells of which have an acid cell sap, gradually change to blue as the flowers open. That this is a chemic change is proved by treating the red buds with an alkaline fluid and the blue flowers with an acid one.

Similar spotting, but less clearly discernible and demonstrable, as the delicate reaction with morning-glory flowers, undoubtedly occurs on leaves and fruits, and the suggestion is made here, that such spots

¹ HARSHBERGER, JOHN W.: The Acid Spotting of Morning Glories by City Rain. Science, new ser., xxxviii: 548, Oct. 17, 1913.

caused by the acidity of raindrops serve repeatedly as the points of entry of parasitic fungi, for there are many leaf spots and fruit spots that show concentric rings of diseased tissue in the earliest lesions produced. A fungus, which is stimulated to growth by an acid condition of the cell sap, would find ideal conditions for the commencement of growth by entering areas influenced by acid raindrops.

TRAUMATISM.—Traumatism, or mechanic injury, may be of various sorts and the effects are dependent upon the form and severity of the injury. Mechanic injury to the plant usually takes the form of wounds, which may be divided into natural and artificial. Natural wounds are those which are produced on plants living in a state of nature, or in a cultivated state in which other natural agents are concerned in their production, man's activity not being considered. Insects and worms may make burrows in the organs of plants. For example, bark boring is accomplished by species of beetles, so also are tunnels through the bark and the wood. Pith flecks are minute brown specks, or patches, found in the wood layers of trees. They consist of holes formed by boring insects filled with dead parenchyma cells, or dead empty cells filled with fungous material. Eroded and skeleton leaves, and shot-holes in the leaf tissue are directly traceable to the work of cutting insects. Frost cracks are longitudinal wounds produced by the rending action of the frost on the bark and wood of the trees. Sometimes this takes place with a loud report. The attempt on the part of the plant to heal the crack generally produces a frost ridge. Rents made by lightning also occur. Strangulations are lesions formed by woody vines, by telegraph wires, or the like pressing on the outer surface of stems which grow about the compressing object and create additional pressure, so that the compressed tissue dies. Callus forms above the wounded areas formed by compression. Large hailstones sometimes produce bruises on the bark of young trees, as also the bombs shot out of volcanoes. The abrasion of a tree by the branch of a neighboring tree rubbing against it or the cutting of large lateral roots in laying curbstones must be classed as wound phenomena. Wounds are also formed by the teeth and horns of various mammals. Rodents, such as mice, rats, beavers and squirrels, are responsible for wounds produced by gnawing with their chisel-shaped incisors. Bark is rubbed off, or scratched by the horns and antlers of animals of the cow and deer tribes. Wounds are formed by the breaking off of branches

under the tearing action of the wind, or by the breaking action of the weight of the ice and the snow of winter. The repair of wounds will be discussed with the consideration of the pathologic anatomy of plants, which will form a separate chapter of this treatise.

Artificial wounds are due to the influence of man. The ploughing, discing, harrowing and cultivation of the soil frequently abrade roots, break them off, or seriously wound them. Limbs are broken off and bark removed by farm implements. Knife and axe wounds are easily recognized by their sharp character, where the cut may have been made vertically, obliquely, or horizontally. The stripping off of pieces of bark opens up the inner tissues of the stem to the attack of the agents of disintegration and decay. The removal of twigs and branches in the ordinary operations of pruning opens up wounds, sometimes of a gaping character. The ringing, girdling, or scarification of trees for various purposes, if not properly performed, opens up wounds, so do nails, or spikes driven into the tree for various purposes and the placing of electric cables and telegraph wires along our streets and roads results in the removal of tree tops. The habit of cutting initial letters and monograms in smooth-barked trees, such as the beech, or the removal of sheets of birch bark, opens up wounds of various menace to the health of the tree. Injuries due to man-created environment may be of a thousand and one kinds too numerous for even a brief mention.

ANIMATE AGENTS OF DISEASE.—These may be divided into two groups, namely, animal and plant. Many animals are responsible for the production of wounds and the destruction of plant parts. Man, cattle, herbivorous animals, rodents (mice, rats, squirrels, rabbits), and birds do great injury to plants by their horns, teeth, claws and beaks (woodpeckers). Among the invertebrates are to be included the insects, mites and worms. Certain nematode worms attack the roots of a large variety of plants and produce galls of characteristic form and appearance. Phylloxera, an hemipterous insect, winters on the roots of the grape, mostly as a young wingless form. Wingless individuals then abandon the roots and crawl up the stems to the leaves, where they form galls. Formerly introduced into Europe, it was very destructive to European grape vines until it was found that it could be controlled by grafting the European vine on the roots of American varieties. Insects injurious to plants may be roughly divided into two groups:

those with mandibulate, or biting mouth parts, and those with haustillate, or sucking mouth parts. The first group includes the insects that bore into wood, those that bite off the leaf surface (Fig. 111) and thus skeletonize leaves and those which tear or bite pieces out of leaves and other plant parts (Fig. 111). The sucking insects include those like the bugs, aphids, or plant lice, and scale insects (Fig. 112), which cannot be destroyed by stomach poisons. These latter insects by sucking the plant juices do irreparable damage to all kinds of fruit and shade trees, and reduce materially the yield of agricultural and horticultural crops.

Of the mites, the most destructive is the red spider *Tetranychus mytilaspidis*. The red spider is probably identical with the insect known throughout Florida as the Purple Mite. It is quite a small insect, yet distinctly visible to the naked eye. They appear during summer in great numbers and damage the oranges by causing the fruit to drop and injure the foliage leaves so that they cannot perform their functions properly. The leaves become spotted and lose their glossy green color. The males and females are protected by stiff hairs and their color is purplish, or reddish-purple in the old insects, but of a lighter red when young.

Animal galls are of various kinds. Those due to insects are characteristic and will be described, when the pathologic anatomy of plants is considered in detail.

The field of Economic Entomology is a special one and there are bulky treatises dealing with various phases of it. A useful book, and written in an easy style is one by John B. Smith, late Entomologist of the New Jersey Agricultural Experiment Station, and is entitled "Economic Entomology for the Farmer and Fruit Grower." etc. Although published in 1896, it is still a useful book. A few American classics on the subject may be mentioned, as follows:

CROSBY, C. R. and SLINGERLAND, M. V.: Manual of Fruit Insects, 1915.

FORBES, S. A.: Several Reports of the State Entomologist on the Noxious and Beneficial Insects of the State of Illinois.

HARRIS, T. W.: Insects Injurious to Vegetation (several editions). Insect Life, seven volumes (a mine of information on American economic entomology).

PACKARD, ALPHEUS S.: Insects Injurious to Forest and Shade

Trees. Fifth Report of the United States Entomological Commission, 1890.

RILEY, C. V.: Several Reports on the Noxious, Beneficial and other Insects of the State of Missouri.

SAUNDERS, WILLIAM: Insects Injurious to Fruits (several editions).

UNITED STATES BUREAU OF ENTOMOLOGY: Popular and Technical Bulletins on Insects.

CHAPTER XXIV

PLANTS AS DISEASE PRODUCERS, EPHIPHYTOTISM, PROPHYLAXIS

VEGETAL AGENTS OF DISEASE.—The plants which are known to be injurious to other plants fall naturally into two large groups, namely, the Phanerogamic and the Cryptogamic. The latter includes injurious algæ, slime moulds, bacteria and fungi.

The phanerogamic parasites belong to four families of plants. Their morphology and physiology is fairly well known, so that in their discussion, we are entering well-trodden fields of investigation.

The flowering plants, which lead a partially or wholly dependent life upon a host plant, may be considered as belonging to two distinct groups: the green parasites and the chlorophyllless parasites. The plants of the first group illustrate by gradations how the conditions of life of the second group have arisen. The seeds of the first series of green parasites begin their growth in the soil and there develop into seedlings with cotyledons and root system, without any connection with a host plant. The root branches supplied with suckers then become attached to the roots or underground stems of other plants. About one hundred plants of the sandalwood family, SANTALACEÆ, belong to this series, including the true sandalwood, *Santalum album* of India, where its roots live attached to the roots of a species of *Acacia leucophæa* and Pride of India, *Melia azidarachta*¹.

The bastard toad-flax of Europe, *Thesium alpinum*, is another member of this family. It develops relatively large suckers, which become attached to the roots of other plants. These suckers are constricted near their point of insertion. The swollen part spreads itself over the root of the host as a plastic mass, while the central cores perforate the root and grow into the wood of the host where they spread out. *Comandra umbellata* is a santalaceous parasite found in the pine-

¹ WILSON, C. C.: Sandalwood. Indian Forester, xli: 248, August, 1915.

barren region of New Jersey. The family SCROPHULARIACEÆ includes a number of these root parasites. Such are the eyebright (*Euphrasia*), yellow-rattle (*Rhinanthus*), cow-wheat (*Melampyrum*), lousewort (*Pedicularis*) and others. The suckers of the yellow-rattle are of considerable size: their margins are swollen and they spread around the roots of the hosts. Those of the cow-wheat resemble in general those of the yellow-rattle. In America species of *Agalinis* (old genus *Gerardia* in part) are known to have parasitic attachments to the roots of various plants. This plant is a member of the family *Rhinanthaceæ* (SCROPHULARIACEÆ, tribe *Rhinanthæ*).

The second series comprises the chlorophyllless root parasites, such as *Lathræa squamaria*, the toothwort. The young seedling lives at first upon the reserve substances of its seed, sending out roots in all directions. These finally fasten to the roots of ash, hornbeam or poplar, by means of a sticky sucker, which develops a central core that penetrates into the roots of its host. Colorless shoots covered with whitish scale leaves are formed and the flowering shoot which develops above ground has a purplish hue.

The third series of parasitic flowering plants includes those of the families OROBANCHACEÆ, BALANOPHORACEÆ and HYDNORACEÆ. One genus, *Orobanche*, the broom-rape genus, is sufficiently common to merit attention (Fig. 117). The embryo of *Orobanche* shows no trace of root and stem and is without cotyledons. It is a spiral filament of delicate cells feeding on the stored reserve food. In its downward growth, its tip traces a spiral line until it finds the roots of a congenial host, when it not only adheres firmly to a root, but swells in such a way as to assume a flask-shaped appearance. The thickened part becomes nodulated and papillose and some of the papillæ form conic pegs, which penetrate into the root of the host until the vessels of the parasitic attachment of the broom rape reach the vessels of the host.* A bud is formed at the point of union between host and parasite and a strong thick flower-bearing stem grows above ground. Closely and intimately associated with a host, such as a clover plant, the broom-rape does considerable damage. *Conopholis americana* (Fig. 118) and *C. mexicana* live as parasites on oak roots, developing large swellings out of which the flowering shoots grow.

The writer collected *Conopholis mexicana* in 1896 on the roots of an oak, *Quercus reticulata*, on the mountains at Eslava (10,000 feet)



FIG. 117.—Broom-rape (*Orobanche minor*) upon greenhouse geranium. (After Halsted, B. D., Rep. N. J. Agric. Exper. Stat., 1905.)

above the Valley of Mexico. Cf. WILSON, LUCY L. W., Observations on *Conopholis americana*. Cont. Bot.-Lab., Univ. of Pa., II: 3-19.

The fourth series of phanerogamic parasites comprises plants of the family RAFFLESIACEÆ, to which a number of genera belong. *Rafflesia* is a genus confined to the islands off southeastern Asia, Java, Borneo, Sumatra and Philippines. The whole plant is reduced to a

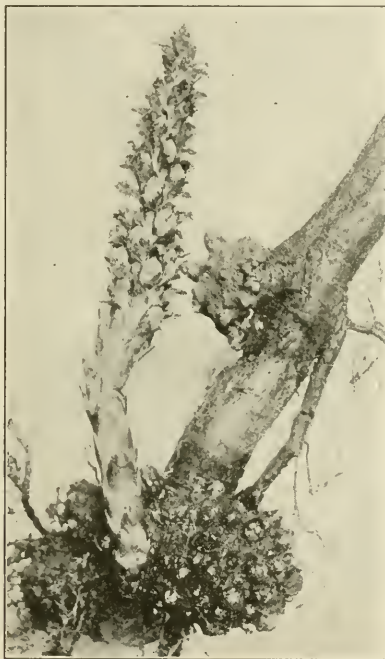

FIG. 118.—Cancer-root, *Conopholis americana* of the broom-rape family, *Orobanchææ*; parasitic on roots of other plants. (From Gager, after Elsie M. Kittredge.)

gigantic ill-smelling flower, one meter across, with parasitic attachments suggesting fungous hyphæ, which penetrate the roots of vines of the genus *Cissus*. *Brugmansia* and *Cytinus* are two other genera of this family. *Cytinus hypocistus* lives on the roots of shrubs of the genus *Cistus* in Mediterranean Europe.

The fifth series of parasitic phanerogams includes epiphytes of bushy habit belonging to the family LORANTHACEÆ. The genera

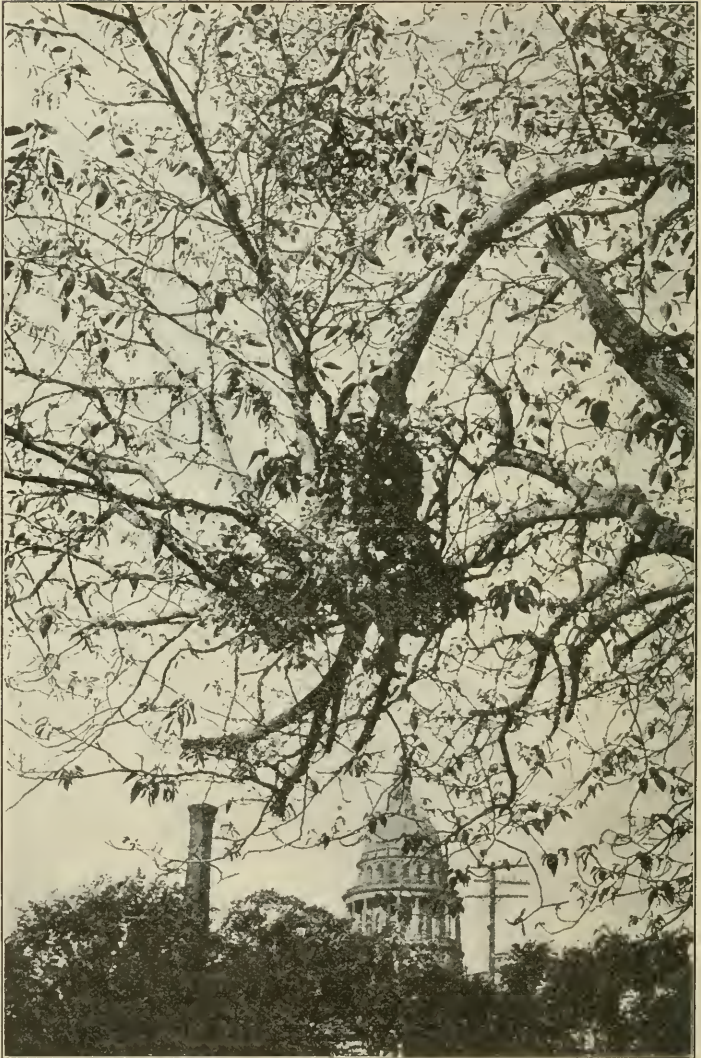

FIG. 119.—Distorted branch of mulberry caused by mistletoe (*Phoradendron flavescens*), Austin, Texas. (After York, H. H., *Bull. 120, Univ. of Tex., pl. ix, March 15, 1909.*)

Loranthus, *Phoradendron* and *Viscum* include the well-known mistletoes. The American mistletoe, *Phoradendron flavescens* (Fig. 119), extends from southern New Jersey, Maryland, Ohio, Indiana and Missouri to Texas. It is a slow-growing green parasite, which on account of its chlorophyll is not entirely dependent upon its host for its carbohydrates (Figs. 120 and 121). It is essentially a water parasite, and consequently, its parasitic roots or sinkers grow into the woody cylinder of its host,



FIG. 120.—Cross-section of a live oak branch showing five stems of mistletoe parasitic upon it. Note sinkers on parasitic roots penetrating into oakwood. (From Gager.)

where they spread out circumferentially (Figs. 120 and 121). The white berries, which are sticky, are carried by birds as the sticky mass containing the seeds adheres to the bill and is only removed by rubbing the beak against the bark of a tree, for example. Mistletoe does not kill the trees directly, but it often causes them to become very much dwarfed and their branches distorted greatly.

Parts of trees, however, may be killed.¹ The larch mistletoe, *Razoumofskya Douglasii laricis*, is one which lives on the western larch in Idaho and Oregon and in the open places interferes seriously with the development of some of the more valuable timber trees.

The sixth series includes the climbing parasites, which are destitute



FIG. 121.—Sectional view, partly diagrammatic, of a branch infected with mistletoe, showing relation of parasite and host. *a*, branch of host tree; *b*, mistletoe; *c*, primary sucker; *d*, sucker from cortical root; *e f*, cortex; *g*, cambium; *h*, wood of branch. (After Bray, W. L., Bull. 166, U.S. Bureau of Plant Industry, Feb. 2, 1910.)

¹ The student should consult the following for more detailed information about mistletoe. SORAUER, DR. PAUL: Handbuch der Pflanzenkrankheiten (2d edition, 1886, ii: 25-32; PEIRCE, GEORGE J.: The Dissemination and Germination of *Arceuthobium occidentale*. Annals of Botany, xix: 99-113, January, 1905; YORK, HARLAN H.: The Anatomy and some of the Biological Aspects of the American Mistletoe. Bull. Univ. of Texas, Scientific Series 13, March 15, 1909; MEINECKE, E. P.: Parasitism of *Phoradendron juniperinum*, Proc. Soc. Amer. Foresters, vii: 35-41, March, 1912; Mistletoe Pest in the Southwest, Bull. 166, Bureau of Plant Industry; WEIR, JAMES R.: Larch Mistletoe, do. Bull. 317.

of chlorophyll and whose seeds sprout in the soil and send up a filiform stem which brings itself by its movements into contact with some host plant, which is penetrated by parasitic roots which enter, as far as the bast region and extract elaborated food. When established on the host the parasite severs its soil connection. Leaves have been



FIG. 122.—Dodder (*Cuscuta*) in flower and parasitic on a golden rod, *Solidago ulmifolia*. (From Gager, after Elsie M. Kittredge.)

reduced to a few scales located near the clusters of small flowers and the twining stem assumes a yellow, or orange-yellow color. The dodder, *Cuscuta* (Figs. 122 and 123), belonging to the bindweed family, is illustrative of these parasites.

Related in habit are species of the genus *Cassytha*. Most of the species of *CASSYTHÆ* inhabit Australia, but some are found in New Zealand, Borneo, Java, Ceylon, the Philippines, the Moluccas, South

Africa, the West Indies and Florida. In Florida,¹ *Cassytha filiformis* is abundant on the dunes and in the rosemary scrub, where it spins its yellow, or reddish-orange stems from bush to bush.

FUNGOUS ORGANISMS AS THE CAUSE OF DISEASE.—The first part of this book dealt with the morphology, physiology, and taxonomy, of

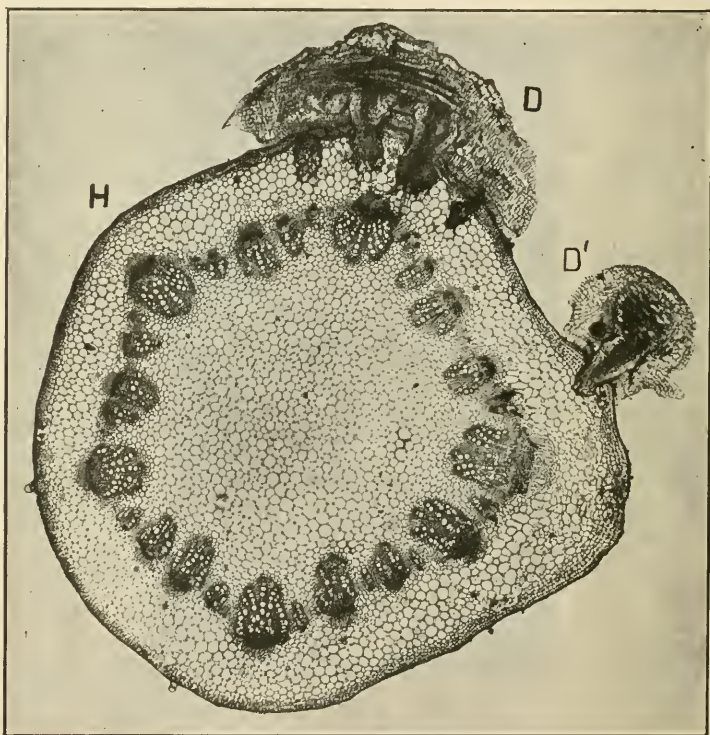

FIG. 123.—Photomicrograph of the section of a dicotyledonous host plant parasitized by dodder, *Cuscuta* sp. At *D* and *D'* note haustoria entering host plant as far as the bast region of the stem. (After Gager).

the slime moulds, bacteria and true fungi. General reference was made to the diseases induced by them and in the third part will be given an

¹ HARSHBERGER, JOHN W.: The Vegetation of South Florida. Trans. Wagner Free Inst. of Science, vii, part 3, October, 1914; 86; Cf. BOEWIG, HARRIET: The Histology and Development of *Cassytha filiformis*. Cont. Bot. Lab., Univ. of Penna., ii: 399-416, 1904.

account of the fungi which cause specific diseases. It remains for this discussion to consider fungi as the causes of diseases in general. Fungi, using the word in the broadest sense to include the bacteria and slime moulds, are responsible for an extraordinary number of diseases. The entrance of the organism into another is known as infection. Nothing like the infection of animals where the microbe, or its poison, circulates in the blood, and finds lodgment in most of the organs is found with plants. Infection follows, when a fungous spore germinates and produces an infecting hyphæ, which grows into the cells¹ or between the cells of the host, it may be reaching to the ends of the plant. As disease is induced by parasitic fungi, the parasite which enters the host and spreads through it must absorb and utilize the plastic and other substances of the plant, which is parasitized. Thus, we can divide the endophytic hyphæ into the intercellular hyphæ such as we find in the oomycetous fungi and *Puccinia simplex*. With such hyphæ the protoplasmic and other contents of cells are utilized by the formation of haustoria of different forms and kinds, which penetrate the interior of the cells. The second kind are the intracellular hyphæ, which as in the disease of the plane tree, *Gnomonia veneta*, grow lengthwise and crosswise from cell to cell.

The growth of the hyphæ between and through the host cells is accompanied by the formation of soluble ferments. These dissolve the substance of the cell walls of cellulose, or woody walls with lignin and pigment deposits. The hyphæ live on the products of solution.² Hence timber may be damaged in two ways: by the formation of minute pores and apertures through it; or by a solution of the cell-wall materials. The wood loses in strength and in weight and becomes "rotten." This rotten condition, however, is reached in a multiplicity of ways, for every parasitic fungus that lives in the wood of growing trees destroys the wood in a manner peculiar to itself. Starch grains are decomposed also in the cells, likewise crystals and tannin, for by the disappearance of the latter, the smell of sound wood is lost. Hartig has described the several methods in his "Text-book on the Diseases of Trees."

Then too, we have the epiphytic fungi which live on the surface

¹ Sometimes the hyphæ grow toward and surround the nucleus as the nucleus exerts a chemotactic influence. Such hyphæ may be termed nucleotropic as in *Puccinia adoxæ*.

² Consult SMITH, ERWIN F.: Bacteria in Relation to Plant Diseases, ii: 76-89.

of the host, as with the common mildews, and send short haustoria into the epidermal cells of the host on which they grow. Some fungi have mycelial hyphæ that grow in both ways, intracellularly and intercellularly. Others, as a number of wood-destroying fungi, grow down through the tissue of the host and ultimately kill it. Apical growth is shown by some. The haustoria, as they enter a cell, may flatten out against the cell wall, as in *Piptocephalis*. Such flattenings are known as appressoria. The haustorium, which enters a cell, may become branched, or dendritic, it may enlarge into a haustorial knob, or remain as an haustorial tube. Internal sclerotia are formed sometimes in certain parasitic fungi. These are consolidated or hardened masses of hyphæ, which are associated with a resting period.

Ordinarily when a spore falls on the surface of the plant, it produces a germ tube, which by the action of a secreted ferment bores its way through the epidermal cell walls and thus enters the host. Sometimes it penetrates the cuticle, grows between it and the cell wall and grows down between the membranes of the cells, as in *Botrytis parasitica*. Occasionally, but not commonly, it enters through the stomata, or sometimes through nectaries and stigmatic surfaces. However, there are certain bacteria, such as those which cause the black rot of the cabbage, which fall upon the drops of water excreted by water stomata and by following the water back into the plant infect the cabbage leaves. A cork layer is protection against infection. Fungi, however, gain access to the interior of the plant in a variety of ways. Some years ago¹ the writer considered the way in which fungi enter living trees and a restatement of the facts presented in that paper is apropos.

Occasionally the planted seed contains a dormant fungus (but not as a mycoplasma in Eriksson's sense), which begins its growth, as soon as the seedling plant emerges. The oat- or wheat-smut spores are produced in the grain and consequently infect the cereal plant when it is small, and at or near the surface of the ground. In other cases the fungus penetrates the underground parts or the twigs of trees. Fungi gain entrance to plants, through injuries caused by mechanic, meteorologic, chemic, or other agents. Mechanic injuries are due to man, animals, or other causes, such as the weight of snow, the rubbing of

¹ HARSHBERGER, JOHN W.: How Fungi Gain Entrance to Living Trees. Forest Leaves, viii: 88-90, December, 1901.

two branches together. Squirrels in search of food bite off the twigs of trees. Deer and moose browse upon the tender branches and bark of various trees, the moose especially upon *Acer pennsylvanicum* and *Sorbus americana*. Grizzly bears rub their backs against the bark of trees and sometimes in this way decorticate them. Rodents peel off the outer protective layers of roots as food, or as material with which to line their burrows. The mycelia of *Rhizoctonia*, or the oak-root fungus,



FIG. 124.—Street tree injured by use as a hitching post. (After Sturgis, W. C., *Rep. Conn. Agric. Exper. Stat.*, pl. iii, 1900.)

Rosellinia quercina, which live in the soil, penetrate into roots through wounds produced by field mice and gophers. The honey agaric, *Armillaria mellea*, forms strands of hyphæ known as rhizomorphs, which grow through the soil and find an easy entrance into roots decorticated by rodents. Beavers are active agents in cutting down trees and removing the bark therefrom. Woodpeckers drill holes into trees and in their case it has been definitely proved that they carry the viable summer spores of the chestnut-blight fungus, *Endothia para-*

sitica, a single downy woodpecker carrying 757,074 spores.¹ Wood-boring insects (FAMILY SCOLYTIDÆ) of the genera *Dendroctonus*, *Scolytus*, *Tomicus* are responsible agents in the destruction of trees opening up holes through which fungi may gain entrance. Horses do considerable damage to trees by stripping off the bark with their



FIG. 125.—Decay following unskillful pruning. (Sturgis, W. C., *Rep. Conn. Agric. Exper. Stat.*, pl. iii, 1900.)

teeth, and street trees cannot be too soon or too carefully protected from such ravages, for a tulip tree planted in the afternoon in front of the house of the writer in West Philadelphia had a strip of its bark removed by the curbstone horse of a delivery wagon before nightfall of the same day (Fig. 124).

Telegraph wires stretched in every direction rub against the trunks and limbs of trees, and do mechanic injury in this way, but, if the insulation is rubbed off the tree may be badly burned, or even set on fire by the electric current, especially on rainy days when there is a direct grounding of the current through the water running down the crevices of the bark. Many trees in our cities are planted too close to the curb and the wheels of passing wagons tear off pieces of bark (Fig. 141). Farmers in plowing, hoeing, mowing and cultivating the soil injure the roots and stems of cultivated plants

and open the way for the entrance of destructive fungi. The blazing of trees by surveyors, the careless system of lumbering, careless transplanting of young trees, are fruitful sources of injury to trees. Careless pruning (Figs. 125 and 126) of trees by inexperienced men, such as was prevalent in Philadelphia before the Park Commission undertook to properly care for the trees, caused the death of many fine shade trees.

¹ HEALD, F. D. AND STUDHALTER, R. A.: Preliminary Note on Birds as Carriers of the Chestnut Blight Fungus. *Science*, new ser., xxxviii: 278-280, Aug. 22, 1913.

Stubs were left which never healed over and through the exposed surface the fungi of wood decay gained easy access.

The injuries produced by meteorologic causes are important. Entire forests have been levelled by tornadoes. Cracks are produced by wind action. Lightning opens a way by cracks to the interior. Snow and ice snap off large limbs and hail stones bruise the bark and leaves of trees so that fungi can readily enter. Chemic substances are rather exceptional destructive agents to which reference has been called



FIG. 126.—Black walnut, *Juglans nigra*. Cold Spring Harbor, L. I. Note large open-branch stub (July, 1914).

in a previous page. Besides these agents, it occasionally happens, that fungi enter healthy plants through diseased grafts which are inserted. Robert Hartig mentions such a graft union of diseased and healthy roots in the case of the red-rot fungus, *Trametes radiciperda*. Here contact of the diseased root containing the fungus with the sound one of a neighboring tree and the partial natural graft union of these two roots explains how such infection occurs. An enumeration of the way in which fungi can gain entrance to plants follows:

Infection by natural growth of the fungus	I.	{ A. By means of spores, or hyphæ, into stomata and water stomata. B. By ferment action of a fungus on the epidermis of the host.	
	II.	{ By developing from a dormant state in the seed into an active state in the seedling.	
Infection through	I. Mechanic injuries induced by	{ Beasts Man Fall of fruit Combined weight action of fruit	
		II. Meteorologic injuries induced by	{ Wind Snow Ice Hail Lightning Sun Frost
	III. Chemic injuries induced by		{ Factory gases Sewer gases Locomotive gases Chemicals at roots. Alkali soils Gases and chemicals in geysers, etc.
			IV. Non-classifiable injuries induced by

INCUBATION.—The period of incubation is the time between exposure to the cause of the disease and the first appearance of the symptoms, or physical signs of the disease. This period in plants is quite as variable as in animals, and it is dependent on the nature of the organism, whether it is virulent, or its virulency attenuated, on its food requirements, on its temperature requirements, the volume of infectious material, the stage of development, or age of the host plant, the amount of water and air in the invaded tissues, and individual or varietal resistance. The period of incubation may be as short as a few hours, or as long as three to four weeks. Presumably on seedling tissues the period of incubation of the damping-off fungus, *Pythium de Baryanum*, is only a few hours. Experiments performed by Erwin F. Smith¹

¹ SMITH, ERWIN F.: Bacteria in Relation to Plant Diseases, ii: 66.

with *Bacillus tracheiphilus* and young cucumbers where the organism was inoculated from young cultures, and on susceptible plants by needle-pricks, showed that signs of disease rarely appeared in less than three to four days, and that signs of wilt and change of color usually were visible in five to seven days. In the case of the white pine blister rust, *Cronartium ribicola*, the period of incubation in the pine is from one to six years.

Duration of Disease.—The resistance of plants to disease is various even after the fungus has obtained an entrance into the tissue of the



FIG. 127.—Chestnut, *Castanea dentata*, killed by blight fungus, *Endothia parascaiti*, Cold Spring Harbor, L. I., July, 1914.

host. In the case of large trees like the white oak, a number of years may elapse before the tree finally succumbs to such fungi, as *Fomes* (*Polyporus*) *applanatus*. A chestnut tree a few miles outside of Philadelphia resisted the chestnut-blight disease for over four years from the time of first infection before it finally succumbed. Smith (*loc. cit.*) describes how a good-sized potato tuber was half rotted in five days at ordinary autumn temperatures when inoculated with *Bacillus phytophthorus* by means of a few needle-pricks.

The final outcome of the disease may be a complete destruction of the host (Fig. 127), or its complete recovery. The simplest cases are leaf spots, or fruit spots, which are removed from the plant when the leaves and fruits fall without in any way jeopardizing the general health of the plant. Sometimes the plant recovers from bacterial, or fungal diseases, but such recovery does not protect the plant from subsequent attacks of the same disease, as is the case with some diseases of animals. Old and slow-growing cabbages are rather resistant to *Pseudomonas campestris* while young and rapidly growing plants are apt to be destroyed. Vaccination of plants to ward off diseases has never been successful, and it is doubtful whether this means of protection is available for plants. It is, however, a wholly unworked field. Some experiments which Smith, Townsend and Brown performed in 1908 and 1909 seem to show that after Paris daisies have been inoculated several times with *Pseudomonas tumefaciens* with the production of tumors, that subsequent inoculations with cultures of the same virulence are without effect, but owing to the possibility that the results were due to loss of virulence, the experiments were inconclusive. For the student, who may be interested in pursuing this line of important research work further, the following bibliography is here given, taken from Smith.

- SHATTOCK, SAMUEL G.: The Healing of Incisions in Vegetable Tissues. Journ. Path. and Bact. Edinburgh and London, v: 39-58, 1898.
- HILTNER, L. and STÖRMER, K.: Neue Untersuchungen über die Wurzelknöllchen der Leguminosen und deren Erreger. Arb. a.d. Biologischen Abt. für Land- und Forstwirtschaft am Kaiser. Gesundheitsamte iii, heft 3: 151, 1903.
- BRÜLLOWA, J. P.: Ueber den Selbstschutz der Pflanzenzelle gegen Pilzinfektion. Jahrb. f. Pflz. Krh. K. Bot. Garten Petersb., Nr. 4, 1907.
- ALTEN, H. VON: Zur Thyllenfrage. Callusartige Wucherungen in verletzten Blattstielen von *Nuphar luteum*. Bot. Ztg., 68, part ii: 89-95, 1910.
- SMITH, ERWIN F.: Bacteria in Relation to Plant Diseases, ii: 93-94, 1914.

DISSEMINATION OF FUNGI

Fungi are usually reproduced by spores, which are minute and light and easily carried about by various agents, such as on seeds, by the wind, by water, by insects, by other animals, by agricultural and commercial practices and by railroads, cars and other vehicles. The black-leg, or *Phoma* wilt of cabbage of recent introduction, was introduced from Europe undoubtedly with imported seed, and as we have seen various

smuts are carried by the single fruits of various grains. In the æcial stage of the cedar-apple fungus, *Gymnosporangium juniperi-virginianæ*, the spores are set free during dry weather at a time when they are most likely to be wind-carried.¹ The spores of the water molds are carried by currents of water and those of the cranberry gall due to *Synchytrium vaccinii*. The motile zoospores of the damping-off fungus need water for their dissemination. The spores developed during the *Sphacelia* stage of the ergot fungus on rye are carried by insects. The formation of the conidiospores is accompanied by a sweet substance, the so-called honey-dew, which is much relished. Birds, especially woodpeckers, disseminate the spores of the chestnut-blight fungus, *Endothia parasitica*, and in a great many different ways man is active.

EPIPHYTOTISMS (EPIDEMICS)

When a plant disease becomes virulent, rampant and aggressive, spreading rapidly from place to place, it is said to be epiphytotic (epidemic). A number of such epiphytotisms (epidemics) have occurred and the destruction due to some particular plant disease has been enormous. The potato crop in the British Isles during the summer of 1845, owing to a high temperature and abundant rains, suffered entire destruction in the short space of a fortnight. This was due to the ravages of *Phytophthora infestans*, an oomycetous fungus, whose spores in wet weather produce numerous infecting motile zoospores. The destruction of the potato crop led to the repeal of the corn laws of England, and as a sequence, the inauguration of a free trade policy. The Irish famine was the direct result and thousands of the natives of the Emerald Isle emigrated to America. With respect to the disease known as peach yellows Dr. Erwin F. Smith writing in 1891² says: "Formerly this disease was confined to a small district on the Atlantic Coast, but during the last twenty years it has invaded distant regions hitherto free, and has entirely ruined the peach industry over very considerable areas. Within ten years the disease has taken fresh

¹ HEALD, F. D.: The Disseminations of Fungi Causing Disease. Trans. American Microscopical Society, xxxiii: 5-29, June, 1913.

² SMITH, ERWIN F.: Additional Evidence on the Communicability of Peach Yellows and Peach Rosette. Bull. 1, Div. of Vegetable Pathology, U. S. Dept. Agric., 1891.

very strong hold upon the orchards in the Delaware and Chesapeake and region, the north portion of the peninsula, and has destroyed thousands and thousands of trees, rendering a great industry unprofitable and precarious." The recent spread and virulency of the chestnut-blight fungus, *Endothia parasitica*, from the neighborhood of New York City, where it was probably first introduced, is so recent and fresh in the minds of the public, that an extended account of the epiphytism (epidemic) need hardly be made here. The disease has practically destroyed the native chestnut trees of the forested areas of the eastern states east of a line running northeast and southwest through the central part of Pennsylvania. There have been a few sporadic cases west of that line removed through the heroic efforts of the men employed by the Pennsylvania Chestnut Blight Commission, who with a big appropriation of state money tried to find a way of heading off the disease and finally controlling it but without success. Introduced in all probability from China, where it has been found recently, the ravages of this disease have been without precedent.

As to the epiphytotic diseases of plants due to animals, we have a number of instructive illustrations. The account of the introduction, spread and final control of the cottony cushion scale forms one of the most interesting chapters in the history of American phytopathology. Having been introduced from Australia to California in 1868, it spread so rapidly during the next twenty years that its ravages proved a very serious menace to the citrus industry of the southern part of California. The Australian ladybird beetle, which was introduced into California from Australia in 1889 for the purpose of controlling this scale, was so successful, that except for occasional outbreaks it ceased to be considered a serious citrus pest.

All of these epiphytisms (epidemics) and others that might be cited have been possible in all probability because the climatic conditions of temperature, moisture, rainfall, wind and soil conditions have been favorable during the period of most active virulency, when the diseases became firmly established. As an important contributing cause may be considered the unhealthy, abnormal, or susceptible condition of the host plant owing to the methods of cultivation which have reduced the disease-resisting capacity of the plant. In the case of the chestnut, the restoration of the trees by sprouting from the stump was undoubtedly one of the contributing causes of the rapid spread of

the disease. Altogether, these epiphytoticisms (epidemics) result either when the conditions are favorable for the spread of the parasites, or when the general tone and health of the plant has been lowered by improper methods of handling, so that its disease-resisting capacity has been reduced. Recognizing the possibility of the introduction of other virulent fungous, or animal diseases, a stricter quarantine has been instituted by both the individual state and national governments with a careful inspection of nursery stock designed for shipment from place to place.

PROPHYLAXIS

Prophylaxis may be defined as the means taken to prevent disease. It includes a consideration of the methods of protecting plants from disease, of preventing the spread of disease, and of the methods of breeding by which the disease resistance of plants is increased until in some cases absolute immunity is reached and the plant is made proof against disease. Some diseases are preventible by the observance of proper care in the cultivation of plants,¹ and by habits of cleanliness, when no refuse which might harbor insect or fungous disease is permitted to remain, but is either destroyed, or rendered innocuous. For example, vegetable and agricultural crops should be rotated, so that the same crop would not follow upon the same piece of soil where the animal or fungous parasite may be lurking. Neither should the farmer attempt to cultivate certain crops in acid soils, or in low situations subject to frost action. Nor should seeds be placed in beds rife with the spores of the damping-off fungus, *Pythium de Baryanum*. By proper care on the part of the grower diseased plants should not be sent away from an infected locality, and vice versa, he should be careful about the introduction of nursery stock and plants from other localities without a careful inspection. The national and state quarantine regulations are designed to help the grower in these respects, and he can refuse to purchase new plants without they are accompanied by a certificate setting forth that these plants are free from animal and fungous diseases. Orton² in two suggestive papers, has shown that

¹ BOLLEY, H. L.: Cereal Cropping: Sanitation, a New Basis for Crop Rotation, Manuring Tillage and Seed Selection. *Science*, xxxvii: 249-250, Aug. 22, 1913.

² ORTON, W. A.: International Phytopathology and Quarantine Regulation, *Phytopathology*, 3: 143-151, June, 1913. The Biological Basis of International Phytopathology, *Phytopathology*, 3: 325-333, February, 1914.

this problem is not only of national, but of international and intercontinental importance. These papers should be read by every serious-minded student.

Plant protection may be secured by the use of spraying materials.¹ The principal rules to be observed in their use are: (1) the poison employed must be sufficiently strong or concentrated to kill the parasite, but not sufficiently powerful to injure the host; (2) it must be applied at the right time, as suggested by a knowledge of the life history of the fungus, or insect in question. Such sprays may, therefore, be divided into two kinds, viz., insecticides and fungicides. Applications of these to healthy plants serve to protect the plant from the attacks of its fungous and insect enemies. Vast possibilities of controlling disease have been opened up by the treatment of seeds with hot water and other substances before the seeds are planted.

¹ McCUE, C. A.: Plant Protection. Bull. 97, Del. Coll. Agric. Exper. Stat. June 15, 1912; REES, CHARLES C. and MACFARLANE, WALLACE: A Bibliography of Recent Literature Concerning Plant Disease Prevention. Univ. of Ill.: Agric. Exper. Stat., Circular 183, May, 1915.

CHAPTER XXV

PRACTICAL TREE SURGERY¹

The object of tree surgery is to repair the damage done to trees by the various causes previously described (page 274). The principles involved in all such remedial work are the removal of all decayed, diseased, or injured wood and bark, the cauterization, sterilization, and waterproofing of the cleaned, or cut, surfaces, and the putting of the tree in a condition for rapid healing. Such treatment should be watched from year to year, so that any defects will receive immediate attention.

As the work requires the application of scientific principles, no ignorant laborers should be employed. The men who act as tree surgeons should have some knowledge of the structure of trees, their physiology and their habits of growth. A knowledge of the general principles of horticultural practice would not come in amiss, such as the tenets of grafting and pruning. Such workmen would be still better prepared, if acquainted with the structure, growth and life histories of the common destructive fungi and insects. If a town or municipality is unable to obtain such skilled labor, then the appointment of a superintendent, or town forester, who is acquainted with such matters, should be made. Such a man should know the right thing to be done and all the details of the work.

Preventive Measures.—As means of preventing injuries to trees, various things may be done. The placing of an open tree box or fence of iron, or wire netting, is important, because it protects the tree from the gnawing of horses and the rubbing action of passing vehicles, or the viciousness of street arabs. Proper attention to the insulation of telephone, telegraph and electric wires will prevent a lot of damage to shade trees. Electric linemen, unless properly supervised, have no

¹ A detailed account of practical tree surgery by J. Franklin Collins will be found in the Yearbook of the United States Department of Agriculture, 1913; also consult STONE, GEORGE E.: Shade Trees, Characteristics, Adaptation, Diseases and Cure, Bull. 170 Mass. Agric. Exper. Stat., Sept., 1916.

regard for shade trees, as they look upon them as obstacles to the prosecution of their work. Improper pruning, when large stubs are



FIG. 128.—Properly treated area left by branch removal. Scar beginning to heal over by callus growth. (After Collins, F. L., *U. S. Yearbook Dept. Agric.*, 1913.)

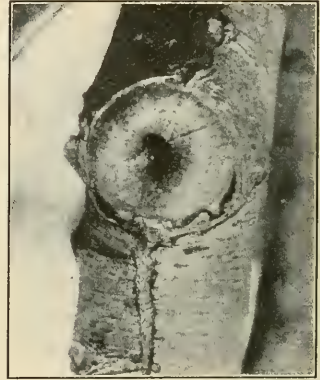

FIG. 129.—Properly treated branch scar about three-quarters healed over. (After Collins, F. L., *Yearbook U. S. Dept. Agric.*, 1913.)

left, is another source of danger to the tree, which with proper knowledge can be safeguarded. There are a thousand and one details which, if neglected, will work injury to the planted trees.



FIG. 130.—Cross-section of 7-year old blaze on a quaking aspen nearly healed over. (After Collins, F. L., *Yearbook U. S. Dept. Agric.*, 1913.)

Character of the Work.—Tree surgery consists in the removal of decayed or dead limbs from trees, the cutting off of stubs left by improper methods of pruning, and the treatment of scars, holes and cavities, so as to prevent decay and secure proper healing (Figs. 128, 129, 130). The removal of branches from trees should be done in such a way as to prevent injury to the surrounding bark and cambium or active layer of growth.

For this purpose, a saw, or gouge, a chisel, a mallet and a strong knife are essential. Where the branches are high above the ground,

a rope and ladder are needed. The cuts should be made close to the main tree trunk, so as to reduce the surface exposed to the action of the elements. Cut surfaces should be cauterized and water-proofed. The best antiseptic dressings are some of the creosotes, which destroy and prevent the growth of wood-destroying fungi, because it penetrates the wood better than a watery antiseptic. The antiseptic treatment with creosote should be followed by painting the scar with coal-tar. Lead paint is sometimes more available. It is useful, but not as satisfactory, as a heavy coat of coal-tar.

Cavity Treatment.—The removal of all decayed and diseased parts of the tree should be accomplished first by the use of gouges, chisels and scraping tools. The use of the chisels is assisted by a wooden mallet. These cutting instruments should have keen edges for the cambium may be injured by dull tools. After properly clearing away all decayed material, the freshly cut surfaces should be treated with creosote and heavy coal-tar which should coat the surface of the sound and healthy exposed surfaces of the wood. The excavation should be so made as to provide drainage at the bottom of the cavity, but the undercutting should be done in such a way as to hold the filling material. Before the filling material is added to the cavity, it may be necessary to place one or more bolts in position to hold the tree shell firmly together. Iron rods and wire netting are also sometimes placed in the hollow to help reinforce the concrete, or cement, when it is mixed and ready for use. The tree surgeon learns by experience the best methods of procedure in the use of bolts, wire netting and the placing of the filling substance.

Mixing and Placing the Cement.—A good grade of Portland cement and clean, sharp sand free from loam (1 part of cement to 3 or less of sand) should be used. The mixing can be done in a mortar bin, a wheelbarrow, a pail, or in any other available receptacle. A mason's flat trowel and an ordinary garden trowel with a curved blade will be found convenient in placing the cement. A tamping stick, one or two inches thick and one to three feet long, according to the size of the cavity, will be needed, also some rocks to help fill the cavity and a pail of water. As the cement begins to harden, the surface should be carefully smoothed, so that it conforms with the general contour of the tree trunk. Sometimes cloth, or wire dams are used. These are stretched across the opening and a more liquid cement is poured into the space behind

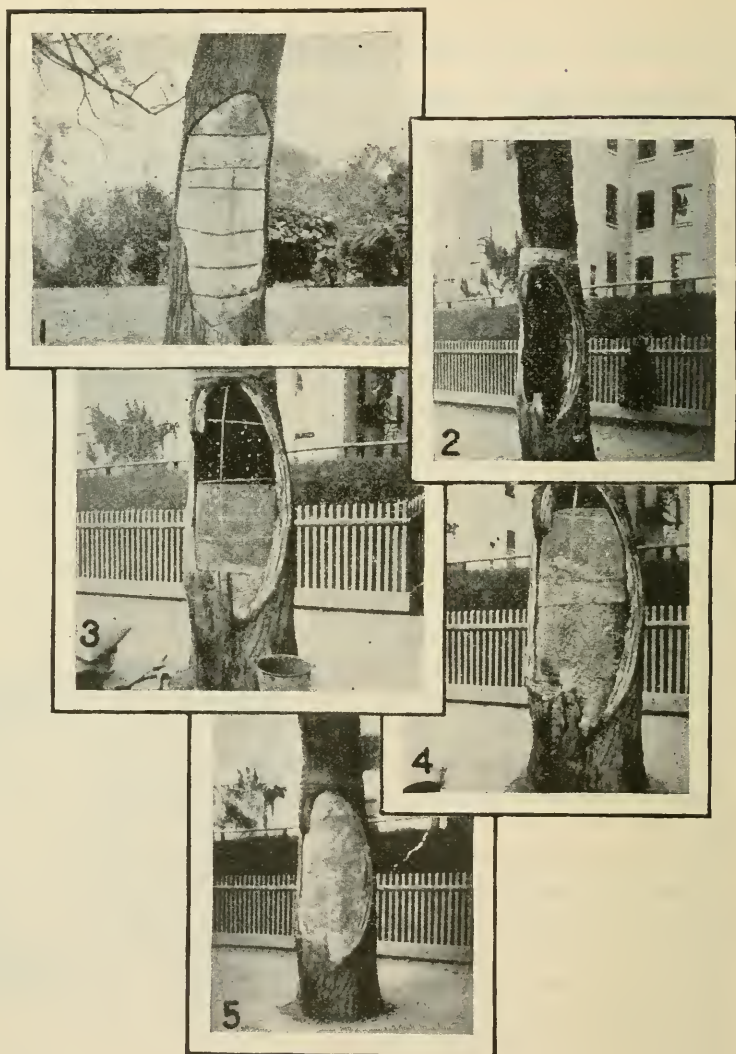

FIG. 131.—Cement cavity fillings, showing different types and successive stages. 1, A large cavity in an elm filled with cement blocks separated by layers of tarred paper; a patented process. 2, An excavated cavity ready for treating and filling. 3, The cavity shown in 2, which has been nailed and partly filled with cement. The ends of the rods for reinforcing the concrete are sprung into shallow holes in the wood. The wire dam is sometimes allowed to remain embedded in the cement, though it is usually removed as soon as the cement has partially set. 4, A later stage of the work shown in 3. The height of the wire dam has been increased. 5, The same cavity shown in 2, 3, and 4, several days after the filling was completed. (After Collins, F. L., *U. S. Yearbook Dept. Agric.*, 1913.)

the dam which is removed when the filling has hardened. Asphalt and asphalt mixtures promise much for the future, when the proper methods of applying liquid asphalt have been discovered (Fig. 131).

Defects in cement work are due to the use of cheap materials, carelessness in the mixing of the cement, splitting of the tree by the action of intense cold, dislodgment of the cement by the swaying action of the wind. Cracks appear in the cement, if the wood of the tree contracts away from the filling, or by the spread of the decayed tissue behind the cement work due to lack of care in excavating rotten wood prior to the filling operation. These defects may cause lots of trouble.

Metal-covered Cavities.—Sheet tin, zinc and iron have been used extensively to cover cavities. These coverings often serve to exclude rain, fungous organisms and destructive insects for some time. If not properly applied, such tin-covered cavities are a greater menace to the tree than open cavities. If such covers are used at all, the excavated cavity should be thoroughly sterilized and waterproofed. The metal is nailed fast with a light hammer and its center should be allowed to curve outward, so as to conform to the general shape of the tree trunk. The tacked edges should be as nearly air-tight and waterproof as it is possible to make them, and this can be assisted by painting the surface of the tin. Sometimes fumigation of the cavity is resorted to as an added precautionary measure.

Where the tree is not of sufficient value to fill with cement, an open cleaned cavity may be left after cauterization of the cleaned wood surface and waterproofing. A layer of burned wood is sometimes a sufficient protective covering, if the burning is accomplished by one of the blow lamps, such as painters use for stripping the paint off woodwork.

Guying.—Closely associated with the work of tree surgery proper, and often an indispensable adjunct is the guying of limbs to prevent the splitting of the crotches, or to check further splitting. Experience demonstrates the best methods of applying the hook bolts, chains or other braces to the trees to be treated. This varies so widely in different trees that it is impossible to give specific directions for this kind of work.

In conclusion, it should be stated that tree surgery can be undertaken safely at almost any season of the year, especially well when the sap is not flowing actively, and the weather is not too cold, to freeze

the cement, and destroy such expensive filling work. Most ornamental and shade trees having only a few dead limbs are unquestionably worth attention. Others which have many dead limbs, or numerous decayed areas may not be worth the expense. Trees of large size, rare trees, historic trees and trees which fill a peculiar place in the landscape are probably worth saving by the most expensive methods of tree surgery, if necessary. Another phase of tree surgery is the commercial side, where ignorant men and tree fakers have undertaken to make a business of pruning and treating trees. The sad appearance of excessively pruned trees in all of our large American cities are living spectacles of the zeal of such men, who should be driven out of the business, as they have in Philadelphia by the municipal authorities undertaking to do the work by the employment of skilled tree surgeons.

BAILEY, L. H.: *The Pruning Book*. The Macmillan Co., New York, 1907.

BLAKESLEE, ALBERT F. AND JARVIS, CHESTER DEACON: *Trees in Winter. Their Study Planting Care and Identification*. The Macmillan Co., New York, 1913.

COLLINS, J. FRANKLIN: *Practical Tree Surgery*. Yearbook of the United States Department of Agriculture, 1913: 163-190.

GASKILL, ALFRED: *The Planting and Care of Shade Trees*.

Forest Park Reservation Commission of New Jersey, 1912, with papers on Insects Injurious to Shade Trees by JOHN B. SMITH and Diseases of Shade and Forest Trees by MEL T. COOK.

START, E. A. STONE, G. E., AND FERNALD, H. T.: *Shade Trees*. Bull. 125, Mass. Agric. Exper. Sta., Oct. 1, 1908.

It has been a matter of general knowledge that a disease may be controlled by a change in the time of planting, for with smuts the very different climatic conditions prevailing at the time of the various sowings have influenced the rate of infection. Early sowing of winter wheat has been found beneficial in the reduction of the amount of stinking smut, for wheat sown early in October showed no sign of infection, while plants sown at the end of October were much attacked (about 60 per cent.) by the smut. By experiment as a problem in prophylaxis this matter of sowing as a means of controlling disease should be established for all of our important cultivated crops.

Then too, a study of the cells and tissues which protect plants against the entrance of insects and fungi is a matter of prophylactic interest. The formation of cork, of bark, of callus, of how in response to the attack of fungi, the multiplication of protecting, or outer cells, is accomplished, should receive the attention of the student of phyto-

pathology. The presence of tannin and other protective chemical substances in the plant may explain immunity or non-immunity.¹

Disease resistance and disease susceptibility are understood imperfectly. The determination of the cause of the inherent differences in the tendency of this or that variety to suffer from disease is a matter of great importance. Breeding for disease resistance is a promising field of research.² Something has been accomplished along this line, but the amount which we do not know vastly exceeds the knowledge which we now possess. Rustproof varieties of wheat have been obtained. At the Ohio Experiment Station by selection of hills of potatoes that withstood attacks of the early blight fungus and planting tubers therefrom with subsequent repetition of this line of work, early blight resistant strains were secured. Progress has been made with cotton resistant to wilt and with musk melons resistant to leaf blight.

Recently Jones and Gilman³, Wisconsin, have undertaken to control the disease known as yellows caused by the parasitic soil fungus, *Fusarium conglutinans*, by breeding cabbage plants that show disease resistance. By repeated selection of the occasional sound heads in fields of diseased cabbages, strains of winter cabbage of the Hollander type have been secured which have proved in a high degree resistant against the attacks of *Fusarium*. The chances for research along these lines are practically unlimited and full of promise for the future of agriculture and horticulture.

¹ COOK, MEL T. and TAUBENHAUS, J. J.: The Relation of Parasitic Fungi to the Contents of the Cells of the Host Plants. (1. The Toxicity of the Tannins) Bull. 91, Del. Agric. Exper. Stat., February, 1911.

² ORTON, W. A.: The Development of Farm Crops resistant to Disease. Year-book of the United States Department of Agriculture, 1908: 453-464.

³ JONES, L. R. AND GILMAN, J. C.: The Control of Cabbage Yellows through Disease Resistance. Research Bull. 38, Agric. Exper. Stat. Univ. Wis., December, 1915; NORTON, J. B.: Methods used in Breeding Asparagus for Rust Resistance, U. S. Bureau of Plant Industry, Bull. 263, 1913.

CHAPTER XXVI

INTERNAL CAUSES OF DISEASE

During recent years attention has been called to diseases which are evidently due to the action of an enzyme, or ferment in the plant, which renews itself perhaps as a catalytic agent in the tissues of the host. As it is filterable through a Berkefeld filter, it may be a soluble enzyme pure and simple, or it may be one of the extremely minute ultra-microscopic organisms to which attention has been called recently. All the evidence seems to point to its enzymatic nature. Such diseases are caused by the excessive activity of the oxidase and peroxidase enzymes in the plant and the loss of function of catalase, another enzyme, which carries off some of the residual products of the others mentioned. Such diseases due to a *Contagium vivum fluidum* affect a number of plants, notably the tobacco, and all of these diseases seem to be more or less related, as to their nature and origin. Recently Küster in the second edition of his "Pathological Plant Anatomy" (1916) has grouped many of the enzyme-produced conditions under the head of "Panaschiering." He distinguishes several types. The first is when the green parts contract sharply under the pale parts. Under this head he considers: (a) marginal panaschiering, when such terms as "*albo-marginatis*" would be applicable, as in such cultivated plants as *Pelargonium zonale*, *Hedera helix* and *Weigelia rosea*. (b) In sectional panaschiering, the white and the green colors are distributed sectionally over leaves and stems, as in *Chamaecyparis pisi-fera plumosa argentea*. (c) He distinguishes marbled and pulverulent panaschiering. His second group includes cases where the border between green and pale parts is not sharply marked and this group includes (a) Zebra-panaschiering, as in the banded leaves of *Eulalia*, and (b) flecked panaschiering, where white specks are distributed over a green background and blend with it. It is clear that "Mosaic," "Brinlle," "Calico" or "Mottle Top" of tobacco is a physiologic, not a fungous or bacterial disease.

It is infectious, and to a certain extent contagious. As calico is an important disease of tobacco and tomato a description of it in these plants will serve to show what enzyme diseases are like in general. The leaves present a mottled appearance, being divided into smaller, or larger, areas of light-green and dark-green patches. In the tomato, the light-green areas become yellowish, as the disease progresses, and in very badly affected plants become finally purplish-red in color. The leaves are much distorted, stiff, and badly curled. It attacks other plants, notably the poke weed, *Phytolacca decandra*, ragweed, *Ambrosia artemisiæfolia*, Jamestown weed, *Datura stramonium*. It is probable that peach "yellows," aster "yellows" are more or less similar to the true "mosaic." Calico is primarily a disease of the green coloring matter (chlorophyll) of the infected plants; hence it disturbs the normal nutrition of the plant. To this destruction of the chlorophyll the name of chlorosis has been given and calico is, therefore, a state of chlorosis. The contagious nature of calico is shown by experiments which prove that it can be communicated at least in some cases by mere contact of calicoed plants with the healthy. Juice on the hands from calicoed plants when handling disease-free plants will spread the disease in nearly all cases, and this infection is due to the chlorotic juice on the hands of the experimenter. Chlorosis, or calico, usually takes ten to fourteen days to make its appearance after infection and a plant once infected remains permanently so, and all new growth usually becomes calicoed. Calico, or mosaic, can be transferred to other species and varieties of *Nicotiana* than the common *N. tabacum*, also to potato, egg plant, peppers, petunia, etc. The dried leaves of calicoed tobacco retain their power of infection for at least a year or two, to some degree, but if wetted they lose this power. The virus, if it is permissible to use this word, can be apparently extracted from calicoed leaves by ether, chloroform and alcohol without destroying its infectious qualities. Bunzel has measured the oxidase content of plant juices, because of the importance of oxidase in chlorotic diseases of plants, in their causal relationship to color production in plants, their importance in the darkening of tea and in the production of the smooth, black and hard lacquer of the Japanese, from the white, fluid, soft secretion of the lacquer tree, *Rhus vernicifera*. The literature on oxidizing enzymes is a copious one. The following papers and books can be consulted, as well as the bibliography which each includes:

- BUNZEL, HERBERT H.: The Measurement of the Oxidase Content of Plant Juices. Bull. 238, Bureau of Plant Industry, U. S. Dept. Agric., 1912.
- CHAPMAN, G. H.: Mosaic and Allied Diseases with Especial Reference to Tobacco and Tomato. 25th Annual Report Mass. Agric. Exper. Stat., 1913: 94-104.
- CLINTON, G. P.: Chlorosis of Plants with Special Reference to Calico of Tobacco. Report Conn. Agric. Exper. Stat., New Haven, 1914: 357-424, with 8 plates.
- KASTLE, J. H.: The Oxidases and other Oxygen Catalysts concerned in Biological Oxidations. Bull. 59, U. S. Hygienic Lab., 1910.
- KLEBAHN, PROFESSOR DR. H.: Grundzüge der Allgemeinen Phytopathologie, 1912: 124-127.
- WOODS, ALBERT F.: Observations on the Mosaic Disease of Tobacco. Bull. 18, Bureau of Plant Industry, U. S. Dept. Agric., 1902.

Nutritive disturbances may also be included as internal causes of disease. If for any reason, such as the inability of the living cells of the root to take up water through a change in the osmotic power of the protoplasmic membrane of the root hair cells, the leaves above owing to active transpiration cannot secure sufficient quantities of water and the whole plant wilts. A disturbance in the formation of starch in the chloroplast results in a deficiency of the plastic carbohydrates, and the active cells of the cambium during this period of starvation form less wood and, therefore, fewer conducting vessels. This reacts on the tissues everywhere in the plant by reducing the available water and food and, therefore, the plant is dwarfed and perhaps sickly. Intumescences are trichomatous outgrowths not associated with insects or fungi which are due to some disturbance of the balance between transpiration and assimilation.

Mutations which result in the sterility of an annual species would lead to the extinction of the plant with such non-seed production. *Enothera albida* is a pale-green, rather brittle and very delicate form with narrow leaves; never attaining anything like the height of *E. Lamarckiana*. It bears pale flowers and weak fruits which contain little seed. It appears every year in most of de Vries's cultures in larger or smaller numbers. The plants are so weak that de Vries imagined them to be diseased,¹ and after much difficulty he secured seeds from them. Enough has been given on these points to show that mutations may be along the line of plants constitutionally weak. The absence of amygdalin and prussic acid in the Sweet Almond may make such a form more susceptible to disease, as also the absence of quinine from cinchona trees kept in European hot houses.

¹ DE VRIES, HUGO: The Mutation Theory (English edition), I: 229, 1909.

MALFORMATIONS AND MONSTROSITIES

Hugo de Vries has shown that malformations and monstrosities do not arise as a result of variations, but may be looked upon as mutations. His tricotylous, hemisyncotylous, syncotylous, and amphisyncotylous races are proof of this statement. Fasciation in its simplest form consists of a flat, ribbon-like expansion of stem, branch, flower clusters, flowers and fruits which may be cylindrical below, but flattened above. This is one of the most common of all malformations and by numerous experimental cultures the fasciation has been found to be heritable. Spirally twisted plants are more striking malformations than fasciations. *Valeriana officinalis* is one of the best-known examples displaying spiral torsion. It is also displayed in a teasle. *Dipsacus silvestris torsus*, twisted sweet william, *Dianthus barbatus*, dark-eyed Viscaria, *Viscaria oculata*. Such malformations de Vries has shown to be truly heritable. Pleiophylly is that condition where two or more leaves arise in place of a single one. Such we find in the ever-sporting races of clovers, where four, five, six, seven, or even eight leaves appear instead of the normal three. The presence of three leaves in a whorl, or of three cotyledons, as above noted, is called polyphyly. Shull has shown that the ascidial leaflets of the white ash, *Fraxinus americanus*, are heritable. Pistilody is demonstrated in the appearance of imperfect pistils in place of stamens, as in the poppy. When colored flower parts become green, this condition is known as antholysis, or chloranthly, and is illustrated in green roses and green dahlias. This condition and petalody and sepalody are transmitted. Peloria, where a normally zygomorphic flower, as in the toad-flax, *Linaria vulgaris*, is transformed into a regular flower with five spurred petals instead of one spurred petal, is another example of monstrosities which are heritable.

The history of *Cytisus Adami* which originated as a graft hybrid is of interest in connection with the study of Chimæras. Hybrids that arise by vegetative reproduction, where scion and stock are mutually affected, are known as graft hybrids. The origin of *Cytisus Adami* seems to have been as follows: a shoot of *Cytisus purpureus* was grafted on a stock of *Cytisus laburnum*; from this were produced many shoots, one of which grew vigorously, and developed larger leaves than those of *C. purpureus* and from this shoot plants were propagated

constituting *Cytisus Adami*. It was found, that on flowering, this form had dingy red flowers. Winkler believes that graft hybrids and chimæras are the result of the process by which cells of two distinct kinds or species are united vegetatively instead of by sexual methods, and that this serves as the point of departure for an organism which in a single growth shows bound together the peculiarities of both species. Hence, a graft hybrid is a complex chimæra. Baur thinks that the union between *Cratægus* and *Mespilus* (*Cratægomespilus*) is a periclinal chimæra, and refers this and the graft hybrid to the development of a mixed vegetation point, where the periclinal chimæra originates in the development of an apical region with a periclinal arrangement of cells.¹

Branches of shrubs and trees originate as mutants with a different combination of characters than the rest of the shrub, or trees. Such mutants probably arise in the change of some single cell. The shoot which arises from tissue formed by mutating cells develops into something new which is called a bud variation, or sport variety. If the shoot arises from the mutating cells alone, then the resulting shoot will consist only of the new cells and the sport can be propagated true without any reversion. If the tissue which gives rise to the shoot combines both old and new cells, then there arises a mixed branch, which is known as a "sectorial chimæra." Citrus trees show such "sectorial chimæras" not infrequently when a Valencia orange tree bears typical Valencia oranges and a small rough and worthless mutation. A twig here and there produces oranges in which certain sectors of the fruits show mutant tissue,² forming what may be called mixed oranges. These have probably arisen because the mutant tissue is scattered or mixed with the tissue of the original form thus constituting a "hyper chimæra."

"Mutations often occur in the cells which begin the formation of the minute ovaries in the blossom buds. As the ovary grows in size, the mutation appears as a sector of the fruit which differs in color, ripening season, or thickness of skin from the rest of the fruit. Such curious fruits have been called spontaneous chimæras" (Coit).

¹ WINKLER, H.: Ueber Pfropfbastarde und Pflanzliche Chimären. Ber. Deutsch. Bot. Gesellsch., 25: 568-576, 1907; BAUR, E.: Pfropfbastarde, Periklinal chimären und Hyperchimären, Do., 27: 603-605, 1909.

² COIT, J. ELIOT: Citrus Fruits, 1915: 121-122.

CHAPTER XXVII

CLASSIFICATION OF PLANT ABNORMALITIES

The older botanists prior to the publication of the important work of Maxwell T. Masters in 1869 gave little attention to abnormalities in plants. Linnaeus treated of them to some extent in his "Philosophia," but it is mainly to Augustin Pyramus de Candolle that the credit is due of calling attention to the importance of vegetable teratology, as throwing light upon normal structure and functions. Until the epoch-making work of de Vries on plant mutations drew attention to the absolute necessity of experimental methods in the study of normal and teratologic plants, the field of vegetable teratology was the concern of the plant morphologist and the different abnormalities were studied by comparative morphologic methods. Hugo de Vries and several of his co-workers pointed out that many abnormal forms are heritable and this suggested that the line of approach in their study was through experiments in breeding these forms to discover their origin and true character. This has been done with a few forms, but the whole field should be worked by some competent geneticist, who would devote his life to the undertaking. Without further discussion, it has been thought advisable to put in a form accessible to American college students, a glossary of the more important terms used in teratology. With the exception of a few additions the terms given in first volume of "Pflanzen-Teratologie" (1890) by Dr. O. Penzig are here translated from the original, as serving as an outline of teratology for American students.

Abortion (Masters and English authors; *Abortus*, German *Avortion* or *Avortement*, French)—Stunting of an organ, that is the exceptionally small formation of the same, whereby the form remains unchanged. The German and French authors use the same expression very frequently for the cases where a certain organ is entirely suppressed and does not make an appearance.

Acaulosity.—Acaulosia is the diminution in the size of the stem, for absolute suppression of the stem, as the terms acaulescent and

acaulescence would signify, is an impossibility in a typical plant. The term is purely a relative one.

Acheilary (Ch. Morren).—The suppression of the labellum in such flowers as the ORCHIDACEÆ.

Adesmy (Ch. Morren).—Congenital separation of organs which are normally united together, therefore, often included as atavism. Morren distinguishes between *homologous adesmy* as the separation of members of one whorl and *heterologous adesmy* the separation of the members of one whorl from those of another.

Adenopetaly.—Formation of a nectary in a former nectarless petal.

Adhesion.—Normally used for the union of parts of different whorls in the flower, for example, the union of a sepal with a petal, or of a stamen with a carpel, and also for fusion in general (of a branch with the main axis, of a leaf with a branch, etc.).

Adherence (Moquin-Tandon).—Fusion of organs which normally are separate.

Anæretic (Schimper, 1854).—Under *foliatio anæretica*, C. Schimper obviously understood the abnormal arrangement of leaves on an axis in a single row, a condition sometimes produced by a torsion, or twisting of the axis.

Antherophylly (Ch. Morren).—Formation of anthers upon leaf blades.

Anthesmolysis (Engelmann).—Central or lateral metamorphosis of an inflorescence, especially of heads as in the Dispaceæ and Compositæ.

Antholysis (Spenner in Flor. Friburg).—A solution of flowers, particularly applied to the condition in which the axis becomes elongated and the flower whorls separated from each other.

Aphyllly.—The condition of the plant in which leaves are suppressed.

Apilary (Ch. Morren).—Suppression of the upper lip in normally bilabiate flowers, as in *Calceolaria*.

Apogamy.—Vegetative reproduction of plant individuals instead of by the usual method with sex organs, especially used with reference to ferns where the antheridia and archegonia are suppressed or not functional, the young plant arising directly from the prothallium. It is also used for the non-sexual formation of embryos in the embryo sac of the phanerogams.

Apophysis.—Vegetative, central proliferation of an inflorescence.

Apostasis.—The monstrous disunion of parts normally united as in the elongation of a flower axis, as a result of which the whorls are transformed into spirals. One, however, uses the term for the separation of single floral phyllomes, for example single sepals from the calycine whorl.

Atrophy.—Wasting away; degeneration of organs; abortion.

Autophyllogeny (Ch. Morren).—The budding of one leaf from another, as from the midrib.

Balance Organic (Moquin-Tandon).—One uses this expression for cases that by atrophy of single organs of a plant is compensated by hypertrophy of others.

Biastrepis (C. Schimper).—This is analogous to the torsion, or twisting of other authors.

Blastomany (A. Braun).—Abnormal tendency of single plant individuals to develop an unusual number of leaf buds (axillary or adventitious).

Calycanthemy (Masters).—Transformation of sepals to petaloid structure.

Calyphyomy (Ch. Morren).—Adhesion of one or all of the sepals to the back of the petals.

Cenanthy (Ch. Morren).—κενὸς = empty + ἄνθος = flower: Abortion, or suppression of the stamens and pistils of a flower, leaving the perianth empty.

Ceratomany.—Abnormal formation of horn-like, or hooded, frequently nectariferous structures in a flower. Clos has employed the same term for the increase in the spurs in many families (ORCHIDACEÆ).

Chellomany (Ch. Morren).—The doubling of the lip, or labellum, in orchids, as in *Orchis morio*.

Chloranthy.—The transformation, or change of all or most of the floral parts into leaf-like green parts; frondescence.

Chorisis.—The separation of a leaf or phylloid part into more than one; dedoublement, doubling.

Cladomany.—An abnormally richly branched plant.

Cohesion.—A union between the members of one and the same whorl (particularly in flowers), or between the parts of a composite organ.

Coryphyly.—An abnormality in which a leaf ends the axis. This leaf is sometimes colored.

Crateria.—C. Schimper uses this term for a leaf blade which develops ascidia, as the ascidial white ash discovered by George H. Shull.

Cyclochorisis (Fermond).—Division of an axial organ in two directions, so that in place of a simple axis there arise whole clusters of secondary axes.

Dedoublement (chorisis, doubling).—Congenital division of an organ in which several parts arise out of a single primordium. Lateral and serial dedoublement are distinguishable.

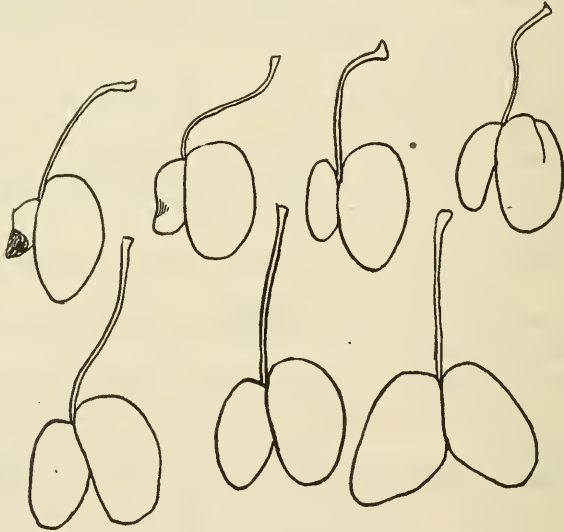

FIG. 132.—Twin cherries due to dialysis, or disjunction, of the pistil of the flower into two carpels, each of which matures into perfect drupe joined at the base with its fellow. Philadelphia Market, May 25, 1916.

Deformation.—A malformation, or alteration from the normal kind. A general expression for the irregular formation of an organ, or a complex of organs.

Degeneration (Masters).—Stunted formation of an organ with which changes of form are associated. An alteration for the worse.

Dialysis (Ch. Morren, Masters).—The separation of parts normally in one, especially parts of the same whorl. Scarcely distinguishable from adesmy (Fig. 132).

Diaphysis (Engelmann).—A central proliferation of flowers. If the flower axis elongated beyond the carpels bears another flower, we

speak of *Diaphysis floriparous*; if leafy shoots arise, it is *Diaphysis frondiparous*; if a cluster of flowers, it is known as *Diaphysis racemiparous*.

Diplasy (Fermond).—The division of an axial organ into two parts.

Diremption.—The occasional separation, or displacement of leaves.

Diruption.—A term used by Germain de St. Pierre for different appearances (division of leaves, axes, fasciation).

Discentration (C. Schimper).—A term applied to fasciation of an axial organ, but used occasionally for the multiple division of a phyllome.

Displacement (Masters).—The abnormal position of a plant organ.

Distrophy (Re).—The dissimilar formation of the homologous organs of a plant.

Divulsion (St. Germain de Pierre).—See diruption.

Ecblastesis (Engelmann).—Lateral proliferation, that is bud formation in the axils of flower parts (sepals, petals, stamens or carpels). There can be distinguished floriparous, frondiparous and racemiparous kinds of ecblastesis.

Enation.—The formation of excrescences of different kinds on the upper surface of other organs. We find scales projecting from petals, small lamina on foliage, leaves, etc.

Epanody (Ch. Morren).—Abnormal reversion of an organ to a simpler form than it normally shows.

Epipedochorisis (Fermond).—A manifold division of an axial organ in one plane. Frequently not distinguishable from fasciation.

Epistrophy (Ch. Morren).—A reversion of an apparently constant monstrosity to the normal form of single organs, for example, the development of branches with normal leaves in place of those with cleft leaves.

Etiolated.—Blanched, or lengthened abnormally by the absence of light.

Expansivity.—A term used by Germain de St. Pierre with a similar sense to Diruption and Divulsion.

Fasciation (Olaus Borrich, 1671).—A flat band-like, or ribbon-like expansion of a normal cylindrical axis, or stem, associated with departure from the normal leaf position. If flowers are developed they are generally altered in structure (Fig. 133).

Fission.—A division of a normally simple organ.

FronDESCENCE.—The proliferation of a normally reduced petal to a foliage leaf with lamina.

GAMOMERY (Engelmann).—The condition in which the normally distinct petals are united into a gamopetalous corolla.

GEMMIPARITY.—The condition of leaves which develop adventitious buds.

GymNAXONY (Ch. Morren).—The condition in which the placenta protrudes through the ovary of the flower.

GynOPHYLLY (Ch. Morren).—The transformation of a carpel into a foliage leaf. Phyllomorphy of the ovary.

HemITERY.—An abnormality of elementary organs, or of axial appendages.

Heterogamy (Masters).—An alteration in the position of the sexual organs.

Heteromorphy (Masters).—Irregular formation of an organ.

Heterotaxy.—This term is used by Masters for the cases in which a new organ, or structure, appears in unusual places, as leaf buds and flower buds on a root. Later authors (Freyhold) use the word in an entirely different sense for the inversion of the floral plan.

Homotypy.—The development of an organ, or of any

FIG. 133.—Fasciated stem and fruits of the poppy (*Papaver*). (Drawing by Alice M. Russell.)



structure in the same place, where normally another one originates.

Hypertrophy.—An abnormal largeness, strong formations of any plant part.

Idiotery.—A monstrosity by which a plant departs from the normal type and from all of its related forms.

Lepyrophyly (Ch. Morren).—The transformation of the integuments of the ovule into scales, or leaves.

Meiophylly.—The diminution in the number of leaves in a whorl, as compared with those of the preceding whorl.

Meiotaxy.—The suppression of entire whorls.

Metamorphosis.—The transformation of an organ into another one, that is morphologically equivalent to it, but it may be has a wholly different appearance and other functions.

Metaphery (Ch. Morren).—The displacement of organs, as when alternate become opposite.

Metastasis (Moquin-Tandon).—The shifting of an organ to some unusual position.

Mischomany (Ch. Morren).—An increase in the number of pedicels or the branching of the inflorescence, as in *Muscari comosum*.

Monosy (Ch. Morren).—Separation of floral parts from one another with which they normally are in Cohesion, or Adhesion. The abnormal isolation of parts due to a desmy or dialysis.

Multiplication.—The division of an order into many homologous parts.

Oolysis.—A greening (viridescence) which shows conspicuously in the carpels and ovules of the flowers.

Peloria (Linnæus).—The radial (actinomorphic) regular formation of a normal zygomorphic (irregular) flower.

Periphyllogeny (Weinmann).—The formation of numerous leaflets about the border of a leaf blade.

Permutation (De Candolle).—An enlargement of the floral envelopes with corresponding abortion of the sexual organs.

Petalody.—The metamorphosis of stamens, or other organs into petals with their usual form, color and consistence.

Petalomania.—An abnormal multiplication of petals.

Phyllocally (Lemaire).—The budding of new leaflets on the surface of foliage leaves.

Phyllody (Masters).—The appearance of foliage leaves in place of floral ones.

Phyllomania.—An abnormal production of green leaves.

Pistillody—The transformation of floral parts into carpels.

Pleiomorphy (Masters).—An abnormal or excessive development.

Pleiophyly (Masters).—The appearance of many leaves in place of a single part.

Pleiotaxy (Masters).—The increase in the number of whorls in a flower.

Plesiasmy (Fermond).—An abnormal shortening of the stem internodes, so that the leaves are arranged closely together.

Pollaplasy (Fermond).—The division of a theoretic simple organ into many analogous structures.

Polyclady.—An unusual development of branches and twigs.

Polyphyly.—The abnormal increase in the number of parts of the floral whorls.

Proliferation.—This term is used with a number of different meanings. One is the central, or lateral, outgrowth from a flower, or an inflorescence. The different kinds are designated as median, axillary, extrafloral, while each kind is again divided into foliar and floral, depending upon the nature of the adventitious bud. The axillary proliferation is known as *ecblastesis* (Engelmann) and the median as *diaphysis*.

Rachitism (Touchy).—Hypertrophy of the floral envelopes, as in JUNCACEÆ, CYPERACEÆ, GRAMINACEÆ.

Recrudescence.—The production of a leafy, or flowering, shoot from an axis of inflorescence after the formation of ripe fruit on that axis.

Rhizocallesy (Ch. Morren).—The union of two plants of the same species solely by their roots.

Salpinganthy (Ch. Morren).—The transformation of ligulate or ray florets of Compositæ into conspicuous tubular florets.

Scyphogeny (Ch. Morren).—The formation of ascidia from leaf blades.

Sepalody.—The transformation of petals into sepals, or sepaloid parts.

Solenoidy. (Ch. Morren).—The metamorphosis of stamens into tubular structures.

Solution (Masters).—Abnormal separation of the members of a whorl from those of another (similar to the *Adesmia heterologous* of Morren).

Sphærochorisis (Fermond).—Multiple division of an axis in all directions producing a witches'-broom-like arrangement of branches.

Speiranthy (Ch. Morren).—The anomalous condition in which the flowers develop into a twisted form.

Spiroism (Ch. Morren).—An elongated snail-like development of an organ.

Staminody.—The transformation of a petal into a stamen.

Stasimorphy (Masters).—The arrest in the development of an organ, or an organ complex, and the stoppage of development at a lower stage.

Stesomy (Ch. Morren).—A term with similar usage to stasimorphy.

Strophomany (Schimper).—A term used in the same sense as biastrepsis for twisting, or torsion.

Suppression.—The complete abortion of an organ.

Synandry.—The abnormal union of stamens.

Synanthy.—Lateral union of two or more flowers. This condition can arise in a number of ways; for example, by the approach and fusion of two floral fundaments, or through the partial forking of a receptacle, or through floriparous eclblastesis, etc.

Synanthody.—Lateral union of two floral buds on the same stalk, or on two peduncles which have become fasciated.

Syncarpy.—Lateral fusion of two or more fruits. This condition is the natural result of synanthy.

Synophthy (Ch. Morren).—The union of two leaf buds, or foliage shoots with each other.

Synspermy.—The fusion of several seeds.

Taxitery (Gubler).—A modification which is so slight that it admits of comparison with the normal form. Contrast Idiocracy.

Torsion.—A spiral twisting, or bending, of parts or organs.

Triplasy (Fermond).—The separation of an organ into three analogous structures. Trifurcation.

Virescence.—The abnormal development of flowers in which all organs are colored green and more or less wholly transformed to small foliage leaves. If the metamorphosis is complete, there result foliage leaves with distinct lamina and this condition is known as frondescence.

In concluding this glossary of teratologic terms, it might be well to add that a recent work on plant teratology has appeared. It is designed to bring our knowledge up to date. The first volume of

Worsdell's¹ "Principles of Plant Teratology" includes a consideration of the fungi and bryophytes as non-vascular plants and with vascular plants he goes as far as a consideration of the teratology of roots, stems, leaves and flowers. It is issued by the Ray Society, as was that of Maxwell T. Masters in 1869.

¹ WORSDELL, WILSON CROSFIELD: The Principles of Plant Teratology, vol. i., London, printed for the Ray Society, 1915; vol. ii, 1916.

CHAPTER XXVIII

SYMPTOMS OF DISEASE (SYMPTOMATOLOGY)

The preceding pages have dealt with the causes of plant diseases, that is their etiology. It remains to discuss the symptoms of disease as that is a very important matter in deciding as to the nature of the disease, and the harm that the various diseases may do to our agricultural crops. It is easy to determine that there is something wrong with the plant, because such well-known symptoms as withering, as yellowing, as abnormal growth are evidences of it, but it is quite another thing to decide as to the specific nature of the disease, its cause and probable amelioration. Even to the trained plant pathologist, it is not an easy problem to decide what the trouble is. It requires sometimes two or three years of research work with all the refined methods of modern science to reach a satisfactory conclusion, and at times even then the solution is baffling. To call a pathologist, or a botanist, an ignoramus, because he cannot by a study of the symptoms name the disease, is unworthy of people who claim to be cultured, and yet it frequently happens that the farmer's opinion of the book scientist is based upon just such a flimsy pretext. General conclusions are reached in this field of inquiry, just as in other fields, by the process of exclusion. The pathologist puts questions to himself about the plant and gradually he eliminates the impossible conditions, gradually narrowing himself down to a few possibilities. For example, he might ask himself whether the cause of the disease is external or internal. If external, then whether it is due to climate, to animals, or plant parasites. If plant parasites are concerned, then are they flowering plants or fungi. We will suppose that he finds that the disease is of fungal origin. Then with the cultural means at his disposal, the fungus must be obtained in pure culture, and its pathogenicity tried out upon healthy individuals corresponding racially, or specifically, with the diseased ones. If the inoculation of the healthy host is successful, then the recovery of the fungus from the tissues for comparative cultural study will follow.

Knowing the specific fungal organism, a great stride has been made toward a comprehensive knowledge of the disease.

The plant pathologist, who would be successful in his profession, must be acquainted with the normal, or healthy, conditions of plants, or how can he study the unhealthy states? Any departure from the healthy state is indicated by a certain behavior of the plant, or reaction to the causes of disease and certain peculiarities of structure, form and color are also manifested. An investigation of these characteristics of disease concerns symptomatology. The most common symptoms of plant diseases may be classified according to the outline presented by Heald in Bulletin 135 of the University of Texas, Nov. 15, 1909, entitled "Symptoms of Diseases in Plants."

1. Discoloration or change of color from the normal.
 - (a) Pallor. Yellowish or white instead of the normal green.
 - (b) Colored spots or areas on leaves or stems.
 - Whitish or gray: mildews; white rusts, etc.
 - Yellow: many leaf spots.
 - Red or orange: rusts, leaf spots, etc.
 - Brown: many leaf spots.
 - Black: black rust, tar spots, etc.
 - Variegated: leaf spots, etc.
2. Shot-hole: perforation of leaves.
3. Wilting: "damping-off," "wilt," etc.
4. Necrosis: death of parts, as leaves, twigs, stems, etc.
5. Reduction in size: dwarfing or atrophy.
6. Increase in size: hypertrophy.
7. Replacement of organs by a new structure.
8. Mummification.
9. Change of position.
10. Destruction of organs.
11. Excrescences and malformations.
 - Galls: pustules, tumors, corky outgrowths, crown galls, etc.
 - Cankers: malformations in the bark generally resulting in an open wound.
 - Punks or conchs and other fruits of fleshy fungi.
 - Witches' brooms.
 - Rosettes and hairy root.

12. Exudations.

Slime flux.

Gummosis: especially for stone fruits.

Resinosis: especially for coniferous trees.

13. Rotting:

Dry rot and soft rot: "the gangrene" of plant tissue.

Root rots: alfalfa, cotton, beets, cherry, etc., generally woody or fleshy roots.

Stem or trunk: dry rot of trees; rot of modified stems like rhizomes, bulbs, or tubers.

Buds.

Fruits: fleshy fruits of various kinds.

It will be profitable to discuss the symptoms of disease under the above heads.

1. *Discolorations*.—The unnatural, or false color which plants assume under diseased conditions may be included under the head of discolorations. Sometimes, as in woods, the discoloration may appear as a stain. Abnormality of color usually accompanies other symptoms of plant disease. Pallor, or chlorosis, where the plant assumes a yellowish to white, or sickly-pale hue, is due to a number of causes. Prominently, one form is due to the absence of light, whereby the plant becomes etiolated, or suffers etiolation. It is considered that the laying of wheat and other cereals is one form of this etiolation where, through lack of carbohydrates, the cellulose which forms the strengthening of the cell wall does not form properly. Sometimes the gardener induces etiolation in his celery, endive and asparagus plants, where the blanching is secured by covering such plants with soil. True chlorosis is due to an enzyme which destroys the chlorophyll pigment of the chloroplasts which are fully developed. *Icterus* is the condition where the organs are only yellow; *chlorosis*, where they are white, such as in the mosaic, or calico disease of plants formerly described. Yellowing may be induced experimentally by an excess of carbon dioxide, in fact yellowing accompanies wilting, the attack of wire worms, the presence of poisons, or acid gases.

Variegation and albinism may be apparently normal conditions of some varieties of plants, for gardeners and horticulturists grow such plants by preference for decorative uses. This variegation, or albinism,

is induced in all probability by the presence of oxidizing enzymes in patches of cells where the chlorophyll pigment is destroyed and not in other adjoining areas.

The formation of spots on leaves (Fig. 134), stems, flowers, or fruits is due to a variety of causes. The grayish or whitish spots on the under surface of grape leaves are due to mildews, on the stems of cruciferous plants to white rusts and on the leaves of the parsnip are found white spots due to a fungus, *Cercospora*. Grayish spots on the prickly pear



FIG. 134.—Apple leaves showing leaf spots produced by natural infection with *Sphaeropsis malorum*. (After Scott, W. M., and Rorer, J. B., Bull. 121, U. S. Bureau of Plant Industry, 1908.)

and on the leaves of the box trees are occasioned by a disease known as anthracnose. Many leaf spots are yellow as in violets, oaks, cucumbers and melons. The red or orange spots on plants usually suggest the presence of rusts as on wheat, rye, alfalfa and a host of other cultivated and wild plants. The so-called tar spots of the maple leaves are black in color and such discolorations of the leaf surface are traceable to the attack of a fungus, *Rhytisma acerinum*. Apples are frequently marked by fly specks which are usually clustered as small circular black spots. A fungus is the causal agent.

2. *Shot-holes* (Fig. 135).—The perforations of leaves and the formation of what are called shot-holes illustrate another form of fungous attack, where circular patches of dead tissue killed by the fungus drop out leaving a hole. The English morello cherry trees in some sections of our country have been killed during the past few years by this “shot-



FIG. 135.—Shot-hole disease of the plum due to *Cylindrosporium padi*. (After Heald, F. D., Bull. 135 (Sci. Ser. 14), Univ. of Tex., Nov. 15, 1909.)

hole” disease. When the funguses belonging to the genera *Cercospora* and *Phyllosticta* attack the leaves of Virginia creeper perforations may be formed.

3. *Wilting*.—Wilting in general is due to the lack of sufficient water to supply that lost by transpiration, for wherever the amount of water

transpired exceeds that absorbed by the roots wilting occurs. Wilting may result, if the normal ascent of the sap is interfered with by the growth of fungi into the water-conducting tissues, the entrance of bacteria into the woody vessels of the plant, whereby they are literally plugged with such organisms, or some injury which cuts off the ascending current of water. Damping-off is a form of wilt in which an oomycetous fungus enters the collar of seedling plants, or where a *Rhizoctonia* species invests the roots of the growing plants and interferes with the regular water absorptive processes.

4. *Necrosis*.—Necrosis is the mortification, or death, of the tissues. The term is usually applied to the death, or loss of vitality, of one part of a plant, while the other parts remain alive. When the fungus, *Fusarium trichothecoides*, is inoculated into Green Mountain potato tubers, in about three weeks' time it will be found that a portion of the tuber, usually the central part directly beneath the point of inoculation, has undergone necrosis. The surface of the potato tuber becomes sunken through the death and collapse of the starch containing cells and the lesions may involve half of the tuber. The black rot of the navel orange is due to a fungus, *Alternaria citri*, which gains entrance to the fruit through slight imperfections about the navel end. A black decayed area is found under the skin. This decay does not spread immediately through the entire fruit, but remains for weeks as a small black necrotic area with a mass of the fungus present. The decayed tissue does not always extend to the surface, but remains beneath the skin. Necrosis often follows the action of frost in killing the cortex cells of fruit trees in patches with a blackening of the tissues. Fire blight may be the cause of necrosis, for the cambium which is killed dries up in black patches.

5. *Dwarfing*.—A reduction in the size of a plant is very often associated with disease. This may be true of the whole plant, or some particular organ only may be dwarfed. Apples are frequently reduced in size by the attack of the scab fungus, sometimes not reaching one-fourth the size, and the same is true of apples affected by the cedar rust. Dwarfing of the whole plant may be a symptom of malnutrition. It may be evidence of a poor soil, or the repeated maiming, or nipping off of the buds by cattle, or purposely by man, as is the case with the miniature trees of the Japanese. Dwarfing, or nanism, may be the result of climate, as is the normal case with alpine plants. Prostrate forms of

trees of great age are formed by the action of the climate of high mountains, or by growth in porous sand on exposed sea dunes. Atrophy, or the non-formation of parts, or organs, is a phase of dwarfing. It is seen in the dwindling of organs in size, as the result of various causes, such as the attack of fungi. The carpels of *Anemone* are atrophied in plants infested by *Aecidium* and the whole flower is suppressed when the cherry is attacked by *Exoascus cerasi*. *Exoascus pruni* is responsible for the absence of the stone in plum fruits, etc.

6. *Hypertrophy*.—The undue excessive development of a plant part is a symptom of a diseased condition of that part. The bladder plums formed in the plum pocket disease are good illustrations of hypertrophied tissues, as the replacement of the rye ovary by the ergot sclerotium, following the entrance of the spores of *Claviceps purpurea*. The attack of *Gymnosporangium bisepatum* (Fig. 136) results in the massive enlargement of the stem of the white cedar. A rust fungus is responsible for the increase in size of the twigs and petioles of our common ash and elder.

7. *Replacement*.—A new structure takes the place of organs.

8. *Mummification*.—The drying and wrinkling of fruits and other plant parts where the general shape of the part is preserved, but in a reduced size, is an evidence of the unhealthy condition of that organ, or part. The attack of the black-rot fungus, *Sphaeropsis malorum*, brings about a slow desiccation of the fruit which may remain hanging on the tree over winter and in a shriveled condition. Frequently, the mummies produce a crop of spores, which spread the disease.

9. *Alteration of Position*.—The change of position of an organ from its normal one is a sure symptom of disease, usually the attack of some fungous parasite. The normal position of the leaves of the house leek, *Sempervivum tectorum*, is that of a rosette with the spirally arranged



FIG. 136.—Swelling of main stem of white cedar caused by *Gymnosporangium bisepatum*. (After Harshberger, *Proc. Acad. Nat. Sci., Phila.*, May, 1902.)

leaves approximately horizontal. When attacked by a rust fungus, *Endophyllum sempervivi* (Fig. 137), the diseased leaves grow erect. The same is true with our native American hepatica, *Hepatica triloba*. Infrequently, it is attacked by a rust fungus in the aecial condition, *Tranzschelia punctata*, so that (Fig. 138), the rusted leaves develop a larger, stiffer petiole, stand erect with a smaller, stiffer leaf blade on which the æcia are found. The common garden purslane *Portulaca oleracea*, usually grows in a prostrate position, but when attacked by the white rust, *Cystopus (Albugo) portulacæ*, many of the diseased branches become erect or ascending. The stems of *Vaccinium vitis-idaea* become erect the second year after infection by *Melampsora Goeppertiana*.

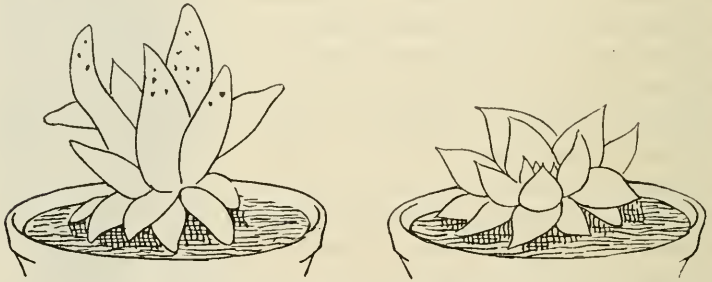

FIG. 137.—Two plants of house-leek, *Sempervivum*. Left one affected by *Endophyllum sempervivi*. Right one, a healthy plant. (After Grove, W. B.: *The British Rust Fungi*, 1913: 54.

10. *Destruction of Organs*.—The destruction of plant organs by the attack of fungi is well illustrated by the cereal smuts, which attack the flower parts reducing them to a black powdery mass of spores, which are carried away, leaving nothing but the bare axis on which the flowers were originally situated.

11. *Excrescences and Malformations*.—These will be treated of in detail in another chapter. Here it may be said that galls, pustules, tumors, corky outgrowths, crown galls, cankers, burls, or knauers, (Fig. 139) witches' brooms (Fig. 140), etc., are evidences of diseased conditions. The nature of these excrescences and malformations cannot be discussed here, but it may be said that they are specific and usually associated with the attack of some fungus, as for example the plum knot due to *Plowrightia morbosa*, the cedar apples formed on the



FIG. 138.—*Hepatica triloba* parasitized by a rust fungus, *Tranzschelia punctata*, which causes some of the leaves to stiffen and grow erect. Left figure shows æcia, April 29, 1915.

red cedar by *Gymnosporangium juniperi-virginianæ*. The crown galls, or possible vegetal cancers, are another illustration of such excrescences, while malformations are represented by peach leaf curl and the witches' brooms on trees.

12. *Exudations*.—The formation of slimy substances, which flow from trees and plants, the diseased conditions known as bacteriosis, gummosis¹ and resinosis, illustrate the character of the exudations from



FIG. 139.—Burl, or enlarged base of an oak tree in the forest on Gardiner's Island, New York, July 17, 1915.

plants under abnormal conditions. The production of clear amber-colored secretions, which accumulate on the surface of the diseased parts, is known as gummosis and is seen in cherries, apricots, almonds and many other trees. It follows wounds or the attack of fungi. The same condition in coniferous trees is known as resinosis and in a few trees it is of economic interest because, as in the spruce, the exudation of

¹ WOLF, FREDERICK A.: Gummosis. *The Plant World*, 15: 49-59, March, 1912.

BUTLER, O.: A Study on Gummosis of *Prunus* and *Citrus*. *Annals of Botany*, 25: 107-153, 1910.



FIG. 140.—Branch-knot or witches'-broom of the Hackberry (*Celtis occidentalis*).
(After Kellerman, W. A., *Mycological Bulletin*, Nos. 61-72, July, 1906.)

gum rosin known as "spruce gum" is collected and sold at from two dollars to two dollars and fifty cents a pound.¹ Where due to the attack of bacteria it is called bacteriosis. Tumescence is the over-turgescence of plant tissues due to the excess of water. It sometimes indicates pathologic changes and was formerly called *adema*, or dropsy. Flux is another name applied to the issuance of fluids from wounds in trees, while slime flux issuing from wounds may be frothy, owing to the fermentative activity of yeasts and other fungi, which live in such slimes. Manna flux is found in such trees as the manna ash and species of tamarisk. Cuckoo spit is a frothy material found on grasses and

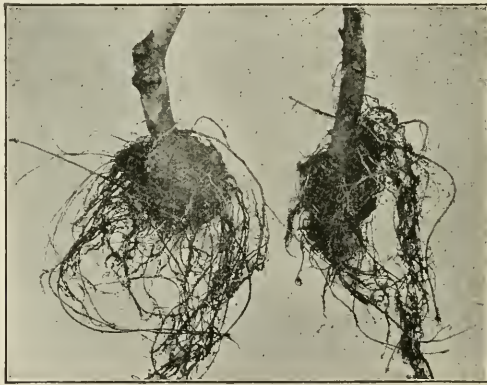

FIG. 141.—Crown gall with hairy root on nursery stock of Northern Spy apple. (From Marshall after Paddock.)

other plants in which green sucking insects live. Honey-dew is the excretion of plant lice, or aphides, and its presence encourages the growth of fungi (*Meliola*, *Scorias*).

13. *Rotting*.—Rottenness of plant parts is the state of decomposition putrefaction, or decay usually associated with the formation of malodorous, or putrid substances. Several kinds of rots are distinguished as dry rot, soft rot, black rot and gangrene. Usually such rot or gangrene is due to the presence of some bacterial, or fungous organism, which brings about the decomposition of the parts attacked. The decay may be slow, or rapid. Sometimes the rot is associated with the production of bitter substances, as in the bitter rot of apples.

¹ RECORD, SAMUEL J.: Harvesting the Spruce-gum Crop. *The Country Gentleman*, Feb. 26, 1916, p. 475.

The wet rot of potatoes is probably due to putrefactive bacteria. The tissues become soft, then mushy, and finally become a liquid mass with a vile smell.

BIBLIOGRAPHY OF PLANT DISEASES IN GENERAL

- HEALD, FREDERICK D.: Symptoms of Disease in Plants. Bull. 135, University of Texas, Nov. 15, 1909.
- KLEBAHN, PROF. DR. H.: Grundzüge der allgemeinen Phytopathologie. Berlin Gebrüder Borntraeger, 1912.
- KÜSTER, DR. ERNST: Pathologische Pflanzenanatomie. Gustav Fischer in Jena, 1903, Zweite Auflage, 1916.
- KÜSTER, DR. ERNST: Pathological Plant Anatomy. Authorized translation by Frances Dorrance, 1913-1915.
- SMITH, JOHN B.: Economic Entomology for the Farmer and Fruit Grower, and for Use as a Text-book in Agricultural Schools and Colleges, J. B. Lippincott Co., 1896.
- STENGEL, ALFRED: A Text-book of Pathology, W. B. Saunders Co., Philadelphia, 1906.
- WARD, H. MARSHALL: Disease in Plants, Macmillan Co., & 1901.

CHAPTER XXIX

PATHOLOGIC PLANT ANATOMY

With the multiplicity of higher plant forms, in which the same end is attained in a diversity of ways, the terms normal and abnormal become in one sense merely relative terms for what apparently is the normal method of procedure in one group of plants, may be decidedly different, or abnormal, in other uncommon groups. The words normal and abnormal are, therefore, variable terms, but useful ones. Specifically, when we use the word abnormal, we mean the departure, or deviation, from the normal (average) structure or function of the members of any group selected for investigation. Pathologic plant anatomy, therefore, has to deal with abnormal, but not necessarily diseased organs, and yet a study of diseased tissues is an important subject of investigation for the plant pathologist.

The material which forms the substance of our inquiry naturally falls into two principal groups.

1. The differentiation, number or size of the cells of pathologic tissues remain more or less below the normal, so that the tissues in one or more ways remain in a stage of incomplete development. The term **HYPOPLASIA** designates those abnormal processes of formation, which compared with the corresponding normal processes of development appear retarded as it were and prematurely.

2. The pathologic cells and tissues exceed the conditions of differentiation and growth characteristic of normal plants, so that a treatment of such necessitates a consideration of several independent groups.

(a) The abnormal cells differ from the normal ones only in their internal structure (contents, mechanics, etc.) and for the processes of differentiation by which the tissue cells supplement their normal qualities, or exchange them for new ones, the term **METAPLASIA** is used.

(b) The increase in size of abnormal cells over normal ones is termed **HYPERTROPHY** (*ὑπέρ* = over, excessive; *τρέφω* = to nourish), and it is not important fundamentally whether the histologic structure

of the cells concerned remains similar to that of the normal ones, or is altered in some way.

(c) The increase of a part by an increase in the number of its individual structural elements is known as *HYPERPLASIA* (*ὑπέρ* = over, excessive; *πλασία* = formation, structure), and this depends on cell division following cell growth. A large number of abnormal formations arise through hyperplasia and the histology of the newly formed tissues is exceedingly varied.

3. The processes of *RESTITUTION* consist in the restoration of structures, which resemble those lost in injuries and mutilations of the plant body. Although the tissues thus formed are like the normal ones yet their formation following injuries, or mutilations, comes within the realm of pathologic anatomy.

Hence we shall treat of morbid anatomy under the five heads suggested in the above considerations. Naturally the material for our investigation and treatment arranges itself into five chapters, on "Restitution," "Hypoplasia," "Metaplasia," "Hypertrophy" and "Hyperplasia."

RESTITUTION

Following a wound or other injury or the removal of a plant part, the organs are stimulated to renew the lost part, or to repair the damage to the cells or tissues. The regeneration of lost or injured plant cells, tissues, or organs, is called specifically in pathologic plant anatomy restitution, while the word regeneration, although implying restitution (*L. restitutio* (-n), < *restitutus*, pp. of *restituo*, restore, < *re-*, again, + *statuo*, set up, < *sto*, stand), is used in a somewhat different sense.

The process of restitution, it is conceivable, includes a number of distinct operations.¹ The newly formed parts are formed at the place of amputation and are like the lost portion (as the regeneration of root tips) or the newly formed parts, which resemble the lost ones, are not produced at the injured place, but some distance away from it, or the new parts arise on the cut surface, but are unlike the lost part (heteromorphosis), and finally the new parts do not resemble the lost ones, nor do they arise at the surface of the amputation.

It will be profitable to discuss the two most important forms of

¹ Consult Studien über die Regeneration v. PROFESSOR DR. B. NĚMEC. Mit 18 Textabb.

restitution, viz., that of the cell and that of the tissues. The experiments of Tittman have shown that the waxy cuticle of the castor-oil plant, *Ricinus communis*, may be restored after removal. Exposure of the protoplast results in many cases in the formation of a new cell membrane, as is illustrated in some of the large-celled algæ belonging to the SIPHONÆ. Frequently, it is possible to demonstrate the restitution of the cell membrane by the process of plasmolysis in which the protoplasm is made to retreat from the cell wall. The time varies for its formation under conditions of plasmolysis. In *Conferva*, it takes place in one to two days, in *Zygnema* in three to four days. When the root hairs of dicotyledonous plants are plasmolyzed new membranes are formed about the protoplast.

Wounded siphonaceous algal cells (*Caulerpa*, *Valonia*, *Vaucheria*), where the cell wall has been injured, are capable of restoring the cell wall. Some fungi show such restitution also, while the injured cells of the higher plants lack this power. A few exceptions are known where nettle hairs of *Urtica dioica* may imperfectly replace the broken-off tip. Pricking the turgid cell of *Valonia utricularis*, as I have done with fresh specimens in Bermuda, is followed by the escape of a liquid jet and later the opening is closed by a gall-like, protoplasmic, chlorophyllless plug.

It has been demonstrated that the important cell wall can be regenerated on fragments of protoplasm provided the influence of the nucleus is felt in such formation. Klebs has shown that, with the removal of the nucleus from the cell, that cell has lost all its power to produce new cell walls, but a distant nucleus may extend its wall-forming influence, when removed several millimeters away in an adjoining cell.

In the restitution of tissues, we will consider those cases in which the injured cells remain unhealed, but in which the uninjured neighboring cells bring about the restitution. The removal of the rhizoidal hairs on the thallus of *Marchantia* is followed by the appearance of other hairs in a few days, which may grow out through the cavity of the mutilated one as described so carefully by King. The mutilated tip, or growing point, of many multicellular algæ is replaced by the development of the uppermost intact cell. Brefeld found in the sclerotia of *Coprinus stercorearius* the inner cells are able to regenerate the outer black cuticularized coat, if that is removed.

The number of cases of tissue restitution known in the higher plants

are few. The peridium, or secondary tegumentary tissue of stem or root, is easily regenerated, as is seen in the formation of new cork layers in the cork oak after the removal of older ones. The epidermis is not always replaced but Massart found that removal of the epidermis of *Lysimachia vulgaris* resulted in the regeneration of a new hair-bearing epidermis. The regeneration of the vascular bundles has been studied in monocotyledonous plants and in dicotyledons. The regeneration of roots in monocotyledons consists in the replacement of epidermis, phloem and xylem. In dicotyledons before the wood and bast are replaced there is a regeneration of the endodermis, so that the restoration of central cylinders, that have been destroyed, is not unusual.

HYPOPLASIA

The condition of hypoplasia in plants is one of arrested developments. The organism, or one of its parts, does not reach normal development, but that development is arrested, or stopped prematurely. Hypoplasia is, therefore, defective development. The plant morphologists and plant anatomists are chiefly concerned with the problems of arrested development and recently awakened interest has been taken in its study, because it has been found that the interpretation of certain phenomena is subject to experimental treatment, and hence, there has arisen a coterie of experimental plant morphologists. Such investigators have found that the processes of growth and differentiation are not always equally arrested, which are associated in time and place in the normal course of development. For example, leaves differ from the normal by their small size. They may be retarded in their form, as the narrow leaves of *Sagittaria* produced under water, or the form may remain entirely undeveloped. We will treat of hypoplasia as to the number of cells, as to the size of the cells, as to the differentiation of the cells and the tissues.

A. Number of Cells.—It has been found in a study of the dwarf forms of plants such as occur on high mountain tops that the condition of nanism is not so much due to a decrease in the size of the cells over those of the normal plant, but is chiefly conditioned on a reduction in the number of cells. The internodes of plants may be shortened, the size of the leaf blade may be reduced, the thickness in the leaf may be reduced, and this reduction in size is usually associated with a loss in the

number of cells, as for example, the omission of one of the palisade layers of the leaf. External factors are important in determining the structure of the leaf tissue, for the leaf more than any other plant organ is an index of the influence of climate. This fact is emphasized by a work entirely devoted to this subject and given the appropriate title of "Phyllobiologie." There is a marked difference in the thickness of beech leaves, for example, which have developed under different environmental conditions, as I have proved satisfactorily by the use of calipers and microscopic measurements, which show an accurate coincidence. The thickness, or thinness, of such a leaf depends essentially on the number of rows of cells. The thickest leaves with the largest number of palisade layers which I have studied, grew in the bright sunlight in exposed places along the edge of a salt marsh at Cold Spring Harbor, Long Island. Sun leaves back from the influence of salt water were thinner and broader, while those growing in the dense shade of the forest in an inland situation near Philadelphia were the broadest and thinnest of all. Not only was the mesophyll modified in these leaves, but a marked difference was found in the shape of the epidermal cells in the sun and shade leaves.

The number of cells which arise from the cambial layer suffers a marked diminution in trees which grow under unfavorable climatic life conditions. Drought, strong winds, pressure, unfavorable light and nutrition are disturbing factors. Growth activity of the cambium may cease entirely, if these factors become too intensive. Huntington has proved abundantly by his study of yellow pines of New Mexico and the big trees of California that climatic cycles of wet and arid conditions in the past history of North America can be determined from a study of the size and character of the annual rings due to the cambial activity of those trees, and he has plotted curves showing this relationship for a period approximately 3500 years in the case of the big tree, *Sequoia gigantea*.¹

B. Size of Cells.—The size of cells must be considered also in discussing the phenomena of hypoplasia. Abnormally small cells may be produced in different ways: A fresh division of the cells may take place before the cells have reached the average size which they assume under normal conditions. Klebs recites a case where he culti-

¹ HUNTINGTON ELLSWORTH: The Climatic Factor. Publ. 192, Carnegie Institution of Washington, 1914: 153.

vated *Euastrum verrucosum*, a desmidiaceous alga, in 10 per cent. cane sugar. The daughter cells formed by a previous division of those cells divided again before they had attained their normal size. The conditions in the higher plants where hypoplasia is shown by the production of abnormally small cells are such that the period of elongation, which normally follows the last cell division, does not take place, or is stopped part way. Abnormally narrow tracheal tubes are found in dwarfs, in etiolated and poorly nourished plants, or in individuals infected by fungi, or gall-producing animals. Disturbances in nutrition reduce the size of the wood elements produced by cambial activity.

In the study of the differentiation of cells and tissues, those cases should be considered first which concern the individual cells, where the formative process may stop prematurely. An investigation of *Udotea Desfontainii* shows the arresting action of unfavorable life conditions upon the development of the cell form. The leaf-like part of this alga is composed of elongated sacs, which run lengthwise and parallel, with numerous side branches of limited growth, which interlock to give the thallus its characteristic firmness. If artificially cultivated, the parallel sacs show undiminished growth activity, but the side branches no longer show limited growth, but unlimited, and the thallus loses its wonted form.

Arrestment of the development of the cell wall is indicated in the partial, or entire cessation of the secondary growth in thickness, and as a result, the elements normally thick-walled have walls of only moderate thickness. Weak, or insufficient, transpiration acts *pari passu* in a poor development of the cuticle of epidermal cells. Dwarfed plants frequently show weakly developed cell membranes, as a sign of disturbances in the nutritive processes. Chemic changes may be associated with hypoplasia. Lignification is rarely excluded in the formation under disturbing influences of the woody elements of plants. The cells of the medullary parenchyma in thorns (*Crataegus*) remain unlignified, when infected with a rust fungus, *Roestelia*. Finally, the formation of cross walls may remain incomplete, thus giving rise to chambers, sometimes communicating with each other.

Hypoplasia, as it affects the cell contents, may be seen in the reduction in the number of chloroplasts in variegated leaves, in plants with pale-green leaves and in plants which grow in places saturated with

vapor. The individual chlorophyll grains may not attain their normal size, remaining small. The formation of chlorophyll presupposes a certain temperature, the action of light, the presence of iron and certain organic food materials. Low temperature may reduce chlorophyll formation, as is seen in grain seedlings and bulbous outgrowths or with yellowish color grown under a low temperature. Deficiency of light and iron causes etiolation, more especially chlorosis, or icterus in the absence of normal pigment due to the lack of iron, while in vines unable to absorb iron chlorosis may take place with abundance of iron in the soil. Sometimes it happens, on the other hand, following the attacks of an insect that ripening lemons remain green-flecked. This condition is due to arrested development of the chloroplasts, which normally would be transformed to yellow chromatophores.

Light also seems to influence the development of the red pigment, anthocyanin, as is especially noticeable in varieties of *Coleus*, while other parts, such as rhizomes, bulbs and roots, which remain underground, are richly provided with anthocyanin. Chromogenic bacteria may lose the power of producing pigment, as is illustrated by *Micrococcus prodigiosus* grown at the high temperature of 40°C. A.F.W. Schimper and other botanists have shown that the formation and distribution of crystals of calcium oxalate in plants is to a large extent dependent on external factors. Shade leaves contain fewer crystals than sun leaves and plants grown in moist air, or without light, are also poor in these crystals.

C. Tissue Differentiation.—The arrestment of tissue differentiation can be illustrated in simple algæ where the cells are united into colonies. When the green alga, *Scenedesmus caudatus*, the end cells of which have gelatinous horns, is subjected to abnormal life conditions the horns do not form. In the consideration of tissues of multicellular growths it may be said that there is no organ in which homoplasia may not appear. Examples have been found in the hepatic and true mosses.

The best illustrations of the developmental arrest of tissues are found among the flowering plants, where as one case the guard cells of the stomata may be arrested by a lowered transpiration and weak illumination. Stapf in his experiments with the potato, *Solanum tuberosum*, showed that under normal conditions there was one stoma for every forty-six epidermal cells, and in specimens matured by him in gaslight,

there was a pair of guard cells for every 204 epidermal cells. The formation of the hairs on the edge of the ocrea of *Polygonum amphibium* is entirely suppressed in the form *natans*, which is grown under water, while they are present in the form *terrestre*. The modification of the mesophyll tissue in homoplasia is due to the character of the environment. Plants cultivated in places saturated with moisture, or after infection by fungi or animals, show a homogeneous development of the mesophyll.

In homoplasia, the vascular bundles decrease in number, the mechanic tissue degenerates and the collenchyma sometimes does not

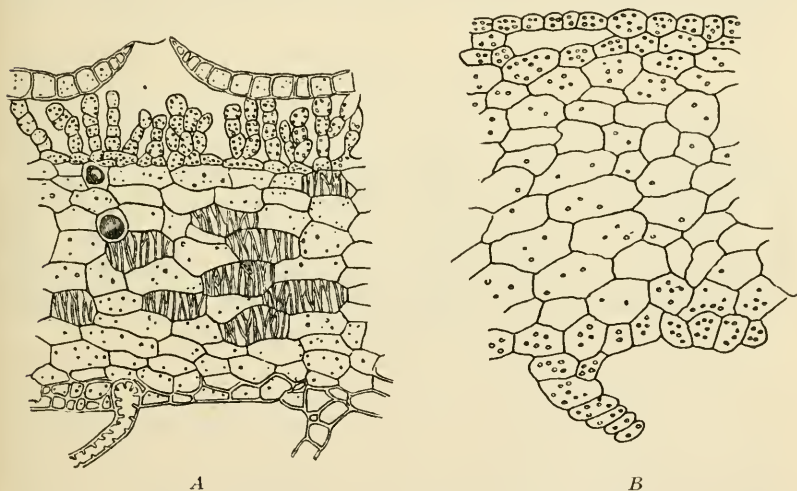

FIG. 142.—A, Cross-section of a normal thalloid shoot of *Lunularia*. (After Nestler, *Die natürlichen Pflanzenfamilien* I. 3, p. 17.) B, Cross-section of a thalloid shoot grown in the absence of light. (After Beauverie in *Küster Pathologische Pflanzen Anatomie*, 1903: 42.)

form. Thouvenin by the use of mechanic pressure retarded the development of the woody tissues in the stem of *Zinnia*. The stems of *Cardamine* grown under water develop no mechanic tissue. The length of the vascular bundles is less in plants grown in moist places over plants which transpire strongly. Stahl found in his study of the leaves of *Lactuca scariola*, that the mesophyll consists of palisade cells throughout in the vertical leaves and in horizontal leaves lighted from above of palisade cells only on the upper side of the leaf. If we call upon homoplasia to explain the formation of shade leaves (Fig. 142), as

the unavoidable product of some arresting factor, then the structure of shade leaves and those from alpine habitats, as well, as those placed under water and which have a shade leaf structure, lose their remarkable character. Taking into consideration all of the experiments which have been performed, it may be stated in concluding this chapter, that all of the described hypoplasias may be traced back to scanty nourishment. We are probably correct in assuming that there is poor nutrition in plants grown in distilled water, in the dark, in an atmosphere deprived of its carbon dioxide in moist places, or under water. Insufficient nourishment leads to an arrestment of differentiation and this becomes evident in a number of ways.

METAPLASIA

Metaplasia has been defined as the progressive change of any cell, which is not connected with cell division and cell growth. The emphasis in this definition is upon the word progressive in contradistinction to the word regressive. Metaplasia is less important in the histology of plants than it is in animal histology. Changes of a metaplastic kind are produced in the cells of plants, especially in the production of new cell contents, or of the cell wall by increase in thickness.

Cell Contents.—Frequently, it happens with tubers, bulbs, rhizomes and roots of many plants that they develop a green color in place of their normal chlorophyllless character. Potato tubers kept in a damp, warm, sunny place sometimes develop a green color and become poisonous through the formation of metaplastic solanin. Bonnier found that the tissues of his experimental plants exposed to strong arc lights turned green even to the pith. Likewise red pigment dissolved in cell sap may appear as a metaplastic change. For example, the normally green pitchers of *Sarracenia purpurea* become purplish green when the plant is grown in intense sunlight. Such is also true in the heather, *Calluna vulgaris*, *Azolla*, many succulents as *Opuntia* and *Sedum*. Injury to plant parts may be followed by the development of a red color. The normal color of the leaves of *Saxifraga ligulata* are green, but if leaves are cut through the midrib, a red coloration developed along the edges of the wound. Parasitic fungi may cause a local reddening of the cells affected as in certain fruit and leaves spot diseases. The metaplastic formation of coloring matters appears in the so-called graft hybrids.

The excessive formation of starch in the leaves of such plants as the buckwheat, *Polygonum fagopyrum*, when insufficiently supplied with chlorine is a case in point, as also the unfavorable nutrition occasioned by potassium salts, while Schimper succeeded in getting the same accumulation of starch in unusual amounts in the leaves of *Tradescantia selloi* by cultivation in nutrient solutions free from calcium.

Cell Membranes.—The metaplastic modifications of cell walls may be considered under two heads. The first condition is found where bordered pits are formed, as in such orchids as *Cymbidium ensifolium*, *Lælia anceps* and *Epidendrum ciliare*, whose leaves have been scarred. The second modification is seen where the cell walls have been thickened abnormally by cellulose knobs, or thickenings. Such cellulose deposits occur about calcium oxalate crystals, oil drops, as in PIPERACEÆ, LAURACEÆ and about the hyphæ of fungi which penetrate cells, the hyphæ along with certain cytoplasmic inclusions being surrounded by the cellulose sheath bridging the space of the cell. Wortmann has found heavy wall thickenings in the epidermis and bark of beans and other twining plants, if they are prevented from carrying out their reaction curvatures, while Küster noticed the lignification of the cell walls in the leaves of *Juglans* under the influence of certain plant lice.

CHAPTER XXX

PATHOLOGIC PLANT ANATOMY (CONTINUED)

HYPERTROPHY

The plant pathologist applies the word hypertrophy to an abnormal process of growth in which the individual cells are larger than the normal, or when whole tissues become enlarged, or distended. Cell division is left out of account as a means of the formation of hypertrophied cells, or tissues. The cells which are enlarged may be derived from the meristematic elements, which have continued their growth to the enlarged size, or cells continue their growth longer and more intensively, or cells of permanent tissue are concerned, which take up anew the process of growth in size. The cell may enlarge in all of its dimensions, so that the original shape of the cell is maintained, or it may enlarge in one or two directions, when the original shape is no longer kept. If the enlargement is in two directions the cell will be distorted, if in one direction it will grow abnormally long. The extent of the enlargement and its direction will be determined by the character of the surrounding cells, or their absence. An hypertrophied cell may be surrounded by cells incapable of distention, hence its enlargement will be limited to the size of the available free space. Küster distinguished two kinds of hypertrophy, cataplastic and prosoplastic. Cataplastic hypertrophy is an abnormal increase in the volume of cells associated with degenerative atrophy of their living contents, for the functional decline of the cell has been termed by Beneke, cataplasia. Prosoplastic hypertrophy involves new anatomic characteristics and functional activities, for the cells store up fats, proteins and starches, or develop chlorophyll, or red coloring matter. The involution forms of *Bacillus radicicola*, which forms the leguminous root tubercles, and those of the crown-gall organism, *Pseudomonas tumefaciens*, are examples of simple hypertrophied cells (Fig. 143). With these preliminary remarks it is important to illustrate the different kinds of hypertrophy which have been described by plant pathologists. The most simple cases are those in which the meristematic cells capable of division have grown to

an abnormal size by the omission of cell division. Under the influence of a fungous parasite, *Chytridium sphacellarum*, the apical cells of the lateral branches of an alga, *Cladostephus spongiosus*, stop dividing and enlarge into club-shaped swellings at their upper end. If specimens of *Padina pavonia*, a siphonaceous alga, be inverted and are exposed to

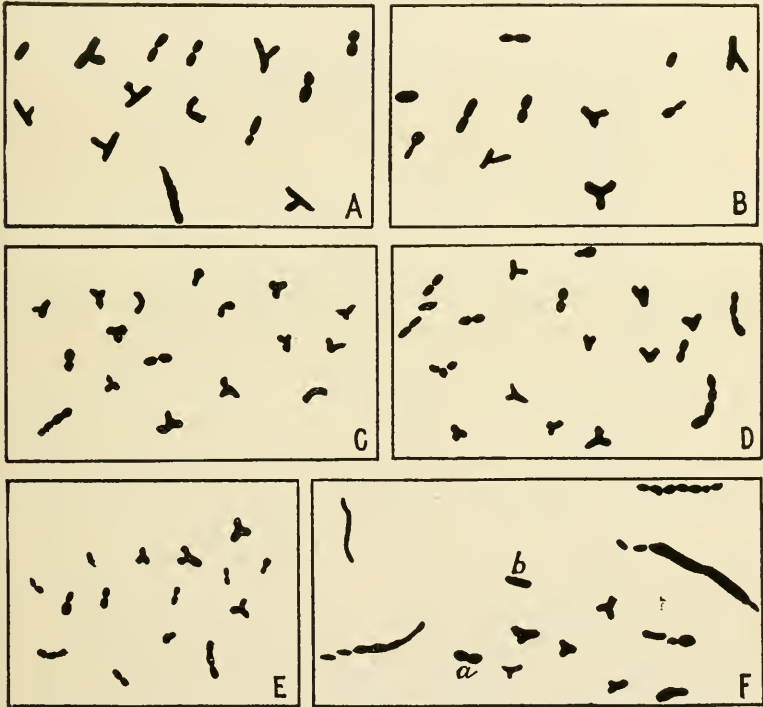

FIG. 143.—Drawings of rods and involution forms of *Pseudomonas tumefaciens* from young tumors. A, B, Daisy on daisy; C, D, hop on red table beet; E, F, hop on sugar beet. (After Smith, Brown, McCulloch, Bull. 255, U. S. Bureau of Plant Industry, 1912.)

light, their spiral edges uncoil and the cells of the apex enlarge into vesicular form. The hyphæ of the sterile mycelium of *Rozites gongylophora* found in the fungous gardens of the tugging-ant, *Atta*, show regular ball-like swellings on the ends of the hyphæ. These united into thick groups form the kohlrabi growths which serve the ants as food.

Etiolated plants afford interesting examples of hypertrophy, for in the absence of light the internodes of the stems and the petioles of the leaves become inordinately long. If this follows cell divisions, then it is a hyperplastic phenomena, but where it is due to the abnormal lengthening of existing cells, it is a simple case of hypertrophy. Küster found in the etiolated peduncles of *Tulipa Gesneriana*, that the cells were from a third to a half longer than the normal ones. Longer cells than usual are produced in plants grown experimentally in moist air.

Hyperhydric tissues are abnormal and are formed by an excess of water within the plant. They constitute a homogeneous group from a causative (etiologic) point of view. As examples may be cited the spongy white masses of cells which appear in the lenticels of the twigs of alder, poplar, willow when such twigs are placed in water. The individual cells of this porous tissue are chlorophyllless, have a thin layer of cytoplasm and a clear abundant cell sap. Such water lenticels were compared by Schenck with typic aerenchyma found on numerous water plants. Such lenticel excrescences arise from normal lenticels by the enlargement of the phelloderm cells and in some cases the bark cells lying under the lenticel hypertrophy. Von Tubeuf and Devaux give extensive lists of the plants which produce hypertrophied lenticels.¹

Bark excrescences form another kind of hypertrophied tissue. They have been produced experimentally on the bark of the red currant, *Ribes aureum* (Fig. 144). In such boss-like excrescences the parenchyma cells of the bark grow out into long sac-like cells of different form and size by growth in a radial direction. Not only the cells of the outermost bark layers take part, but all the elements down to the wood take part in the abnormal growth and have become completely or nearly colorless. The firm connection between bark cells is lost and they are separated from each other by large intercellular spaces. Sorauer kept cuttings of shoots of *Ribes aureum* several years old in a vessel of water and in moist air. At the end of four weeks extensive excrescences were formed.

Intumescences are small pustules, which are formed only in limited areas, and their formation follows the same processes of growth as in the case of bark excrescences. They are known in the branches of *Acacia pendula*, *Eucalyptus rostratus*, *Lavatera trimestris* and *Malope*

¹ KÜSTER, DR. ERNST: Pathological Plant Anatomy, authorized translation by FRANCES DORRANCE, 1913: 74-75.

grandiflora. They are formed on the side of the branches exposed to the sun and the bark cells are elongated in a radial direction, finally breaking through the epidermis as spongy masses of cells. Leaves also produce intumescences. Originating in the mesophyll cells, they

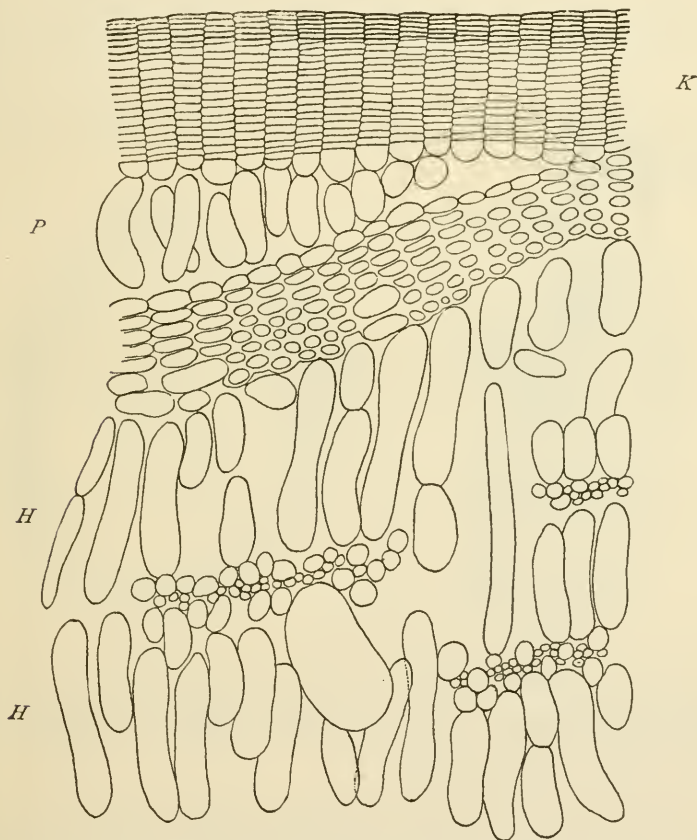

FIG. 144.—Cross-section of a part of a strongly hypertrophied bark of *Ribes aureum*. K, Cork; P, periderm; H, abnormally elongated bark cells. (Küster, *Pathologische Pflanzenanatomie*, 1903: 80.)

appear as greenish or whitish pustules of varying size and beneath the cells lose their chlorophyll content. Cataplastic hypertrophy explains the origin of some intumescences. For example, the lower cells of the several-layered epidermis of *Ficus elastica* are pressed together by the

growth of the mesophyll cells and the space originally occupied by the former is finally filled with the cells of the mesophyll. Excess of water is one of the contributing causes in the formation of intumescences, as also treatment of plants with poisons, especially copper salts.

Abnormal succulence, as an hypertrophy, is such where plants with normally thin leaves, develop thick ones in their place. Salt solutions, if used experimentally upon certain plants, may induce succulency. LeSage produced artificial succulence in the leaves of *Lepidium sativum* by abundant doses of common salt, NaCl. The mesophyll cells were elongated greatly.

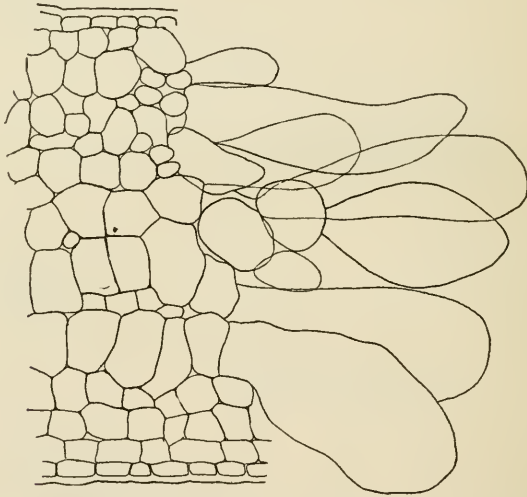

FIG. 145.—Cross-section through the wounded border of a cabbage leaf. The hypertrophied mesophyll cells are enlarged into vesicular swellings. (Küster, *Pathologische Pflanzenanatomie*, 1903: 94.)

Callous hypertrophy arises after an injury when the living cells of an organ enlarge without division, especially at the edge of the wound, where they may enlarge to many times their normal volume (Fig. 145). As it frequently happens that cell divisions follow an injury, it is not always easy to distinguish between callous hypertrophies and callous hyperplasias. We find callus hypertrophies among the thallophytes, as in *Padina pavonia*, and in the higher plants where the bark, wood parenchyma, leaves are affected. Küster produced callous hypertrophies near the upper surface of the cut by keeping one end of the

cutting under water, the other extending into moist air. The bark cells were enlarged greatly, producing ball-like or weakly lobed forms. Only single cells in the bud hypertrophied and they grew out into large colorless vesicles. Miehe has found *Tradescantia virginica* a suitable object to produce callous hypertrophies experimentally. The destruction of cells, or cell groups, of the epidermis causes the formation of empty places which are filled by the neighboring cells which close the

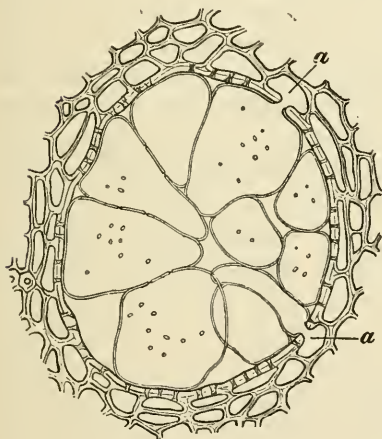

FIG. 146.—Pitted vessel of black locust, *Robinia pseudacacia*, filled with enlarged parenchyma cells or tyloses. At *a* the connection between tyloses and original cell is seen. (Küster, *Pathologische Pflanzenanatomie*, 1903: 100.)

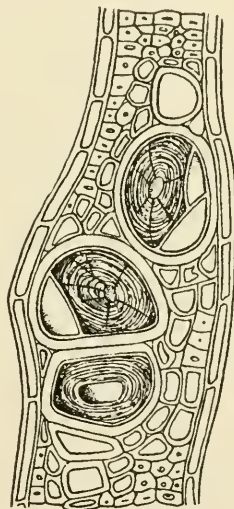

FIG. 147.—Cross-section through old wood of *Mespilodaphne sassafras*. The lower vessels contain stone tyloses, the upper besides stone tyloses, contain thin-walled tyloses. (After Molisch in Küster, *Pathologische Pflanzenanatomie*, 1903: 100.)

opening. Haberlandt in his culture of isolated tissue elements obtained abnormally large cells which should be classed among callous hypertrophies. He kept alive isolated mesophyll cells from the leaves of the purple dead nettle, *Lamium purpureum*, for weeks in Knop's solution, or in nutrient sugars, and these cells grew perceptibly at the same time that a thickening of their membranes took place. The exact causative influence in the development of callous hypertrophies is still an open question.

Tyloses¹ are more or less closely packed, bladder-shaped intrusions derived from the parenchyma cells adjoining the cavities of water-conducting elements into which they project, often completely blocking the cavities (Fig. 146). They were first investigated by Hermine von Reichenbach, who noticed that the swelling is not cut off from the parent cell by a septum. They arise frequently in association with one-sided bordered pits, the limiting membranes of which undergo active surface growth and thus push their way into the cavities of the vessels (Fig. 147). Several tyloses may arise from a single epidermal cell. They occur beneath branch scars that have been formed by a branch breaking off and also at the wounded end of cuttings being formed in such numbers, that they become flattened by mutual pressure. The cavities of vessels are thus filled and they probably serve, as Boehm first suggested, to plug up the cavities of the water-conducting tubes that have suffered mechanic injury. This explanation suffices for such special cases of injury, but tyloses are formed in uninjured vessels where they obviously do not serve to close up a wound. Haberlandt believes that tyloses of this last-mentioned type take some part in the process of conduction, by increasing the surface of contact between the vessels and the neighboring parenchyma cells. Küster in his "Pathological Plant Anatomy" gives a detailed account of the different kinds of tyloses and their method of formation, which need hardly be discussed in a text-book for student use. Molisch gives a list of plants in which tyloses have been found. Sometimes tyloses fill the air chambers of the stomata partially or almost entirely, where the epidermal cells adjacent to the guard cells grow out into large unicellular bags, as in *Tradescantia viridis*.

Gall hypertrophies are those which are produced by the effect of a poison formed by an attacking animal, or plant. The tissue products are the most diverse and a sharp distinction cannot be drawn between hypertrophic and hyperplastic gall tissues. Gall hypertrophies usually occur in the epidermal and the fundamental tissues of various plants. The galls of the fungi belonging to the family CHYTRIDIACEÆ, namely, those occasioned by species of *Synchytrium*, are very simple, for the entire life history of the fungus parasite is passed in a single cell of the

¹ GERRY, ELOISE: Tyloses: Their Occurrence and Practical Significance in Some American Woods. Journal of Agricultural Research, i: 445-470, with 8 plates, March 25, 1914.

host. The zoospores of the species of *Synchytrium* penetrate the epidermal cells and incite these cells to active growth causing their enlargement, as in the cells attacked by *Synchytrium drabæ*. Sometimes the infected cell grows inordinately and pushes the mesophyll cells lying below apart, until it projects into the underlying cells as a spheric pouch. If the neighboring epidermal cells are stimulated warts are formed.

The second group of gall hypertrophies are certain hair-like developments of epidermal cells due to the irritation of certain mites of the genus *Phytoptus*, which produce felt-galls, or *Erineum*. These erineum structures arise in clusters on the surface of leaves of such trees as maples, alders, birches, beeches, oaks, willows, limes and on herbaceous plants belonging to the genera *Geranium*, *Mentha*, *Salvia*, etc. These outgrowths so resemble fungi, that Persoon was deceived into so believing. They are usually pale, or even white at first, and they turn brown as the hair-like outgrowths die and lose their sap, but since the latter may be colored yellow, red or purple, the outgrowths are conspicuous objects on smooth leaves. The botanist Malpighi in 1675-1679 was the first to call attention to these galls. One-celled erineum are the rule, but multicellular abnormal hairs are formed by the hypertrophies of the normal trichomes as Frank reports on *Quercus ægilops*.

Gall hypertrophies, where the ground tissues of plants participate in their formation, are known. The roots of the CYCADACEÆ develop sacs out of their parenchyma cells, so that large intercellular spaces are formed in which a blue-green alga, *Anabaena cycadearum*, the causal organism, lives. Galls produced by flies and belonging to the group of zoöecidia may be taken as illustrations of gall hypertrophies. One is known as the window gall of the maple, and the other is a reddish-brown, bladder gall occurring on the leaves of *Viburnum lantanum*.

Multinuclear giant cells may be formed in plants, if the nuclei divide regularly, but for some reason the formation of cross-walls becomes impossible. The cells are stimulated to abnormal growth forming the so-called giant cells. Such hypertrophies are associated with an increase of the cytoplasmic contents of the cells. Such giant cells are those produced by certain Nematode worms of the genus *Heterodera* on such host plants as *Beta*, *Colcus*, *Daucus*, *Plantago* and *Saccharum* (Fig. 148). Prilleux produced multinuclear giant cells in seedlings which

were cultivated at an abnormally high temperature. The number of nuclei rarely exceeded three.

Multinucleate cells occur in crown gall which are perhaps comparable to the giant cells of the animal histologist. Cancer specialists have divided these into two groups, viz., foreign-body giant cells in which the

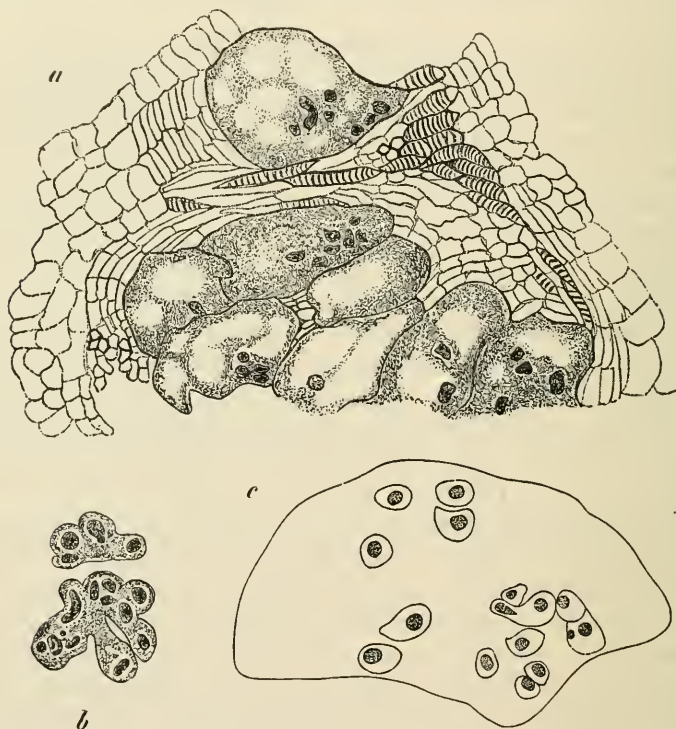

FIG. 148.—Cross-section of a part of a root gall of *Circea luteliana* in old stage, numerous giant cells are seen, the nuclei of which have begun to degenerate; *b*, irregularly branched nuclei out of the giant cells dividing by amitosis within a nucelli; *C*, a single multinucleate giant cell. (After Tischler in Küster, *Pathologische Pflanzenanatomie*, 1903: 128.)

stimulus is some introduced foreign substance, and genuine ones in which no foreign bodies are visible. There is probably no real distinction other than that those occupied by parasites are malignant and those induced by non-living granules are harmless. The cells in question in crown gall are not very large, but they contain several nuclei (Fig.

149). Four nuclei in one cell is the most we have seen, but it is probable that larger numbers occur. It would seem from the studies of Erwin F. Smith, which, however, are incomplete, that most of the cell divisions in crown gall are by mitosis. Frequently, however, there have been found nuclei variously lobed and in process of amitotic division, and this is probably the way in which several nuclei are formed in one cell (Fig. 149).

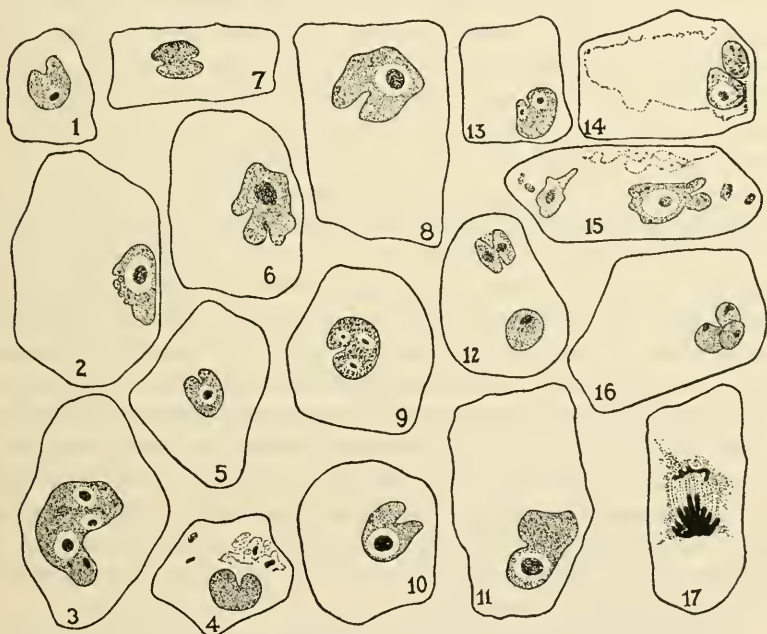

FIG. 149.—Nuclear division in crown gall; 1-16, cells showing amitotic (direct) division; 17, mitotic division in which more chromosomes have passed to one pole than to the other. (After Smith, Brown, McCulloch, *Bull.* 255, U. S. Bureau of Plant Industry, 1912.)

HYPERTROPHY AND HYPERPLASIA

Virchow in his "Cellularpathologie" (1858: 58) defined hyperplasia as all abnormal quantitative increase, produced by cell division, and that definition will be adopted here. It is very difficult in practice to distinguish without a careful study between hypertrophy and hyperplasia, but in the latter abnormalities are produced by cell division,

while in hypertrophy they are not. A number of well-defined groups of vegetative hyperplasias may be distinguished by their etiology. Chemic stimulation may be the cause of some, injury the cause of others. The normal currents of foodstuffs may be clogged, the food may be irregularly distributed and these interferences with normal processes may result in proliferations and other abnormalities. Special stimuli may also bring about abnormal supplies of food with consequent hyperplastic tissue formation. The study of the abnormality to determine its kind must be based on histologic analysis. If in our histologic examination, we discover that the abnormal tissues resemble the corresponding normal plant parts, we are dealing with *homooplasia*; if they differ from the normal, that is are composed of cells different from the corresponding normal ones, then we have a case of *heteroplasia*.

Heteroplastic excrescences are of great interest histologically. The difference between normal and abnormal states is sometimes greatly diverse. This difference may be one of size, of tissue differentiation, of constitution, and it is important in our pathologic study to determine the nature of the differences between normal and abnormal conditions. Thus, when we find a less differentiated tissue produced by abnormal cell division without regard to the increase in the numbers of cells, we can speak of the degeneration of tissue formation combined with an increase of volume. This is known as cataplasmy, and the products of the cataplastic processes as cataplasms and the kind of hyperplasia illustrated in these abnormal changes as cataplastic hyperplasia. When, on the other hand, we find new histologic characteristics and functional activities associated with hyperplasia, we speak of prosoplasmy, of prosoplasms, and of prosoplastic hyperplasia.

HOMOOPLASIA.—This term may be defined as abnormal tissue formation produced by an increase of the normal elements; it has a limited use to abnormalities, not to increase in size of normal organs by a mere increase in the number of cells. We would not use the word homooplasia for the unusually large leaves which of normal form and texture appear on the shoots which arise from tree stumps and which have been studied by the writer in a number of our American forest trees, such as the tulip tree, *Liriodendron tulipifera*. Homooplasia is opposed to the phenomena of *giant growth* here mentioned.

Localized tissue excrescences composed of the same histologic elements and of homooplastic character are not common. Occasionally

sugar beets continue their growth to abnormal thickness by the formation of ridge-like tissue excrescences composed of normal layers of tissues which extend longitudinally. De Vries investigated a case where new cambial rings were formed outside of the latest ones of the first year coincident with an arrestment of activity. Hottas incased roots of *Vicia faba* in plaster casts pierced by holes. He found that by correlative growth homoplastic excrescences filled the holes.

Some kinds of homoplasias are characterized by the fact, that only single tissue forms of an organ are developed unusually without the formation of local excrescences by which means the histology of the organ is altered. Increased demand upon a tissue may result in the formation of abnormally abundant tissue and to this the name of activity homoplasias has been given. Various experiments have been conducted in the attempt to form mechanic tissue by putting an increased mechanic demand upon plant tissues. The experiments of Küster with sunflower stems were negative, as also those of Wiedersheim with branches of beech and ash, for he found no strengthening of the hard bast in his experiments. He proved, however, an increase of stereids in the strained branches of *Corylus avellana*. Vöchting has shown that horizontal stalks of the Savoy cabbage strained at the extremity by hanging weights developed thickenings on the upper side of the branch. De Vries has described an abnormal potato tuber in which through the need of conduction of plastic substances the bundles of the tuber had developed to an extent unusual to the normal plant. The wood and bast portions were both increased. Vöchting's experiments with potato tubers supplement those of de Vries; for he succeeded in interpolating the potato tuber as an element in the potato plants grown from it and succeeded in getting hyperplastically developed vascular bundles.

Correlation homoplasias result when there is a local arrestment of growth, and growth is started elsewhere with homoplastic changes in the tissues. The experiments of Boirivant and Braun have proved this in a number of plants. Only one case of callus homoplasia has been reported and it is described by Schilberszy, who succeeded in stimulating an increase of vascular tissue in the stalks of *Phaseolus multiflorus* through injury. No positive cases are known where homoplasias occur in the formation of galls.

HETEROPLASIAS.—This term of pathologic anatomy is used when there is a quantitative increase of an organ in which by abnormal di-

vision of the cells there are produced tissues, the single elements of which have no resemblance to normal ones. Size of cells is of relatively little interest in the study of these abnormalities. More important are cataplastic and prosoplastic tissues, which are formed in heteroplasia. Cataplastic tissues are those which are more simply constructed than the corresponding normal tissues, while prosoplastic tissues are those in which we can see processes of differentiation in the formation of their single cells and in the distribution of their different elements, which are not manifest in the formation of the corresponding normal tissue.

The material illustrating the various kinds of heteroplasia may be treated of under the following heads:

HETEROPLASIAS	1. Correlation-heteroplasms	}	Cataplasms
	2. Calluses		
	3. Wound-wood		
	4. Wound-cork		
	5. Galls	}	(a) Cataplasms
	(b) Prosoplasms		

1. *Correlation-heteroplasms*

This term is applied to cases where the normal growth of any plant is arrested at its vegetative points by any causative factors whatsoever, and where under the stimulus of the unused nutritive materials some part of the plant develops abnormal growth and tissues. Vöchting has studied this subject in all of its details. He found that decapitation of sunflower plants resulted in the production of tuber-like swellings on the roots and that in the aerial runners of *Oxalis crassicaulis* filled with reserve materials that removal of the apical cells and all axillary bud cells resulted in the formation of swellings on the leaves and internodes. According to Vöchting, the parenchyma participates, also the vascular bundles, which have fewer ducts than the normal ones. The sieve tubes, however, are richly developed and extensive fundamental tissue outgrowths are found between bast and wood. The first experimentally produced correlation-heteroplasms were made by Sachs. He cut off all the vegetative points of pumpkin plants. He found, as a result, that the embryonic root cells present in the stem at the right and left of each petiole grow out into short-stalked tubers, as large as marbles, in which the root cap and vegetative point are absent and

the axillary fibrovascular cord is resolved into a circle of isolated bundles separated by chlorophyll-containing cells.

2. *Callus*

Callus may be defined in the widest sense of the word as all cell and tissue forms produced subsequent to and as a result of injury. In many plants and plant organs, only a metaplastic change of the cells was incited by the injury (callus-metaplasia); in others, the cells laid bare showed an abnormal growth and were changed into voluminous vesicles and sacs (callus-hypertrophy), or an increase of the normal tissue may result from wound stimuli (callus-homoeoplasia). The cells may be abundant after an injury owing to active cell division and heteroplastic tissue arises (callus-heteroplasia). When excrescences arise, which are composed of cells very little differentiated and of the simplest form, they are called cataplasms. If produced after injury, they are found to differ greatly. The tissues produced after an injury, if resembling cork, are termed wound-cork, if similar to those of wood, they are called wound-wood and where we have the healing tissue composed of nearly homogeneous parenchyma, it is called simply *callus*.

Callous tissue may be formed as wound tissue in very different plant groups. It has been found in the algal fungi and vascular cryptogams. The woody seed plants have been studied carefully as to the formation of callus, because of its economic importance in forestry and horticulture. Rose, poplar, or willow cuttings kept in moist air and at a proper temperature after a few days form a ring-like tissue excrescence from the cambium of the cut surface. This spreads out rapidly and finally closes over the wound. Such rolls of tissue have been called *callus* (callus, hard skin).

Callus at least in its first stages appears in the form of a ring, sometimes it is irregular in its formation, often being lacking in some places

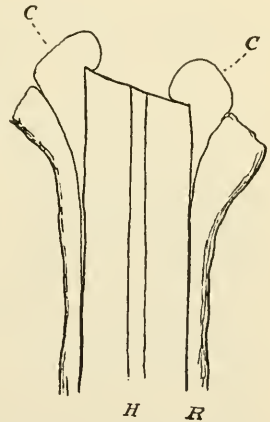

FIG. 150.—Longitudinal section of a callused end of a cutting. C, C, Callus developed from cambium; H, wood; R, bark. (After Küster, p. 159.)

and this is sometimes due to limitations of space relations. Sometimes the callus is most luxuriant, as in cuttings of *Populus pyramidalis* (Figs. 150 and 151) and *Lamium orvala* (Fig. 152), which produces the largest callous rolls among herbaceous plants. All organs of the plant

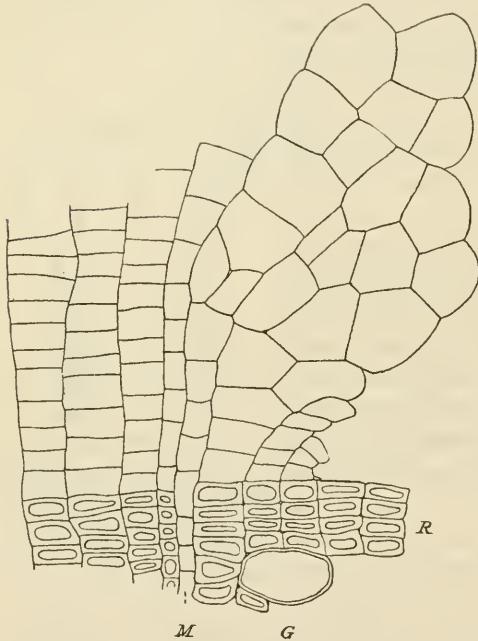

FIG. 151.—Cross-section of a calloused end of a poplar cutting. *G*, Vessel; *M*, pith ray. (After Küster, p. 159.)

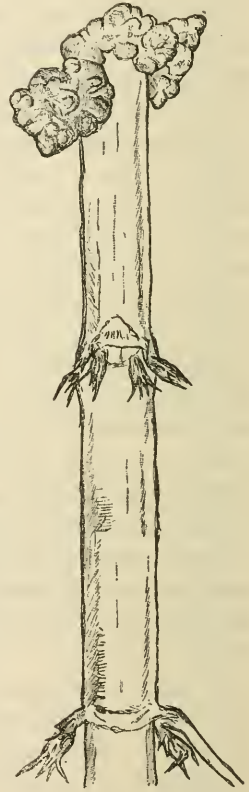

FIG. 153.—Stem of *Lamium orvala* with strong callous growth. (After Küster.)

are capable of producing callus, such as roots, stems and leaves, yet all parts of all plants do not have the capacity of forming it. Such growth seems to reside in the living elements of exposed tissue and the productive power of different kinds of tissues varies greatly. Cambium is the most active layer in the production of callus and next to

the cambium the primary and secondary bark tissues. The epidermis plays an unimportant rôle. Pith also can develop callus.

The investigations of R. Hoffman, Küster and Stoll go to show that the cambial cells when division takes place after injury are not restricted to the mode of normal division but can grow in every direction. It is certain, therefore, that the conditions of changed pressure are of importance and significance, and yet this fact alone is hardly sufficient to explain the phenomena of growth subsequent to an injury. The cell divisions are very regular and rapid in those woody plants which form callus.

Cuttings of woody plants, such as *Populus pyramidalis* (Fig. 150), if placed in water and covered with a bell glass, so that the upper end extends above the water into the moist air, shows early division of the cambial cells near the upper wounded surface. We find these cells are divided by walls perpendicular to their long axis, and in a lively manner, by forming tangential walls, causing an abnormally intensive growth in thickness of the cutting near the injured place. A strong callus has been formed by abundant division of the cambial cells and the cutting assumes a club-shaped form at its upper end. The wedge, which is formed in this way between the wood and bast, has been termed by Th. Hartig the "Lohdenwedge," which might be termed more appropriately in English the healing wedge. In the formation of this wedge, the cambial cells have divided just as under normal conditions, but the relief of pressure has caused some of the outer cells to protrude to form the enlarged part of the wedge with the outer cells bent strongly. Primary bark as in *Salix* easily forms callus, and petioles and leaves often form abundant callus.

Histologically the tissues of callus are distinguished by the slight differentiation of their cells. The cushions of callus in many kinds of cuttings are made up of the same kinds of cells and in a homogeneous fashion. The cells are typically nascent ones with thin cell wall, protoplasmic contents and a colorless cell sap. If the growth is slow, the callous cells are small and closely fitted together, but with rapid growth the cells are large and loosely placed with conspicuous intercellular spaces. Tracheids are absent from the upper cells of the cushion of callus, but in the lower part of the healing wedge some of the cells assume the tracheal character. The formation of a tegumentary layer is next to the development of tracheids the most interesting process of

differentiation in the callus. The callus of poplar cuttings is favorable for a study of its formation. The outer cells of the wedge of healing are long and pouch-like, and their outer walls give the cork reaction, since they take up Sudan III with avidity, and at the same time are colored with hydrochloric acid and phloroglucin. Sooner or later, a cork cambium is produced in the outer cell layers of most callous formations. Massart, who first studied the nuclear phenomena in callous tissue, rarely found that the cells contained more than one nucleus. He found that direct nuclear division took place after wounding in *Cucurbita*, *Ricinus* and *Tradescantia*, while Nathansohn found mitosis in the callus of the divided roots of *Vicia faba* and both mitosis and amitosis in that of poplar cuttings.

Conditions of Callous Formation

The behavior of cuttings from different plants varies within rather wide limits. Some cuttings develop callus quickly, others slowly, and the quality of the callous tissues differs as greatly. The poplar develops a large amount of callus, while cuttings of elm, willow and oak form only a low callus ring. Organs rich in foodstuffs form callus more quickly than those poor in food materials. For example, the cotyledons of *Phaseolus* and *Vicia*, rich in proteins and starch, develop callus to an extraordinary degree. Moisture is an important factor in the formation of callus, for it is formed in water, but better in moist air, and not at all in dry air. Cuttings of poplar with both cut ends in moist air develop callus at both extremities, but usually there is a polarity shown. Cut-off petioles of the poplar form a more prolific callus at the basal end of the petiole than at the end nearer the leaf blade. With stem cuttings, the callus is best developed at the basal end in preference to the apical. Pieces of dandelion roots, 3 cm. long, kept in a moist place, show most abundant callus on the upper stem ends and not at all, or only slowly at the apex, but in alfalfa a powerful tuber-like callus is produced at the root end and feebly at the sprout end. So that having varied the external conditions of their formation, it becomes evident that internal conditions are active and these probably depend upon inequalities in the nutritive condition of the cut parts and also on the direction of established sap flow.

Loosely connected with pathologic anatomy are the regenerative

processes which result in the formation of the vegetative points of roots and shoots following an injury. Following an injury in very many woody plants, there is a formation of adventitious roots and adventitious shoots which grow from vegetative points developed directly from the permanent tissue of the wounded plant organs, but this operation is necessarily preceded by formation of callus and in some cases the new vegetative points are developed directly from the callus. Upon these functional operations depend the success of the horticultural operations of the making and establishment of cuttings of roots, stems, and leaves. A very large number of plants may be raised by means of cuttings. Soft-wooded, or herbaceous cuttings having leaves are used in many cases, the shoots being in a half-ripened condition, that is neither too young nor too old, dry and woody. Such cuttings are usually inserted in sandy or gritty soil, and most of the leaves are stripped off to check transpiration of moisture. Several leaves are retained, so that a certain amount of assimilation can be carried on to induce callus formation.

WOUND-WOOD

The wood, which is formed on the surface of the exposed wood of the stem and on the inner surface of the detached bast, is distinguished from ordinary wood by its abnormal structure, and especially by the shortness of its cells and the absence, or scarcity of vessels. Hugo de Vries,¹ who was the first to direct attention to this abnormality, called such wood, wound-wood. Such abnormal wood is distinguished from the normal xylem by its simple histologic character, and is to be added to the list of cataplasms.

The difference between wound-wood and normal wood depends upon whether its formation has been brought about by cross cuts into the cambium, or by longitudinal wounds. In the latter, the wound-wood is distinguished by a wide-celled structure and by more numerous ducts than in normal wood, but the libriform fibers are less in evidence. Hugo de Vries studied *Caragana arborescens* and proved that the wound stimulus caused the formation of wound tissue 7 cm. from the wound itself. The nearer the cells of the cambium are to the wound the more cross walls are formed, so that the short-celled zone of the

¹ DE VRIES, HUGO: Ueber Wundholz. Flora, 1876: 2.

wound-wood is produced near the place of injury, the transitional forms at a greater distance and then the long-celled zone, which is formed from undivided cells of the cambium. The daughter cells of the cambium of the short-celled zone form near the edges of the injured part, a wound-wood composed of polyhedric fundamental tissue cells resembling the medullary ray cells of normal wood, only a few of such elements develop into parenchymatous tracheids. The cells of the long-celled zone retain the character of wood parenchyma, but between them narrow vascular cells united into strand-like groups are formed, while wood fibers and broad ducts are absent. Such formed elements have been termed primary wound-wood by de Vries, and later, there occurs the production of a secondary wound-wood in which the cells gradually assume a normal form. Abnormal resin ducts are formed in wound-wood and these ducts are often more numerous in abnormal wood than in the normal.

Sometimes the wound-wood does not form definite stratified tissues. Occasionally tracheid-like cells are found in the callus which become united into ball-like groups separated from the normal wood. Wood fibers, which have an irregular course, have formed the gnarled wood.

The pith may take part in the formation of wound-wood, for it is highly capable of producing callus, and also from the ground tissue of injured leaves. No definite outer form is characteristic of wound-wood. Frost action may kill the cambium in places, and if the dead places are surrounded by cushions of wound-wood, then we speak of frost canker. Frost cracks are filled with wound-wood, which close up the wound followed by the formation of a frost ridge. Such canker tissue may be destroyed during a frosty spell and a new attempt to form callus results in the addition of new wound-wood to the old and frost cankers are formed.

Sometimes without an injury, tissues resembling wound-wood are formed by the activity of the normal cambium, or from a newly formed independent cambium. Under some conditions, the parenchyma of the medullary rays increases at the expense of the formed elements of the wood, so that broadened medullary rays are formed. Fasciated branches frequently show such broadened medullary rays. Tuber-like gnarls are formed in fruit trees that have stone fruits, and also in beech bark and the structure of gnarls has been investigated by Sorauer, and the bark tubers of beech by Krick.

WOUND-CORK

Injury to different plant organs such as roots, tubers, rhizomes, stems, leaves and inflorescences is followed by the formation of cells in rows and adjacent to the place of injury. The walls of these new cells react to sulphuric acid, chlor-iodide of zinc and Sudan III and the application of such reagents demonstrates the formation of cork, which has been termed wound-cork. It is developed generally on all parts of the wound, and at its edges connects directly with the normal membranes, thus closing the wound. The walls of wound-cork cells are always thin and are often folded, and the cork cells thus formed are larger than those of the phelloderm. A stem wounded by a knife cut soon heals up unless disturbed. The cut cells die, while those next below grow out as a result of the decreased pressure, giving rise to cork cells. As the opposing cushions of callus close together, this cork is squeezed between them and finally a shearing of the cork cells results as the tips of callus close together and unite. The only external sign of the wound is a slight ridge-like elevation beneath which are traces of the dead cells and the cork trapped here and there beneath the ridge. Normally, wound-cork closes over the broken surface of the scars formed in the autumn by the fall of the leaf, which is actually occasioned by the formation of a cork layer, which cuts off the leaf from the stem.

CHAPTER XXI

GALLS

Galls may be defined as all abnormal tissues produced by the action of animal, or vegetal parasites. The great majority of galls arise either through the growth of cells alone (gall hypertrophy), or by cell division (gall hyperplasia). The number of galls constructed heteroplastically is very large, exceeding the diverse gall hypertrophies. Galls of heteroplastic origin occur in the most diverse kinds of plants and on all organs of these plants. The term gall, or cecidium (cecidia), is applied to those variations in form which are caused by foreign organisms. In the formation of the cecidium, an active participation of the host plant is necessary and the biologic connection between the host plant and the gall-producing organism must be considered. Only those cases fall within our purview in which abnormal tissues are produced.

Considered biologically and etiologically galls form a well-defined group without, however, any one feature common to all. Even when considering only gall hyperplasias, we will find no common characteristics except that a production of heteroplastic tissue is involved in all. This is either extraordinarily simple histologically, showing little or no differentiation, or there are specific differentiations which produce structures entirely distinct from those of normal tissues. The first kind are cataplasmic galls, and the second kind prosoplasmic. Galls may be classified as to their morphologic characteristics, as well as by their histologic. They may be found on every part of plants, roots, stem, branches, leaves, flowers and fruits and plants capable of producing galls belonging to all groups of the plant kingdom.

The following descriptive terms for galls will serve as a rough classification of their morphologic forms. Connold¹ gives an example of each kind.

As to morphologic character, galls are: axillary, coalescent, conglomerate, cymbiform, elongated, globose, glossy, gregarious, hirsute

¹ CONNOLD, EDWARD T.: *British Vegetable Galls*, 1901: 24-25.

imbricate, pedunculate, pilose, pubescent, pustulate, rugose, rosaceous, scabious, separate, sessile, solitary, spiny, rolling and thickening of the leaf, upon the upper surface of the leaf, upon the under surface of the leaf, upon the margins of the leaf. Some cecidologists would classify galls by the causal animal or fungus, by the natural families of the host plants, according to the situation of the galls upon the plant, according to their modes of growth, etc. Anton Kerner in his "Natural History of Plants" (translated from the German by F. W. Oliver) divides galls into simple, where one plant organ is involved, and compound, where several plant organs are concerned in their formation. The simple galls he divides into (a) felt galls, (b) mantle galls and (c) solid, or tubicular galls.

Cataplasmic galls are often produced by the action of parasitic fungi, which invade the interior of the plant after an infection by animals, which by their wanderings over the surface of the plant may enlarge the field of their stimulation. Domiciled organisms are the cause of prosoplasms, where the extent of the field of stimulation remains the same under all circumstances, and is effective only in certain phases of the development of the host plants.

The etiology of galls is of great interest. Malpighi in his "Anatome Plantarum" published in 1675-79 attributes the formation of insect galls to the action of a poison excreted by the gall insect. Darwin and Hofmeister explained galls, as the action of different kinds of poisons. The stimuli, which cause the formation of galls, is undoubtedly chemic, some unknown substances excreted by the causal parasite, excite the cells of the host plant to growth and cell division and to different kinds of differentiation. We know nothing definite about the chemic substance, nor have the attempts to produce artificial galls been successful. Traumatic stimuli, too, must come into play, for injury to the plant goes hand in hand with infection, for the first stage of the development of galls resembles callous tissue. The galls produced may be due to plants, *phytocecidia*, or to animals, *zooccecidia*. The fungi and a few flowering plants are largely responsible, while dipterous and hymenopterous insects and mites are gall-producing animals.

(a) CATAPLASMS.—Cataplasmic galls are those which are distinguished from the normal tissue of the corresponding organs by the small amount of their tissue differentiation. The cell elements may often be abnormally large, and the union of these elements usually forms a thin-



FIG 153.—Tubercles of velvet bean produced by inoculation. (After Moore, *Geo. T., Yearbook, Dept. Agric., 1902, pl. xxxvii.*)

walled often homogeneous parenchyma, while in other cases the cataplasms are marked by the absence of any definite form, or size. Almost all phytocecidia, or plant-induced galls, are cataplasmic. The swellings on the roots of various members of the CRUCIFERÆ caused by the slime mould *Plasmodiophora brassicæ* are of this nature. It is known as Hanbury, clubroot, finger-and-toes by the practical grower of plants. Root nodules, or tubercles, are produced on the roots of leguminous plants by bacteria (Figs. 153, 154, 155, 156), which can utilize

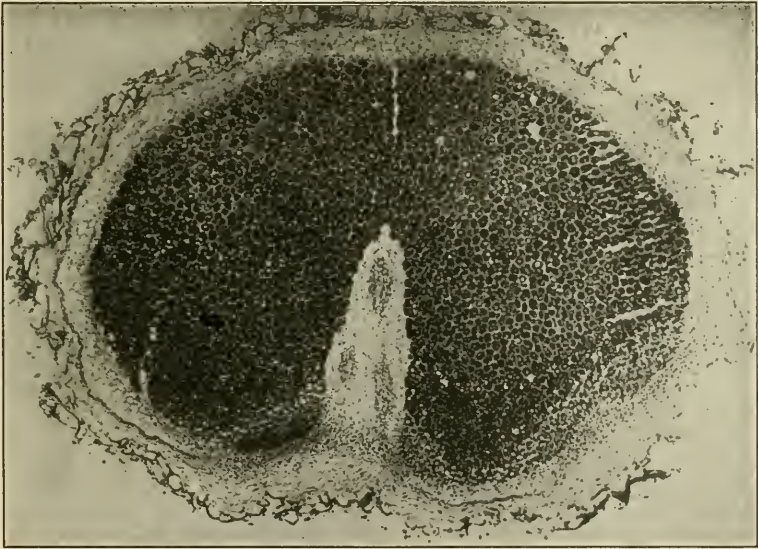

FIG. 154.—Cross-section of root tubercle of *Lupinus angustifolius* containing bacteria, $\times 46$. (After Moore, Geo. T., *Yearbook Dept. Agric.* pl. xxxviii, 1902.)

free atmospheric nitrogen and by their activity the leguminous plants secure large amounts of nitrogen. A species of *Actinomyces*, or ray fungus, is probably the cause of the mycodomatia of *Myrica*. Bacteria also cause tumors on the *Pinus halepensis* and *Olea europæa*, on the latter in the nature of a crown gall suggested to be somewhat like animal cancer (Figs. 157, 158, 159). Recently Erwin F. Smith in relation to the abnormal multiplication of the tissues which result in a crown-gall tumor, or hyperplasia, concludes that the removal of growth inhibitions is brought about by the physical action of substances liberated

within the tumor cells as the result of the metabolism of the imprisoned bacteria (*Pseudomonas tumefaciens*). Growth of the tumor comes about not by the direct application of stimuli, but indirectly by the removal of various inhibitions. Under normal conditions the physiologic brakes are on at all times, more or less, in both plants and animals, and only when they are entirely or largely removed in

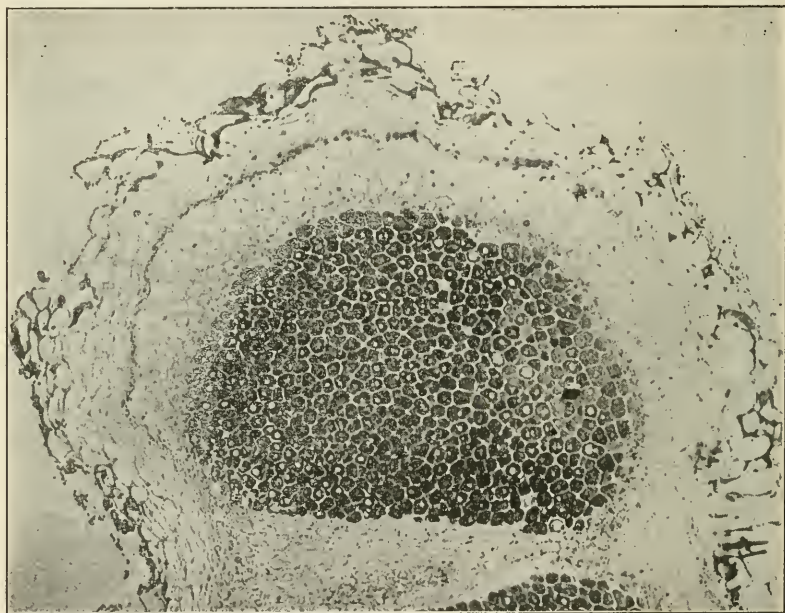

FIG. 155.—Cross-section of one lobe of tubercle of *Lupinus angustifolius*, containing bacteria, \times circa 60. (After Moore, *Geo. T.*, Yearbook U. S. Dept. Agric., pl. xxxviii, 1902.)

particular areas do we observe an unlimited cell proliferation resulting in the hasty and peculiar growths known as neoplasms, or cancers (Figs. 158, 159). Various weak (dilute) poisons are known to cause cell proliferations in plants—that is, copper salts, ammonia, salts of lithium, and the excretions of the larvæ of gall flies, of certain nematodes and of various fungi.¹

The true fungi (*EUMYCETES*), including all the important groups,

¹SMITH, ERWIN F.: Mechanism of Tumor Growth in Crown gall. Journ. Agric. Res. viii: 165–186, Jan. 29, 1917, with 65 plates.

form cataplastic plant galls. Galls are due to species of *Synchytrium*, to the aecidial stage of the rusts on violets, barberries, nettles and buck-

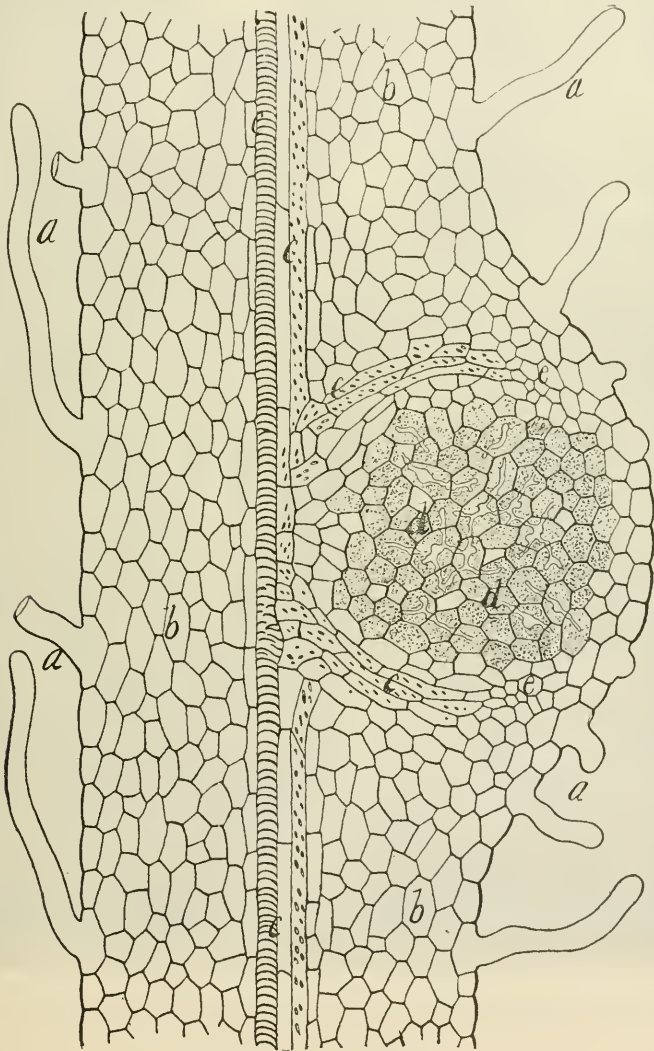

FIG. 156.—Longitudinal section through red clover rootlet, showing formation of tubercle. *a*, Root hairs; *b*, normal root parenchyma; *c*, vascular tissue; *d*, infected areas showing infection strands; *e*, growing cells of tubercle. (Fig. 44, page 95, *Schneider, Pharmaceutical Bacteriology, 1912.*)

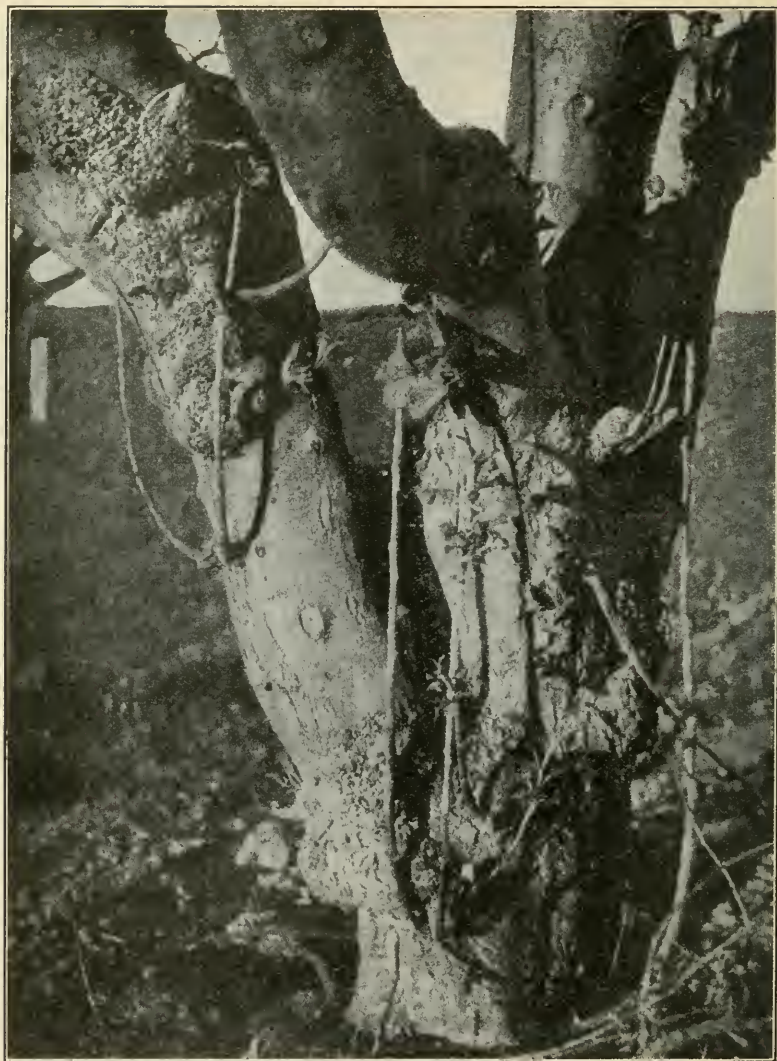

FIG. 157.—Stem tumors on an old apple tree at Mesilla Park, N. Mex. (After Hedgcock, G. G., *Circ.* 3, U. S. Bureau of Plant Industry, May 11, 1908.)

thorns. Branches of *Vaccinium vitis-idaea* are enlarged by *Calyptospora Goepfertiana* and those of *Juniperus* and *Chamaecyparis* by rusts of the genus *Gymnosporangium*. Various species of the genus *Exobasidium* produce soft, edible galls. All such galls are mycocecidia (Fig. 84).

Various algæ, such as *Cystoseira opuntioides*, *C. ericoides*, and *Ectocarpus Valianteri*, live parasitically and cause tissue excrescences, while the higher plants, especially of the family LORANTHIACEÆ, produce large galls and the so-called wood roses on their host plants. These wood roses are formed by the woody tissues of the host forming a ridge-like growth about the clasping part of the parasite.

The animal-produced galls known as *zoocecidia* are some of them of cataplastic nature and are caused by nematode worms, insects and mites. The most important nematode worm responsible for the formation of galls is *Heterodera radiculicola*, which attacks many cultivated plants both in the greenhouse and in the open. The mite galls include the fleshy (hyperplastic) curlings of the leaf edges, shoot tips of various woody plants. Erineum galls, consisting of multicellular cones and ridges, are to be placed here. Dipterous insects produce galls with a prosoplasmatic structure, while the cataplasms produced by them have the form of fleshy curlings of the edges of the leaves of the host plants. Galls are produced also by the attack of bugs, aphids, or plant lice, leaf wasps and gall wasps. They are



FIG. 158.—Crown gall on raspberry. (After Conn. Agricultural Bacteriology, p. 306.)

found on roots, stems, leaves, inflorescences and fruits. Such are those on the roots of the grape due to *Phylloxera vastatrix*, etc.

HISTOLOGY OF CATAPLASMS.—Usually aside from the slight tissue differentiation cataplasms are composed of abnormally large cells with an abundant protoplasmic content and sometimes with red cell sap, also a large starch content. The primary and secondary tissues are both involved in the formation of the galls.

Primary Tissues.—Leaves, which are infected by fungi on which are formed mycocecidia, show an arrestment of the tissue differentiation.

For example, the distinction between the palisade and spongy parenchyma is often lost, because the palisade layer is not formed as such and sometimes the spongy parenchyma undergoes a rich proliferation

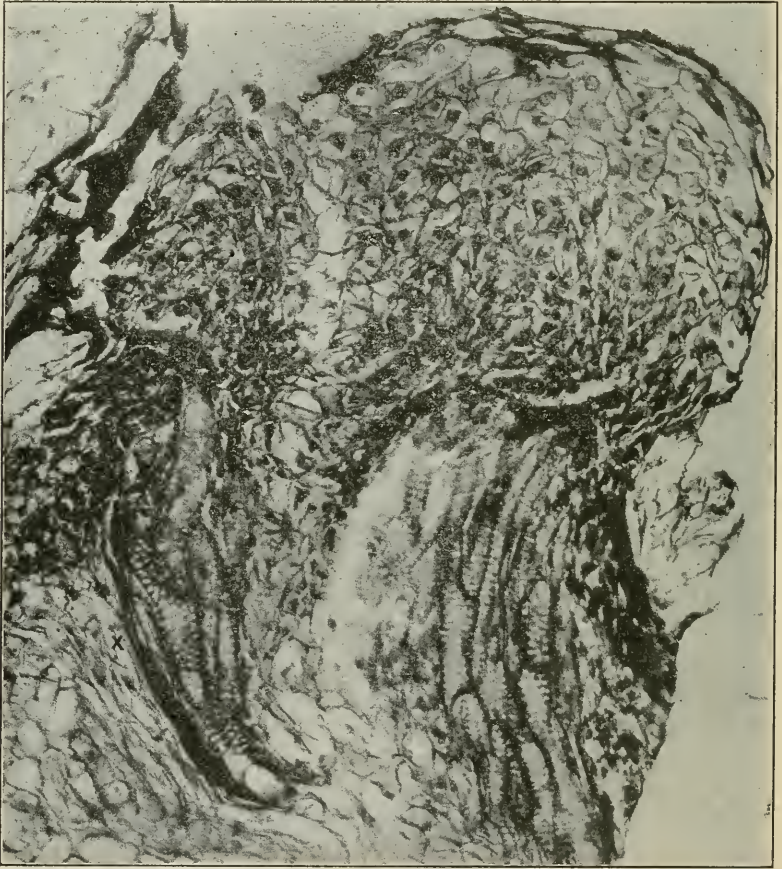

FIG. 159.—Section of tobacco. Margin of infected needle wound. Tumor in middle part of back parenchyma; sieve tubes at x. (After Smith, Brown, McCulloch, *Bull.* 255, U. S. Bureau of Plant Industry, 1912, pl. cl.)

and red pigment sometimes appears. The same failure to form the regular tissues is displayed by the zoocidia. The vascular and mechanic tissues may also undergo the same reductions in cataplasms, as do the assimilatory tissues, so that the vascular bundles in infected parts are

often only moderately developed. Wakker describes the disappearance of the collenchyma in the stalks of *Vaccinium vitis-idaea* infected with *Exobasidium*. Hyperplastic excrescences may be found by the pith as in branches of *Clematis* attacked by *Aecidium Englerianum*.

Secondary Tissues.—Under this head will be considered the products of the cambium. The formation of galls may be due to the division of the living derivatives of the already-formed annual ring, or as in wound-wood, its own cells are used in the production of the cataplasmatic tissue. The wood and bark swellings formed by the attack of animals and fungi may be clustered or knob-like and resemble the frost-induced cankers or even the witches' brooms.

Abnormal wood found in many woody galls is induced by many fungi belonging to the genera *Dasyscypha*, *Gymnosporangium* and *Peridermium*, by insects, and by parasitic flowering plants. A characteristic feature of such galls is the abnormal increase in the parenchyma, produced by the division of the cambial derivatives, which give rise to group of parenchymatous cells. Sometimes the cambial rays are broadened, so that extensive continuous masses of parenchymatous wood are produced. The same kind of tissue formation is seen in an examination of mycoecidia and zoocecidia. The mycoecidia may be illustrated by a brief consideration of the spindle-like, or ball-like, woody galls induced on different species of *Juniperus* by forms of the genus of rust fungi, *Gymnosporangium*. In the diseased wood, the difference between the spring and autumn wood is scarcely recognizable, and the parenchyma occupies a relatively broad space. The cambial rays in the parts of the branches infected by *Gymnosporangium clavariæforme*, instead of being only two to ten cells deep, are often ten to sixty cells deep and at least three cells broad. The woody gall of *Gymnosporangium juniperi-virginianæ* shows still broader cambial rays, when viewed in tangential longitudinal section. According to the investigations of Reed and Crabill,¹ the cedar apple gall is a modification of the leaf of the red cedar (Fig. 160). The cedar leaf parenchyma makes up the greater portion of the cedar apple with the fungous hyphæ in the intercellular spaces of the parenchyma cells.

The fibrovascular system of the gall is a modified continuation of the

¹ REED, HOWARD S. and CRABILL, C. H.: The Cedar Rust Disease of Apples Caused by *Gymnosporangium Juniperi-Virginianæ*. Technical Bull. 9, Va. Agric. Exper. Sta., May, 1915.

fibrovascular system of the cedar leaf (Fig. 161). From, or near the base of the cedar apple, where the vascular elements are much contorted, arise many branches, which extend radially almost to the cortex. Harshberger¹ has investigated the galls produced by two species of *Gymnosporangium* on the coastal white cedar, *Chamaecyparis thyoides*,

and Stewart² has published an account of the anatomy of *Gymnosporangium* galls and *Peridermium* galls.

There may be an over-production of the wood parenchyma and the parenchymatous elements may divide without abnormal widening of the annual ring. The production of abnormal resin canals which are always surrounded with parenchyma illustrate this point. Hartig produced an increase of resin ducts in the diseased areas of coniferous trees infected by *Armillaria mellea*.

Abnormal Bark.—Many gall formations exist where extensive bark excrescences are produced whereby there is an abnormal formation of parenchyma. An examination of the galls due to species of *Gymnosporangium* shows that the bark and wood form excres-

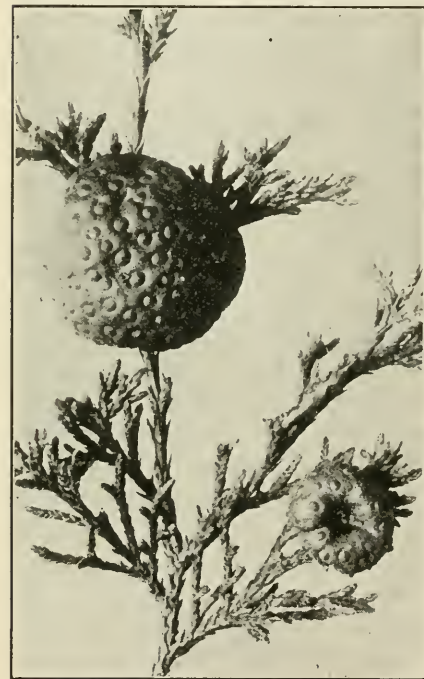

FIG. 160.—Unopened cedar apples on red cedar, *Juniperus virginiana*. (After Jones and Bartholomew, Bull. 257, Agric. Exper. Stat. Univ. Wisc., July, 1915.)

cences simultaneously. Wörnle found that in weak branches of *Juniperus communis* a rust fungus, *Gymnosporangium clavariæforme*, incited the bark to form woody parenchyma.

¹ HARSHBERGER, JOHN W.: Two Fungous Diseases of the White Cedar. Proc. Acad. Nat. Sci., Phila., 1902: 461-504, with 2 plates.

² STEWART, ALBAN: An Anatomical Study of *Gymnosporangium* Galls. Amer. Journ. Bot., ii: 402-417, October, 1915; Notes on the Anatomy of *Peridermium* Galls. do, iii: 12-22, January, 1916.

Witches' Brooms and *Stag-head*.—The branches of the silver fir, the flowers, fruits and portions of stem of various species of plants are transformed into witches' brooms, or stag-head by the action of fungi of the genus *Exoascus* and in the silver fir by *Aecidium clatinum*. The shoots

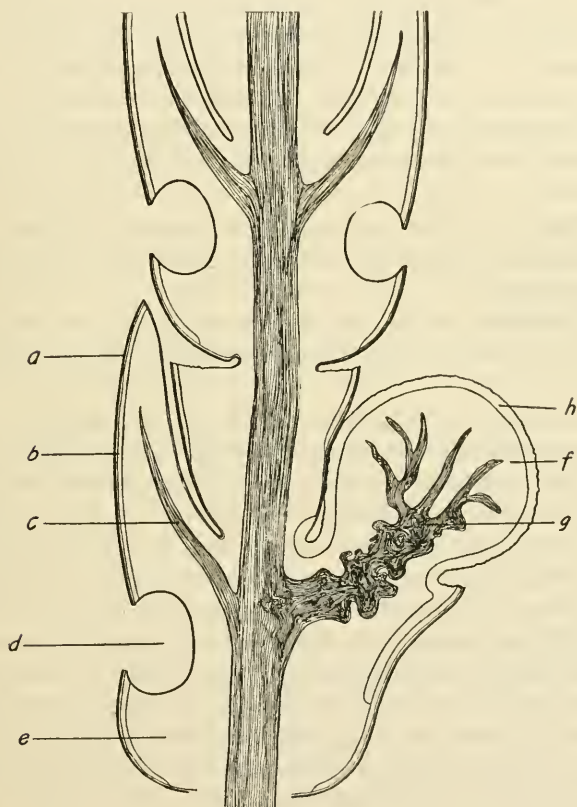

FIG. 161.—Diagram of a longitudinal section of a cedar twig bearing a small cedar apple in June. *a*, Epidermis of cedar leaf; *b*, sclerenchymatous layer; *c*, fibro-vascular bundle; *d*, resin gland; *e*, parenchyma; *f*, parenchyma of cedar apple; *g*, fibro-vascular system of cedar apple; *h*, cortex. (After Reed, H. S., and Crabill, C. H., *Techn. Bull.* 9, *Va. Agric. Exper. Stat.*, May, 1915.)

are annual instead of perennial and are always sterile and branch out into broom-like, or antler-like forms called thunder bushes by some.

(*b*) PROSOPLASMS.—Those galls are included, as prosoplasms, which do not have arrested tissue differentiations, nor in which callus tissues

are found, but in which new kinds of tissues are formed differing from the normal and in which definite proportions of form and size normal for the species are repeated in them. Therefore, prosoplasms display in their external form, something independent and well defined from the organs of the normal plant both internally and externally. Hyperplastic tissues of this sort have been found until now only in the excrescences caused by parasites and almost entirely those of the animal world, which produce zoocecidia. Six different orders of insects are the principal producers of galls and various fungi. They are as follows: The Acarina, or Mites of diminutive size, produce galls of simple form and structure.

The Diptera, or Flies, cause many prosoplasms. The galls produced by the gall gnats, or gall midges, are very different in character and often very complicated.

The Hemiptera, which include the aphides commonly known as green fly and plant lice, also produce numerous usually simple prosoplasms.

The Hymenoptera, or gall-wasps, produce striking galls on account of their size, diversity and complexity of form external and internal.

The Coleoptera and Lepidoptera (Heterocera) are responsible for relatively few galls, and if formed their structure is relatively simple.

There are several plant-produced galls, or mycoecidia, in which there is a regular arrangement of certain elements such as the cells in which anthocyanin is formed. *Ustilago Treubii* causes the production of canker-like excrescences on the stems of *Polygonum chinense*, which consist of spongy, parenchymatous, wood tissue. The excrescences, which develop from the canker swelling, are fleshy, succulent, easily breakable, irregularly bent, cylindric and often longitudinally furrowed broadened at the top like the head of a snail. The fruit galls, which represent the part which produces the spores of the fungus, are represented by this part of the gall.

HISTOLOGY OF GALLS

Three types of abnormal cell divisions, connected with the formation of galls, may be distinguished, according to the direction that the division takes. In the first type, the regular orientation of the transverse partitions cannot be recognized in young galls. In the second type, the cells divide usually in a plane perpendicular to the upper sur-

face of the affected organ. The third type is where no definite direction of cell division may be found.

The tissue material used in the formation of galls may be considered from several viewpoints. Thomas asserts that only those tissues are able to form galls which are attacked during development, or in other words permanent tissue cannot form galls and this is certainly true of prosoplasmatically formed galls, but with cataplasms there seem to be exceptions, where callus has been formed from bark parenchyma several years old. Definite experimental proof of the contested points cannot be obtained, because all attempts with experimentally producing cecidia have failed. It is certain, however, that many galls are produced from completely undifferentiated tissue, that is, from the primary meristem of the tips of shoots, or from callus tissue, but not from cells and tissues with lignified walls. It has been proved that all living cells belonging to the epidermis, the ground tissue, or the vascular bundle tissue, can under certain circumstances participate in the formation of galls. The fundamental tissue, or parenchyma, produces the largest mass of the galls, and it should be remarked in passing that the pith, bark and mesophyll cells often proliferate with astonishing luxuriance. If in leaf galls, for example, the infected part of the leaf becomes ten or twelve times the thickness of the normal leaf, it is in nearly all cases the mesophyll which has been active, for in nearly all galls the tendency to form parenchyma is striking. The epidermis is concerned only occasionally in the formation of galls and the chlorophyll content of galls is scanty.

The comparison of galls with animal tumors has been made but inadvisedly because with the exception of a diseased new formation of tissue being involved and in the absorption of appreciable amounts of foodstuffs from the fundamental tissue galls and tumors have little in common. Galls in contrast to tumors are developed by a typic infection growth. Mixed swellings occur in galls where epidermis, bark, mesophyll and other tissues unite to form an homogeneous whole while no tumor is known, which consists of characteristic tissue zones of such diversity as those of the galls of the dipterous insects.

CECIDIAL TISSUE FORMS

We are next concerned with a study of the different kinds of tissue forms in galls and in their consideration we will treat first the two most important, namely, the protective and nutritive tissues.

Protective Tissues.—The protective tissues of galls consist of the epidermal, or covering tissues, and the stone cells which form part of the mechanic tissue. The epidermal tissue will be considered as a protective tissue irrespective of its origin whether from the epidermis of the host, or as a new formation. The outer epidermis of sac and walled galls consists of relatively large, often flat cells which have a cuticle of moderate development. Occasionally this epidermis may consist of more than one layer. A gall found on a Californian oak *Quercus Wislizeni*, has the outer walls of its epidermal cells and the upper part of the side walls thickened so that the cell cavity becomes conic in shape (Fig. 162). Cork, as a covering for galls, is extremely rare. *Wound-cork* is found occasionally in these galls, while bark is even rarer in a few apterous galls.

Hair structures, or trichomes, are not unusual in galls. The majority of prosoplasmatic galls are naked or only slightly pubescent and some galls are entirely without any covering tissue.

‡ *Mechanic Tissue.*—These consist of stereids (sclerotic, or stone cells) or sclerenchyma fibers almost entirely and they surround the larval chambers so that their occupants are protected from outside pressure, or sudden blows. Lacaze-Duthiers called the stone cell tissues in galls "couche protectrice." The arrangement of the stone cells, their structure and their position in the gall tissues are of the greatest diversity. In the majority of cases, the stereids are round, in other galls they are angular, while in others, they are stretched like palisade cells and stand perpendicular to the upper surface of the gall body similar to those in many fruit and seed shells. Sometimes the sclereid cell is thickened only on one side, the delicately walled part being outside as in the galls of *Andricus quadrilineatus* and sometimes they are inside as in an elliptic gall of the oak, etc. The walls of the sclereids may be pitted, and, therefore, porous, while in other cases the pitting may be very scanty and other peculiarities have been described by pathologists who are intimately acquainted with the structure of galls.

• *Nutritive Tissues.*—The tissues of galls which are eaten by the animal occupants of the different galls, or the contents of which are beneficial to the larvæ have been termed by cecidologists nutritive tissues. The position of these nutritive tissues in the galls and their contents must be considered next. No gall is entirely without nutritive tissues and these not infrequently form the largest part of the gall and in those

formed by dipterous insects the nutritive layers are often sharply separated from the mechanical tissue adjoining. The epidermis of the gall may represent the nutritive tissue when it develops as an inner hairy lining to the larval chamber. Albuminous substances are found in such papilla, or hairs, as well as drops of fat and small grains of starch, so that the larvæ are surrounded by abundant supplies of a rich pabulum. Nutritive parenchyma may be formed within the mechanic mantel and here it is available to the larval occupant of the cell (Fig. 162). In

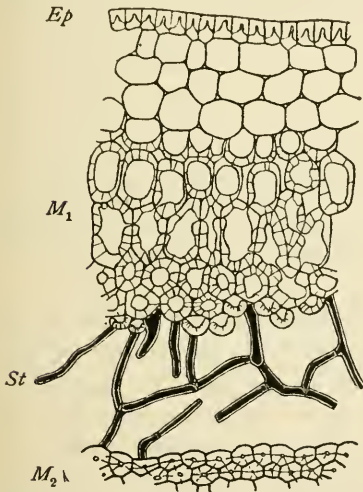

FIG. 162.—Cross-section of an unknown gall on *Quercus Wislizeni*. *Ep*, epidermis; *M*₁, outer mechanic mantle; *St*, starch-filled outer nutritive layer; *M*₂, inner mechanic mantle. (After Küster, p. 252.)



FIG. 163.—Insect gall on scrub oak, *Quercus nana*, due to gall insect, *Amphibolips ilicifolia* with interior of gall. Pine Barrens near Chatsworth, N. J., May 27, 1916.

other cases, the food materials are stored outside the mechanic mantel, and they become available only by the larvæ breaking through the stereid layer. The cells of the nutritive parenchyma are usually isodiametric, elongated and sac-like forms, or as delicate cell threads. In the highly organized galls of the Cynipidæ, the cells of the innermost layers on which the larvæ feed contain a cloudy dense cytoplasm in which small fat globules are seen and this layer may be termed appropriately the *protein layer*. A starch layer lies outside of the protein layer. Here the cells contain starch. Besides the nutritive bodies

just mentioned occur tannic substances and lignin bodies. The latter are produced at corners where several cells come together as local thickenings of the walls. It is improbable that this lignin is nutritive in function.

Tissues of Assimilation.—Almost all galls are characterized by the almost entire absence of chlorophyll. In a few galls, if present, the chloroplasts are small, twisted and feebly colored besides being extremely scanty.

Vascular Tissues.—The tissue of galls is intimately associated with the vascular bundles of the host plants on which the galls occur and some are actually formed from the tissue of the vascular bundles. Inside the galls the vascular strands are usually delicate cords both in cataplasms and prosoplasms. Where they occur inside galls, we find that their individual elements resemble those of the normal bundles. In a few exceptional cases, as in the galls of *Andricus albopunctatus*, these are concentric bundles. The arrangement of the gall bundles varies greatly for we find them in a circle, or they pass through the bark of the gall as a delicate network.

Tissues of Aeration.—The structure of many galls is an open porous one (Fig. 163). The gall parenchyma cells in some cases are star-shaped, fitting together by their projections, so that large intercellular spaces are formed. Stomata and lenticels constituting pneumathodes are found in galls. The stomata, however, have lost their ability to close and remain, therefore, permanently open. Lenticels are present in some cases. The stomata and parts of the epidermis disintegrate and large roundish lenticels develop beneath them. Perhaps this aerating tissue enables the larva to get sufficient oxygen for its metabolism. Anthocyanin is present in the cells of many galls, as their red cheeks abundantly testify.

Secretions and Secretory Reservoirs.—The elements concerned with secretion in the normal epidermis are present in galls in unchanged form, or they are increased, richly furnishing the secretions which are associated with gall formations. Less frequently new forms of secreting cells and tissues are found in galls. Crystals of calcium oxalate are not found usually in galls, but yet their entire absence is a rare feature. In some cases, the crystals when present are associated with the steroids.

The presence of tannic bodies has been noted previously, and it seems that the tannin is found in the cells of certain gall tissues. The

outer cell layers in some of the galls produced by *CYNIPIDÆ* is rich in tannin, so that these galls have been used from time immemorial in the tanning of leather and in the production of ink. Tannin balls occur in the nutritive parenchyma of many galls and are devoured by the larvæ of the same.

BIBLIOGRAPHY OF GALLS

- ADLER, HERMANN, Transl. by STRATON, CHARLES R.: Alternating Generations. A Biological Study of Oak Galls and Gall Flies. Oxford, at the Clarendon Press, 1894, pages 198.
- ASHMEAD, W. H.: Galls of Florida. Proc. Ent. Soc. Am., new ser., 1881: ix-xx, xxiv-xxviii, 1885 and x-xix. Trans. Am. Ent. Soc., xiv: 125-128.
- BEUTENMÜLLER, WILLIAM: Catalogue of Gall-producing Insects Found Within Fifty Miles of New York City, with Descriptions of Their Galls, and of Some New Species. Bull. American Museum Natural History, iv: 245-278, with 8 plates.
- BEUTENMÜLLER, WILLIAM: The Insect Galls of the Vicinity of New York City, Guide Leaflet No. 16, American Museum of Natural History. Reprinted from American Museum Journal, iv, No. 4.
- CONNOLD, EDWARD T.: British Vegetable Galls: an Introduction to Their Study, 1902, pages 312, with 130 plates.
- COOK, MEL T.: Some Problems in Cecidology. Botanical Gazette, 52: 386-390, November, 1911; A Common Error concerning Cecidia. Science, new ser., 34: 683-684, Nov. 17, 1911.
- COSENS, A.: A Contribution to the Morphology and Biology of Insect Galls. Trans. Canadian Institute, ix: 297-387, 1912, with 13 plates.
- DARBOUX, G. and HOVARD, C.: Hilfsbuch für das Sammeln der Zoocécidien, mit Berücksichtigung der Nährpflanzen Europas und des Mittelmeergebietes.
- FELT, EFHRAIM PORTER: A Study of Gall Midges II. 29th Report of the New York State Entomologist, 1913: 79-213, with 16 plates, Albany, 1915.
- HOWARD, C.: Les Zoocécidies des Plantes d'Europe et du Bassin de la Méditerranée. Description des Galles. Illustration. Bibliographie détaillée. Répartition géographique. Index bibliographique, 2 tomes, Paris, 1908.
- KERNER, ANTON: Natural History of Plants, transl. by F. W. OLIVER, ii: 518-554, 1895.
- KÜSTER, DR. ERNST: Die Gallen der Pflanzen. ein Lehrbuch für Botaniker und Entomologen, mit 158 Abbildungen.
- KÜSTER, E.: Pathologische Pflanzenanatomie, Gustav Fischer in Jena, 1903; Zweite Auflage, 1916.
- KÜSTER, E.: Pathological Plant Anatomy, authorized translation by FRANCES DORRANCE, 1913-1915.
- LACAZE-DUTHIERS, H.: Recherches pour servir a l'histoire des Galles. Ann. Sc. Nat. Bot., xii: 353, 1849; xiv: 17, 1850; xix: 273, 332, 1853.

- MAGNUS, PROF. DR. WERNER: Die Entstehung der Pflanzengallen verursacht durch Hymenopteren, Jena, 1914.
- MAYR, DR. GUSTAV L.: Die Mittel-Europaischen Eichen Gallen in Wort und Bild, Berlin, 1907.
- OSTEN-SACKEN, C. R. VON: On the Cynipidæ of the United States and Their Galls. Proc. Ent. Soc. Phil., I: 47, 62 (1861); IV: 380 (1865).
- ROSS, DR. H.: Die Pflanzengallen (Cecidien) Mittel-und Nordeuropas ihre Erreger und Biologie und Bestimmungstabellen, 1911.
- RÜBSAAMEN, EW. H.: Die Zoocecidien durch Tiere erzeugte Pflanzengallen Deutschlands und ihre Bewohner, Leipzig, 1911.
- THOMPSON, MILLETT TAYLOR: An Illustrated Catalogue of American Insect Galls, published and distributed by Rhode Island Hospital Trust Co., executor in accordance with the provisions of the will of S. Millett Thompson, edited by E. Felt, 1915, pages 66, with 21 plates.

CHAPTER XXXII

MECHANIC DEVELOPMENT OF PATHOLOGIC TISSUES

Our study of plant pathology would not be complete without a brief reference to the reactions which influence the genesis of the abnormal tissues of diseased plants. The investigation of these questions is a matter of recent development ever since prominence has been given to the experimental methods of studying plant diseases and abnormalities. Küster gives considerable prominence to these problems in the second edition of his "Pathologische Pflanzenanatomie" (pages 328-398), where we have the last and most authoritative treatment of the subject. As an important factor he mentions the reaction ability of the living cells, both in normal cell division and with inequalities in cell division, for it is recognized that unequal division of the dividing cells plays an important part in pathologic plant anatomy. The polarity of cells is another important element to be considered by the pathologic anatomist, for if by unequal division, there is produced a change in the polarity of the cells concerned in such division, the tissues which arise from such cells will show a different kind of differentiation.

Miehe has demonstrated the physiologic polarity of cells by plasmolyzing the cells of a marine species of *Cladophora*. He found, after the destruction of the continuity of the protoplasm from cell to cell by plasmolysis, and the transference of the plant into a solution of determined concentration, that elongated filaments developed, and that rhizoids developed from the basal pole of each of the cells. The epidermal cells of the leaves of linden, *Tilia platyphylla*, when attacked by *Eriophyes tiliaë* develop long cylindrical trichomes from the same pole of each cell.

The reaction capabilities of the cells of different tissues are both quantitative and qualitative. The cells of the epidermis, parenchyma, sap bundles react differently and this is expressed in the formation of intumescences, callus wound-cork and wound-wood out of them. The change in the reaction of cells is also a noteworthy feature in the study of abnormal plant structure. There is a difference between young

organs, tissues and cells, as expressed in the growth, plasticity and processes of differentiation under the influence of the exciting cause, as is evidenced in the formation and nutrition of galls comprehended under the general head of cecidogenesis.

The recent study of the developmental mechanics of pathologic tissues calls for an investigation of stimuli, and the reaction to stimuli where every reaction presupposes a capacity for reaction and where the cells of different tissues vary in this respect and no cell remains always the same, but changes without any influence of the external world with the age of the cell, as well as the fact that every reaction presupposes previous conditions which permit the reaction to take place. Such considerations as these introduce the student to the investigation and terminology of Roux, as set forth in his "Terminologie der Entwicklungs Mechanik der Tiere und Pflanzen," 1912, and to the work of Vöchting, Küster, Klebs, Haberlandt, Němec and others along experimental lines. Correlation, Neoevolution, Neoepigensis are terms with which the pathologic student must become acquainted. He learns that Osmomorphosis comprehends all osmotic and turgor influences which determine the form and differentiation of cells and tissues; that mechano-morphosis is where plant cells and tissues have been modified in development by mechanic pressure and pull; that chemomorphosis is where chemic influences are the determining factors in molding the form and controlling the differentiation process; that trophomorphosis is where abnormal nutrition is influential locally in the transformation of plants.

The consideration of chemomorphosis shows us that we may deal with known chemic bodies the action of which can be studied experimentally, or we may be concerned with unknown chemic substances, as the poisons injected into the tissues of a plant by the gall forms which profoundly influence the formation of the gall tissues.

Trophic correlation, or trophomorphosis, exists between the parts of a cell, as well as between the organs of a plant, or the tissues of the organs. The action within the cell may be between the nucleus and the cytoplasm, and its importance in pathologic plant anatomy has been experimentally studied by Gerassimoff and Němec. Gerassimoff's research dealt with the influence of the size of the nucleus on the cytoplasm, while Němec discovered that in chloralized roots of *Vicia faba* the cells with normal diploid chromosome content had didiploid and tetradiploid chromosome-rich nuclei, and that the greater the content of the

cell in nuclear material the greater becomes its volume. Equally remarkable discoveries were made in an investigation of the action of tissues and organs upon one another. Vöchting has produced a bending growth in the root of the kohlrabi by removal of the leaves of one side of the plant, so that the development of the normal side was markedly greater than that of the other. The same effect was secured in the petiole of a compound leaf of *Ptelea mollis* by removal of a lateral leaflet and the result of this experiment is displayed in the accompanying figure. Narcotics and the vitiation of the atmosphere by poisonous gases inhibit growth in length. Mathuse figures the effect of removal of the growing point of a plant in the promotion of superficial leaf growth and other anatomic changes in the leaves of *Achyranthes Verschaffeltii*. Other experiments of a somewhat similar nature are equally illustrative. Hardly a more important and inviting field of research has been opened than that which has been revealed by the investigation of the experimental plant morphologists, or the experimental pathologic plant anatomists.

BIBLIOGRAPHY OF DEVELOPMENTAL MECHANICS OF PATHOLOGIC TISSUES

- BORDNER, J. S.: The Influence of Traction on the Formation of Mechanical Tissue in Stems. *Botanical Gazette*, 48: 251, 1909.
- BÜCHER, H.: Anatomische Veränderungen bei gewaltsamer Krümmung und geotropischer Induktion. *Jahrbücher für wissenschaftliche Botanik*, 43: 271, 1906.
- COWLES, H. C.: A Text-book of Botany for Colleges and Universities, vol. ii, *Ecology*, 1911.
- DANIEL, W.: Zur Kenntnis der Riesen- und Zwergblätter, Dissertation, Göttingen, 1913.
- EWART, A. J. and MASON-JONES, A. J.: The Formation of Red Wood in Conifers. *Annals of Botany*, 20: 201, 1906.
- GOEBEL, K.: *Organography of Plants* (English edition), 1: 206, 1900.
- HABERLANDT, G.: Vergleichende Anatomie des assimilierenden Gewebesystems der Pflanzen. *Jahrbücher für wissenschaftliche Botanik*, 13: 74, 1882.
- HABERLANDT, G.: Zur Physiologie der Zellteilung. *Sitzungsber. Akad. Wiss., Berlin*, 1913, Nr. xvi.
- HABERLANDT, G. transl. by DRUMMOND, MONTAGU: *Physiological Plant Anatomy*, Macmillan and Co., London, 1914.
- HOFFMANN, R.: Untersuchungen über die Wirkung mechanischen Kräfte auf die Teilung, Anordnung und Ausbildung der Zellen beim Aufbau des Stammes der Laub und Nadelhölzer. Dissertation, Berlin, 1885.
- HARTIG, R.: Das Rotholz der Fichte. *Forstl. naturwiss. Zeitschr.*, 5: 96, 1896.

- HIBBARD, R. P.: The Influence of Tension on the Formation of Mechanical Tissue in Plants. *Botanical Gazette*, 43: 361, 1907.
- KELLER, H.: Ueber den Einfluss von Belastung und Lagelauf die Ausbildung der Gewebe in Fruchtsielen. Dissertation, Kiel, 1904.
- KNY, L.: Ueber den Einfluss von Zug und Druck auf die Richtung der Scheidewände in sich teilenden Pflanzenzellen. *Jahrbücher für wissenschaftliche Botanik*, 37: 55, 94, 1901.
- KÜSTER, ERNST: Histologische und experimentelle Untersuchungen über Intumescenzen. *Flora*, 96: 527, 534, 1906.
- KÜSTER, ERNST: Aufgaben und Ergebnisse der entwickelungsmechanischen Pflanzenanatomie *Progressus Rei Botanicæ*, 2: 455, 1908.
- KÜSTER, ERNST: Gallen der Pflanzen, Leipzig, 1911.
- MIEHE, H.: Wachstum, Regeneration und Polarität isolierter Zellen. *Berichte der Deutschen botanische Gesellschaft*, 23: 257, 1905.
- NĚMEC, B.: Studien über die Regeneration, 1905.
- NEWCOMBE, F. C.: The Regulatory Formation of Mechanical Tissue. *Botanical Gazette*, 20: 441, 1895.
- NORDHAUSEN, MAX: Ueber Richtung und Wachstum des Seitenwurzeln unter dem Einfluss äusserer und innerer Faktoren. *Jahrbücher für wissenschaftliche Botanik*, 44: 557, 1907.
- PIETERS, A. J.: The Influence of Fruit-bearing on the Development of Mechanical Tissue in Some Fruit Trees. *Annals of Botany*, 10: 511, 1896.
- PREIN, R.: Ueber den Einfluss mechanischer Hemmung auf die histologische Entwicklung der Wurzeln. Dissertation, Bonn, 1908.
- ROUX, WILHELM: Der Kampf der Teile im Organisms, Leipzig, 1881.
- ROUX, WILHELM: Terminologie des Entwicklungs mechanik der Tiere und Pflanzen Leipzig, 1912.
- SCHULTE, W.: Ueber die Wirkung der Ringelung auf Blättern. Dissertation, Göttingen, 1912.
- SIMON, S.: Experimentelle Untersuchungen über die Entstebung von Gefässverbindungen. *Berichte der Deutschen botanische Gesellschaft*, 26: 364, 393, 1908.
- SMITH, L. M.: Beobachtungen über Regeneration und Wachstum aus isolierten Teilen von Pflanzen embryonen. Dissertation, Hallea S., 1907.
- SNOW, L. M.: The Development of Root Hairs. *Botanical Gazette*, 40: 12, 1905.
- STRASBURGER, E.: Ueber die Wirkungssphäre der Kerne und die Zellgrösse Histologische Beiträge, 1893: 5.
- STRASBURGER, E.: Die Ontogenie des Zelle seit 1875. *Progressus Rei Botanicæ*, 1: 1, 90, 1907.
- VÖCHTING, HERMANN: Ueber die Bildung der Knollen. *Bibliotheca Botanica*, 4: 11, 1887.
- VÖCHTING, HERMANN: Untersuchungen zur experimentellen Anatomie und Pathologie des Pflanzenkörpers, Tübingen, 1908.
- VON SCHRENK, H.: Intumescences Formed as a Result of Chemical Stimulation. *Report Mo. Bot. Gard.*, 1905: 125.
- WORGITZKY, G.: Vergleichende Anatomie der Ranken, *Flora*, 70: 2-25 et seq., 1887.

WORTMANN, J.: Zur Kenntnis der Reizbewegungen, *Botanische Zeitung*, 45: 819, 1887.

SUGGESTIONS TO TEACHERS AND STUDENTS

The investigation of plant diseases in general is most important and it should be approached from a number of standpoints.¹ The teacher is interested in it, because he desires to arrange the subject matter, so that it may be presented in the laboratory and lecture course. The experience of the writer along these lines may be of service to other teachers, and it is given, therefore, with some detail. Living plants should be kept for experimentation along pathologic lines. The best plants for this purpose will be determined by the locality, by their availability, by the ease of their cultivation and by their successful growth in the greenhouse during the short days of winter. The experiments outlined in the lessons of part IV can be tried upon these plants, such as the influence of chemicals upon growth, the action of illuminating gas on the health of the plant, and the extremely minute, or excessive action of amounts of chemic reagents, for some experiments conducted by Free at Johns Hopkins University indicate that various plants react in a specific way to extreme dilution of poisonous substances.²

The plants can be wounded in various ways and on different organs. The repair tissue can be studied by sectioning the healed part and staining with appropriate stains. Various infection experiments can be tried with fungi and the lesions produced can be fixed and imbedded in paraffin for sectioning, mounting, and for study later under the microscope.. The stock of such material for study can be increased materially by collecting galls, insect depredations on plants, examples of callus formation from street trees, which have been injured by horses biting off the bark, or by abrasion with wagon wheels. This material, collected from the streets and highways, from the woods and fields, should be fixed and hardened and finally embedded in paraffin for sectioning and microscopic study. These sections should be furnished along with alcoholic, or dried material of the abnormal plant, so that the student

¹ Cf. SHEAR, C. L.: *Mycology in Relation to Phytopathology*. Science, new ser., xli: 479-484, April 2, 1915.

SMITH, E. F.: *Plant Pathology: Retrospect and Prospect*. Science, new ser. xv: 601-612, April 18, 1902.

² FREE, E. E.: *Symptoms of Poisoning by Certain Elements, in Pelargonium and other Plants*. *Contributions to Plant Physiology*, The Johns Hopkins University, March 1917; 195-198.

becomes familiar with the gross anatomy, as well as the microscopic. Photomicrographs can be made readily by the use of the Edinger apparatus which has been used successfully at the University of Pennsylvania in class work. It adds materially to the interest of the work to take photographs of the sections studied and make permanent prints of the diseased structures. After a few years, the alcoholic stock material will have increased to such an extent that all phases of pathologic plant anatomy can be demonstrated, not only by actual specimens, but also by sections. The sections, if made directly by the sliding microtome, can be kept in large numbers in small bottles in 50 per cent. alcohol, where they are available for class use at any time. The paraffin mounts can be kept in block form ready for use when required by the sequence of laboratory exercises and lectures. If alcohol is not available on account of its high price, other materials may be used in its place.

The sections and alcoholic material having been prepared for use can be studied for hypertrophy, for metaplasia, hypoplasia and other pathologic conditions. Such an investigation presupposes a thorough grounding in the technique of plant anatomy and histology, so that no time may be wasted in unnecessary explanations. From the standpoint of curriculum, such a course in mycology and pathologic plant anatomy should be given in the junior, or senior years, or deferred until the post-graduate years because of the special nature of the work.

Written reports should be required of all students based upon the experiments with the inoculation and infection of various cultivated plants and their reaction to various fungi. Similarly, where pathologic anatomy and histology of plant organs and tissues are concerned photographic prints may take the place of microscopic drawings. Each topic considered in the lecture course should receive attention in the laboratory and in the field and indoor experiments, because this work is designed to prepare future plant doctors, teachers and investigators, who are interested in the science of phytopathology and who are anxious to be proficient in the study of plant diseases.

Stock material should be kept of all the more common insect and fungous diseases of cultivated and wild plants not only for such pathologic study, but also for a systematic and morphologic work with insect and fungous parasites. The mycologic student should be able to identify not only the more common insects and fungi after such a

course, but should be able also to diagnose the more common diseases and suggest remedies in the form of insecticides, or fungicides, or other remedial measures from a knowledge of the physiology of pathologic plants. A change in the soil, or a change in the temperature and exposure may be all that is needed to keep a plant in a perfect state of health.

The problems which may be assigned to the post-graduate student for experimental investigation are unlimited in America, where the nation is confronted by serious pests introduced from various lands. The anatomic and histologic characters and the development of cecidia have been the subject of extensive studies in Europe, but American botanists have done very little in the study of American galls along these lines of investigation. The character of the poisons which cause the stimulation of the plant to produce the galls is a matter well worth the attention of botanists experimentally inclined. The equipment of the laboratory and the facilities for experimentation should be considered before the problem is assigned to the post-graduate student. The previous training and bias of the individual should be weighed carefully for the research work may be of a cytologic nature. It may be a histologic study pure and simple with pathologic tissues, or the problem may deal with prophylaxis, or preventive measures. It may be that the student is better prepared to investigate the etiology of disease, or the composition of sprays and their effects on the plant tissues. Some advanced students would find keener zest in the systematic or biologic study of some fungus, or group of fungi, or the bias may be toward detailed experimentation with insects, or other forms of animal life. The teacher should weigh carefully all of these details and act accordingly. Problems with an economic bearing would be more suitable for the students of agricultural colleges and experiment stations, while matters of pure science might be properly relegated to the endowed colleges and universities, where investigation with a practical trend would not be absolutely essential. The laboratory work should be combined with field work in the study of inorganic and organic diseases. The character of the field work will be determined by the nature of the investigation and by the season and by the climatic conditions. The work in the field at first would consist in the observation of diseases, the taking of notes from the living trees and the collection of material for more detailed study. The extent of the injury should be

determined. Extension and the work of prevention can be carried on. Coöperative work with the progressive farmers and horticulturists can be inaugurated with profit to the farmer and the investigator. The etiology of diseases can be investigated by properly directed field experiments. Inoculations can be made on plants growing in the field, or in the laboratory or greenhouse.¹ Such original investigation presupposes the accumulation of apparatus and a suitable working library. With the limited appropriation available for the purchase of apparatus and books, such an equipment seems beyond the ordinary school and college, but it will be surprising to those who have not tried the plan how many books, diagrams, etc., can be accumulated, and how much apparatus can be secured by spreading the purchase of such needful things over a series of years. If the books and apparatus are cared for, little deterioration need be suffered and at the end of twenty or twenty-five years, a respectable stock of these desiderata will be on hand for use in the class room, laboratory, research rooms and greenhouses.

The growth of the study of plant pathology as a distinct branch of science has been by leaps and bounds. It is now on a more satisfactory basis than ever before, and a larger number of men and women are directing their attention to phytopathology as a life work. The men who enter this field from now on must have a better and an all-sided training. This presupposes an acquaintance with the literature of the subject in his own and several foreign languages. There should also be a training in chemistry and physics. He should know something about zoology and should be conversant with the physiology and histology of plants and other phases of botanic inquiry. To meet this demand our American colleges and universities have introduced subjects which will be of direct benefit to the future plant pathologist. The curricula² have been arranged to introduce the study, not only of plant pathology, but also cognate subjects some of which may not have a direct bearing, but which make the man a well-trained and a competent "plant doctor."

¹ Cf. HEALD, F. D.: Field Work in Plant Pathology. *The Plant World*, 10: 104-109, May, 1907.

² FINK, BRUCE: A College Course in Plant Pathology. *Phytopathology*, II: 150-152, August, 1912. Consult STEVENS, F. L.: Problems of Plant Pathology, *The Botanical Gazette*, lxiii: 297-306, Apr., 1917; also HARSHBERGER, JOHN W.: The Need of Competent Plant Doctors, *Education*, 1895, 140-144.

PART III
SPECIAL PLANT PATHOLOGY

CHAPTER XXXIII

LIST OF SPECIFIC DISEASES OF PLANTS

The remarkable growth of the work of the United States Department of Agriculture, and that of the agricultural experiment stations of the different states, has been along the most diverse lines. Mycology has been given prominence and the number of trained workers in this field has increased to such an extent, that a separate organization, known as the American Phytopathological Society, has been found necessary. The meetings of this society have been largely attended and the papers read have been of the greatest value and interest. The organ of the society, "Phytopathology," has published already a considerable number of important papers, and it has set a high standard for the future work along mycologic and pathologic lines. One of the specific problems, which it has attempted to do through special committees appointed for the purposes, has been to suggest the use of common names of fungous diseases based on recognized rules of procedure and to prepare a list of the common and important diseases of economic plants in the United States and Canada. The preliminary report of the committee on common names has been made, but considerable time must elapse before the list of common and important diseases is completed.

As this book will be printed and issued before the preliminary list of the American Phytopathological Society of fungous diseases appears, it has been deemed advisable to compile a list from various sources of information for the common host plants in the United States and Canada, using the "Literature of Plant Diseases" given by W. C. Sturgis in the Report of the Connecticut Agricultural Experiment Station for the year ending Oct. 31, 1900, part III, pages 255-293, as the basis of such a list.

That the list might be made as complete as possible and representative of the plant diseases of the United States and the tropic countries to the southward, the following publications have been used in its compilation.

- ATKINSON, GEO. F.: Studies of Some Shade Tree and Timber-destroying Fungi. Cornell Univ. Agric. Exper. Sta., Bull. 193, June, 1901.
- COIT, J. E.: Citrus Fruits, 1915: 364-402, The Macmillan Co.
- COOK, MELVILLE T.: The Diseases of Tropical Plants, 1913, The Macmillan Co.
- DUGGAR, BENJ. M.: Fungous Diseases of Plants, 1909, Ginn and Co.
- FREEMAN, E. M.: Minnesota Plant Diseases, 1905.
- GRAVES, ARTHUR H.: Notes on Diseases of Trees in the Southern Appalachians. Phytopathology, III (1913) and IV (1914).
- HEALD, FREDK. D. and WOLF, FREDK. A.: A Plant-disease Survey in the Vicinity of San Antonio, Texas. U. S. Bureau of Plant Industry, Bull. 226, 1912.
- HESLER, LEX R. and WHETZEL, HERBERT H.: Manual of First Diseases. xx + 146 pages, 126 figs., 1917, The Macmillan Co.
- HUME, H. HAROLD: Citrus Fruits and Their Culture, 1911: 466-492, Orange Judd Co.
- JACKSON, H. S.: Some Important Plant Diseases of Oregon in Biennial Crop Pest and Horticultural Report, 1911-1912, Oregon Agric. Exper. Sta., 177-308.
- LONGYEAR, B. O.: Fungous Diseases of Fruits in Michigan. Michigan State Agric. Coll. Exper. Sta., Special Bull. No. 25, March, 1904.
- MEINECKE, E. P.: Forest Tree Diseases Common in California and Nevada. U. S. Forest Service, A Manual for Field Use, 1914.
- REED, HOWARD S. and COOLEY, J. S.: Plant Diseases in Virginia in the Years 1909 and 1910.
- ROBBINS, W. W. and REINKING, OTTO A.: Fungous Diseases of Colorado Crop Plants. Agric. Exper. Sta. Colo. Agric. Coll., Bull. 212, October, 1915.
- SELBY, A. D.: A Brief Handbook of the Diseases of Cultivated Plants in Ohio, Bull. 214, Ohio Agric. Exper. Sta., 1910.
- SHEAR, C. L. and WOOD, ANNA K.: Studies of Fungous Parasites Belonging to the Genus *Glomerella*. U. S. Bureau of Plant Industry, Bull. 252, 1913.
- SMITH, RALPH E. and SMITH, ELIZABETH H.: California Plant Diseases. Coll. of Agric., Agric. Exper. Sta., Bull. 218, June, 1911.
- STEVENS, F. L. and HALL, J. G.: Diseases of Economic Plants, 1910, The Macmillan Co.
- VON SCHRENK, HERMANN: Some Diseases of New England Conifers. U. S. Div. Veg. Physiol. and Pathol., Bull. 25.
- VON SCHRENK, HERMANN: Sap-rot and Other Diseases of the Red Gum. U. S. Bureau of Plant Industry, Bull. 114, 1907.
- VON SCHRENK, HERMANN and SPAULDING, PERLEY: Diseases of Deciduous Forest Trees. U. S. Department of Plant Industry, Bull. 149, 1909.
- WHETZEL, H. H. and ROSENBAUM, J.: The Diseases of Ginseng and Their Control. U. S. Bureau of Plant Industry, Bull. 250, 1912.

This list will serve as an index of the diseases which will be described

in full in the remainder of part III. As it will be impossible to describe in detail all of the diseases of the list, a selected number will be chosen, which will illustrate the subject and which, if mastered by the student, will lay the foundation for a more thorough acquaintance with the diseases, which are prevalent in the United States, and which the student, the teacher, the horticulturist, the forester, the agriculturist, and the practical mycologist are likely to meet in their plant-growing experience. It is recommended that for each of the diseases described in the following pages the outline for the use of students given in Lesson 29 be used to facilitate an investigation of the disease in the laboratory, greenhouse, or in the open field. This is a method of study approved by the best teachers of the United States.¹ The author wishes to state emphatically that he has designedly kept down the number of diseases described in the following pages because the thorough mastery of a limited number is better than a superficial study of a larger list.

The general list precedes the descriptive pages of part III dealing with a series of specific plant diseases, especially chosen because of the author's familiarity with them, or because, they stand out prominently as some of the more important diseases, which concern the American plant-grower.

These specific diseases are divided into two groups. One group includes the parasitic diseases due to fungi as the causal organisms. The other group includes the non-parasitic, or so-called physiologic diseases of plants. These have been treated in general in part II of this book, but certain of the non-parasitic diseases have become of such general interest that they merit a more detailed treatment. The literature of these diseases is very much scattered, the only general account being one published by Sorauer, Lindau and Reh in their "Handbuch der Pflanzenkrankheiten" (3d Edition of Sorauer), 1908. This work is being translated by Frances Dorrance. Four parts of Vol. I have been printed and the other parts will appear as fast as translated and printed. The English edition beginning 1914 is entitled "Manual of Plant Diseases." To this work the student of plant pathology is referred for many details.

¹ WHETZEL, H. H. and COLLABORATORS: Laboratory Exercises in Plant Pathology, Ithaca, N. Y., 1916.

PARASITIC DISEASES OF PLANTS

A LIST OF THE COMMON AND IMPORTANT DISEASES OF ECONOMIC
PLANTS IN THE UNITED STATES AND CANADA

ALFALFA

(Medicago sativa, L.)

- Anthraxnose (*Colletotrichum trifolii*, Bain).
Journ. Mycol., Vol. XII, p. 192 (1906).
- Bacterial Blight (*Pseudomonas medicaginis* Sackett).
Bull. 212, Colo. Agr. Exp. Sta. (October, 1915).
- Downy Mildew (*Peronospora trifoliorum*, de By.).
N. Y. Agr. Exp. Sta., Bull. 305, p. 394 (1908).
- Leaf-blotch (*Pyrenopeziza medicaginis*, Fckl.).
Phytopathology 6, Abstracts of Columbus Meeting.
- Leaf-spot (*Pseudopeziza medicaginis* (Lib.), Sacc.).
Ibid., p. 384.
- Root-gall (*Urophlyctis alfalfæ* (v. Lagerh.), Magn.).
Duggar, Fungous Diseases of Plants, p. 140 (1909).
- Texas Root-rot (*Ozonium omnivorum*, Shear.)
Tex. Agr. Exp. Sta., Bull. 22 (1892).
- Rust (*Uromyces striatus* Schröt.).
Bull. 218, Calif. Exp. Sta. (June, 1911).
Iowa Bull. 131, p. 209 (April, 1912).
- Violet Root-rot (*Rhizoctonia crocorum* (Pers.) DC.).
Phytopathology 1, p. 103 (1911).
- Winter Injury.
N. Y. (Cornell) Agr. Exp. Sta., Bull. 221, p. 6 (1904).

ALMOND

(Prunus amygdalus, Baill.)

- Armillaria Root-Rot (*Armillaria mellea*, Vahl).
Cal. Agr. Exp. Sta., Bull. 218, p. 1084 (1911).
- Crown-gall (*Pseudomonas tumefaciens*, E. F. Sm. & Towns).
Ariz. Agr. Exp. Sta., Bull. 33 (1900).
- Die-back (*Non-par.*).
Cal. Agr. Exp. Sta., Bull. 218, p. 1086 (1911).
- Rust (*Puccinia pruni-spinosæ* Pers.).
Duggar, Fungous Diseases of Plants, p. 417 (1909).
- Shot-hole (*Cercospora circumcissa*, Sacc.).
Journ. Mycol., Vol. VII, p. 66 (1892).

AMPELOPSIS

- Leaf-spot (*Phyllosticta ampelopsidis*, Ell. & Mart, *Laestadia Bidwellii* (Ell.) V. & R.
and *Sphaeropsis hedericola* (Speg.).

N. J. Exp. Sta., Rep. (1914).

Die-back (*Cladosporium* sp.).

N. J. Exp. Sta. Rep. (1914).

APPLE

(*Pirus malus*, L.)

Anthracnose (*Gleosporium malicorticis*, Cordley; Ascigerous stage said to be *Neofabraea malicorticis* (Cordley) Jackson, see Phytopathology 2: 94, 1912).

Oregon Sta., Biennial Rep., pp. 178-197 (1911-12).

Arsenical Poisoning.

Cal. Agr. Exp. Sta., Bull. 131 (1908).

Bark-canker (*Myxosporium corticolum*, Edg.).

Ann Myc., Vol. VI, p. 48 (1908).

Bitter-rot (*Glomerella rufomaculans* (Berk.) Spauld. & v. Schr.).¹

Bitter-rot canker, U. S. Dept. Agr. Bur. Plant Industry, Bull. 44 (1903).

Black-rot (*Sphaeropsis malorum*, Berk.).

Black-rot Canker.

N. Y. State Agr. Exp. Sta., Bull. 163 (1899).

Black-rot Leaf-spot.

U. S. Dept. Agr. Bur. Plant Industry, Bull. 121, p. 47 (1908).

Blight (*Bacillus amylovorus* (Burr.), Trev.).

Blight-canker, N. Y. (Cornell) Agr. Exp. Sta., Bull. 236 (1906).

Blossom-blight, Phytopathology, Vol. IV, p. 27 (1914).

Collar-blight, Penn. Agr. Exp. Sta., Bull. 136, p. 7 (1915).

Fruit-blight, *Ibid.*, p. 20.

Twig-blight, N. Y. (Cornell) Agr. Exp. Sta., Bull. 329, p. 322 (1913).

Blister-canker (*Nummularia discreta* (Schw.) Tul.).

Ill. Agr. Exp. Sta., Bull. 70 (1902).

Blotch (*Phyllosticta solitaria*, Ell. & Ev.).

Blotch canker, U. S. Dept. Agr. Bur. Plant Industry, Bull. 144, p. 10 (1909).

Blotch leaf-spot, *Ibid.*, p. 11.

Fruit-blotch, *Ibid.*, p. 9.

Blossom End Rot (*Alternaria* sp.).

N. J. Exp. Sta. Rep., p. 471 (1914).

Blue Mold Rot (*Penicillium* spp.).

Stevens Diseases of Economic Plants, p. 94 (1913).

Brown-rot² (*Sclerotinia fructigena* (Pers.) Schröt.).

Stevens and Hall; Diseases of Economic Plants, p. 92 (1913).

Canker (Pacific Coast) (*Macrophoma curvispora*, Pk.).

Stevens & Hall, Diseases of Economic Plants, p. 83 (1913).

Common Rust (*Gymnosporangium juniperi-virginiana*, Schw.).

U. S. Dept. Agr., Rep., 1888, p. 376 (1889).

¹ Consult SHEAR, C. L. and WOOD, ANNA K: Studies of Fungous Parasites Belonging to the Genus *Glomerella*. U. S. Bureau of Plant Industry, Bull. 252, 1913.

² For apple rots consult Phytopathology 4, p. 403, December, 1914, and Manual of Fruit Diseases by Hesler and Whetzel.

- Crown-gall (*Pseudomonas tumefaciens*, E. F. Sm. & Towns).
U. S. Dept. Agr. Bur. Plant Industry, Bull. 186, p. 13 (1910).
Hairy-root, *Ibid.*, p. 14.
- Fly-speck (*Leptothyrium pomi* (Mont. & Fr.), Sacc.).
Ohio Agr. Exp. Sta., Bull. 79, p. 133 (1897).
- Frost-blister (*Non-par.*).
N. Y. Agr. Exp. Sta., Bull. 220 (1902).
- Frog-eye Spot (*Phyllosticta pirina* Sacc.)
Va. Rep., pp. 95-115, figs. 16 (1911-12).
- Fruit-pit (*Non-par.*).
Bull., Torr. Bot. Club, Vol. XXXV, p. 430 (1908).
- Fruit-spot { *Phyllachora pomigena* (Schw.), Sacc.
Phoma pomi, Pass. (Phytopath., Vol. II, pp. 63-72).
Spharopsis malorum, Pk.
Bull. 121, U. S. Bureau Pl. Indst.
- Leaf-spot (Frog-eye) (*Phyllosticta pirina*, Sacc.).
R. I. Agr. Exp. Sta., Rep. 7, pp. 188-192 (1895).
- Pink-rot (*Cephalothecium roseum*, Cda.).
N. Y. Agr. Exp. Sta., Bull. 227 (1902).
- Powdery Mildew (*Podosphæra leucotricha* (Ell. & Ev.) Salm. and *P. oxyacanthæ* (DC.) de By.).
U. S. Dept. Agr., Bull. 120 (1914).
- Ripe-rot (*Glосporium fructigenum*, Berk.).
Journ. Mycol., Vol. VI, pp. 164, 172 (1891).
- Root-rot (*Armillaria mellea* Vahl).
Oregon State Biennial Report, pp. 226-233 (1911-12).
- Scab (*Venturia inaequalis* (Cke.), Wint.).
N. Y. (Cornell) Agr. Exp. Sta., Bull. 335 (1913).
Mont. Bull. 96, pp. 65-102, pl. 1, figs. 3 (February, 1914).
- Scab (*Fusicladium dendriticum* (Wallr.) Fckl.).
Wash. Bull. 64, pp. 24, pls. 2, figs. 5 (1904).
- Rusts (*Gymnosporangium juniperi virginianæ* Schw. (*Ræstelia pirata* (Schw.), Thaxt.);
G. globosum, Farl. (*Ræstelia lacrata*, y, z. Thaxt.).
- Scald (*Non-par.*).
Vt. Agr. Exp. Sta., Rep. 10, p. 55 (1897).
- Scurf (*Phyllosticta prunicola* (Opiz), Sacc.).
Stevens & Hall, Disease of Economic Plants, p. 78 (1911).
- Silver-leaf (*Stecrum purpurcum*, Pers.).
Phytopathology 1, p. 177 (1911).
- Sooty-blotch (*Leptothyrium pomi* (Mont. & Fr.), Sacc.).
Duggar, Fungous Diseases of Plants, p. 367 (1909).
- Spongy Dry-rot (*Volutella fructi*, Stev. & Hall).
Duggar, Fungous Diseases of Plants, p. 316 (1909).
- Spray Injury (*Non-par.*).
Bordeaux injury, N. Y. Agr. Exp. Sta., Bull. 287 (1907).
Lime-sulphur injury, Ore. Agr. Exp. Sta., Research Bull. 2 (1913).

- Stem-blight (*Pseudomonas medicaginis*, Sackett.)
Col. Bull. 158, April, 1910, pp. 3-32; Bull. 159, pp. 3-15 (April, 1910).
- Stem-rot (*Schizophyllum commune* Fr.)
Bull. 218, Calif. Agr. Exp. Sta. (June, 1911).
- Volutella Rot (*Volutella fructi*, Stev. & Hall).
N. C. Agr. Exp. Sta., Bull. 196, pp. 41-48 (1907).
- Water-core (*Non-par.*).
Phytopathology 3, p. 121 (1913).
- Winter Injury (*Non-par.*).
Winter bark-splitting, Canada Exp. Farm. Rep., 1908, p. 112 (1908).
Winter black heart, *Ibid.*, p. 113.
Winter bud-injury, Mont. Agr. Exp. Sta., Bull. 91 (1912).
Winter crotch-injury, Me. Agr. Exp. Sta., Bull. 164, p. 17 (1909).
Winter crown-rot, N. Y. Agr. Exp. Sta., Techn. Bull. 12, p. 370 (1909).
Winter die-back, Canada Exp. Farms, Rep., 1904, p. 108; 1908, p. 113.
Winter root-injury, Iowa Agr. Exp. Sta., Bull. 44, p. 180 (1899).
Winter sunscald, Canada Exp. Farm Rep., p. 112 (1908).

APRICOT

(*Prunus armeniaca*, L.)

- Bacteriosis (*Pseudomonas pruni*, E. F. Sm.).
N. Y. (Corn.) Agr. Exp. Sta., Mem. 8 (1915).
- Black-knot (*Plowrightia morbosa* (Schw.), Sacc.).
Bull. 212, Colo. Exp. Sta. (October, 1915).
- Blight (*Bacillus amylovorus* (Burr.), Trev.).
Colo. Agr. Exp. Sta., Bull. 84 (1903).
- Blossom-rot (*Sclerotinia libertiana*, Fckl.).
Cal. Agr. Exp. Sta., Bull. 218, p. 1097 (1911).
- Brown-rot (*Sclerotinia fructigena* (Pers.), Schrt.).
Ibid.
- California Blight (*Coryneum Beijerinckii*, Oud.).
Cal. Agr. Exp. Sta., Bull. 203, p. 33 (1909).
- Die-back (*Valsa leucostoma* (P.), Fr.)
Heald & Wolf, Plant Disease Survey, San Antonio, Tex. (1912).
- Gummosis (*Various causes*).
Amer. Gard., Vol. XIX, p. 606 (1898).
- Shot-hole (*Cylindrosporium padi*, Karst.).
Heald and Wolf, Plant Disease Survey, San Antonio, Tex. (1912).

ARBOR-VITÆ

(*Thuja occidentalis*, L.)

- Die-back (*Pestalozzia* sp.)
N. J. Agr. Exp. Sta., Rep., p. 517 (1912).
- Root-rot (*Polyporus Schweinitzii*, Fr.).
U. S. Dept. Agr. Div. Veg., Phys. & Path., Bull. 25, p. 23 (1900).

ASH

*(Fraxinus sp.)*Decay, or Brown-rot (*Polyporus sulphureus* (Bull.), Fr.).Heart-rot (*Fomes fraxinophilus* (Pk.), Sacc.).

U. S. Dept. Agr. Bur. Plant Industry, Bull. 32 (1903).

von Schrenk, H., Diseases of Deciduous Forest Trees, U. S. Bur. of Plant Industry, Bull. 149 (1909).

Leaf-spot (*Cercospora fraxinites*, Ell. & Ev.; *Cylindrosporium viridis*, Ell. & Ev., and *Septoria submaculata*, Wint.).Rust (*Aecidium fraxini*, Schw.).

Rep., Conn. Exp. Sta., p. 304 (1903).

ASPARAGUS

*(Asparagus officinalis, L.)*Blight (*Cercospora asparagi*, Sacc.).

Heald & Wolf, Plant Diseases Survey in Texas (1912).

Rust (*Puccinia asparagi*, DC.).

N. J. Agr. Exp. Sta., Bull. 129 (1898).

Calif. Bull. 165, pp. 1-7, 18-95, 98, 99, figs. 32 (Jan., 1905).

ASTER, CHINA

*(Callistephus chinensis, Nees)*Rust (*Coleosporium solidaginis* (Schw.), Thüm).Wilt (*Fusarium sp.*).

Mass. (Hatch) Agr. Exp. Sta., Bull. 79, p. 5 (1902).

Yellow (undetermined).

Ibid., p. 11.

AZALEA

Rust (*Pucciniastrum minimum* (Schw.), Arth.).

Conn. Exp. Sta., Rep., p. 854 (1907-1908).

BAMBOO

*(Phyllostachys henonis, Mitf. and P. quilioi, Riv.)*Smut (*Ustilago Shiraiana*, Henn.).

Patterson, Flora W. and Charles, Vera K., The Occurrence of Bamboo Smut in America. Phytopath. 6, pp. 351-356 (1916).

BANANA

*(Musa spp.)*Trinidad Bud-rot (*Bacillus musæ*, Rorer.).

Phytopath. 1, pp. 43-49 (1911).

Ripe Fruit-rot (*Glcosporium musorum*, Cke. and Mass.).

Root Disease (*Marasmius semiustus*, Bri. & Cav.).

See Cook, Diseases of Tropical Plants, 1889, pp. 133-136 (1913).

BARLEY

(*Hordeum sativum*, Jess.)

Anthraxnose (*Colletotrichum cereale*, Manns) = *graminicola* (Ces.) Wilson Phytopath, 4:110.

Ohio Agr. Exp. Sta., Bull. 203, pp. 187-212 (1909).

Covered-smut (*Ustilago hordei* (Pers.), K. & S.).

Kan. Agr. Exp. Sta., Rep. 2, p. 269 (1890).

Nebr. Rep., pp. 45-53, figs. 4 (1907).

Ergot (*Claviceps purpurea* (Fr.), Tul.).

So. Dak. Agr. Exp. Sta., Bull. 33, p. 38 (1893).

Leaf-rust (*Puccinia simplex* (Körn), Erikss. & Henn.).

U. S. Dept. Agr. Bur. Plant Industry, Bull. 216 (1911).

Loose-smut (*Ustilago nuda* (Jens.), K. & S.).

U. S. Dept. Agr. Bur. Plant Industry, Bull. 152, p. 7 (1909).

Powdery Mildew (*Erysiphe graminis*, DC.).

Bull., Ill. State Lab. Nat. Hist., Vol. II, pp. 387-432 (1887).

Scab (*Gibberella saubinetii* (Mont.), Sacc.).

Ohio Agr. Exp. Sta., Bull. 203, pp. 212-232 (1909).

Stem-rust (*Puccinia graminis*, Pers.).

U. S. Dept. Agr. Bur. Plant Industry, Bull. 216 (1911).

Stripe Disease (Blade-blight) (*Helminthosporium graminum*, Rabenh.).

Iowa Agr. Exp. Sta., Bull. 116, p. 179 (1910).

Bull. 218, Calif. Agr. Exp. Sta. (June, 1911).

BEAN

(*Phaseolus vulgaris*, L.)

Anthraxnose (*Colletotrichum lindemuthianum* (Sacc. & Magn.), Bri. & Cav.).

N. Y. Agr. Exp. Sta., Bull. 48, p. 310 (1892).

Cornell Bull. 255, pp. 431-447, figs. 6 (May, 1908).

Mich. Spec. Bull. 68, pp. 12 (March, 1914).

Bacterial-blight (*Bacterium phaseoli*, E. F. Sm.).

N. Y. Agr. Exp. Sta., Bull. 151, p. 11 (1901).

La. Bull. 139, pp. 43, pls. 6 (January, 1913).

Leaf-spot (*Cercospora canescens*, Ell. & Mart.).

Heald and Wolf, Plant Disease Survey in Texas. (1912.)

Damping-off (*Fungi* spp.).

Pod-blight (*Phoma subcircinata*, Ell. & Ev.).

N. J. Exp. Sta., Rep., p. 472 (1914).

Rhizoctoniose (*Corticium vagum*, Bri. & Cav. var. *solani* Burt).

Rhizoctonia damping off, N. Y. (Cornell) Agr. Exp. Sta., Bull. 94, p. 266 (1895).

Rhizoctonia pod-spot, Science, new ser., Vol. XIX, p. 268 (1904).

Rhizoctonia stem rot, Science, new ser., Vol. XXXI, p. 796 (1910).

Rust (*Uromyces appendiculatus* (Pers.), Lev.).

N. Y. Agr. Exp. Sta., Bull. 48, p. 331 (1892).

Southern Blight (*Sclerotium Rolfsii*, Sacc.).

Fla. Agr. Exp. Sta., Bull. 21, p. 27 (1893).

BEAN (LIMA)

(*Phaseolus lunatus*, L.)

Bacterial Blight (*Pseudomonas phaseoli*, E. F. Sm.).

N. Y. Agr. Exp. Sta., Bull. 48, p. 331 (1892).

Downy Mildew (*Phytophthora phaseoli*, Thax.).

Conn. Agr. Exp. Sta., Rep. 167 (1889).

BEECH

(*Fagus grandifolia*, Ehrh.)

Sap-rot (*Polystictus pergamenus*, Fr.).

von Schrenk, H., Disease of Desiduous Trees, U. S. Bureau of Plant Industry, Bull. 149 (1909).

White Heart-rot (*Fomes igniarius* (L.), Gill.).

N. Y. (Cornell) Agr. Exp. Sta., Bull. 193, p. 214 (1901).

BEEF

(*Beta vulgaris*, L.)

Bacterial Leaf-spot (*Bacterium aptatum*, Brown & Jamieson).

Journ. Agr. Research 1, p. 190 (1913).

Cercospora Leaf-spot (*Cercospora beticola*, Sacc.).

N. Y. (Cornell) Agr. Exp. Sta., Bull. 163, p. 352 (1899).

Nebr. Bull. 73 (1902).

Poole, V. W. and McKay, M. B., Relation of Stomatal Movement to Infection by *Cercospora beticola*, Journ. Agr. Research 5, pp. 1011-1038 (1916).

Crown-gall (*Pseudomonas tumefaciens*, E. F. Sm. & Towns).

U. S. Dept. Agr. Bur. Plant Industry, Bull. 213 (1911).

Curly-top (undetermined).

U. S. Dept. Agr. Bur. Plant Industry, Bull. 122 (1908).

Smith, Ralph E. and Bonquet, P. A.: Connection of a Bacterial Organism with Curly Leaf of the Sugar Beet Phytopath. 5 pp. 335-342 (1915).

Damping-off (*Fungi* spp.).

Downy Mildew (*Peronospora Schachtii*, Fckl.).

Bull. 218, Calif. Agr. Exp. Sta. (June, 1911).

Leaf-scorch (*Non-par.*).

N. Y. Agr. Exp. Sta. Bull. 162, p. 167 (1899).

Mosaic (undetermined).

Science, new ser. Vol. XLII, p. 220 (1915).

Phoma Crown-rot (*Phoma betæ* (Oud.) Fr.).

Frank Die Krankheiten der Pflanzen Zweitl. Aufl. 2, p. 399 (1896).

Journ. Agr. Research 4, pp. 135-168, pls. 11, pp. 169-177 (1915).

Phoma Leaf-spot (*Phoma betæ* (Oud.), Fr.).

Journ. Agr. Research 4, p. 169 (1915).

Phoma Root-rot (*Phoma betæ* (Oud.), Fr.).

Frank Die Krankheiten der Pflanzen Zweite. Aufl. 2, p. 399.

Puccinia Rust (*Puccinia subnitens*, Diet.).

Phytopathology 4, p. 204 (1914).

Rhizoctonia Root-rot (*Corticium vagum*, Bri. & Cav. var. *Solani* Burt).

N. Y. (Corn.) Agr. Exp. Sta., Bull. 163, p. 34 (1899).

Rust (*Uromyces betæ.*).

Bull. 218, Calif. Agr. Exp. Sta. (June, 1911).

Scab (*Actinomyces chromogenes*).

N. Dak. Agr. Exp. Sta., Bull. 4, p. 15 (1891).

Soft-rot (*Bacterium tentillum*, Metc.).

Nebr. Agr. Exp. Sta., Rep. 17, p. 69 (1904).

Tuberculosis (*Bacterium beticola*, E. F. Sm.).

Ct. Dept. Agr. Bur. Plant Industry, Bull. 213, p. 194 (1911).

Uromyces Rust (*Uromyces betæ* (Pers.), Lév.).

U. S. Dept. Agr. Rep., 1887, p. 350 (1888).

BERMUDA GRASS

(*Capriola dactylon* (L.), Kuntze)

Leaf-spot (*Helminthosporium giganteum*, Heald & Wolf).

Heald and Wolf, Plant Disease Survey in Texas (1912).

BIRCH

(*Betula* spp.)

Decay (*Fomes fomentarius* (L.), Fr.).

Red Heart-rot (*Fomes fulvus*, Fr.).

von Schrenk, H., Diseases of Deciduous Forest Trees, U. S. Bureau Plant Industry, Bull. 149 (1909).

Sapwood Decay (*Polyporus betulinus* (Bull.), Fr.).

von Schrenk, H., p. 57.

White Heart-rot (*Fomes igniarius* (L.), Gill).

N. Y. (Corn.) Agr. Exp. Sta., Bull. 193, p. 214 (1901).

BLACKBERRY

*(Rubus spp.)*Anthracnose (*Gleosporium vinctum*, Speg.).

U. S. Dept. Agr., Rep., 1887, p. 357 (1888).

Wash. Bull. 97, pp. 3-18 (1910).

Cane-blight (*Coniothyrium Fuckelii*, Sacc.).Crown-gall (*Bacterium tumefaciens*, E. F. Sm. & Towns).

U. S. Dept. Agr. Bur. Plant Industry, Bull. 213 (1911).

Double-blossom (*Fusarium rubi*, Wint.).

Del. Agr. Exp. Sta., Bull. 93 (1911).

Gall (*Pycnochytrium globosum*, Schröt.).Late-rust (*Kuehneola albida* (Kühn), Magn.).

Mass. (Hatch) Agr. Exp. Sta., Rep. 9, p. 74 (1897).

Leaf-spot (*Septoria rubi*, Westd.).

Conn. Agr. Exp. Sta., Rep. 27, p. 309 (1904).

Orange-rust (*Gymnoconia Peckiana* (Howe), Tranz.).

Ill. Agr. Exp. Sta., Bull. 29, pp. 273-300 (1893).

BOX ELDER

(Acer negundo californicum (T. & G.), Sarg.).Leaf-spot (*Glaosporium negundinis*, Ell. & Ev.).Leaf-tip Blight (*Septoria marginata*, Heald & Wolf).Leaf-blight Buckeye (*Æsculus octandra*, Marsh). (*Phyllosticta æsculi*, Ell. & Mart.)

BOXWOOD

*(Buxus sp.)*Leaf-blight (*Macrophoma Candollei* (B. & Br.), Berl. and Vogl.).Leaf and Stem Disease (*Volutella buxi* (Cda.), Berk.).

BUCKWHEAT

(Fagopyrum esculentum, Mœnch)Leaf-blight (*Ramularia rufomaculans*, Pk.).

Descr., Conn. Agr. Exp. Sta., Rep. 14, 1890, p. 98 (1891).

BUTTERNUT

(Juglans cinerea, L.)Leaf-spot (*Gnomonia leptostyla* (Fr.), Ces. & de Not.).

Mass. (Hatch) Agr. Exp. Sta., Rep. 10, p. 69 (1898).

BUTTONBUSH

(Cephalanthus occidentalis, L.)

- Leaf-blight (*Cercospora pernicioso*, Heald and Wolf).
 Leaf-spot (*Ramularia cephalanthi* (Ell. & Kell.), Heald).

CABBAGE •

(Brassica oleracea, L.)

- Bacterial Leaf-spot (*Bacterium maculicolum*, McCul.).
 U. S. Dept. Agr. Bur. Plant Industry, Bull. 225 (1911).
 Black-leg (*Phoma lingam* (Tode), Desm.).
 Phytopathology 1, p. 28 (1911).
 Black-mold (*Alternaria brassicae* (Berk.), Sacc.).
 U. S. Dept. Agr., Farmers' Bull. 488, p. 31 (1912).
 Black leaf-spot, Ibid.
 Black-mold storage-rot, Ibid.
 Black-rot (*Pseudomonas campestris* (Pam.), E. F. Sm.).
 Wis. Agr. Exp. Sta., Bull. 65 (1898).
 Black-spot (*Macrosporium brassicae*, Berk.). (*Alternaria brassicae* (B.), Sacc.).
 Va. Agr. Exp. Sta., Rep. (1909-1910).
 Club-root (*Plasmodiophora brassicae*, Wor.).
 Journ. Mycol., Vol. VII, p. 79 (1892).
 Va. Bull. 191, pp. 12, figs. 5 (Apr., 1911).
 Vt. Bull. 175, pp. 1-27, pls. 4, figs. 6 (Oct., 1913).
 Damping-off (*Fungi* spp.).
 U. S. Dept. Agr., Farmer's Bull. 488, p. 31 (1912).
 Downy Mildew (*Peronospora parasitica* (Pers.), deBy.).
 Ibid., p. 29.
 Drop (*Sclerotinia libertiana*, Fckl.).
 Mo. Bot. Gard. Rep. 16, p. 149 (1905).
 Leaf-spot (*Cercospora Bloxami*, B. & Br. (?)).
 Heald and Wolf, Plant Disease Survey in Texas (1912).
 Root-rot (*Corticium vagum*, Bri. & Cav., var. *Sclani*, Burt.).
 Soft-rot (*Bacillus carotovorus*, Jone.).
 Journ. Science, new ser., Vol. XVI, p. 314 (1902).
 Yellows (*Fusarium conglutinans*, Wollenw.).
 Ohio Agr. Exp. Sta., Bull. 228, p. 263 (1911).

CACAO

(Theobroma cacao, L.)

- Bark Disease (*Corticium javanicum*, Zimm. = *C. Zimmermanni*, Sacc. & Syd.).
 Diseases of Tropical Plants, pp. 180-191 (1913).

Black-rot (*Phytophthora Fabrei*, Maubl.).

Diseases of Tropical Plants, pp. 180-191 (1913).

Brown-rot (*Thyridaria tarda*, Bancroft).

Diseases of Tropical Plants, pp. 180-191 (1913).

Canker (*Nectria theobromæ*, Mass., and *Calonectria flavida*, Masee)

Diseases of Tropical Plants, pp. 180-191 (1913).

Pink Disease (*Corticium lilacofuscum*, Berk. and Curt.).

Diseases of Tropical Plants, pp. 180-191 (1913).

Root Disease (*Macrophoma vestita*, Prill & Del.).

Diseases of Tropical Plants, pp. 180-191 (1913).

Scabby-pod (*Lasiodiplodia theobromæ* (Pat.) Griff. & Maubl.).

Diseases of Tropical Plants, pp. 180-191 (1913).

Seedling Disease (*Ramularia necator*, Mass.).

Diseases of Tropical Plants, pp. 180-191 (1913).

Thread-blight (*Marasmius equicrinus*, Mull.).

Diseases of Tropical Plants, pp. 180-191 (1913).

CALLA

(*Richardia thiopica*, Spreng.)

Soft-rot (*Bacillus aroideæ*, Towns.).

Leaf-spot (*Phyllosticta Richardiæ*, Hals.).

Black-edge (*Cercospora Richardiæcola*, Atk.).

CARNATION

(*Dianthus caryophyllus*, L.)

Alternariose (*Alternaria dianthi*, Stev. & Hall).

Anthracoze (*Volutella dianthi*, Atkins).

Descr., N. J. Agr. Exp. Sta., Rep. 14, 1893, pp. 385-386 (1894).

Bud-rot (*Sporotrichum anthrophilum*, Pk.).

Nebr. Bull. 103, pp. 3-24 (Jan., 1908).

Leaf-mold or Fairy-ring (*Heterosporium cchinulatum* (Berk.), Cke.).

Descr., N. J. Agr. Exp. Sta., Rep. 14, 1893, p. 386 (1894).

Die-back (*Fusarium* sp.).

Descr. Illus., N. Y. Agr. Exp. Sta., Bull. 164, pp. 219-220 (1899).

Leaf-spot (*Septoria dianthi*, Desm. and *Heterosporium cchinulatum*).

Bull. 218, Calif. Agr. Exp. Sta. (June, 1911).

Descr., N. J. Agr. Exp. Sta., Rep. 14, 1893, pp. 384-385 (1894).

Rust (*Uromyces caryophyllinus* (Schrank), Wint.).

Descr. Illus., Gar. and For., Vol. V, pp. 18-19 (1892).

Treat., N. Y. Agr. Exp. Sta., Bull. 100, pp. 50-68 (1896).

Cf. N. Y. Agr. Exp. Sta., Bull. 175 (1900).

Wilt (*Fusarium* sp.?).

Descr., Conn. Agr. Exp. Sta., Rep. 21, 1897, pp. 175-181 (1898).

CARROT

*(Daucus carota, L.)*Root-rot (*Corticium vagum*, Bri. & Cav., var. *Solani*, Burt.).Rot (*Phoma sanguinolenta*, Grove).Soft-rot (*Bacillus carotovorus*, Jones).

Duggar, Fungous Diseases of Plants, p. 131 (1909).

CATALPA

*(Catalpa bignonioides, Walt.)*Leaf-blight (*Macrosporium catalpæ*, Ell. & Mart.).

Descr. Illus., U. S. Dep. Agr., Rep. for 1887, pp. 364-365 (1888).

Treat. (rec.), U. S. Dep. Agr., Rep. for 1887, p. 366 (1888).

Leaf-spot (*Phyllosticta catalpæ*, Ell. & Mart.).

Descr. Illus., U. S. Dep. Agr., Rep. for 1887, pp. 364-365 (1888).

Treat. (rec.), U. S. Dep. Agr., Rep. for 1887, p. 366 (1888).

Soft Heart-rot (*Polystictus versicolor* (L.), Fr.).

Stevens, Neil, Mycologia IV, p. 263 (September, 1912).

CEDAR

*(Libocedrus; Thuya; Juniperus)*Leaf-pit (*Keithia thujina*, Durand).Phytopath 6, pp. 360-363, 1916, on *T. plicata*.Red-rot or "Pecky" Disease (*Fomes carneus*, Nees).

Descr. Illus., U. S. Dep. Agr., Div. Veg. Phys. & Path., Bull. 21, pp. 16-20 (1900).

Rust	{	(<i>Gymnosporangium globosum</i> , Farl.).
		(<i>Gymnosporangium juniperi-virginianæ</i> , Schw.).
		Nebr. Rep. 1, pp. 103-127, pls. 13, map 1 (1908).
		(<i>Gymnosporangium sabinæ</i> , Plowr).

Duggar, Fungous Diseases of Plants, pp. 425-426.

White-rot (*Polyporus juniperinus*, v. Schr.).

Descr. Illus., U. S. Dep. Agr., Div. Veg. Phys. & Path., Bull. 21, pp. 7-16 (1900).

Whitening (*Cyanospora albicedræ*, Heald & Wolf).

CELERY

*(Apium graveolens, L.)*Bacteriosis (*Bacterium apii*, Brizi).

Descr. Illus., N. J. Agr. Exp. Sta., Rep. 12, 1891, pp. 257-258 (1892).

Cf. U. S. Dep. Agr., Exp. Sta. Rec., IX-9, p. 850 (1898).

Late-blight (*Septoria petroselini*, Desm., var. *apii*, Br. & Cav.).

Oregon Sta. Biennial Rep., p. 273 (1911-12).

Calif. Bull. 208, pp. 83-115, pl. 1, figs. 18 (Jan., 1911).

Leaf-blight (*Cercospora apii*, Fres.).

Descr. Illus., U. S. Dep. Agr., Rep. for 1886, pp. 117-120 (1887).

Treat. (pos.), Conn. Agr. Exp. Sta., Rep. 21, 1897, pp. 167-171 (1898).

Leaf-spot (*Phyllosticta apii*, Hals.).

Descr. Illus., N. J. Agr. Exp. Sta., Rep. 12, 1891, p. 253 (1892).

Leaf-spot (*Septoria petroselini*, Desm., var. *apii*, Bi. & Cav.).

Descr. Illus., N. Y. Agr. Exp. Sta., Bull. 51, pp. 137-138 (1893).

N. Y. (Corn. Univ.) Agr. Exp. Sta., Bull. 132, pp. 206-215 (1897).

Treat. (rec.), N. Y. Agr. Exp. Sta., Bull. 51, pp. 139-141 (1893).

Rust (*Puccinia bullata* (Pers.), Wint.).

Descr. Illus., N. J. Agr. Exp. Sta., Rep. 12, 1891, p. 256 (1892).

CENTURY PLANT

(*Agave americana*, L.)

Blight (*Stagonospora gigantea*, Heald & Wolf).

Plant Disease Survey in Texas (1912).

CHERRY

(*Prunus cerasus*, L.)

Black-knot (*Ploerwrightia morbosa* (Schw.), Sacc.).

Descr. Illus., Mass. Agr. Exp. Sta., Rep. 8, 1890, pp. 200-210 (1891).

N. J. Agr. Exp. Sta., Bul. 78, pp. 2-10 (1891).

N. Y. (Corn. Univ.) Agr. Exp. Sta., Bull. 81, pp. 638-646 (1894).

Cf. N. Y. Agr. Exp. Sta., Rep. 12, 1893, pp. 686-688 (1894).

Treat. (pos.), N. Y. (Corn. Univ.) Agr. Exp. Sta., Bull. 81, pp. 646-653 (1894).

Fruit-mold (*Sclerotinia cinerea* (Bon.), Schröt.).

Descr. Illus., U. S. Dep. Agr., Rep. for 1888, pp. 349-352 (1889).

Ky. Agr. Exp. Sta., Rep. 2, 1889, pp. 31-34 (1890).

Mass. Agr. Exp. Sta., Rep. 8, 1890, p. 213 (1891).

Treat. (pos.), N. Y. (Corn. Univ.) Agr. Exp. Sta., Bull. 98, p. 409 (1895).

Leaf-curl (*Exoascus cerasi* (Fckl.), Sadeb.).

Descr., N. Y. Agr. Exp. Sta., Rep. 14, 1895, pp. 532-533 (1896).

Leaf-spot (*Cylindrosporium padi*, Karst., = *Septoria cerasina*, Pk.).

Descr. Illus., Scribner, Fung. Dis., p. 119 (1890).

Iowa Agr. Exp. Sta., Bull. 13, pp. 61-65 (1891).

Treat. (pos.), Iowa Agr. Exp. Sta., Bull. 30, pp. 291-294 (1895).

Leaf-spot (*Cercospora cerasella*, (Aderh.); Sacc.).

Powdery Mildew (*Podosphara oxycanthæ* (DC.), deBy.).

Descr. Illus., U. S. Dep. Agr., Rep. for 1888, pp. 352-356 (1889).

Treat. (pos.), Iowa Agr. Exp. Sta., Bull. 17, pp. 421-433 (1892).

Rust (*Puccinia pruni-spinosæ*, Pers.).

Descr. Illus., U. S. Dep. Agr., Rep. for 1887, pp. 353-354 (1888).

Scab (*Cladosporium carpophilum*, Thüm.).

Twig-blight { (*Sclerotinia fructigena* (Pers.), Schröt.)
(*Sclerotinia cinerea* (Bon.), Schröt.).

CHESTNUT

(*Castanea dentata* (Marsh.), Borkh.).

Anthracnose { (*Cylindrosporium castanicolum* (Desm.), Berl.)
(*Cryptosporium epiphyllum*, C. & E.). (= *Marssonia ochroleuca*
(B. & C.), Humph.).

Treat. (pos.), Amer. Gardening, Vol. XX, p. 559 (1899).

Blight (*Endothia parasitica* (Murrill), Anders. Hall).

Diseases of Economic Plants, p. 436 (1910).

Conn. Rep., pt. 5, pp. 359-453, pls. 8 (1912).

Leaf-spot (*Marssonia ochroleuca*, (Bri. & Cav.), Humph.).

Descr. Illus., N. J. Agr. Exp. Sta., Rep. 17, 1896, p. 412 (1897).

Descr., Mass. Agr. Exp. Sta., Rep. 10, 1897, p. 69 (1898).

Sap-rot (*Polystictus versicolor* (L.) Fr.).

CHRYSANTHEMUM

(*Chrysanthemum sinense*, Sabine & *C. indicum*, L.)

Leaf-blight (*Cylindrosporium chrysanthemi*, Ell. & Dearn.).

Descr. Illus., N. J. Agr. Exp. Sta., Rep. 15, 1894, pp. 365-368 (1895).

Treat. (rec.), N. J. Agr. Exp. Sta., Rep. 15, 1894, p. 369 (1895).

Ray-blight (*Ascochyta chrysanthemi*, Stev.).

Leaf-spot (*Phyllosticta chrysanthemi*, Ell. & Dearn.).

Occ., N. J. Agr. Exp. Sta., Rep. 15, 1894, p. 368 (1895).

Leaf-spot (*Septoria chrysanthemi*, Cav.). (= *S. chrysanthemella* (Cav.), Sacc.)

Descr. Illus., N. J. Agr. Exp. Sta., Rep. 15, 1894, pp. 363-365 (1895).

Treat. (pos.), N. Y. Agr. Exp. Sta., Rep. 11, 1892, pp. 557-560 (1893).

Ray-blight (*Ascochyta chrysanthemi*, Stev.).

Rust (*Puccinia chrysanthemi*, Roze).

Occ., N. J. Agr. Exp. Sta., Circ., Nov. 15 (1899).

Descr., Treat. (rec.), Ind. Agr. Exp. Sta., Bull. 85 (1900).

Cf. Gardening, Vol. VI, p. 277, '98.

CHIVES

(*Allium schænoprasum*, L.)

Rust (*Puccinia porri* (Sow.), Wint.).

Conn. Exp. Sta., Rep., 1909-1910, p. 726.

CLEMATIS

*(Clematis spp.)*Anthraxnose (*Glæosporium clematidis*, Sor.).Leaf-spot (*Ascochyta clematidina*, Thüm).

Journ. Agr. Research 4, pp. 331-342 (1915).

Root-rot (*Phoma* sp.)

Descr., N. Y. Agr. Exp. Sta., Rep. 3, 1884, pp. 383-384 (1885).

CLOVER

*(Trifolium spp.)*Anthraxnose (*Colletotrichum trifolii*, Bain).Damping-off (*Pythium de Baryanum*, Hesse).Leaf-spot (*Pseudopeziza trifolii* (Pers.), Fckl.).Leaf-spot (*Phyllachora trifolii* (P.), Fckl.).

Descr., N. J. Agr. Exp. Sta., Rep. 18, 1897, p. 319 (1898).

Rust (*Uromyces Trifolii* (Hedw. f.), Lev. and *U. fallens* (Desm.), Kern).

Descr. Illus., N. Y. (Corn. Univ.) Agr. Exp. Sta., Bull. 24 (1890).

Iowa Agr. Exp. Sta., Bull. 13, pp. 51-55 (1891).

Phytopath. 1, pp. 3-6 (February, 1911).

Treat. (rec.), N. Y. (Corn. Univ.) Agr. Exp. Sta., Bull. 24, p. 139 (1890).

Sooty spot (*Polythrincium trifolii*, Kze.).Stem-rot (*Sclerotinia trifoliorum*, Eriks.).

Descr. Illus., Del. Agr. Exp. Sta., Rep. 3, 1890, pp. 84-88 (1891).

N. J. Agr. Exp. Sta., Rep. 18, 1897, pp. 314-318 (1898).

Treat. (rec.), Del. Agr. Exp. Sta., Rep. 6, 1893, p. 110 (1894).

COCKLEBUR

*(Xanthium spp.)*Rust (*Puccinia xanthii*, Schw.).

COCONUT

*(Cocos nucifera)*Bud-rot (*Bacillus coli*, (Esch.) Mig.).

Johnston, John R., The History and Cause of the Coconut Bud Rot, U. S. Bureau of Plant Industry, Bull. 228 (1912).

Godaveri Disease (*Pythium palmivorum*, Butler).

Cook, Diseases of Tropical Plants, pp. 197-206 (1913).

Leaf Disease (*Pestalozzia palmarum*, Cooke.)

Cook, Diseases of Tropical Plants, pp. 197-206 (1913).

Stem-bleeding (*Thielaviopsis ethacetica*, Went.).

Cook, Diseases of Tropical Plants, pp. 197-206 (1913).

COFFEE

(Coffea arabica.)

- Foot Disease (*Euryachora liberica*, Oud.).
 Cook, Diseases of Tropical Plants, pp. 160-170 (1913).
 Porto Rico Bull. 17, pp. 29 (Feb., 1915).
- Leaf-rot (*Pellicularia koleroga*, Cke).
 Cook, Diseases of Tropical Plants, pp. 160-170 (1913).
 Porto Rico Bull. 17, pp. 29 (Feb., 1915).
- Leaf-spot (*Cercospora coffeicola*, Bri. & Cav.).
 Cook, Diseases of Tropical Plants, pp. 160-170 (1913).
 Porto Rico Bull. 17, pp. 29 (Feb., 1915).
- Mancha de Hierro (*Sphaerostilbe flavida*, Massee).
 Cook, Diseases of Tropical Plants, pp. 160-170 (1913).
 Porto Rico Bull. 17, pp. 29 (Feb., 1915).
- Root Disease (*Irpex flavus*, Klotsch).
 Cook, Diseases of Tropical Plants, pp. 160-170 (1913).
 Porto Rico Bull. 17, pp. 29 (Feb., 1915).
- Rust (*Hemileia vastatrix*, Berk. & Broome).
 Cook, Diseases of Tropical Plants, pp. 160-170 (1913).
 Porto Rico Bull. 17, pp. (Feb. 29, 1915).
- Stem Disease (*Necator decretus*, Mass.).
 Cook, Diseases of Tropical Plants, pp. 160-170 (1913).
 Porto Rico Bull. 17, pp. 29 (Feb., 1915).

CORN

(Zea mays, L.)

- Downy Mildew (*Sclerospora macrospora*, Sacc.).
- Leaf-blight (*Helminthosporium inconspicuum*, C. & E.).
 Descr. Illus., N. Y. Agr. Exp. Sta., Rep. 15, 1896, p. 452 (1897).
- Dry-rot (*Diplodia zeae* (Schw.), Lév. = *D. maydis* (Berk. Sacc.).
 Stevens & Hall, Diseases of Economic Plants, p. 335 (1910).
 Ill. Bull. 133, pp. 73-85, 92-100, pl. 1, figs. 20 (Feb., 1909).
- Rust (*Puccinia sorghi*, Schw. = *P. maydis* Bereng.)
 Descr. Illus., U. S. Dep. Agr., Rep. for 1887, p. 390 (1888).
 Cf. U. S. Dep. Agr., Div. Veg. Phys. & Path., Bull. 16, p. 65 (1899).
- Smut (*Ustilago zeae* (Beckm.), Unger) and (*U. Reiliana*, Kühn).
 Descr. Illus., Kans. Agr. Exp. Sta., Bull. 62, pp. 179-189 & 198-201 (1896).
 Ind. Agr. Exp. Sta., Rep. 12, pp. 99-112 (1900).
 Treat. (rec.), Ill. Agr. Exp. Sta., Bull. 57, p. 335 (1900).
- Wilt (*Pseudomonas Stewarti*, E. F. Sm.).
 Descr. Illus., N. Y. Agr. Exp. Sta., Bull. 130, pp. 423-438 (1897).
 Treat. (rec.), N. Y. Agr. Exp. Sta., Bull. 130, pp. 438-439 (1897).

COSMOS

*(Cosmos bipinnatus, Cav.)*Stem-spot (*Phlyctæna* sp.).

Descr. Illus., N. J. Agr. Exp. Sta., Rep. 15, 1894, pp. 371-372 (1895).

COTTON

*(Gossypium spp.)*Angular Leaf-spot (*Bacterium malvacearum*, E. F. Sm.).Anthracnose (*Colletotrichum gossypii*, Southworth).

Descr. Illus., Ala. Agr. Exp. Sta., Bull. 41, pp. 40-49 (1892).

U. S. Dep. Agr., Office Exp. Sta's, Bull. 33, pp. 293-299 (1896).

Ala. Bull. 153, pp. 27-33 (Feb., 1911).

Boll-rot (*Bacillus gossypina*, Stedm.).

Descr. Illus., Ala. Agr. Exp. Sta., Bull. 55 (1894).

Treat. (rec.), Ala. Agr. Exp. Sta., Bull. 107, p. 313 (1900).

Damping-off (*Corticium vagum*, B. & C., var. *Solani*, Burt.).

Descr., Ala. Agr. Exp. Sta., Bull. 41, pp. 30-39 (1892).

Cf. Ala. Agr. Exp. Sta., Bull. 107, pp. 295-296 (1900).

Descr. Illus., U. S. Dep. Agr., Rep. for 1887, pp. 355-356 (1888).

Ala. Agr. Exp. Sta., Bull. 41, pp. 58-61 (1892).

Leaf-mold (*Ramularia areola*, Atk.).

Descr. Illus., Ala. Agr. Exp. Sta., Bull. 41, pp. 55-58 (1892).

Root-rot (*Ozonium omnivorum*, Shear).

Descr. Illus., Tex. Agr. Exp. Sta., Rep. 2, 1889, pp. 67-76 (1890).

U. S. Dep. Agr., Office Exp. Sta's, Bull. 33, p. 300 (1896).

Treat. (rec.), U. S. Dep. Agr., Office Exp. Sta's, Bull. 33, p. 304 (1896).

Rust (*Uredo gossypii*, Lagerh.) and (*Æcidium gossypii*, Ell. & Ev.).

Descr., Journ. Mycol., Vol. VII, pp. 47-48 (1891).

Texas Root-rot (*Ozonium omnivorum*, Shear).Smut (*Doassansia gossypii*, Lagerh.).

Descr., Journ. Mycol., Vol. VII, pp. 48-49 (1891).

Wilt (*Neocosmospora vasinfecta* (Atk.), Smith).

Descr. Illus., Ala. Agr. Exp. Sta., Bull. 41, pp. 19-29 (1892).

U. S. Dep. Agr., Div. Veg. Phys. & Path., Bull. 17 (1899).

COW PEA

*(Vigna catjang)*Angular Leaf-spot (*Cercospora cruenta*, Sacc.).

Stevens and Hall, Diseases of Economic Plants, p. 395 (1910).

Leaf-spot (*Amerosporium æconomicum*, Ell. & Tracy).

Stevens & Hall, p. 394 (1910).

- Rust (*Uromyces appendiculatus* (P.), Lk.).
 Wilt (*Neocosmospora vasinfecta* (Atk.), E. F. Sm.).

CRANBERRY

(*Vaccinium oxycoccus*, L.)

- Anthraxnose (*Glomerella rufomaculans* (Berk.) Sp. & v. Schr. var. *vaccinii*, Shear).
 Gall (*Synchytrium Vaccinii*, Thomas).
 Descr. Illus., N. J. Agr. Exp. Sta., Bull. 64, pp. 4-9 (1889).
 Treat. (rec.), N. J. Agr. Exp. Sta., Rep. 11, 1890, p. 333 (1891).
 Hypertrophy (*Exobasidium oxycocci*, Rost = *Ex. vaccinii* (Fckl.) Wor.).
 Rot (*Acanthorhynchus vaccinii*, Shear).
 Shear, C. L., Bull. 10, U. S. Bur. Plant Industry.
 "Scald" (*Guignardia vaccinii*, Shear).
 Descr. Illus., N. J. Agr. Exp. Sta., Bull. 64, pp. 30-34 (1889).
 Treat. (rec.), N. J. Agr. Exp. Sta., Bull. 64, pp. 39-40 (1889).
 Sclerotial Disease (*Sclerotinia oxycocci*, Wor.).
 Spot (*Pestalozzia Guepini*, Desm., var. *vaccinii*, Shear).

CUCUMBER

(*Cucumis sativus*, L.)

- Anthraxnose (*Colletotrichum lagenarium* (Pass.), Ell. & Hals.).
 Descr. Illus., Ohio Agr. Exp. Sta., Bull. 89, pp. 109-110 (1897).
 Treat. (pos.), N. J. Agr. Exp. Sta., Rep. 17, 1896, pp. 340-343 (1897).
 W. Va. Bull. 94, pp. 127-138, pls. 5 (Dec. 2, 1904).
 Bacteriosis or Wilt (*Bacillus tracheiphilus*, E. F. Sm.).
 "Damping-off" or Seedling-Mildew (*Pythium de Baryanum*, Hesse).
 Descr. Illus., Mass. Agr. Exp. Sta., Rep. 8, 1890, p. 220 (1891).
 Treat. (rec.), Mass. Agr. Exp. Sta., Rep. 8, 1890, p. 221 (1891).
 Downy Mildew (*Plasmopara cubensis* (Bri. & Cav.), Humphrey).
 Descr. Illus., N. Y. Agr. Exp. Sta., Bull. 119, pp. 158-165 (1897).
 Ohio Agr. Exp. Sta., Bull. 89, pp. 103-108 (1897).
 Cf. Ohio Agr. Exp. Sta., Bull. 105, pp. 219-220 (1899).
 Treat. (pos.), Ohio Agr. Exp. Sta., Bull. 105, pp. 223-229 (1899).
 Leaf-glaze (*Acremonium* sp.).
 Descr., Mass. Agr. Exp. Sta., Rep. 9, 1891, p. 227 (1892).
 Illus., Mass. Agr. Exp. Sta., Rep. 10, 1892, p. 230 (1893).
 Leaf-spot (*Phyllosticta cucurbitacearum*, Sacc.).
 Occ., Ohio Agr. Exp. Sta., Bull. 105, p. 222 (1899).
 Powdery Mildew (*Erysiphe polygoni*, DC.).
 Descr. Illus., Mass. Agr. Exp. Sta., Rep. 10, 1892, p. 225 (1893).
 Treat. (pos.), N. Y. (Corn. Univ.) Agr. Exp. Sta., Bull. 31, p. 138 (1891).
 Mass. Agr. Exp. Sta., Rep. 9, 1891, p. 225 (1892).

Scab (*Cladosporium cucumerinum*, Ell. & Arth.).

Descr. Illus., Ind. Agr. Exp. Sta., Bull. 19, pp. 8-10 (1889).

Mass. Agr. Exp. Sta., Rep. 10, 1892, pp. 227-229 (1893).

Stem-rot (*Sclerotinia libertiana*, Fckl.).

Descr. Illus., Mass. Agr. Exp. Sta., Rep. 10, 1892, pp. 212-224 (1893).

Treat. (rec.), Mass. Agr. Exp. Sta., Rep. 10, 1892, p. 222 (1893).

CURRENT

(*Ribes*, spp.)

Anthraxnose (*Glaosporium ribis* (Lib.), Mont. & Desm.).

Descr. Illus., N. Y. (Corn. Univ.) Agr. Exp. Sta., Bull. 15, p. 196 (1889).

Cane-wilt (*Dothiorella*).

Descr., N. Y. Agr. Exp. Sta., Bull. 167, pp. 292-294 (1899).

Cane-blight (*Nectria cinnabarina* (Tode), Fr.).

Descr. Illus., N. Y. (Corn. Univ.) Agr. Exp. Sta., Bull. 125 (1897).

Treat. (rec.), N. Y. (Corn. Univ.) Agr. Exp. Sta., Bull. 125, p. 38 (1897).

Knot (*Pleconectria berlinensis*, Sacc.).

Cornell Agr. Exp. Sta., Bull. 125 (February, 1897).

Leaf-spot (*Septoria ribis*, Desm., and *Cercospora angulata*, Wint.).

Descr. Illus., Iowa Agr. Exp. Sta., Bull. 13, pp. 68-69 (1891).

Treat. (pos.), Iowa Agr. Exp. Sta., Bull. 30, pp. 289-291 (1895).

Powdery Mildew (*Sphaerotheca mors-uvæ* (Schw.), Bri. & Cav.).

Rust (*Puccinia Ribis*, DC.).

See U. S. Dep. Agr., Exp. Sta. Rec., X-6, p. 559 (1899).

Wilt (*Botryosphaeria ribis*, Gross. & Dug.).

N. Y. Techn. Bull. 18, pp. 113-190, pls. 2, fig. 1 (July, 1911).

(*Cronartium ribicola*, Diet.), representing the uredo- and teleuto-stages of the white pine blister rust, *Peridermium strobi*, Kleb, a serious disease of white pines against which a strict quarantine is maintained.

N. Y. State Techn. Bull. 2, pp. 61-74, pls. 3 (1906).

CYCLAMEN

Dark Leaf-spot (*Phoma cyclamenæ*, Halst.).

Watery Leaf-spot (*Glomerella rufomaculans* (Berk.), Spauld. & v. Schr., var. *cyclaminis*, Patt. & Ch.).

CYPRESS

(*Taxodium distichum* (L.), Rich.)

Leaf-blight (*Pestalozzia funerca*, Desm.).

"Pecky" Disease (*Fungus indet.*).

DANDELION

*(Taraxacum officinale, Web.)*Leaf-spot (*Ramularia taraxaci* Karst.).

Conn. Agr. Exp. Sta., Rep., p. 862 (1907-08).

EGG-PLANT

*(Solanum melongena, L.)*Anthracnose (*Glaosporium melongenæ*, Ell. & Hals.).

Occ., N. J. Agr. Exp. Sta., Rep. 12, 1891, p. 281 (1892).

Cf. N. J. Agr. Exp. Sta., Rep. 13, pp. 330-333 (1892).

Blight (*Pseudomonas solanacearum*, E. F. Sm.).

Descr. Illus., U. S. Dep. Agr., Div. Veg. Phys. & Path., Bull. 12 (1896).

Treat. (rec.), U. S. Dep. Agr., Div. Veg. Phys. & Path., Bull. 12, pp. 23-24 (1896).

"Damping-off," or "Seedling-mildew" (*Pythium de Baryanum*, Hesse).

Descr., N. J. Agr. Exp. Sta., Rep. 13, 1892, p. 286 (1893).

Fruit-mold, Gray Mold (*Botrytis fascicularis* (Cord.), Sacc.).

Descr., N. J. Agr. Exp. Sta., Rep. 11, 1890, p. 357 (1891).

Leaf-spot *Phomopsis vexans* (Sacc. & Wint.), Hart. = *Ascochyta hortorum* (Speg.),

C. O. Smith, a fruit rot).

Journ. Agr. Research II, pp. 331-338, pls. 5 (1914).

Descr. Illus., N. J. Agr. Exp. Sta., Rep. 11, 1890, pp. 355-357 (1891).

Del. Bull. 70, pp. 10-15, pl. 1, figs. 2 (March, 1905).

Treat. (pos.), N. J. Agr. Exp. Sta., Rep. 17, 1896, pp. 337-340 (1897).

Rot (*Penicillium* sp.).

Descr. Illus., N. J. Agr. Exp. Sta., Rep. 14, 1893, pp. 362-366 (1894).

Seedling-rot (*Phomopsis vexans*, Sacc. & Syd., Hart.).

Descr. Illus., N. J. Agr. Exp. Sta., Rep. 12, 1891, pp. 277-279 (1892).

Treat. (rec.), N. J. Agr. Exp. Sta., Rep. 12, 1891, p. 279 (1892).

Stem-rot (*Nectria ipomææ*, Hals.).

Descr. Illus., N. J. Agr. Exp. Sta., Rep. 12, 1891, pp. 281-283 (1892).

ELDER

*(Sambucus canadensis, L.)*Rust (*Aecidium sambuci*, Sacc.).Leaf-spot (*Cercospora catenospora*, Atk.).

ELM

*(Ulmus spp.)*Black-spot (*Dothidella ulmi* (Duv.), Wint.) and (*Gnomonia ulmea* (Sacc.), Thüm)Blister-canker (*Nummularia discreta*, (Schw.) Tul.).

Duggar, p. 282 (1909).

- Leaf-scab (*Gnomonia ulmca* (Sacc.), Thüm.).
 White-rot (*Polyporus squamosus* (Huds.), Fr.).
 Duggar, p. 453 (1909).

ENGLISH IVY

(*Hedera helix*, L.)

- Anthraxnose (*Colletotrichum glæosporioides*, Penz, var. *hederae*, Pass.).
 Leaf-blight (*Phyllosticta concentrica*, Sacc.).
 Leaf-spot (*Ramularia hedericola*, Heald & Wolf).

EVENING PRIMROSE

(*Oenothera biennis*, L.).

- Gall, or Chytridiose (*Synchytrium fulgens*, Schröt.).
 Duggar, p. 139 (1909).

FIG

(*Ficus carica*, L.)

- Anthraxnose (*Glomerella rufomaculans* (Berk.) Spauld & von Schr. = *G. fructigena* (Clint.), Sacc.).
 Canker (*Tubercularia fici*, Edgerton).
 Cook, Diseases of Tropical Plants, p. 139 (1913).
 Phytopath. 1, pp. 12-17 (February, 1911).
 Die-back (*Diplodia sycina*, Mont., var. *syconophila*, Sacc.).
 Fruit-rot (*Glomerella rufomaculans* (Berk. Spauld. & von Schr.).
 Leaf-blight (*Cercospora Bolleana* (Thüm.), Sacc.).
 Occ., U. S. Dep. Agr., Div. Pomol., Bull. 5, pp. 27-28 (1897)
 Leaf-spot (*Cercospora fici*, H. & W.).
 Limb-blight (*Corticium lætum*, Karst.).
 Rust (*Uredo fici*, Cast. = *Physopella fici* (Cast.), Arth.).
 Occ., N. C. Agr. Exp. Sta., Bull. 92, p. 117 (1893).
 Scab (*Fusarium roseum*, Lk.).
 Occ., N. C. Agr. Exp. Sta., Bull. 92, p. 117 (1893).
 Soft-rot (*Rhizopus nigricans* Ehrenb.).
 La. Agr. Exp. Sta., Bull. 126 (March, 1911).

FILBERT

(*Corylus avellana*, L. and *C. americana*, Walt.)

- Black-knot (*Cryptosporrella anomala* (Pk.), Sacc.).
 Descr., N. J. Agr. Exp. Sta., Rep. 13, 1892, pp. 287-289 (1893).

FIR

(Abies balsamea (L.), Miller)

- Dry-rot (*Trametes pini* (Brot.), Fr.) }
 Root-rot (*Polyporus Schweinitzii*, Fr.) } Descr. Illus., U. S. Dept. Agr., Div. Veg.
 Wet-rot (*Polyporus subucidus*, Pk.?) } Phys. & Path., Bull. 25 (1900).
 Rust (*Aecidium elatinum*, Alb. & Schw.)

FLAX

(Linum spp.)

- Rust (*Melampsora lini* (DC.), Tul.).
 Occ., Journ. Mycol., Vol. V, p. 215 (1889).
 Wilt (*Fusarium lini*, Bolley).
 Stevens & Hall, Diseases of Economic Plants, p. 406 (1910).
 N. Dak. Bull. 50, December, 1901, pp. 27-60, figs. 18.

GERANIUM

(Pelargonium spp.)

- Leaf-spot (*Bacteria?*).
 Descr., Mass. Agr. Exp. Sta., Rep. 12, 1899, p. 57 (1900).
 Rot (*Bacillus* sp.).
 Descr. Illus., Journ. Mycol., Vol. VI, pp. 114-115 (1891).

GINSENG

*(Panax quinquefolium, L.)*¹

- Anthraxnose (*Vermicularia dematium* (Pers.), Fr.).
 Blight (*Alternaria panax*, Whetzl.).
 Leaf Anthracnose (*Pestozozia funcrea*, Desm.).
 Wilt (*Neocosmopara vasinfectum* (Atk.) E. F. Sm. var. *nivea* (Atk.) E. F. Sm.).
 Mo. Bull. 69 (October, 1905).

GLADIOLUS

- Hard-rot (*Septoria gladioli*, Passer).
 Phytopathology 6 (Columbus Meeting Abstracts).

GOLDENROD

(Solidago spp.)

- Red-rust (*Coleosporium solidaginis* (Schw.), Thüm).
 Rust *Uromyces solidaginis* (Somm.), Niessl.

¹ See WHETZEL, H. H.: The Diseases of Ginseng and Their Control, U. S. Bur. of Plant Industry, Bull. 250 (1912).

GOOSEBERRY

(Ribes grossularia, L.)

- Leaf-spot (*Septoria ribis*, Desm., and *Cercospora angulata*, Wint.).
 Leaf-spot (*Sphaerella grossulariæ* (Fr.), Awd.?).
 Occ. Illus., Iowa Agr. Exp. Sta., Bull. 13, p. 70 (1891).
 Powdery Mildew (*Sphaerotheca mors-uvæ* (Schw.), Bri. & Cav.).
 Descr. Illus., U. S. Dep. Agr., Rep. for 1887, pp. 373-378 (1888).
 Mass. Agr. Exp. Sta., Rep. 10, 1892, p. 240 (1893).
 Treat. (pos.), N. Y. Agr. Exp. Sta., Bull. 161 (1899).
 Root-rot (*Dematophora* sp.?).
 Descr., N. Y. Agr. Exp. Sta., Bull. 167, pp. 295-296 (1899).
 Rust (*Aecidium grossulariæ*, Schum.).
 Descr., Mass. Agr. Exp. Sta., Rep. 10, 1892, p. 241 (1893).
 Treat. (rec.), Mass. Agr. Exp. Sta., Rep. 10, 1892, p. 241 (1893).

GRAPE

(Vitis spp.)

- Anthracnose (*Sphaceloma ampelinum*, deBy. = *Glocosporium ampelophagum* (Pass.) Sacc.).
 Descr. Illus., Tenn. Agr. Exp. Sta., Bull. IV-4, pp. 111-112 (1891).
 Descr., U. S. Dep. Agr., Div. Veg. Path., Bull. 2, pp. 170-172 (1892).
 Shear, C. L. Grape Anthracnose in America. Rep. Int. Congr. Viticulture, San Francisco, July 11-13, 1915: 111-117.
 Treat. (rec.), N. Y. (Corn. Univ.) Agr. Exp. Sta., Bull. 76, p. 443 (1894).
 Hawkins, Lon A. Circ. 105, Bureau Pl. Industry, 1913.
 Bacteriosis (*Bacillus* sp.).
 See U. S. Dep. Agr., Exp. Sta. Rec., VI-3, pp. 231-232.
 Bitter-rot (*Melanconium fuliginum* (Scrib. & Viala.), Cav.).
 Descr. Illus., U. S. Dep. Agr., Rep. for 1887, pp. 324-325 (1888).
 Scribner, Fung. Dis., pp. 37-40 (1890).
 Cf. N. Y. (Corn. Univ.) Agr. Exp. Sta., Bull. 61, pp. 302-305.
 Black-rot (*Gnignardia (Laesiadia) Bidwellii* (Ell.), Viola. & Rav. and *G. baccæ* (Cav.), Jacq.).
 Descr. Illus., U. S. Dep. Agr., Rep. for 1886, pp. 109-111 (1887).
 Del. Agr. Exp. Sta., Bull. 6, pp. 18-27 (1889).
 Tenn. Agr. Exp. Sta., Bull. IV-4, pp. 97-102 (1891).
 Tex. Agr. Exp. Sta., Bull. 23, pp. 219-228 (1892).
 Penna. Bull. 66, pp. 1-16, pls. 2, map. 1 (Jan., 1904).
 N. Y. Cornell Bull. 293, pp. 289-364, pls. 5 (March, 1911).
 Treat. (pos.), Conn. Agr. Exp. Sta., Rép. 14, 1890, pp. 100-101 (1891).
 U. S. Dep. Agr., Farm. Bull. 4, pp. 8-9 (1891).
 Tex. Agr. Exp. Sta., Bull. 23, pp. 228-231 (1892).

Chytridiose (*Cladochytrium viticolum*, Prunet.).

See U. S. Dep. Agr., Exp. Sta. Rec., VI-7, pp. 642-644 (1895).

Dead-arm (*Cryptosporidella viticola*, Shear.).

Circ. 55, N. J. Agr. Exp. Sta.

N. Y. State Bull. 389, pp. 463-490 (July, 1914).

Phytopath. 1, pp. 116-119 (1911).

Downy Mildew (*Plasmopara viticola* (B. & C.), Berl. & De Ton.).

Descr. Illus., U. S. Dep. Agr., Rep. for 1886, pp. 96-99 (1887).

Tenn. Agr. Exp. Sta., Bull. IV-4, p. 108 (1891).

Mich. Agr. Exp. Sta., Bull. 83, pp. 9-12 (1892).

Phytopath. 2, pp. 235-249 (1912).

Treat. (pos.), U. S. Dep. Agr., Farm. Bull. 4, p. 8 (1891).

Fruit-mold (*Botrytis* sp.).

Leaf-blight *Isariopsis clavispora* (B. & C.) Sacc.

Descr. Illus., Scribner, Fung. Dis., pp. 60-62 (1890).

N. Y. Agr. Exp. Sta., Rep. 9, 1890, p. 324 (1891).

Cornell Bull. 76, November, 1894.

Treat. (rec.), N. C. Agr. Exp. Sta., Bull. 92, p. 122 (1893).

Leaf-mold (*Leptosporium heterosporum*, Ell. & Gall.).

Descr. Illus., U. S. Dep. Agr., Rep. for 1888, pp. 381-383 (1889).

Leaf-spot (*Isariopsis clavispora*, Sacc.).

N. J. Exp. Sta., Rep., p. 474 (1914).

Powdery Mildew (*Uncinula necator* (Schw.), Burr.).

Descr. Illus., U. S. Dep. Agr., Rep. for 1886, pp. 105-108 (1887).

N. Y. Agr. Exp. Sta., Rep. 9, 1890, pp. 322-323 (1891).

U. S. Dep. Agr., Div. Veg. Path., Bull. 2, pp. 166-170 (1892).

Treat. (pos.), U. S. Dep. Agr., Farm. Bull. 4, p. 8 (1891).

N. C. Agr. Exp. Sta., Bull. 92, pp. 120-121 (1893).

Ripe-rot or Anthracnose (*Glæosporium fructigenum*, Berk.).

Descr. Illus., U. S. Dep. Agr., Rep. for 1890, p. 408 (1891).

Journ. Mycol., Vol. VI, pp. 164-171 (1891).

Root-rot (*Dematophora necatrix*, Hartig).

Descr. Illus., Scribner, Fung. Dis., pp. 64-69 (1890).

U. S. Dep. Agr., Div. Veg. Path., Bull. 2, pp. 153-159 (1892).

Treat. N. C. Agr. Exp. Sta., Bull. 92, p. 122 (1893).

Root-rot (*Armillaria mellea*, Vahl.).

Stevens & Hall, Diseases of Economic Plants, p. 173 (1910).

Scab (*Cladosporium viticolum*, Ces. = *Cercospora viticola* (Ces.) Sacc.)

Descr., U. S. Dep. Agr., Div. Veg. Path., Bull. 2, pp. 173-174 (1892).

Scald (*Aurcibasidium vitis*, Viala & Boyer).

See U. S. Dep. Agr., Exp. Sta. Rec., VI-3, pp. 230-231 (1894).

Twig-blight (*Botrytis cinerea*, Pers.).

White-rot (*Charrinia diplodiella*, Viala & Rav.; Syn. *Coniothyrium diplodiella* (Speg.) Sacc.).

Descr. Illus., U. S. Dep. Agr., Rep. for 1887, pp. 325-326 (1888).

Scribner, Fung. Dis., pp. 41-44 (1890).

Treat. (pos.), U. S. Dep. Agr., Sec. Veg. Path., Bull. 11, p. 69 (1890).

GUAVA

*(Psidium guajava, L.)*Ripe-rot (*Glomerella psidii* (G. Del.) Sheldon).

Stevens & Hall, Diseases of Economic Plants, p. 191 (1910).

W. Va. Bull. 104, pp. 299-315 (April, 1906).

HACKBERRY

*(Celtis spp.)*Leaf-spot (*Cylindrosporium defoliatum*, Heald and Wolf and (*Ramularia cellidis*, Ell. & Kell.).Powdery Mildew (*Uncinula polychæta*, Bri. and Cav.).

HAZEL

*(Corylus spp.)*Black-knot (*Cryptosporella anomala* (Pk.), Sacc.).

Descr. Illus., Mass. Agr. Exp. Sta., Rep. 10, 1892, p. 242 (1893).

Treat. (rec.), Mass. Agr. Exp. Sta., Rep. 10, 1892, p. 243 (1893).

HEMLOCK

*(Tsuga canadensis (L.), Carr.)*Dry-rot (*Trameles pini* (Brot.), Fr.).

Descr. Illus., U. S. Dep. Agr., Div. Veg. Phys. & Path., Bull. 25 (1900).

Heart-rot (*Polyporus borealis* (Wahl.), Fr.).

Bull. 193 Corn. Univ. Agr. Exp. Sta. (June, 1901).

Timber Rot (*Fomes pinicola*, Fr.).

Graves, A. H., Phytopath. 4, p. 69 (April, 1914).

Wet-rot (*Polyporus subacidus*, Pk. ?).

Descr. Illus., U. S. Dep. Agr., Div. Veg. Phys. & Path., Bull. 25 (1900).

Rust (*Peridermium Peckii*, Thüm.).

Phytopath. 1, pp. 94-96 (1911).

HEMP

*(Cannabis sativa, L.)*Leaf-wilt (*Botryosphaeria Marconii* (Cav.), Charles & Jenkins).

Journ. of Agr. Research 3, pp. 81-84 (Oct. 15, 1914).

HICKORY

*(Carya spp.)*Leaf-spot (*Marsonia juglandis* (Lib.), Sacc.).

HOLLYHOCK

*(Althæa rosea, Cav.)*Anthracnose (*Colletotrichum malvarum* (Braun. & Casp.), Southworth).

Descr. Illus., Journ. Mycol., Vol. VI, pp. 46-48 (1890).

Treat. (pos.), Journ. Mycol., Vol. VI, p. 50 (1890).

N. J. Agr. Exp. Sta., Rep. 11, 1890, p. 362 (1891).

Leaf-blight (*Cercospora althæina*, Sacc.).

Descr., N. J. Agr. Exp. Sta., Rep. 11, 1890, p. 361 (1891).

Treat. (pos.), N. J. Agr. Exp. Sta., Rep. 11, 1890, p. 361 (1891).

Leaf-Spot (*Phyllosticta althæina*, Sacc.).¹

Descr., N. J. Agr. Exp. Sta., Rep. 12, 1891, p. 297 (1892).

Rust (*Puccinia malvacearum*, Mont.).

Descr. Illus., N. Y. (Corn. Univ.) Agr. Exp. Sta., Bull. 25, p. 154 (1890).

Phytopath. 1, pp. 53-62 (1911).

Treat. (rec.), N. Y. (Corn. Univ.) Agr. Exp. Sta., Bull. 25, p. 155 (1890).

Rust (*Puccinia heterogenca*, Lagerh.).

Descr. Illus., Journ. Mycol., Vol. VII, pp. 44-47 (1891).

HOP

*(Humulus japonicus, Sieb & Zucc.)*Powdery Mildew (*Spherotheca humuli* (DC.), Burr.).

N. Y. Corn. Bull. 328, pp. 281-310, figs. 19 (March, 1913).

N. Y. State Bull. 395, pp. 29-80, pls. 2, figs. 2 (February, 1915).

HORSE-CHESTNUT

*(Æsculus hippocastanum, L.)*Leaf-blotch (*Guignardia æsculi* (Pk.) Stewart). Phytopath. 6, 5-19, 1916.Leaf-spot (*Phyllosticta paviæ*, Desm.).

Descr., N. Y. Agr. Exp. Sta., Rep. 15, 1896, p. 456 (1897).

Tr. (pos.), Journ. Mycol. Vol. VII, p. 353; Phytopathology 4, 399 (December, 1914)

HORSERADISH

*(Cochlearia armoraciæ, L.)*Leaf-blight (*Ramularia armoraciæ*, Fckl.).

Occ., N. J. Agr. Exp. Sta., Rep. 11, 1890, p. 360 (1891).

Leaf-mold (*Macrosporium herculcum*, Ell. & Mart.).

Occ., N. Y. Agr. Exp. Sta., Rep. 15, 1896, p. 452 (1897).

¹ The different species of *Phyllosticta* will be found described in The North American *Phyllostictas* with Descriptions of the Species, published up to August, 1900 by J. B. Ellis and B. M. Everhart, Vineland, N. J., December, 1900.

Leaf-spot (*Septoria armoraciæ*, Sacc.).

Descr., N. J. Agr. Exp. Sta., Rep. 11, 1890, p. 360 (1891).

HUCKLEBERRY

• (*Gaylussacia* sp.)

Gall (*Exobasidium vaccinii* (Fckl.) Wor.).

HYACINTH

(*Hyacinthus orientalis*, L.)

Yellow Disease (*Pseudomonas hyacinthi* (Wakk.) E. F. Sm.).

HYDRANGEA

(*Hydrangea hortensia*, Siebold)

Leaf-spot (*Phyllosticta hydrangeæ*, Ell. & Ev.).

Occ., N. J. Agr. Exp. Sta., Rep. 12, 1891, p. 298 (1892).

Rust (*Melampsora Hydrangeæ* = *Thecopsora hydrangeæ* B. & C.) Magn.

INCENSE CEDAR

(*Libocedrus decurrens*, Torr.)

Dry-rot (*Polyporus amarus*, Hedgcock).

Rust (*Gymnosporangium Blasdaleanum* (Diet. & Holw.) Kern).

Meinecke, E. A., Forest Tree Diseases Common in California and Nevada, 1914.

IRIS

(*Iris* spp.)

Bulb-spot (*Mystrosporium adustum*, Mass.).

Leaf-blight (*Botrytis galanthina*, (B. & Br.) Sacc.).

JOHNSON GRASS

(*Andropogon halepensis* (L.), Brot.).

Leaf-blight (*Helminthosporium turcicum* Pass. and *Septoria pertusa* Heald & Wolf).

Leaf-spot (*Cercospora sorghi* (Ell. & Ev.) and *Colletotrichum lineola* Cda var. *halepense*, Heald & Wolf).

Rust (*Puccinia purpurea*, Cke.).

KAFFIR CORN

(*Sorghum vulgare*, Pers.)

Grain Smut (*Sphaclotrocha sorghi* Lk.) Clint.

Clint Conn., Exp. Sta. Rep., p. 351 (1912).

LARCH

(*Larix laricina* (DR.) Koch)Canker (*Dasyscypha Willkommii*, Hartig).Dry-rot (*Trametes pini* (Brot.) Fr.).

Descr. Illus., U. S. Dep. Agr., Div. Veg. Phys. & Path., Bull. 25, pp. 31-40 (1900).

LAUREL

(*Kalmia latifolia*, L.)Leaf-spot (*Septoria kalmicola* (Schw.) Bri. & Cav.).

LEMON

(*Citrus medica*, L. var. *limon*, L.)Black pit (*Bacillus citriputeale* spp.)

Coit, Citrus Fruits, p. 401, 1915; Phytopath. 3, pp. 277-281 (1913).

Brown-rot (*Pythiacystis citrophthora*, R. E. Smith).

Calif. Bull. 190, pp. 1-72, pl. 1, figs. 30 (July, 1907).

Foot-rot (*Fusisporium limonis*, Bri.).Cotton-rot (*Sclerotinia libertiana*, Fuckl.). Phytopath. 6, pp. 268-278 (1916).Fruit-spot (*Trichoseptoria alpei*, Cav.).Leaf-spot (*Cercospora aurantia*, Heald & Wolf).Melanose (*Fungus indet?*).Canker (*Pseudomonas citri*, Hasse). Journ. Agr., Res. 4: 97-150 (1915).Scab (*Cladosporium*, sp.).

Descr. Illus., U. S. Dept. Agr., Div. Veg. Phys. & Path., Bull. 8, pp. 20-23 (1896).

Treat. (pos.), U. S. Dept. Agr., Div. Veg. Phys. & Path., Bull. 8, pp. 23-24 (1896).

Sooty-mold (*Meliola Penzigi*, Sacc. and *M. Camelliae* (Catt.), Sacc.).Twig-blight (*Diplodia aurantii*, Catt and *Sphaeropsis malorum*, Berk.).White-rot (*Sclerotinia libertiana* Fckl.) Bull. 218, Calif. Agr. Exp. Sta. (June, 1911).Wither-tip (*Colletotrichum gloeosporioides* Penz.

Plant Disease, Survey San Antonio Texas (1912).

LETTUCE

(*Lactuca sativa*, L.)Anthracnose (*Marssonina perforans*, Ell & Ev.).

Descr. Illus., Ohio Agr. Exp. Sta., Bull. 73, pp. 222-223 (1897).

Treat. (rec.), Ohio Agr. Exp. Sta., Bull. 73, pp. 225-226 (1897).

Downy Mildew (*Bremia lactuca*, Regel).

Descr. Illus., N. Y. Agr. Exp. Sta., Rep. 4, 1885, p. 253 (1886).

Treat. (pos.), Ohio Agr. Exp. Sta., Bull. 73, p. 226 (1897).

Drop (*Sclerotinia libertiana*, Fckl.).

Descr. Illus., Mass. Agr. Exp. Sta., Bull. 69, pp. 12-15 (1900).

N. C. Bull. 217, 1-21, figs. 8 (July, 1911).

Treat. (pos.), Mass. Agr. Exp. Sta., Bull. 69, pp. 17-35 (1900)

Leaf-mold, Gray Mold or Rot (*Botrytis cinerea*, Pers.).

Descr. Illus., Mass. Agr. Exp. Sta., Bull. 69, pp. 7-12 (1900).

Leaf-rot (*Rhizoctonia* sp.).

Descr. Illus., Mass. Agr. Exp. Sta., Bull. 69, pp. 16-17 (1900)

Treat. (pos.), Mass. Agr. Exp. Sta., Bull. 69, pp. 39-40 (1900).

Leaf-spot (*Septoria consimilis*, Ell. & Mart.).

Descr. Illus., Ohio Agr. Exp. Sta., Bull. 44, pp. 145-146 (1892)

Stem-rot (Bacterial).

Descr., Vt. Agr. Exp. Sta., Rep. 6, 1892, p. 87 (1893).

Treat. (rec.) Vt. Agr. Exp. Sta., Rep. 6, 1892, p. 88 (1893).

LILAC

(*Syringa vulgaris*, L.)

Leaf-spot (*Phyllosticta Halstedii*, Ell. & Ev.).

Powdery Mildew (*Microsphaera alni* (Wallr.) Wint.).

Leaf-blight (*Cercospora macromaculans*, Heald & Wolf).

LILY

(*Lilium* spp.)

Bermuda Disease.

See U. S. Dept. Agr., Div. Veg. Phys. & Path., Bull. 14 (1897)

Bulb-rot (*Rhizopus necans*, Masee).

Mold or Ward's Disease (*Sclerotinia Fuckeliana* deBy.).

Treat. (pos.), Gar. and For., IX-414, p. 44 (1896).

See N. J. Agr. Exp. Sta., Rep. 14, 1893, pp. 392-394 (1894)

LINDEN

(*Tilia* spp.)

Leaf-blight (*Cercospora microsora*, Sacc.).

Occ., N. Y. Agr. Exp. Sta., Rep. 15, 1896, p. 454 (1897).

Stem-rot (*Botrytis cinerea*, Pers.).

LOCUST

(*Robinia pseudacacia*, L.)

Leaf-spot (*Cylindrosporium solitarium*, Heald & Wolf).

Heart-rot (*Trametes robiniophila*, Murr. and *Fomes rimosus* Berk.).

Diseases of Deciduous Trees (1909).

LOQUAT

*(Eriobotrya japonica, Lindl.)*Scab (*Fusicladium dendriticum* (Wallr.), Fckl. var. *Eriobotryæ*, Scalia.

LUPINE

*(Lupinus, spp.)*Blight (*Pestalozzia lupini*, Sor.).

MAGNOLIA

*(Magnolia grandiflora, L.)*Leaf-spot (*Phyllosticta magnoliæ* Sacc. Duggar, p. 347 (1909).

MANGO

*(Mangifera indica, L.)*Anthracnose (*Colletotrichum glæosporioides*, Penz.).

McMurrin Bull. U. S. Dept. Agr. No. 52 (1914).

MAPLE

*(Acer spp.)*Anthracnose (*Glaeosporium apocryptum*, Ell. & Ev.).

Descr., N. Y. Agr. Exp. Sta., Rep. 14, 1895, pp. 531-532. (1896).

Treat. (rec.), N. Y. Agr. Exp. Sta., Rep. 14, 1895, p. 532 (1896)

Decay, *Fomes fomentarius* (L.) Fr. Duggar, p. 467.Gall, *Pycnochytrium globosum*, Schröt; Duggar, p. 139.Heart-rot, *Fomes igniarius* (L.) Gill.; Duggar, p. 465.Leaf-blotch, *Rhytisma acerinum* (Pers.) Fr.Leaf-spot (*Phyllosticta acericola*, Cke. & Ell.).

Descr. Illus., U. S. Dep. Agr., Rep. for 1888, pp. 383-386 (1889).

Treat. (rec.), U. S. Dep. Agr., Rep. for 1888, p. 386 (1889).

Powdery Mildew, *Uncinula aceris* (DC.) Wint.White-rot, *Polyporus squamosus* (Huds.) Fr.; Duggar, p. 453.

MELON

*(Cucumis melo, L.)*Anthracnose (*Colletotrichum lagenarium* (Pass.) Ell. & Hals.).

Descr., U. S. Dep. Agr., Bot. Div., Bull. 8, p. 64 (1889).

Descr. Illus., Okla. Agr. Exp. Sta., Bull. 15, pp. 30-31 (1895).

Treat. (pos.), Md. Agr. Exp. Sta., Rep. 4, 1891, p. 387 (1892).

Anthracnose (*Colletotrichum oligochaetum*, Cav.).

Bacteriosis or Wilt (*Bacillus tracheiphilus*, E. F. Sm.).

Downy Mildew (*Plasmopara cubensis* (B. & C.) Humph.).

Occ. Descr., Conn. Agr. Exp. Sta., Rep. 23, 1899, pp. 277-278 (1900).

Leaf-blight (*Alternaria brassicae*, Sacc., var. *nigrescens*, Regel.).

Descr., Conn. Agr. Exp. Sta., Rep. 19, 1895, pp. 186-187 (1896).

Illus., Ohio Agr. Exp. Sta., Bull. 73, pp. 235-236 (1897).

Treat. (pos.), Conn. Agr. Exp. Sta., Rep. 22, '98, pp. 229-235 (1899).

Cf. Conn. Agr. Exp. Sta., Rep. 23, 1899, pp. 270-273 (1900).

Leaf-spot (*Phyllosticta cucurbitaccarum*, Sacc. ?).

Descr. Illus., N. J. Agr. Exp. Sta., Rep. 14, 1893, p. 355 (1894).

Scab (*Scolecotrichum melophthorum*, Pr. & Del.).

Soft-rot (*Bacillus melonis*, Gidd.) Vt. Bull. 148, 363-416, pls. 8 (Jan. 1910).

Southern Blight (*Sclerotium Rolfsii*, Sacc.).

Wilt (*Neocosmospora vasinfecta* (Atk.) E. F. Sm.).

Cf. Conn. Agr. Exp. Sta., Rep. 22, 1898, pp. 227-228 (1899).

MESQUITE

(*Prosopis juliflora*, DC.)

Anthracnose (*Glaeosporium leguminum* (Cke.), Sacc.).

Blight (*Sclerophygnium aurum*, Heald & Lewis). Trans. Amer. Micr. Soc., XXXI,
5-9 (June, 1912).

Rust (*Ravenelia arizonica*, Ell. & Ev.).

MIGNONETTE

(*Reseda odorata*, L.)

Leaf-blight (*Cercospora rescdae*, Fckl.).

Descr. Illus., U. S. Dep. Agr., Rep. for 1889, pp. 429-430 (1890).

Treat. (pos.), U. S. Dep. Agr., Rep. for 1889, p. 431 (1890).

MILLET

(*Panicum miliaceum*, L.)

Purple-spot (*Piricularia grisea* (Cke.), Sacc.).

Smut (*Ustilago Crameri*, Körn.).

MULBERRY

(*Morus* spp.)

Die-back (*Myxosporium Diedickii*, Syd.).

Chytridiosis (*Cladochytrium mori*, Prunet.).

See U. S. Dept. Agr., Exp. Sta. Rec., VI-9, p. 830 (1895).

Eye-spot (*Cercospora moricola*, Cke.).

Leaf-spot (*Cercospora missouriensis*, Wint.).

Root-rot (*Helicobasidium mompa*, Tanaka. = *Septobasidium mompa* (Tanaka), Rac.).

MUSHROOM

(*Agaricus campestris*, L.)

Mold (*Mycogone perniciosa*, Magn.).

NASTURTIUM

(*Tropaeolum majus*, L.)

Wilt (*Pseudomonas solanacearum*, E. F. Sm.).

Journ. Agric. Research 4, pp. 451-457, pls. 64 (1915).

Leaf-blight (*Alternaria* sp., and *Pleospora tropaeoli*, Hals.).

Descr., N. J. Agr. Exp. Sta. Rep. 13, 1892, p. 290-293 (1893).

OAK

(*Quercus* spp.)¹

Anthraxnose (*Gnomonia veneta* (Sacc. & Speg.), Kleb.).

Pocketed-rot (*Polyporus pilota*, Schw.).

Decay, or Brown-rot (*Polyporus sulphureus* (Bull.) Fr.).

Atkinson, Bull. 193, Cornell Agr. Exp. Sta. (June, 1901).

Heart-rot (*Fomes igniarius* (L.) Gill.).

Honeycomb Heart-rot (*Stercum subpilcatum*, B. & C.).

Journ. of Agr. Research V; 421 (Dec. 6, 1915).

Leaf-curl (*Taphrina cacrulescens*, Desv. & Mont.), Tul.

Leaf-spot (*Marsonia quercus*, Pk.).

Root-rot { (*Armillaria mellea*, Vahl). Bull. U. S. Dep. Agr., No. 89 (1914).
 (*Clitocybe parasitica*, Wilcox).
 (*Polyporus dryadeus*, Fr.).
 (*Rosellinia quercina*, Hartig).

Soft Rot (*Polyporus obtusus*, Berk.).

String and Ray-rot (*Polyporus Berkeleyi*, Fr.).

Straw-colored Rot (*Polyporus frondosus*, Fr.), Journ. Agr. Research I, 109 (1913).

Tar-spot (*Rhytisma crythrosporum*, Bri. & Cav.).

White-rot (*Polyporus squamosus* (Huds.) Fr.).

¹ Consult VON SCHRENK, HERMANN and SPAULDING, PERLEY: Diseases of Deciduous Forest Trees. Bull. 149, U. S. Bureau of Plant Industry, 1900.

OATS

*(Avena sativa, L.)*Blight (Bacterial) *Pseudomonas avenae*, Manns.

Descr., Journ. Mycol., Vol. VI, p. 72; Ohio Bull. 210, Oct. 1909, pp. 91-167, pls. 15 (1890).

Leaf-spot (*Phyllosticta* sp.).

Descr., N. J. Agr. Exp. Sta., Rep. 15, 1894, p. 319 (1895).

Mildew (*Helminthosporium inconspicuum*, Cke. & Ell., var. *britannicum* Gr., and *Cladosporium herbarum* (Pers.), Lk.).

Descr., Me. Agr. Exp. Sta., Rep. for 1894, pp. 95-96 (1895).

Rust (*Puccinia coronata*, Cda., and *P. graminis*, Pers.).

See Wheat (Rust).

Cf. U. S. Dep. Agr., Div. Veg. Phys. & Path., Bull. 16, pp. 45-52 & 60-65 (1899).

Smut (*Ustilago avenae* (Pers.), Jens. and *U. levis* (Kell. & Sw.) Magn.).

Descr. Illus., Kan. Agr. Exp. Sta., Rep. 2, 1889, pp. 215-238 & 259-260 (1890).

Ohio Agr. Exp. Sta., Bull. 64, pp. 123-126 (1896).

Ill. Agr. Exp. Sta., Bull. 57, pp. 297-298 (1900).

Treat (pos.), U. S. Dep. Agr., Farm. Bull. 75, pp. 11-16 (1898).

Ill. Agr. Exp. Sta., Bull. 57, pp. 309-316 (1900).

OKRA

*(Hibiscus esculentus, L.)*Root-rot (*Ozonium omnivorum*, Shear).Wilt (*Fusarium vasinfectum* = *Neocosmospora vasinfectum* (Atk.), E. F. Sm.).

See U. S. Dep. Agr., Div. Veg. Phys. & Path., Bull. 17, p. 31 (1899).

Cf. N. Car. Rep. 1911, pp. 70-73, figs. 4.

(Verticillium albo-atrum, Reinke & Berthold) *Phytopathology* IV, p. 393 (December, 1914).

OLEANDER

*(Nerium oleander, L.)*Leaf-spot (*Macrosporium nerii*, Cke.).

Bull. 218, Calif. Agric. Exper. Sta. (June, 1911).

OLIVE

*(Olea europaea, L.)*Anthracnose (*Glæosporium olivarum*, d'Almeida).Fruit-mold or Dry-rot (*Alternaria* sp. and *Macrosporium* sp.).

Descr. Illus. Cal. Agr. Exp. Sta., Rep. for '95-'97, pp. 235-236 (1898).

Knot (*Pseudomonas Savastanoi*, E. F. Sm.).

Cook Diseases of Tropical Plants, p. 144 (1913).

Rot (Bacterial).

Descr., Cal. Agr. Exp. Sta., Bull. 123, p. 19 (1899).

Scab, Peacock Leaf-spot (*Cyloconium oleaginum*, Cast.).

Descr., Cal. Agr. Exp. Sta., Rep. 1892-93, pp. 297-298 (1894).

See U. S. Dep. Agr., Exp. Sta. Rec., XI-6, p. 554 (1900).

Sooty-mold (*Meliola* sp., Syn. *Capnodium citri* Berk. & Desm.).

Tuberculosis (*Bacillus oleæ* (Arcang.) (Trev.).

Descr. Illus., Cal. Agr. Exp. Sta., Bull. 120 (1898).

Treat. (rec.), Cal. Agr. Exp. Sta., Bull. 120, pp. 10-11 (1898).

Cf. Cal. Agr. Exp. Sta., Rep. for '97-'98, p. 178 (1900).

ONION

(*Allium cepa*, L.)

Anthracnose or Rot (*Vermicularia circinans*, Berk.).

Descr. Illus., Conn. Agr. Exp. Sta., Rep. 13, 1889, p. 163 (1890).

Treat. (rec.), Conn. Agr. Exp. Sta., Rep. 13, 1889, pp. 164-165 (1890).

Downy Mildew (*Peronospora Schleideniana*, deBy.).

Descr. Illus., Wis. Agr. Exp. Sta., Rep. 1, 1883, pp. 38-44 (1884).

Descr., Conn. Agr. Exp. Sta., Rep. 13, 1889, pp. 155-156 (1890).

N. Y. Cornell Bull. 218, pp. 137-161, figs. 17 (Apr., 1904).

Treat. (rec.), Vt. Agr. Exp. Sta., Rep. 10, 1896-97, pp. 61-62 (1897).

Mold (*Macrosporium sarcinula*, B., var. *parasiticum*, Thüm., and *M. Porri*, Ell.).

Descr. Illus., Conn. Agr. Exp. Sta., Rep. 13, 1889, pp. 158-162 (1890).

Treat. (rec.), Conn. Agr. Exp. Sta., Rep. 13, 1889, p. 161 (1890).

Rot (Bacterial).

Descr. Illus., N. Y. Agr. Exp. Sta., Bull. 164, pp. 209-212 (1899).

Smut (*Urocystis cepulæ*, Frost).

Descr. Illus., Conn. Agr. Exp. Sta., Rep. 13, 1889, pp. 129-146 (1890).

Ohio Bull. 122, pp. 71-84, figs. 4 (Dec., 1900).

Treat. (pos.), Conn. Agr. Exp. Sta., Rep. 13, 1889, pp. 147-153 (1890).

(By transplanting), Conn. Agr. Exp. Sta., Rep. 19, 1895, pp. 176-182 (1896).

Cf. U. S. Dep. Agr., Farm. Bull. 39, pp. 16-20 (1896).

N. Y. State Bull. 182, pp. 145-172, pl. 1 (Dec., 1900).

ORANGE

(*Citrus aurantium*, L.)

Anthracnose (*Colletotrichum gloeosporioides* Penz.).

Descr. Illus., Fla. Agr. Exp. Sta., Bull. 53, pp. 171-173 (1900).

Fla. Agr. Exp. Sta., Bull. 108, pp. 25-47 (Nov., 1911).

- Treat. (rec.), Fla. Agr. Exp. Sta., Bull. 53, p. 173 (1900).
- Black-rot (*Alternaria citri* Ellis & Pierce).
Coit, Citrus Fruits, p. 388 (1915).
- Cottony-mold and Twig-blight (*Sclerotinia libertiana*, Fkl.).
Coit, Citrus Fruits, p. 382 (1915).
- Diplodia Rot (*Diplodia natalensis* Evans), Coit, p. 397 (1915).
- Flyspeck (*Leptothyrium pomi* (Mort & Fr.) Sacc.) Hume, Citrus Fruits and Their Culture, p. 481 (1911).
- Foot-rot or Mal-di-gomma (*Fusarium limonis*, Bri.).
Descr. Illus. Treat. (rec.), U. S. Dept. Agr., Div. Veg. Phys. & Path., Bull. 8, pp. 28-31 (1896).
Fla. Agr. Exp. Sta., Bull. 53, pp. 151-155 (1900).
- Fruit-rot (*Penicillium digitatum* (Fr.), Sacc. & *Penicillium italicum*, Wehm.).
- Gum-disease (*Botrytis vulgaris*, Fr.).
Coit, Citrus Fruits, p. 366 (1915).
- Leaf-glaze (*Strigula complanata*, Fée).
Occ., Journ. Mycol., Vol. VII, p. 36 (1891).
- Melanose (*Phomopsis citri* Fawcett).
Descr. Illus. Treat. (pos.), U. S. Dept. Agr., Div. Veg. Phys. & Path., Bull. 8, pp. 33-38 (1896).
- Nail-head Rust (*Cladosporium herbarum* (Pers.), Pk. var. *citricolum* Fawcett & Berger).
Coit, Citrus Fruits, p. 395, 1915, Fla. Bull. 109, pp. 47-60 (May, 1912).
- Scab (*Cladosporium citri* Mass.).
Phytopath. 6, pp. 127-142 (1916).
See Lemon (scab.).
- Sooty-mold (*Meliola Penzigi*, Sacc. and *M. camelliae* (Catt.), Sacc.).
Descr. Illus. Treat. (pos.), U. S. Dept. Agr., Div. Veg. Phys. & Path., Bull. 13 (1897).
- Toadstool Root-rot (*Armillaria mellea* Vahl.).
Coit, Citrus Fruits, p. 373 (1915).
- Trunk-rot (*Schizophyllum commune* Fr.).
Coit, Citrus Fruits, p. 399 (1915).
- Wither-tip (*Colletotrichum gloeosporioides*, Penz.).
Coit, Citrus Fruits; 380 (1915).
Grossenbacher, J. G.; Some Bark Diseases of Citrus Trees in Florida, Phytopath. 6, pp. 29-50 (1916).

ORCHARD GRASS

(*Dactylis glomerata*, L.)

- Rust { *Puccinia coronata*, Cda.; Duggar, p. 420 (1909).
 { *Puccinia graminis*, Pers.; Duggar, p. 408 (1909).
- Scolecotrichose (*Scolecotrichum graminis* Fuckl.).

ORCHIDS

(Orchidaceæ)

Anthraxnose (*Glæosporium cinctum* Bri. & Cav. *Colletotrichum cinctum* (Bri. & Cav.) Stonem.).

Descr., N. J. Agr. Exp. Sta., Rep. 14, 1893, pp. 414-417 (1894).

Anthraxnose (*Glæosporium macropus*, Sacc.).

Leaf-blight (*Cercospora angreci*, Feuill & Roum.).

OSAGE ORANGE

(Toxylon pomiferum, Raf.)

Rust (*Physopella fici* (Cast), Arth. = *Uredo fici* Cast.)

Blight (*Sporodesmium macluræ* Thüm.).

PALM

(Phænix dactylifera, L.)

Leaf-spot (*Graphiola phænicis* (Moug.) Poit.).

Bull. 218, Calf. Agr. Exp. Sta. (June, 1911).

PANSY

(Viola tricolor, L.)

Leopard Petal-blight (*Colletotrichum violæ-tricoloris*), R. E. Smith.

Smith, R. E., Bot. Gaz. 27, p. 203 (March, 1899).

Dry-up (*Fusarium violæ* Wolf.).

Wolf, F. A.; Mycologia, 2, p. 19 (January, 1910).

PAPAW

(Carica papaya, L.)

Leaf-spot (*Pucciniopsis carica* Earle).

PARSNIP

(Pastinaca sativa, L.)

Leaf-blight (*Cercospora apii*, Fres.).

Occ., N. J. Agr. Exp. Sta., Rep. 15, 1894, p. 351 (1895).

Root-rot (*Corticium vagum*, Bri. & Cav., var. *solani*, Burt.).

Heald & Wolf, Plant Disease Survey in Texas (1912).

PEA

*(Pisum sativum, L.)*Damping-off (*Ascochyta pisi*, Lib. and *Pythium* sp.).

Occ., Conn. Agr. Exp. Sta., Rep. 23, 1899, pp. 280-281 (1900).

Ohio Bull. 173, pp. 231-246, figs. 11 (Apr., 1906).

Pod-spot (*Ascochyta pisi*, Lib.).

Descr., N. J. Agr. Exp. Sta., Rep. 14, 1893, p. 358 (1894).

Treat. (rec.), Del. Agr. Exp. Sta., Bull. 41, pp. 9-11 (1898).

Leaf-spot (*Septoria pisi*, West.).

Occ., N. J. Agr. Exp. Sta., Rep. 14, 1893, p. 358 (1894).

Mold (*Pleospora pisi* (Sow.), Fckl.).

Occ., N. J. Agr. Exp. Sta., Rep. 14, 1893, p. 358 (1894).

Powdery Mildew (*Erysiphe polygoni*, DC.).

Descr., N. J. Agr. Exp. Sta., Rep. 14, 1893, p. 357 (1894).

PEACH

*(Prunus persica, Benth. & Hook)*Anthracnose (*Glaeosporium lacticolor*, Berk.).

Occ. Ohio Agr. Exp. Sta., Bull. 92, p. 225 (1898).

Brown-rot (*Sclerotinia cinerea* (Bon.) Schröt.) Heald, F. W., Washington Agriculturist, VIII, No. 9, June, 1915.Crown-gall (*Pseudomonas tumefaciens*, E. F. Sm. and Towns.).Die-back (*Valsa leucostoma* (Pers.) Fr.).

Stevens & Hall, Diseases of Economic Plants, p. 129 (1910).

California Peach Blight (*Coryneum Beijerinckii* Oud.).

Oregon Stat. Biennial Report, p. 255 (1911-12).

Cal. Bull. 191, pp. 73-98, figs. 17 (Sept., 1907).

Frosty Mildew (*Cercospora persica*, Sacc.).

Stevens & Hall, Diseases of Economic Plants, p. 133 (1910).

Fruit-mold or Twig-blight (*Sclerotinia fructigena* (Pers.) Schröt.).

Descr. Illus., Journ. Mycol., Vol. VII, pp. 36-38 (1891).

Ga. Agr. Exp. Sta., Bull. 50 (1900).

Treat. (pos.), Ga. Agr. Exp. Sta., Bull. 50, pp. 267-269 (1900).

Cf. Conn. Agr. Exp. Sta., Rep. 24, 1900, pp. 252-254 (1901).

Cf. Cherry (Fruit-mold and Twig-blight).

Pustular-spot (*Helminthosporium carpophilum*, Lév.).

Occ., Mich. Agr. Exp. Sta., Bull. 103, p. 57 (1894).

Treat. (pos.), Ohio Agr. Exp. Sta., Bull. 92, p. 225 (1898).

Leaf-blight or Shot-hole (*Cercospora persica*, Sacc.).

Occ., N. C. Agr. Exp. Sta., Bull. 92, p. 103 (1893).

Treat. (rec.), N. C. Agr. Exp. Sta., Bull. 92, p. 103 (1893).

Leaf-blight or Frosty Mildew (*Cercospora persica*, Sacc.).

Occ., Journ. Mycol., Vol. VII, p. 91 (1892).

Leaf-curl (*Exoascus deformans* (Berk.), Fckl.).

Descr. Illus., N. Y. (Corn. Univ.) Agr. Exp. Sta., Bull. 73, pp. 324-325 (1894).

U. S. Dep. Agr., Div. Veg. Phys. & Path., Bull. 20 (1900).

Treat. (pos.), N. Y. Cornell Bull. 276, p. 151-178, figs. 8 (Apr., 1910).

U. S. Dep. Agr., Div. Veg. Phys. & Path., Bull. 20 (1900).

Powdery Mildew (*Sphaerotheca pannosa* (Wallr.), Lév. ? and *Podosphera oxyacantha* (DC.), de By.).

Occ., Journ. Mycol., Vol. VII, p. 90 (1892).

Descr. Illus., N. Y. (Corn. Univ.) Agr. Exp. Sta., Bull. 74, p. 381 (1894).

Root-rot (*Fungus indct.?*).

Occ., Journ. Mycol., Vol. VII, p. 377 (1894).

Ohio Agr. Exp. Sta., Bull. 92, p. 235 (1898).

Rust (*Puccinia pruni-persicæ* Hori).

Phytopath. 2, p. 143-145, also *Tranzschelia punctata* (Pers.) Arth.

2d Biennial Crop Pest and Hort. Rep. Oregon (June, 1915).

See Cherry (Rust).

Scab (*Cladosporium carpophilum*, Thüm).

Descr. Illus., Ind. Agr. Exp. Sta., Bull. 19, pp. 5-8 (1889).

Del. Agr. Exp. Sta., Rep. 8, 1895-96, pp. 60-63 (1896).

Ohio Agr. Exp. Sta., Bull. 92, pp. 220-222 (1898).

Treat. (pos.), Del. Agr. Exp. Sta., Rep. 8, 1895-96, p. 63 (1896).

Cf. N. J. Agr. Exp. Sta., Rep. 15, 1894, pp. 328-330. (On leaves).

Conn. Agr. Exp. Sta., Rep. 20, 1896, pp. 269-271. (On twigs).

Bull. 395, U. S. Dept. Agric., 1917.

Shot-hole (*Coryncum Beijerinckii* Oud.).

Stevens & Hall, Disease of Economic Plants, p. 129 (1910).

Stem-blight (*Phoma persicæ*, Sacc.).

Descr. Illus., Ohio Agr. Exp. Sta., Bull. 92, pp. 233-234 (1898).

Yellows.

Stevens & Hall, Diseases of Economic Plants, p. 135 (1910).

PEANUT

(*Arachis hypogæa*, L.)

Bacterial Blight (*Bacillus solanaccarum*, E. F. Sm.).

Phytopathology IV; 397 (December, 1914).

Leaf-spot¹ (*Cercospora personata* (Bri. & Cav.), Ell. & Ev.).

Phytopathology IV; 397 (December, 1914).

Red-rot (*Neocosmopora vasinfecta* (Atk.) E. F. Sm.).

Phytopathology IV; 397 (December, 1914).

Sclerotial-rot (*Sclerotium Rolfsii* Sacc.).

Phytopathology IV; 397 (December, 1914).

¹ Consult also WOLF, FREDERICK A.: Further Studies on Peanut Leaf-spot.

Journ. Agr. Res. 5, pp. 891-902, Feb., 1916.

PEAR

(Pirus communis, L.)

Anthracnose (*Colletotrichum* sp.).

Occ., N. J. Agr. Exp. Sta., Rep. 15, 1894, p. 331 (1895).

Bitter-rot (*Glomerella rufomaculans* (Berk.), Spauld. & v. Schr.).

Stevens & Hall, Diseases of Economic Plants, p. 107 (1910)

Black-rot (*Sphaeropsis malorum*, Berk.).Brown-blotch (*Macrosporium Sydowianum*, Farneti).

Circ. 52, N. J. Agr. Exp. Sta.

Body-blight or Canker (*Sphaeropsis malorum*, Berk.).

Occ., N. Y. Agr. Exp. Sta., Bull. 163, p. 203 (1899).

Dry-rot (*Thelephora pedicellata*, Schw.).

Descr., Journ. Mycol., Vol. VI, pp. 113-114 (1891).

Treat. (pos.), Journ. Mycol., Vol. VI, p. 114 (1891).

Fire-blight (*Bacillus amylovorus* (Burr.), Trev.).

Descr. Illus., N. Y. Agr. Exp. Sta., Rep. 5, 1886, pp. 275-289 (1887).

Descr., Conn. Agr. Exp. Sta., Rep. 18, 1894, pp. 113-116 (1895).

U. S. Dept. Agr., Year-book for 1895, pp. 295-298 (1896).

N. Y. (Corn. Univ.) Agr. Exp. Sta., Bull. 145, pp. 622-625, 1898.

Utah Bull. 85, Nov., 1903, pp. 45-52.

Vt. Rep. 1902, pp. 231-239.

Ark. Bull. 113, 1913, pp. 493-505.

Treat. (pos.), Phytopath. 6, pp. 152-158, 288-292 (1916).

Fly-speck (*Leptothyrium carpophilum*, Pass.).

N. J. Agr. Exp. Sta., Rep. 18, 1897, pp. 378-383 (1898).

Fruit Spot (*Fabraea maculatum*, (Lév.), Atk.).Leaf-blight (*Fabraea maculatum* (Lév.), Atk. and *Cercospora minima*, Tracy and Earle).

Descr. Illus., U. S. Dep. Agr., Rep. for 1888, pp. 357-362 (1889).

Del. Agr. Exp. Sta., Bull. 13, pp. 4-6 (1891).

N. Y. (Corn. Univ.) Agr. Exp. Sta., Bull. 145, p. 611 (1898).

Heald and Wolf, Plant Disease Survey, San Antonio, Texas, (1912).

Treat (pos.), R. I. Agr. Exp. Sta., Bull. 31, pp. 5-9 (1895).

Cf. Quince (Leaf-spot).

Leaf-spot (*Septoria piricola*, Desm.).

Descr. Illus., Treat. (pos.), N. Y. (Corn. Univ.) Agr. Exp. Sta., Bull. 145, pp. 597-611 (1898).

Rust (*Gymnosporangium globosum*, Farl.).

Occ., Conn. Agr. Exp. Sta., Rep. 14, 1890, p. 98 (1891).

Scab (*Fusicladium pirinum* (Lib.), Fckl. = *Venturia pirina*, Aderh.).

Descr. Illus., N. Y. (Corn. Univ.) Agr. Exp. Sta., Bull. 145, pp. 616-620 (1898).

Treat. (pos.), Vt. Agr. Exp. Sta., Bull. 44, pp. 85-90 (1895).

Cf. Apple (Scab).

Shot-hole (*Cylindrosporium padi*, Karst.).

Bull. 212, Colo. Exp. Sta. (October, 1915).

PECAN

(*Hicoria pecan* (Marsh.), Butt.)¹

Anthracnose (*Glomerella cingulata* (Stonem) S. & S.).

Brown Leaf-spot (*Cercospora fusca*, Rand).

Crown-gall (*Pseudomonas tumefaciens*, E. F. Sm. & Towns.).

Kernel-spot (*Coniothyrium caryogenum*, Rand).

Leaf-blight (*Scptoria carya*, Ell. & Ev.).

Heald & Wolf, Plant Disease Survey in Texas (1912).

Leaf-blotch (*Mycesphærella convexula* (Schw.), Rand).

Phytopath. 1, pp. 133-138 (1911).

Mildew (*Microsphaera alni* (Wallr.), Wint).

Nursery-blight (*Phyllosticta carya*, Pk).

Scab (*Fusicladium effusum*, Wint.).

Orton, W. A., Science, new ser. 21, p. 503 (March 31, 1905).

PEONY

(*Pæonia officinalis*, L.)

Mold (*Botrytis pæoniæ*, Oud.)

PEPPERS

(*Capsicum annuum*, L.)

Anthracnose (*Colletotrichum nigrum*, Ell. & Hals. and *Glæosporium piperatum*, Ell. & Ev.).

Descr. Illus., N. J. Agr. Exp. Sta., Rep. 11, 1890, pp. 358-359 (1891).

Cf. N. J. Agr. Exp. Sta., Rep. 13, pp. 332-333 (1893).

Fruit-rot (*Glæosporium piperatum*, Ell. & Ev.).

Mold (*Macrosporium* sp.).

Occ., N. J. Agr. Exp. Sta., Rep. 15, 1894, p. 351 (1895).

Leaf-spot (*Cercospora capsici*, Heald & Wolf).

PERSIMMON

(*Diospyros* spp.)

Black Leaf-spot (*Cercospora fuliginosa*, Ell. & Kellem).

Leaf-spot (*Cercospora kaki*, Ell. & Ev.).

Fruit-rot (*Phyllosticta biformis*, Heald & Wolf).

¹ RAND, FREDERICK V.: Some Diseases of Pecans, Journal of Agricultural Research I, pp. 303-337, June 10, 1914.

- Miscellaneous Fungous Diseases. $\left\{ \begin{array}{l} \textit{Agaricus.} \\ \textit{Cercospora atra, Ell. \& Ev.} \\ \textit{Glæosporium diospyri, Ell. \& Ev.} \end{array} \right.$
- See N. C. Agr. Exp. Sta., Bull. 92, p. 116 (1893).

PHLOX

*(Phlox spp.)*Leaf-spot (*Septoria divaricata*, Ell. & Ev.).

PINE

*(Pinus spp.)*¹

- Blister-rust (*Cronartium ribicola*, Fisch. (= *Peridermium strobi* (Kleb.), Spauld.).
Bull. 206, Bureau of Plant Industry, 1911; American Forestry (Feb., Dec., 1916).
- Bluing (*Ceratostomella pilifera* (Fr.) Wint.).
von Schrenk, U. S. Bureau Plant Industry, Bull. 36 (1903).
- Chalky Quinine Fungus (*Fomes laricis* (Jacq.), Murr.).
Meinicke, 1914, p. 44.
- Dry-rot (*Trametes Pini* (Brot.) Fr., and *T. radiciperda* Hartig=*Fomes annosus* (Fr.), Cke.).
Descr. Illus., U. S. Dep. Agr., Div. Veg. Phys. & Path., Bull. 25, pp. 31-40 (1900).
- Gray Leaf-tip (*Hypoderma Desmazieri*, de By.).
Stevens & Hall, Diseases of Economic Plants, p. 445 (1910).
- Leaf-blight (*Lophodermium brachysporum*, Rostr. = *Hypoderma brachysporum* (Rostr.), Tubeuf.).
Stevens & Hall, p. 445 (1910).
- Needle Disease (*Hypoderma deformans*, Weir on *Pinus ponderosa*, Laws. Journ. Agric. Res. VI: 277-288, May 22, 1916).
- Pine Gall (*Peridermium Harknessii* Moore = *P. cerebrum* Pk.).
Meinecke, E. P., Forest Tree Diseases Common in California and Nevada, U. S. Forest Service (1914).
- Punk-rot (*Polyporus pinicola*, Atk. = *Fomes unguatus* (Schraeff) Sacc.).
Bull. 193, Corn. Univ. Agr. Exp. Sta. (June, 1901).
- Red-rot (*Polyporus ponderosus*, v. Schr.).
U. S. Bureau of Plant Industry, Bull. 36 (1903).
- Root-rot (*Polyporus Schweinitzii*, Fr.).
Descr. Illus., U. S. Dep. Agr., Div. Veg. Phys. & Path., Bull. 25, pp. 18-24 (1900).

¹ The twelve species of *Peridermium* found in American pines are described by Arthur and Kern in North American Species of *Peridermium*, Bull. Torr. Bot. Club 33, pp. 403-438, 1906.

Rust (*Coleosporium pini*, Gall=*Gallowaya pini* (Gall.), Arth. and *Peridermium piriforme*, Pk.).

Descr., Journ. Mycol., Vol. VII, p. 44 (1891).

Wet-rot (*Polyporus subacidus*, Pk. ?).

Descr. Illus., U. S. Dep. Agr., Div. Veg. Phys. & Path., Bull. 25, pp. 44-49, (1900).

PINK (SWEET WILLIAM)

(*Dianthus barbatus*, L.)

Mold (*Heterosporium cchinulatum* (Berk.), Cke.).

Rust (*Puccinia arenariae* (Schum.), Wint.).

Descr. Illus., N. J. Agr. Exp. Sta., Rep. 13, 1892, pp. 278-280 (1893).

Treat. (rec.), N. J. Agr. Exp. Sta., Rep. 13, 1892, p. 280 (1893).

PLUM

(*Prunus* spp.)

Bacterial Leaf-spot (*Pseudomonas pruni*, E. F. Sm.).

Heald & Wolf, Plant Disease Survey, San Antonio, Texas (1912).

Black-knot (*Plowrightia morbosa* (Schw.), Sacc.).

Descr. Illus. Treat., Ky. Agr. Exp. Sta., Bull. 80, pp. 250-256 (1899).

Cf. Cherry (Black Knot).

Canker (*Nectria ditissima*, Tul.).

Descr., See U. S. Dep. Agr., Exp. Sta. Rec., IX-8, pp. 761-762 (1898).

Die-back (*Valsa leucostoma* (Pers.), Fr.).

Heald & Wolf, Plant Disease Survey, San Antonio, Texas (1912).

Fire-blight (Bacterial).

Occ., Conn. Agr. Exp. Sta., Rep. 18, 1894, pp. 117-118 (1895).

Fruit-mold (*Sclerotinia fructigena*, Kze. & Schm.).

Descr. Illus., Oreg. Agr. Exp. Sta., Bull. 57, pp. 3-12 (1899).

Treat. (pos.), N. Y. (Corn. Univ.) Agr. Exp. Sta., Bull. 86, pp. 71-72 (1895).

Mo. Agr. Exp. Sta., Bull. 31, pp. 16-18 (1895).

Valleau, W. D.: Varietal Resistance of Plums to Brown Rot, Journ. Agr. Research V, pp. 365-395 (1915).

Cf. Cherry (Fruit-mold).

Leaf-curl (*Exoascus mirabilis*, Atk.).

Descr. Illus., Conn. Agr. Exp. Sta., Rep. 19, 1895, pp. 183-185 (1896).

Treat. (pos.), Conn. Agr. Exp. Sta., Rep. 20, 1896, p. 281 (1897).

Leaf-spot (*Cylindrosporium padi*, Karst. and *Phyllosticta congesta*, Heald & Wolf).

Descr. Illus., N. Y. Agr. Exp. Sta., Rep. 5, 1886, pp. 293-296 (1887).

N. Y. Agr. Exp. Sta., Rep. 6, 1887, pp. 347-350 (1888).

Treat. (pos.), U. S. Dep. Agr., Div. Veg. Path., Bull. 7, p. 30 (1894).

N. Y. Agr. Exp. Sta., Rep. 15, '96, pp. 384-401 (1897).

Cf. Cherry (Leaf-spot).

Plum-pockets (*Exoascus pruni*, Fekl.).

Descr. Illus., U. S. Dep. Agr., Rep. for 1888, pp. 366-369 (1889).

N. Y. (Corn. Univ.) Agr. Exp. Sta., Bull. 73, pp. 329-330 (1894).

Treat. (rec.), N. C. Agr. Exp. Sta., Bull. 92, p. 111 (1893).

Powdery Mildew (*Podosphæra oxyacanthæ* (DC.), de By.).

See Cherry (Powdery Mildew).

Root-rot (*Armillaria mellea*, Vahl).

Bull. 59, pp. 14 (1903).

Rust (*Puccinia pruni spinosæ*, Pers. = *Tranzschelia punctata* (Pers.), Arth.).

Descr., Journ. Mycol., Vol. VII, pp. 354-356 (1894).

Treat. (pos.), Journ. Mycol., Vol. VII, pp. 356-362 (1894).

Cf. Cherry (Rust).

Scab (*Cladosporium carpophilum*, Thüm.).

Descr., Journ. Mycol., Vol. VII, pp. 99-100 (1892).

Descr. Illus., Iowa Agr. Exp. Sta., Bull. 23, pp. 918-920 (1894).

Cf. Cherry and Peach (Scab).

Shot-hole (*Cylindrosporium padi*, Karst.).

POMEGRANATE

(*Punica granatum*, L.)

Leaf-spot (*Cercospora lythracearum*, Heald & Wolf).

POMELO

(*Citrus decumana*, Murr.)

Anthracnose (*Colletotrichum glaucosporioides*, Penz.).

Fla. Bull. 74, pp. 159-172, pls. 4 (August, 1904).

Canker (*Pseudomonas citri*, Hesse).

Journ. Agr. Research VI, pp. 69-99 (April, 1916).

POPLAR

(*Populus* spp.)

Anthracnose (*Marssonina populi* (Lib.), Sacc.).

Descr., N. J. Agr. Exp. Sta., Rep. 15, 1894, pp. 394-396 (1895).

Leaf-spot (*Septoria musiva*, Pk.) and (*Septoria populicola*, Pk.).

Rust (*Melampsora populina* (Jacq.), Lév.).

Descr. Illus., U. S. Dep. Agr., Rep. for 1888, pp. 390-392 (1889).

Treat. (pos.), Mass. Agr. Exp. Sta., Rep. 7, 1894, p. 20 (1895).

POTATO

(*Solanum tuberosum*, L.)

Anthracnose (*Vermicularia*, sp.).

Black-leg (*Bacillus phytophthorus*, Appel).

Orton, W. A., Potato Tuber Diseases, Farmers' Bull. 544 (1913).

Blight (*Bacillus solanaccarum*, E. F. Sm.).

Descr. Illus. Treat. (rec.), U. S. Dep. Agr., Div. Veg. Phys. & Path., Bull. 12 (1896).

Chytridiose or Black Scab (*Synchytrium endobioticum* (Schillb.) Percival = *Chyso-phlyctis endobiotica*, Schillb.)

Downy Mildew or Rot (*Phytophthora infestans*, de By.).

Descr. Illus., U. S. Dep. Agr., Rep. for 1888, pp. 337-338 (1889).

N. H. Agr. Exp. Sta., Bull. 22, pp. 3-5 (1894).

N. Y. (Corn. Univ.) Agr. Exp. Sta., Bull. 113, pp. 240-254 (1896).

Vt. Bull. 168, pp. 100, pls. 10, figs. 10 (August, 1912).

Conn. Rep., pt. 10, pp. 753-774 (1909).

Melhus, I. E., Hibernation in the Irish Potato, Journ. Agr. Research V, pp. 71-102 (1915).

Treat. (pos.), U. S. Dep. Agr., Farm. Bull. 91 (1899).

Dry-rot (*Fusarium solani* (Mart.) Sacc. and *F. radicola*, Wollenw.).

Occ., Ill. Agr. Exp. Sta., Bull. 40, p. 139 (1895).

Internal Browning (Bacterial?).

Descr., Ill. Agr. Exp. Sta., Bull. 40, pp. 138-139 (1895).

N. Y. Agr. Exp. Sta., Bull. 101, pp. 78-83 (1896).

Leaf-blotch (*Cercospora concors* (Casp.) Sacc.).

Stevens & Hall, Diseases of Economic Plants, p. 278 (1910).

Leaf-mold or Early-blight (*Alternaria solani* (Ell. & Mart.), Jones & Grout).

Descr. Illus., Del. Agr. Exp. Sta., Rep. 4, 1891, pp. 58-59 (1892).

N. Y. (Corn. Univ.) Agr. Exp. Sta., Bull. 140, p. 393 (1897).

Vt. Agr. Exp. Sta., Bull. 72, pp. 16-25 (1899).

Treat. (pos.), U. S. Dept. Agr., Farm. Bull. 91, pp. 5-7 (1899).

Wisc. Rep., pp. 343-354, figs. 7 (1907).

Leak (*Pythium de Baryanum*, Hesse.)

Journ. Agr. Research VI, pp. 627-640, pl. 1 (1916).

Powdery² Scab (*Spongospora subterranea*).

Orton, W. A., Potato Tuber Diseases, U. S. Farm. Bull. 544 (1913).

Bull., U. S. Dept. Agr., No. 82 (1914).

Powdery Dry-rot (*Fusarium trichothecoides* Wollenw.).

Orton, W. A., U. S. Farm. Bull. 544 (1913).

Pratt, Journ. Agric. Res., VI: 817-831, Aug. 21, 1916.

Root-rot (*Entorrhiza solani*, Fautr.).

See U. S. Dept. Agr., Exp. Sta. Rec., VII-10, p. 873 (1896).

Scab (*Actinomyces chremogones*, Gasp.).

Descr. Illus., Conn. Agr. Exp. Sta., Rep. 14, 1890, pp. 81-95 (1891).

Descr. Illus., Conn. Agr. Exp. Sta., Rep. 15, 1891, pp. 153-160 (1892).

¹ CARPENTER, C. W.: Some Potato Tuber-rots Caused by Species of *Fusarium*, Journal of Agricultural Research V, pp. 183-209 (Nov. 1, 1915).

² Consult MELHUS, I. E., ROSENBAUM, J. and SCHULTZ, E. S.: Studies of *Spongospora subterranea* and *Phoma tuberosa* of the Irish Potato, Journ. Agr. Research VII, pp. 213-253, October, 1916, also IV, pp. 265-278.

- Cf. W. Va. Agr. Exp. Sta., Sp. Bull. 2, pp. 97-111 (1895).
 Treat. (pos.) Journ. Agr. Research IV, pp. 129-133 (1915).
 (Cor. Sub.) Mich. Agr. Exp. Sta., Bull. 108, pp. 38-45 (1894).
 Ind. Agr. Exp. Sta., Bull. 56, pp. 70-80 (1895).
 Conn. Agr. Exp. Sta., Rep. 19, 1895, pp. 166-176 (1896).
 (Formalin) U. S. Dep. Agr., Farm. Bull. 91, pp. 9-10 (1899).
 Scurf (*Rhizoctonia solani*, Kühn = *Corticium vagum*, B. & C., var. *solani*, Burt.).
 Silver-scurf (*Spondylocladium atrovirens*, Harz.).
 Orton, U. S. Farm. Bull. 544 (1913).
 Journ. Agr. Research VI, pp. 339-350 (June, 1916).
 Stem-blight (*Fusarium acuminatum*, Ell. & Ev.?).
 Descr., N. Y. Agr. Exp. Sta., Bull. 101, p. 85 (1896).
 Cf. N. Y. Agr. Exp. Sta., Bull. 138, pp. 632-634 (1897).
 Stem-rot (*Corticium vagum*, Bri. & Cav., var. *solani*, Burt.).
 Cal. Bull. 70, pp. 1-20, pls. 12 (March, 1902).
 Tuber-rot (*Fusarium oxysporum*, Schlecht).
 Orton, U. S. Farmer's Bull. 544 (1913).
 Bull., U. S. Dep. Agr., No. 64 (1914).
 Wart (*Synchytrium endobioticum* (Schilb.), Percival).
 Orton, W. A., Potato Tuber Diseases, U. S. Farmer's Bull. 544 (1913).
 Wet-rot (*Bacterial*).
 Descr., Del. Agr. Exp. Sta., Rep. 4, 1891, pp. 54-57 (1892).
 Wilt (*Bacillus solanaccarum*, E. F. Sm.).
 Yellow-blight (*Sclerotinia libertiana*, Fckl.; Syn. *Peziza postuma*, Berk. & Wils.?).

PRIMROSE

(Primula, spp.)

- Miscellaneous Fungous Diseases. { *Phyllosticta primulicola*, Desm.
Ramularia primulae, Thra.
Colletotrichum primulae, Hals.
Ascochyta primulae, Trail.

See N. J. Agr. Exp. Sta., Rep. 15, 1894, pp. 377-380 (1895).

PRIVET

(Ligustrum vulgare, L.)

- Anthraxnose (*Glæosporium cingulatum*, Atk.).
 Descr. Illus., N. Y. (Corn. Univ.) Agr. Exp. Sta., Bull. 49, pp. 306-314 (1892).
 Leaf-spot (*Cercospora adusta*, Heald & Wolf, *C. ligustri*, Roum and *Phyllosticta ovalifolia*, Brun.)

QUINCE

(Pirus cydonia, L.)

- Black-rot (*Sphaeropsis malorum*, Berk.).
 Descr. Illus., N. J. Agr. Exp. Sta., Bull. 91, pp. 8-10 (1892).
 Treat. (rec.), Conn. Agr. Exp. Sta., Bull. 115, pp. 6-7 (1893).

Fire-blight (*Bacillus amylovorus* (Burr.), Trev.).

See Apple and Pear (Fire-blight).

Leaf-blight (*Entomosporium maculatum*, Lév = *Fabraca maculatum* (Lév.) Atk.

Descr. Illus., See Pear (Leaf-spot).

Treat. (pos.), N. Y. (Corn. Univ.) Agr. Exp. Sta., Bull. 80, pp. 619-625 (1894).

Mold (*Sclerotinia cydoniæ*, Schellenb.).

Pale-rot (*Phoma cydoniæ*, Sacc. & Schulz.?).

Descr. Illus., N. J. Agr. Exp. Sta., Bull. 91, pp. 10-11 (1892).

Ripe-rot or Anthracnose (*Glæosporium fructigenum*, Berk.).

See Apple and Grape (Ripe-rot).

Rust (*Gymnosporangium clavipes*, C. & P., Syn. *Ræstelia aurantiaca*, Pk.).

Descr. Illus., N. J. Agr. Exp. Sta., Bull. 91, pp. 2-5 (1892).

N. Y. (Corn. Univ.) Agr. Exp. Sta., Bull. 80, pp. 625-626 (1894).

Mass. Hatch Rep., pp. 61-63 (1897).

Treat. (rec.), N. Y. (Corn. Univ.) Agr. Exp. Sta., Bull. 80, p. 627 (1894).

RADISH

(*Raphanus sativus*, L.)

Club-root (*Plasmodiophora brassicæ*, Wor.).

Occ., N. J. Agr. Exp. Sta., Rep. 11, 1890, pp. 348-349 (1891).

Downy Mildew (*Peronospora parasitica* (Pers.) deBy.).

Occ., N. J. Agr. Exp. Sta., Rep. 11, 1890, p. 349 (1891).

White-rust (*Cystopus candidus* (Pers.), Lév.).

Occ., N. J. Agr. Exp. Sta., Rep. 11, 1890, p. 350 (1891).

Treat. (rec.), N. J. Agr. Exp. Sta., Rep. 11, 1890, p. 350 (1891).

RASPBERRY

(*Rubus* spp.)

Anthracnose (*Glæosporium venetum*, Speg. = *Gl. necator*, Ell. & Ev.).

Descr. Illus., U. S. Dept. Agr., Rep. for 1887, pp. 357-360 (1888).

Ohio Agr. Exp. Sta., Bull. IV-6, pp. 124-126 (1891).

N. Y. Agr. Exp. Sta., Bull. 124, pp. 262-264 (1897).

Treat. (pos.), Conn. Agr. Exp. Sta., Rep. 23, '99, pp. 274-276 (1900).

Black-blight (*Fusarium*, sp. ?).

Blue-stem (*Acrostolagmus caulophagus*, Lawrence.).

Washington Bull. 108, pp. 30, figs. 28 (October, 1912).

Cane-blight (*Coniothyrium Fuckelii*, Sacc.).

Stevens & Hall, Diseases of Economic Plants, p. 177 (1910).

Descr. N. Y. Agr. Exp. Sta., Bull. 107, pp. 305-307 (1899).

Crown-gall (Possibly identical with Crown-gall of Peach, q.v.).

See Ohio Agr. Exp. Sta., Bull. 79, pp. 108-112 (1897).

Fire-blight (Bacterial).

Descr., Ohio Agr. Exp. Sta., Bull. IV-6, pp. 128-129 (1891).

- Leaf-spot (*Septoria rubi*, Westd).
 Mushroom Root-rot (*Armillaria mellea* Vahl).
 Ore. Sta. Bien. Rep. (1911-12).
 Orange-rust (*Gymnoconia interstitialis*).
 Bull. 212, Colo. Exp. Sta. (October, 1915).
 Rust (*Gymnoconia interstitialis* (Schl.) v. Lagerh.).
 Spur-blight (*Sphaerella rubina* Pk.).
 Bull. 212, Colo. Exp. Sta. (October, 1915).
 Wilt (*Leptosphaeria coniothyrium* (Fckl.) Sacc.).

RED GUM

(*Liquidambar styraciflua*, L.)¹

- Sap-rot (*Polystictus versicolor*, (L.) Fr.).
 von Schrenk, Diseases of Deciduous Forest Trees, U. S. Bur. Plant Industry,
 Bull. 149 (1909).

RED TOP

(*Agrostis alba*, L.)

- Sclerotial Disease (*Sclerotium rhizodes*, Auersw.).
 Conn. Exp. Sta., Rep., p. 23 (1914).

RICE

(*Oryza sativa*, L.)

- Blast (*Piricularia oryzae*, Cav.).
 Stevens & Hall, Diseases of Economic Plants, p. 352 (1910).
 Cook, Diseases of Tropical Plants, p. 99 (1913).
 Smut (*Tilletia corona*, Scrib.).
 Descr. Illus., S. Car. Agr. Exp. Sta., Bull. 41, pp. 7-11 (1899).
 Treat. (rec.), S. Car. Agr. Exp. Sta., Bull. 41, pp. 15-29 (1899).

ROSE

(*Rosa* spp.)

- Anthracnose (*Glæosporium rosæ*, Hals.).
 Descr. Illus., N. J. Agr. Exp. Sta., Rep. 14, 1893, pp. 401-405 (1894).
 Cane-blight (*Coniothyrium Fuckelii* Sacc.).
 Downy Mildew (*Peronospora sparsa*, Berk.).
 Occ., N. J. Agr. Exp. Sta., Rep. 13, 1892, p. 282 (1893).

¹VON SCHRENK, HERMANN: Sap-rot and other Diseases of the Red Gum, U. S. Bureau of Plant Industry, Bull. 114, 1907, where all the important diseases are considered.

Leaf-blotch (*Actinonema rosæ* (Lib.), Fr.).

Descr. Illus., U. S. Dep. Agr., Rep. for 1887, pp. 366-368 (1888).

Treat. (pos.), N. J. Agr. Exp. Sta., Rep. 13, 1892, p. 281 (1893).

Leaf-spot (*Sphaerella rosigena*, Ell.).

Occ.

Mildew (*Peronospora sparsa*, Berk.).

Powdery Mildew (*Sphaerotheca pannosa* (Wallr.), Lév.).

Descr., N. J. Agr. Exp. Sta., Rep. 13, 1892, p. 281 (1893).

Treat. (pos.), N. J. Agr. Exp. Sta., Rep. 13, 1892, pp. 281-282 (1893).

Rust (*Phragmidium subcorticium* (Schrank) Wint. and *Ph. speciosum*, Fr.).

Descr. Illus., U. S. Dept. Agr., Rep. for 1887, pp. 369-372 (1888).

Treat. (pos.), See U. S. Dept. Agr., Exp. Sta. Rec., X-7, p. 651 (1899).

Twig-blight (*Botrytis cinerea*, Pers.).

RYE

(*Secale cereale*, L.)

Anthraxnose (*Colletotrichum graminicola* (Ces.) Wilson).

Ergot (*Claviceps purpurea*, (Fr.) Tul.).

Descr. Illus., S. Dak. Agr. Exp. Sta., Bull. 33, pp. 40-43 (1893).

Treat. (rec.), N. C. Agr. Exp. Sta., Bull. 76, p. 20 (1891).

Rust (Black-stem, *Puccinia graminis*, Pers., and Orange-leaf, *P. rubigo-vera* (DC.), Wint.).

See U. S. Dep. Agr., Div. Veg. Phys. & Path., Bull. 16, pp. 42-45 & 60.

Smut (*Urocystis occulta* (Wallr.), Rabh.).

Occ. Illus., Mass. Agr. Exp. Sta., Rep. 9, 1891, p. 247 (1892).

Treat. (pos.), see Oats and Wheat (Smut).

Stem-blight (*Leptosphaeria herpotrichoides*, de Not).

SALSIFY

(*Tragopogon porrifolius*, L.)

Rot (Bacterial).

Descr., N. J. Agr. Exp. Sta., Rep. 11, 1890, p. 351 (1891).

White-rust (*Cystopus tragopogonis*, (Pers.), Schröt.).

Occ., N. J. Agr. Exp. Sta., Rep. 15, 1894, p. 355 (1895).

Rust (*Puccinia tragopogoni* (Pers.), Cda.).

SCRUB PINE

(*Pinus virginiana*, Mill)

Burl Disease (*Cronartium quercus* (Brand.) Schröt.).

Graves, A. H., Phytopathology IV (February, 1914).

Heart-rot (*Trameles pini* (Brot.) Fr.).

Graves, A. H., Phytopathology IV (February, 1914).

Leaf-cast (*Gallowaya pini* (Gall.), Arth.).

Graves, A. H., Phytopathology IV (February, 1914).

Rust (*Colcosporium inconspicuum* (Long), Hedg.).

Graves, A. H., Phytopathology IV (February, 1914).

SHADDOCK OR GRAPE-FRUIT

(*Citrus decumana*, Murr.)

See Lemon and Orange

SNAPDRAGON

(*Antirrhinum majus*, L.)

Anthraxnose (*Colletotrichum antirrhini*, Stewart).

Descr. Illus. Treat. (pos.), N. Y. Agr. Exp. Sta., Bull. 179 (1900).

Root-rot (*Thielavia basicola*, Zopf.).

Rust (*Puccinia antirrhini*, Diet. & Holway.).

Stem-rot (*Phoma* sp.).

Descr. Treat. (rec.), N. Y. Agr. Exp. Sta., Bull. 179, pp. 109-110 (1900).

SORGHUM

(*Sorghum vulgare*, Pers.)

Blight (*Bacillus sorghi*, Burrill).

Descr., Kan. Agr. Exp. Sta., Rep. 1, 1888, pp. 281-301 (1889).

Treat. (rec.), Kan. Agr. Exp. Sta., Rep. 1, 1888, pp. 301-302 (1889).

Head-smut (*Sorosporium reilianum* (Kühn) McAlpine).

Journ. of Agr. Research II, pp. 340-371 (Aug. 15, 1914).

Descr. Illus., Kan. Agr. Exp. Sta., Bull. 23, pp. 95-96 (1891).

Ill. Agr. Exp. Sta., Bull. 47, pp. 374-388 (1897).

Ill. Agr. Exp. Sta., Bull. 57, pp. 335-347 (1900).

Treat. (pos.), Ill. Agr. Exp. Sta., Bull. 57, pp. 345-346 (1900).

Kernel-smut (*Sphacelotheca sorghi*).

Bull. 212, Colo. Agr. Exp. Sta. (October, 1915).

Journ. Agr. Research II, pp. 339-371, pls. 7 (1914).

SOY

(*Soja hispida*, Moench.)

Wilt-disease (*Fusarium tracheiphilum*, E. F. Sm.), Journ. Agric. Res. 8: 421-439,
with 1 pl., Mch. 12, 1917.

SPINACH

(*Spinacia oleracea*, Mill.)

Leaf-blight (*Cercospora beticola*, Sacc.).

Descr., N. J. Agr. Exp. Sta., Rep. 11, 1890, p. 355 (1891).

Cf. N. J. Agr. Exp. Sta., Rep. 18, 1897, p. 303 (1898).

- Miscellaneous
Fungous Diseases. { Anthracnose (*Colletotrichum spinacea*, Ell. & Hals.).
Downy Mildew (*Percnospora effusa*, (Grev.), Rabenh.).
Leaf-spot (*Phyllosticta chenopodii*, Sacc.).
Scab (*Cladosporium macrocarpum*, Preuss.).
White Smut (*Entyloma Ellisii*, Hals.).
- Descr. Illus., N. J. Agr. Exp. Sta., Bull. 70 (1890).
Treat. (rec.), N. J. Agr. Exp. Sta., Bull. 70, pp. 13-14 (1890).

SPRUCE

(Picea spp.)¹

- Blight of Seedlings (*Ascochyta piniperda*, Lindau = *Diplodina parasitica* (Hart, Prill), and *Sclerotinia Fuckeliana*, deBy).
Graves, A. H., Phytopathology IV (April, 1914).
Brown-rot (*Polyporus sulphureus* (Bull.) Fr.).
Dry-rot (*Trametes pini* (Brot.) Fr. and *T. abietis* Karst.).
Heart-rot (*Polyporus borealis* (Wahl.) Fr.).
Atkinson, Bull. 193 (Corn. Univ.) Agr. Exp. Sta. (June, 1901).
Root-rot (*Polyporus Schweinitzii*, Fr.).
Wet-rot (*Polyporus subacidus*, Pk. ?).
- Descr. Illus., U. S. Dep. Agr., Div. Veg. Phys. & Path., Bull. 25 (1900).

SQUASH

(Cucurbita spp.)

- Anthraxnose (*Colletotrichum lagenarium* (Pass.), Ell. & Hals.).
Bacteriosis or Wilt (*Bacillus tracheiphilus*, E. F. Sm.).
Downy Mildew (*Plasmopara cubensis* (Bri. & Cav.), Humph.).
Fruit-mold (*Macrosporium* sp.).
Powdery Mildew (*Erysiphe cichoracearum*, DC. and *E. polygoni*, DC.).
Descr. Illus., See Cucumber (Powdery Mildew).
Treat. (pos.), N. Y. (Corn. Univ.) Agr. Exp. Sta., Bull. 35, p. 330 (1891).
Leaf-spot (*Cercospora cucurbita*, Ell. & Ev.).

STRAWBERRY

(Fragaria spp.)

- Blight (*Micrococcus* sp. ?).
Descr., Mass. Agr. Exp. Sta., Rep. 9, 1896, pp. 59-61 (1897).
Leaf-blotch (*Ascochyta fragariae*, Sacc.).
Descr. Illus., N. Y. (Corn. Univ.) Agr. Exp. Sta., Bull. 14, pp. 182-183 (1889).
Treat. (rec.), N. Y. (Corn. Univ.) Agr. Exp. Sta., Bull. 14, p. 183 (1889).

¹ For species of *Peridermium* on spruce consult Arthur & Kern, North American Species of *Peridermium*, Bull. Torr. Bot. Club 33, pp. 403-438, 1906.

Leaf-spot (*Apospharia* sp.).

Descr. Illus., N. J. Agr. Exp. Sta., Rep. 14, 1893, pp. 329-330 (1894).

Treat. (rec.) N. J. Agr. Exp. Sta., Rep. 14, 1893, pp. 331-332 (1894).

Leaf-spot (*Mycosphaërella fragariæ*, (Tul.) Lindau).

Descr. Illus., U. S. Dep. Agr., Rep. for 1887, pp. 334-339 (1888).

N. Y. (Corn. Univ.) Agr. Exp. Sta., Bull. 14, pp. 171-181 (1889).

Oregon State Biennial Rep. p. 268 (1911-12).

Leaf-spot (*Mycosphaërella fragaria* (Tul.), Lindau).

Treat. (pos.), U. S. Dep. Agr., Rep. for 1890, p. 397 (1890).

Conn. Agr. Exp. Sta., Bull. 115, p. 14 (1893).

Powdery Mildew (*Sphaerotheca Castagnei*, Lév.).

Descr., N. Y. Agr. Exp. Sta., Rep. 5, 1886, pp. 291-292 (1887).

• Descr. Illus., Mass. Agr. Exp. Sta., Rep. 10, 1892, p. 239 (1893).

Treat. (rec.), Mass. Agr. Exp. Sta., Rep. 10, 1892, pp. 243-245 (1893).

Rot (*Sphaeronemella fragariæ*, Stev. & Pet.).

Phytopath. VI, pp. 258-266 (1916).

SUGAR-CANE¹

(*Saccharum officinarum*, L.)

Bundle-blight (*Pseudomonas vascularum* (Cobb.) E. F. Sm.).

Cacao Disease (*Diplodia cacaicola*, Henn).

Cook, Disease of Tropical Plants, p. 85 (1913).

Iliau (*Gnomonia iliau*, Lyon).

Cook, p. 85 (1913).

Phytopath. 3, pp. 93-98 (1913).

Leaf-spot (*Cercospora longipes*, Butler).

Cook, p. 89 (1913).

Miscellaneous Diseases. { *Macrosporium graminum*, Cke.
 { *Uromyces Kühnii* (Krüg.), Wakk. & Went.

Pineapple Disease (*Thielaviopsis ethacetica*, Went).

Red-rot (*Colletotrichum falcatum*, Went).

Rind Disease (*Trichosphaeria sacchari*, Mass.).

See U. S. Dept. Agr., Exp. Sta. Rec., X, pp. 56-57, '98, and XI, p. 759 (1900).

Ring-spot (*Leptosphaeria sacchari*, de Haan).

Cook, p. 89 (1913).

Smut (*Ustilago sacchari*, Rabenh.).

Stool Disease (*Marasmius sacchari*, Wakker).

Cook, p. 92 (1913).

¹ Cf. EDGERTON, C. W.: Some Sugar-cane Diseases, Bull. 120, La. Agric. Exper. Sta., July, 1910; COBB, N. A.: Fungous Maladies of the Sugar Cane, Bull. 6, Exper. Sta., Hawaiian Sugar Planters Assoc., 1906.

SUNFLOWER

*(Helianthus annuus, L.)*Black-rot (*Sphaeronema fimbriatum* (Ell. & Hals.) Sacc.).

Duggar, p. 348 (1909).

Dry-rot (*Phoma batatae*, Ell. & Hals.).

Duggar, p. 344 (1909).

Root-rot (*Corticium vagum*, B. & C. var. *solani*, Burt.).

Duggar, p. 444 (1909).

Rust (*Puccinia helianthi*, Schw.).

SWEET PEA

*(Lathyrus odoratus, L.)¹*Anthracnose (*Glomerella rufomaculans* (Berk.), Spauld. & v. Schr.).Powdery Mildew (*Erysiphe polygoni* DC.).Root-rot (*Thielavia basicola*, Zopf.; *Rhizoctonia* (*Corticium vagum*, Bri. & Cav. var. *solani* Burt); *Chaetomium spirochate*, Pall.; *Fusarium lathyri*, Taub. & Manns).Stem or Collar-rot (*Sclerotinia libertiana*, Fckl.).Streak (*Bacillus lathyrii*, Manns & Taub.).

SWEET POTATO

*(Ipomoea batatas, Lam.)*Black-rot (*Sphaeronema* (*Ceratocystis*) *fimbriata* (Ell. & Hals.), Sacc.).

Descr. Illus., N. Y. Agr. Exp. Sta., Bull. 76, pp. 7-13 (1890).

Journ. Mycol., Vol. VII, pp. 1-9 (1891).

Treat. (pos.), Md. Bull. 60, pp. 147-168, figs. 17 (March, 1899).

(rec.), U. S. Dept. Agr., Farm. Bull. 26, p. 21 (1895).

Charcoal-rot (*Sclerotium bataticola*, Taub.).

Phytopathology 3, p. 161 (1913).

Foot-rot (*Plenodomus destruens*, Hart.).

Phytopathology. 3, pp. 242-245 (1913).

Taubenhaus & Manns, Bull. 109, Del. Agr. Exp. Sta., May, 1915.

Journ. Agr. Research I, p. 251

Java-rot (*Lasiodiplodia tubericola*, Ell. & Ev.).Soil-rot (*Acrocystis batatae*, Ell. & Hals.).

Descr. Illus., N. J. Agr. Exp. Sta., Bull. 76, pp. 14-18 (1890).

Treat. (pos.), N. J. Agr. Exp. Sta., Rep. 20, 1899, pp. 345-354.

N. J. Spec. Bull. 5, February, 1900, pp. 22-31, pls. 3 (1900).

¹ Consult TAUBENHAUS, J. J.: The Diseases of the Sweet Pea, Bull. 106, Del. Agric. Exper. Sta., November, 1914.

Stem-rot (*Fusarium hyperoxysporum* Wollenw.).

U. S. Farmers' Bull. 714, March 11, 1916.

Phytopath. 4, pp. 277-303 (1914).

Miscellaneous
Diseases.

Dry-rot (*Phoma batatae*, Ell. & Hals. conidial stage of *Diaporthe batatalis* (Ell. & Hals.), Hart & Field).

Leaf-spot (*Phyllosticta bataticola*, Ell. & Mart.).

U. S. Farmers' Bull. 711.

Scurf (*Monilochaetes infuscans* (Ell. & Hals.) Hart).

N. J. Bull. 76, pp. 25-27 (Nov., 1890).

Soft-rot (*Rhizopus nigricans*, Ehrb.).

Phytopath. 4, pp. 305-320.

Trichoderma Rot (*Trichoderma Koningi*, Oud.).

Taubenhaus & Manns, Bull. 109, Del. Agr. Exp. Sta., May, 1915.

White-rot (*Penicillium* sp.).

White-rust (*Cystopus ipomæe-panduranæ* (Schw.), Farl.).

Descr. Illus., N. J. Agr. Exp. Sta., Bull. 76 (1890).

Md. Agr. Exp. Sta., Bull. 60 (1899).

Treat. (rec.), U. S. Dept. Agr., Farm. Bull. 26 (1895).

Vine-wilt (*Fusarium batatalis*, Wollenw.).

Taubenhaus and Manns, Bull. 109, Del. Agr. Exp. Sta., May, 1915.

Wollenweber, H. W., Journ. Agr. Research 2, pp. 251-283 (1911).

SYCAMORE

(*Platanus occidentalis*, L.)

Anthracnose (*Glaeosporium nervisequum* (Fckl.), Sacc., stage of *Gnomonia veneta* (Sacc. & Speg.) Kleb.).

Blight (*Gnomonia veneta* (Sacc. & Speg.), Kleb.).

Descr. Illus., U. S. Dep. Agr., Rep. for 1888, pp. 387-389 (1889).

Treat. (rec.), U. S. Dep. Agr., Rep. for 1888, p. 389 (1889).

Cf. Journ. Mycol., Vol. V, pp. 51-52.

Gar. and For., X-488, pp. 257-258.

TEA

(*Thea chinensis*)¹

Bark Disease (*Corticium javanicum*, Zimm. = *C. Zimmermani*, Sacc. & Syd.).

Blisters-blight (*Exobasidium vexans*, Masec.).

Copper-blight (*Loestadia theae*, Show).

Grey-blight (*Pestalozzia guepini*, Desm.).

Horsehair-blight (*Marasmius sarmentosus*, Berk.).

Internal Stem Disease (*Massaria theicola*, Petch.).

Red-rust (*Cephalosporium mycoidea*, Karst.).

¹ For all consult Cook, Diseases of Tropical Plants, pp. 170-180 (1913).

- Root Fungus (*Rosellinia radiciperda*, Masec.).
 Soot-blight (*Capnodium Footii* Berk. and Desm.).
 Thread-blight (*Stilbum nanum*, Masec.).

TEOSINTE

(*Euchlæna mexicana*, Schrod.)

- Smut (*Ustilago zeæ* (Beckm.), Ung.).

TIMBER

- Decay (*Stereum frustulosum* (Pers.), Fr.).
 von Schrenk, Diseases of Deciduous Forest Trees, U. S. Bureau of Plant Industry,
 Bull. 149 (1909).
 Sap-rot (*Dadalea quercina* (L.), Pers.).
 Mainly on oak timber, von Schrenk (1909).

TIMOTHY

(*Phleum pratense*, L.)

- Ergot (*Claviceps purpurea* (Fr.), Tul.).
 Phytopath. 4, pp. 20-22 (1914).
 Rust (*Puccinia phlei-pratensis*, Eriks & Henn.)
 Phytopath. 4, pp. 20-22 (1914).
 Smut (*Ustilago striæformis* (West.), Niessl.).

TOBACCO

(*Nicotiana tabacum*, L.)

- Black-rot (*Sterigmatocystis nigra* v. Tieg.).
 Wisc. Res. Bull. 32, pp. 63-83, figs. 7 (June, 1914).
 Blue Mold (*Fungus indet.*).
 Brown-spot (*Macrosporium longipes*, Ell. & Ev.)
 Descr., Journ. Mycol., Vol. VII, p. 134 (1892).
 Cf. U. S. Dept. Agr., Exp. Sta. Rec., XII-4, p. 359 (1900).
 "Damping-off" (*Alternaria tenuis*, Nees).
 Downy Mildew { (*Peronospora hyoscyami*, deBy.).
 { (*Phytophthora nicotianæ*, de Haan).
 Leaf-blight (*Cercospora nicotianæ*, Ell. & Ev.).
 Descr. Illus., Conn. Agr. Exp. Sta., Rep. 20, 1896, pp. 273-277 (1897).
 Treat. (rec.), Conn. Agr. Exp. Sta., Rep. 20, 1896, pp. 277-278 (1897).
 Mosaic, Bull. U. S. Dept. Agr., p. 40 (1914).

Pole-burn (*Fungi and Bacteria*).

Descr., Conn. Agr. Exp. Sta., Rep. 15, 1891, pp. 168-173 (1892).

Descr., Conn. Agr. Exp. Sta., Rep. 17, 1893, pp. 84-85 (1894).

Treat. (rec.), Conn. Agr. Exp. Sta., Rep. 15, 1891, pp. 180-184 (1892).

Powdery Mildew (*Erysiphe cichoraccarum*, DC., Syn. *E. lamprocarpa* (Wallr.), Lév.).Root-rot (*Thielavia basicola*, Zopf.).

Gilbert, W. W., Bull. 158, U. S. Bur. of Plant Industry (1909).

Conn. Rep., pt. 5, p. 342 (1906.)

Phytopath. 6, pp. 167-181 (1916).

Stem-rot (*Botrytis longibrachiata*, Oud.).

Cook, Diseases of Tropical Plants, p. 149 (1913).

Descr., Conn. Agr. Exp. Sta., Rep. 15, 1891, pp. 184-185 (1892).

Treat. (rec.), Conn. Agr. Exp. Sta., Rep. 15, 1891, pp. 185-186 (1892).

White-speck (*Macrosporium tabacinum*, Ell. & Ev.).

Descr., Journ. Mycol., Vol. VII, p. 134 (1892).

Cf. Conn. Agr. Exp. Sta., Rep. 20, 1896, p. 276 (1897).

TOMATO

(*Lycopersicum esculentum*, Mill.)Anthracnose (*Colletotrichum phomoides* (Sacc.), Chester).

Descr. Illus., Del. Agr. Exp. Sta., Rep. 4, 1891, pp. 60-62 (1892).

Cf. Del. Agr. Exp. Sta., Rep. 6, 1893, pp. 111-115 (1894).

Nebr. Rep., 1907, pp. 1-33, figs. 33.

Treat. (rec.), Me. Agr. Exp. Sta., Rep. for 1893, p. 155 (1894).

Blight (*Pseudomonas solanacearum*, E. F. Sm.).

Descr. Illus., See Egg-plant (Blight).

La. Bull. 142, pp. 1-23, figs. 3 (October, 1913).

Treat. (pos.), Md. Agr. Exp. Sta., Bull. 54, pp. 123-125 (1898).

Fla. Agr. Exp. Sta., Bull. 47, pp. 133-136 (1898).

Blight (*Sclerotium* sp.).

Descr., Fla. Agr. Exp. Sta., Bull. 21, pp. 25-27 (1893).

Ala. Agr. Exp. Sta., Bull. 108, pp. 28-29 (1900).

Treat. (pos.), Fla. Agr. Exp. Sta., Bull. 21, pp. 32-36 (1893).

Downy Mildew (*Phytophthora infestans* (Mont.), deBy.).Fruit-rot (*Macrosporium solani*, E. & M. and *Phoma destructiva*, (Plowr.), Jamies.)

Descr., Ala. Agr. Exp. Sta., Bull. 108, pp. 19-25 (1900).

Cf. N. Y. Agr. Exp. Sta., Rep. 3, 1884, pp. 379-380. 1885.

Cf. N. Y. Agr. Exp. Sta., Bull. 125, pp. 305-306. 1897.

Journ. Agr. Research 4, p. 1 (April 15, 1915).

Leaf-blight (*Cylindrosporium* sp.).

Descr., N. Y. Agr. Exp. Sta., Rep. 14, 1895, p. 529 (1896).

Treat. (rec.), N. Y. Agr. Exp. Sta., Rep. 14, 1895, pp. 530-531 (1896).

Leaf-mold (*Alternaria solani* (Ell. & Mart.), Jones & Grout.).

- Descr., Fla. Agr. Exp. Sta., Bull. 47, pp. 124-125 (1898).
 Treat. (pos.), Fla. Agr. Exp. Sta., Bull. 47, pp. 125-127 (1898).
 Leaf-spot (*Septoria lycopersici*, Speg.).
 Descr. Illus., Del. Agr. Exp. Sta., Rep. 7, 1894-95, p. 123 (1895).
 Ohio Agr. Exp. Sta., Bull. 73, p. 241 (1897).
 Treat. (pos.), Va. Bull. 192, pp. 16, figs. 9 (April, 1911).
 Ala. Agr. Exp. Sta., Bull. 108, pp. 32-33 (1900).
 Rust (*Macrosporium solani*, Ell. & Mart.).
 Stevens & Hall, Diseases of Economic Plants, p. 312 (1910).
 Scab (*Cladosporium fulvum*, Cke.).
 Descr. Illus., U. S. Dep. Agr., Rep. for 1888, pp. 347-348 (1889).
 Treat. (pos.), U. S. Dep. Agr., Sec. Veg. Path., Bull. 11, p. 47 (1890).
 Ala. Agr. Exp. Sta., Bull. 108, p. 33 (1900).
 Wilt (*Fusarium lycopersici*, Sacc.).

TRUMPET CREEPER

(*Tecoma radicans* (L.) Jass.)

- Leaf-blight (*Cercospora sordida*, Sacc.).
 Duggar, p. 315 (1909).
 Leaf-spot (*Septoria tecomæ*, Ell. & Ev.).

TULIP TREE

(*Liriodendron tulipifera*, L.)

- Leaf-blight (*Glaosporium liriodendri*, Ell. & Ev.).
 Sap-rot (*Polystictus versicolor* (L.), Fr.).
 von Schrenk, H., Diseases of Deciduous Forest Trees, U. S. Bur. of Plant Industry, Bull. 149 (1909).

TURNIP

(*Brassica campestris*, L. and *B. rapa*, Linn.)

- Brown-rot (*Pseudomonas campestris* (Pam.), E. F. Sm.).
 Descr. Illus., Iowa Agr. Exp. Sta., Bull. 27, pp. 130-134 (1895).
 Club-root (*Plasmodiophora brassicæ*, Wor.).
 Descr. Illus., See Cabbage (Club-root).
 Treat. (pos.), N. J. Agr. Exp. Sta., Rep. 20, '99, pp. 354-367 (1900).
 Downy Mildew (*Peronospora parasitica* (Pers.) deBy.).
 Occ., Mass. Agr. Exp. Sta., Rep. 8, 1890, p. 222 (1891).
 Treat. (rec.), Mass. Agr. Exp. Sta., Rep. 8, 1890, p. 223 (1891).
 Dry-rot (*Phoma brassicæ*, Thüm ?).
 See U. S. Dept. Agr., Exp. Sta. Rec., XII-3, p. 256 (1900).
 Conn. Exp. Sta., Rep., p. 355 (1912).

Leaf-mold (*Macrosporium herculcum*, E. & M.).

Descr. Illus., N. Y. Agr. Exp. Sta., Rep. 15, '96, pp. 451-452 (1897).

Powdery Mildew (*Erysiphe polygoni*, DC.).

Occ., N. Y. (Corn. Univ.) Agr. Exp. Sta., Bull. 61, pp. 305-306 (1893).

White-rust (*Cystopus candidus*, (Pers.) Lév.).

Occ., Mass. Agr. Exp. Sta., Rep. 8, 1890, p. 222 (1891).

Treat. (rec.), Mass. Agr. Exp. Sta., Rep. 8, 1890, p. 223 (1891).

TREE OF HEAVEN

(*Ailanthus glandulosa*, Desf.)

Shot-hole (*Cercospora glandulosa*, Ell. & Kell.).

VERBENA

(*Verbena* sp.)

Powdery Mildew (*Erysiphe cichoraccarum*, DC.).

Occ., N. Y. (Corn. Univ.) Agr. Exp. Sta., Bull. 37, p. 405 (1891).

Treat. (pos.), N. Y. (Corn. Univ.) Agr. Exp. Sta., Bull. 37, p. 405 (1891).

VETCH

(*Vicia* spp.)

Powdery Mildew (*Erysiphe polygoni*, DC.).

Duggar, p. 227 (1909).

Rust (*Uromyces pisi* (Pers.) de By).

Duggar, p. 398 (1909).

VIOLET

(*Viola odorata*, L. and *V. tricolor*, L.)

Anthraxnose (*Glaeosporium violæ*, B. & Br.).

Occ., N. J. Agr. Exp. Sta., Rep. 11, 1890, p. 362 (1891).

Anthraxnose (*Colletotrichum violæ-tricoloris*, Smith).

Descr., Mass. Agr. Exp. Sta., Rep. 11, '98, pp. 152-153 (1899).

Treat. (pos.), Mass. Agr. Exp. Sta., Rep. 11, '98, p. 153 (1899).

Gall or Chytridiose (*Cladochytrium violæ*, Berl.).

See U. S. Dep. Agr., Exp. Sta. Rec., XI-3, p. 261 (1899).

Downy Mildew (*Peconospora violæ*, de By.).

Occ., N. J. Agr. Exp. Sta., Rep. 11, 1890, p. 362 (1891).

Dry-rot (*Merulius lacrymans* (Jacq.) Fr.).

See U. S. Dep. Agr., Exp. Sta. Rec., XI-10, p. 947 (1900).

Leaf-blight (*Cercospora violæ*, Sacc.).

Occ. Illus., N. J. Agr. Exp. Sta., Rep. 15, 1894, pp. 384-386 (1895).

Treat. (rec.) N. J. Agr. Exp. Sta., Rep. 15, 1894, pp. 386-389 (1895).

Leaf-mold or Spot Disease (*Alternaria viola*, Gall. & Dors.).

Descr. Illus. Treat., U. S. Dep. Agr., Div. Veg. Phys. & Path., Bull. 23 (1900).

Leaf-spot (*Phyllosticta viola*, Desm. and *Alternaria viola*, Gall. & Dors.).

Descr., Mass. Agr. Exp. Sta., Rep. 10, 1892, pp. 231-232 (1893).

Treat. (rec.) Mass. Agr. Exp. Sta., Rep. 10, 1892, pp. 232-235 (1893).

N. J. Agr. Exp. Sta. Rep. 15, 1894, pp. 286-389 (1895).

Root-rot (*Thielavia basicola*, Zopf).

Descr. Conn. Agr. Exp. Sta., Rep. 15, 1891, pp. 166-167 (1892).

White Mold (*Zygodescmus albidus*, Ell. & Hals.).

Occ., N. J. Agr. Exp. Sta., Rep. 11, 1890, p. 362 (1891).

VIRGINIA CREEPER

(*Ampelopsis quinquefolia*, Michx.)

Leaf-spot (*Phyllosticta ampelopsidis*, E. & M.) = *Laestadia Bidwellii* (Ell.). V. & R.

WALNUT

(*Juglans regia*, L.)

Bacteriosis (*Pseudomonas juglandis*, Pierce).

Ore. Sta. Rep., p. 260 (1911-12).

See U. S. Dep. Agr., Exp. Sta. Rec., Vol. XI, p. 261 (1899).

Cal. Bull. 231, pp. 320-383, figs. 19 (August, 1912).

Leaf-blight (*Marsonia juglandis* (Lib.) Sacc. of *Gnomonia leptostyla* (Fr.) Ces. & deN.

Leaf-spot (*Ascochyta juglandis*, Boltsh. and *Phleospora multumaculans*, Heald & Wolf).

Leaf Disease (*Cylindrosporium juglandis*, Wolf.)

Mycologisches Centralblatt 4, p. 65 (1914).

WATERMELON

(*Citrullus vulgaris*, Schrad.)

Anthraxnose (*Colletotrichum lagenarium* (Pass.), Ell. & Hals.).

Occ., N. J. Agr. Exp. Sta., Rep. 13, 1892, p. 326 (1893).

Treat. (neg.), Del. Agr. Exp. Sta., Rep. 5, 1892, p. 79 (1893).

Cf. N. J. Agr. Exp. Sta., Rep. 13, pp. 326-330 (1892).

Del. Agr. Exp. Sta., Rep. 5, pp. 75-79 (1892).

Downy Mildew (*Plasmopara cubensis* (Bri. & Cav.), Humph.).

See Cucumber (Downy Mildew).

Leaf-blight (*Cercospora citrullina*, Cke.).

Occ., Ohio Agr. Exp. Sta., Bull. 105, p. 232 (1899).

Leaf-mold (*Alternaria brassicae*, Sacc., var. *nigrescens*, Regel.).

See Melon (Leaf-mold).

Leaf-spot (*Phyllosticta* sp. and (?) *Sphaerella* sp.).

Descr. Illus., Del. Agr. Exp. Sta., Rep. 5, 1892, pp. 75-78 (1893).

WHEAT

(Triticum vulgare, L.)

- Blight (*Myrothecium abrodens*, Neum.).
 Chytridiosis (*Pyroctonus sphaericum*, Prunet).
 See U. S. Dept. Agr., Exp. Sta. Rec., VI-3, pp. 226-227 (1894).
 Ergot (*Claviceps purpurea*, (Fr.) Tul.).
 See Rye (Ergot).
 Foot-rot (*Ophiobolus* & *Leptosphaeria*).
 See U. S. Dept. Agr., Exp. Sta. Rec., IX-11, p. 1057 (1898).
 U. S. Dept. Agr., Exp. Sta. Rec., X-7, p. 650 (1899).
 Leaf-spot (*Leptosphaeria eustoma* (Fr.), Sacc., var. *tritici*, Garov.).
 Leaf-spot (*Septoria graminum*, Desm.).
 See U. S. Dept. Agr., Exp. Sta. Rec., X-5, p. 452 (1899).
 Mildew (*Erysiphe graminis*, DC.).
 Iowa Bull. 104, pp. 245-248 (July, 1909).
 Mold (*Cladosporium herbarum* (Pers.), Lk.).
 Rust (Black-stem, *Puccinia graminis*, Pers. and Orange-leaf, *P. rubigo-vera* (DC.),
 Wint., also *P. glumarum* (Schum.), Eriks. & Henn.).
 Descr. Illus., Ind. Agr. Exp. Sta., Bull. 26 (1889).
 Kan. Agr. Exp. Sta., Bull. 38, pp. 1-3 (1893).
 Treat. (rec.), Idaho Agr. Exp. Sta., Bull. 11, pp. 33-34 (1898).
 Cf. U. S. Dept. Agr., Div. Veg. Phys. & Path., Bull. 16 (1899).
 Scab (*Cladosporium herbarum* (Pers.), Lk.).
 Scab (*Fusarium culmorum* (E. F. Sm.), Sacc. = *F. rubiginosum*, Appel & Wollenw.).
 Descr. Illus., Del. Agr. Exp. Sta., Rep. 3, 1890, pp. 89-90 (1891).
 Ohio Agr. Exp. Sta., Bull. 44, pp. 147-148 (1892).
 Scab (*Gibberella Saubenelii* (Mont.), Sacc., Stage of *Fusarium roscum*, Lk.).
 Descr. Illus., Ohio Agr. Exp. Sta., Bull. 97, pp. 40-42 (1898).
 Stinking-smut (*Tilletia foetens* (Bri. & Cav.), Schrt., *T. tritici* (Bjerk.), Wint.).
 Phytopath. 6, pp. 21-28 (1916).
 Loose-smut (*Ustilago tritici* (Pers.), Jens.).
 Descr. Illus., Kan. Agr. Exp. Sta., Rep. 2, 1889, pp. 261-267 (1890).
 N. Dak. Agr. Exp. Sta., Bull. 1, pp. 9-20 (1891).
 U. S. Dept. Agr., Farm. Bull. 75, pp. 6-8 (1898).
 Treat. (pos.), Ohio Agr. Exp. Sta., Bull. 97, pp. 60-61 (1898).
 U. S. Dept. Agr., Farm. Bull. 75, pp. 11-14 (1898).

WILLOW

(Salix spp.)

- Black-spot (*Rhytisma salicinum* (Pers.), Fr.).
 Duggar, p. 209 (1909).
 Crown-gall (*Pseudomonas tumefaciens*, E. F. Sm. & Towns.).
 Duggar, p. 114 (1909).

Decay, or Brown-rot (*Polyporus sulphureus* (Bull.), Fr.).

Duggar, p. 457 (1909).

Powdery Mildew (*Uncinula salicis* (DC.), Wint.).

Duggar, p. 230 (1909).

White-rot (*Polyporus squamosus* (Huds.), Fr.).

Duggar, p. 453 (1909).

Rust (*Mcclampsora salicicapræ* (Pers.), Wint.) = *M. farinosa* (Pers.), Schröt.

ZINNIA

(*Crassina elegans* (Jacq.) Kze.)

Leaf-spot (*Cercospora atricineta*, Heald & Wolf).

Heald & Wolf, Plant Disease Survey in Texas (1912).

BIBLIOGRAPHY OF SPECIFIC PLANT DISEASES

That the foregoing list may be made as useful to American students as possible, a partial bibliography of some of the publications dealing with specific diseases of our economic plants is herewith given.

ARTHUR, JOSEPH C. and KERN, F. D.: North American Species of Peridermium on Pine. *Mycologia*, vi: 109-138, May, 1914.

CLINTON, G. P.: The Smuts of Illinois Agricultural Plants. Univ. Ill. Agric. Exper. Sta., Bull. 57, March, 1900.

COOK, MEL T.: Potato Diseases in New Jersey, N. J. Agric. Exper. Sta., Circular 33.

COOK, MEL T.: Common Diseases of the Peach, Plum and Cherry. N. J. Agric. Exper. Sta., Circular 45.

COOK, MEL T.: Common Diseases of Apples, Pears and Quinces. N. J. Agric. Exper. Sta., Circular 44.

DUGGAR, B. M.: Some Important Pear Diseases. Cornell Univ. Agric. Exper. Sta., Bull. 145, February, 1898.

DUGGAR, B. M.: Three Important Fungous Diseases of the Sugar Beet. Cornell Univ. Agric. Exper. Sta., Bull. 163, February, 1899.

EDGERTON, C. W.: Some Sugar Cane Diseases. La. Agric. Exper. Sta., Bull. 120, 1910.

EDGERTON, C. W.: Disease of the Fig Tree and Fruit. La. Agric. Exper. Sta., Bull. 126, March, 1911.

FREEMAN, E. M., and JOHNSON, E. C.: The Loose Smuts of Barley and Wheat. U. S. Bureau of Plant Industry, Bull. 152, 1909.

FREEMAN, E. M., and JOHNSON, E. C.: The Rusts of Grain in the United States, U. S. Bureau of Plant Industry, Bull. 216, 1916.

FREEMAN, E. M. and STAKMAN, E. C.: The Smuts of Grain Crops. Minn. Agric. Exper. Sta., Bull. 122, February, 1911.

HARTER, L. L.: Sweet Potato Diseases. U. S. Farmers' Bull. 714, March 11, 1916.

HESLER, Lex R., and WHETZL, HERBERT H.: Manual of Fruit Diseases, 1917. The MacMillan Co.

- JOHNSON, E. C.: Timothy Rust in the United States. U. S. Bureau of Plant Industry, Bull. 224, 1911.
- ORTON, W. A.: Some Diseases of the Cowpea. U. S. Bureau of Plant Industry, Bull. 17, 1902.
- ORTON, W. A.: Tomato Diseases, from Tomato Culture by WILL W. TRACY, 1907, Orange Judd Co.
- ORTON, W. A.: Potato Tuber Diseases. U. S. Farmers' Bull. 544, 1913.
- POOL, VENUS W.: Some Tomato Fruit Rots during 1907, 1908.
- REED, HOWARD S. and CRABILL, C. H.: Notes on Plant Diseases in Virginia observed in 1913 and 1914. Va. Agric. Exper. Sta., Tech. Bull. 2, April, 1915.
- SELBY, A. D.: Some Diseases of Orchard and Garden Fruits. Ohio Agric. Exper. Sta., Bull. 79, 1897.
- SELBY, A. D.: Prevalent Diseases of Cucumbers, Melons and Tomatoes. Ohio Agric. Exper. Sta., Bull. 89, December, 1897.
- SHEAR, C. L.: Cranberry Diseases. U. S. Bureau of Plant Industry, Bull. 110, 1907.
- STEVENS, F. L.: Fungous Diseases of Apple and Pear. N. C. Agric. Exper. Sta., Bull. 206, March, 1910.
- STONE, GEO. E.: Tomato Disease. Mass. Agric. Exper. Sta., Bull. 38, June, 1911.
- TAUBENHAUS, J. J.: Diseases of the Sweet Pea. Del. Agric. Exper. Sta., Bull. 106, November, 1914.
- VON SCHRENK, HERMANN: Two Diseases of Red Cedar caused by *Polyporus juniperinus* and *P. carneus*. U. S. Div. Veg. Physiol. & Pathol., Bull. 21, 1900.
- VON SCHRENK, HERMANN: The Decay of Timber and Methods of Preventing It. U. S. Bureau of Plant Industry, Bull. 14, 1902.
- VON SCHRENK, HERMANN, and SPAULDING, PERLEY: The Bitter Rot of Apples. U. S. Bureau of Plant Industry, Bull. 44, 1903.
- WILCOX, E. MEAD: Diseases of Sweet Potatoes in Alabama. Agric. Exper. Sta. of the Ala. Polytechnic Institute, Bull. 35, June, 1906.

CHAPTER XXXIV

DETAILED ACCOUNT OF SPECIFIC DISEASES OF PLANTS

This section of the book will be devoted to a consideration of the specific diseases of plants, and the treatment of the subject has been made possible by a selection of nearly 100 parasitic and non-parasitic diseases. In this selection, several things have been kept in view, viz., the importance of the disease over wide geographic areas, the systematic relationship of the fungus in order to connect up the practical and the systematic parts of the book, because our knowledge of the disease warrants its inclusion in the descriptive part which follows. As a consideration of the remedial measures used to combat the disease was omitted largely in the description of plant diseases in general, it is introduced incidentally with the study of specific plant diseases. The chief reference to such remedial substances and their use will be found in one of the appendices in the back of the book, where the manufacture of sprays and washes and their recommended use may best be made with the consideration of a spray calendar. A regular spraying program is now considered a necessity by every successful plant-grower, the expense of which, treated as insurance, can no more be escaped than the outlay for cultivation, manures, or pruning. In the control of plant enemies, including both insect pests and fungous parasites, there are essential points in practice which may not be evaded or neglected, namely: To spray at the correct time (hence the need of a calendar) to use the proper form and strength of spray (hence the need of formulæ) and to make a thorough covering of the parts sprayed. Hence that important branch of phytopathology known as therapeutics will be mentioned incidentally in part III and treated in detail in the latter part of part IV.

The description of each disease will be given in condensed form purposely, so that the student of plant pathology who wants to know more about the specific diseases of some particular crop in which his interest has been aroused will be compelled to study the literature and thus gain

access to the most important work which has been done. In this investigation, the student should write descriptions of the diseased host plants and parasitic organisms concerned, according to the method outlined in part IV, pages 639 to 642, and together with this detailed description he should compile a bibliography.

Pedagogically it is a mistake to give too full details in a text-book, because the student learns to depend on the statements in the book rather than on original observations of his own. The compilation of a bibliography becomes an important adjunct to all successful phytopathologic work. "Study things, not books" is a truism in this department of scientific knowledge, as in other departments of natural science. The teacher should so guide and stimulate the class of students that each member of the class will be led to independent study and investigation, so that they may be able to apply individually the modicum of knowledge which the strictures of the time allotted to the subject in the college has permitted them to obtain. Unless this independence of thought and action is secured, the results of the teaching have not been satisfactory. It is, therefore, hoped by the writer of this text-book that what has been included in its pages will be directive and helpful to teacher and student rather than a work of encyclopedic value. The subject of phytopathology is such a vast one, that it would be impossible without the coöperation of a large number of specialists to make a work which would be of encyclopedic value. The design of this text-book has been to give an outline of the subject, so that the attention of the student may be directed to the important phases of the subject of phytopathology.

Alfalfa (*Medicago sativa* L.)

Leaf-spot (*Pseudopeziza medicaginis* (Lib.), Sacc.).—The fungus which causes this widely prevalent disease, where alfalfa is grown, belongs to a genus in which the apothecium is formed beneath the epidermis and as it grows it breaks through the epidermal covering and emerges as a shallow, relatively simple structure with asci that contain eight one-celled spores. It is related to a similar fungus *Ps. trifolii*, which attacks the leaves of clovers. It forms small brown, or black, spots on the upper leaf surface usually. These spots, which are about 2 mm. in diameter, represent the sessile apothecia, which are sprinkled pretty copiously over the leaf surface in the latter part of summer.

The unicellular spores measure 10 to 14 μ in length. No practical method has been devised for controlling the alfalfa leaf-spot disease.

Rust (*Uromyces striatus* Schröt.).—The æcidia of this rust are found on *Euphorbia cyparissias* in Europe and in Great Britain the uredinea and telia occur on a clover *Trifolium minus*. In California, it forms reddish-brown, dusty pustules on the surfaces of alfalfa leaves and in wet weather it may be destructive to the crop, but in dry weather it usually disappears. The spots are on close examination seen to be cinnamon-colored, due to the presence of globose to ellipsoid, faintly echinulate, yellowish-brown uredospores, which measure 15 to 22 μ with a spore wall 1 to 2 μ thick, and with four to six germ pores each with a small cap. The telia are darker in color, and the teliospores are globose to ovate with a minute papilla striated from apex to base with lines of brown warts and measure 18 to 24 by 15 to 20 μ with an epispore 1½ to 2 μ thick. The best way of combating this disease is to cut and burn badly affected crops. Frequent close mowing is useful in checking leaf-spot.

Apple (*Pyrus malus* L.)

Bitter-rot (*Glomerella cingulata* (Stonem.) S. & V. S.).—This fungus, which in some text-books is known as *G. rufomaculans* (Berk.) Spauld. & von Sch., causes one of the most serious losses in the apple-growing districts of the United States (Fig. 190). It is distributed widely, particularly eastward of the arid portions of the country and its effects are seen during July and August and later, especially during warm rainy weather, which produce sultry conditions of the atmosphere, when the age of the fruits is such as to render them especially susceptible. Cold weather acts as a check to the spread of the disease. The fruit is attacked chiefly, but the branches may also become diseased.

The disease first appears as a small brown spot beneath the skin of the apple, which increases gradually in size, keeping nearly a circular outline with a well-defined margin. The central part of the spot soon becomes sunken and this is accompanied by the spread of the fungus throughout the fruit and the formation of pustules. Decay soon sets in and the products of the decay are invariably bitter. The fruits, if attacked on the tree, later fall off, but sometimes, they hang on and become mummified. Two stages in the life history of the fungus have

been discovered. The gleosporial, or imperfect stage, usually develops on the fruit, while the ascigeral stage is occasionally produced on a fruit or twig, and in artificial cultures is readily obtained. Early infection of the fruit is probably due to the spores produced in pustules on the areas of stem, which have become cankered through the attack of the bitter-rot mycelium. Such cankers are sunken areas upon twigs or limbs, accompanied by a cracking and breaking of the bark over such regions. The pustules, which accompany the rot of the fruit, are formed beneath the apple skin as condensed masses of the mycelium known as stroma and these emerge as a cone-shaped mass of erect hyphæ, which are the conidiophores, which cut off conidiospores that emerge as a pink waxy strand, later becoming of a gray color. The ovate to oblong conidiospores, which measure in extreme cases 6 to 40 by 3.5 to 7 μ , more usually 12 to 16 by 4 to 6 μ , are imbedded in a gelatinous matrix which dissolves in water setting the spores free. These spores germinate freely and become septate in doing so. Infection of apple fruits may be through the uninjured skin, but a slight abrasion facilitates the entrance of the germ tube of the spore. Berkeley, who first described this stage, named it *Gleosporium fructigenum* and under this scientific name the disease is frequently quoted.

Clinton discovered the perithecial stage in 1902, and as it is readily obtained in cultures on any of the ordinary nutrient media its characteristics are well-known. The perithecia which are developed contain oblong-clavate asci, 55 to 70 by 9 μ , which develop eight curved ascospores, usually uniform in size, 12 to 22 by 3.5 to 5 μ . The pomologist, who wishes to control the disease, should prune away all cankered limbs and keep the orchard free of diseased fruits. The spraying of the trees with Bordeaux or lime-sulphur (3-3-50) has been found efficacious, and the crop returns from sprayed trees, as contrasted with unsprayed trees, have abundantly repaid the trouble which the orchardist has taken in the application of Bordeaux mixture. The first application of the spray should be in the form of a mist about a month after the petals have fallen and subsequent applications should be made about two weeks apart until at least five sprayings have been made.

Black-rot (*Sphæroopsis malorum* Berk.).—Although the apple is one of its host plants, the black rot fungus attacks other pomaceous trees, producing cankers so that the description of the disease and fungus, as applied to the apple, will serve with certain modifications for

the other pomaceous trees as well, and this may be said of several of the other diseases treated of here that the description of a disease as specifically affecting a certain host, might equally apply to several other host plants. The black-rot fungus not only causes a fruit decay of apples, quinces and pears, but it causes the formation of canker on the limbs of these trees. The fruit rot is the generally recognized form of the disease. The disease begins as a small spot sometimes near the bud end of the fruit and it spreads until the whole fruit is involved. The apples do not shrink, as in the former disease. The canker form of the disease on the bark of the trees is accompanied by either a roughening of the bark in mild forms of the disease, or in more virulent forms by a destruction of the bark with the formation of depressed areas about which local swellings of the limbs occur.

The sooty brown, or olivaceous, mycelium penetrates the bark of the tree, hardly extending into the wood. It soon forms pycnidia which are erumpent and surrounded by the remnants of the epidermis. The pycnospores are oblong-elliptic, 22 to 32 by 10 to 14 μ , brown in color, and their size varies with the host plant on which the fungus lives. Artificial cultures of the fungus have successfully produced spores. Lime-sulphur solution has been found useful in combating the disease, but pruning and scraping the trees should not be neglected.

Scab (*Venturia inequalis* (Cke.) Wint.).—The scab also appears on the pear, but mycologists now consider that the scab fungus of the apple is specifically distinct from that of the pear. Earlier mycologists were familiar with the conidial forms of the two fungi, and they were placed under the genus *Fusicladium*, as *F. dendriticum* and *F. pyrinum*, but since the perfect stages have been discovered the species have been put in the genus *Venturia*. The perithecial stage is saprophytic. Scab is found wherever the apple is grown from Maine to California.

The fungus mainly attacks the fruit and leaves of the apple, but it has been found on the flowers, flower stalks and twigs. The leaf spots are more abundant on the lower surface, but sometimes also on the upper surface, as a velvety, olivaceous, superficial growth, occasionally accompanied by a curling of the leaf. The fruit spots are at first small and olivaceous, and as the mycelium spreads the epidermis is killed and the scabby areas arise (Figs. 164 and 165). Nearly all varieties of apple and pear are susceptible, but there is a varietal difference in this susceptibility.

The hyphæ grow beneath the epidermis and between the epidermis and cuticle spreading slowly. The erect conidiophores, which are produced, rupture the epidermis, giving the characteristic velvety,

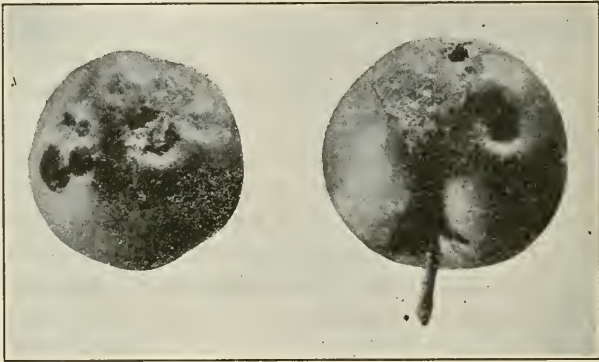

FIG. 164.—Two apples affected with scab (*Venturia inequalis*), showing spots, deformation and reduction in size of the fruit. (After Heald, F. D., Bull. 35 (*Sci. Ser. 14*), *Univ. of Tex.*, Nov. 15, 1909.)

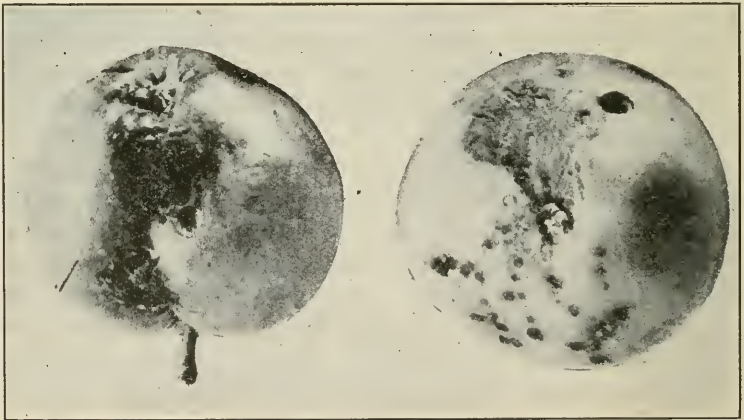

FIG. 165.—Two apples affected with scab (*Venturia inequalis*), showing spots, deformation and reduction in size of the fruit. (After Heald, F. D., Bull. 135 (*Sci. Ser. 14*), *Univ. of Tex.*, Nov. 15, 1909.)

olivaceous character to the spotted surface, and as the scabby areas are formed, the epidermis disappears. Conidiospores arise at the tips of the conidiophores and in concatenation. These spores are ovate,

truncate at the base and measure 28 to 30 μ by 7 to 9 μ . According to Clinton, they do not retain their vitality long. An investigation of perithecial formation indicates that perithecia begin to form in October, or even later, and reach maturity in the following April, when mature ascospores have been found especially on the under surfaces of the leaves. They are imbedded in the leaf tissues and are slightly pyriform in shape, including clavate slightly curved asci measuring 55 to 75 μ by 6 to 12 μ . Each ascus contains eight two-celled ascospores, which are olive-brown in color with the following dimensions: 11 to 15 μ by 5 to 7 μ . They germinate readily in water.

Spraying with lime-sulphur mixture 32° Beaumé, 1-40, before the time of flowering has been recommended for Scab, followed by a second, or even a third spraying after the petals fall, and at least two or three weeks after the second.

Ash (*Fraxinus americanus*, L.)

Heart-rot (*Fomes fraxinophilus* (Pk.) Sacc.).—In the Mississippi Valley, white ash trees of all ages are attacked by this bracket fungus, which is a tree wound parasite, entering usually the stub

of a branch, which has been broken off by the wind, or by snow. From the point of entrance, the mycelium grows into the heartwood of the trunk. The wood at first turns darker in color, later the disease is marked by a bleaching of the color in the spring wood of the annual rings, which turn to a straw color and then become blanched. The whole woody



FIG. 166.—An old sporophore of *Fomes (Polyporus) fraxinophilus* on white ash. (After Hermann von Schrenk, Bull. 32, U. S. Bureau of Plant Industry, 1903.)

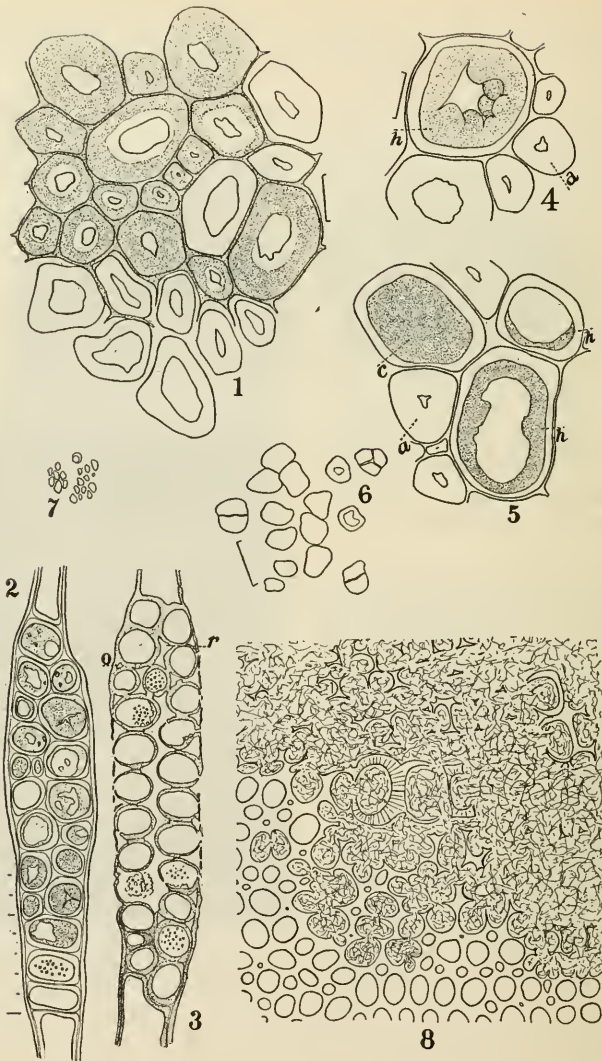

FIG. 167.—Disease of ash caused by *Fomes (Polyporus) fraxinophilus*. 1, Cross-section of ash wood; 2, of medullary ray; 3, medullary ray, showing later stage of attack; 4, 5, of wood cells; 6, starch grains from medullary ray cell; 7 diseased wood; 8, transection from entirely rotted wood. (After von Schrenk, Hermann, Bull. 32, U. S. Bureau of Plant Industry, 1903)

tissue becomes straw-colored and finally transformed into a loose spongy mass of fibers, which readily absorbs water (Fig. 167).

The fruiting brackets, or sporophores, make their appearance from the mycelium at the base of the stubs, or from wounded surfaces, either alone, or a number together (Fig. 166). The mature sporophore, according to von Schrenk,¹ is nearly triangular in cross-section with a broad rounded edge, which at first is white, turning gradually darker until it becomes straw-colored (Fig. 167). The older portions of the upper surface are dark brown, or black, and are very hard and woody, its upper surfaces obscurely zoned, pale brown and rust colored. Wound protection, as outlined in the section on prophylaxis, is an important method of preventing the white heart-rot from killing white ash trees.

Asparagus (*Asparagus officinalis*, L.)

Rust (*Puccinia asparagi* DC.)—The asparagus rust is well-known, having been investigated by a number of mycologists in this country, notably Halsted, Surrine, Smith and Stone.² In Europe the disease is of little consequence, but in America it threatens the asparagus growing of our country, spreading rapidly, especially during times when dew is abundant, for Smith says: "The amount of rust varies directly and exactly with the amount of dew, and so long as there is little or no dew, there can be no rust." During dry summers rust is largely absent.

All of the spore forms are found on the stems and twigs of the cultivated asparagus and on several wild species of the genus. The uredinia and telia appear also on the leaf-like branches of the plant. The æcidia appear as long light-green cushion-like patches. They have a white peridium and are short cylindrical, inclosing the orange-colored æciospores, which are 15 to 18 μ in diameter, and retain their power of germination for several weeks. Stomatal infection probably is the rule. Associated with these æcia are spermagonia in small, yellow clusters. Early summer ushers in the red rust (uredo) stage of the disease with the deep brown sori more or less scattered at first, later becoming confluent. The urediniospores are yellowish-brown, thick-walled with four germ pores and measure 21 to 24 μ . The clothing of a person

¹VON SCHRENK, HERMANN and SPAULDING, PERLEY: Diseases of Deciduous Forest Trees. Bull. 149, U. S. Bureau of Plant Industry.

²SMITH, RALPH E.: Asparagus and Asparagus Rust in California. Calif. Agric. Exper. Sta., Bull. 165: 1-95, 1905.

rubbing against the plant may be colored owing to the abundance produced. Later in the season the black rust stage appears with the formation of elliptic two-celled teliospores, 30 to 60 μ by 21 to 28 μ , and with a thickened apex and long pedicels. Infection of asparagus plants in cultivated fields is, according to Duggar,¹ through the æciospores produced on wild or escaped plants and not directly from the germination of the teliospores, which remain in or about the soil. Bordeaux mixture, used as a spray alone, has not been very successful. A more successful treatment has been obtained by adding a resin mixture to the Bordeaux solution. Sirrine recommends the following: Bordeaux mixture, 5-5-40 formula, 40 gallons; resin mixture, 2 gallons, diluted 10 gallons. The resin mixture consists of resin 5 pounds; potash lye 1 pound; fish oil 1 pint; and water 5 gallons. Under certain climatic conditions in California it has been found efficient to dust the young tops with dry powdered sulphur on a dewy morning at the rate of one and a half sacks of sulphur per acre, followed in a month by a second application, using two sacks of sulphur per acre.

Banana (*Musa* sp.)

Bud-rot (*Bacillus musæ*, Rorer).—Bud rots of the banana have been reported from the greater Antilles (Cuba, Jamaica) from Central America and Trinidad. The disease in Trinidad has been investigated by a mycologist from the United States, J. B. Rorer, the mycologist of the island government, and he has proved that an organism which he has isolated and named *Bacillus musæ* is the responsible parasite. However, the bud-rots of the banana are probably due to the same cause, but the matter has not been investigated satisfactorily outside of Trinidad. The disease usually appears on the young plants, attacking the young leaves and the core, which become brown. The tissues disorganize and a putrid rot sets in with the death of the parts attacked.

March is the month in which the disease usually begins and in three or four months its destructive effects are seen.

Beet (*Beta vulgaris*, L.)

Leaf-spot (*Cercospora beticola*, Sacc.).—This disease is distributed widely in America and Europe and the red garden beet is seldom free

¹ DUGGAR, B. M.: Fungous Diseases of Plants, 406.

from it. The leaf-spots are very small brown with reddish-purple borders, when they first appear, and later, when about 4 mm. in diameter, they become ashen gray at the center with the usual margin. They are scattered over the blade and eventually the leaves blacken and dry up, and as the lower leaves die, new ones are formed above until a characteristic elongated crown may be produced. The gray color of the spots is usually associated with the formation of conidiospores and conidiospores. The conidiophores are clustered, arise from a few-celled stroma, and push through the leaf stomata. The conidiospores are elongated and needle-shaped, multicellular, 75 to 200μ by 3.5 to 4.5μ , and under moist conditions, the average length may be exceeded. They germinate readily in ordinary nutrient media and the submerged mycelium in agar grows as a dense colony olivaceous in color, while the aerial portion is grayish-green. The disease fortunately can be controlled by the use of Bordeaux mixture (4-4-50), and as the spores retain their vitality for some time, early spraying is important and frequent after sprayings.

Rust (*Uromyces betæ* (Pers.), Tul.).—The beet rust is known only from California. It is common in Australia and not unusual in Europe. Kühn thinks that the mycelium may be biennial in the host, forming æcia throughout the year. The spermogonia are found in small yellow groups associated with the æcia, which are white and saucer-shaped with æcidiospores 17 to 36μ in diameter, filled with orange-colored contents. The uredinia and telia are irregularly scattered over the leaf surfaces. The urediniospores are obovate, 21 to 24μ by 35μ with echinulate walls, and two opposite germ pores. The short pedicellate obovate teliospores are 18 to 24μ by 25 to 32μ , with an apical germ pore piercing a wall scarcely thicker at the apex.

Cabbage (*Brassica oleracea*, L.)

Black-rot (= *Pseudomonas brassicæ* (Pam.), Sm., *Bacterium campestris* (Pam.), Sm.)—The cause of the black-rot of cabbage and other cruciferous plants is a yellow, uni-flagellate microorganism, which causes a yellowing of the cabbage leaves accompanied by a black stain in the vascular system, forming a conspicuous black network on a yellowish, or light-brown, background. The badly diseased leaves are shed, so that the stem may have a terminal tuft of badly distorted leaves.

A stem section shows a browning of the vascular ring and the vessels are found occupied by bacteria (Fig. 168). When the cabbage plant is attacked early in the season, it is killed outright, or else it fails to form the characteristic head. Infections may take place through injury of the surface, but the greater part of them are through the water pores, which exude drops of water, which collect during cool

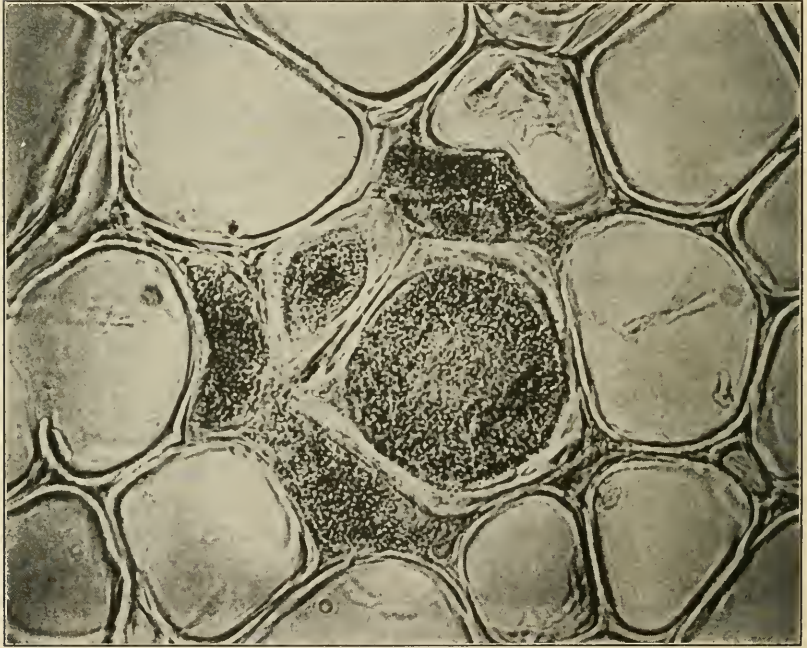

FIG. 168.—Brown-rot of turnip (*Pseudomonas brassicae*). Cross-section from middle of turnip root showing small bundle fully occupied by the bacterial organism. (After Smith, E. F., Bull. 29, U. S. Bureau of Plant Industry, Jan. 17, 1903.)

nights, and in natural infection slugs are responsible carriers of the organism.

Russell has found that the cauliflower is the most susceptible plant, while turnips and rutabagas are not very susceptible. Edwards reports that the Houser cabbage is practically immune to black-rot under field conditions. The period of incubation is variable. In some cases with needle punctures, the first signs of the disease appear in seven to

twenty-eight days on leaves and in from nine to thirty-one days on stems. E. F. Smith obtained with needle punctures first signs of disease in fourteen to twenty-one days. In a study of the morbid anatomy of the cabbage, it has been found that the parasite is confined for some time to the vascular system and even to particular leaf traces or bundles, especially to the spiral and reticulated vessels, which are very often filled with incalculable numbers of this organism. Later, as the walls of the vessels are destroyed, the organism finds its way into the surrounding parenchyma. *Pseudomonas brassicæ* is sometimes motile, especially when taken from the plant, and is examined in a hanging drop of water. Its measurements are 0.7 to 3.0 μ by 0.4 to 0.5 μ . It is often somewhat irregular in shape. The flagella is several times the length of the cell and arises at or near the end. The organism is wax-yellow, changing to a dirty yellow-brown in old cultures.

The treatment of this disease falls principally under the head of restriction and prevention. Seasonal variations are found and the organism thrives well in cool, moist lands. Underdrainage of soils might prove advantageous in wet seasons. The diseased plants should not find their way into the manure heap, but all refuse should be destroyed. As E. F. Smith puts it, "Avoid infected seed, soil and manure; destroy insect carriers of infection, if the plants are attacked." Crop rotation is advantageous. Soaking the seed for fifteen minutes in a solution of mercuric chloride (one tablet to a pint of water) should be practiced.

Club-root (*Plasmodiophora brassicæ*, Wor.) This disease, which has been known for a hundred years, has received a number of names, such as fingers and toes, Anbury, Hanbury (England), Kohlhernie (Germany), maladie digitoire (France) Kapoustnaja Kila (Russia). (The organism causes unsightly and destructive root disease of cruciferous plants, such as cabbage, Brussels sprouts, turnips, rutabagas, radishes and certain mustards (Fig. 169). The parasite is a slime mould (MYXOMYCETES) named by Woronin (*Plasmodiophora brassicæ*). It lives in the parenchymatous cells, often in the vicinity of the cambium, and an abnormal development of phloem is noticeable. The infested cells are grouped together into packets and their contents are at first fluid, then turbid and granular, assuming the amœboid form with distinct nuclei. The amœba are increased by

division, and by a sort of gemmation. The myxamœba are provided with several nuclei. The formation of spores soon begins by the successive simultaneous divisions of the myxamœbæ, so that each nucleus and surrounding mass of cytoplasm is differentiated, as a spore by the formation of a spore wall about them. The diseased cells are crammed

full of such spores, which escape only when the root disintegrates. The liberated spores will germinate in water in from four to twenty-four hours and later the parasite gains entrance to the roots of the cabbage plant. The organism causes an excessive formation of new cells so that a gall, or canker results.

In order to check the organisms, soils have been treated with lime, sulphur and other fungicides. Liming, using two tons of quicklime to the acre eighteen months before planting, has been found the most reliable with the destruction of the refuse of previous crops by burning.



FIG. 169.—Cabbage roots showing club-root caused by a parasitic slime mould, *Plasmodiophora brassicæ*. (From Marshall, *Microbiology*. Second edition, p. 609, after Woronin.)

Carnation (*Dianthus caryophyllus*, L.)

Alterniöse (*Alternaria dianthi*, Stev. & Hall).—Through Connecticut, Pennsylvania, District of Columbia and North

Carolina this disease of the cultivated carnation has been recently quite troublesome. The leaves and stems, especially at the nodes, are discolored with spots of ashen whiteness with a central black fungous growth. The spot is dry, shrunken and thinner than the surrounding healthy parts of the leaf, and is either circular, or somewhat elongated in line with the long axis of the leaf. The nodal spots involve the leaf

bases as well, and the mycelium finally grows into the stem killing its tissue which becomes soft and broken down (Fig. 170). The variety known as Mrs. Thomas W. Lawson is especially susceptible.

Rust (*Uromyces caryophyllinus* (Schrank), Wint.—This disease was practically unknown in the United States prior to 1890, but now it

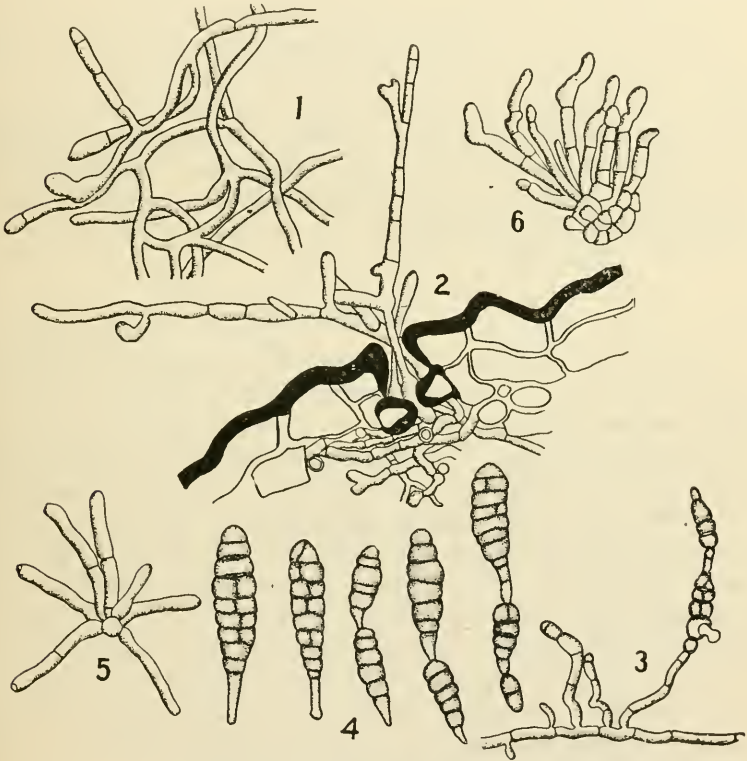

FIG. 170.—Carnation alternariose (*Alternaria dianthi*). 1, Branched, septile mycelium; 2, hyphae below surface of stroma; 3, spore formation; 4, compound spores, 5, young clustered hyphae; 6, older cluster. (After Stevens, F. L., and Hall, J. G.; *Bot. Gaz.*, 47: 409-413, May, 1909.)

is prevalent wherever the carnation is grown commercially. The different varieties of cultivated carnations differ to a marked degree in susceptibility. Enchantress and Lawson have a high degree of resistance to rust, while Scott and Jubilee are very susceptible.

The fungus is largely propagated by its urediniospores, which are ellipsoid to spheric in form and measure $24-35\mu$ by $21-26\mu$. The spore wall is thick and spinulose. The teliospores resemble in form the urediniospores and measure $20-35\mu$ by $18-25\mu$. Their walls are chestnut-brown and uniformly thickened with terminal germ pores and are papillate. As the adult plants may be infected, the disease may spread rapidly during the growing season.

The disease can be controlled undoubtedly by growing rust-resistant varieties of carnations. The leaves should be kept away from the moist soil by simple V-shaped wire mesh supports and lastly fungicides, such as a solution of copper sulphate (1 pound copper sulphate to 20 gallons of water), might be used with success. Duggar also recommends the use of potassium sulphide 1 ounce to a gallon of water. Sub-irrigation has been practised.

Cacao (*Theobroma cacao*, L.)

Brown-rot (*Thyridaria tarda*, Bancroft).—A number of different organisms have been thought at different times to cause the brown rot of the chocolate pods, but Bancroft in 1911, an authority on the subject, ascribed the disease to the above-named fungus. Circular brown patches appear on the chocolate fruits along the grooves that seam the surface. The disease spreads rapidly and the fruit falls in from six to ten days from the time that it is first infected. When the spots are 2 cm. in diameter, their center becomes marked by wounds in which a brownish-gray mycelium appear. Wounded fruits are especially open to infection through the abraded surface and the seeds, or beans, are sometimes involved and are destroyed completely. The disease is widely spread in the eastern and western tropics (in Jamaica, Santo Domingo and the Philippines). It may be controlled to some extent by burning all diseased fruits, busks and prunings.

Pink Disease (*Corticium lilaco-fuscum*, Berk & Curt.).—The genus *Corticium* belongs to the family of THELEPHORACEÆ, which includes the smothering fungi of the genus *Thelephora*. The leathery hymenophore of *Corticium* is membranous, fleshy, waxy with clavate basidia with four sterigmata. The basidiospores of our cacao fungus are sessile on the basidia. It attacks the younger branches of the chocolate tree covering them with a pinkish incrustation, which spreads over

the bark and into the bark crevices, causing the bark to crack and peel. Later a new bark forms under the old. The new bark is not sufficiently resistant to the attacks of species of *Diplodia* and *Nectria*, so that these fungi may enter and complete the work of destruction. *Corticium lilaco-fuscum* grows more rapidly in damp, shady places, and it usually refuses to grow in sunny places, hence opening up the growth is beneficial.

Cherry (*Prunus* spp.)

Leaf-curl (*Exoascus cerasi* (Fckl.), Sadeb.).—This fungus produces witches' brooms out of the twigs of the cherry, and when the leaves on affected twigs are parasitized, they become somewhat reddish and curled. The asci develop on the leaves and measure according to Sadebeck, 35 to 50 μ by 7 to 10 μ , or in specimens studied by Atkinson, 25 to 33 μ by 6 to 9 μ . The asci are naked and arranged in rows over the leaf surface. Spraying, if done at all should be done when the buds begin to develop in the Spring, and again when the asci are mature and ready to discharge their spores.

Powdery Mildew (*Podosphaera oxycanthæ* (DC.), deBy).—This disease, although found on a number of other rosaceous plants, such as plums and hawthorns and the like, is especially destructive to apples and cherries. The leaves become mildewed with large spots of white mycelium from which arise the perithecia, which are 65 to 90 μ in diameter surrounded by the dichotomously branched hyphal appendages four to thirty in number, which are usually five times as long as the diameter of the perithecium. A single ascus usually contains 8 ascospores. It is recommended to spray with lime sulphur (1-40) or dust with powdered sulphur in combating this disease.

Chestnut (*Castanea dentata* (Marsh.) Borkh.)

Blight (*Endothia parasitica* (Murrill), Anderson).—When the chestnut blight fungus was first described by Murrill he called it *Diaporthe parasitica*, but by the studies of Anderson and others it has been transferred to the genus *Endothia*, where it seems rightly to belong.¹ On account of its virulency and its rapid spread through the chestnut

¹ SHEAR, C. L., STEVENS, NEIL E., and TILLER, R. J.: *Endothia parasitica* and Related Species. Bull. 380, U. S. Dept. Agric.

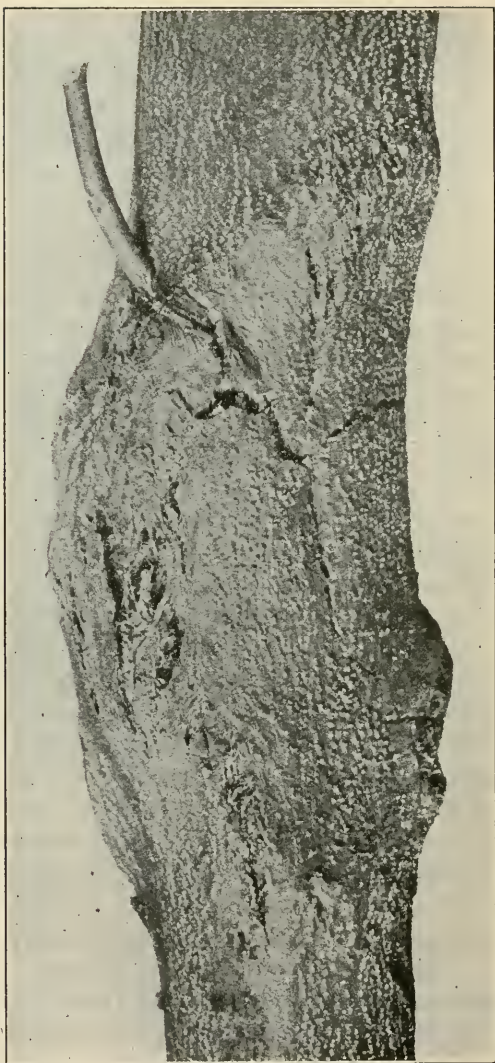

FIG. 171.—Canker lesion that nearly surrounds the chestnut branch, sunken on one side and enlarged on the other. (Photo by Wm. Currie, Bull. 5, Penna. Chestnut Tree Blight Com., 1913.)

forests of the eastern United States, it has been the subject of much legislation and also a copious bibliography has been formed by the appearance of papers on its parasitism, life history and the remedial measures to be taken to combat it. The chestnut blight fungus was

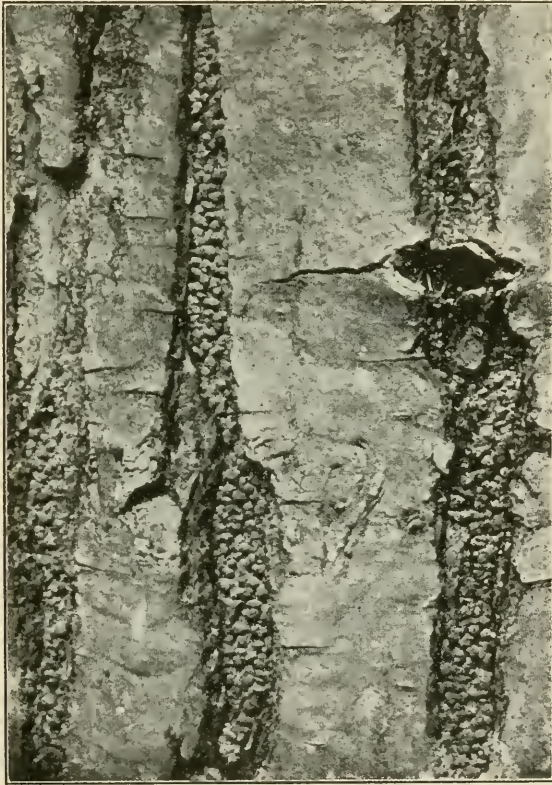

FIG. 172.—Perithecial pustules of chestnut blight fungus (*Endothia parasitica*) in the crevices of bark of a fallen chestnut tree. (Photo by Wm. Currie, Bull. 5, Penna. Chestnut Tree Blight Com., 1913.)

discovered by Merkel in 1904 on American Chestnut trees (*Castanea dentata*) in the New York Zoological Park. It was studied by Murrill during 1906 by pure culture and by inoculation on healthy chestnut trees, and an account was published of the fungus as a new species in *Torrey* (6 : 186-189) in 1906.

The rapidity of spread has been phenomenal, and the completeness of destruction is without parallel in the annals of plant pathology. It is now found from New Hampshire to Albemarle County, Virginia, in the South. Summer is the best time to study the symptoms of the disease, which are manifested in the brown shriveled leaves, which may be seen at a distance. The dead leaves hang on the tree over winter, and if on the blighted branches, the girdling is completed while the burs are maturing. Burs smaller than usual, and unopened, re-



FIG. 173.—Chestnut blight pustules producing gelatinous threads with summer spores. (After pictorial card issued by Penna. Chestnut Tree Blight Com., 1912.)

main attached to the tree through the winter months and well into the next spring. If, however, the girdling takes place after the leaves and burs are shed and before the leaves open in the spring, the leaves do not attain their full size, but are pale and distorted and this is a common symptom during May and June. Dead limbs without attached leaves, or burs, are often indications of the canker disease. Water sprouts, or suckers, may develop just below the cankered regions of the branches or stem and thick clumps of suckers on the trunk and

branches, or at the base of the tree, are evidences that the trees are attacked by the chestnut blight fungus.

The cankers on smooth bark are especially marked, and with a reddish-brown color in contrast with the healthy bark can be seen for a considerable distance (Fig. 171). As sunken, or swollen diseased areas of the bark, they occur on branches of all sizes and generally the cankers are ellipsoidal with the long axis up and down the stem (Fig. 171). The cankered areas of bark become covered with numerous small pimples (Fig. 172) from which emerge in wet weather long twisted

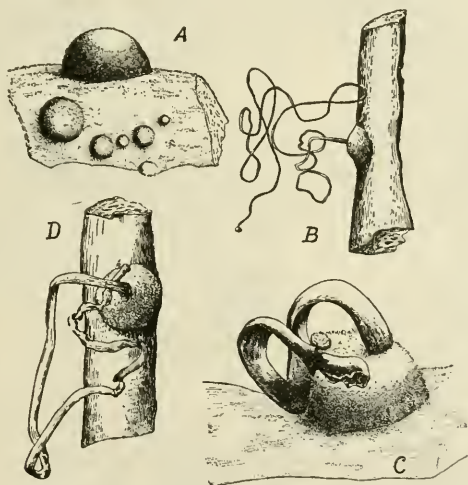

FIG. 174.—Chestnut blight fungus, *Endothia parasitica*. A, Pustules on bark; B, escape of pycnospores as gelatinous cords; C, D, magnified views of the cord-like masses of pycnospores. (From Gager after Murrill.)

yellow horns of a gelatinous nature (Figs. 173 and 174). As the canker ages the bark splits and cracks, and in a year or two it peels off from the tree leaving the wood exposed to the weather (Fig. 127). The mycelium forms thick, fan-like mats in the bark and cambium of the tree and it spreads both longitudinally and circumferentially (Fig. 175) until, having completed its growth around the stem, or branch, and killed the cambium and bark, the part of the tree above the girdled portion succumbs and the next year leafless branches show the irreparable damage done to the tree by the blight fungus (Fig. 127).

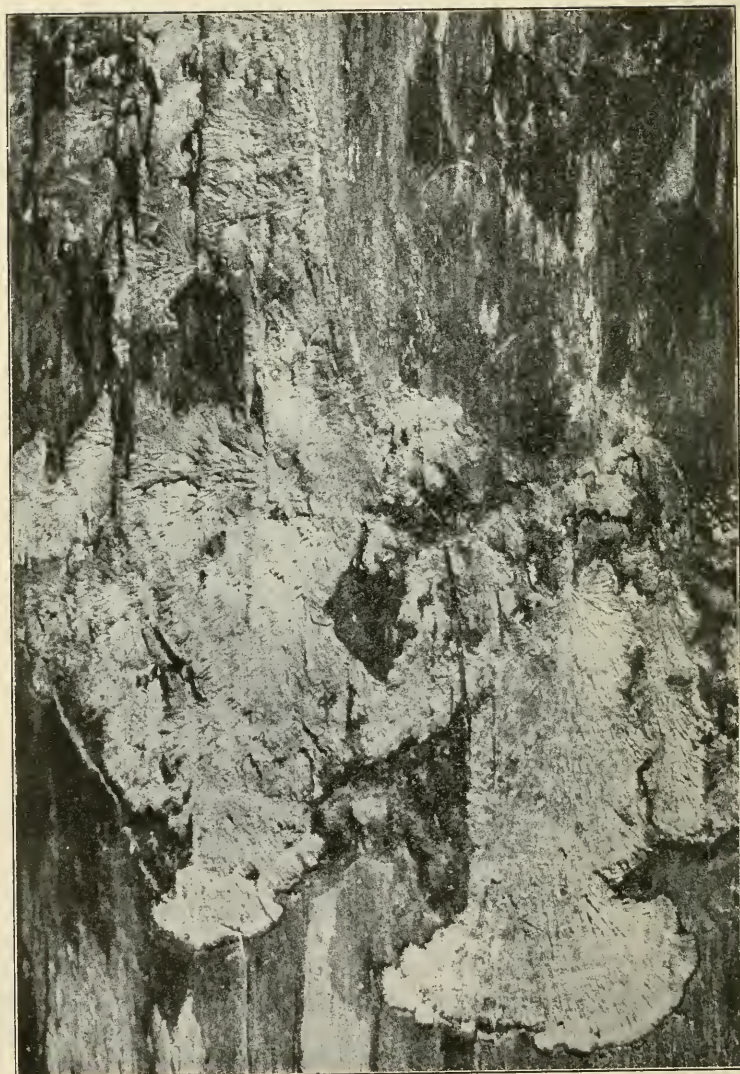

FIG. 175.—Fan-shaped mycelium of chestnut blight fungus (*Endothia parasitica*) from rough bark of a chestnut tree. (Photo by E. T. Kirk, after Anderson, Bull. 5, Chestnut Tree Blight Com., 1913.)

Morphology.—On smooth bark, especially in summer, the outer cork layer is raised into numerous little blisters, with slender, yellow, waxy twisted horns emerging from a pore in their apices. A section across each blister reveals a somewhat globose pycnidium surrounded by a scanty loose mass of whitish, or yellowish hyphæ, which merge with the tangled hyphæ that make up the pycnidial wall. The conidiophores arise inside the pycnidium, as a dense brush-like fungi and project into the fruit cavity (Figs. 174 and 176). They range in length from 20 to 40 μ . From these conidiophores, spores (pyncospores) are abstracted, and as the cavity is filled with the hyphal stalks, the pyncospores are forced out at an opening in the top of the pycnidium in the form of a twisted slimy cord (Figs. 173 and 174). The smooth hyaline pyncospores are held together by a sticky material and they measure 1.28 by 3.56 μ in size, and are oblong cylindrical with rounded ends sometimes slightly curved. Heald and Gardner¹ find that the pyncospores are to a considerable degree resistant to desiccation in soil in the field and that a large number may retain their viability during a period of 2 to 13 days of dry weather (Fig. 177). They found that with indoor desiccation a large number of spores survived two months and that in 5 out of 12 samples not all of the spores had succumbed after three months of drying. The longevity limit varies from 54 to 119 days, the average being 81 days. Studhalter and Ruggles² by experimental methods obtained some interesting results as to insects as carriers of the chestnut blight fungus. Tests were made with twenty-one ants in certain laboratory and insectary experiments in which they had been permitted to run over chestnut bark bearing

¹ HEALD, F. D. and GARDNER, M. W.: Longevity of Pyncospores of the Chestnut Blight Fungus in Soil. *Journal Agricultural Research* II: 67-75, April 15, 1914. Additional facts in the life history of the chestnut blight fungus are presented in the following: HEALD, F. D., and WALTON, R. C.: The Expulsion of the Ascospores from the Perithecia of *Endothia Parasitica* (Murr.), *Amer. Jour. Bot.*, 1: 449-521, Dec., 1914; HEALD, F. D., and STUDHALTER, R. A.: Seasonal Duration of Ascospore Expulsion of *Endothia parasitica*. *Amer. Journ. Bot.*, 2: 429-448, Nov., 1915; *Ibid.*, The Effect of Continual Desiccation on the Expulsion of Ascospores of *Endothia Parasitica*. *Mycologia*, 7: 126-130; *Ibid.*, Longevity of Pyncospores and Ascospores of *Endothia Parasitica* under Artificial Conditions. *Phytopath.*, 5: 35-44; STEVENS, NEIL E.: Some Factors Influencing the Prevalence of *Endothiagyrosa*. *Bull. Ton. Bot. Club*, 44: 127-144, Mch., 1917.

² STUDHALTER, R. A. AND RUGGLES, A. G.: Penna. Dept. of Forestry. *Bull.* 12, April, 1915.

spore horns or active perithecial pustules of *Endothia parasitica*. They found that five of the twenty-one ants were carrying spores. Tests with other insects demonstrated that they were carrying spores. The number of viable spores carried varied from 74 to 336,960 per insect, and the last number was obtained on *Leptostylus Macula*, one of the beetles, which feeds on the pustules of the blight fungus. During these experiments, it was proved that the spores of *Endothia parasitica* were easily shaken from the body of the beetle during its own movements. Heald and Studhalter¹ undertook to determine whether birds carried the spores. They found on birds shot on blighted chestnut trees after the bill, head, tail, feet and wings of each bird were scrubbed with a brush and poured plates were made from the wash water, which was retained and centrifuged for its sediment, that in the case of the 36 birds tested, 19 were found to be carrying the spores of the chestnut-blight fungus. The viable spores carried by two downy woodpeckers numbered 757,074 and 642,341 respectively, while a brown creeper carried 254,019, and that the highest positive results were obtained from birds shot two to four days after a period of considerable rainfall. Analyses of spore traps at West Chester and Martic Forge² showed that viable pycnospores of the chestnut blight fungus were washed down the trees in enormous numbers during every winter rain.

The mature stromata on older cankers have numerous projecting papillæ on the surface. The black speck at the tip of each papilla is the opening of a perithecium, which is a bottle-shaped depression with a long neck-like, black canal opening at the surface. There are commonly fifteen to thirty perithecia in a stroma. The mature perithecia (Fig. 176) measure about 350 to 400 μ in diameter, and are mostly spherical. The neck is usually four to six times the diameter of the perithecium and its black wall is composed of densely interwoven, septate, heavy-walled hyphæ running parallel with the long axis of the neck. The asci are clavate, or oblong, and contain eight ascospores imbedded in an epiplasm. The ascospores are two celled and measure

¹ HEALD, F. D. and STUDHALTER, R. A.: Birds as Carriers of the Chestnut Blight Fungus. *Journal of Agricultural Research* II: 405-422, Sept. 21, 1914.

² HEALD, F. D. AND GARDNER, M. W.: The Relative Prevalence of Pycnospores and Ascospores of the Chestnut Blight Fungus during the Winter. *Phytopathology* 3: 296-305, December, 1913.

4.5 to 8.6 μ in size (Fig. 177). The walls are thicker than those of the pycnospores. Expulsion of the ascospores is dependent upon tempera-

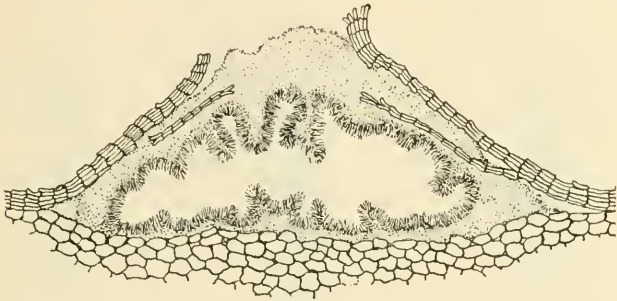

A

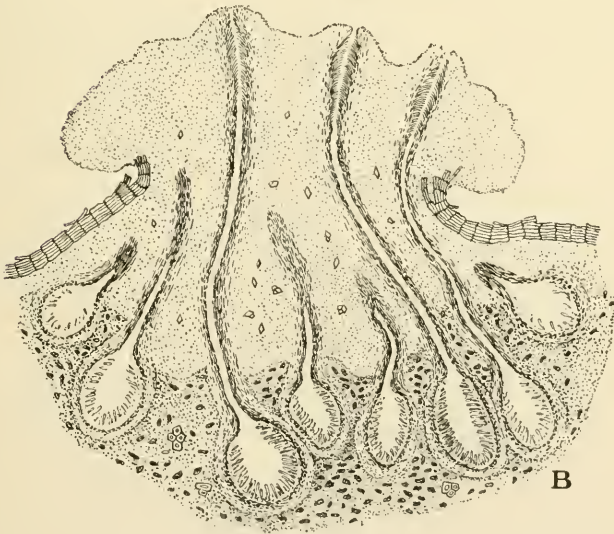

B

FIG. 176.—A, Vertical section of a pycnidial pustule. The filaments lining the cavity produce the spores that ooze out as "spore-horns;" B, vertical section of a perithecial pustule. Several of the perithecia are cut so as to show the full lengths of the necks in the chestnut blight fungus (*Endothia parasitica*). (After Heald, F. D., Bull. 5, Chestnut Tree Blight Com., 1913.)

ture, as well as moisture. There was no expulsion of ascospores under field conditions from late November until the rain of March 21, when

temperature conditions were favorable. Ascospores were not expelled during the warm winter rains, but during the summer rains ascospores

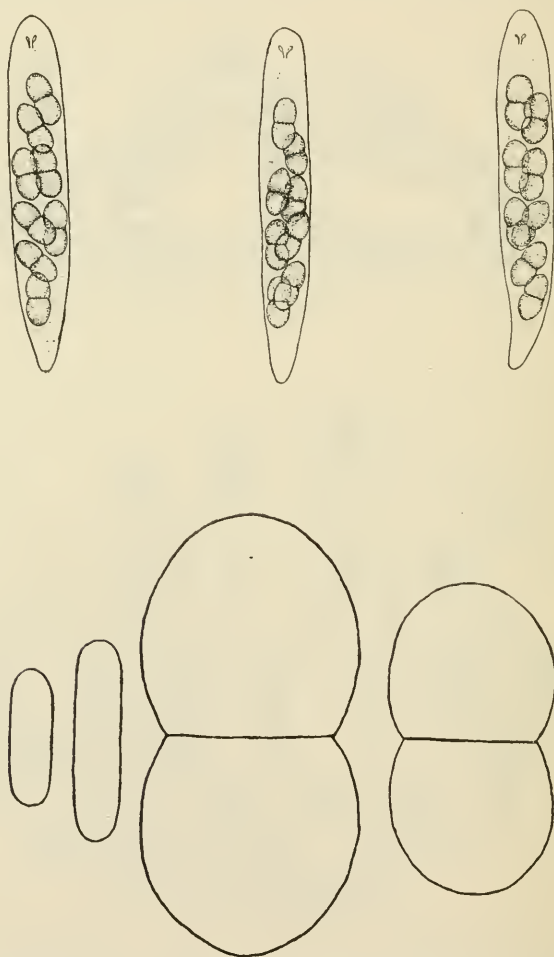

FIG. 177.—Spore-sacs or asci with eight two-celled ascospores of chestnut blight fungus (*Endothia parasitica*). Below diagram showing relative size of pycnospores (left) and ascospores (right). (After Heald, F. D., Bull. 5, Chestnut Tree Blight Com., 1913.)

are forcibly expelled in large numbers from the perithecia during and after each warm rain in case the amount of rain is sufficient to soak up

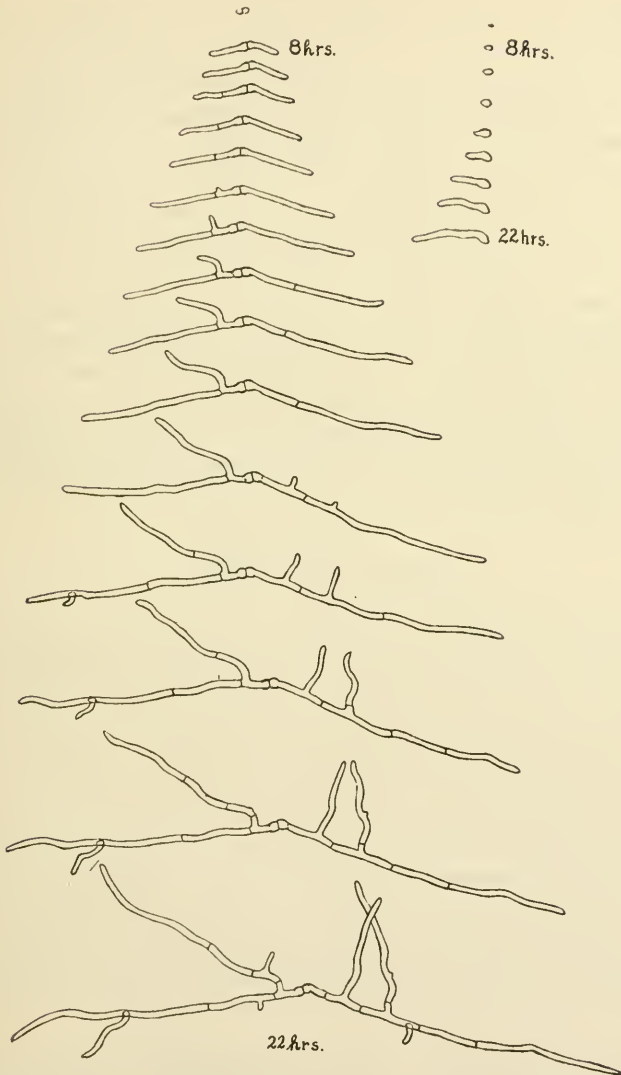

FIG. 178.—Photograph showing successive stages in the germination of ascospores and pycnosporangia of the chestnut blight fungus (*Endothia parasitica*). Left, ascospore series from 8 to 22 hours at hourly intervals; right, pycnosporangium series from 8 to 22 hours, taken every two hours. (After photo by Wm. Currie, Bull. 5, Penna. Chestnut Tree Blight Com., 1913.)

the pustules.¹ All of the experiments point to air and wind transport of the ascospores, as one of the very important methods of dissemination. Infection is by means of wounds produced mechanically, as by insects and other animals (Fig. 178). It is still to be demonstrated that the parasite can enter without visible breaks in the bark.² In the control of this disease inspection of nursery stock should be made and the use of gas tar following removal of diseased branches.

Leaf Mildew (*Phyllactinia corylea* (Pers.), Korst).—The under leaf surfaces of the chestnut are marked frequently by irregular patches of mycelium, which constitute the mildew fungus (Fig. 53). Typical haustoria are absent, but there are special setalike branches which penetrate the leaf tissues. The subglobose perithecium is large and is garnished with rigid needle-like appendages with a swollen base (Fig. 53). There are many included asci usually containing two spores, occasionally three. It is a fungus of wide geographic distribution throughout the temperate regions of the world.

Clover (*Trifolium* spp.)

Rust, *Uromyces trifolii* (Hedw.), Liv.—The common clovers of our cultivated fields, such as the red clover, alsike clover, white clover, and crimson clover, are attacked by this rust, which causes serious disease conditions (Fig. 70, E and F). The prevalence of the disease varies greatly with the season. The clover rust fungus is autoecious, all of the stages being found on the same host plant. All of the stages occur on the white clover (*T. repens*). In general the spermagonia and æcia are not met with on the red clover, the host upon which the other stages are perhaps more frequent. The mycelium is local in its occurrence in the plant, from it æcia and spermagonia arise in the early spring, or at almost any time during an open winter. They occur on the under leaf surfaces and on the leaf stalk. The æciospores are 14 to 23 μ in diameter and germinate readily in water.

HEALD, F. D., GARDNER, M. W. and STUDHALTER, R. A.: Air and Wind Dissemination of Ascospores of the Chestnut Blight Fungus. *Journal of Agricultural Research* iii: 493-526, March 25, 1916.

² For numerous other details consult ANDERSON, P. J. and RANKIN, W. H.: Endothia Canker of Chestnut. *Bull.* 347, Cornell University Agricultural Experiment Station, June, 1914.

The urediniospores are about $22-26\mu$ by $18-20\mu$, and repeated crops of these may be produced. The teliospores are formed in sori with the urediniospores, as the season advances. They are one-celled, thick walled and measure $20-35\mu$ by $15-22\mu$. The teliospores germinate in the ordinary way by the formation of a four-celled basidium each producing a basidiospore. No satisfactory method of controlling clover rust is known.

Coffee (*Coffea arabica*, L.)

Leaf-spot (*Cercospora coffeicola*, B. & C.).—The leaves and fruits of coffee plants in the Dutch East Indies, Mexico, Cuba, Jamaica, Trinidad and Brazil are attacked by the leaf-spot fungus, which causes large blotches at first visible only on the upper leaf surface. The spots are dark brown at first, later becoming grayish above and clear below. The center of these blotches die and here the spores are borne. The disease causes the leaves to fall, thus reducing the vigor of the plant and preventing the proper maturing of the coffee berries. Infected berries fall before ripening.

Rust (*Hemileia vastatrix*, Berkeley & Broome).—The coffee rust is widely spread through the coffee-growing regions of the old world, and it has been reported from the American tropics, but there is some uncertainty about reports. It is the most destructive disease of the coffee plant and American coffee growers should be on the lookout for it.

Orange-red spots appear on the leaves, which finally wither and drop, and frequently parts or whole plants die, especially during the rainy season, when the red spots increase in number. The spots appear as slightly transparent discolorations, which are not easily observed until the leaf is held up to the light. An older spot is yellow in color and then a bright orange color. They vary in size, but are usually circular in outline, and increase in number during June and July, when the disease reaches its culmination, if the weather conditions are favorable. The spores are produced in great abundance in the orange-red spots and on being set free are carried by the wind and insects to other coffee plants on the leaves of which they germinate sending a germ-tube into the leaf through the stomata. The urediniospores 35 to 40μ by 25 to 28μ are single, usually egg-shaped, provided with a papilla and without

germ-pores. The teliospores are unicellular. As a remedial measure the use of tobacco water or Bordeaux mixture is recommended.

Corn (*Zea mays*, L.)

Dry-rot (*Diplodia zeæ* (Schw.), Lev.).—The dry rot fungus attacks the dry ears of corn soon after silking and does not usually manifest itself until husking time, when the kernels are found to be covered with a whitish mycelial growth, which dips down between the individual grains of corn. The grains so attacked become shrunken, loosely attached to the cob, lighter in weight, darker in color, and more brittle than the healthy grains. Pycnidia may be found imbedded in the mycelium, especially between the kernels. In the open field, these pycnidia may be formed in such numbers as to impart a black color to the grains of corn. Of course the feeding value of the corn is gone and some physicians even ascribe pellagra to the use of such moldy corn. When the fungus attacks the stalks, it forms small dark specks under the epidermis near the nodes and even on three-year-old stalks pycnidia have been found. Infection takes place through the roots and the fungus which enters in this way finally reaches the stem. Ear infection may also occur through the silk by wind-blown spores which come from old diseased stalks left in the field, so that by destroying the corn trash the disease can be controlled to some extent. Rotation of crops is probably more efficacious.

Smut (*Ustilago zeæ* (Beckm.), Unger).—The smut boils of Indian corn, or maize, are found not only on the ears as with most smuts, but also on the husks, on the tassels of male flowers, on the leaves, and even on the stem (Figs. 179 and 180). The attack first begins on any young and tender part of the plant. If the leaves are the part attacked, they assume a pale yellow hue and are puckered with smaller, or larger bladder-like swellings. The swellings are made up of masses of the hyphæ of the smut fungus and their surface is covered with a smooth skin-like covering. Later the hyphæ divide up into innumerable rounded cells, which develop into the smut spores, or chlamydospores. Finally, the silvery-white skin having been more and more stretched bursts, and the black chlamydospores are set free, as a powdery mass. The echinulate chlamydospores measures 8 to 12 μ , and they readily germinate in manure-water giving rise to a four-celled basidium,

each cell of which produces a basidiospore. Infection of the nascent tissue at any part of the growing corn plant is accomplished by the



FIG. 179.—Smut boil of *Ustilago zea* on ear of corn, developed from one infected kernel. (After Jackson, F. S., Bull. 83, Del. Coll. Agric. Exper. Stat., December, 1908.)

basidiospores and not by the chlamydospores (Fig. 181). Wet weather is essential for the growth of the corn and the smut also.

The disease may be controlled by removing the smutted plants from the field and destroying them and also by a rotation of crops.



FIG. 180.—Corn smut on tassels of sweet corn. (After Jackson, F. S., *Bull.* 83, *Del. Coll. Agric. Exper. Stat.*, December, 1908.)

As the fungus may infect the adult plant, the treatment of the seed corn with fungicides has been unsuccessful. Rotation of crops also assists in keeping smut in check.

Wilt (*Pseudomonas Stewarti*, Smith).—This is a specific communicable disease of sweet corn and other races of maize, caused by a yellow, polar-flagellate organism discovered in 1895 by F. C. Stewart. The disease has been found on Long Island, in New Jersey, Washington, D. C., Maryland, Michigan, Virginia and West Virginia. One of the first signs of the disease in well-grown plants is the whitening (drying

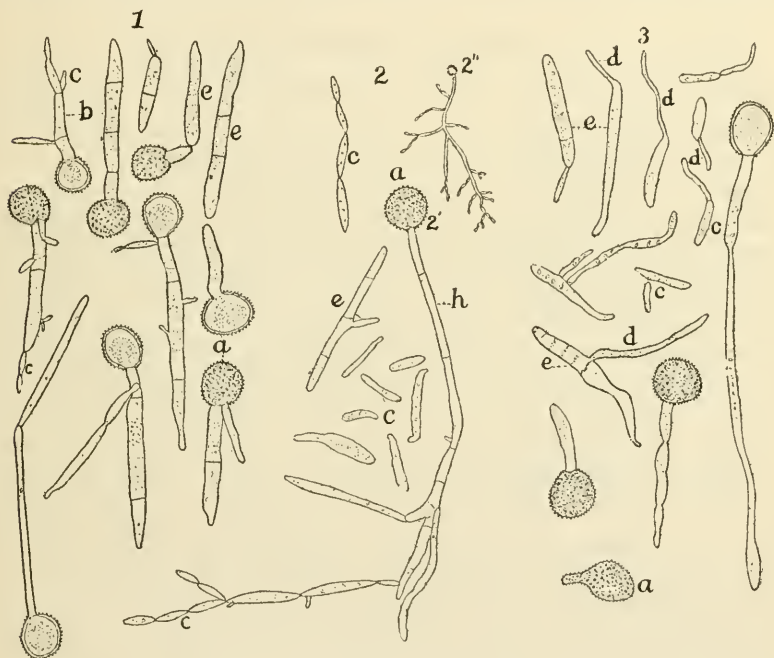

FIG. 181.—Germination of the chlamydospores of corn smut (*Ustilago zeae*); 1, Various stages in germination from corn 3 days after being placed in water; 2, spores germinated in contact with air; 3, several days after spores were placed in 1/20 per cent. acetic acid, formation of infection threads. a, Spores; b, promycelia; c, basidiospores; d, infection threads; e, detached pieces of mycelia. (After Bull. 57, Univ. Ill. Agric. Exper. Stat., March, 1900.)

out) of the male inflorescence. The leaves then dry out and the plant is dwarfed, later the stem dries. If the leaves or the stem be chosen and broken across, slimy yellow contents ooze out. A cross-section of the stem shows that the organism fills the vessels of the host plant and the wilting is due to the stoppage of the water supplies by the tracheid plugging.

The greatest pains should be taken to secure only sound seed corn, but in the present indifferent state of the seed-trade, even the best should be treated with mercuric chloride before planting. On fields subject to the disease, only resistant varieties should be planted. Manure containing corn stalks from diseased fields, or gathered from animals pastured in such fields, should never be used on land designed for corn.¹

Cotton (*Gossypium* sp.)

Boll Anthracnose (*Glomerella gossypii* (Southw.) Edg.) (= *Colletotrichum gossypii*, Southw.).—The same fungus causes an anthracnose of stem and boll of the cotton plant, especially in the Gulf states. The disease is more important when it attacks the boll, or the seedlings. The bolls lose their green color and become dull red, or bronzed. If the boll is nearly mature when attacked, it may mature and open in the usual manner, but if attacked early, it may cause a premature dying of the carpels and an unequal growth of the boll, which is liable to crack open and expose the immature lint to the action of the weather. The first evidence of the disease is a minute reddish spot, which later becomes black in the center and depressed with a reddish border, and these spots may run together.

Two types of conidiophores break out from the stroma within the tissues. Some of the conidiophores are hyaline and abstrict conidiospores that measure 4.5 to 7 μ by 15 to 20 μ , while other conidiophores in the form of setæ arise from the dark colored cells of the stroma. The setæ are clustered and bear ovate, basally pointed spores. Spores and setæ together form an acervulus. The spores germinate readily and produce a mycelium which grows vigorously in culture, is hyaline, flexuous and abundantly septate and it may give rise to appressoria.

Proper remedial measures have not been discovered, and a field of experimentation is opened up along these lines. Use resistant varieties.

Rust (*Uredo gossypii*, Lager.).—This is the uredo stage of *Kuehneola gossypii* (Lagerh.) Arth. which occurs on the cotton plant in Cuba, Puerto Rico, Florida and Guiana. *Æcia* are wanting in the life cycle,

¹ SMITH, ERWIN F.: Bacteria in Relation to Plant Diseases, Volume III: 89-150, 1914, where full details of the experimental study of the disease and the causal organism will be found.

while the other spore forms are represented by urediniospores and teliospores. All parts of the green cotton plant may be rusted, spreading to the new leaves as they are formed. Small rounded, or angular, purplish-brown spots appear on the upper leaf surface and the urediniospores are borne in pustules just beneath the epidermis on the under leaf surface, which finally ruptures and sets them free. The varieties of cotton grown in the Southern United States are partially immune, while the tropic varieties are more susceptible. It is recommended that the cotton grower destroys all rubbish in his fields and adopts a system of field culture in which only vigorous plants will be obtained.

Cranberry (*Vaccinium macrocarpon*, Ait.)

Gall (*Synchytrium vaccinii*, Thomas) (Fig. 230).—The fungus which causes cranberry gall is a very much reduced phycomycetous one, which attacks the young stems and leaves, as well as flowers and fruit of the cranberry. It also lives on other ericaceous plants. The galls are small in size, reddish in color and are produced in great numbers on the parts affected. The fungous body is much reduced, consisting of a single cell which becomes a zoosporangium. The presence of this parasitic cell in the tissues of the host is to produce a small gall. Later the zoosporangium develops a mass of swarm spores, or zoospores, which escape into the water. Infection, therefore, probably takes place when water is abundant.

Scald (*Guignardia vaccinii* Shear).¹—The scald fungus (Figs. 182 and 183) may attack the very young fruit and even the flowers of the cranberry and annually does considerable damage to the growing crop, as the annual loss has been estimated at \$200,000. The pycnidia are usually found upon such parts. The berries are characterized by watery spots, which may remain small under certain conditions, while under others it spreads quickly, often concentrically until the whole berry becomes soft. The leaves are also spotted with irregular brown spots within which the pycnidia are found.

The pycnidial stage is a characteristic *Phoma*, or *Phyllosticta*, measuring 100 to 120 μ in diameter. These are scattered over the affected surface and abundant hyaline, obovoid pycnospores are formed,

¹ SHEAR, C. L.: Cranberry Diseases. U. S. Bureau of Plant Industry. Bull. 110: 1-64, 1907.



FIG 182.—Cranberry scald (*Guignardia vaccinii* Shear). (After Shear; *Bull.* 110, U. S. Bureau Plant Industry, pl. 1, 1907.)

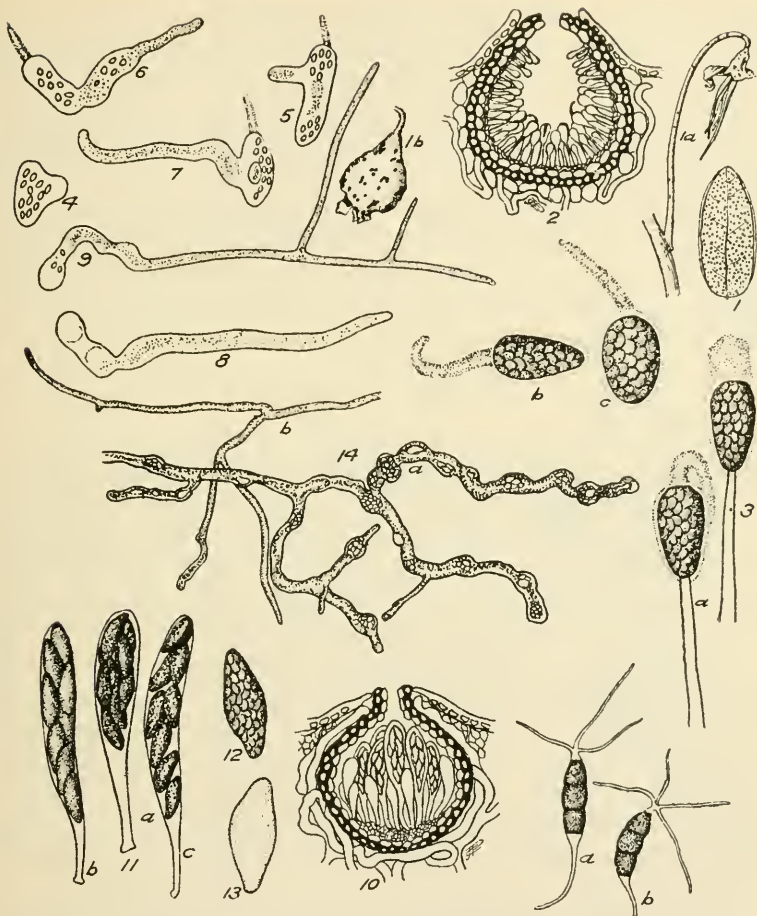

FIG. 183.—Details of cranberry scald fungus (*Guignardia vaccinii*). 1, A cranberry leaf, showing pycnidia of *Guignardia vaccinii* thickly scattered over the under surface; *a*, a cranberry blossom blasted by *Guignardia vaccinii*, showing pycnidia on calyx, corolla, and pedicel; *b*, a blasted fruit, showing pycnidia. 2, A vertical section of a single pycnidium of *Guignardia vaccinii* from a cranberry leaf, showing pycnosporae in various stages of development. 3, An immature pycnospore of the same fungus, showing the partially formed appendage; *a*, the same, showing a little later stage of development; *b* and *c*, fully developed pycnosporae and appendages. 4, 5, 6, 7, 8, and 9, Various stages in the germination and growth of pycnosporae of *Guignardia vaccinii* grown in weak sugar solution; 4, 5, 6, and 7, 72 hours after sowing; 8 and 9, 86 hours after sowing. 10, A vertical section of a perithecium of *Guignardia vaccinii*, showing asci, from a cranberry leaf collected in New Jersey. 11, Three asci, with ascospores showing variations in length of the stipe and the arrangement of the spores; *a* and *b*, from perithecia on a leaf; *c*, from a pure culture. 12, A fresh,

which measure 10.5 to 13.5 μ by 5 to 6 μ . The ascigeral stage is less common. The perithecium has a rather dense wall inclosing a number of clavate asci, which are 60 to 80 μ long (Fig. 183). The ascospores are hyaline, elliptic to sub-rhomboidal in form with granular contents. The fungus has been grown successfully in artificial culture media, but after a few generations, it seems to lose in vitality.

Preventative measures consist in an occasional renovation of the bag and in the proper regulation of the water supply. Spraying at least six times with Bordeaux mixture (5-5-50) is used with success; especially, if adhesive substances (4 pounds resin fish oil soap) are added to the mixture.

Grape (*Vitis* spp.)

Black-rot (*Guignardia Bidwellii* (Ell.) V. & R.).—Wherever the grape is grown this American fungus is a constant menace to the successful prosecution of the industry. It attacks not only the fruits, but also the leaves, fruit pedicels and stems. The disease, which is most important on the berries (Fig. 184), begins as a small circular brown spot which enlarges until it is 5 to 10 mm. in diameter, when the center of the spot will be found to show a few black pimples which are the openings of the pycnidia, which have now appeared beneath the skin. The spots become darker in color and spread until more than one-half of the fruit surface is involved, when the fruit begins to lose its spheric contour and to shrivel, persistently hanging on the vine sometimes throughout the season. Nearly all of the dark colored grapes are susceptible, such as the universally grown Concord, while some light colored varieties are more resistant. The Scuppernong is apparently entirely resistant.

As with many of the fungi which attack our cultivated plants, the different stages were known before the complete life cycles were determined and therefore, these stages received scientific names, which are relegated to synonymy, when the life history becomes known

mature ascospore, showing the usual condition, in which the protoplasm is very coarsely granular. 13, An old ascospore from a dried specimen, having its contents homogeneous. 14, *a*, A portion of the coarse brown mycelium from the interior of a scalded berry, from which a culture was made December 23, producing pycnidia and ascogenous perithecia of *Guignardia vaccinii*; *b*, a portion of younger, lighter colored hyphæ from the same berry. (After Shear, C. L., Bull. 110, U. S. Bureau of Plant Industry, 1907.)

thoroughly. So it has been with the black-rot fungus. The pycnidial stage on the grape leaves (Fig. 185) was called *Phyllosticta labruscæ*, while on the fruit it was called *Phoma uvicola*. These have been determined to be merely stages of one and the same fungus, *Guignardia Bidwellii*. The mycelium of the black-rot fungus is never abundant in the outer portions of the berries where it is found. Here a stromatic mass of hyphæ arises beneath the grape skin and develop the pycnidia, which are broadly elliptic, thick-walled and beakless depressions from the inner walls of which the pycnidiohores arise which abstrict off the ovate to elliptic pycnidiospores (pyncospores) 8 to 10 μ by 7 to 8 μ . These are pushed out in twisted masses and can germinate immediately.

Spermagonia-like pycnidia of smaller size are also found. These produce filiform conidiophores, which cut off minute, slightly curved microconidia. The ascigeral stage, discovered in 1880, may be had on fruit, which has been covered with grass and leaves in the dried up state. The perithecia are globose and bear broadly clavate asci containing eight unicellular ascospores, measuring 12 to 17 μ by 4.5 to 5 μ .

The black-rot grape disease can be controlled by Bordeaux mixture (4-4-50). The first application should be made in the spring, just as the buds begin to swell, followed by a second spraying, as the buds unfold. Subsequent sprayings, always before rain storms, to the number of five or six, should be made two weeks apart during the season. After July 20 use 4-2-50 Bordeaux, or ammoniacal copper carbonate.

Downy Mildew (*Plasmopora viticola* (B. & C.) Berl. & DeTon).—The consensus of opinion among mycologists is that the downy mildew fungus is of American origin, and it is now widely spread in Europe and eastern North America, where it probably did not originate. It has been noted on practically every variety of cultivated and wild grapes, and it attacks stems, leaves and berries. Usually it confines its attack

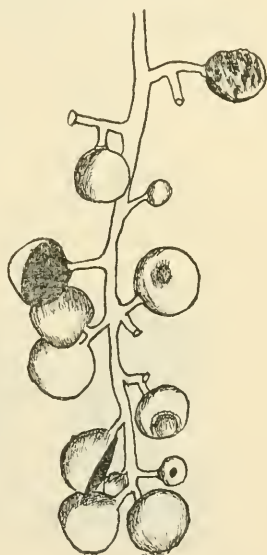

FIG. 184.—Black-rot fungus, *Guignardia Bidwellii*, attacking green grapes. Cold Spring Harbor, L. I., July 20, 1915.

to the grape leaves (Fig. 186), where it produces under ordinary conditions spots of mildew, especially on the lower leaf surface. In bad cases, the whole lower leaf surface may be covered with the downy, or cottony mass of hyphæ which gives the fungus its common name. The parasitic hyphæ live in the intercellular spaces of the host and send into the host cells small knob-like haustoria. The presence of the mycelium seriously interferes with the normal physiologic activity of the host. In light cases, the areas of upper leaf surface immediately overlying the hyphæ turn brown in the form of angular spots. Through

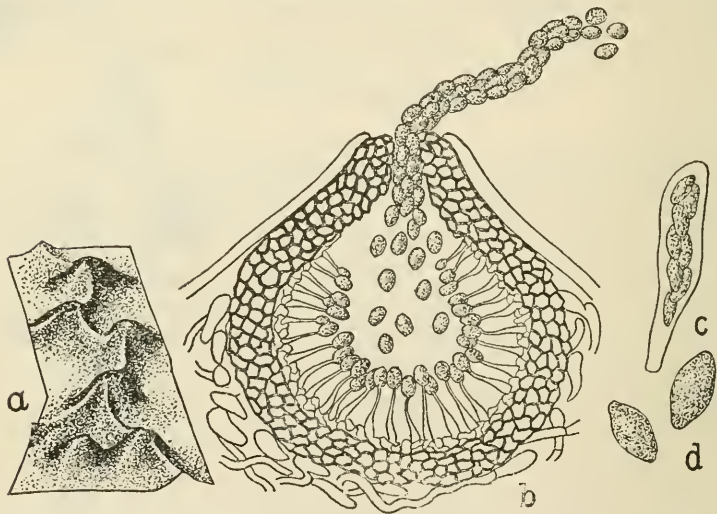

FIG. 185.—Black-rot fungus (*Guignardia Bidwellii*). *a*. Portion of an affected grape showing pustules; *b*, section of pustule (pycnium) showing pycnosporangia; *c*, ascus with ascospores; *d*, ascospores. (After Quaintance, A. L., and Shear, C. L., *U. S. Farmers' Bull.* 284, 1907.)

the stomata emerge stiff projecting conidiophores which form short stub-like branches from which fall ellipsoidal conidiospores. These conidiospores are virtually zoosporegia for their protoplasmic contents divide into a number of biciliate zoospores which escape and swim about in the rain water which covers the leaf or stem, or are washed down, or splashed from plant to plant during a dashing rain storm. When the fungus appears on the fruit, it has been called gray rot, and occasionally, the berry may be completely covered with a downy mass of hyphæ.

The oogonia and antheridia are not so common as the conidiospores. If the shriveled parts of the leaves are examined in September, the



FIG. 186.—Grape leaf attacked by mildew, *Plasmopara viticola*, Cold Spring Harbor, L. I., Aug. 2, 1915.

oogonia will be found as spheric organs attached to the intercellular hyphæ by a short stalk. One or several filamentous curved antheridia are formed near the oogonia to the surface of which they become ap-

plied. A germ tube is formed through which the antheridial contents pass over into the oogonium. A single large central egg-cell, or oosphere, becomes differentiated in the protoplasm of the oogonium; this contains a single nucleus in a central position, while the remaining nuclei pass into the peripheral layer of protoplasm (periplasm). A single male nucleus passes through the antheridial beak into the oosphere, which becomes surrounded by a cell wall. Nuclear fusion now takes place and the oosphere becomes an oospore with a single central nucleus. The oospores are about 30μ in diameter.

Bordeaux mixture is the most important fungicide used in combating the downy mildew disease. It is applied as in black-rot.

CHAPTER XXXV

DETAILED ACCOUNT OF SPECIFIC PLANT DISEASES (CONTINUED)

Hemlock (*Tsuga canadensis* Carr)

Heart-rot (*Polyporus borealis* (Wahl.), Fr.).—This bracket fungus is distributed widely in North Temperate regions. As a wound parasite, it occurs on hemlocks, pines and spruces, entering these trees through the stubs formed by the breaking off of branches. The mycelium gradually grows into the heart of the trees and from there downward into the roots and upward into the tops. It advances in definite directions through the wood in the form of cords, or strands, which run radially, or tangentially, in the channels dissolved by the action of the enzyme, which is formed by the living hyphæ. The wood shrinks and the mycelial strands begin to dry up, and the wood is separated into cuboidal blocks marked off by the channels formed by enzyme action. If the mycelium attacks the cambium, the trees die. The bracket-like fruit bodies are soft and spongy and last only a season. They are, according to Atkinson, 10 to 20 cm. (4 to 8 inches) by 6 to 15 cm. broad. Several of these sporophores may be joined together. The upper surface is rough, shaggy and has a sodden appearance. The pores on the under side are quite regular with rounded openings in some specimens, or irregular, elongated and sinuous in other samples.

Hollyhock (*Althæa rosea* Cav.) (Fig. 187)

Rust (*Puccinia malvacearum*, Mont.).—This fungus was introduced into France about 1868 from Chili, where it is native, and in the summer of 1915, the writer found it very destructive to the hollyhocks in the gardens on the Island of Nantucket off the southern coast of New England. It spread rapidly over Europe and came to the United States in 1886 upon infected seed. The leaves are spotted with the yellowish-brown sori slightly raised above the leaf surface (Fig. 72), or they are found on the stem in the form of small wart-like elevations. The leaves dry up, as if blighted, and during August of 1915 on Nan-

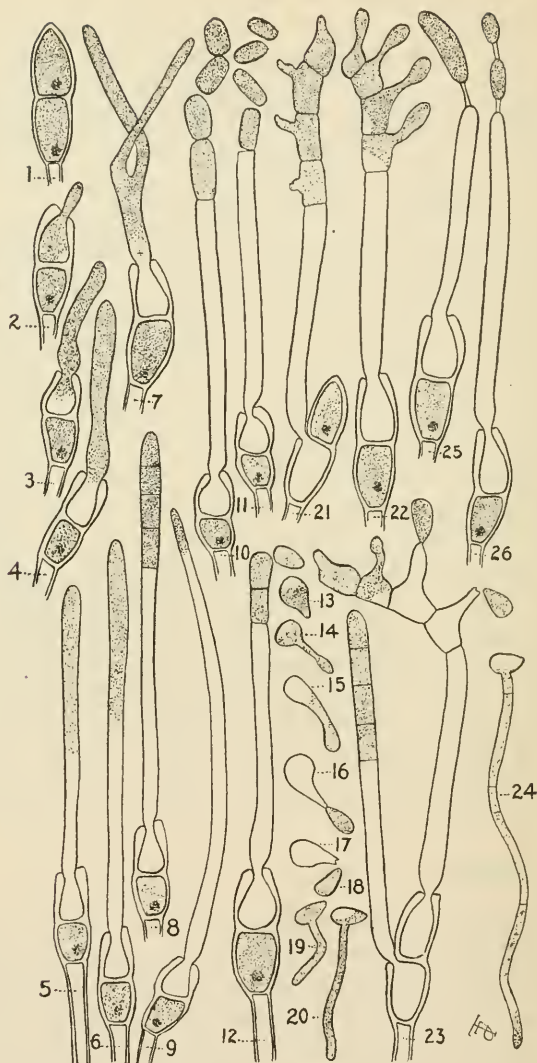

FIG. 187.—Hollyhock rust, *Puccinia malvacearum*. 1, Typical mature teliospore; 2-6, different stages in growth of promycelium (basidium); 7, forked promycelium; 8, basidium dividing into 4 cells; 9, basidium resembling a germ tube; 10-12, cells breaking apart; 13-16, germination of promycelial cells; 17, empty cell; 18, mature basidiospores; 19, 20, same in germination; 25, 26, formation of chlamydo-spore-like bodies in old promycelia. (After Taubenhaus, J. J.: *Phytopath.* I, April, 1911.)

tucket only a few host leaves were left on a row of garden hollyhocks, all of the other leaves having fallen off. The sori consist of light-colored teliospores which are two-celled and measure 17 to 24 μ by 35 to 63 μ (Fig. 187).

Bordeaux mixture (4-3-50) has been found efficient, as a spray, in controlling the hollyhock rust. Others recommend sponging the diseased parts with permanganate of potash, two tablespoonfuls of saturated solution diluted with one quart of water.

Larch (*Larix* spp.)

Canker (*Dasyscypha Willkommii*, Hartig).—The life history of this destructive fungus of larch trees has been studied by German plant pathologists, so that it is pretty well known. In the moist, marsh meadows in the mountains of Europe where the larch has been planted in pure forests, the fungus has been frequent in past years. The mycelium attacks the bast elements of the stem and its insidious character is manifested in the death of the bark, which peels off. Pronounced cankers soon develop and the fungus lives perennially in the tree spreading rapidly when the larch tree is comparatively inactive, viz., autumn and winter. The diseased area, represented by wounded tissue, may heal over during the growing season, but when the fungus regains its activity the disease progresses until the branch is completely girdled and its terminal part dies.

Creamy white stromatic tufts appear, where the bark has been killed and on this superficial mycelium minute conidiophores arise, which bear simple hyaline conidiospores. As these probably do not germinate they have no influence in the spread of the canker. Short-stalked apothecia may appear on the canker areas later in the year. They are somewhat yellow on the outer surface and orange within. The cylindrical asci (120 μ by 9 μ) bear light ovoidal, unicellular ascospores. Filiform paraphyses are found between the asci. No efficient remedial measures are known.

Dry-rot (*Trametes pini* (Brot Fr.)).—This fungus is very common in the forests of New England, Canada and Newfoundland. It grows on nearly all coniferous trees; white pine, red spruce, white spruce, hemlock, balsam fir and larch attacking the living trees after they begin to form heartwood. In the tamarack, or larch, the decay goes

much beyond that of the spruce and balsam fir. In the early stages, according to von Schrenk, small white spots appear, which occupy the entire width of an annual ring. Two or more of these spots soon join, at first in a longitudinal direction, then laterally also, so that one or more rings of woods are transformed to cellulose. The rings are thus separated from adjoining ones so that a series of easily separable tangential plates are formed. The line of separation between the rings is always at the point where the summer wood stops and the spring wood of the following year begins.

The progress of decay is marked by the attack of more and more sound wood fibers which are reduced to loose fibers of cellulose until the wood has disappeared, when black lines appear, scattered irregularly. The tangential plates become ultimately extremely thin and they then consist of the resistant summer wood cells more or less infiltrated with resin. The whole of the former woody cylinder becomes a mass of separate fibers which can be pulled out individually.

The fruiting organ is found commonly on all of the affected trees. It is readily distinguished from allied forms by the light red-brown color of the hymenial surface, and the regular small round pores. The form of the pileus varies greatly. Sometimes the brackets are large on the larch, 10 cm. (4 inches) in width laterally, 7 cm. (2.8 inches) from front to back, and 5 cm. (2 inches) in thickness, and are formed at the ends of old hard stubs and at scattered points on the bark. Sometimes sessile sheets are formed inside of the brackets. The basidia, which form the hymenial surface that lines the pores, are smaller at the apex and form from slender, spore-bearing sterigmata. The basidiospores are brown at maturity.

Lemon (*Citrus limonum*, Risso.)

Brown-rot (*Pythiacystis citriophora*, R. E. Smith).—The disease is characterized by a copious exudation of gum from the trunk just above the bud union. A certain area of the bark surrounding the part which shows gummosis dies, becomes hard and dry without any evidence of the fungous parasite. It appears especially destructive on the fruits after packing, and is recognized as a brownish, or purplish, discoloration of the rind, which is lighter green than on the ripe fruits. It spreads rapidly from fruit to fruit, and is also characterized by its peculiar odor and the presence of small flies attracted to it. The

mycelium penetrates the lemon rind and consists of much-branched extensive hyphæ of irregular diameter. Conidiospores which represent zoosporangia appear under favorable conditions. They measure 20 to 60 by 40 μ to 90 μ and are lemon-shaped with a pronounced protuberance at the apex. Upon opening a number of biciliate zoospores are liberated.

Infection of the fruit usually takes place in the orchard and also during the operation of washing the lemons preparatory to packing them. The wash water, therefore, should be treated with copper sulphate, formalin, or potassium permanganate. In using formalin, it is made up in one part to ten thousand parts of water, or 1 pint to about 1200 gallons. Where the cheaper copper sulphate is more available, 1 pound should be dissolved in 250 gallons of water.

Sooty Mold (*Meliola Penzigi*, Sacc., and *M. camelliæ* (Catt.) Sacc.).— This fungus is widely distributed in those districts where citrus fruits are grown. It is most injurious to the orange, but occurs on the lemon as well, appearing on both leaves and fruits. The mycelium forms a sooty black covering on the leaves, twigs and fruits and is usually associated with various scale insects and aphids, which exude a honey dew upon which and the dead bodies of the scale insects the fungus feeds as a saprophyte. The mycelium consists of large branched threads, which are closely septate, and the branches are cemented together to form a false stratum, which lives purely as a superficial saprophytic growth without penetrating into the tissues of the citrus plant on which it is found. Certain hyphal branches flatten out and probably serve as appressoria. The reproductive cells are of various kinds, such as stylospores in pustules, pycnidia with pycnidiospores (pyncospores) and perithecia. The stylospores arise from small conidiophores within peculiar, elongate, flask-shaped structures. The pycnidia are small and scattered. The perithecia are spheric and in close asci with eight dark elliptic, three- to four-septate spores.

The most effective substance for the treatment of sooty mold has been found by Webber to be the resin wash.¹ The mixture consists of

Resin.....	20 lb.
Caustic soda (98 per cent.)	4 lb.
Fish oil crude.....	3 lb.
Water to make.....	15 gal.

¹ DUGGAR, B. M.: Fungous Diseases of Plants: 215.

Webber prepares the mixture as follows: Place the resin, caustic soda and fish oil in a large kettle, pour over them 13 gallons of water, and boil until the resin is thoroughly dissolved, which requires from three to ten minutes after boiling has commenced. While hot, add enough water just to make 15 gallons. It is advised to make about two sprayings when the white fly (*Aleyrodes*) is in the larval stage. In Florida winter sprayings are important, but a spraying in May is also often desirable. In all cases dilute the stock solution with 9 parts of water.

Lettuce (*Lactuca sativa*, L.)

Drop (*Sclerotinia libertiana* Fckl.).—This is one of the most disastrous of the sclerotium-producing fungi to garden and greenhouse plants, being widely distributed and difficult to control. It attacks greenhouse lettuces, causing at first flagging, then indications of water-soaked areas over the stem and basal part of leaves, finally followed by the collapse of the whole plant into a formless mass. The mycelium may grow on the surface of the lettuce leaves and black sclerotia may be formed there commencing as white condensations which finally turn black. Conidiospore formation is not certainly known in the lettuce-drop fungus. Sclerotia, however, are commonly formed which measure 3 cm. in length and these are formed even on artificial culture media. The apothecia are wineglass-shaped with long black stalks. The asci formed on the upper depressed side of the apothecia are cylindric and measure 130 to 135 μ by 8 to 10 μ , while the ascospores are small, 9 to 13 μ by 4 to 6.5 μ .

All dead and diseased lettuce plants should be destroyed by fire and the ground where they grew soaked with some suitable fungicide so as to confine, or practically exterminate the disease. The soil should be sterilized with steam before planting.

Lilac (*Syringa vulgaris*, L.)

Powdery Mildew (*Microsphaera alni* (Wallr.) Wint.).—During the summer months and late in the autumn, the upper surface of the leaves of the lilac will be found covered with a whitish mildew which consists of interlacing hyphæ, which form a cobwebby, superficial growth. Short haustoria are produced which grow into the epidermal cells.

The mycelium develops upright vertical conidiophores which abstrict off conidiospores in chains. These conidiospores no doubt account for the rapid spread of the disease, which is never very serious to the lilac shrubs, but no doubt to some extent interferes with the normal physiologic processes of the leaves. Subsequently perithecia are formed which are spheric in shape, almost jet black in color, and which are surrounded by a circle of hyphæ known as appendages, which are curved or dichotomously hooked at the extremities. Each perithecium produces 3 to 8 asci, and each ascus contains 4 to 8 relatively small ascospores, which measure 18 to 23 μ by 10 to 12 μ (Fig. 54).

Maple (*Acer* spp.)

Decay (*Fomes fomentarius* (L. Fr.) (Fig. 188).—The sporophores of this fungus are hoof-shaped and appear first as small rounded knobs on the surface of the trunk, or at branch stubs. The upper surface is smooth and more or less definitely marked by concentric ridges. The older fruit bodies owing to the action of the weather are uniformly gray and appear as if powdered. The lower surface is reddish-brown in color and shows numerous, small round pores. The margin of the new layer is grayish white and very soft and velvety. The sporophores are found usually singly, although by proximity of two, or several, they may appear grouped together. The decay produced in the wood of deciduous trees by *Fomes fomentarius* begins in the outer alburnum immediately beneath the bark layers, and extends inwardly, until it reaches the pith of the tree. The rotten wood is distinguished by a large number of irregular black lines outlining areas of sound wood. Wholly decayed wood is extremely soft and spongy, light yellow and crumbles into numerous separate wood fibers when rubbed. The tinder fungus, *Fomes fomentarius*, is found in the deciduous forests of Michigan, Minnesota, New England, New York, Wisconsin and in other states. It grows rapidly in dead wood and the mycelium will form large masses if the infected timber is kept under moist conditions.

Leaf-blotch (*Rhytisma acerinum* (Pers.), Fr.).—The tar spot of the maple is found about Philadelphia usually on the silver maple to which it does slight injury. The black irregular spots are, however, always of interest to the laymen and questions are asked frequently about their cause. The spot begins, as a yellow thickened area, when the maple

leaves are expanded fully. The epidermis is pushed up by short conidiophores which arise from a hyphal stroma beneath. These conidiophores produce unicellular, curved conidiospores which serve to distribute the fungus. Formerly this stage was called *Melosmia*. Later



FIG. 188.—Cross-section of branch of dead beech rotted by *Fomes fomentarius*. (After von Schrenk, Hermann, Bull. 149, U. S. Bureau of Plant Industry, pl. viii, 1909.)

as the season advances, the hyphæ become massed into a sclerotium-like area black without, but white within, and this persists after the fall of the leaf. Sometime the next spring, there arise from these sclerotia complex apothecia often 1.5 cm. broad, which break through at irregular

fissures. The club-shaped asci bear eight acicular ascospores between which are found paraphyses with hooked tips. These ascospores measure 65 to 80 μ by 1.5 to 3 μ and are ejected forcibly from the ascus. As the disease is not a serious one, usually no remedial measures are necessary. If the owner of maple shade trees wishes to keep it in check, he should burn the dry maple leaves which litter the ground about his place.

Melons, Squashes, Watermelons (*Cucurbita* spp.)

Anthracnose (*Colletotrichum lagenarium* (Pass.), Ell. & Hals.—As an illustration of a disease-producing fungus included among the Fungi Imperfecti, we may describe briefly the anthracnose of cucumbers, squashes, watermelons, *Colletotrichum lagenarium*, which attacks both leaves and fruits. The leaves are found with brown spots which cause their early maturity. If the fungus attacks the fruits, it produces sunken water-soaked spots in which the acervuli appear. The acervuli produce numerous conidiospores sticking together to form viscid masses of a pink color. During moist weather, the hyphæ may grow out, superficially covering the fruit with a mold-like growth. The fungus eventually causes a complete decay of the fruit. The disease has been prevalent in Nebraska and New Jersey. If the disease appears in greenhouse culture, it is well to sulphur the greenhouses thoroughly when they are empty, and to clean and whitewash all the walls and woodwork to destroy any funguses present. Spraying with Bordeaux mixture (3-6-50) should begin when the vines begin to trail over the ground. Subsequent sprayings should be made every ten days, if the weather is dry.

Wilt (*Bacillus tracheiphilus*, E. F. Sm.).—This serious disease of cucurbitaceous plants was first reported by Erwin Smith about 1893. It was first known in the northeastern states, but it is now common in the middle west and Rocky Mountain regions. Although pumpkins and squashes may be attacked by wilt, yet cucumbers and melons are most susceptible. This microörganism, which is a rod-shaped bacillus two or three times as long as broad, is actively motile by wavy cilia only when young. It measures 1.2 to 2.5 μ by 0.5 to 0.7 μ . It causes a progressive wilting of the host which it attacks. Whether the whole plant dies depends upon the point of infection, which is usually ac-

complished by biting insects. If a leaf is attacked, it dies back to the stem. If the basal part of the stem is infected, the plant rapidly succumbs. This rapid wilting is due to the fact that the organism lives in masses in the vessels of the xylem by which the water taken up by the roots is distributed throughout the plant, hence any occlusion of these spiral and pitted vessels stops the water supply and the plant suffers. Advanced stages of the disease may be characterized by the disintegration of the vascular system and the formation of cavities in the adjacent parenchymatous tissue. Smith sums up the cultural characteristics of this organism, as follows: Stains readily; smooth; white; viscid; glistening; slow grower on media; surface colonies small, round, discrete; no growth at 37°C. or at 6°C. (16 days); aerobic; facultative anaerobic (with grape-sugar, cane-sugar or fruit-sugar); usually it grays potato after a time; clouds peptone-bouillon and Dunham's solution thinly; growth retarded in acid juice of cucumber-fruits; also retarded or inhibited by juice of many vegetables, e.g. table-beet, sugar-beet, turnip, etc.; grows on many media at 25°C., carrot, coconut, etc.; thermal death point 43°C.; optimum for growth 25° to 30°C., maximum, 34° to 35°C.; easily killed by dry-air, sunlight, freezing; ammonia production moderate, in litmus milk persistent growth without reduction or distinct change in color of litmus; killed readily by acids. Group No. 222, 232, 2023. As the disease is distributed by insects, the grower of cucurbits should endeavor to reduce the number of these pests by the use of kerosene, or arsenate spray, and trap plants should be grown to attract the insects away from the more valuable plants.

Oak (*Quercus* spp.)

Decay (*Polyporus sulphureus* (Bull.) Fr. Figs. 189 and 190).—The decay induced by *Polyporus sulphureus* is often called the red heart-rot. It attacks not only oaks, but also the chestnut, maples, black walnut, butternut, alder, locust, etc. It is widely distributed in North America and Europe. The sporophores of this fungus form a series of superimposed, fleshy brackets of a sulphur-yellow color, weighing in the aggregate at times almost one hundred pounds (Fig. 189). The color sometimes may vary to an orange-red. The under surface is usually a light yellow color and beset with numerous minute pores. At maturity, the fruit bodies lose their soft character and become harder and more brittle,

and frequently, become the prey of maggots which riddle them with holes and burrows. It is also eagerly gathered by mycophagists who know it to be an excellent article of food.

The mycelium of the fungus may live in the dead wood of a tree after it has been killed for a number of years, so that the same tree may produce successive crops of edible fruit bodies. The destruction, which the mycelium works, is characteristic. The heartwood is reduced to a crumbly brown mass which resembles charcoal in its fracture, but is



FIG. 189.—Fruiting body of *Polyporus sulphureus*. (After von Schrenk, Hermann, Bull. 149, U. S. Bureau of Plant Industry, pl. iv, 1909.)

red-brown in color. The decayed wood shows concentric and radial cracks extending irregularly through it (Fig. 190). As the wood is attacked and destroyed by the spreading mycelium, these cracks increase and in them are found leathery compact sheets of mycelium, which can be isolated by reducing the decayed wood to a fine powder by the blows of a hammer. The wood decays uniformly and is converted into a brittle brown substance, which can be rubbed to a fine powder between the fingers. Von Schrenk found that the youngest trees in which the red heart-röt occurred were about 50 years old. The removal of dis-

eased trees seems to be the only efficient method of checking the spread of *Polyporus sulphureus*.

Honeycomb Heart-rot (*Stereum subpileatum*, W. H. Long).—The pocketed, or honeycomb, heart rot has been found on the following.

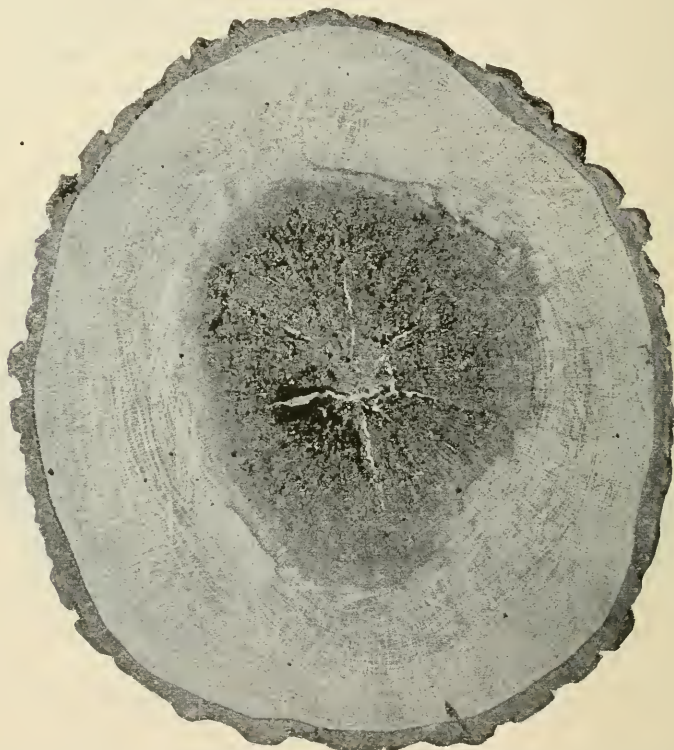

FIG. 190.—Cross-section of a living post oak tree rotted by *Polyporus sulphureus*. (After von Schrenk, Hermann, Bull. 149, U. S. Bureau of Plant Industry, pl. iv, 1909.)

nine species of oaks: *Quercus alba*, *Q. lyrata*, *Q. marilandica*, *Q. Michauxii*, *Q. minor*, *Q. palustris*, *Q. texana*, *Q. velutina* and *Q. virginiana*.¹

The first indication of this honeycomb heart-rot in white oak is a slight discoloration of the heartwood, which assumes a water-soaked appearance, which may extend from 1 to 6 feet beyond the actual decay.

¹ LONG, W. H.: A Honeycomb Heart-rot of Oaks caused by *Stereum subpileatum*, Journal of Agricultural Research V: 421-428, Dec. 6, 1915.

The water-soaked heartwood becomes tawny in color when dry. Light-colored, isolated areas now appear in the discolored wood and these areas originate the pockets. The rot spreads in all directions into the surrounding tissue, but more rapidly in the summer wood of the annual ring of the preceding year, so that the bulk of the pocket lies in the summer wood of one year and the spring wood of the succeeding year. Delignification now follows in which delignified wood fibers appear in patches in the light-colored areas, and this delignification spreads rapidly until white, oval to circular pockets are formed. These lens-shaped pockets are at first filled with white cellulose, which is later absorbed, leaving cavities. The diseased area increases in size until the pockets reach a large medullary ray, which seems to check the activity of the enzyme, so that the larger medullary rays become the radial walls of the pockets. All the cellulose finally disappears, leaving the pockets either (1) empty, (2) containing the shrunken white membranes of the included vessels, or (3) more or less filled with mycelium. The last stage of the rot is characterized by the very light and honeycombed nature of the wood. The pockets are longer than they are broad, and all of the wood has disappeared, except the thin walls around the pockets, which remain distinct and usually involve the heartwood uniformly. The rotted wood is, therefore, in the shape of a cylinder and there is a brownish discoloration of the heartwood on the outer edges of the affected area.

The growth of the mycelium seems to be preceded by the enzymes which cause the disintegration of the wood. A few of the larger vessels show hyphal threads and these become more numerous, as delignification advances, until they become stuffed with small, intricately branched, colorless hyphæ. When the hyphæ are exposed to the air, they become brown in color. The sporophores are found on dead trees, or the dead areas of living trees. The sporophores are thin shelving bodies formed in the cracks of the bark, sometimes assuming a conchate shape. They sometimes form in parallel lines, and range up to 5 cm. in width. These sporophores may be formed on the dead tree for a number of years. This fungus is widely distributed in the southern states and ranges as far north as Ohio. The only method of control is to prevent the infection of trees by eliminating forest fires, by preventing the formation of the sporophores, and the destruction of all diseased timber which has the rot.

Root-rot (*Armillaria mellea*, Vahl).¹—The “hallimasch” of the Germans, or the so-called honey mushroom, is a fungus of considerable interest to the forester (Fig. 15). The spores, if blown to an exposed branch stub, may germinate and produce a mycelium which works up and down the tree. Infection may be also by the mycelium growing across from the roots of a diseased tree to a healthy one through the soil of the forest. In either case, the young mycelium grows into the cambial layer, attacks the living cells, and finally completely encircles the trunk of an infected tree. Later the hyphæ are converted into strands, which show a characteristic apical growth, thus providing for the elongation of the strands through the host. The strands of hyphæ turn a deep chocolate-brown color and are known as rhizomorphs (Fig. 15), which may anastomose under the bark of the tree. Ultimately, as the tree dies, the bark splits off and the rhizomorphs are found flattened against the woody cylinder of the tree. If such trees are used as mine props, the strands may keep on growing under the moist even temperature of the mine and there they may hang down in long streamers into the mine galleries, as specimens of such in the botanic museum of the University of Pennsylvania indicate. The effect of the mycelium in the tree is to kill its top with the ultimate death of the entire tree. The rhizomorphs formerly known as *Rhizomorpha subterranea* grow out into the root system of the tree, which they kill, and here they may live for a number of years, endangering the nearby healthy trees, because they extend out into the soil toward other tree roots. It is this subterranean growth, which makes the honey mushroom an extremely dangerous one to the hardwood forests, where it is found. The fruiting bodies of this fungus usually occur grouped in considerable numbers about the base of the affected tree arising from the dark-brown rhizomorphs, which thus serve to connect together isolated groups of the sporophores. The sporophores produced most commonly from September to November are honey-colored, *i.e.*, yellow to orange-brown, and their umbonate tops have a more or less viscid character with small black spicules scattered over the surface. The stipes are slightly swollen at the base and a short distance below the pileus is found the ring, or annulus. The lamellæ are dirty-white and from each pyriform basidium four white basidiospores fall until surround-

¹LONG, W. H.: The Death of Chestnuts and Oaks due to *Armillaria mellea*. Bull. U. S. Dept. Agric. No. 89, 1914.

ing leaves and mosses may be coated with a mealy powder derived from the gills of several sporophores directly over them.

Oat (*Avena sativa*, Linn.)

Rust (*Puccinia coronifera*, Kleb).—The oat rust, or crown rust, affects oats and also several other grasses. The summer stage appears on oats just prior to the period of ripening where it forms an elongated uredinium of an orange color on the leaves and sheaths. The globular spores germinate readily. The teliospores are formed later as black spots around the edge of the uredosori. As the teliospores bear at their apex a crown of blunt projections, or processes, the common name of "crown rust" has been applied. Such winter spores remain in a resting condition until the following spring, when they germinate in the usual way. The basidiospores, which are formed from the basidium, or promycelium, begin growth on the leaves of the buckthorn, *Rhamnus cathartica*, where within eight to ten days cluster cups (*Æcidium catharticæ*) appear. The æciospores germinate readily and are blown to the oat and other grasses, such as perennial rye grass, Yorkshire fog, so that at least eight forms of the species limited to certain hosts have been distinguished. The measurements of its spores are as follows: Æciospores, orange, vermiculose, 16 to 25 μ by 12 to 20 μ ; Uredospores globose to obovate, echinulate yellow, 18 to 27 μ by 16 to 24 μ ; teliospores brown, two-celled, crowned with rough projections; approximately 35 to 60 μ by 12 to 22 μ .

Smut (*Ustilago avenæ* and *U. levis*). The appearance of this disease is illustrated in the figures (Fig. 191).

Onion (*Allium cepa*, L.)

Smut (*Urocystis cepulæ*, Frost).—This fungus, probably of American origin, is found in the onion growing districts of the eastern United States where it has been known for about 50 years. The smut frequently appears soon after the first leaf appears, and is first in the form of dark spots at the base of the first leaf and on succeeding leaves, as they make their appearance. These spots are followed by longitudinal cracks, which show a granular spore powder associated with threads of fibrous tissue. The spore powder under the microscope is found to consist of the spore balls, which number several compacted cells, the

central one of which contains cytoplasm, being surrounded by an envelope of sterile cells. Such spore balls are 17 to 25 μ in diameter



FIG. 191.—Smut of oats. A, *Ustilago avenae*; B, *Ustilago levis*. (After Jackson, H. S., Bull. 83, Del. Coll. Agric. Exper. Stat., December, 1908.)

and may retain their capacity for germination in the soil for a period of 12 years.

As the spores occur in the soil, it is useless to treat the onion seeds with chemic bodies. The most successful method of prevention is to transplant the seedlings into beds known to be free from smut. Some growers place sulphur (100 pounds to the acre) and air-slacked lime (50 pounds) in the drills as the seeds are planted.

Orange (*Citrus aurantium*, L.)

Black-rot (*Alternaria citri*).—Only navel oranges are subject to black rot which is recognized by the premature ripening, large size of the fruit and its deep red color. The fungus gains entrance through the navel end, because there imperfections of the skin occur. There soon arises a black area of decay under the peel which remains isolated for some time without spreading, therefore, the disease is not very virulent. In *Alternaria*, the conidiophores are in bundles, always unbranched and short. The conidiospores are club-shaped to flask-shaped, divided and united into chains by thinner cells.

Fruit-rot (*Penicillium italicum*, Wehm.).—A large part of the decay of the orange and other fruits of the genus *Citrus* is due to blue and green molds. These molds usually cannot enter uninjured fruits, and so their attacks usually follow a bruise occasioned by careless handling, or when the fruit falls from the orange tree. *Penicillium italicum* seems to be more common than the other species, *P. digitatum*. Pure cultures of this fungus can always be secured from decaying oranges in the market, which have the blue-green areas of rot just beginning to appear upon them. These areas are usually blue-green in the center surrounded by white areas which are grouped usually into little white patches toward the vegetative margin and the whole superficial colony surrounded by an area of soft watery rot. Sometimes, as the colonies become older, *P. digitatum* mixes with *P. italicum*.

The conidiophores are short (100μ), or very long (600μ) and black in media containing sugar. They average about 250μ in length. The conidial fructifications are up to 300μ or more in length, consisting usually of a main branch and one lateral branch, each producing a whorl of branchlets bearing crowded verticils of conidiospores, 12 to 14 μ by 3 μ . The chains of conidiospores are cylindrical to elliptic, slightly ovate, clear green by transmitted light and measure 2 to 3 μ by 3 to 5 μ . Decay of this sort can be prevented by careful handling of the fruit in field and packing house.

Pea (*Pisum sativum*, L.)

Pod-spot (*Ascochyta pisi*, Lib.).—The horticulturist, who attempts to grow the garden pea, will find that the leaves and pods become spotted with conspicuous, circular, sunken spots 3 to 6 mm. in diameter, which are dark bordered, pale in the centers and slightly pinkish when mature. Pycnidia are associated with these spots and out of their porous opening under favorable conditions the spore masses may be seen issuing. When the leaves are affected, it is usually the lower leaves which become diseased first, and such soon die. If the stems are attacked, the spots sometimes penetrate through the woody part. Different races of peas differ as to their susceptibility. The variety Alaska is slightly affected, while the varieties American Wonder, French June and Market Garden are frequently badly diseased. According to Stevens, the pycnidia consist of angular cells, 5 to 7 μ with a rounded ostiole and reddish-brown surface. The conidiospores are constricted slightly at the septum, are oblong and measure 12 to 16 μ by 4 to 6 μ . The mycelium perennates in affected seeds, reduces their power of germination and carries the fungus over to the next crop. Selby has indicated that healthy peas may be grown by spraying with Bordeaux mixture, and it has been suggested, that a two years' rotation of non-susceptible crops lessens the prevalence of the disease, if another pea crop is raised.

Peach (*Amygdalus persica*, L.)

Leaf Curl (*Exoascus deformans* (Berk.), Fckl.) (Fig. 192).—This disease is called by the French *Cloque du pecher*, by the Germans *Kräuselkrankheit* and by Americans and English peach leaf curl. It is widely distributed through America, Europe, China and Japan and in Africa and Australia, so that it is practically cosmopolitan.

The disease is most prevalent and most disastrous to the leaves and tender shoots of the peach, when the spring months are damp and cool, for records show that such conditions prevailed during April of the year 1893, 1897 and 1899, when peach leaf curl was especially abundant in Ohio and New York. Warm and relatively dry springs seem to be unfavorable to its occurrence. The susceptibility of the host plants differs to a marked extent, some being susceptible, others less so.

The presence of the disease may be detected when the leaf buds unfold, for the coloring of the young leaves is heightened, and as they

open out, the curling and arching of the blades become manifest. The curling may be confined to a small portion of a leaf, or it may be general and all of the leaves of a tree may be affected, as well as the young stem on which they are found. The green, or reddish, color of



FIG. 192.—Peach leaves deformed by leaf curl (*Exoascus deformans*). (After Heald, *F. D.*, Bull. 135 (*Sci. Ser.* 14), Univ. of Tex., Nov. 15, 1909.)

the leaves is lost as they mature, and they become pale, or slightly discolored. Diseased shoots may grow to twice their normal diameter and assume a characteristic paleness. The diseased leaves finally turn brown and drop off the tree, and if this defoliation is excessive

the crop of peaches may be nil. The twig affection is sometimes associated with gummy exudations, particularly when the enlargement is terminal. It is doubtful whether the mycelium perennates in the twigs, as was supposed in former years. Infection must generally occur as the buds unfold.

The mycelium of the fungus may be studied most advantageously in the leaf before the fungus has appeared on the surface. At that time, the hyphæ show a greater protoplasmic content and sections reveal the fact that the intercellular mycelium is distributed through the mesophyll and cortex of the young stems. Pierce distinguishes vegetative hyphæ, distributive hyphæ and fruiting hyphæ. The latter push up between the epidermal cells and a series of short hyphal cells are formed, as ascogenous cells, which form an almost continuous layer beneath the cuticle. The ascogenous cells give rise to the asci, which push through the cuticle. An ascus is usually truncate at the exposed end and it gives rise to four to eight ascospores, which may bud within the ascus.

Leaf curl may be controlled by the use of lime-sulphur solution (1-20), Bordeaux mixture (5-5-50) and copper sulphate in water (2-50), for the use of which the practical man is referred to the spray calendar given in the subsequent pages of this book.

Pear (*Pyrus communis* L.)

Fire-blight (*Bacillus amylovorus* (Bun.), De Trev. Toni).¹—This bacterial disease is found on the apple, pear and quince, but more especially on the pear, so that it has been termed pear blight. It was first reported from the northeastern United States, but now it is distributed throughout the country from the Atlantic to the Pacific oceans. The disease first makes its appearance in the early part of the season, when it appears in the form of a twig blight throughout the time of blossoming of apples and pears, when the blossoms and tips begin to wilt and show signs of blackening. This results in the complete blackening and death of all the short branches, or spurs, upon which flower clusters have been borne. The fire blight disease may continue to extend down the twig, or the branch, the branch being entirely killed, as it progresses. Under conditions more favorable to the host

¹ ORTON, C. R. and ADAMS, T. F.: Collar-blight and Related Forms of Fire-blight. Bull. 136. Penna. Agricultural Experiment Station August, 1915.

the blight may extend only a short distance, which results in tip pruning. The bark of the tree indicates the progress of the disease, for the soft bark assumes a water-soaked appearance followed by a blackening and shriveling. When the organism ceases to spread rapidly in the tissues, there appears a sharp line of separation between the dead and the healthy tissues. The bark is broken and through the bark cracks appear gummy, or gelatinous, drops which vary in color from white to brown, or black.

Bacillus amylovorus was described first by Burrill in 1877, a discovery full of significance to plant pathology, because it established the first bona fide case of a plant disease due to bacteria. It has been established, that infection takes place through the visits of insects, especially bees, to the pear flowers. From the floral nectary, the bacillus spreads to the softer tissues of bark and cambium, where it is very largely confined, and where it winters over, spreading to other blossoms the next spring. *Bacillus amylovorus* is an oval microorganism 1.5μ to 2μ long, growing singly, or several attached end to end, and is motile in fresh cultures. On agar, the cloudy and white surface colonies appear the second day, and attain a diameter of 2 to 3 mm. by the fourth or fifth day. Cloudiness appears in bouillon after twenty-four hours, and in milk, thickening of the medium begins at the third or fourth day, which increases until the fifth, or sixth day, when the product is finally partially gelatinous with a clear acid liquid above, changing to slightly alkaline.

The work of Waite has shown that pear blight can be controlled by pruning out the blight during winter, so as to eliminate the source of infection during the next year, and if this pruning is done thoroughly, the disease can be kept in check. The stubs should be disinfected with corrosive sublimate (1-100).

Fine (*Pinus* spp.)

Blister-rust (*Cronartium ribicolum*, Fisch & Waldh. = *Peridermium strobi*, Klebahn).¹—This disease, as it appears on white pine,

¹ SPAULDING, PERLEY: The White Pine Blister Rust Situation, American Forestry 22, pp. 137-138, March, 1916; The Blister Rust of White Pine, Bull. 206, U. S. Bureau Plant Industry, 1911; also consult American Forestry, Feb., Mch., Dec., 1916. In the December, 1916, number a map showing the distribution of the disease is given. A conference was held at Washington in January, 1917, to consider the establishment of stricter quarantine regulations of the methods of checking the spread into the western states.

has been considered to be of such great importance, that strict quarantine regulations were established in order to keep it out of the country, but the result of a thorough exploration of the New England States during the summer of 1916 has shown its general distribution throughout them and even as far west as Minnesota. It appears to have been

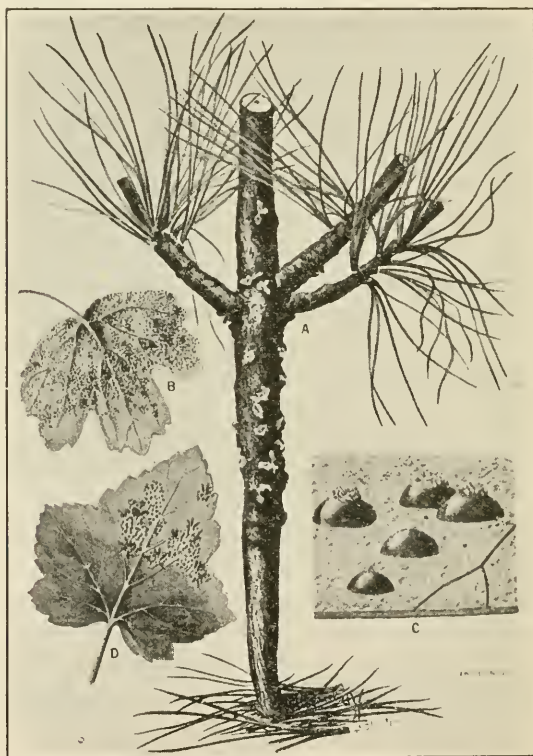

FIG. 193.—White pine blister-rust, *Cronartium ribicola*. A, Diseased tree with aëcial blisters broken open from which spores are blown to currant or gooseberry leaves; B, D, teliosori on under leaf surface of currant, *Ribes*. (From Gager, after Perley Spaulding.)

introduced into America on nursery stock from Holland, and all the trees in these advanced posts of infection have been destroyed. In 1906, there was an outbreak on currants at Geneva and measures were taken to destroy the fungus in that vicinity. The aëcial stage, known as *Peridermium strobi*, appears on the pine tree and the uredinia and the

telia on species of the genus. *Ribes*, viz., *R. aureum*, *R. nigrum*, *R. rubrum* with which intermediate hosts (it does little damage). The susceptibility of different currants varies considerably (Fig. 193).

The attacked white pine trees are stunted, the tops show a bushy growth and the part of the tree where the mycelium occurs is swollen. The leaves of the currant infested by the fungus are thicker in texture and assume a different color. The æcidia are crumpled from the bark in the form of a bladder with an inflated peridium about one centimeter high and yellowish-white. The spores are roundish, or polygonal, coarsely verrucose, orange in color and measure 22 to 29 μ by 18 to 20 μ . The urediniospores form orbicular groups surrounded by a delicate peridium which opens at the summit with a pore. They are ellipsoid to obovoid in shape, echinulate, orange and their dimensions are 21 to 24 μ by 14 to 18 μ . The smooth teliospores are crowded along the veins of the leaf. They are orange to brownish-yellow, 70 μ long by 21 μ broad.

This serious disease may be controlled by the destruction of the hosts, namely, the currant and gooseberry bushes especially in the wild state. This disease threatens the extinction of all the species of five-leaved pines including those of the Pacific States, such as sugar pine, *Pinus lambertiana*.

Red-rot (*Polyporus ponderosus*, H. von Schrenk).—The red rot of the western yellow pine (*Pinus ponderosa*) usually starts in the tops of the "black-top" trees, i.e., trees which have been dead for two or more years. At one or more points, one will find that the wood immediately under the bark starts to rot and the rot proceeds inwardly to the wood which becomes wet and soggy, and rapidly becomes brittle, so that it crumbles into small pieces when rubbed. The color of the wood changes to blue and later to red yellow. When the decay has gone on for some time, bands and sheets of a white felty substance consisting of masses of hyphæ are found filling certain cracks which result, because of shrinkage in the wood mass. The destruction of the wood continues until the heartwood is reached.

Red-rot is caused by a higher fungus which enters the tree through beetle holes made into the dead cambium of the wood killed by the "blue" fungus which precedes the red rot. When the wood has been completely destroyed red-rot fungus forms its sporophores which begin to grow out from the mycelium, as flesh-colored knobs, which rapidly in-

crease in size and turn reddish in color, assuming the form of a bracket, or shelf. The lower surface is beset with pores, or tubes, on the walls of which the spores are borne. This bracket fruit may grow many years, and it adds a ring on the outside when new growth commences. The fruit bodies may occur singly or in groups of two or three together. They are rough on top and appear to be covered with a waxy substance, which has hardened and cracked. It is brittle and readily soluble in alcohol and xylol. The lower surface is smooth with regular pores.¹



FIG. 194.—Black-knot of plum, *Plowrightia morbosa*, on cultivated plum, Cold Spring Harbor, L. I., July 26, 1915.

Plum (*Prunus americana*, Marsh)

Black-knot (*Plowrightia morbosa* (Schw.), Sacc.).—The black knot was at first mainly confined to the New England states, but it now extends across the northern United States to the Pacific coast with areas free from the disease in the middle west and southwest. Several species of plums and cherries are susceptible.

The disease appears as wart-like excrescences on the smaller and larger branches of plum trees (Fig. 194) which it either surrounds completely killing the terminal part of the branch, or only part way round when the branch continues living and fruit-bearing (Fig. 194). The common name is well given, because

¹VON SCHRENK, HERMANN: The "Bluing" and the Red Rot of the Western Yellow Pine, with Special Reference to the Black Hills Forest Reserve. U. S. Bureau of Plant Industry Bull. 36, 1903.

the hypertrophies are black in color. The knot begins as a slight swelling of the branch, and as the swelling increases in size the bark is cracked (Fig. 194).

The mycelium of the fungus occupies the cambium and bast areas of the stem, extending throughout the cortex also. The knot consists of dense areas of the fungus and tissue elements of the host. Bast fibers, parenchyma cells and even vessels may be found in the gall tissue. In the spring, small greenish areas may be noticed on the surface of the knot, and later, the hyphæ break through the bark in all directions and form a pseudoparenchymatous layer. This stomatic layer gives rise to the conidiospores, which are flexuous and septate. The conidiophores are 40 to 60 μ by 4 to 5 μ and the conidiospores abstricted off are light brown in color. Conidiospores are formed from Spring to late midsummer. They are simple and light brown in color. The fungous stromata is covered with papillæ which locate the opening of the perithecia which include the asci with eight ascospores, that ripen during midwinter, or later. Each ascus is 120 μ in length and the ascospores measure 16 to 20 μ by 8 to 10 μ . Between the asci are paraphyses.

Since the conidial stage is produced during late Spring and early Summer pruning out the developing knots is found an efficient remedy in most cases against black knot.

Plum Pockets (*Exoascus Pruni*, Fckl.).—The plum pocket fungus is widely distributed over the United States and Europe and its etiology of the disease it produces is somewhat similar to that of the peach leaf curl. The mycelium lives in the flower buds and causes remarkable changes in the ovaries, as they develop into fruits. The hyphæ are found in the mesocarp, the cells of which are stimulated to form a spongy growth, so that the plum fruit becomes swollen and somewhat distorted. As a result of the fungus attack, the endocarp which normally would develop a putamen, or stone, fails to do so, and no stone, or seed, is formed, but in their place a cavity appears which gives the common name to the disease. The mycelium is probably perennial in the twigs of the plum tree and is, therefore, in a position to grow out into the young ovaries of the next succeeding crop of flowers. The ascogenous cells develop beneath the cuticle of the well-formed fruits and finally rupture the latter, appearing as a velvety layer. The asci are 30 to 60 μ by 7 to 12 μ , although Robinson notes a certain dimor-

phism of the asci where these figures vary. Each ascus contains eight ascospores which measure 4 to 5μ (Fig. 42).

Potato (*Solanum tuberosum*, L.)

Late-blight (*Phytophthora infestans*, deBy).—Historically, this is one of the most interesting of fungi, for in 1845 the potato crops of the British Isles, especially Ireland, were decimated by the late blight to such an extent as to cause a severe famine in Ireland. This famine caused the emigration of hundreds of thousands of people from the Emerald Isle to America and the British parliament in order to alleviate the distress of the poor repealed the corn laws, and thus began the free trade policy of that country.

Formerly, it was thought that the potato disease was distributed widely in America, but it is now known to be most prevalent in New England, in New York and the Canadian provinces, where the potato-growing industry is an important one. It has a wide range in Europe and is known throughout Great Britain and from France to Russia, being especially favored, as it was in 1845, by warm damp weather in the summer months.

The disease is characterized by leaf spots which first appear at the margin, or apex of the leaf, and spread over its surface until the leaf presents a dark somewhat water-soaked appearance. These spots are brown in drier weather and in all cases a withering of the leaf follows the attack of the mycelium. The disease is known as dry-rot, when it develops in the tubers, for the hyphæ enter the cells, as haustoria kill the cells, and the condition of the tuber known as dry rot is produced, which may be found especially in the stored tubers.

The hyphæ of the late-blight fungus are unicellular and they spread through the intercellular spaces of the host sending filamentous haustoria into the cells of the leaves, or tubers. From this internal mycelium, long branched (dendritic) conidiophores grow out through the stomata and the branches bear either laterally, or apically, egg-shaped conidiospores, which measure 27 to 30μ by 15 to 20μ . The conidiospores on germination form eight biciliate zoospores, which are motile for a brief time perhaps not longer than an hour. If one of these swarm spores finds its way to a leaf, germination speedily follows and the hyphal germ tube enters the interior of the leaf either through a stoma, or by boring a hole through the epidermis.

The germ tube of the swarm spores penetrate the tuber, as easily as the leaf, if they happen to be washed down to the soil. Recently G. P. Clinton¹ has discovered the oogonia, antheridia and oospores of *Phytophthora infestans* after they had been sought for by mycologists since 1845, and thus an American mycologist has added one more achievement to the list of important work accomplished by American scientific men.

Spraying the foliage with Bordeaux mixture (5-5-50) has proved an almost complete remedy against both the *Phytophthora* blight and the rot, and also operates beneficially to the potato plant in other ways. Burying the tubers to a sufficient depth (about 4 to 5 inches) has been found beneficial, as also the disinfection of the tubers designed for seed purposes by exposure to dry heat 40°C. (104°F.) for four hours. Tuber infection may be prevented by spraying the soil, even when the fungus is allowed to develop unchecked on the foliage. When the tops are attacked by late-blight, the harvesting of the tubers should be delayed until a week or more after the death of the tops. Longer delay does no harm, unless the season be wet and the soil exceptionally heavy. Dry cool storage is of primary importance, the use of lime, or formalin, for disinfection being valueless.² It seems from investigations, that have been made, that well-marked and fixed differences exist among potato varieties in relative susceptibility to invasion by the late-blight fungus, in other words, in disease resistance.

Powdering Dry-rot (*Fusarium trichothecioides* Wollenw.).—This fungus kept in artificial culture has been used successfully in the artificial inoculation of potato tubers, as laboratory exercise with university students in mycology. In every case, the rot has been secured and the students have imbedded pieces of tuber and fungus in paraffin; cut the same with a rotary microtome and mounted and stained the sections for microscopic study.

Fusarium trichothecioides forms two kinds of conidiospores: (1) The comma type, formed as a slightly curved comma ellipsoidally rounded on both sides; and (2) the normal macroconidiospores. The plecten-

¹ CLINTON, G. P.: Oospores of Potato Blight. Report of the Connecticut Agricultural Experiment Station, 1909-1910: 753-774 with 3 plates.

² JONES, L. R., GIDDINGS, N. J. and LUTMAN, B. F.: Investigations of the Potato Fungus, *Phytophthora infestans*. Bull. 245 U. S. Bureau of Plant Industry, 1912, with full bibliography; MELHUS, I. E., Hibernation of *Phytophthora infestans* of the Irish Potato. Journ. Agric. Research V: 71-102.

chymatic mycelium and conidial masses are rosy white. The powdery dry-rot with pink mycelium-lined cavities is quite characteristic and not easily confused with the other species of *Fusarium* found on potatoes.¹

Scab (*Actinomyces chromogenes*).—This scab disease is one well-known throughout the United States and also in Europe, although all the cases of scabby potatoes are probably not due to this fungus, as a causal organism. Turnips, beets and mangels are susceptible to the disease while carrots and parsnips are not. The first symptoms of the disease are minute reddish-brown spots on the surface of the tuber beginning usually at one of the lenticels of the tuber and spreading rapidly to other tissues, assuming a deeper color and an abnormal corky development over considerable areas. Thus arise the scab-like crusts which have given the common name to the disease. The surface of the tuber frequently becomes cracked to considerable depths. If scabby potatoes are examined immediately after being gathered a fine grayish, evanescent film will be found consisting of extremely delicate, minute, refractive, branched filaments, which break up into bacteria-like cells. Some branches are curved and structures suggesting true spores are produced in certain cells. The writer has found the fungus as minute white specks on horse manure. It has been found to persist in the soil for several years.

The disease can be controlled by soil treatment, by the adoption of a rational rotation of crops and by planting seed tubers only after they have been treated for several hours with a solution of 1 ounce of formalin to every 2 gallons of water, or by a solution of corrosive sublimate in water.

Raspberry (*Rubus occidentalis*, L.)

Anthrachnose (*Glaosporium venetum*, Speg.).—As this fungus produces injuries to the raspberry and blackberry canes, it was called by Burrill, who published the first account of the disease in 1882, the “raspberry cane rust.” It is known to occur in New Jersey, Illinois, Texas, Wisconsin, Missouri and other states.

The fungus attacks both fruiting and non-fruiting canes, or suckers,

¹ CARPENTER, C. W.: Some Potato Tuber-rots caused by Species of *Fusarium*. Journal Agricultural Research V: 183-209, Nov. 1 1915.

producing small purple spots that are variously scattered along the cane. The spots first formed rapidly increase in size, and as the fungus develops the center of each becomes grayish-white in color surrounded by a slightly raised, dark-purple border, separating the healthy from the diseased tissues. The disease progresses in an upward direction and as the advanced stage of the malady is reached, the spots coalesce. The greatest injury is to the cambium, so that the living tissues of the cane become sickly, the leaves do not attain half their normal size, the fruit ripens prematurely, or dries up as worthless. The petioles of the older leaves may be attacked and later the veins of the leaves which show whitish, blister-like spots. The spots on the lamina are smaller than on the canes.

The mycelium lives in the intercellular spaces of the host, but is supplied from the neighboring host cells with nutritive materials. There is at first a slight discoloration of the cell contents, the cells then lose their shape and finally collapse. The conidiophores are formed beneath the epidermis of the host and later appear at the surface bearing the conidiospores, which are surrounded by a gelatinous substance. Pruning away the diseased canes and burning them in a brush heap is the most important means of controlling the raspberry anthracnose. Spraying early in the season with Bordeaux mixture (4-4-50) is useful, although not an absolute preventive.

Red Gum (*Liquidambar styraciflua*, L.)

Sap-rot (*Polystictus versicolor* (L.), Fr.).—*Polystictus versicolor* is one of the most cosmopolitan species of fungi known. It is known from Europe, Africa, Australia, South America, Mexico, Japan, the West Indies and throughout the United States. It grows on the sapwood of every species of deciduous tree known. It is the most serious of all the wood-rotting fungi, destroying probably 75 per cent. of the timber used for railroad ties. A broad sheet of mycelium covers the entire surface of the timber on which it grows, but it develops in the wood, especially the sapwood, in which decay takes place with great rapidity.¹ There is a rapid solution of the various parts of the woody structure for the fungus has no preference for either the lignin, or the cellulose

¹ STEVENS, NEIL E.: *Polystictus Versicolor* as a Wound Parasite of *Catalpa*. *Mycologia*, vi: 263-270, Sept., 1912; see Ante p. 75.

parts of the cell wall, and the parts of the springwood fall apart readily, because of their porous character. The fruiting bodies of this fungus are extremely variable depending upon the kind of wood on which they grow. The sessile sporophores may grow singly, or, more usually, many of them together, forming a series of closely overlapping brackets. They are readily recognized by the soft, hairy upper surface with bands of white and yellow color, although these colors are variable. The young sporophores are fleshy, but become leathery with age. Their lower surface is white and the pores are minute and regular. Treatment of the wood with chemic preservatives has been found efficacious in preventing the attack of such fungi as *Polystictus versicolor*, and most of our large railroads have machinery where the steeping of the ties in chemic preservatives can be accomplished quickly and inexpensively.

Rye (*Secale cereale*, L.)

Ergot (*Claviceps purpurea*, Tul.) (Figs. 56 and 57).—The ergot fungus is found on rye both in America and Europe, where during wet warm weather it may be extremely prevalent. It gains entrance to the host at the base of the young ovary penetrating the ovary wall and gradually replacing the tissues of the rye ovary. This is accompanied by an enlargement of the ovary which at its upper end presents a somewhat spongy character. This is due to the outgrowth of the mycelium in the form of twisted strands, the marginal hyphæ of which acting as conidiophores abstrict off conidiospores. This early stage was known as the *Sphacelia* stage. Later, as the time for the maturing of the healthy grains arrives the diseased ovaries will be found to be replaced by bluish-black horn-like bodies which project conspicuously from between the glumes of the rye spikelet. The rye ovary is replaced by a hard body with a blackish surface and white interior known as the sclerotium. The ergot spurs, or sclerotia, perennate as such until the following spring, when they send up one or several outgrowths, or stroma, with a knob-like end of a yellowish-brown color. In the hyphal tissue, which comprises the knob-like portion of the stroma, flask-shaped perithecia are formed with short necks and slightly protruding ostioles. The asci contained in these perithecia are elongated and contain eight needle-shaped ascospores, which measure 60 to 70 μ in length, and issue from the tip of the ascus by

a small opening. These ascospores bud off conidiospores, which are capable of infecting the ovaries of rye plants, which have started their growth toward maturity the following season.

The ergot spurs are used medicinally under police regulations, for they are dangerous and poisonous. In the Baltic provinces of Germany and Russia, the peasant class frequently eat bread made out of flour in which ergot spurs have been ground. They suffer from gangrenous affections of the extremities with a loss of the hair, teeth and fingernails. A nervous form of ergotism has also been prevalent. Cattle eating ergoted grain show similar gangrenous and nervous symptoms, the loss of hoofs, tails and horns.

Ergot can be controlled to some extent by the selection of the grain seed and by removal of all ergoted masses, when detected in the fields.

A closely related species, *Claviceps microcephala* (Wallr.), Tul., was submitted to the writer by the late Dr. Leonard Pearson on red-top hay, which had been responsible for gangrenous affection of a herd of cattle in Pennsylvania.

Sweet Pea (*Lathyrus odoratus*, L.)

Streak (*Bacillus lathyri*, Manns & Taubenhaus).—This disease had been noted by the growers of the sweet pea in England, and recently, it has been detected in the United States.¹ Like the bacteriosis of beans, streak makes its appearance in the season of heavy dew. On the sweet pea, the disease usually appears just as the plants begin to blossom; it is manifested by light reddish-brown to dark brown spots and streaks (the older almost purple) along the stems, having their origin near the ground, indicating distribution by spattering rain and infection through the stomata. The disease becomes quickly distributed over the more mature stems until the cambium and deeper tissues are destroyed in continuous areas, when the plant prematurely dies. From the stems the disease spreads to the petiole, peduncles, flowers and pods with symptoms similar to those on the stems. On the leaves, however, the disease appears as small roundish spots, which gradually coalesce, and eventually involve the entire leaf, which when

¹ TAUBENHAUS, J. J.: The Diseases of the Sweet Pea. Bull. 106. Delaware Agricultural Experiment Station, Nov., 1914.

killed presents a dark-brownish appearance. If the causative organism, which is a small rod-shaped bacillus, is sprayed upon the sweet

pea plant, the disease makes its appearance from seven to ten days after artificial infection and the symptoms are similar to those produced in nature. The bacillus is rarely found in chains and seldom united in twos or fours. Its flagella are not easily demonstrated, as they are shed so readily that not more than two to five may be stained and these are generally quite short. If properly fixed and stained, very long delicate flagella may be demonstrated, 8 to 12 in number, and peritrichous.

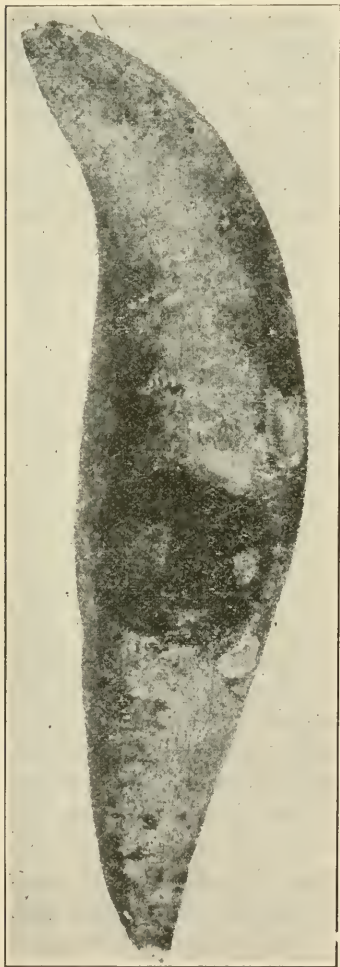

FIG. 195.—Sweet-potato black rot produced by a fungus, *Sphaeronema fimbriatum*. (After Harter, L. L., U. S. Farmers' Bull. 714, March 11, 1916.)

Sweet Potato (*Ipomœa batatas*), Poir)

Black-rot (*Sphaeronema fimbriata* (Ell. & Hals.), Sacc.).—We owe our past knowledge of this disease to Halsted, who in 1890 described this, as well, as other diseases of the sweet potato. It is a seed-bed disease, a field disease and a storage trouble. It is characterized by irregular hard, dark areas, or circular spots, varying in size from that of a dime to that of a silver dollar appearing on the skin of sweet potatoes (Fig. 195). If the root is injured, the fungus follows the line of injury. The sprouts are dwarfed and the foliage turns yellow. The end of the hank is blackened and charred and this is associated with a withering of the leaves which become black and crisp.

Frequently, the stems and petioles are affected and black areas appear on them. In the field the appearance of black girdling lines between two leaves is an indication of the disease. The part below the black line remains healthy, while that above wilts and dies. Stem infection is not always associated with root infections.

The black-rot parasite lives skin deep on the roots extending only to the cambial layer, while in infected stems, leaves and rootlets, it invades all parts. The hyphæ are septate and the cells are filled with oil globules. They are capable of breaking up into as many spores as there are cells, and these spores are denominated chlamydospores. Olive-brown conidiospores are also formed and these are cut off from terminal, or lateral branches. The pycnidia are formed within the diseased areas, and they can be had in artificial cultures. They are flask-shaped with extremely long necks. The pycnospores are more or less subglobose, or oblong, hyaline and measure 5μ to 9μ in length. The mycelium, which has developed to a considerable extent on the root, may develop sclerotia of a large size by which the fungus perennates, and it may also live over on stored roots and pieces of roots left in the field. Pure cultures of the fungus are not difficult to obtain. It grows well on any starchy medium, such as sweet and white potato cylinders and on bean agar. As to the spread of the fungus, various mites, as well, as watering the plants, help to distribute the pycnospores. Roots attacked by the black rot fungus have a bitter taste.¹

The disease can be controlled by the careful selection of seed roots and by a judicious rotation of crops.

Sycamore (*Platanus occidentalis*, L.)

Blight (*Gnomonia veneta* (Sacc. & Speg.) Kleb.).—Within the last few years in southeastern Pennsylvania, the sycamore, or plane trees have been visited in the spring, when the young leaves are about half developed, by attacks of this fungus, so that the young leaves appear as if destroyed by early frosts. It is sometimes very disastrous, es-

¹ WILCOX, E. MEAD: Diseases of Sweet Potatoes in Alabama. Alabama Agric. Exper. Stat. (Auburn) Bull. 135, June, 1906; TAUBENHAUS, J. J. AND MANN, THOS. F.: The Diseases of Sweet Potato and Their Control. Delaware Agric. Exper. Stat. Bull. 109, May, 1915; TAUBENHAUS, J. J.: The Black Rots of the Sweet Potato. Phytopathology III: 159-165.

pecially in low-lying country, as along stream banks, or in closed-in valleys. Whole trees are practically attacked, the young leaves turn brown and then they begin to wither and finally curl up into a brittle mass. It also produces spots on the leaves of the white, black, and scarlet oaks.

Until the life history of this fungus was fully known, it was considered as three distinct types of imperfect fungi by the older mycologists. The fungus known as *Glaeosporium nervisequum* represents the stage, which appears upon the leaves in the form of pustules, or acervuli, especially localized upon the veins of both the upper and lower leaf surfaces. Ovate conidiospores measuring 10 to 15 μ \times 4 to 6 μ are formed upon small colorless conidiophores.

The acervuli measure 100 to 300 μ in diameter and in moist weather the numberless spores are ejected in creamy masses, or strings. The same stage was known on the twigs by the generic name of *Myxosporium*. The *Sporonema* stage is represented by the pycnidium, which develops from the stroma of the fungus and the interior of the pycnidium is lined by inwardly projecting conidiophores, which abstrict pycnospores. The ascigeral stage is found on old leaves that have remained over winter in the open, and it may appear in late winter or early in the spring. The perithecia are not uniform in size, for we find them measuring in diameter from 150 to 250 μ with a beak 50 to 100 μ long. The broadly clavate asci are bent at right angles near the base. They have a thickened apex, a terminal pore with a surrounding refractive ring and bear invariably eight hyaline two-celled elliptic ascospores. The two ascospore cells are unequal in size, the larger of the two giving rise to a germ tube.

Application of the 5-5-50 Bordeaux mixture to young shade trees and to nursery stock assists in controlling the disease.

Tobacco (*Nicotiana tabacum*, L.)

Root-rot (*Thielavia basicola*, Zopf).—This fungus is found on a great variety of host plants and its growth on the roots of tobacco may be taken as illustrative. It is found in the eastern United States and in Europe from England to Italy. Roots attacked by this fungus do not develop normally and the roots may be so injured, that if the plant is pulled out of the soil everything will remain in the soil except

the broken stub of the main root system. Nature attempts to repair the damage in the tobacco by the formation of a cluster of new roots, so that affected plants may not be killed, but remain in the stunted form (Figs. 196 and 197).

The intercellular mycelium is septate, hyaline at first and consists of narrow hyphæ. The fungus produces three kinds of spores, which



FIG. 196.—Tobacco roots affected by rot (*Thielavia basicola*). 1, Inoculated at two months; 2, diseased root from field. (After Gilbert, W. W., Bull. 158, U. S. Bureau of Plant Industry, 1909.)

are according to Duggar (1) endosporous conidia, which are formed in chains in terminal branches, or clusters of branches. They are formed by basipetal septation, as short cylindric cells within the branch. The tip of the branch is broken off, and they are pushed out by osmotic force, so that the branch has served as a spore case. The hyaline

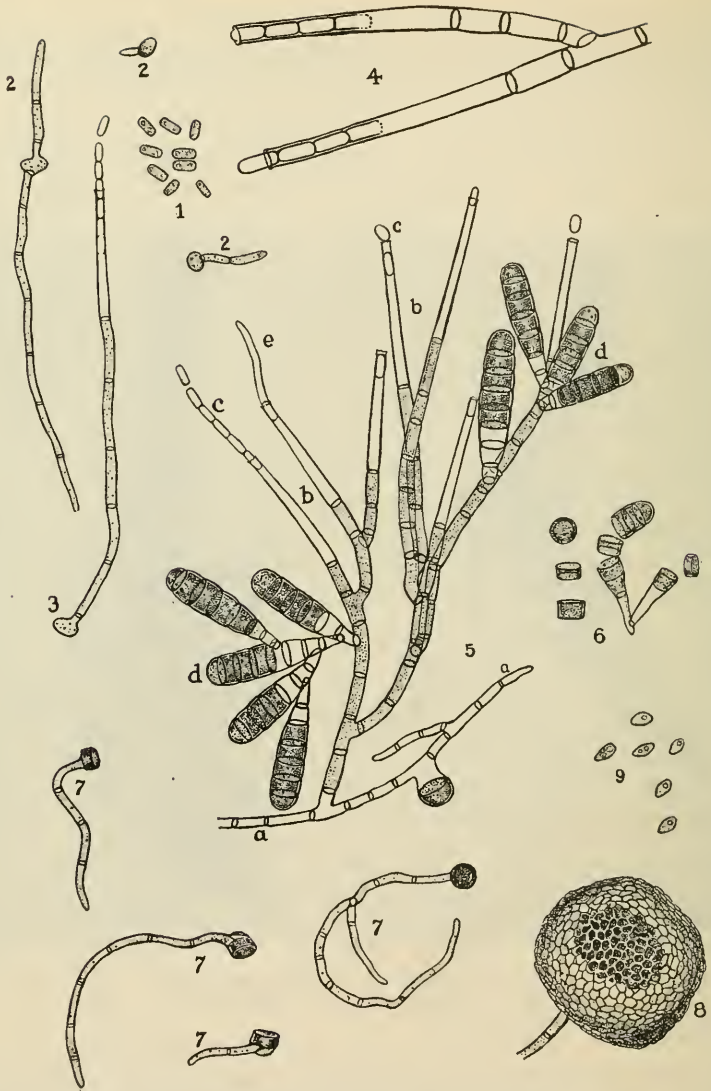

FIG. 197.—Root-rot fungus (*Thielavia basicola*) in various stages. (After Gilbert, W. W., Bull. 158, U. S. Bureau of Plant Industry, 1909.)

endospores measure 10 to 20 μ by 4 to 5 μ . (2) Another kind of spore is the thick-walled chlamydospore which is cylindrical in shape, borne in chains and measures about 12 μ in width. (3) The third kind of spore is the ascospore, which is borne in evanescent asci in simple perithecia. The ascospores are unicellular and measure about 12 μ by 5 μ .

To check or control the disease sterilization of the soil has been practised. All diseased roots about the place should be destroyed by fire.

Timber

Decay (*Stereum frustulosum* (Pers.), Fr.).—The fruit bodies of this fungus appear as slightly raised gray spots thickly placed on the surface of wood and timber (Fig. 85). The fruiting bodies are 2 to 5 mm. in diameter. The action of this fungus on structural wood is characteristic, as it forms pocket-like areas in the decaying wood, causing changes in the wood fibers. The holes are more or less lenticular and are isolated from each other by the sound wood. Layers of white cellulose fiber line the margin of the hole.

Other decay producing fungi are punk fungus, *Fomes igniarius* (Figs. 198, 199, 200) and hedgehog fungus, *Hydnum erinaceus* (Fig. 201).

Dry-rot (*Merulius lacrymans*, Schum.).—The dry-rot fungus (Der Hausschwamm) is one of the best-known and most destructive of wood-destroying fungi. For many years, it was claimed, that it was purely domestic found only in connection with the structural wood-work of houses and buildings, but Hartig drew attention to the fact, that it probably exists occasionally in a state of nature. Professor von Tubeuf sums up the evidence of Hartig¹ and a number of other observers in this statement: "Hausschwamm ist bisher ganz auffallend selten, direkt als botanische Rarität, im Walde gefunden worden. Die wenigen Funde, welche bis jetzt bekannt wurden, sind nicht etwa in urwaldähnlichen Forsten gemacht, sondern in der Nähe der menschlichen Kultur; in solchen Wäldern, die in der Nähe grosser Städte liegen, oder an Orten in der Nähe von Waldhäusern und von Wegen,

¹ MEZ, DR. CARL: Der Hausschwamm und die übrigen holzerstörenden Pilze der menschlichen Wohnungen, Dresden, 1908, page 260; MÖLLER, DR. A.: Hausschwamm forschungen im amtlichen Auftrage. Jena, Band i, 1907; Band ii, 1909; Band iii, 1909.

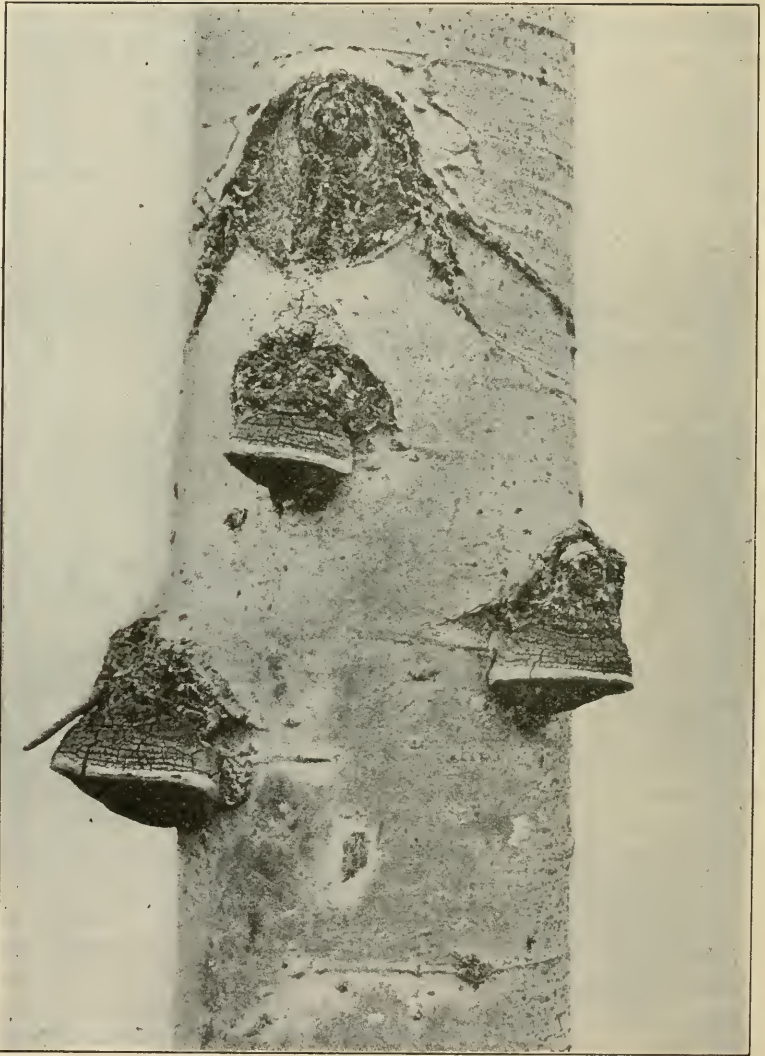

FIG. 198.—Aspen tree with several sporophores of *Fomes igniarius*. (After von Schrenk, Hermann, Bull. 149, U. S. Bureau of Plant Industry, 1909.)

zu deren Anlage bearbeitetes Holz verwendet wurde, kann die Möglichkeit der Verschleppung des Hausschwamms in den Wald., nicht bestritten werden." To this wild form, the name of *Merulius silvester* has been given. The domestic form of the fungus *Merulius lacrymans* is an obligate saprophyte. The spores fall upon the exposed end of a board, beam, joist, rafter, wooden column, or flooring, which may be in contact with, or resting on, a stone foundation, brick wall, or



FIG. 199.—Cross-section of the trunk of a living silver maple rotted by *Fomes igniarius*. (After von Schrenk, Hermann, Bull. 149, U. S. Bureau of Plant Industry, pl. ii, 1909.)

earth, which is slightly damper, if not in dry weather, then during rainy, than the more protected part of the same piece of structural wood. Here the spore germinates and produces a mycelium, which grows inside the wood from which it abstracts the proteins necessary for its growth (Figs. 88 and 89). At the same time, it dissolves the coniferin and cellulose of the cell-walls, and leaves behind a brown residue consisting of lignin, tannin and oxalate of lime (Fig. 88)

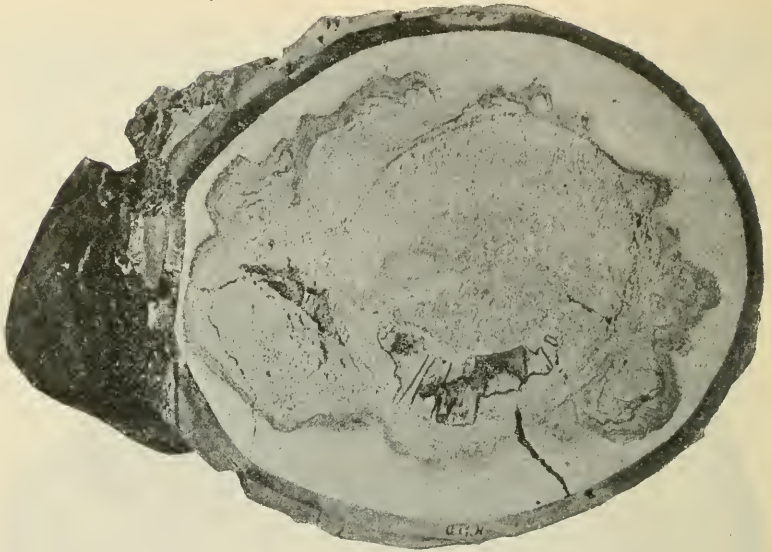

FIG. 200.—Cross-section of a living aspen tree rotted by *Fomes igniarius*. (After von Schrenk, Hermann, Bull. 149, U. S. Bureau of Plant Industry, pl. ii, 1909.)



FIG. 201.—Cross-section of a living white oak tree decayed by *Hydnum erinaceus*. (After von Schrenk, Hermann, Bull. 149, U. S. Bureau of Plant Industry, pl. vii, 1909.)

So long as sufficient moisture is present, these substances enable the wood to retain its original volume, but whenever water is withdrawn the wood becomes traversed by numerous fissures running at right angles to each other, and frequently, it breaks up into regular cubes which readily crumble away, if rubbed, or compressed, and a brown punky substance is the result of the destructive attack of the mycelium.

When the opportunity is presented for the mycelium to develop vigorously outside the nourishing substratum, it forms especially on the side of the joist or board, which is facing a moister air-still chamber, as under a porch floor, or the interior of some conduit (electric or otherwise), a skin-like layer which often attains large proportions. In other cases, it may fill cracks, or other cavities. If a microscopic examination is made of the hyphæ of the dry-rot fungus, they will be found of several kinds showing clamp-connections (Schnallenbildungen), the formation of oidia and the anastomosis of hyphæ that come in contact. The hyphal cells are multi-nucleate. Three kinds of structural hyphæ are discernible, viz., the ordinary thin-walled hyphæ, the water-conducting hyphæ of larger size and thicker walls, and the sclerenchyma-like hyphæ with very much thicker walls than the other two. The function of the water-conducting hyphæ will be explained, if we examine the sheet-like mycelia, which cover at times the surface of structural wood. Such a mycelium will be found covered with drops of extruded water like tear drops (hence *lacrymans* > Lat. *lacryma*, a tear). This water has been conveyed from the soil, or damp wall, in contact with the joist, a beam, a distance sometimes of ten or twelve feet to the drier parts of the wood. This accounts for the rapid spread of the mycelium and its ability to secure enough water for its insidious growth through well-seasoned timbers. Sometimes in houses only a thin coat of paint conceals the destructive work of the "house-fungus." Later the fruit bodies appear as an extended thin superficial crust of a brownish-smoke color covered with low anastomosing ridges and wrinkles, suggesting the surface of tripe, over which the hymenial, or basidial, layer is spread (Fig. 8g). The basidiospores are deep yellowish-brown in color and impart to the hymenium a yellowish-brown hue. Each basidium terminates in four short sterigma which bear the basidiospores, which measure 9μ to 12μ in length by 5.5μ to 6.5μ in breadth. Germination of the spores is readily obtained.

Kiln drying of structural wood is an excellent means of preventing

the growth of the dry-rot fungus. Coating materials should be avoided unless the woods are absolutely dry and the well-seasoned wood should be painted at once as neglect on this score may cause a lot of trouble. The walls on which timbers are laid should be perfectly dry.

Sap-rot (*Daedalea quercina* (L.) Pers).—One of the most important enemies of structural oak, produces a soft, mushy decay of the wood (Fig. 202, also page 76).

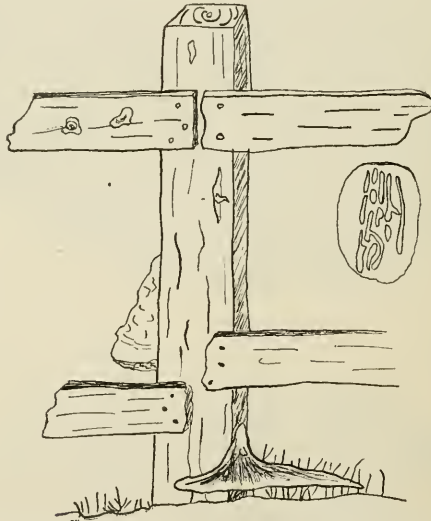

FIG. 202.—*Daedalea quercina* destroying a fence post, Nantucket, Aug. 23, 1915. Xerophytic hoof-shaped fruit-body above, mesophytic bracket below in contact with the grass.

Violet (*Viola* spp.)

Spot Disease (*Alternaria violæ* Gall. & Dorsett) (Fig. 203).—The wild violets in the yard of the author have been attacked by the spot disease every year for the past six years. In some years, the attack is more virulent than in other years. It is also common on violets grown under glass, and in some districts, commercial violet growing has been practically abandoned. The fungus attacks plants that are making a rapid and vigorous growth. The first spots are circular, greenish or yellowish white ones. They have a light colored central portion surrounded by a narrow ring of discolored tissue, usually

black or very dark brown at first, but changing to a lighter shade, as the spots grow older. The first diseased part of the leaf looks as if water-logged, and in a few days, the diseased part of the leaf peripheral to the central spot fades, or bleaches, to a yellow, or grayish-white. Here the disease may stop and the plants recover, the diseased areas separate from the healthy tissue and fall out leaving holes in the leaves. The disease may spread, however, until the whole leaf is destroyed.

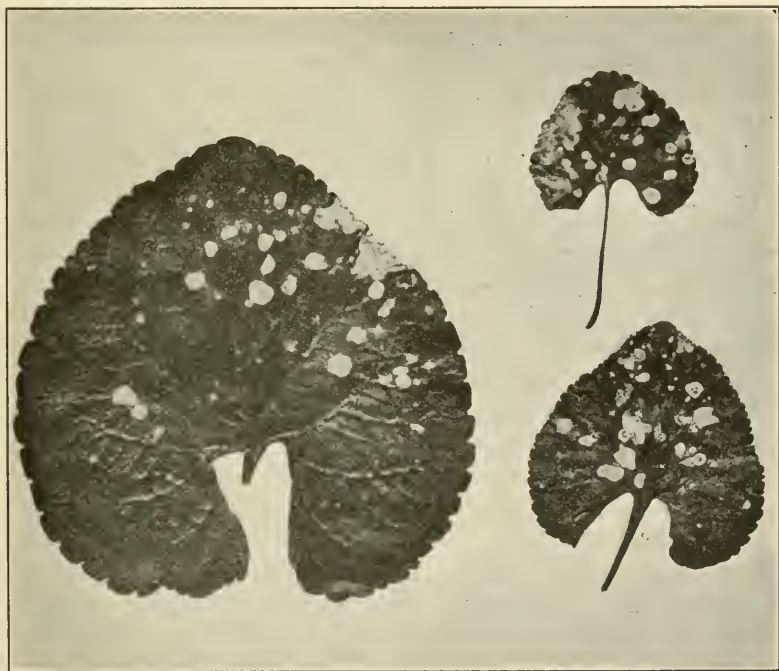

FIG. 203.—Violet leaves affected with leaf-spot (*Alternaria violæ*). (Photo. by Heald, F. D. and Wolf, F. A., *Bull.* 135 (*Sci. Ser.* 14), *Univ. of Tex.*, Nov. 15, 1909.)

The majority of the spots are free from fungous spores except under conditions favorable to their development. Some spots produce spores in abundance, especially upon the central, or older portions of the spots. The spores are borne in chains on dark brownish hyphæ that arise from the diseased surface. The conidiospores are clavately flask-shaped, muriform, strongly constricted at the septa, which are variable

in number, olivaceous, 10 to 17 μ by 40 to 60 μ , exclusive of the isthmus, which is 3 to 5 μ by 3 to 25 μ .¹

To prevent the disease, only healthy vigorous stock of known parentage should be grown. These plants should be propagated at the season most favorable to the growth of the violet. The frames, glass houses and conservatories should be kept scrupulously clean.

Wheat (*Triticum sativum* Lam.)

Black-rust (*Puccinia graminis*, Pers).—Before the rise of modern scientific investigation in botany, the farmers of Germany believed that there was some connection between the rusted condition of their wheat plants and the barberry bushes in proximity to their fields. It remained for de Bary in 1865 to give scientific demonstration of the life cycle of the rust fungus by experimental methods. He found on the branches and leaves of the wheat plant rust-red lines, which represent cracks in the epidermis through which the summer spores known as uredospores, or urediniospores, project. These together form the uredinial sorus, or uredinium. The spores, as they rise from the intercellular mycelium of the leaf, or stem, are ovate, yellowish-brown, spinulose and measure 10 to 15 μ by 20 to 35 μ . They may be repeated, as long as fresh blades and branches are provided for infection and spread to new parts, but these spores are specialized, as they cannot infect any other host plant like oat, rye, barley and so forth, but only wheat. Later the rust-red sori are replaced by brownish-black sori, which represent the telium composed of teliospores, or teleospores, which project. The teliospores are spindle-shaped, two celled, thick-walled and deep brown in color. They measure 35 to 60 μ by 12 to 22 μ . Germination consists in the formation of a four-celled promycelium, or basidium, each cell of a stalk gives rise to a single sporidium, or basidiospore. These if blown to the barberry enter the barberry leaf by the formation of a germ tube and the intercellular mycelium develops a flask-shaped *pycnium* (spermatogonium) with small, spore-like bodies abstracted off from vertical hyphæ known as spermatia and æcia, or cluster cups on the under leaf surface, which give rise to æciospores. These carried to the wheat infect the wheat and the cycle is completed. The æciospores germinate irregularly and capriciously, the process being accelerated to some

¹ DORSETT, P. H.: Spot Disease of the Violet, Bull. 23, U. S. Division of Vegetable Physiology and Pathology, 1900.

extent by chilly nights with alternating warm days. Cluster cups that originate from spores produced on the wheat plant, develop aeciospores, which will infect only wheat plants. If it should happen that these aeciospores are blown to rye, oats, barley and rye, no infection takes place, so that the same specialization of spores form is noticeable here as with the uredospores.

In America, the barberry shrubs are extremely rare and to account for the completion of the life cycle on this side of the Atlantic Ocean,

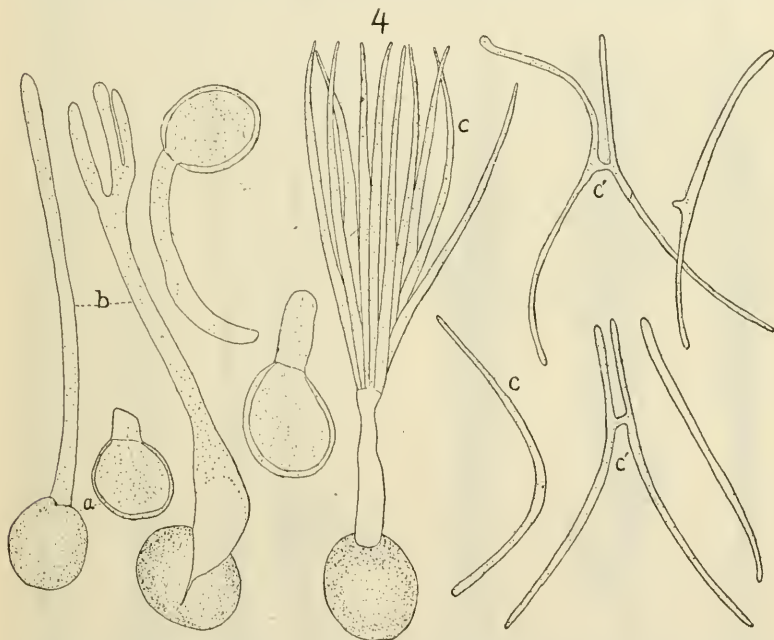

FIG. 204.—Germination of the chlamydospores of *Tilletia fatens* several days after being placed on moist plaster of Paris slabs. *c'*, showing conjugating basidiospores. (After Bull. 57, Univ. Ill. Agric. Exper. Stat., March, 1909.)

recourse has been had to amphispores, which are thick-walled stalked urediniospores produced in the western states under more or less arid conditions, but Arthur thinks that the perennation of urediniospores alone is sufficient to explain the recurrence of the disease on the wheat plant in succeeding years.

It should be emphasized also that within the species of black rust, there exist several specialized forms, more or less adopted to their own

host plants or plants. According to Eriksson, six forms can be distinguished in Sweden, namely, *tritici* (on wheat seldom on rye, barley and oat), *secalis* (on rye, barley and couch grass), *avenæ* on oat, orchard grass, etc.), *poæ* (on the blue grasses), *airæ* or species of *Aira* and *Agrostis* on *Agrostis canina* and *A. stolonifera*.

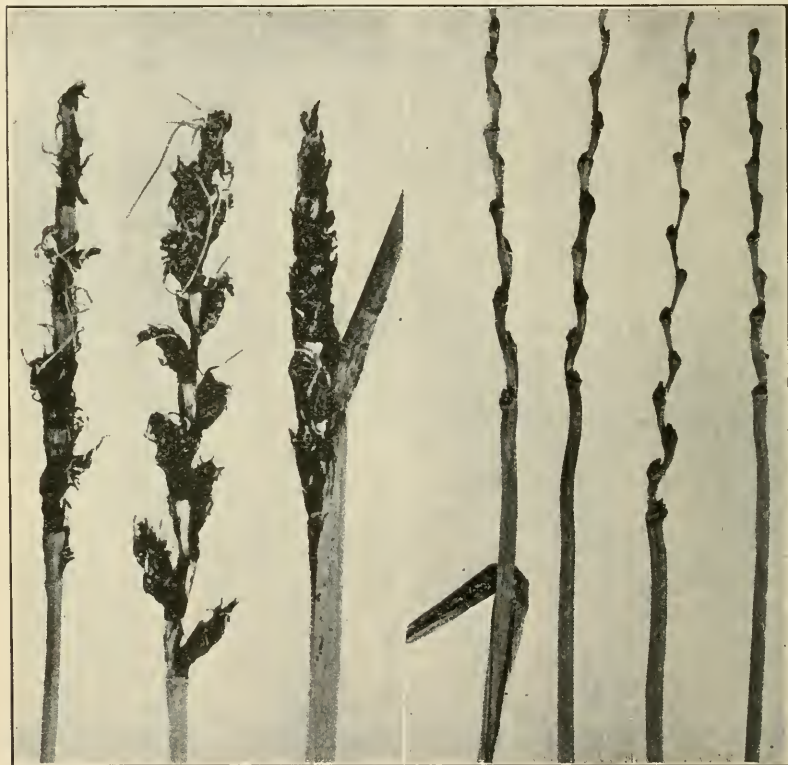

FIG. 205.—Heads of wheat showing smut (*Ustilago tritici*), and to the right, appearance of smutted stalks at harvest time. (After Jackson, F. S., Bull. 83, Del. Coll. Agric. Exper. Stat., December, 1900.)

Stinking-smut (*Tilletia foetens* (B. & C.) Schrt.).—This is the commonest smut on wheat in the United States. It occurs in the wheat-growing regions of Canada¹ and the Northwest, where it

¹Güssow, H. F.: Smut Diseases of Cultivated Plants. Bul. 73, Division of Botany, Central Experimental Farm, Ottawa, Canada, March, 1913.

does considerable damage (Fig. 204). The fungus is confined to the wheat plant, although nearly all the varieties of that cereal are susceptible to it and under all climatic conditions. The production of spores in the host is confined largely to the ovules, and as these begin to grow, they become smutted. Such smutted grains cause a flaring of the spikelets and diseased parts may be recognized by a slight difference in color. With the formation of the spores, a penetrating and disagreeable odor arises, the presence of which gives the common name to the disease. The smut spores, or chlamydospores, are brown in color, nearly spheroid in form and vary from 16 to 25 μ in diameter. From these chlamydospores on germination acicular or needle-shaped basidiospores (sporidia) arise, which are produced in the form of a crown on a short basidium (promycelium). The spores may unite in pairs and secondary basidiospores be formed.

This disease can be controlled by the use of formalin. The grain of wheat should be sprayed with the solution (1 pint to 30 gallons of water).

Another wheat smut fungus is *Ustilago tritici* (Fig. 205).

CHAPTER XXXVI

NON-PARASITIC, OR PHYSIOLOGIC PLANT DISEASES

The non-parasitic diseases of plants traceable to the unfavorable conditions of the slope, physical and chemical character of the soil including the deficiency or excess of water content, as well as the unfavorable climatic influences, have been discussed at length by Sorauer in his "Handbuch der Pflanzenkrankheiten" (3d Edition, assisted by Lindau and Reh, 1908) and the English translation of the 3d edition of this book by Frances Dorrance under title of "Manual of Plant Diseases," issued in parts. Four parts have already appeared on Non-parasitic Diseases. At length also are considered the poisonous influence of gases and other chemicals together with wound and gall diseases. Gummosis and several other physiologic diseases have been described by him. A general treatment of these diseases has been made in Part II of this book and, therefore, such general considerations need not be rehearsed here. A few specific cases will be given by way of introducing the student to another phase of phytopathologic work.¹

It should be stated at the beginning that no sharp line can be drawn between parasitic and non-parasitic diseases. If they were controlled by a single set of factors this might be done, but complications always are involved.

The classification, however, is a convenient one and we can, therefore, use the terms physiologic and non-parasitic merely as conventional designations for a certain class of diseases. A convenient bibliography of non-parasitic diseases of plants by Cyrus W. Lantz forms part of Circular No. 183 Agricultural Experiment Station, University of Illinois, Urbana, May, 1915. The following are some of the names applied to such diseases in the original papers listed in the above-mentioned circular by Lantz: Anaheim, Bitter-pit, Brunissure, Brusone, Chloro-

¹ SMITH, R. E.: The Investigation of Physiological Plant Diseases. Phytopathology, V, 83-93, Apr., 1915.

sis, Collar-blight, Coulure, Court-nóue, Curly-top, Die-back, Exanthema, Foot-rot, Fruit-spot, Gummosis, Intumescence, Leaf-curl, Leaf-scorch, Mal di gomma, Melanose, Mosaic, Œdema, Pithiness, Pourriture, Roncet, Rosette, Scald, Stippen, Sunburn, Tipburn, Tomosis, Tumor, Water-core, Yellows, Zopal.

The following diseases, selected because of their interest and importance to plant growers, may be looked upon as belonging to this class.

Stag-head, or Top-dry. The disease so designated frequently results from lack of proper food in the soil. The gradual death of the top of the tree is an indication of the malady, as well as the loss of active growth in the lower part of the tree. It is found in forested areas where by burning, or by denudation, the conditions have been changed. Stag-head is frequently seen in park trees where the natural undergrowth has been removed and where the covering of turf prevents the access of rain to the roots of the trees, or where the stock of humus has become depleted in the soil. The soil tends to dry out in summer and in some of the parks in Philadelphia its surface for several inches becomes baked hard. This is assisted by the constant tramping of many feet beneath the trees. The soil becomes impoverished, especially in nitrogen and starvation of the tree becomes evident with the slow death of its terminal branches. As a preventive measure a constant supply of food should be provided. Wherever practicable the ground beneath the tree should not be sodded completely, but should be planted to low-growing shade-enduring plants, and if possible, the soil should be top-worked and dressed each year with manure, or other plant food. Along streets and walks this is rendered difficult by the proximity of paving material, but as in Paris each tree should have around its base an unpaved area through which the water can seep into the soil and by which plant food can be added. An open grating can be placed so as to protect the surface soil about the tree from the tramping of passersby.

Root Asphyxiation (Suffocation).—The health of trees and other plants depends on the proper aeration of the soil. This is conditioned on the size and proximity of the soil particles or the amount of water present, and on the proximity of pavements, fills or grading materials, etc. The lack of air is of far-reaching importance. The organisms of nitrification cannot carry on the process of nitrogen fixation in soils poor in oxygen, and this is true of wet soils or those which are poorly

drained. Flooding of tree roots is frequently the cause of the death of the tree. This is seen in low places underlaid by a hard pan, where the groundwater comes close to the surface, or in stiff soils, which become saturated and hold their water for a long time. Bad aeration of the soil coupled with the presence of noxious gases is frequently the cause of disease and death in street planted trees. As preventive measures the ground should be kept stirred about the bases of the trees, or where the ground has been filled in around the tree, small patches of bark should be removed to induce the formation of adventitious roots from the wounded areas beneath the new soil surface.

Desiccation.—This phenomenon is noticeable in plants exposed to bright sunlight following a spell of cold or cloudy moist weather. The young leaves and tender shoots of such plants frequently wither and die under such conditions. This is sometimes called sun-scald, but evidently it is due to a too rapid loss of water, so that the tender parts wither. The excessive loss of water is due to the fact that the leaves produced in very moist air are not adapted to resist excessive transpiration even where there is an abundant supply of water in the soil. In other words, the leaves and tender shoots have not been sun hardened. The writer has noticed such a state in the spring when a dry hot spell of weather succeeds a moist cool spell. This disease is produced in the West and Southwest by hot dry winds which sweep over the country, or in South Florida by what are called dry hurricanes. The "Sirocco" on the African coast of the Mediterranean Sea, in Malta and Italy is a hot dry desiccating wind, and so is the "Khamzin," a hot wind from the desert, which blows across Egypt. The leaves of plants are literally cooked, or parched, with such dry winds. The cold dry winds of winter may produce the same effects as the warm dry ones.¹

Remedial measures under such climatic conditions would be difficult to operate. Frequently in dry regions the formation of a dust mulch by cultivating the soil surface is a method of conserving soil moisture, as is also the application of litter of various kinds. Top pruning in dry seasons will often check the excessive demand for water and thus prevent injuries to the rest of the tree. Copious watering of the soil under such dry conditions may save the destruction of the orchard trees or cultivated plants. Winter blighting, or dry-out of coniferous

¹ HARTLEY, CARL and MERRILL, T. C.: Storm and Drouth Injury to Foliage of Ornamental Trees. *Phytopathology*, V, 20-29, Feb., 1915.

trees may be prevented by proper shelter, or by liberal mulching. Sometimes a light straw shelter, or wind-break, may be efficacious.

Water-logging.—Transpiration from the leaves of plants is much reduced during periods of long-continued rains or fogs and as a result the plant becomes gorged with water. Growth is stimulated, but the cells are thin walled and easily dry up, or are the easy prey of fungi and insects. Such excess of water may result in the formation of little warts and swellings. These may be formed on leaves or stems. Sometimes the leaves become diseased by being water-logged in spots which are translucent in appearance. Galloway and Woods¹ describe the influence of the excess of water during the season of 1896 in Washington, D. C. "In early spring vegetation was at first a little retarded by cool weather, but this was suddenly followed by good growing weather, during which the leaves of most trees and shrubs especially those of Norway maples pushed out with great rapidity. This latter period was followed by one quite dry and warm, during which red spiders increased to unusual numbers, particularly on the lower and more protected leaves of the crown. After this came a period of several days of rainy weather, and many of the spiders were washed off, but the leaves where they had been working became water-logged. The Norway maples and horse-chestnuts suffered most, the leaves of these trees in many cases appearing to have been scorched with fire."

Such injuries as water-logging resulting from an excess of moisture in the air cannot be prevented readily. Proper planting may render trees less liable to such trouble especially if care is exercised in feeding them after they are planted. Susceptible trees such as horse-chestnut and Norway maple require special care and if the conditions under which these trees can be grown open the way to serious water-logging they should be discarded and other trees planted in their stead.

Edema of Manihot.—The blister-like pustular outgrowths on plants variously designated as œdemata or intumescences have been the subject of careful investigation by a number of plant pathologists. The disease is also known as dropsy² and has been observed both in greenhouses and out-of-doors (Fig. 206). The diseased condition known as œdema or dropsy occurs on stems, leaves and fruits. It has been found recently

¹ GALLOWAY, B. T. and WOODS, ALBERT F.: Diseases of Shade and Ornamental Trees. Yearbook, U. S. Dept. Agric., 1896: 245.

² SÖRAUER, PAUL, LINDAU, G. AND REH, L.: Manual of Plant Diseases, trans. by Frances Dorrance, 1: 335.

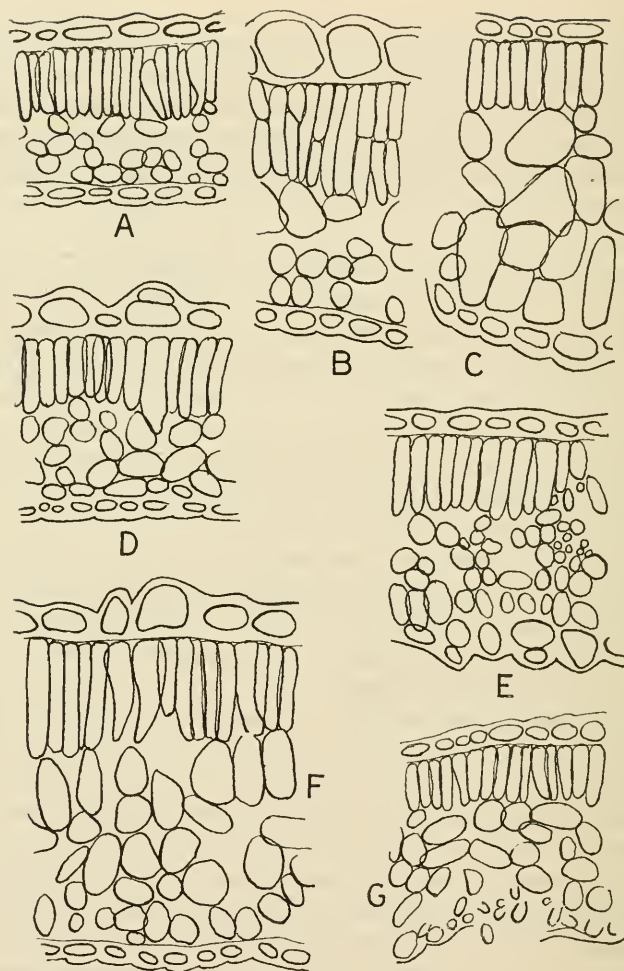

FIG. 206.—Edema on *Manihot* (Ceará). A, Normal arrangement of leaf tissues; B, division and enlargement of palisade cells in œdematous leaf; C, division of cells in the spongy parenchyma which become giant cells; D, early stages of disease in which all of the cells except lower epidermal ones are œdematous; E, division and enlargement of cells in lower epidermis; F, œdematous leaf tissue double that of normal leaf; G, shrinking and collapse of cells in œdematous leaf. (After Wolf and Lloyd, *Phytopathology*, 2: 134, pl. xi.)

by Wolf and Lloyd affecting the leaves of rubber-producing plants belonging to the genus *Manihot* of which *M. glaziovii*, *M. heptaphylla* and *M. pianhyensis* are known as ceará. The leaves of the ceará plants growing in the greenhouses of the Agricultural Experiment Station, Auburn, Alabama, were found with numerous, glistening, prominently projecting elevations on either surface of the leaf. When the elevations or swellings occur on the upper surface there are corresponding depressions or concavities on the lower reaching as much as three millimeters in diameter and protruding a millimeter above the surface. The blisters are circular in outline and mostly isolated, but if they exceed 300 to 500 they become more or less confluent. At first there is no change in the color of the leaves, but as the disease progresses the œdematous tissue turns brown and finally dries and collapses. The anatomic details of healthy as contrasted with the diseased œdematous cells are shown in the accompanying details of Figure 206.

A number of explanations have been given for the origin of œdema, or dropsy in plants. Giant cells have been found in dropsical tissues similar to those found in insect galls. Woods found that thin walled œdematous cells were found in carnations as a result of the puncture by aphids, and in such the possible acid conditions must be considered. Sorauer and also von Schrenk have shown that intumescences may be caused by spraying leaves with copper salts. Several other plant pathologists hold to the general view that the disease is due to impaired transpiration. Sorauer was the first to attribute the cause to abnormal elevation of temperature, together with excessive water supply. He finds that weak light or semi-darkness favors the accumulation of water in the tissues, in that reduced illumination lowers assimilatory activity, and swollen tissue results. Viala and Pacollet believe that brilliant light is a prepotent cause, while Fisher argues that œdema is due to the increased affinity of the colloids of the tissues for water. This may be due to the accumulation of acids and Wolf and Lloyd¹ believe that the œdematous tissue of ceará seems to afford some evidence for the truth of this contention.

Frost Necrosis of Potato Tubers.— Jones and Bailey² have called atten-

¹ WOLF, FREDERICK, A. AND LLOYD, FRANCIS E.: Œdema on *Manihot*, *Phytopathology* 2: 131-134, pl. 1, 1912.

² JONES, L. R. AND BAILEY, ERNEST: Frost Necrosis of Potato Tubers, *Phytopathology* 7: 71-72, Feb., 1917.

tion to a type of non-inheritable "net necrosis" of potato tubers which has developed under conditions which suggest frost injury and this hypothesis has been confirmed by chilling experiments. Tubers "frozen solid" are totally killed and collapse when thawed, and if the chilling stops with incipient ice crystallization, such interior tissues as are most sensitive may be killed. Such frozen tubers are normal in external appearance but when cut open they show that the most sensitive internal vascular tissues are discolored and are killed. Therefore, moderate exposure to freezing temperature may produce either "ring" or "net" necrosis, the blackened vascular tracts penetrating the fundamental tissue cells filled with starch. Tubers vary individually in their sensitiveness but in general the best types of "net necrosis" have been secured by about two hours exposure to $+5^{\circ}\text{C}$. with similar results on exposing them to -1°C . for eight and one-half hours to -9°C . for one hour. Slightly more severe treatments, or unequal exposures, may give frozen spots with corresponding dark blotches involving the general parenchyma. The stem end of the tuber is always more sensitive than the other end.

Apple Fruit Spots.—This disease of the fruit of the apple is also known as Baldwin-spot, bitter-pit, fruit-pit, pointe bruns de la chair and stippen. It is cosmopolitan in its distribution, being found wherever apples are grown. It has recently received the attention of a number of mycologists and a number of explanations as to its cause have been given. The most recent study seems to indicate its non-parasitic character. The observed spots are dark in color, circular or somewhat angular in outline, from one-eighth inch or less to one-fourth inch in diameter. Although distributed over the surface of the pome they appear most commonly on the blush, or sun-exposed side. A lenticel forms the center of the slightly depressed areas or "pocks," which consist of necrotic tissue. The injury is superficial extending only slightly into the pulp. Pathologists appear to have agreed that the disease is due to extreme variations in the water-supply of the apple tree during the growing season.

McAlpine,¹ an Australian mycologist, has published four quarto

¹ EASTHAM, J. W.: Bitter Pit Investigation, *Phytopath.* 4: 121-123, 1914;
BROOKS, CHARLES: Bitter Pit Investigations, *Phytopath.* 6: 295-298, 1916;
CRABILL, C. H. and THOMAS, H. E.: Stippen and Spray Injury, *Phytopath.* 6: 51-54, 1916.

volumes with plates and illustrations in which he presents the evidence in favor of the hypothesis that the stippen is due to irregularities in the factor influencing the balance between transpiration and water supply and not to poisoning of cells, *e.g.*, by arsenical sprays as supported by abundant experimental proofs. He believes that the principal contributing factors are:

1. Intermittent weather conditions when the fruit is at a critical period of growth.
2. Amount and rapidity of transpiration.
3. Sudden checking of the transpiration at night when the roots are still active owing to the heat of the soil.
4. Failures of supplies at the periphery of the fruit followed by spasmodic and irregular recovery.
5. Irregularity of growth, so that the vascular network controlling the distribution of nutritive material is not formed regularly.
6. Fluctuations in temperature when fruit is in store.
7. Nature of the variety.

*Water-core of Apple.*¹—The diseased fruits are characterized by hard watery areas in the flesh, usually in the core and extending outward. Occasionally the flesh is marked by scattered small spots with extensive watery areas near the surface. The abnormal areas are usually associated with the vascular tissues. The seed cavities contain liquid and the hard partition membranes become cracked and covered with the hair-like out-growth known as tufted carpels. Norton states that the intercellular spaces so conspicuous in the normal apple flesh are filled with fluid in the diseased tissue so that the white opaque appearance of the normal flesh is lacking. "The occurrence of the disease under conditions favoring excessive sap pressure or cell turgor, on vigorous growing trees, or trees with the foliage reduced by blight, and especially in late summer when the air is cold at night and the soil warm, the cracks in the carpels, the occurrence along the vascular tissue, the liquid filling the intercellular spaces, lead me to the conclusion that the trouble is due to sap forced into the seed cavities and intercellular spaces by excessive sap pressure under conditions of reduced transpiration. The air being excluded from the inner cells by the liquid filling the intercellular spaces, anaerobic respiration may be increased and

¹ NORTON, J. B. S.: Water Core of Apple. *Phytopathology* 1: 126-128, Aug., 1911.

account for the alcoholic flavor, if not lead to the decrease in acid and the sweeter taste.

*Die-back or Exanthema of Citrus Fruits.*¹—Exanthema is a disease of the orange groves of the United States occurring in California and Florida. It affects all varieties of the genus *Citrus*, both young and old trees being susceptible. The malady is worse in trees which grow in poorly drained soils underlaid by an impermeable ferruginous sandstone but it occurs in hammocks as well. Exanthema attacks the small branches and shoots, though the fruit shows symptoms of diagnostic value. The disease is diagnosed more surely when the shoots become more or less stained sub-epidermally by a yellowish-brown material and begin to die back. The fruit may become similarly stained and its epidermis so dry that it cracks and splits by the pressure of the developing pulp cells. The disease may be held in abeyance for a number of years, but if it progresses, the shoots swell at the nodes, infrequently along the internodes and as they mature, linear, erumpent pustules break out on the internodes. On the older branches the pustules may be extremely numerous and a small amount of gum may be observed in them. Proliferation of young buds takes place and these may develop into short branches with chlorotic foliage producing a pseudo witches' broom.

Exanthema is induced, like gummosis, by the concurrence of active growth and active tissues. "The soils in which exanthema occur are typically dry soils, which when saturated by irrigation water or rains, promptly become dry once more when the weather clears or irrigation is discontinued. The rings of growth, which, as we have seen, are very marked in diseased shoots and branches of trees affected by exanthema, could not be caused except by a more or less rapid succession of maxima and minima of growth." Obviously as climatic conditions cannot be said to be causative, we must look to changes in the water relations of the plants which causes a marked development of the rings of growth. Webber and Swingle have observed that cultivation increases the susceptibility of the *Citrus* trees to exanthema, and even causes a more virulent outbreak of the disease in the affected trees. Any method of cultivation which tends to promote regular instead of fluctu-

¹ BUTLER, ORMAND: A Study on Gummosis of Prunus and Citrus with Observations on Squamosis and Exanthema of Citrus. *Annals of Botany* 25: 107-153, 1911.

ating growth may be regarded as a preventive or remedial measure. Drainage may prove to be remedial to exanthema which is only of one kind while there may be several kinds of die-back.

Mottle-leaf.—Mottle-leaf of Citrus trees is marked by the loss of chlorophyll from parts of the leaf, the portions farthest removed from the midrib and larger veins being first affected. As the disturbance progresses, the yellowish spots increase in size until the remaining chlorophyll is found in narrow areas along the midrib and larger veins. The advanced stages are distinguished by a marked decrease in the size, quality and yield of fruit. No organism has yet been proved to be associated with mottle-leaf which is common in the groves of southern California. Orchards fertilized with organic materials, such as stable manure, usually showed less mottling than groves the soils of which were treated with commercial fertilizers. The results of soil analyses show in the case of oranges a marked inverse correlation between the humous content of the soil and the percentage of mottling, the latter tending to diminish as the humous content increases and experiments show that this humus should be well decomposed. It would seem, therefore, that the mottling of orange leaves in the areas studied is definitely correlated with the low humous content of the soil, the mottling diminishing as the humus increases.¹

*Curly-top of Sugar Beets.*²—The curly-top of sugar beets seems to have attracted the attention of growers in California about 1898. It is distinguished by the following symptoms. An inward curling of the leaves, a distortion of the veins of the affected leaves, having roots and checked growth. It has caused great financial loss in the beet districts of the western United States. Experimental study of the disease shows that the leaves of the curly-top plants have an oxidase content two or three times as great as the healthy and normally developed ones. It appears that an abnormal retardation of growth in sugar beet plants is accompanied by an increase in the concentration of oxidases in the leaves or a change in the juice of the latter by which the pyrogallol oxidizing oxidase becomes more active.

Peach Yellows.—This disease which according to the early records

¹ BRIGGS, LYMAN J., JENSEN, C. A. and McLANE, J. W.: Mottle-leaf of Citrus Trees in Relation to Soil Conditions. Journ. Agric. Res. 6: 721-739, pls. 3, 1916.

² BUNZEL, HERBERT H.: A Biochemical Study of the Curly-top of Sugar Beets, Bull. 277, U. S. Bureau of Plant Industry, 1913.

seems to have spread from the region around Philadelphia as a center has been known about one hundred years. It is a contagious disease of unknown origin. Erwin F. Smith¹ in 1894 gave the first complete scientific account of yellows founded upon experimental data. He describes the symptoms as follows: "Prematurely ripe, red-spotted fruits, and premature unfolding of the leaf buds into slender, pale shoots, or into branched, broom-like growths. The time of ripening of premature fruit varies within wide limits; sometimes it precedes the normal ripening by only a few days, and at other times by several weeks. The red spots occur in the flesh as well as on the skin, making the peach more highly colored than is natural. The taste of of the fruit is generally inferior and often insipid, mawkish, or bitter. Often this premature ripening is the first symptom of yellows. Often during the first year of the disease this kind of fruit is restricted to certain limbs, or even to single twigs, which, however, do not differ in appearance from other limbs of the tree. The following year, a larger part of the tree becomes affected and finally the whole of it, the parts first attacked now showing additional symptoms, if they have not already done so. These symptoms are the development of the winter buds out of their proper season. The buds may rush into shoots only a few days in advance of the proper time in the spring, or may begin to grow in early summer, soon after they are formed, and while the leaves on the parent stem are still bright green. This is a very common and characteristic symptom, and is especially noticeable in autumn when the normal foliage has fallen. Usually under the influence of this disease feeble shoots also appear in considerable numbers on the trunk and main limbs. These arise from old resting buds, which are buried deep in the bark and wood and remain dormant in healthy trees. Such shoots are sometimes unbranched, and nearly colorless, but the majority are green and repeatedly branched, making a sort of broomlike, erect, pale green, slender growth, filling the interior of the tree."

Yellows can be well controlled by destroying the diseased trees as soon as they show premature fruit, or shoots with the narrow yellow leaves. The best treatment is to pull out or grub out and burn the diseased trees, and remove the stumps at a more convenient time. This, however, does not remove all source of infection as the disease may possibly spread from the stumps or yellowed shoots arising from them.

¹ SMITH, E. F.: U. S. Farmers' Bulletin No. 17, 1894.

The next year young trees may be set in the vacant places, care being taken to obtain trees for resetting that are free from yellows.

Tip-burn of Potato.—This disease is also called leaf burn or scald. It occurs in many parts of the country and is often confused with early blight. The tips and edges of the leaves turn brown and these discolored areas soon become hard and brittle. The burning or scalding may occur at any time and as a rule is the result of unfavorable conditions surrounding the plant. Long continued cloudy and damp weather followed by several hot bright days are very apt to result in the burning of the foliage. This is especially the case on soils carrying a comparatively small percentage of moisture. When the weather is cloudy and damp the tissues of the potato become gorged with water and this has a tendency to weaken them. If the sun appears bright and hot when the leaves are in this condition there is a rapid evaporation of the moisture stored up in their cells. The evaporation may be more rapid than the supply absorbed by the roots, and if this continues for any length of time the weaker and more tender parts first collapse, then die, and finally turn brown and dry up. Tip burn may also occur as the result of protracted dry weather.¹

Little of a specific nature can be said as to the treatment of this trouble. The plants should be kept as vigorous as possible by good cultivation, with plenty of available food.

Leaf-casting.—The fall of leaves at the end of the growing season, at the approach of winter, or periodically in the tropics is a normal result of the formation of an abscission layer. The premature dropping of leaves, the leaf-fall in house plants, the dropping of flowers and twig abscission are all manifestation of abnormal, even diseased conditions.

The premature dropping of leaves owing to the sudden weakening of functional activities concerns the plant pathologist and is known as "leaf-casting." The dropping of pine needles is only one phase of the general phenomenon. I may be allowed to quote here from the English translation of the third edition of Sorauer's "Manual of Plant Diseases" (1:349) by Frances Dorrance, concerning the leaf-fall in house plants. "Among the most delicate of the house plants belong the *Azaleas*, because, as a rule, they suddenly drop their leaves in summer, or in the autumn; the broom-like little tree then at best develops only a few piti-

¹ GALLOWAY, B. T.: Potato Diseases and their Treatment. U. S. Farmers' Bulletin 91, 1899.

ful flowers. Here too are concerned sharp contrasts occurring suddenly. Either the plants (usually set in peat soil) in summer are left too dry, and later watered very abundantly, or they are brought too suddenly into the warm house in the autumn. In both cases the leaves are weak functionally and then their functioning is increasingly stimulated by the increased upward pressure of the water. If the transition is brought about gradually, the inactive leaf surfaces would have time to resume their normal action by a general slow increase in their turgidity and there would be no resultant injury. But, with the sudden upward pressure of the water, the basal region alone is stimulated, thus causing the development of the cleavage layer." Here are briefly a few of the observations of the writer on two plants of *Fuchsia* brought into the house from out of doors and placed in a window with a bright southern exposure. Soon after removal to the house although abundantly watered the leaves began to drop until the window sill was covered with the litter. New leaves were constantly formed, but these in turn dropped off and this phenomenon continued through the winter until the plants were transplanted the following summer to garden soil, when the dropping of the leaves ceased and the plants again became apparently normal. The general consensus of opinion among plant pathologists is that the disturbance in the equilibrium of the turgor distribution is the cause of all premature dropping of the leaves. "For house plants it may be recommended as a fundamental principle that the plants should be subjected gradually to other vegetative conditions, and the *dormant period*, upon which every vegetative part enters, should not be interrupted by an increase in the supply of heat and moisture."

Curly-dwarf of Potato.—This is a peculiar disorder characterized by a dwarfed development of the potato plant accompanied by a curling and wrinkling of the foliage, so that it resembles the foliage of the varieties of cabbage known as Scotch Kale and Savoy Cabbage. The Germans call it Kräusel Krankheit. The disease is manifest in the shortening of the leaf petioles, midribs and veins of the leaves and especially in the nodes, so that the foliage is clustered thickly. The diminished growth of the veins in proportion to the cells of the fundamental tissue results in a wrinkled leaf surface, often curled downward. There seems also a tendency for the formation of a greater number of secondary branches, associated with brittle stems. The color of the foliage is not altered as it remains a normal green except in very severe

cases, when it becomes a lighter green sometimes with brown or reddish flecks, where the tissues are dying. This malady is distinguished from leaf-roll by the bullate, downward curling of the leaves, the persistence of the normal leaf green and the general firmness of the leaves. It results in the reduction in the yield of tubers, and in several cases no tubers have been found.

The nature and cause of this disease remain inexplicable. That it is an hereditary trouble has been attested by German plant pathologists. The tubers from diseased hills all develop into curly-dwarfs, while those from healthy hills remain normal. The disease which is found in Europe and in this country plays a large rôle in the deterioration of potatoes. It seems from our knowledge of the disease that it is a physiologic disorder resulting in a permanent deterioration of the potato stock. It may develop at any time under the influence of conditions not yet fully understood, and the vigor of the strain is reduced apparently without any chance of its restoration. Perhaps it is concerned with the senescence of the particular race of potatoes attacked or in other words a varietal decline.

The disease can be controlled to some extent by selecting tubers from healthy hills, and if it is prevalent in a field of potatoes, it would be better not to use any of the tubers from such a field for seeding purposes.¹

*Bean Mosaic.*²—Hundreds of acres of pea beans *Phaseolus vulgaris* in New York showed the mosaic disease in 1916 and in some fields practically every plant was affected and these plants rarely form pods. The malady is not confined exclusively to the pea beans, but affects varieties of dry and snap beans and perhaps is the same disease described by McClintock as attacking pole and bush lima beans. The leaves of the plants attacked by mosaic show irregular crinkled areas, somewhat deeper green than the surrounding yellowish-green tissue. The disease is transmitted through the seed for diseased seedlings develop from bean seeds taken from mosaic parents. The disorder has been induced experimentally by rubbing healthy seedlings with crushed leaves from diseased plants, the reaction taking place four weeks later. The first signs of the disease are seen about the time of blossoming.

¹ ORTON, W. A.: Potato Wilt, Leaf Roll and Related Diseases, Bull. U. S. Dept. Agric. 64, 1914.

² STEWART, U. B. and REDDICK, DONALD: Bean Mosaic, *Phytopathology* 7: 61.

Experimental treatment indicates that high temperature and humidity at the time of inoculation favor infection.

*Mosaic Disease of Tobacco.*¹—This disease is one of the most serious which attacks the tobacco plant. It is known locally as “calico,” “gray-top,” “mottled-top,” “mottling” and “foxy” tobacco. The term “frenching” is used in southern tobacco sections to designate abnormal, sickly plants with stringy, very thick and leathery leaves which may be mottled, or not. It is not known whether this disease is distinct from mosaic. Chlorosis has also been used for mosaic, as well as the terms “brindle” or “mongrel.” Allard states that the mosaic disease of tobacco is attended with various physiologic and morphologic changes in the leaves, branches and sometimes flowers of all affected plants. The character and the intensity of these symptoms vary greatly, depending upon the age, habits of growth, species of plants affected and external conditions. Allard classifies the characteristic symptoms of mosaic, as follows:

1. Partial or complete chlorosis.
2. Curling of the leaves.
3. Dwarfing and distortion of the leaves.
4. Blistered or “savoyed” appearance of the leaves.
5. Mottling of the leaves with different shades of green.
6. Dwarfing of the entire plant.
7. Dwarfing and distortion of the blossoms.
8. Blotched or bleached corollas (in *Nicotiana tabacum* only).
9. Mosaic sucker growths.
10. Death of tissues (sometimes very marked in *Nicotiana rustica*).

The first visible symptom of mosaic in very young plants appears as a slight downward curling and distortion of the smallest innermost leaves, which at the same time become more or less chlorotic. Small abnormally dark-green spots and areas appear as these leaves increase in size and if the plants are not crowded these spots develop rapidly into large, irregular, crumpled swellings or blisters of a “savoyed” appearance. The leaves of these young plants may grow to a disproportionate size,

¹ WOODS, ALBERT F.: Observations on the Mosaic Disease of Tobacco, Bull. 18, U. S. Bureau of Plant Industry, 1902; CHAPMAN, G. H.: Mosaic and Allied Diseases, Report of Botanist in 25th Annual Report Massachusetts Agricultural Experiment Station, 1913; ALLARD, H. A.: The Mosaic Disease of Tobacco, Bull. U. S. Department Agriculture, 40, 1914.

in some cases becoming long and sinuous. As the plants approach maturity and become infected they develop into the characteristic "gray-top" or "mottled-top." The incubation period of 10 or 15 days is followed especially in the hot sun by a very noticeable wilting of the upper leaves which become finely mottled. The mottling is due to the distribution of the dark-green shades along the fine anastomosing veins, while the lighter shades occupy the small inclosed areas. The roots of mosaic plants appear superficially quite normal but it is probable they are impaired, in form and function. It is however in the leaves that the disease is most manifest, which become blotched and mottled accompanied by distortions which produce at times fantastic leaf forms. The lamina is suppressed at times so that the leaf is reduced to a twisted midrib. Sometimes long sinuous ribbon-like leaf blades are found.

The flowers of diseased plants are characterized by the presence of the normal pink color in lines, specks, or conspicuous blotches, usually of very irregular distribution. A rather striking and symmetric color character is the occurrence of the pink color as a fine line in the sinus of each corolla lobe. Some blossoms are entirely devoid of color and have a blanched appearance.

Various solanaceous plants are susceptible to the mosaic. Such are many species of tobacco, tomato varieties, *Petunia*, two distinct garden varieties of *Physalis*, *Datura*, *Hyoscyamus*, *Solanum* (2 species), and in several varieties of *Capsicum*. It is probably distinct from the mosaic of pokeweed.

The incubation period of the mosaic disease is variable, depending upon conditions favorable or unfavorable to the growth of the plants. Eight days is the shortest period recorded. The mosaic virus permeates all parts of the plant, including the roots and corollas as well as the foliage, but it does not infect the embryos of seed produced by mosaic mother plants, and, therefore, such seeds produce healthy plants. The sap of mosaic plants after passing through a filter still retains its infectious properties and mosaic material ground and dried retained its virulence one and a half years. The virus preserved by ether, toluene and glycerin was virulent four months later, as was also the original juice, which had been allowed to undergo natural fermentation during that time. Certain species of aphides are active disseminators of the mosaic disease.

"Various theories have been advanced to explain the primary origin

of the mosaic disease of tobacco. The view most generally accepted defines the disease as a disturbance of the enzymatic equilibrium induced by unfavorable conditions of growth. An enzymatic disease is physiological in its nature, has its origin within the protoplasmic complex, and results in a serious and sometimes permanent impairment of the assimilative functions." Although it has been shown by previous workers that the oxidase and peroxidase content of mosaic leaves is higher than in normal healthy plants, this fact alone does not warrant, Allard thinks, its being considered the initial cause of the disease, for it might well be an effect rather than a cause. It is true that physiologic symptoms attend the mosaic disease such as chlorosis and various morphologic changes in the leaves, and hence we have placed it among the physiologic diseases, but notwithstanding, Allard thinks, that parasitism accounts for the primary origin of the disease more consistently than the enzymatic hypothesis.¹

BIBLIOGRAPHY OF NON-PARASITIC DISEASES

A complete bibliography of non-parasitic diseases up to May, 1915, will be found in Circular 183 Agricultural Experiment Station, University of Illinois by Cyrus W. Lantz, 81-111.

¹ Additional papers on mosaic are, as follows: GILBERT, W. W.: Cucumber Mosaic Disease, *Phytopath.* 6: 143-144 with 1 plate; DOOLITTLE, S. P.: A new Infectious Mosaic Disease of Cucumber, *Phytopath.* 6: 145-147; JAGGER, I. C.: Experiments with Cucumber Mosaic Disease, *Phytopath.* 6: 148-151, 1916.

PART IV

LABORATORY EXERCISES IN CULTURAL STUDY OF FUNGI

CHAPTER XXXVII

LABORATORY AND TEACHING METHODS

Introductory Remarks.—The fourth part of this book is designed principally to give directions for laboratory exercises in mycology, plant pathology and the determination of fungi. The teacher will find perhaps more than can be covered conveniently in a year's work, unless the number of hours to be devoted to the study is greater than usual in college or university work. The instructor will be compelled therefore to make a selection. There is provided in the fourth part laboratory exercises in the making of culture media and stains, the methods of study of bacteria and fungi, the manufacture and use of spray materials and keys for the identification of different kinds of fungi for use as class exercises in learning how to identify fungi and in becoming acquainted with the terms used in systematic mycology. The teacher systematically inclined can emphasize the taxonomic exercises provided in the lessons and appendices. The professor, who wishes to emphasize the important phases of plant pathology, will find in the fourth part exercises in the description and study of plant diseases and the pathogenic organisms concerned in disease production.

The teacher interested in technique will find many lessons which deal with that subject, as also the apparatus used in the scientific study of the fungi. The endeavor has been to appeal to a larger circle of students than those engaged in purely pathologic study. The inquirer, who wishes to lay a foundation in technical mycology, will find much along this line in Part IV and the preceding parts of the book. The teacher, who wishes to acquaint himself with the pedagogic methods, will find suggestions on this important phase of mycology in the last part of the text. The mycophagist, who desires to grow mushrooms, will

find in detail a method for doing so, and lastly, the practical grower will find formulæ and methods for combating the various fungous and insect foes which prey upon his crops and which must be subdued or held in subjection.

LESSON 1

Micrometry.—The unit of length used in microscopic measurement is the micron (1μ) which is the one-thousandth part of a millimeter (0.001 mm.). There are four kinds of micrometers in use: the stage, the eyepiece, the step, the filar, or cobweb, micrometer, and where in modern types, the cobweb is replaced by a finely spun platinum wire.

Method with Stage Micrometer.—The stage micrometer is a slide with a scale engraved on it divided to hundredths of a millimeter (0.01 mm.) every tenth line being made longer than the intervening ones, to facilitate counting.

1. Attach a camera lucida to the eyepiece of the microscope.
2. Adjust the micrometer on the stage of the microscope and accurately focus the divisions.
3. Project the scale of the stage micrometer on to a piece of paper and with pen, or pencil, sketch in the magnified image, each division of which corresponds to 10μ . Mark on the paper the optic combination (ocular objective and tube length) employed to produce this particular magnification. Do this for each of the possible combinations of oculars and objectives, and keep the scales that you have made for future work in measurement, which is accomplished by projecting the image of the object on the scale corresponding to the optic combination at use in the study.

Method with Eyepiece Micrometer.—The eyepiece micrometer is a circle of glass with a scale etched on the surface and suitable for insertion inside of the ocular used during the operation of measurement. The scale is divided to tenths of a millimeter (0.1 mm.) or the entire surface of the glass may be etched with squares (0.1 mm.), the net micrometer.

The value of one division of the micrometer scale must be ascertained for each optic combination by the aid of the stage micrometer, thus:

1. Insert the eyepiece micrometer within the tube of the ocular by placing it on the diaphragm of the ocular, and adjust the stage micrometer by placing it on the stage of the microscope.
2. Focus the scale of the stage micrometer accurately; the lines of the two micrometers will appear in the same plane. Make the lines on the two micrometers to parallel each other.
3. Make two of the lines on the ocular micrometer to coincide with those bounding one division of the stage micrometer; this is effected by increasing or diminishing the tube length; and note the number of included divisions.
4. Calculate the value of each division of the eyepiece micrometer in terms of by means of the following formula: $x = 10y$.

Where x = the number of included divisions of the eyepiece micrometer.

y = the number of included divisions of the stage micrometer.

5. Note the optic combinations used and keep a record of them with the calculated micrometer value. Repeat for each of the other combinations. To measure an object by this method, read off the number of divisions of the eyepiece micrometer it occupies and express the result in microns by looking up the standard value for the optic combination used.

Example.—Determine how many of the stage micrometer divisions correspond with the eyepiece micrometer divisions. Divide the first by the last, the quotient will be the true value of the ocular micrometer divisions in units of the objective micrometer. If 20 divisions of the ocular micrometer cover 87 divisions of the stage micrometer then $\frac{87}{20} = 43.5 = 0.0435$ mm.

Method with Filar Micrometer (Fig. 207).—This consists of an ocular having a fixed wire stretching horizontally across the field with a vertical reference wire

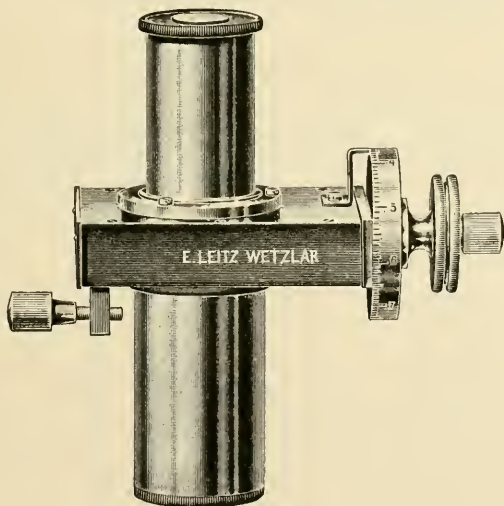

FIG. 207.—Screw micrometer eyepiece (Filar micrometer).

adjusted at right angles to the first and a fine wire, parallel to the reference wire, which can be moved across the field by the action of the micrometer screw. The trap head is divided into 100 parts, which pass successively a fixed index as the head is turned. A fixed comb with the intervals between its teeth corresponding to one complete revolution of the screw head is found in the field. As in the previous method, the value of each division of the comb scale must be found for each optic combination.

1. Place the filar micrometer and the stage micrometer in their respective positions.

2. Rotate the screw of the filar micrometer until the movable wire coincides with the fixed one, and the index marks zero on the screw head.

3. Focus the scale of each micrometer accurately and the lines in them parallel.
 4. Turn the micrometer screw until the movable line has traversed one division of the stage micrometer note the number of complete revolutions (by means of the recording comb) and the fractions of a revolution (by means of scale on the head of the micrometer screw) which are required to measure the 0.01 mm.

5. Make several estimations and average the results.

6. Note the optic combination employed in this experiment and record it carefully, together with the micrometer value in terms of μ .

7. Repeat this process for each of the different optic combinations and record the results.

To measure an object by this method, simply note the number of revolutions and fractions of a revolution of the screw, and express the result as microns by reference to the recorded values for that particular optic combination.

TABLE OF MICROMETER VALUES

Designation of objective	Focal length, mm.	Mark at which the draw tube has to be adjusted	100 intervals of the step micrometer covers as many intervals of the object micrometer as mentioned below. (1 interval equals $\frac{1}{100}$ mm.)	Micrometer value in microns (0.001 mm.)
<i>Achromat</i>				
1 ¹	42.0	174	300	30.0
1	40.0	154	300	30.0
2	24.0	174	150	15.0
3	16.2	141	100	10.0
3 ^a	13.0	159	70	7.0
4	10.0	168	50	5.0
5	5.4	152	30	3.0
6	4.0	160	20	2.0
7	3.0	174	15	1.5
Water immersion				
10	2.1	165	10	1.0
Oil immersion				
$\frac{1}{12}$	1.8	150	10	1.0

¹The tube length given has to be observed strictly and this tube length is understood inclusive of the nosepiece.

TABLE OF MICROMETER VALUES.—(Continued)

Designation of objective	Focal length, mm.	Mark at which the draw tube has to be adjusted	100 intervals of the step micrometer covers as many intervals of the object micrometer as mentioned below. (1 interval equals $\frac{1}{100}$ mm.)	Micrometer value in microns (0.001 mm.)
<i>Fluorite system</i>				
6a	4.2	180	20	2.0
7a	3.2	180	15	1.5
7b	3.0	152	15	1.5
8	2.6	135	15	1.5
9	2.2	168	10	1.0
Oil immersion $\frac{1}{12}a$	1.8	158	10	1.0
Oil immersion $\frac{1}{16}$	1.6	165	8	0.8
<i>Apochromats</i>				
16 mm.	16.0	128	100	10.0
8 mm.	8.0	170	40	4.0
4 mm.	4.0	160	20	2.0
3 mm.	3.0	148	15	1.5
Oil immersion 2 mm.	2.0	168	10	1.0

Step Micrometer

The special features of the step micrometer (Stufenmicrometer) are that ten intervals constitute one group. Each group is marked partly in white and partly in black. The black groups are accompanied by a white and the white groups by a black figure. These two different markings facilitate considerably the measurements of specimens of the opposite color. The grouping of ten intervals to one distinct group allows a rapid and convenient count. The value of one interval of the step micrometer is 0.06 mm.

Directions (Fig. 208).—Object micrometer 1 mm. divided into 100 parts to be

used. The step micrometer has 100 intervals distinctly indicated in the middle. It is necessary to find the number of intervals of the object micrometer covered by 100 intervals of the step micrometer, viz., with objective 3 (16 mm.), at a tube length of 141 mm., 100 intervals of the step micrometer cover 100 intervals of the object micrometer, equal to 1 mm.

One interval of the step micrometer is as $1 : 100 = 0.01$ or 10 micra. Micrometer value = 10.

With objective 6 (4 mm.) at a tube length of 160 mm. 100 intervals of the step micrometer cover 20 intervals of the object micrometer = 0.2 mm. One interval of the step micrometer therefore $0.2 = 100 = 0.002$ or 2 micra. Micrometer value 2.

This new micrometer eliminates the time-consuming measurement with three or more figures after the old method and is still more accurate.

Comment.—M. Nobert of Griefswald in Prussia engraved lines more than 100,000 to the space of an inch.

Laboratory Work.—Compute the various micrometric values according to the three methods outlined above. After determining these values for the various combinations of which your microscope is capable measure the following objects:

Spores of black mould, spores of slime moulds studied, various diatoms, etc. Practice these methods until you have perfected yourself in them.

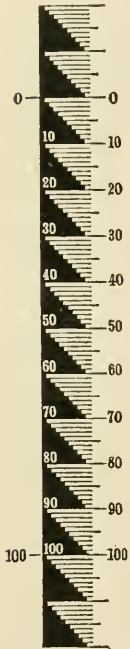

FIG. 208.—
Scale of step
micrometer.

REFERENCES

- BEALE, LIONEL S.: *How to Work with the Microscope*, 1868 (4th Edition), pp. 35-38.
- BEHRENS, JULIUS W., trans. by REV. A. B. HERVEY: *The Microscope in Botany. A Guide for the Microscopical Investigation of Vegetable Substances*, Boston, 1885, pp. 120-133.
- DOLLEY, CHARLES S.: *Notes on the Methods Employed in Biological Studies*, 1889, pp. 18-20.
- GAGE, SIMON HENRY: *The Microscope. An Investigation of Microscopic Methods and of Histology*, 1899, pp. 100-108.

LESSON 2

Directions for Plugging Test-tubes and Flasks.—Before sterilization all test-tubes and flasks must be carefully plugged with cotton-wool, and for this purpose best absorbent cotton-wool (preferably that put up in cylindrical one-pound cartons and interleaved with tissue paper) can be used (Fig. 209).

1. For a test-tube or a small flask, tear off a piece of cotton-wool some 10 cm. long by 2 cm. wide from the roll.

2. Turn in the ends neatly and roll the strip of wool lightly between the thumb and fingers of both hands to form a long cylinder.
3. Double this at the center and introduce the now rounded end into the mouth of the tube or flask.
4. Now, while supporting the wool between the thumb and fingers of the right hand, rotate the test-tube between those of the left, and gradually screw the plug of wool into its mouth for a distance of about the same length of wool projecting.

The plug must be firm and fit the tube or flask, but not so tightly that it cannot be removed by a screwing motion when grasped between the fourth, or third, and fourth fingers and the palm of the hand.

Rough Method of Cultivating Bacteria and Fungi.—1. Make decoctions of split peas, cabbage, lettuce, hay, lima beans, broad beans and water lily leaves by boiling in water. Expose decoctions to air by placing in an open vessel. This gives the organisms introduced from the air.

2. Boil a similar lot of material in a glass flask over a water bath. After material is thoroughly steamed, close opening of the flask with a cotton plug. Note result.

3. Place untreated material in distilled water previously boiled. Plug the flask with cotton. This will serve as a control. This gives the organisms introduced on the material.

Desiderata.—Flasks, cotton, water bath and Bunsen burner for these experiments will be found in the Culture Room. Perform all experiments there.

Other Materials.—Procure a loaf of dry bread, cut it into slices and place slices on a dinner plate. Wet bread until well soaked with water, cover with a bell jar provided with wet filter paper.

Similarly take horse manure, wet it and place under a bell jar. Place jars in a dark place. Inoculate the following culture media with the spores of the various fungi that grow on the bread and manure. For this purpose, use a platinum needle sterilized in the Bunsen flame.

Culture of Slime Moulds.—Compare: The Culture of *Didymium xanthopus* (DITMAR) Fr. in Synthetic Media, Science, new ser., XL: 791, Nov. 27, 1914.

LESSON 3

Microscopic Study of Culture Material.—A study is to be made of the organisms raised in the culture media prepared as directed in Lesson 2.

Hanging-drop Preparation.—1. Smear a layer of vaseline (sterile) on the upper surface of the ring cell of a hanging-drop slide by means of the glass rod provided with the vaseline bottle, and place slide on a piece of filter paper.



FIG. 209.—Cotton plugged tube with a potato slant resting on a bit of glass rod to keep the potato out of the water in the bottom of the tube. (After Williams, in Schneider, *Pharmaceutical Bacteriology*, p. 54.)

2. Flame a cover-slip and place it on the filter paper on which rests the hanging-drop slide.

3. Place a drop of water on the center of the cover-glass by means of the platinum loop.

4. Remove some of the material in the culture flasks by means of a platinum loop and mix it with the drop of water on the cover-slip.

5. Raise the cover-glass with the points of a forceps and rapidly invert it on to the ring cell of the hanging-drop slide, so that the drop of fluid occupies the center of the ring. (In exact investigation, carefully avoid contact between the drops of fluid and either the ring cell or the ring of vaseline. Should this happen, the infected hanging-drop slide and its cover-slip must be dropped into lysol solution and a new preparation made.)

6. Press the cover-slip firmly down into the vaseline on to the top of the ring cell. This spreads out the vaseline into a thin layer, and besides ensures the adhesion of the cover-slip seals the cell and almost prevents evaporation.

7. Examine microscopically (*vide infra*).

Microscopic Examination of the Unstained Material.—1. Place the tube of the microscope in a vertical position.

2. Arrange the hanging-drop slide on the microscope stage so that the drop of fluid is in the optical axis of the instrument, and secure it in the position by means of the spring clips.

3. Use one-sixth inch objective, rack down the body tube until the front lens of the objective is almost in contact with the cover-slip.

4. Apply the eye to the eyepiece and adjust the plane mirror to the position which secures the best illumination.

5. Rack the condenser down slightly and cut down the aperture of the iris diaphragm so that the light, although even, is dim.

6. Rack up the body tube by means of the coarse adjustment until the organisms come into view; then focus exactly by means of the fine adjustment.

Some difficulty is experienced at first in finding the hanging-drop, and if the first attempt is unsuccessful, the student must not on any account, while still applying his eye to the eyepiece, rack the body tube down, for by doing so there is every chance of breaking the cover-glass and contaminating the objective.

The examination of fresh material in a hanging-drop is directed to the determination of:

1. The nature of the bacteria and other organisms present.
2. The purity of the culture.
3. The presence or absence of motility.

When the examination is completed and the specimen finished the slide with cover slip should in the study of contagious material be dropped into the lysol pot.

Cf. KISSKALT, K.: *Practicum der Bakteriologie und Protozoologie*, Zweite Auflage, Erster Teil (Bakteriologie), pp. 10-12 (1909).

Mounting and Staining.—The mounting and staining of bacteria, protozoa and other microorganisms may be accomplished as follows:

1. Take the square, or round cover-slip, which has been previously cleaned out of the alcohol pot, dry it between filter paper.

2. Hold it in the bacteriologic forceps which are so constructed that a spring holds the cover-slip firmly, while an enlargement of the wire handle permits the placing of the forceps on the table while the culture material is obtained.

3. Place several drops of distilled water on the cover-slip and add a loopful of the organisms secured from the culture media as described in this lesson and from the pure culture in a test-tube as follows:

4. Remove the cotton plug by the third and fourth fingers of the left hand.

5. Hold the open test-tube between the thumb and forefinger of the left hand.

6. By means of a previously flamed platinum needle remove a little of the culture from the surface of the culture media.

7. Replace the cotton plug.

8. Add the culture material to the drop of distilled water on the cover-slip and distribute this material by stirring.

9. Evaporate the water on the cover-slip to dryness by holding it some distance above the Bunsen flame and slowly enough to prevent convection circles being formed by the material affixed to the cover.

10. Pass the cover-glass three times rapidly through the Bunsen flame.

11. Apply the stain, which should remain long enough to stain the objects. The stains to be used are described in detail below.

12. Wash off the stain with distilled water either from a wash bottle, or from a bottle suspended some distance above the laboratory table.

13. Dry between filter paper.

14. Apply a drop of balsam, turn the cover-slip over and drop it into the center of a glass slide previously provided and cleaned for the purpose.

STAINS.—One of the most useful bacteriologic stains is:

Ziehl's Carbol Fuchsin, prepared as follows:

Fuchsin (basic).....	1
Absolute alcohol.....	10
Carbolic acid (5 per cent. solution in water).....	100

The fuchsin should be dissolved first in the alcohol and then the two fluids mixed.

Loeffler's Alkaline Methylene Blue.—

Alcoholic solution of methylene blue (saturated).....	30
Caustic potash 1 }	100
Distilled water 10,000 }	

This fluid retains its valuable properties for a considerable time and is an excellent stain.

Ehrlich's Anilin-water Gentian Violet.

Alcoholic solution of gentian violet (saturated).....	5
Anilin water.....	100

This should be used as soon as prepared. It does not keep well.

Ehrlich-Weigert Anilin Methyl Violet.

Alcoholic solution of methyl violet (saturated).....	11
Absolute alcohol.....	10
Anilin water.....	100

This preparation does not keep well.

Gram's Stain.—This is a method of differential bleaching after a stain. The cover-glass preparations, or sections, are passed from absolute alcohol into Ehrlich's anilin gentian violet, or into a watery solution of methyl violet, where they remain one to three minutes, except tubercle bacilli preparations, which remain commonly twelve to twenty-four hours (Gram). They are then placed for one to three minutes (occasionally five minutes) in iodine potassium iodide water (iodine crystals, potassic iodide 2 gr., water 300 c.c.), with or without first washing lightly in alcohol. In this way they remain one to three minutes. They are then placed in absolute alcohol until sufficiently bleached, after which they are cleared in clove oil and mounted in Canada balsam. By this method the stain is removed from some kinds of bacteria and not from others. Too much confidence must not be placed in this method, since in some cases the removal, or non-removal of the stain from the organism depends on the length of exposure to iodine water. It would be better, therefore, to expose all for the same period, e.g., two minutes.

Delafield's Hæmatoxylin.—To 100 c.c. of a saturated solution of ammonia alum add, drop by drop, a solution of 1 gram of hæmatoxylin dissolved in 6 c.c. of absolute alcohol. Expose to air and light for one week. Filter.

Add 25 c.c. of glycerin and 25 c.c. of methyl alcohol. Allow to stand until the color is sufficiently dark. Filter, and keep in a tightly stoppered bottle. The addition of the glycerin and methyl alcohol will precipitate some of the ammonia alum in the form of small crystals. The last filtering should take place four or five hours after the addition of the glycerin and methyl alcohol.

The solution should stand for at least two months before it is ready for using. This "ripening" is brought about by the oxidation of the hæmatoxylin into hæmatin, a reaction which may be secured in a few minutes by a judicious application of peroxide of hydrogen (see CHAMBERLAIN, *Methods in Plant Histology*, p. 34).

Safranin Gentian Violet.—Stain two to three days in safranin (dissolve 0.5 gram safranin in 50 c.c. absolute alcohol, and after four days add 10 c.c. distilled water); rinse quickly in water; stain one to three hours in a 2 per cent. aqueous solution of gentian violet, wash quickly in water. Transfer from stain to absolute alcohol, clear in clove oil and mount in balsam.

Other useful stains in mycologic work are Fuchsin and Methyl Green, Fuchsin and Methylene Blue, Eosin Water, Erythrosin and Acid Fuchsin. For the preparation of these and directions for using consult CHAMBERLAIN, *Methods in Plant Histology*, and other books on microscopic technique.

Neisser's Stain.—To differentiate between diphtheria bacilli and pseudo-diphtheria bacilli.

1. Cultivate the organisms on fresh Loeffler's blood-serum at 34° to 35°C. for ten to twenty hours.

2. Stain with acid methylene blue three seconds.

3. Wash.
4. Stain with Aq. Vesuvin five seconds.
5. Wash.
6. Mount.

Diphtheria bacillus should show the polar granules stained *blue* and the body *brown*. Pseudo-diphtheria show no polar granules.

Auerbach's Stain.—AUERBACH, LEOPOLD: Untersuchungen über die Spermato-genese von *Paludina vivipara*. Jenaische Zeitschrift für Naturwissenschaft, 30: 405-554.

B. Acid fuchsin and Methyl green

Ba. Simultaneous.

1 part methyl green	}	I.
1000 parts of water		
1 part acid fuchsin	}	II.
1000 parts of water.		

To 50 grams of the red solution add 1 drop of 10 per cent. glacial acetic acid.

Solution I:	3 parts	}	Mix.
Solution II: acid	2 parts		

If necessary to filter, use a filter paper moistened with solution 1, as the paper absorbs the methyl green. Take slides from alcohol and stain slides five to fifteen minutes, having dried the glass leaving only the sections moist before immersion. 20° to 25° is best temperature; more heat hastens the absorption of methyl green, cold retards it. Place in absolute alcohol and destain five to fifteen minutes, or even an hour.

Polychrome Methylene Blue.—See MCFARLAND, JOSEPH: Pathogenic Bacteria and Protozoa, 1912, p. 197.

To a 0.5 per cent. aqueous solution of sodium bicarbonate add methylene blue (B X or "medicinally pure") in the proportion of 1 gram of the dye to 100 c.c. of the solution. Heat the mixture in a steam sterilizer at 100°C. for one full hour counting the time after the sterilizer has become thoroughly heated. The mixture is to be contained in a flask of such size and shape, that it forms a layer not more than 6 cm. deep. After heating, the mixture is allowed to cool, placing the flask in cold water, if desired, and is then filtered to remove the precipitate which has formed in it. It should, when cold, have a deep purple-red color, when viewed in either layer by transmitting a yellowish artificial light. It does not show this color, while it is warm. To each 100 c.c. of the filtered mixture, add 500 c.c. of a 0.01 per cent. aqueous solution of yellowish water soluble eosin and mix thoroughly. Collect the abundant precipitate which immediately appears on a filter. When the precipitant is dry, dissolve it in methylic alcohol (Merck's reagent) in the proportion of 0.1 grain to 60 c.c. of alcohol. In order to facilitate the solution, the precipitate is to be rubbed up with methyl alcohol in a porcelain dish, or mortar with a metal spatula, or pestle.

This alcoholic solution of the precipitate is the staining fluid. It should be kept

in a well-stoppered bottle, because of the volatility of the alcohol. If it becomes too concentrated by evaporation, and thus stains too deeply, or forms a precipitate on the blood smear, the addition of a suitable quantity of methylic alcohol will correct quickly such fault. It does not undergo any other spontaneous change except that of concentration by evaporation.

Differential Staining of Fungus and Host Cells.—Another useful method is set forth in the following:

VAUGHAN, R. E.: A Method for the Differential Staining of Fungous and Host Cells. *Ann. Mo. Bot. Gard.*, i: 241, 242.

LESSON 4

Liquid Nutrient Solutions.—Synthetic culture media (see SMITH: Bacteria in Relation to Plant Diseases, 1: 197):

Pasteur's Culture Fluid (Yeasts):

Ammonium tartrate.....	10 gr.
Ashes of yeast.....	10
Rock candy.....	100
Distilled water	1000 C.C.
Dissolve cold.	

Naegeli's Nutrient Solution.

Calcium chloride.....	0.1 gr.
Magnesium sulphate.....	0.2
Dipotassium phosphate.....	1.0
Ammonium tartrate.....	10.0
Distilled water.....	1000.0 C.C.

Cohn's Nutrient Solution.

Distilled water.....	1000.0 C.C.
Acid potassium phosphate.....	5.0 gr.
Magnesium sulphate.....	5.0
Neutral ammonium tartrate.....	10.0
Potassium chloride.....	0.5

(DEBARY, p. 86, Vorles. über Bakterien, 2 Auflage).

Raulin's Culture Fluid.

Distilled water.....	1500.00 C.C.	Magnesium carbonate..	0.40 gr.
Granulated cane sugar.....	70.00 gr.	Ammonium sulphate...	0.25
Tartaric acid.....	4.00	Zinc sulphate.....	0.07
Ammonium nitrate....	4.00	Ferrous sulphate.....	0.07
Ammonium phosphate	0.60	Potassium silicate.....	0.07
Potassium carbonate...	0.60		

Prazmowski's Culture Fluid.

Dipotassium phosphate.....	5.0 gr.
Magnesium sulphate.....	5.0
Ammonium carbonate.....	5.0
Calcium chloride.....	0.5
Distilled water.....	1000.0 C.C.

Dissolve cold. Any desired sugar may be added as carbon food.

Adolf Mayer's Culture Fluid (Unters ü-d. alc. Gähr., 1870).

Magnesium sulphate.....	10.0 gr.
Ammonium nitrate.....	15.0
Tri-basic calcium phosphate.....	0.1
Potassium phosphate.....	10.0
Distilled water.....	1000.0 C.C.

Dissolve cold and add sugar. Add NaCl (3 per cent.), if it is to be used for luminous bacteria, and an excess of pure carbonate of lime, if acid-forming bacteria are to be grown.

Uschinsky's Solution.

Distilled water.....	1000 C.C.
Glycerin.....	30-40 gr.
Sodium chloride.....	5-7
Calcium chloride.....	0.1
Magnesium sulphate.....	0.3 to 0.4
Dipotassium phosphate.....	2.0 to 2.5
Ammonium lactate.....	6-7
Sodium asparaginate.....	3-4

Modified Uschinsky's Solution.—The modified Uschinsky's recommended by Smith for use with starch jelly is made as follows:

Distilled water.....	1000.00 C.C.
Ammonium lactate.....	5.00 gr.
Sodium asparaginate.....	2.50
Sodium sulphate.....	2.50
Sodium chloride.....	2.50
Dipotassium phosphate.....	2.50
Calcium chloride.....	0.01
Magnesium sulphate.....	0.01

Fraenkel and Voges' Solution.

Water.....	1000 C.C.
Sodium chloride.....	5 gr.
Dipotassium phosphate.....	2
Ammonium lactate.....	6
Sodium asparaginate.....	4

Hygienische Rundschau, Bd. iv, 1894, p. 769.

Fermi's Culture Fluid.

Distilled water.....	1000.0 c.c.
Magnesium sulphate.....	0.2 gr.
Acid potassium phosphate.....	1.0
Ammonium phosphate.....	10.0
Glycerin.....	45.0

This may be added to agar in place of peptonized beef-broth (De Schweinitz) or to silicate jelly in which case the volume of water must be reduced.

Knop's Solution.

Calcium nitrate ($\text{Ca}(\text{NO}_3)_2$), gram.....	1.00 gr.
Calcium chloride (KCl), gram.....	0.25
Magnesium sulphate (MgSO_4), gram.....	0.25
Acid potassium phosphate (KH_2PO_4), gram.....	0.25
Distilled water, c.c.....	1000.00 c.c.

Mclisch's Culture Medium (for luminous bacteria).

Water.....	1000.00 c.c.
Gelatin.....	100.00 gr.
Sugar.....	20.00
Pepton.....	10.00
Dipotassium phosphate.....	0.25
Magnesium sulphate.....	0.25

Enough sodium hydroxide is added to render the medium fully alkaline. On this substratum, the bacteria grow feebly and are not luminous until sodium chloride, or some equivalent substance, is added (usually 3 per cent.). Then they grow well and become luminous.

Leberle-Will Culture Medium (for Yeasts).—See KÜSTER, Ernst: Kultur der Mikroorganismen, p. 143.

CaHPO_4 , gram.....	0.50
K_2HPO_4 , grams.....	4.55
MgSO_4 , grams.....	2.10
Pepton, grams.....	20.00
Water, liter.....	1.00

Hansen's Culture Media for Yeasts.

	Per cent.		Per cent.
Pepton.....	1	Pepton.....	1
Dextrose.....	5	Maltose.....	5
Potassium phosphate.....	0.3	Potassium phosphate.....	0.3
Magnesium sulphate.....	0.2	Magnesium sulphate.....	0.5

Claussen's Culture Medium for Pyronema confluens.—See KÜSTER, ERNST: Kultur der Mikroorganismen, p. 152. Claussen places in a Petri dish a small glass vessel and fills this to the rim with agar of the following formula:

	Per cent.
Agar.....	2.000
Inulin puriss.....	2.000
KH_2PO_4	0.050
NH_4NO_3	0.050
MgSO_4	0.020
$\text{Fe}_3(\text{PO}_4)_2$	0.001
H_2O	95.000

The outer free margin of the Petri dish is filled with inulin-free agar to a similar height as in the inner glass dish. In the middle one, spores of *Pyronema* are sown. After a few days the fungus will fruit on the inulin-free substratum.

Tubeuf's Culture Medium for Dry-rot Fungus.—See KÜSTER, ERNST: Kultur der Mikroorganismen, p. 154.

	Grams
Ammonium nitrate.....	10
Potassium phosphate.....	5
Magnesium sulphate.....	1
Lactic acid.....	2
Water.....	1000 C.C.

Laboratory Work.—Each member of the class should make up at least three of the above culture media. In order to save material, if the class consists of four to six students, the full amount of materials can be used and the final amount of liquid divided into four to six parts for the experiments of each member of the class with all of the media made according to the above formulæ. Where the class is smaller than four students, then one-half, or one-fourth of the materials should be used, as some of them are expensive chemicals.

Inoculate all of the culture solutions with yeast obtained from a cake of Fleischman's compressed yeast. Sterilize the needle and add some of the yeast on the end of the sterile needle. Study and note the growth of the yeast in the several culture media inoculated. Bacteria can also be used.

Fermenting Power of Different Yeasts.—Take a series of fermentation tubes and fill to the tops of the upright long branch with any of the liquid culture media used especially for yeasts. Inoculate one with dried yeast, one with brewer's yeast, one with compressed yeast, one with baker's yeast and others with several of the yeasts kept in pure culture, and plug the open end with cotton. Compare the depression of the upright column of liquid in the different fermentation tubes in order to determine the relative amount of gas formed.

Raulin's Medium for Moulds.

	Grams
Cane sugar.....	70.00
Tartaric acid.....	4.00
Ammonium phosphate.....	0.600
Magnesium carbonate.....	0.400
Ammonium sulphate.....	0.250
Zinc sulphate.....	0.750
Ferrous sulphate.....	0.075
Potassium silicate.....	0.070
Water.....	1500.00 c.c.

Too complicated to be of much value.

LESSON 5

Potatoes as Medium.—Whole white potatoes are taken and washed with corrosive sublimate 1:1000. They are then wrapped in filter paper and steamed in the sterilizer about thirty minutes, the next day twenty minutes, the third fifteen minutes. The potatoes are then cut in two by a knife heated in a Bunsen flame. The cut pieces are laid in a large flat glass dish on a circular piece of filter paper, the glass dishes having been sterilized by corrosive sublimate. Inoculations are then made on the surface of the potatoes. This method is especially useful for the growth of glanders, and chromogenic bacteria.

Potato Juice.

Grated potato, grams.....	100
Water, c.c.....	300

Mix and put in ice chest over night; strain off 300 c.c. through a cloth. Cook for one hour in water bath, filter and add $\frac{1}{4}$ per cent. glycerin. Sterilize. Do not neutralize as best growth of tubercle bacillus is obtained when the juice is acid. Growth is rapid and luxuriant, but non-virulent (*Archiv für Hygiene*, XVI). For culture in tubes with potatoes. Use knife designed by Ravenel, which is used in the same manner as a cork punch (Fig. 210). The semi-tubular pieces of potato, punched out, are beveled by a slant cut and placed in a test-tube which is laid flat with flat side of the potato down to prevent warping; the whole is then sterilized by the intermittent German process. After sterilization, it is sometimes advisable to add glycerin soaked in a cotton plug, to the test-tube in order to prevent drying. A specially designed test-tube (Fig. 211) is used so that the cut piece of potato can be introduced at the top and the glycerin in the enlarged bottom.

Glycerinated Potato.—1. Prepare ordinary potato wedges.

2. Soak the wedges in a 25 per cent. solution of glycerin for fifteen minutes.

3. Moisten the cotton-wool plugs at the bottom of the potato tubes with a 25 per cent. solution of glycerin instead of plain water.

4. Insert a wedge of potato in each tube and replug the tubes.

5. Sterilize in the steamer at 100°C. for twenty minutes on each of five consecutive days.

Glycerin Potato Broth.—1. Take 1 kilo of potatoes, wash thoroughly in H_2O , peel and grate finely on a bread grater.

2. Weigh the potato gratings, place them in a 2-liter flask, and add distilled water in the proportion of 1 c.c. for every gram weight of potato. Allow the flask to stand in the ice chest for twelve hours.



FIG. 210.—Knife punch designed to cut cylinder of potatoes and other vegetables for insertion as slant cylinders in test-tubes as culture media.



FIG. 211.—Culture tube with bulb to hold glycerine and water below slant of vegetable.

3. Strain the mixture through cheese cloth and filter into a graduated cylinder. Note the amount of the filtrate.

4. Place the filtrate in a flask, add an equal quantity of distilled water, and heat in a steam sterilizer for an hour.

5. Add glycerin, 4 per cent., mix thoroughly and again filter.

6. Tube and sterilize in the steamer at $100^{\circ}C.$ for twenty minutes on each of three consecutive days.

LESSON 6

Solid Vegetable Substance (Fig. 210).—These should consist of slant cylinders (Fig. 211) in cotton-plugged test-tubes with some distilled water and steamed twenty minutes at 100°C. on each of three consecutive days or at the same temperature for over an hour. Discontinuous sterilization is best. The following are some of the vegetable substances recommended:

- | | | |
|-----------------|----------------|---------------------|
| 1. Potato | 7. Salsify | 13. Peanuts |
| 2. Sweet potato | 8. Parsnip | 14. Brazil nuts |
| 3. Carrot | 9. Onion | 15. Apple |
| 4. Sugar beet | 10. Tulip bulb | 16. Pear, or quince |
| 5. Turnip | 11. Banana | 17. Pineapple |
| 6. Radish | 12. Coconut | 18. Macaroni |

This list may be extended almost indefinitely. The method of preparation of these solid vegetable substances for the test-tubes is fully described in Lesson 5.

Oat Meal.—Put 10 grams of oatmeal in 1000-c.c. Erlenmeyer flask. Add 200 c.c. of distilled water. Stir until thoroughly mixed and autoclave for twenty-five minutes at 120°C.

Corn Meal.

10 grams + 10 c.c. of water.

10 grams + 15 c.c. of water.

10 grams + 20 c.c. of water.

LESSON 7

Plant Juices (With and without the addition of water).—*Hay Infusion*.

1. Weigh out dried hay, 10 grams, chop it up into fine particles and place in a flask.
2. Add 1000 c.c. distilled water, heated to 70°C. Close the flask with a solid rubber stopper.
3. Macerate in a water bath at 60°C. for three hours.
4. Replace the stopper by a cotton plug, and heat in the Arnold sterilizer at 100°C. for an hour.
5. Filter through filter paper.
6. Tube and sterilize in the Arnold sterilizer at 100°C. for one hour on each of three consecutive days.

Orange Juice.

1. With a wooden, or metal lemon-squeezer remove the juice from one or several oranges according to requirements.
2. Filter through ordinary filter paper.
3. Add to the test-tubes provided for the purpose.
4. Plug the test-tubes with cotton.
5. Sterilize on three consecutive days.

Prune Juice.

1. Take a dozen or two of prunes and boil them in water until the water is decidedly colored with the prune extract.

2. Add this prune juice to test-tubes and plug.

3. Sterilize on three consecutive days.

Coconut Water.—This is removed directly from the nut to sterile test-tubes by means of sterile pipettes, which are useful in many ways. The pipettes should be dry-heated and kept from contamination, or in long, narrow, covered tin boxes.

Wheat Broth (After Eyre and Gasperini).

1. Weigh out and mix wheat flour, 150 grams; magnesium sulphate, 0.5 gram; potassium nitrate, 1 gram; glucose, 5 grams.

2. Dissolve the mixture in 1000 c.c. of water heated to 100°C.

3. Filter through filter paper.

4. Fill test-tubes and sterilize on three consecutive days.

Plant Decoctions, or Infusions in General (After Heald).—Liquid media containing the soluble nutrients derived from various plant structures are of special value in dealing with fungi and may be used with bacteria, although they are not so important for these organisms. By the selection of parts of a host plant for making a medium for the growth of the attacking fungus, it will be provided with food nearer to its immediate needs than from the standard nutrient media. Plant decoctions may be used as liquid media, or they may serve in combination with other media solidified by gelatin, or agar.

Some of the most valuable plant decoctions are obtained from fruits, seeds, root parts and other plant organs. Decoctions may be made from *fresh plant parts* as sweet potatoes, beets, turnips, carrots, celery, bean pods, plums, apples, etc., or *dried plants* such as dried apples, dates, beans, leaves, etc.

In preparing either decoctions, or infusions, it is well to have the parts employed in a finely divided state. The parts may be run through a food chopper or ground finely by a small coffee mill. The pharmaceutical standard should be selected for decoctions and infusions, *i.e.* 1000 c.c. should contain the soluble constituents of 50 grams of dry weight of the product employed. To secure uniformity of composition the following table can be used in determining the weight of the fresh product to be employed.

TABLE TO DETERMINE AMOUNT OF DRY SUBSTANCE TO BE USED

Name of plant organ	Water content, per cent.	Dry substance, per cent.	Approximate weight yielding 50 grams of dry substance, grams
Potato	75	25	200
Sugar beet.....	82	18	275
Carrot.....	87	13	390
Celery.....	84	16	315
Leaves (young).....	75	25	200
Leaves (mature).....	55	45	
Bark (fresh).....	15	85	60
Bark (air dry).....	7	93	55

Directions for Making Plant Infusion.

1. Add 1000 c.c. of boiling distilled water to 50 grams dry weight of the substance of the equivalent, chopped or ground fine.
2. Macerate in a closed vessel for thirty minutes.
3. Strain through cheese cloth or filter as for other media and pass distilled water through the filter to make 1000 c.c. If a clear medium is desired the white of an egg may be added.

Directions for Making a Plant Decoction.

1. Add 1000 c.c. of cold distilled water to 50 grams dry weight of the substance, or the equivalent, chopped or ground fine.
2. Heat in a cooker over a gas burner and boil for fifteen minutes, stirring sufficiently to prevent burning.
3. Filter as for infusion and clear, if desirable. Decoctions are preferable to infusions since there will be a somewhat more complete extraction of the nutrients.

Laboratory Study.—In the use of the culture fluids observe the rapidity, density and persistency of the growth. Record the formation of acids, alkalis, odors, gas bubbles, stains, etc.

LESSON 8

Milk.—Nearly all bacteria grow in milk. Ordinary cow's milk is used. The cream is separated off and the skim milk used. Ordinary milk as sold is contaminated with fecal bacteria, those found in cow's dung and around stables. Consequently the milk before it is used must be thoroughly sterilized. It may be used in this form, or a tincture of blue litmus is added until a pale blue color is obtained. Different organisms react differently with this milk; some render the litmus more deeply blue, others are indifferent, some give an acid reaction.

The milk should not be acid to taste and should not contain formaldehyd, or other antiseptic substance which milk dealers sometimes add to milk to improve its keeping qualities. It should be steamed in wire-crates fifteen minutes at 100°C. on each of four consecutive days (100-c.c. portions in test-tubes) and should not be used until at least a week after the last steaming. Such milk should be kept under observation at least six or eight weeks.

Litmus milk is prepared from fresh milk which has been passed through a separator (centrifuge) or from milk which has stood eighteen or twenty hours at 20°C. and has had the cream removed by skimming. To each 100 c.c. of this milk is added 2 c.c. of a saturated solution of high-grade lime-free blue litmus (litmus 1 gram, water 15 c.c.). This gives a lavender color of just the right degree, which reddens distinctly under the action of acids and blues with the development of alkalis. After adding the litmus water, the milk should be pipetted in 10-c.c. portions into cotton-plugged test-tubes and heated as directed above. This is a very useful medium.

Litmus Whey (After Eyre).

1. Curdle fresh milk by adding rennet (or by acidifying with hydrochloric acid).
2. Filter off the whey into a sterile flask.
3. Heat in the Arnold sterilizer for one hour.
4. Filter into a sterile flask.

5. Tint the whey with litmus solution to a deep purple red.

6. Tube, and sterilize as for milk.

Laboratory Study.—Milk offered for sale in cities is frequently more than forty-eight hours old and often contains 3,000,000 to 6,000,000 bacteria per cubic centimeter. Such milk is not fit for laboratory use.

Observe in particular:

(a) The separation of the casein without the development of any acid, indicating the presence of lab, or rennet, ferment. The milk usually becomes more alkaline.

(b) Saponification of the fat. The fluid becomes transparent without any precipitation of the casein; but the caseinogen may be thrown down subsequently by acidifying the clear liquid.

(c) Ropiness. The liquid becomes viscid and strings when touched.

(d) Formation of acids.

(e) Resolution of precipitated casein (trypsin ferment); formation of crystals, tyrosin, leucin, etc.

(f) Gelatinization of old cultures. Milk alkaline.

(g) Changes in smell, color, taste.

Beerwort.—Beerwort obtained from the brewery is put in test-tubes with cotton plugs. These test-tubes are then sterilized by discontinuous sterilization and then inoculated. It is a useful medium for the culture of yeasts.

Beerwort may be added to agar, or in the cultivation of moulds for class study it may be used to soak bread or other material on which the moulds are to be cultivated.

LESSON 9

Bouillon.—Bouillon forms the nutrient basis for culture media. It is made up in the following proportions, a certain amount of water being used: 1 per cent. peptone, .5 per cent. NaCl and .5 per cent. beef extract are added and the liquid boiled. Thus for 1 liter of H₂O

10 grams peptone	}	are added.
5 grams salt		
5 grams beef extract		

This solution has a slight acid reaction and is neutralized by 10 per cent. NaOH until it is no longer acid to blue litmus, but is still acid to phenolphthalein. Bouillon is used either alone or with other media in combination.

Fresh Bouillon.—Prepared by digesting fresh veal (3 pounds) in water over night. This mass is then pressed until the water and dissolved juice are separated from the meat fiber. After filtration, the liquid is brought to a boil and a coagulation of the albuminoids present takes place. The liquid is again filtered and is found to be decidedly acid. In one case it was found that 3 pounds of veal made 2800 c.c. of liquid beef tea, or meat extract, which consists essentially of the salts of the meat. To make the regulation bouillon, to this liquid must be added salt and peptone according to the following proportion. Glycerin may be added for the growth of the tubercle bacillus.

2800 c.c.	Water extract beef	} (Bouillon alone)
38 grams	Peptone	
14 grams	Salt	
<hr/>		
140 c.c.	Glycerin	

After boiling, to this is to be added enough of 10 per cent. NaOH to neutralize the acidity of the meat extract. It must be neutralized until it is alkaline to blue litmus and acid to phenolphthalein. It is again filtered and is ready for use. Tubercle bacilli grow exceptionally well in this second solution.

Fresh Bouillon (Another formula).—Standard peptonized beef bouillon is made as follows: To 500 grams of finely minced lean beef add 1000 c.c. of distilled water.

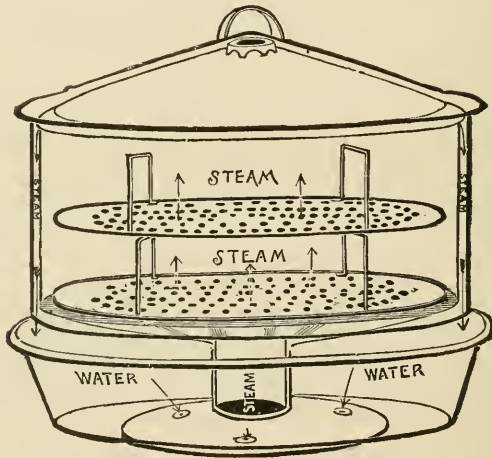

FIG. 212.—Diagram illustrating construction and action of Arnold steam sterilizer. (Fig. 15, p. 39, *Schneider, Pharmaceutical Bacteriology*, 1912.)

The soluble parts may be removed from the meat by allowing the water to stand on it for twenty-four hours in the ice chest or for one hour in the water bath at 55°C. The second method is perhaps preferable. Then boil for sixty minutes either in the steamer, or in a covered dish. Filter through clean cloth, using pressure (meat press), cool, and remove fat by filtering through filter paper; make up to 1000 c.c. by addition of more water; then add 1 per cent. Witte's peptonum siccum and 0.5 per cent. c.p. sodium chloride. Steam one-half hour, filter, pipette into test-tubes or flasks, and autoclave or heat for a minimum time in the Arnold sterilizer (Fig. 212). Plugs should be well made and fit tightly; glassware should be scrupulously clean. For some purposes both the peptone and the salt should be omitted. A greenish bouillon indicates insufficient boiling, and will usually throw down some additional vexatious pre-

cipitate when heated in the test-tubes. Other meats may be substituted for beef, and other peptones for Witte.

Glycerin Bouillon.

1. Measure out nutrient bouillon, 1000 c.c.
2. Measure out glycerin, 60 c.c. (=6 per cent.) and add to the bouillon.
3. Tube and sterilize as for bouillon.

Sugar Bouillon.

1. Measure out nutrient bouillon, 1000 c.c.
2. Weigh out glucose, 20 grams (=2 per cent.) and dissolve in the fluid.
3. Tube and sterilize as for bouillon. Ordinary commercial glucose serves the purpose equally well, but it is not recommended, as during the process of sterilization the medium gradually deepens in color. In certain cases a corresponding percentage of lactose, maltose, or saccharose, is substituted for glucose.

LESSON 10

Egg Albumen.—Absolutely fresh eggs should be used. The end of the egg from which the albumen is poured must be thoroughly flamed before it is broken, and care must be used in the transfer to test-tubes, so as to exclude air-borne germs; otherwise, the sterilization will be difficult. By being placed in a steam sterilizer and sterilized by intermittent sterilization for three days, *care being taken to leave off the cover of the sterilizer* (Fig. 211), the albumen will be found to be white, quite hard and ready for use. If the lid of the sterilizer is kept on and the heat becomes too great, bubbles will form in the albumen and thus spoil its usefulness. The albumen of eggs may be cut with sterile scissors.

Egg Albumen (After Eyre, *The Elements of Bacteriological Technique*, 1902: 160).

1. Break several fresh eggs (hens', ducks', or turkeys' eggs) and collect the "whites" in a graduated cylinder, taking care to avoid admixture with yolks.

2. Add 40 per cent. distilled water, and incorporate the mixture thoroughly by aid of an egg whisk.

3. Weigh out 0.15 per cent. sodium hydrate and dissolve it in the fluid (or add the amount of decanormal caustic soda solution (see *infra*) calculated to yield the required percentage of soda in the total bulk of the fluid—*i.e.*, 0.375 c.c. of decanormal NaOH solution per 100 c.c. of the mixture.

- 3a. Glucose to the extent of 1 or 2 per cent. may now be added, if desired.

4. Strain the mixture through butter muslin and filter through a porcelain filter candle into a sterile filter flask.

5. Tube, and stiffen at 100°C. in the serum inspissator, or in the steam sterilizer with the lid off.

6. Incubate at 37°C. for forty-eight hours and eliminate any contaminated tubes; store the remainder for future use.

Egg Yolk.—This is poured into test-tubes and solidified in a slanting position by 80°C. heat, or the egg may be boiled hard and the yolk cut with a sharp knife and transferred to sterile petri dishes. If desired the yolk and white may be mixed before solidifying, *i.e.* by shaking the egg vigorously before breaking the shell.

Solidified Blood-serum.—As this medium is rather difficult to obtain and prepare, being one of the most difficult to make in culture work, the plant mycologist must in general obtain blood-serum from the animal bacteriologist. Near Philadelphia it can be purchased from the laboratory of H. K. Mulford & Co., Glenolden, Pa. The solidified serum may be used either plain or with the addition of grape sugar.

Fresh Serum How Obtained.—Procure blood by a sterile method from a horse, or a cow, and stand it aside in a cool place, breaking the clot from the side of the jar until the amber-colored serum rises to the surface, when it is to be drawn off. It is then filtered and measured off. To 3 parts of this serum, 1 part of bouillon, prepared in the ordinary way, is to be added. The mixture of bouillon and serum is then to be filled into the sterile test-tubes, care being taken to slant the tubes. By being placed in a steam sterilizer and sterilized by intermittent sterilization for three days, care being taken to leave off the cover of the sterilizer, the serum will be found to be white and quite hard and ready for use. If the lid of the sterilizer is kept on and the heat becomes too great, bubbles will form in the serum and thus spoil the usefulness of the hardened serum.

Before filling the tubes, care must be taken that the mixed serum and bouillon are thoroughly neutralized by NaOH. As blood-serum is rarely used in mycologic work, the above notes are given merely for reference. The teacher will probably find it convenient to omit this part of Lesson 10 entirely.

LESSON 11

Nutrient Gelatin.—To 1000 c.c. of sterile peptonized beef-bouillon add 100 grams of best quality gelatin. Soak two hours at room temperature, then steam five minutes, cool, titrate, add the necessary alkali, steam thirty minutes, filter through filter paper, wash with sterile boiling hot water, tube at once, and heat in the steamer on three successive days fifteen minutes, ten minutes and five minutes respectively at 100°C. Do not autoclave, and carefully avoid long heating in the steamer. Have all glassware sterile, the fluids sterile and sufficiently boiled to begin with. The very best English, French or German gelatins should be used. +10 or +15 is a good degree of alkalinity for many purposes.

Sugar Gelatin.

Water, c.c.....	600
Peptone, grams.....	6
Salt, grams.....	3
Beef extract, grams.....	3
Glucose, grams.....	6
Gelatin, grams.....	60

The gelatin is added as the mixture in water is brought to a boil. The mixture is cooled down to 60° below the coagulating point of albumen and the white of two eggs for every 1000 c.c. of water added. It is then brought to a boil, the albumen coagulates and clarifies the medium. The fluid is then filtered through filter paper previously wetted with boiling water. A funnel with wire support for filter paper is to be preferred for ease in filtering.

Sugar Gelatin (Another formula).—Prepare nutrient gelatin and weigh out glucose 20 grams (= 2 per cent.) and dissolve in the hot gelatin. Filter, tube and sterilize as for nutrient gelatin. In certain cases, lactose, maltose or saccharose in similar percentages is substituted for glucose.

Litmus Gelatin.—Prepare nutrient gelatin, add sterile litmus solution, sufficient to tint the medium a deep lavender color, tube and sterilize as for nutrient gelatin.

LESSON 12

Agar-agar.—To make 1 liter of agar-agar take

- | | | |
|----|--|-----|
| A. | Dried peptone (1 per cent.), grams. | 10 |
| | Common salt (0.5 per cent.), grams. | 5 |
| | Liebig extract (0.5 per cent.), grams. | 5 |
| | Water, c.c. | 500 |
| | Boil for three minutes and neutralize. | |
| B. | Agar-agar (1.2 per cent.), (in shreds, or as flour) grams. | 12 |
| | Water, c.c. | 500 |

Chop the agar and put into autoclave (Fig. 213). Run autoclave up to two atmospheres of pressure, giving 121.4°C. of heat. As soon as this pressure is reached, turn out the flame, and allow the autoclave to cool until below 100°C. before opening. The two solutions A and B are then mixed, cooled to 60°C., the whites of two eggs beaten in 50 c.c. of water added, well stirred in, and the whole then boiled, the solidified albumen and precipitate skimmed off and the residue filtered through paper.

The whole process requires only an hour and a quarter to an hour and a half, and the result is a most excellent jelly. Instead of the white of egg, blood-serum may be used, which seems to add also to the nutritive value of the medium.

Agar made with meat extract will often form a precipitate during the sterilization, which is objectionable if one wishes to use it in the pouring of Petri dishes, or the making of Esmarch's roll-tubes.

Agar with Fresh Meat.—To make an absolutely and permanently clear agar, fresh meat should be used as follows:

To make 1 liter, take:

- | | | |
|----|--|-----|
| A. | Chopped meat, grams. | 500 |
| | Water, c.c. | 500 |
| | Mix and place in cool place over night, then strain through towel. | |
| B. | Agar-agar (1.2 per cent.), grams. | 12 |
| | Water, c.c. | 500 |

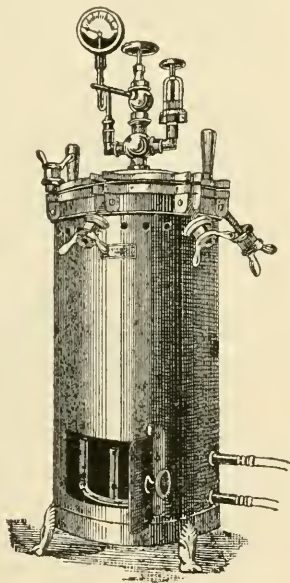

FIG. 213.—Usual form of laboratory autoclave for sterilization with steam under pressure. (Fig. 16, p. 40, *Schneider, Pharmaceutical Bacteriology*, 1912.)

Put in autoclave, run up to two atmospheres of pressure, put out flame, and allow to cool until below 100°C . before opening (Fig. 213). Let the solution of agar cool still further to about 75°C ., and then mix *A* and *B*, add (1 per cent.) 10 grams dried peptone and (0.5 per cent.) 5 grams common salt, bring to a boil for about three minutes, neutralize and filter. The product is an absolutely clear jelly, which never forms any precipitate. The whole process, with the exception of the time the meat is steeping, requires only about one hour and a half. In both the above methods of making agar, the filtration is very quick—from ten to twelve minutes for the liter. It is not necessary to use a hot-water funnel, but wet the filter paper with boiling water immediately before pouring in the agar. In the process with fresh meat the clarification is effected by the coagulation of the albumen in the meat water, hence solution *B* must not be added to *A* until cool enough to avoid coagulation. In general the fresh meat is to be recommended, and the process is easier than with the meat extract, though the latter has the advantage of cheapness and convenience, since the meat extract can always be kept on hand, and the time lost in soaking the fresh meat is saved.

Methods of Inoculations of Agar-agar.—Agar is stored in test-tubes in one of two ways, viz.: as a straight, or cylindrical medium; or, as an oblique, or slanted medium.

1. Oblique or slanted medium. Here the medium has been allowed to solidify with the tube in an inclined position, thus forming a flat surface extending nearly to the mouth of the tube. Such slanted agar is used for "streak" (Strich cultur), or "smear" cultivations.

2. Straight, or cylindrical, medium. Here the medium forms a cylindrical mass in the lower part of the test-tube and the upper surface is at right angles to the long axis of the tube. Such a cylindrical medium is suitable for stab culture when the platinum needle is thrust deeply into the substance of the medium with the needle held vertically.

LESSON 13

Various Nutrient Agars.—In addition to beef bouillon, or in place of it, various substances organic and inorganic may be added to the agar with advantage.

Litmus lactose agar is made out of ordinary nutrient agar by adding milk sugar and enough pure litmus to give the tests. To 1000 c.c. of ordinary agar, preferably that made from bouillon free from muscle sugar, add 10 grams of c.p. lactose and 20 c.c. of a saturated (water) solution of c.p. (lime-free) blue litmus.

Glycerin agar, maltose agar may be made with any amount of the substance desired, generally 1 or 2 per cent. (1000 c.c. agar plus 50 c.c. Schering's c.p. glycerin).

Beerwort agar is conveniently made in 1 or 2 per cent. combinations of beerwort and ordinary agar. Take a measured quantity of agar by volume and after it is liquefied in the steam sterilizer add enough beerwort by volume to make a 1 or 2 per cent. quantity of that liquid.

Glucose agar is a useful culture medium. Take 1 or 2 per cent. of glucose by weight (1 gram = 1 c.c. by volume) and add to a measured volume of agar in the liquid form.

Dextrose Agar.

Dextrose, grams.....	10
Agar, grams.....	15
Water, c.c.....	500
Nutrient solution (same as for cellulose agar) c.c.....	500

Hesse and Niedner's Nutrient Agar for Water Bacteria (SMITH, p. 196).

Distilled water, c.c.....	980.
Nährstoff Heyden, an albumose, grams.....	7.5
Agar-agar, grams.....	12.5

This agar is said to be the most suitable medium for the bacteriologic examination of water. It gives a much larger number of colonies than ordinary agar. It requires no neutralizing. The poured plates are counted according to Dr. Robin on the ninth and tenth day. Chromogens are brilliantly colored (*Zeitschr. für Hygiene*, Bd. XXIX: 454-462; see also *Amer. Journ. Pharm.*, LXXVI: 112).

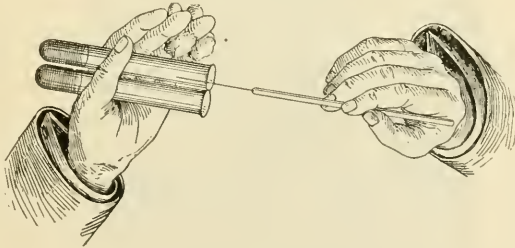

FIG. 214.—Manner of holding test-tubes in making subcultures. (After Williams in Schneider, *Pharmaceutical Bacteriology*, p. 54.)

Prune Agar (C. S. SHEAR and N. E. STEVENS, *Cultural Character of the Chestnut Blight Fungus and Its Near Relatives*. Circular No. 131, U. S. Bureau of Plant Industry).—Take four ordinary prunes and add 1 liter of water. Boil over an open flame for one hour, being careful not to break the skin of the prunes. Strain through gauze, make up to the original amount with distilled water and add 2 per cent. of agar. Steam for three-quarters of an hour, filter and tube. Autoclave for fifteen minutes at 115°C. (Fig. 213).

Media for Mine Fungi (Dr. Caroline Rumbold).

1. Pure gelatin 10 per cent., 20 per cent. Bausch and Lomb imported seal gelatin.
2. 6 per cent. gelatin, 2.5 per cent. Liebig's extract, 1 per cent. citric acid. Cox's gelatin can also be used. This was more successful than the golden seal gelatin. This with 1 per cent. citric acid solidified.

Laboratory Work.—Inoculate any or all of the several nutrient agars with several of the stock cultures of fungi. Note the rate of growth and differential character of the growth on the different media (Fig 214).

LESSON 14

General Directions for Making Plant Agars.—Plant agars of various kinds may be made by substituting the desired decoction (made as directed later) for the bouillon and each 1000 c.c. of agar should contain the soluble nutrients from 50 grams of dry weight of the plant structure used.

Decoctions (F. D. Heald) are made by adding 1000 c.c. of cold distilled water to 50 grams dry weight of the substance. Heat in a steam sterilizer and boil for fifteen minutes. The following data are applicable in this connection.

TABLE OF DRY CONTENTS

Materials	Water content, per cent.	Dry substance, per cent.	Approximate weight giving 50 grams of dry substance, grams
Potato.....	75	25	200
Sugar beet.....	82	18	275
Carrot.....	87	13	390
Celery.....	84	16	315
Corn meal.....	83	17	300

Corn Meal Agar.—This nutrient medium is made by taking 300 grams of corn meal and adding 1000 c.c. of distilled water. Heat it in a cooker over a gas burner and boil for fifteen minutes. The decoction is then made up with agar being used in place of bouillon. Clinton (Conn. Exper. Sta. Rep. 1907-08: 898) gives these directions for making *corn meal juice agar*. With a 50 + 10 + 500 formula; that is, 50 grams of dried corn meal (= 300 grams of wet corn meal), 10 grams agar-agar and 500 c.c. of water. The corn meal is made into a decoction by using not over 500 c.c. of water strained through fine cloth, the agar-agar is added, heated long enough to mix agar-agar and filtered.

Corn Meal Agar (Another Formula).—To 50 grams of corn meal add 1 liter of water. Keep in a water bath for one hour at a temperature of 58°C., never over 60°. Filter through paper, add 1¼ per cent. of agar flour, steam for 1½ hours, filter and tube. Autoclave for fifteen minutes at 115°C. Corn meal agar made by the above formula generally tests +3.

Lima Bean Juice Agar (CLINTON: Conn. Exper. Sta. Rep. 1907-08: 898).—Use a 50 + 10 + 500 formula; that is, 50 grams of dried ground lima beans, 10 grams of agar-agar and 500 c.c. of water. The beans are ground as fine as possible with a fruit grinder, and then 50 grams are soaked one-half hour in tepid water (use as much water as necessary, but of course not to exceed 500 c.c. finally) and then simmer slightly for another half hour. Strain off the liquid through a fine wire strainer, add agar-agar (better dissolve in a small amount of water) and add water necessary to make 500 c.c. of medium; heat long enough to thoroughly mix the agar-agar and strain through fine cloth into test-tubes.

LESSON 15

Potato Juice Agar (150 + 10 + 500).—Take 150 grams of peeled potato, slice it thin, soak it in tepid water and allow it to simmer for half an hour. The juice is used from this in place of bouillon in making the agar-agar.

Potato Agar.—Put clean pared potatoes rapidly through a grater and immediately throw into the required quantity of distilled water, which should be used in ratio of 2 c.c. of water to 1 gram of the potato. Then put in the Arnold sterilizer. Soak the agar in water (1 gram of agar to 100 c.c. of water), add to the potato and mix thoroughly (Washington formula).

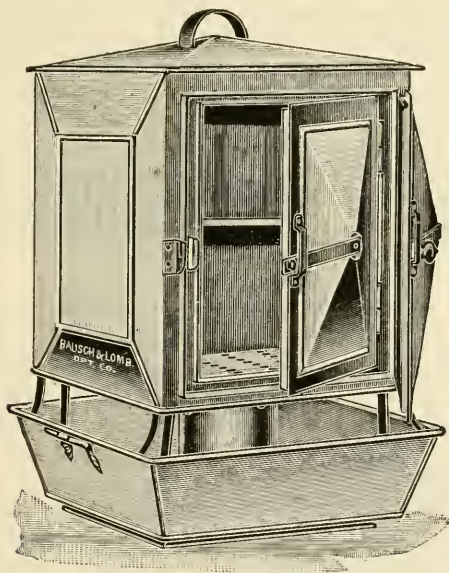

FIG. 215.—Square form of Arnold steam sterilizer, showing two front doors as recommended by the Boston Board of Health. (Fig. 17, p. 42, *Schneider, Pharmaceutical Bacteriology*, 1912.)

Mel T. Cook's Formula.—Cook says 500 grams in 500 c.c. of water, 10 grams of agar in 500 c.c. of water.

Dr. Caroline Rumbold's Formula.—The freshly grated potato, 500 grams in 500 c.c. of water, is put in the Arnold steam sterilizer and heated up to 90°C. Part of the pulp is strained through cheese cloth. 7.5 grams of agar are soaked in 500 c.c. of distilled water and before the agar has dissolved, it is put into the potato, and the whole thoroughly mixed. It is then steamed by discontinuous sterilization (Fig. 215).

McBeth and Scales Formula (McbETH, I. G. and SCALES, F. M.: *The Destruction*

of Cellulose by Bacteria and Fungi. Bull. 266, Bureau of Plant Industry, 1913: 28).—Pare, steam and mash a quantity of potatoes. To 100 grams of mashed potato add 800 c.c. of tap water and steam for one-half hour; filter through cotton.

Potato solution, c.c.....	500
Agar, grams.....	15
Nutrient solution, c.c.....	500

Potato Agar (Another formula).—Put clean pared potatoes through a meat grinder. To 1000 grams of the potato pulp add an equal quantity of distilled water. Stir thoroughly and let stand in an ice box for an hour, with occasional stirring. Strain through gauze of medium mesh. Make up to three times the weight of the original pulp with distilled water. Strain for one hour, filter through cotton and paper and make up to 3000 c.c. with distilled water. Add 1½ per cent. of agar flour, steam for one hour, filter through cotton and paper, tube and autoclave for fifteen minutes at 115°C. As this potato agar varies widely in acidity, to reduce this variation a large quantity of potato juice made from a uniform lot of Burbank potatoes is used. This is placed in 1000-c.c. flasks tightly plugged and kept in a refrigerator. The juice is then made up in agar tubes as needed. It was found that this agar varied less than 1 per cent. in acidity, changing from +7 to +6 during five months.

LESSON 16

Starch Agar.—To 800 c.c. of boiling water add 10 grams of potato starch suspended in a little cold water. Concentrate by boiling to 500 c.c. This breaks up the starch grains and it should give a nearly transparent starch solution.

Starch solution, c.c.....	500
Nutrient solution (same as for cellulose agar), c.c.....	500
Agar; grams.....	10

Cellulose Agar (MCBETH and SCALES: Bull. 266, Bureau of Plant Industry, p. 27).—Prepare a liter of dilute ammonium hydroxide solution by adding 3 parts of water to 10 parts of ammonium hydroxide, sp. gr. 0.90. Add a slight excess of copper carbonate and shake, allow to stand over night and then siphon off the supernatant solution. Add 10 grams of unwashed sheet filter paper and shake occasionally until the paper is dissolved. Dilute to 10 liters and add slowly a 1 to 5 solution of HCl, with vigorous shaking until the precipitation of the cellulose is complete. Dilute to 20 liters, allow the cellulose to settle and decant the supernatant liquid. Wash by repeated changes of water, adding HCl each time until the copper color disappears; then wash with water alone until the solution is free from chlorine. Allow it to settle several days and decant off as much of the clear solution as possible. If the percentage of cellulose is still too low, a portion of the solution is centrifugized to bring the cellulose content up to 1 per cent.

Cellulose solution, c.c.....	500
Agar, grams.....	10
Nutrient solution, as follows:	
Potassium phosphate (dibasic), gram.....	1
Magnesium sulphate, gram.....	1
Sodium chloride, gram.....	1
Ammonium sulphate, grams.....	2
Calcium carbonate, grams.....	2
Tap water, c.c.....	1000

Chestnut Twig Agar.—To 275 grams of one- or two-year-old chestnut branches add 500 c.c. of distilled water and boil over an open flame for one-half hour. Filter the juice and make up to 550 c.c. with distilled water. To 50 parts of this infusion add 100 parts of distilled water and 2 per cent. of agar flour. Steam for one-half hour, filter, tube and autoclave for fifteen minutes at 115°C.

LESSON 17

Culture Medium.—Winogradsky employed for culturing upon solid media a mineral gelatin. A solution of from 3 to 4 per cent. of silicic acid in distilled water is placed in flasks. By addition of the following salts to such a solution gelatinization occurs.

(a)	Ammonium sulphate, gram.....	0.4
	Magnesium sulphate, gram.....	0.05
	Calcic chloride.....	a trace
(b)	Potassium phosphate, gram.....	0.1
	Sodium carbonate, gram.....	0.6, 0.9
	Distilled water, c.c.....	100.0

The sulphates and chloride are mixed in 50 c.c. of distilled water, and the latter substance in the remaining 50 c.c. in separate flasks. After sterilizing and cooling these are all mixed and added in small quantities to the silicic acid. Upon this medium, it is possible to subculture a pure growth from the film at the bottom of the flasks in which the nitrous organism is first isolated (*cf.* NEWMAN, GEORGE: *Bacteria*, pp. 154-157).

Isolation of the Nitric Organisms.—Nitrobacter develops freely in solutions to which no organic matter has been added; indeed, much organic matter will prevent its growth. Winogradsky used the following medium to isolate it:

Water, c.c.....	1000.0
Potassium phosphate, gram.....	1.0
Magnesium sulphate, gram.....	0.5
Calcium chloride.....	a trace
Sodium chloride, grams.....	2.0

About 20 c.c. of this solution is placed in a flat-bottom flask and a little freshly washed magnesium carbonate is added. The flask is closed with cotton-wool, and

the whole is sterilized. To each flask 2 c.c. of a 2 per cent. solution of ammonium sulphate is subsequently added. The temperature for incubation is 30°C (Fig. 216). This organism can be successfully grown on silicate jelly. As silicate jelly is difficult to make it is optional for the students to attempt its manufacture. For reference the method is given.¹

*Pot Experiments with Nitrogen Fixation.*²—Since the experiments of Hellriegel and Wilfarth and other experimenters, it has been known that certain bacteria

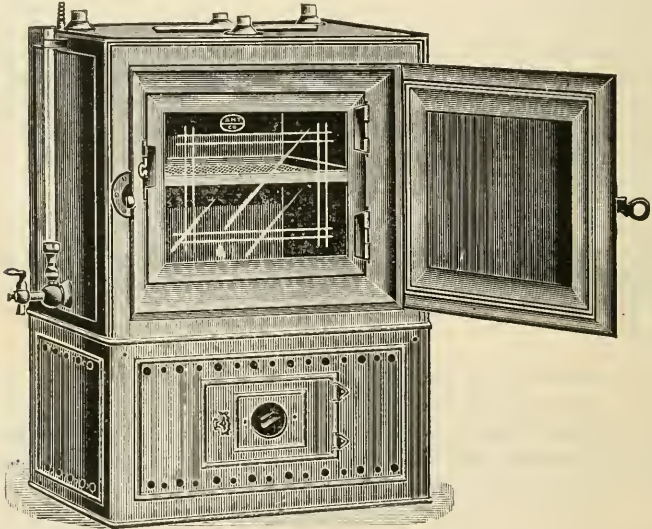

FIG. 216.—Double-walled copper incubator constructed with non-conducting materials, with water gauge and openings for insertion of thermometer and thermostat. Padded outer door of copper, inner door of glass. (Fig. 22, p. 46, *Schneider, Pharmaceutical Bacteriology*, 1912.)

(*Bacillus radicola*, etc.) have the power of fixing free atmospheric nitrogen, when they enter the roots of leguminous plants with the formation of root nodules. The formation of these nodules can be followed in a series of experiments.

¹ It is optional of course for the teacher to omit these rather difficult exercises entirely. If followed by the student or class, a useful work to consult in connection with LESSON 17 is SMITH, ERWIN F.: *Bacteria in Relation to Plant Diseases*, I : 36-39.

² An important paper on the culture and isolation of *Bacillus radicola* is by HARRISON, F. C. and BARLOW, B.: *The Nodule Organism of the Leguminosæ—Its Isolation, Cultivation and Commercial Application*. *Centralblatt für Bakteriologie, Parasitenkunde und Infektionskrankheiten*, 19, Abt. 2, 1907: 264-272, 426-440, pls. 9. Consult for other details LIPMAN, J. G. and Brown, P. E.: *A Laboratory Guide in Soil Bacteriology*, 1911.

Take three pots *A*, *B*, *C*, which have been thoroughly sterilized by dry heat in a sterilizing oven. Place in pot *A* ordinary rich garden soil. Fill pot *B* and *C* with sand and thoroughly sterilize both pot and sand with dry heat. Plant in pots, *A*, *B* and *C* seeds of pea, bean, clover or those of other leguminous plants and water pots *A*, and *B* only with distilled water previously carefully sterilized. Pot *C* with sand, is watered with distilled water which has been allowed to percolate through rich garden earth and which removes the bacterial life which such rich soil contains. Pot *C* watered with such water, therefore, becomes microbe-seeded. After the first watering, all subsequent applications of water should be made with thoroughly sterilized distilled water.

Note daily the growth of the plants in each of the pots and explain the difference in the rate and character of the growth, if any.

In order to be able to study microscopically the entrance of the organisms from the soil into the root of the leguminous plants a larger series of pots should be used than three. By doing this successive stages in the development of the nodules can be obtained and made ready for microscopic study by the paraffin method described in a subsequent lesson (Page 656).

LESSON 18

Standardization of Culture Media (F. D. Heald).—Bacteria and fungi are influenced in their development by the degree of acidity or alkalinity of the medium in which they are growing. Since this is true, it is important to employ media of known reaction. In order to secure results which may be compared, the adoption of a uniform method of standardization is necessary and the reaction of a culture medium should be indicated always when cultural or morphologic characters are described. The standardization of culture media requires the following solutions:

$\frac{N}{NaOH}$ = a normal solution of sodium hydroxide.

$\frac{N}{20} NaOH$ = twentieth normal solution of sodium hydroxide.

$\frac{N}{HCl}$ = normal hydrochloric acid.

The $\frac{N}{20} NaOH$ is used for the titration of culture media and the $\frac{N}{NaOH}$ for their

neutralization. $\frac{N}{HCl}$ is used for acidifying media. A normal solution contains 1 gram of basic H, or the equivalent to each 1000 c.c. Since the above normal solutions are required in every pathologic laboratory, directions are here given for their preparation.

Preparation of Normal Solutions.—Normal solutions of NaOH or HCl cannot be made by weighing. NaOH readily absorbs CO₂ and water from the air and so cannot be weighed accurately enough for making standard solutions. HCl is liquid and of varying strength. It is necessary, then, to start with an acid or alkali that is in solid crystalline form and is not altered on exposure to the air. Oxalic acid presents the requisite characteristics.

$\frac{N}{10}$ Oxalic Acid Solution.—Weigh out exactly 6.3 grams of chemically pure oxalic acid ($H_2C_2O_4$ plus $2H_2O$) and add distilled water in 1000-c.c. volumetric flask. After the crystals of acid have dissolved, dilute the solution until it measures exactly 1000 c.c.

$\frac{N}{NaOH}$ or Normal Sodium Hydroxide.—This solution should contain 40 grams of NaOH in 1 liter. It can be made by titrating against the standard oxalic solution already prepared. Weigh out 90 grams of NaOH and dissolve in 2 liters of distilled water. This solution is now too strong and the amount necessary to dilute it must be determined. Place exactly 50 c.c. of the $\frac{N}{10}$ oxalic acid in a beaker and add a few drops of phenolphthalein solution to serve as an indicator and then add to this drop by drop from a burette some of the NaOH solution, stirring with a glass rod and continue until the solution is turned a faint, but permanent pink color. Read off from the burette the amount of NaOH solution used to neutralize 50 c.c. of $\frac{N}{10}$ oxalic acid, which contained as much acid as 5 c.c. of normal acid. Now calculate the amount of dilution necessary. Supposing 4.5 c.c. of NaOH be the amount used and 1950 c.c. the amount of NaOH to be diluted, the proportion would be as follows: $4.5 : 5 :: 1950 : x$ where $x = 2167$, and this means that 2167 c.c. of water must be used. After the dilution, repeat the titration and adjust if necessary.

$\frac{N}{HCl}$ or Normal Hydrochloric Acid.—This may be prepared by making an acid solution which is a little over strength, and determining the amount of dilution necessary by titrating with the $\frac{N}{NaOH}$ 1 c.c. of $\frac{N}{NaOH}$ should exactly neutralize 1 c.c. of $\frac{N}{HCl}$.

Expressing the Reaction of Media.—Fuller's scale has been generally adopted for expressing the reaction of culture media. The plus sign (+) indicates that the medium is acid to phenolphthalein, while the minus sign (-) indicates that the medium is alkaline to phenolphthalein, the figure following the sign indicating the degree of acidity, or alkalinity. For example, a +10 medium contains 10 c.c. of $\frac{N}{HCl}$

for 1000 c.c. beyond the neutral point for phenolphthalein paper. A -10 medium is alkaline and would require 10 c.c. of $\frac{N}{HCl}$ for 1000 c.c. to bring it back to the neutral point. Media may then have the reaction +5, +10, +15, etc., or -5, -10, -15, etc. The neutral point for litmus is not the same as the neutral point for phenolphthalein and this fact should be kept in mind when working with culture media.

25 of Fuller's scale gives approximately the neutral point for litmus, so that any medium with a reaction less than +25 is still alkaline to litmus.

The Optimum Reaction.—For every organism there is a definite optimum reaction. It lies near +5 for most animal pathogens, about +10 to +15 for most water and

putrefactive bacteria and +10 to +25 or even higher for fungi. There are some bacterial organisms which prefer distinctly alkaline media (Fuller's scale), while others prefer acid media. A good general practice to follow in the preparation of the basic culture media to be kept in stock is to standardize to +10 of Fuller's scale and vary the reaction according to the preference of the organisms under cultivation. When other acids than HCl are used for acidifying the media, the kind should be definitely specified, when the reaction is expressed.

Titration of Media.—In outlining the method of preparation of bouillon for routine work, directions were given for neutralization of the medium and the addition of the requisite amount of acid. In accurate work, or in the prosecution of research, a more careful method of standardization is employed. The medium should be neutralized by the titration method. The process is as follows:

1. Add exactly 5 c.c. of the medium to 45 c.c. of distilled water in an evaporating dish (use a 5-c.c. Mohr pipette), boil for three minutes to drive off the CO_2 and add 1 c.c. of phenolphthalein solution.

2. Add $\frac{N}{20}$ NaOH drop by drop from a burette, stirring constantly until the solution turns a faint, but permanent pink. Repeat the titration for two more 5-c.c. samples, and determine the average of the three readings.

3. Calculate the amount of $\frac{N}{\text{NaOH}}$ necessary to neutralize the medium (10 to 15 c.c.), add the amount determined to the medium, test reaction and if neutral, proceed with preparation of the medium; if not, repeat the titration on neutralization.

LESSON 19

Germination Studies.—The examination of spore germination of various fungi can be studied best by the hanging-drop method. Take a hanging-drop slide and sterilize thoroughly in the hot-air oven at 110°C . after it has been wrapped in a crepe napkin or piece of tissue paper. After sterilization plunge it into a beaker of absolute alcohol (or such sterilized slides may be kept in stock in absolute alcohol) and then drain off the greater part of the spirit, grasping the slide in a pair of sterile forceps. Burn off the remainder of the alcohol in the flames.

Place the hanging-drop slide on a piece of blotting paper moistened with a 2 per cent. lysol solution and cover it with a small bell glass that has been rinsed with the same solution and not dried.

Raise the bell glass slightly and smear sterile vaseline around the rim of the cell by means of a sterile spatula of stout platinum wire. Remove a clean cover-slip from the alcohol pot with sterile forceps and burn off the alcohol; again raise the bell glass and place the sterile cover-slip on the blotting paper by the side of the hanging-drop slide.

Remove a drop of the culture medium selected for use (see below) and place the drop on the center of the cover-slip. Sterilize the loop.

Raise the bell glass sufficiently to allow of the cover-slip being grasped with the sterile forceps, invert it and place over the cell of the hanging-drop slide. Remove the bell glass altogether and press the cover-slip firmly on the cell.

Germination on Solid Media.—Observing precisely similar technique a few drops of liquefied gelatine or agar may be run over the surface of the cover-slip and a hanging-drop plate cultivation thereby prepared. After sealing down the preparation it may be set aside and the growth watched at definite intervals under the microscope.

Dilution Method to Obtain Material for Inoculating Hanging-drop Media.—In the case of yeast this problem was solved by Hansen, who developed the method to such a degree of perfection as to create, in fact, an exact method (1881). He employed dilution with water. The yeast developed in the flask is diluted with an arbitrary amount of sterilized water, and after vigorous shaking, the number of cells in a small drop of liquid is determined. The counting, in this case, is effected in a very simple manner by transferring a drop to a cover-glass, in the center of which some small squares are engraved and this is then connected with a moist chamber; the drop must not be allowed to extend beyond the limits of the square. The cells present in the drop are then counted. Suppose, for instance, that ten cells are found: a drop of similar size is transferred from the liquid, which must first be shaken vigorously, to a flask containing a known volume of water, e.g. 20 c.c. of sterilized water. This flask, then, will in all likelihood contain about ten cells. If it is then vigorously shaken for some time until the cells are equally distributed in the water, and then 1 c.c. of the liquid introduced into each of twenty flasks containing nutritive liquid, it is probable that half of these twenty flasks have received one cell each. But, here again, as in Lister's experiments, it is entirely a calculation of probabilities. If the flasks are allowed to stand for further development of micro-organisms, there will be a chance of getting a pure culture in some of them. Hansen succeeded, however, in adding a new factor, which first gave certainty to this experiment. Thus, if the freshly inoculated flasks are vigorously shaken, and then left in repose, the individual cells will sink to the bottom and be deposited on the walls of the flask. It is self-evident that if a flask contains, for instance, three cells, these cells will always, or at least in the great majority of cases, be deposited in three distinct places on the bottom. After some days, if the flask is raised carefully, it will be observed that one or more white specks have formed on the bottom of the flask. If only one such speck be found, we have a pure culture by the dilution method.

Method of Preparing Squared Cover-glasses.—Since such cover-glasses are somewhat expensive and can be easily etched, the method of their preparation is described below. A little paraffin or wax is melted in a saucer and the cover-glass dipped into it, being held at one corner by a forceps; it is taken out quickly and as much as possible of the melted paraffin is allowed to run off, leaving on either side a thin cover of paraffin which is allowed to harden. By a very fine needle and a small ruler the required lines are then scratched on the wax, and the cover-glass immersed for a moment in hydrofluoric acid which should be poured into a platinum crucible or dish. The paraffin can now be dissolved off in xylol, leaving the surface etched with the squares used in making bacterial, or fungous spore counts (Fig. 217).

These squared covers may be raised above the slide, while the count is being made, either on four pillars of paraffin, or in a moist chamber.

LESSON 20

Counting of Yeast Cells, Fungous Spores and Bacteria.—In many cases the cells are in a liquid which is inclined to form froth when shaken, hence the liquid can be treated with dilute sulphuric acid (1 part concentrated sulphuric acid and 10 parts water). This prevents aggregations of the cells and also furnishes in addition a liquid in which cells do not sink to the bottom too quickly, an important point, when single drops are taken out for counting purposes.

In counting, the counting chamber is employed. Thoma's hæmatimeter consists of a glass slip on which a cover-glass is fastened which has a circular hole in the

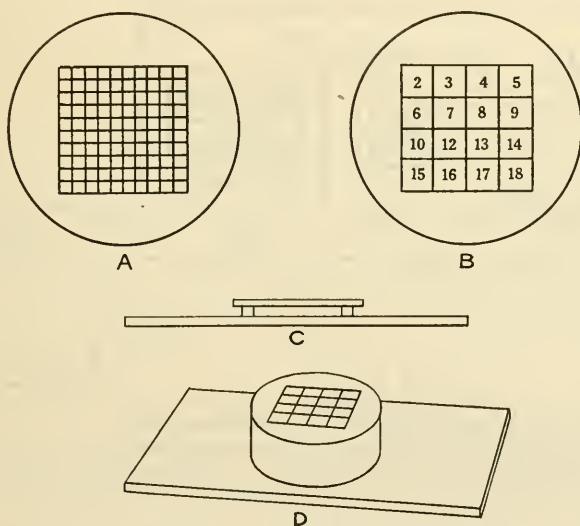

FIG. 217.—A, Squared cover glass used in counting; B, Jorgensen's squared cover glass; C, moist chamber, sectional view; D, moist chamber with Jorgensen's squared cover. (A and B, after Klocker; C, original; D, after Jorgensen.)

middle and is 0.2 mm. thick (Fig. 218). A circular cover-glass, 0.1 mm. thick, is fitted centrally in this hole and is also fastened to the glass slip; thus an annular space is formed. In the middle of the cover-slip two sets of twenty-one parallel lines are etched which cut each other at right angles; there are thus formed a large square with a side of 1 mm. and small squares with a side of 0.05 mm. The drop of liquid taken up by a pipette is examined on this square and enclosed by the cover-glass, the depth of the liquid layer thus formed amounting to 0.1 mm. (Fig. 218).

Thoma's Hæmatimeter.—After the test-tube with the average sample and the H_2SO_4 has been subjected to a prolonged and vigorous shaking, a sample is taken out and examined as above.

As soon as the cover-glass has been put into position the chamber is laid under the microscope, and if a hæmatimeter is being used as a counting chamber the "net eyepiece" is required. It is not advisable to use a greater magnification than is necessary. After waiting a short time, the counting is proceeded with when all the cells in the preparation have sunk to the bottom. The "net eyepiece" consists of a large square divided into sixteen or twenty-five smaller squares, the latter being used as aids in counting. The cells inside the large square are counted; it does not matter how the cells lying on the side lines of the square are counted, if the same rule is always followed. Many squares in each hæmatimeter may be counted by displacing the hæmatimeter. It is to be recommended always to count a certain

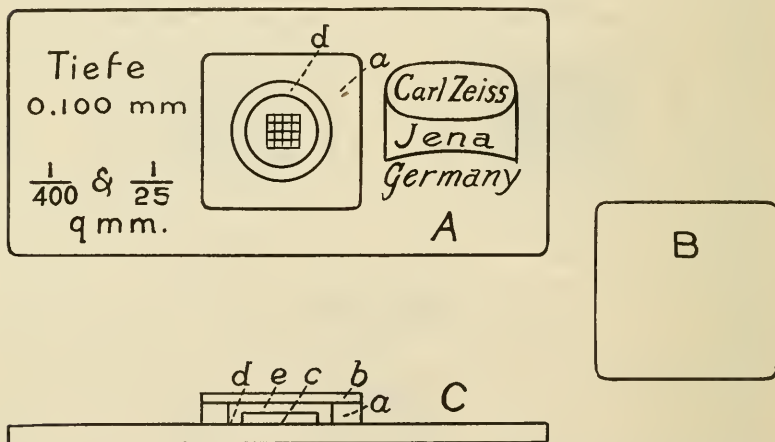

FIG. 218.—Details of Thoma's hæmatimeter. A, Surface view of thick glass slide with chamber and ruled center; B, cover glass; C, sectional view.

number of squares, e.g. ten—two in the middle and eight along the edge of the drop. As soon as these ten countings are performed, the hæmatimeter is well cleaned and dried, the second test-tube well shaken and then a drop taken from it and counted in the same manner. This alternation is repeated until a constant average is obtained.

When it is not necessary to determine the number of cells in a given volume, the same unit of volume is always employed, viz., that of a column of liquid of which the base is the large square of the "net eyepiece" for the particular magnification employed, the height being the thickness of the perforated cover-glass.

For example, 3 cc. of beerwort with yeast cells and 1 c.c. of sulphuric acid give the following results.

SAMPLE I

Square	First drop	Second drop	Third drop	Fourth drop
1	23	10	28	13
2	22	20	20	24
3	19	28	19	21
4	10	19	22	14
5	14	24	32	18
6	27	26	25	20
7	20	14	21	19
8	18	25	13	34
9	12	20	17	23
10	27	14	20	16
Average.....	19.2	20.0	21.7	20.2

Cells in each large square

Calculation of Counts.—As these four averages are nearly the same, it is not necessary to count more drops. The mean of the four averages is $\frac{81.1}{4} = 20.275$ cells per unit of volume. But since the wort was diluted with H_2SO_4 (4 parts of the mixture contains 3 parts of wort with cells) the actual number of cells in the volume in question is $\frac{20.275 \times 4}{3} = 27$ cells.

Detailed Description of Thoma's Hæmatimeter (Figs. 218 and 218A).—Thoma's hæmatimeter (Zeiss form) is used also for counting microorganisms. *A* is a glass slide on which a cover-glass (*a*) is fastened which has a circular hole in the middle and is 0.2 mm. thick. A circular cover-glass (*c*), 0.1 mm. thick is fitted centrally in this hole and is also fastened to the glass slide; thus an annular space (*d*) is formed. In the middle of (*c*) two sets of parallel lines are etched which cut each other at right angles. There are thus formed a large square with a side of 1 mm., and small square with a side of 0.005 mm. The drop of liquid to be examined is placed on this square and enclosed by the cover-glass (*b*), the depth of the liquid layer (*e*) thus formed amounting to 0.01 mm. *B* gives a vertical section of the chamber.

If the actual number of cells in a certain volume is to be calculated, the size of the space unit must be determined. It is then necessary to know the height of the column of liquid, *i.e.*, the thickness of the perforated cover-glass. The hæmatimeter designed by Hayem and Nachet has one with a thickness of 0.2 mm., but that in the Zeiss hæmatimeter is usually 0.1 mm. The value of the square in the "net" for the magnification used must further be known, or squared cover-glasses are used of which the size of the squares is known. In Thoma's chamber the column of liquid is 0.1 mm. high and the large square etched on the bottom of the chamber contains 1 sq. mm. The volume of the liquid prism, of which the base is the large square, is thus 0.1 cu. mm.

When it is intended to sow a definite number of cells,¹ water is usually added to the yeast to be used as sowing material, the cells being thus more easily separated from one another on shaking; also, no appreciable increase of the cells takes place, especially if the flask is subjected to a low temperature after the sample has been withdrawn.

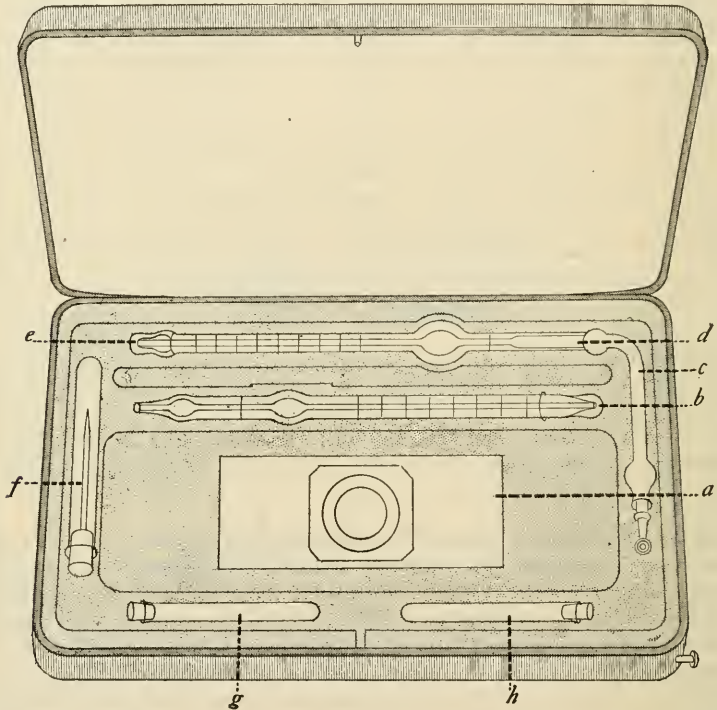

FIG. 218A.—Blood counter case. *a*, Slide with counting chamber; *b*, rubber cork covering tip of white pipette; *c*, soft rubber tubing; *d*, red pipette provided with rubber cork; *e*, cutting needle in 95 per cent. alcohol; *g*, Hayem's solution; *h*, .5 per cent. acetic acid. (After *McJunkin*.)

The yeast is, therefore, shaken up vigorously and continuously with sterile water, and an average sample removed. There are three different cases to be considered now, viz.: (1) When we wish to know only how many cells are present in a certain portion of the water-yeast mixture; (2) when it is intended to inoculate a previously determined number of cells into the liquid to be dealt with; and (3) when it is desired to sow so many cells, that after the seeding the definite number of cells desired may be present in an arbitrary space unit, *e.g.*, when making comparisons of the multiply-

¹ KLÖCKER, ALB.: *Fermentation Organisms*, 1903.

ing powers of two species. In the first two cases, it is required to determine the actual number of cells which are to be seeded, and no attention is paid to the quantity of liquid inoculated; in the last case, it is required only to know the relative number of cells, but regard must be had to the quantity of liquid seeded. Finally, the following must be remembered: If there is to be a definite volume in the flask after seeding, then, in the case where the seeding is not to be made in water, or where the concentration of the liquid is of some account, no water must be used in shaking up the yeast. In this case the same culture liquid must be employed. The same quantity of culture liquid is then removed from the flask before seeding, as will be added when seeding takes place.

The procedure in the above three cases is as follows: (1) After shaking, a drop of the water is placed in the hæmatimeter, or in the Thoma chamber, and the number of cells is determined in the usual manner. On seeding a measured portion of the water mixture is taken, and we thus know how many cells have been sown.

2. As above. In counting we learn, for example, that a cells are present in a certain volume. It is here necessary to know the quantity of culture liquid in the flask to be inoculated; assume the amount to be p c.c. If it is desired to seed so many cells that there will be a_1 cells per unit of volume, the number of cubic centimeters x of the water-yeast mixture, which must be added in order to arrive at this, is found from the following equation: $\frac{a}{a_1} = \frac{p+x}{x}$, or the number of cells in the water mixture (the seeding liquid) has the same proportion to the cells after seeding as the whole amount of liquid after seeding has to the amount of seeding liquid. The quantity of liquid in the flask after seeding has taken place is thus $p+x$.

From the given equation, $x = \frac{a_1 p}{a - a_1}$. Example: It is found that the seeding liquid contains 75 cells per unit of volume and the flask to be infected contains 70 c.c. of wort, and it is further desired to have 5 cells per unit of volume after inoculation. Accordingly, $x = \frac{5 \times 70}{75 - 5} = 5$ c.c. to be withdrawn from the seeding liquid. The result may be checked by another counting after seeding. If the result is incorrect, either more liquid or more cells must be added. But in exact work this contingency does not arise.

Suppose it is wished to sow a_1 cells of a yeast species A , and b_1 cells of a species B in a flask containing p c.c. of culture liquid, from two seeding liquids containing a and b cells per unit of volume respectively. The number of cubic centimeters x and y , to be sown from A and B respectively, is found from the following equations.

$$\frac{a}{a_1} = \frac{p+x+y}{x} \text{ and } \frac{b}{b_1} = \frac{p+x+y}{y}$$

the quantity of liquid after infection being $p+x+y$; from this we find:

$$x = \frac{a_1 b p}{ab - a_1 b - a_1 b_1} \text{ and } y = \frac{a b_1 p}{ab - a_1 b - a_1 b_1}$$

Combinations of the above three cases may of course occur but from the explanations given here it will not be difficult to solve them.

LESSON 21

Cultivation of Yeasts on Gypsum Blocks.—Spore Cultivation.—Blocks of gypsum are used generally for the cultivation of the spores of the yeasts. The block is in the form of a truncated cone, and the cover of the vessel fits quite loosely. The dishes used in the Carlsberg laboratory are the so-called bird troughs (Vogelnäpfe).

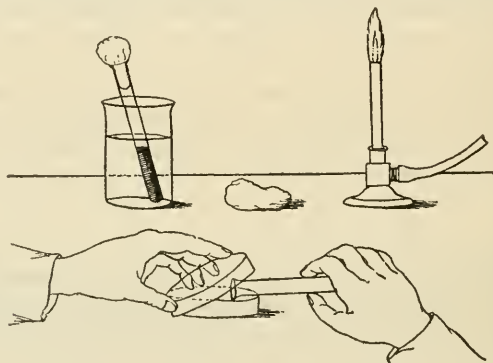

FIG. 219.—Method of pouring gelatin into Petri dishes. (After Löhnis.)

A suitable size for these, taking outside measurements, is as follows: height 4.5 to 5 cm.; diameter of the bottom about 7 cm. The gypsum block is 3 cm. high; the diameter of the lower surface is 5.3 cm., that of the upper surface 3.8 cm. To make a gypsum block, 2 parts of powdered gypsum are mixed with $\frac{3}{4}$ part of water and the mixture poured into a tin mould. The block should be hard, and the mould must not be rubbed with fat, oil or such material. A culture on a gypsum block in such

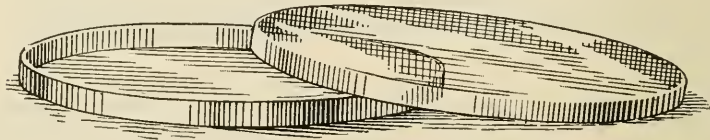

FIG. 220.—Petri dish. (After Williams in Schneider, *Pharmaceutical Bacteriology*, p. 59.)

a vessel cannot, as a rule, be kept free from bacterial infection, for the cover must not be closed down tightly, but should allow free access of the air. The dishes with gypsum blocks are sterilized for one to one and a half hours at 110° to 115°C. , the dishes first being wrapped in a crepe napkin or in filter paper. The gypsum blocks are sterilized in a moist condition before planting the yeast on their upper surface. The gypsum blocks can be used several times.

Method of Pouring Plates (Fig. 219).—Place three sterile Petri dishes (Fig. 220)

in a row after previously sterilizing them wrapped in a crepe napkin in the hot-air oven.

Take three sterile test tubes numbered 1, 2 and 3 and fill with the liquefied nutrient to be used. Plug each tube with cotton and flame the plugs, which should be removed readily from the mouths of the tubes.

Add one loopful of inoculum to tube No. 1. After replugging, rotate the tube between the palms of the hands with an even circular movement to diffuse the inoculum throughout the medium; avoid jerky movements as these cause bubbles of air to form in the medium.

Sterilize the platinum loop and add two loopfuls of diluted inoculum to tube No. 2 and mix as before. In a similar manner transfer three loopfuls of liquefied medium from tube No. 2 to tube No. 3 and mix thoroughly.

Flame the plug of tube No. 1, remove it, then flame the lips of the tube; slightly raise the cover of Petri dish No. 1, introduce the mouth of the tube; then elevate the bottom of the tube, pour the liquefied medium into the Petri dish to form a thin layer. Remove the mouth of the tube and close the "plate." If the medium has failed to flow evenly over the bottom of the plate, raise the plate and tilt it to rectify the fault.

Pour plates No. 2 and No. 3 in a similar manner from tubes Nos. 2 and 3. Label the plates with the distinctive name or number of the inoculum, the number of the dilution, also the date.

In this way colonies may be obtained quite pure and separate from each other. They may be described as such, and may then be transferred as pure cultures to other media in other test-tubes.

In plate No. 1 probably the colonies will be so numerous and crowded, and therefore so small, as to render it useless. In plate No. 2 they will be more widely separated, but usually No. 3 is the plate reserved for careful examination, as in this the colonies are usually widely separated, few in number and large in size.

Agar plates are poured in a similar manner, but the agar must be melted in boiling water and then allowed to cool to 42°C. or 45°C. in a carefully regulated water bath before being inoculated and the entire process must be carried out very rapidly otherwise the agar will have solidified before the operation is completed. After the agar has hardened it is incubated at 37°C. and the plates are inverted as this prevents flooding of the agar surface by the squeezing out of the water of condensation as the agar hardens. Gelatin plates are not inverted.

Streak Method.—The isolation of pure cultures of organisms by the streak method differs from the plate method in that the medium (gelatin, agar, blood serum) is not inoculated in the fluid state but the necessary dilution to secure isolated colonies is secured by drawing a glass rod with its end bent into a triangle, as recommended by Bergey, several times across the surface of the sterile medium in Petri dishes by lifting the cover while so doing. The  glass rod has been previously infected with the material to be studied qualitatively. It is preferable, according to Bergey, to place a small quantity of the mixed culture in the center of the first plate of a series, and thence distribute the material over three or more plates in succession with the glass spreader. Eventually a degree of dilution is reached where distinct colonies are in evidence.

LESSON 22

Isolation of a Leaf Wilt Fungus in Pure Culture.—Given a fungus causing leaf wilt, to obtain a pure culture by excluding the non-pathogenic forms.

1. Look for the fruiting stage of the suspected fungus, or fungi. Transfer some of the spores with a sterile needle into a tube of 5 c.c. of sterile water. (If pycnidia or perithecia are present, transfer a whole pycnidium or perithecium into sterile water, and crush the fruit body to cause the escape of the spores). Then with a sterile needle transfer some of the water with the spores into a tube of agar-agar which is made liquid by putting in a vessel of hot water and then allowed to cool. This tube is marked *A*. Then from tube *A* transfer a drop of agar with a sterile needle to another similar test-tube with liquid agar designated as *B* (Fig. 221). Then perform the same sort of transfer to a third tube *C*. Distilled water or nutrient bouillon can be used for these dilutions instead of agar.

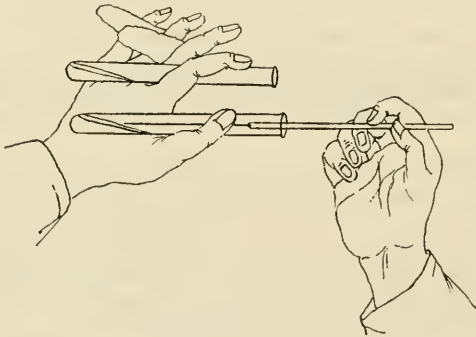

FIG. 221.

FIG. 221.—Method of holding test-tubes in transfer of fungi from one test-tube to another. (After Löhnis.)

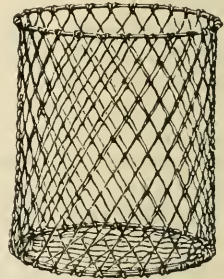

FIG. 222.

FIG. 222.—Cylindric form of wire basket for holding test-tubes during sterilization and other operations. (After Schneider, *Pharmaceutical Bacteriology*, p. 37.)

A, *B* and *C* are thoroughly shaken and each is transferred to Petri dishes marked *A*, *B* and *C*. If water is used to dilute, or bouillon, it must be mixed with the material poured into the Petri dishes. These are observed for any growth that may take place on the surface of the agar-agar. Transfers are made from the single colonies into agar slants in test-tubes.

If no spore forms are present, cut out pieces of the affected leaf and place in a tube containing 1 per cent. mercuric chloride diluted in equal amounts in 50 per cent. alcohol. Shake the tube so that the material is bathed in the disinfectant. Do this for half a second to two minutes according to the thickness of the leaf. Pour off the disinfectant and wash the material three times in sterile water, care being taken to keep out foreign infection. Then with a sterile forceps, take each piece of the material and crush it thoroughly at the mouth of a tube containing melted

and cooled agar. When the material is crushed, it is well shaken up with agar and the whole poured into a Petri dish. If the growth of one fungus appears, it means that we have the parasite in captivity, or pure culture. If more than one fungus is obtained, they must all be transferred separately into agar slants in test-tubes and tested by inoculation for their pathogenicity. The true pathogen is of course the one which will reproduce all of the symptoms of the disease.

Note.—To keep out bacterial infection put one drop of a 5 per cent. lactic acid in each of the agar tubes used in making the cultures.

DIFFERENTIAL METHODS OF ISOLATION

Pasteurization and Sterilization.—In order to compare the effect of these two operations on organic material, take some milk and pasteurize part of it and sterilize the other part by one sterilization. Conduct both operations in previously sterilized flasks plugged with cotton after the milk is introduced (Fig. 223).

Milk is pasteurized by heating it up to a temperature of 85°C. followed by a rapid cooling. Milk is sterilized by heating up to 100°C. for five minutes. Set the flasks aside and compare. Note any changes that may take place.

Differential Media.—(a) Selective.—Some media are specially suitable for certain species of bacteria and enable them to overgrow and finally choke out other varieties.

(b) Deterrent.—The converse of the above also. Certain media possess the power of inhibiting the growth of a greater or less number of species. For instance, media containing carbolic acid to the amount of 1 per cent. will inhibit the growth of practically everything but the *Bacillus coli communis*.

Differential Sterilization.—(a) Non-sporing Bacteria.—Similarly, advantage may be taken of the varying thermal death points of bacteria. From a mixture of two organisms whose thermal death points differ by, say, 4°C.—e.g., *Bacillus pyocyaneus*, thermal death point 55°C., and *Bacillus mesentericus vulgatus*, thermal death point 60°C.—a pure cultivation of the latter may be obtained by heating the mixture in a water bath to 58°C. and keeping it at that point for ten minutes. The mixture is then planted on to fresh media and incubated, when the resulting growth will be found to consist entirely of *B. mesentericus*.

(b) Sporing Bacteria.—This method is found to be of even greater practical value when applied to the differentiation of a spore-bearing organism from one which does not form spores. In this case the mixture is heated in a water bath at 80°C. for fifteen to twenty minutes. At the end of this time the non-sporing bacteria are dead, and cultivations made from the mixture will yield only a growth resulting from the germination of the spores only.

DIFFERENTIAL ATMOSPHERE CULTIVATION

Aerobic and Anaerobic.—For the separation of bacteria, it is possible to draw the line between those that need oxygen for growth (aerobic) and those that will grow without oxygen (anaerobic). By excluding oxygen, anaerobic forms alone develop.

Inoculation into various animals or plants may be used as a means of separation.

LESSON 23

Water Analysis.

I. Collect water from tap in a sterile Erlenmeyer flask, allowing H₂O to run for ten minutes before collecting.

II. Melt two tubes of gelatin at 42°C.

III. Add to tube No. A 0.1 c.c. and tube No. 2 0.2 c.c. from the flask. Shake to mix H₂O with gelatin.

IV. Pour in Petri dishes No. A and B and place in locker.

V. Count colonies which develop at end of twenty-four and forty-eight hours.

VI. Estimate the number of colonies which would have developed in 1 c.c. of water.

Example.

Twenty-four hours

50 colonies have developed on plate No. A— $50 \times 10 = 500$ in 1 c.c.

96 colonies have developed on plate No. B— $96 \times 5 = 480$ in 1 c.c.

$$2 \overline{)980}$$

490 in 1 c.c.

Forty-eight hours

62 colonies have developed on plate No. A— $62 \times 10 = 620$ in 1 c.c.

102 colonies have developed on plate No. B— $102 \times 5 = 510$ in 1 c.c.

$$2 \overline{)1130}$$

565 in 1 c.c.

LESSON 24

METHODS OF IDENTIFICATION

Descriptive Terms.—For complete details consult EYRE, J. W. H.: *The Elements of Bacteriological Technique*, 1902: 208.

TYPES OF COLONIES

A. Size.—The size of the cells and the spores at various ages.

B. Shape.—Punctiform, round, elliptic, irregular, fusiform, cochleate, amœboid, mycelioid, filamentous, floccose, rhizoid, conglomerate, toruloid, rosulate.

C. Surface Elevation.—Flat, convex, capitate, umbonate, effused, pulvinate, umbilicate, raised.

D. Character of Surface.—Smooth, alveolate, punctate, bullate, vesicular, verrucose, squamose, echinate, papillate, rugose, corrugated, contoured, rimose.

E. Internal Structure of Colony (Microscopic).—Refraction weak, refraction strong, amorphous, hyaline, homogeneous, homochromous, finely granular, coarsely granular.

F. Optic Characters.—Transparent, vitreous, oleaginous, resinous, translucent, porcelaneous, opalescent, nacreous, sebaceous, butyrous, ceraceous, opaque, cretaceous, dull, glistening, fluorescent, iridescent, color of colonies.

G. Edges of Colonies.—Entire, undulate, repand, erose, lobulate, auriculate, lacerate, fimbriate, ciliate.

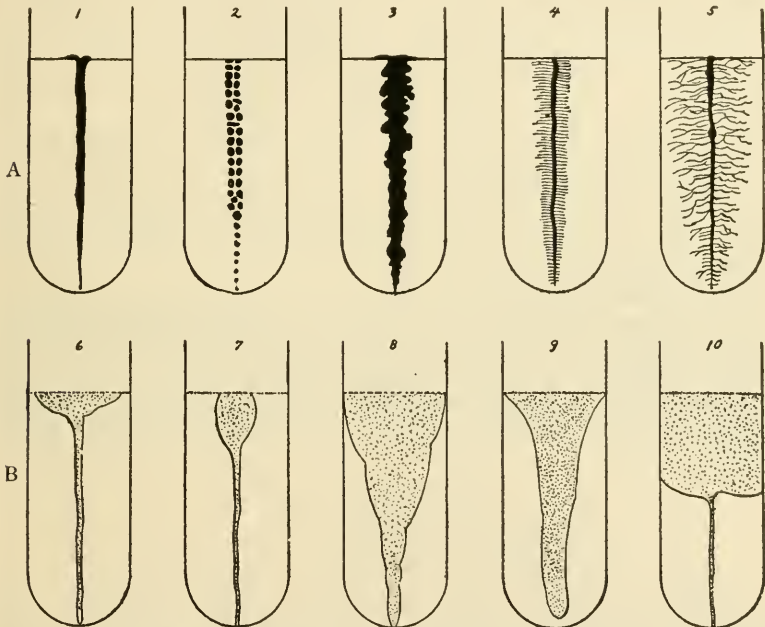

FIG. 223.—Types of growth in stab cultures. *A*, Non-liquefying. 1, Filiform (*Bacillus coli*); 2, beaded (*Streptococcus pyogenes*); 3, echinate (*Bacterium acidilactici*); 4, villous (*Bacterium murisepticum*); 5, arborescent (*Bacillus mycoides*). *B*, Gelatin liquefying. 6, Crateriform (*Bacillus vulgare*, 24 hr.); 7, napiform (*Bacillus subtilis*, 48 hr.); 8, infundibuliform (*Bacillus prodigiosus*); 9, saccate (*Microspira Finkleri*); 10, stratiform (*Pseudomonas flavescens*). (From McFarland after Frost in Schneider, Albert: *Bacteriological Methods in Food and Drug Laboratories*, 1915: 87.)

TYPES OF STAB CULTURES

A. Surface Growth.—Filiform, beaded, echinate villous, arborescent.

B. Character of Liquefied Gelatin.—Pellicle on surface, uniformly turbid, granular, mainly clear but containing flocculi, deposit at apex of liquefied portion, production of gas bubbles.

C. Area of Liquefaction (if present).—Crateriform, saccate, infundibuliform, napiform, fusiform, stratiform (Fig. 223).

LESSON 25

Plate Counter.—The most accurate method of counting the colonies on each of the plates is by means of the counting disk. These disks consist of a piece of paper, upon which is printed a dead black disk, subdivided by concentric circles and radii painted in white. In Jeffer's counter each subdivision has an area of 1 sq. cm.: in Pake's counter, radii divide the circle into sixteen equal sectors, and counting is facilitated by equidistant concentric circles. (For disks see Eyre, p. 322.)

(a) In the final counting of each plate, place the Petri dish over the counting disk, and center it, if possible, making its periphery coincide with one or other of the concentric circles.

(b) By means of a hand lens count the colonies appearing in each sector in turn. Make a note of the number present in each.

(c) If the colonies present are fewer than 500 the entire plate should be counted. If, however, they exceed this number, enumerate one-half, or one-quarter of the plate, or count a sector here and there, and from these figures estimate the number of colonies present on the entire plate.

Jeffer's counting plate¹ (Fig. 224) consists of concentric zones which are divided into small sections, each having an area of 1 sq. cm. To determine the position of the circles marked 10, 20, the position of the circles marked 10, 20, 40, 60, 100 and 140 in the diagram, whose areas equal 10, 20, 40, 60, 100 and 140 sq. cm. respectively, the formula, $\pi r^2 = \text{area}$, was used. In order to show the application of the formula, the radius of the circle whose area is equal to 10 sq. cm., will be found from the formula as follows:

$$\begin{aligned}\pi &= 3.1416. \\ \pi r^2 &= 10 \text{ or } r^2 = 10 \div \pi. \\ 10 \div 3.1416 &= 3.18309 \text{ or } r^2. \\ \sqrt{3.18309} &= 1.78+ \text{ or } r.\end{aligned}$$

1.78 + cm. = the radius of a circle whose area is 10 sq. cm. Dividing the circle into ten equal sectors, each sector has an area equal to 1 sq. cm. By the same method we find the radius of a circle whose area equals 20 sq. cm. thus making each of the ten spaces between circles 10 and 20 and bounded laterally by the ten radii equal to 1 sq. cm. We next construct a circle whose area equals 40 sq. cm. and divide each sector as far as circle 20, making twenty equal areas between circles 20 and 40, each equal to 1 sq. cm. In like manner we construct circles 60, 100 and 140 dividing the sectors in the zone lying between circles 60 and 140 to produce areas equal to 1 sq. cm. each. If a plate whose area is greater than 140 sq. cm. is used, a circle whose area is 180 sq. cm. can be drawn and the radiating lines extended out to the circle (Fig. 224).

The Petri dish can be centered upon this apparatus by the circles and the area read from the line its edges approach. To facilitate the reading of the area of the plate the circles 80 and 120, whose areas are equal to 80 and 120 sq. cm., respectively,

¹ JEFFERS, H. W.: An Apparatus to Facilitate the Counting of Colonies of Bacteria on Circular Plates. Journ. Applied Micros., I: 53-54, March, 1898.

were drawn as dotted circles, thus making the areas marked "a" and "b" equal to 0.5 sq. cm. The colonies in several areas can be counted, an average taken, and the result multiplied by the number of square centimeters in each plate.

A fine apparatus could be made by covering a plate of glass with a uniform layer of wax and with a sharp instrument cut the figure in the wax and subject it to hydrofluoric acid for a few minutes which would etch the glass where exposed. Cleaning

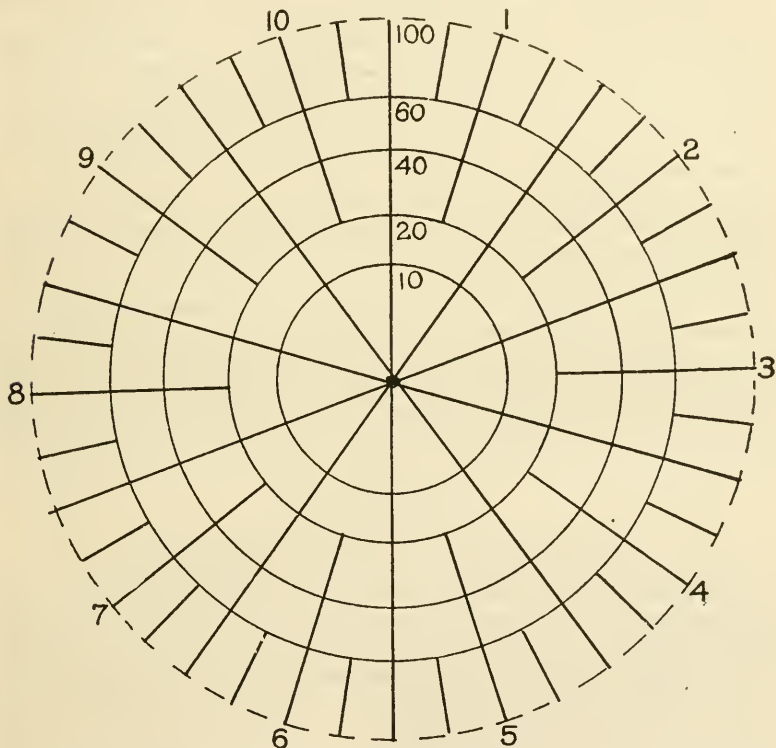

FIG. 224.—Jeffer's circular counting plate for Petri dish cultures. The entire area (100 sq. cm.) is marked off into the equal sectors of ten sq. cm. each. (After Schneider, *Pharmaceutical Bact.* p. 90.)

off the wax and placing the glass plate over black velvet, the colonies could easily be counted.

Neisser's Marking and Counting Apparatus for Bacterial Colonies.—The apparatus is employed for counting bacterial colonies and for marking off their position.

When in use the apparatus is mounted on the lid of the box with which it is supplied, thus the latter serves at the same time as a base.

For this purpose a metal guide plate is screwed on to the inside of the lid, which latter is reversed when the instrument is arranged for use and the marking apparatus is placed on this plate. This apparatus consists of a vertical pillar with square base plate and a metal frame which is vertically adjustable by means of a rack and pinion. The horizontal movement is obtained by moving the entire dish carrier along the guide plate which is screwed on to the box lid.

The Petri dish is secured in the frame by means of two milled heads which are fixed on the right-hand side and at the bottom.

Immediately behind the Petri dish is mounted a glass screen divided into squares, which as a further aid to localization, are subdivided and numbered.

A second pillar is screwed into the lid in front of the dish holder and carries the lens. The lens is vertically adjustable and is threaded for focusing purposes.

Below the lens carrier is fitted a horizontal bar which serves as a hand rest when marking off the colonies.

A special counting screen is provided with fifteen square openings arranged in a V-shape (echelon) by means of which the number of colonies at four places in sixty squares may be determined.

At the upper edge of the counting screen lines are ruled which serve as scales for the Petri dish; the numbers on the one side indicate the diameters in millimeters corresponding to each scale line, while the numbers on the other side indicate how many times the area of the sixty squares is contained in the area of the whole Petri dish. Thus in order to ascertain the total number of colonies in the dish, it is only necessary to count the number of colonies in the sixty squares and to multiply the figure thus obtained by the proportional number required by the diameter of the dish.

LESSON 26

LABORATORY WORK IN SYSTEMATIC BACTERIOLOGY

As it is important for students in mycology to be able to identify the various species of bacteria, which they may meet in their investigation of the fungi, the following suggestions are made as to the systematic study of the forms of bacterial life. Ordinarily, where the other groups of fungi are to be considered, time will not permit a detailed systematic study of the bacteria where cultural methods are required in the identification of the specific forms. Yet much can be done in the classroom with the microscope in the study of the morphology of selected species. The following exercises are presented as suggestions to the teacher and student of mycology.

First Exercise.—The teacher can distribute to each member of the class a selected number of bacteria in culture tubes. Each tube should be numbered, so that the student, after determining the generic character of the different organisms handed to him, can attach the number to his specific determinations, so that the teacher can check off the results of each student's work by the numbered list of species kept for such classroom work. The bacteria from each of the culture tubes should be mounted in balsam after staining with carbol fuchsin, or some other approved stain, and kept for future reference and study.

Second Exercise.—The members of the class can raise material for such morphologic study after the first exercise has been completed by partially filling test-tubes with such materials as chopped hay, prunes, lima beans, split peas, cracked oats and cabbage leaves, adding water, and treating, as follows:

One set of tubes should be plugged and thoroughly sterilized by differential sterilization. This experiment, after examination of the material under the microscope, demonstrates that bacterial growth in the tubes does not take place.

A second set of test-tubes can be left open to the air after the water and the culture material have been completely sterilized. This gives the organisms that come from the air.

A third set of tubes can be partially filled with water, plugged and then sterilized, and after sterilization unsterilized material can be added. This gives the organisms that enter through the vegetable substance.

A fourth set of tubes can be filled with the culture material, plugged and sterilized. Unsterilized water can be then added to each of these tubes. This gives the microbes that come in through the water. These are rough methods adapted to general class work, and in each case the organisms which appear should be mounted and systematically studied to determine the different generic forms which are present, as far as that can be done by staining methods and the microscope.

Third Exercise.—The teacher can distribute material of diseased plants in which the disease is directly traceable to some bacterial organism. For this exercise, the professor should have a stock of at least a half dozen diseased plants properly fixed and preserved in 50 per cent. alcohol. The material, which has been distributed, should be cut free-hand by the student and the sections mounted as directed, or the student can imbed the material in celloidin, or in paraffin, to secure thinner serial sections by the use of a sliding, or rotary microtome. To carry on this exercise, the student should have an acquaintance with celloidin and paraffin technique.

Fourth Exercise.—Where the student has plenty of time and expects to specialize in the study of the bacterial diseases of plants, then he, or she, should follow the following scheme suggested by Chester in his "Manual of Determinative Bacteriology," the descriptions and keys of which can be used in a detailed systematic study of bacterial organisms. This exercise can be pursued only after the student has learned cultural and isolation methods and not at the beginning of a course in mycology and its technique.

LESSON 27

Scheme for the Study of Bacteria.—The Society of American Bacteriologists has adopted a numeric system of recording the salient characters of an organism (group number).

100.....	Endospores produced.
200.....	Endospores not produced.
10.....	Aërobic (strict).
20.....	Facultative anaërobic.
30.....	Anaërobic (strict).

1.....	Gelatin liquefied.
2.....	Gelatin not liquefied.
0.1.....	Acid and gas from dextrose.
0.2.....	Acid without gas from dextrose.
0.3.....	No acid from dextrose.
0.4.....	No growth with dextrose.
0.01.....	Acid and gas from lactose.
0.02.....	Acid without gas from lactose.
0.03.....	No acid from lactose.
0.04.....	No growth with lactose.
0.001.....	Acid and gas from saccharose.
0.002.....	Acid without gas from saccharose.
0.003.....	No acid from saccharose.
0.004.....	No growth with saccharose.
0.0001.....	Nitrates reduced with evolution of gas.
0.0002.....	Nitrates not reduced.
0.0003.....	Nitrates reduced without gas formation.
0.00001.....	Fluorescent.
0.00002.....	Violet chromogens.
0.00003.....	Blue chromogens.
0.00004.....	Green chromogens.
0.00005.....	Yellow chromogens.
0.00006.....	Orange chromogens.
0.00007.....	Red chromogens.
0.00008.....	Brown chromogens.
0.00009.....	Pink chromogens.
0.00000.....	Non-chromogens.
0.000001.....	Diastatic action on potato starch (strong).
0.000002.....	Diastatic action on potato starch (feeble).
0.000003.....	Diastatic action on potato starch (absent).
0.0000001.....	Acid and gas from glycerin.
0.0000002.....	Acid without gas from glycerin.
0.0000003.....	No acid from glycerin.
0.0000004.....	No growth with glycerin.

The genus, according to the system of Migula, is given its proper symbol which precedes the member thus: According to the above the symbol of *Bacillus coli* would be B. 222.111102 and of *Pseudomonas campestris* Ps. 211.333151. This will be found useful as a quick method of showing close relationships inside the genus, but is not a sufficient characterization of any organism. The descriptive chart of the Society of American Bacteriologists of which the above decimal system forms a part will be found useful in the detailed systematic study of the bacteria. It was prepared by F. D. Chester, F. P. Gorham and Erwin F. Smith, appointed as a committee on methods of identification of bacterial species. Their report was endorsed by the society at the annual meeting, December, 1907.

LESSON 28

The detailed investigation of the bacteria and other fungous organisms, as outlined below, can be undertaken only after the student has become acquainted with the cultural methods given in another section of this handbook, but the table adopted by the Society of American Bacteriologists is given below, because it fits into the general discussion and study of the classification previously given.

I. MORPHOLOGY.

1. VEGETATIVE CELLS.—Medium used.....
 temp....., age....., days.....
 Form, *round, short rods, long rods, short chains, long chains, filaments, commas, short spirals, long spirals, clostridium, cuncate, clavate, curved.*
 Limits of size.....
 Size of majority.....
 Ends, *rounded, truncate, concave.*
 Agar hanging block { Orientation (grouping).....
 { Chains (number of elements).....
 { *Short chains, long chains.*
 { Orientation of chains, *parallel, irregular.*
2. SPORANGIA.—Medium used.....
 temp.....
 Form, *elliptic, short rods, spindled, clavate, drum-sticks.*
 Limits of size.....
 Size of majority.....
 Location of endospores, *central, polar.*
3. ENDOSPORES.—Form, *round, elliptic, elongated.*
 Limits of size.....
 Size of majority.....
 Wall, *thick, thin.*
 Sporangium wall, *adherent, non-adherent.*
 Germination, *equatorial, oblique, polar, bipolar.*
4. FLAGELLA.—No..... Attachment, *polar, bipolar peritrichiate.*
 How stained.....
5. CAPSULES.—Present on.....
6. ZOOGLÆA, PSEUDOZOOGLÆA.
7. INVOLUTION FORMS.—On..... in days at°C.
8. STAINING REACTIONS.—1:10 watery fuchsin, gentian violet, carbol fuchsin
 Loeffler's alkaline methylene-blue.
 Special stains.....
 Gram..... Glycogen.....
 Fat..... Acid-fast.....
 Neisser.

II. CULTURAL FEATURES

- 1, 2, 3. AGAR STROKE, POTATO, LOEFFLER'S BLOOD-SERUM.—
 Growth, *invisible, scanty, moderate, abundant.*

Form of growth, *filiform, echinulate, beaded, spreading, plumose, arborescent, rhizoid* (Fig. 225).

Elevation of growth, *flat, effuse, raised, convex*.

Luster, *glistening, dull, cretaceous*.

Topography, *smooth, contoured, rugose, verrucose*.

Optic characters, *opaque, translucent, opalescent, iridescent*.

Chromogenesis,

Odor, *absent, decided, resembling*

Consistency, *slimy, butyrous, viscid, membranous, coriaceous, brittle*.

Medium, *grayed, browned, reddened, blued, greened*.

Liquefaction (Loeffler's blood-serum) begins in days, complete in days.

- 4, 5. AGAR STAB, GELATIN STAB.—Growth, *uniform, best at top, best at bottom, surface growth scanty, abundant; restricted, widespread*.

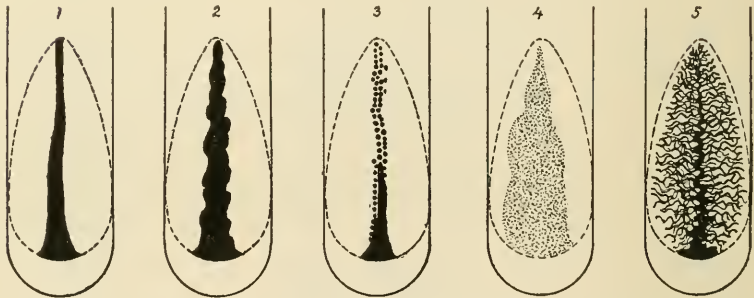

FIG. 225.—Types of streak culture. 1, Filiform (*Bacillus coli*); 2, echinulate (*Bacterium acidi lactici*); 3, beaded (*Streptococcus pyogenes*); 4, effuse (*B. vulgaris*); 5, arborescent (*Bacillus mycoides*). (From McFarland, after Frost in Schneider, Albert: *Bacteriological Methods in Food and Drug Laboratories*, 1915: 89.)

Line of puncture, *filiform, beaded, papillate, villous, plumose, arborescent*.

Liquefaction, *crateriform, napiform, infundibuliform, saccate, stratiform*, begins in days, complete in days.

Medium, *fluorescent, browned*.

6. NUTRIENT BROTH.—Surface growth, *ring, pellicle, flocculent, membranous, none*. Clouding, *slight, moderate, strong; transient, persistent; none, fluid turbid*. Odor, *absent, decided, resembling*
- Sediment, *compact, flocculent, granular, flaky, viscid on agitation, abundant, scant*.
7. MILK.—Clearing, without coagulation. Coagulation, *prompt, delayed, absent*. Extrusion of whey, begins in days. Coagulum, *slowly peptonized, rapidly peptonized*. Peptonization, begins on days, complete on days

- Reaction, 1 day, 2 days, 4 days, 10 days
 20 days
- Consistency, *slimy, viscid, unchanged*.
- Medium, *browned, reddened, blued, greened*.
- Lab. ferment, *present, absent*.
8. LITMUS MILK.—*Acid, alkaline, acid then alkaline, no change. Prompt reduction, no reduction, partial slow reduction.*
- 9, 10. GELATIN COLONIES. AGAR COLONIES.—Growth, *slow, rapid*.
 (Temperature).
- Form, *punctiform, round, irregular, amaboid, mycelioid, filamentous, rhizoid*.
 Surface, *smooth, rough, concentrically ringed, radiate, striate*.
 Elevation, *flat, effuse, raised, convex pulvinate, umbonate, crateriform*
 (liquefying).
 Edge, *entire, undulate, lobate, crose, lacerate, fimbriate, floccose, curled*.
 Internal structure, *amorphous, finely, coarsely granular, grumose, filamentous, floccose, curled*.
 Liquefaction, *cup, saucer, spreading*.
11. STARCH JELLY.—Growth, *scanty, copious*.
 Diastatic action, *absent, feeble, profound*.
 Medium stained
12. SILICATE JELLY (FERMIS' SOLUTION).—Growth, *copious, scanty, absent*.
 Medium stained
13. COHN'S SOLUTION.—Growth, *copious, scanty, absent*.
 Medium, *fluorescent, non-fluorescent*.
14. USCHINSKY'S SOLUTION.—Growth, *copious, scanty, absent*.
 Fluid, *viscid, non-viscid*.
15. SODIUM CHLORIDE IN BOUILLON.—Per cent. inhibiting growth
16. GROWTH IN BOUILLON OVER CHLOROFORM.—*Unrestrained, feeble, absent*.
17. NITROGEN.—Obtained from *peptone, asparagin, glyocol, urea, ammonia salts, nitrogen*.
18. Best media for long-continued growth

19. Quick tests for differential purposes

III. PHYSICAL AND BIOCHEMIC FEATURES

I. FERMENTATION TUBES CONTAINING PEPTONE WATER OR SUGAR-FREE BOUILLON, AND.....	Dextrose	Saccharose	Lactose	Maltose	Glycerin	Mannite						
Gas production in per cent. (Fig. 226).....												
$\left(\frac{H}{CO_2}\right)$												
Growth in closed arm.....												
Amount of acid produced 1 day.....												
Amount of acid produced, 2 days.....												
Amount of acid produced, 3 days.....												

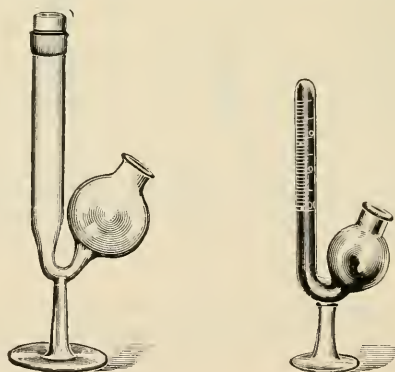

FIG. 226.—Graduated fermentation tubes for gas determinations. (Schneider, *Pharmaceutical Bacteriology*, p. 60.)

2. AMMONIA PRODUCTION.—*Feeble, moderate, strong, absent, masked by acids.*
3. NITRATES IN NITRATE BROTH.—*Reduced, not reduced.*
 Presence of nitrites..... ammonia.....
 Presence of nitrates..... free nitrogen.....
4. INDOL PRODUCTION.—*Feeble, moderate, strong.*
5. TOLERATION OF ACIDS.—*Great, medium, slight, acids tested*.....
6. TOLERATION OF NAOH.—*Great, medium, slight.*
7. OPTIMUM REACTION FOR GROWTH IN BOUILLON, STATED IN TERMS OF FULLER'S SCALE.

8. VITALITY ON CULTURE MEDIA.—*Brief, moderate, long.*
9. TEMPERATURE RELATIONS.—Thermal death point (ten minutes exposure in nutrient broth when this is adapted to growth of organism).....°C.
10. KILLED READILY BY DRYING, resistant to drying.
11. PER CENT. KILLED BY FREEZING (salt and crushed ice or liquid air).
12. SUNLIGHT.—Exposure on ice in thinly sown agar plates; one-half plate covered (time fifteen minutes), *sensitive, non-sensitive.*
Per cent. killed.....
13. ACIDS PRODUCED.....
14. ALKALIS PRODUCED.....
15. ALCOHOLS.....
16. FERMENTS.—*Pepsin, trypsin, diastase, invertase, pectase, cytase, tyrosinase, oxidase, peroxidase, lipase, catalase, glucase, galactase, lab, etc.*
17. CRYSTALS FORMED.....
18. EFFECTS OF GERMICIDES.....

Substance	Method used	Minutes	Temperature	Killing quantity	Amount required to restrain growth

IV. PATHOGENICITY.

1. PATHOGENIC TO ANIMALS.—*Insects, crustaceans, fishes, reptiles, birds, mice, rats, guinea pigs, rabbits, dogs, cats, sheep, goats, cattle, horses, monkeys, man.*
2. PATHOGENIC TO PLANTS.—.....
3. TOXINS.—*Soluble, endotoxins.*
4. NON-TOXIN FORMING.....
5. IMMUNITY (bactericidal).....
6. IMMUNITY (non-bactericidal).....
7. LOSS OF VIRULENCE ON CULTURE MEDIA.—*Prompt, gradual, not observed in.....months.*

The Society of American Bacteriologists has endorsed a brief characterization as a part of the descriptive chart which it has published. This brief description is useful in a comparative study of different microorganisms.

BRIEF CHARACTERIZATION

Mark + or o, and when two terms occur on a line, erase the one which does not apply, unless both apply.

Morphology	Diameter over 1μ		Biochemic features	Liquefaction	Gelatin
	Chains, filaments				Blood-serum
	Endospores				Casein
	Capsules				Agar, mannite
	Zoogloea, pseudozoogloea			Milk	Acid curd
	Motile				Rennet curd
	Involution forms				Casein peptonized
	Gram's stain			Indol	
Cultural features	Broth	Cloudy, turbid	Hydrogen sulphid		
		Ring	Ammonia		
		Pellicle	Nitrates reduced		
		Sediment	Fluorescent		
	Agar	Shining	Luminous		
		Dull	Animal pathogen, epizoon		
		Wrinkled	Plant pathogen, epiphyte		
		Chromogenic	Plant pathogen, endophyte		
	Gel. plate	Round	Soil		
		Proteus-like	Milk		
		Rhizoid	Fresh water		
		Filamentous	Salt water		
		Curled	Sewage		
	Gel. stab	Surface-growth	Air ¹		
		Needle-growth	Iron bacterium		
	Potato	Moderate, absent	Sulphur bacterium		
		Abundant	Erythro bacterium ¹		
		Discolored	Nitro bacterium ¹		
		Starch destroyed	Nodule-producing ¹		
	Grows at 37°C.		Economic use	Fermentation ¹	
Grows in Cohn's sol.		Retting ¹			
Grows in Uschinsky's sol.		Dairy ¹			
		Pharmaceutic ¹			

¹Additions to the original chart of the Society of American Bacteriologists.

NOTES.—The morphologic characters shall be determined and described from growths obtained upon at least one solid medium (nutrient agar) and in at least one liquid medium (nutrient broth). Growth at 37°C. shall be in general not older than twenty-four to forty-eight hours, and growths at 20°C. not older than forty-eight to seventy-two hours. To secure uniformity in cultures, in all cases preliminary cultivation shall be practised as described in the revised Report of the Committee on Standard Methods of the Laboratory Section of the American Public Health Association, 1905.

The observation of cultural and biochemic features shall cover a period of at least fifteen days and frequently longer, and shall be made according to the revised standard methods above referred to. All media shall be made according to the same standard methods.

Gelatin stab cultures shall be held for six weeks to determine liquefaction.

Ammonia and indol tests shall be made at the end of tenth day, nitrite tests at end of fifth day.

Titrate with $\frac{n}{20}$ NaOH, using phenolphthalein as an indicator; make titrations at times from blank. The difference gives the amount of acid produced.

The titration should be done after boiling to drive off any CO₂ present in the culture.

Generic nomenclature shall begin with the year 1872 (Cohn's first important paper). Species nomenclature shall begin with the year 1880 (Koch's discovery of the poured plate method for the separation of organisms).

Chromogenesis shall be recorded in standard color terms.

LESSON 29

DIRECTIONS FOR THE STUDY OF PATHOGENIC FUNGI

The directions given below for the study of the fungi which cause diseases in plants have been made as general as possible so that the student will find enough flexibility in the outline that it may be applied to description of any of the pathogenic fungous organisms which may be presented to him in his laboratory or field work. The use of such directions is in line with the best teaching methods in this country at the present time. The student is given the diseased organ or plant for study and by following the outline an acquaintance is obtained not only with the diseased conditions of the host, but with the morphologic character of the fungus as well. Some teachers emphasize the importance of getting away from the study of systematic details and concentrating the attention of the members of the class in mycology upon the plant diseases on the basis of the pathologic phenomena exhibited. Perhaps this is the best plan with advanced students, who have some knowledge of the morphology and classification of the fungi, a knowledge which should precede, it seems to the writer, a more detailed study of these interesting plants. It is recommended to the teacher that this outline be used closely in connection with the study of the diseases described in part III of this book. The teacher, of course, is at liberty to select other forms for study as the geographic locality may afford. The following

outline is suggestive of such study, where the heading suggests the question which the students ask themselves in their examination of the diseased plants.

Serial number of type.	Place of collection.
Habitat and soil condition.	Date.
Name of host.	Common names of disease.
History and geographic distribution.	
Additional data (Here may be given the nature and amount of loss).	

SYMPTOMS

Under this head should be described the general structural changes (morphologic, or histologic) which are manifest in the diseased host plant, and which distinguish it from a healthy individual. They may be treated under the following captions:

1. General appearance of the diseased plant.
2. Change in form of part diseased.
3. Change in taste and odor.
4. Change in color as contrasted with healthy part.
 - (a) Pallor (chlorosis), yellow or white instead of normal green. (Do such names as mosaic, calico and yellows apply?)
 - (b) Colored spots or areas on leaves, stems, fruits (black, brown, orange, red, variegated, white, yellow, etc.).
5. Perforation of leaves (shot-hole).
6. Damping-off, wilt, wilting, blight (blossom-blight, body-blight, leaf-blight, twig-blight).
7. Death of leaves, twigs, stems, etc. (necrosis).
8. Dwarfing or atrophy. Several names have come into current use expressive of such condition, as: curly dwarf, leaf-roll, little-peach, spindling-sprouts.
9. Increase in size: hypertrophy. Measurements should be made of the enlarged parts as contrasted with the normal and the following names may be found applicable in the study of the hypertrophy: crown-gall, root-gall, root-knot, root-tubercle.
10. Replacement of parts by new parts.
11. Mummification, character of.
12. Change in position of organs.
13. Disappearance or non-formation of plant parts.
14. Excrescences and malformations. The following names may be found suggestive in the description of excrescences and malformations: Cankers, corky outgrowths, pustules, rosettes, scabs and witches' brooms.
15. Exudations.
 - Slime flux.
 - Gummosis.
 - Resinosis.
16. Rotting.—The following terms are suggestive of some kinds of rot: bud-rot, collar-rot, crown-rot, foot-rot, heart-rot, root-rot, stem-rot and the following particular kinds given prominence here.

Dry-rot.
 Soft-rot (Gangrene).
 Black-rot.
 White-rot.

SIGNS

The incidental or experimental evidence of disease is indicated by marks or signs. Such signs are usually afforded by the fruiting or vegetative part of the pathogenic organism. Such terms as mildew, mould, ooze, rust and smut are indicative of diseased or parasitic conditions.

General Suggestions.—In the report which is made by each student following the above outline, drawings should, as far as possible, accompany the descriptions.

ETIOLOGY

COMMON NAME OF PATHOGEN.

SCIENTIFIC NAME.

FAMILY.

PATHOGENICITY.

ADDITIONAL DATA.

CULTURAL CHARACTER OF ORGANISM.

NOTE.—In case the pathogenic organism is bacterial the directions for its study have already been given as recommended by the Society of American Bacteriologists. As the outline of the Society is the outcome of years of study, it should be followed in all cases, but in addition the following directions for the study of parasitic plant organisms should be kept in view by the mycologic student.

Isolation of organism in pure culture. Directions have been given for the manufacture of culture media and for the isolation of fungi in pure culture. These should be followed.

Inoculation of pure culture into healthy host plants.

Recovery of organism in pure culture.

LIFE HISTORY

The Primary Cycle.—Nature of mycelium (septate, or unseptate; presence or absence of haustoria (nature); intercellular, or intracellular hyphæ; color; contents; penetration and destruction of host cells = pathogenic histology of host).

Kinds of spores (sexual or non-sexual; conidia; pycnospores; oidiospores; chlamydospores; ascospores; zygosporos; oospores; urediniospores; teliospores; aeciospores; basidiospores, etc.).

Sizes, shapes and color of spores.

Importance in life cycle.

Pathogenesis of primary stage.

Saprogenesis.

The Secondary Cycles.—The same order of procedure should be observed in the study of the secondary cycles as in the examination of the primary.

INFLUENCE OF SOIL FACTORS.

INFLUENCE OF CLIMATIC FACTORS.

CONTROL.

Quarantine measures.

Spraying.

Remedial measures (dressing wounds and soil amelioration).

Breeding (selection of resistant strains and crossing).

Eradication (burning of diseased plants, cultivation of soil by rotation; disinfection).

LITERATURE RELATING TO DISEASE AND ORGANISM.—The citations which are given in this section can be arranged with reference to their importance and with some view of the above outline of study. For example, papers dealing with the disease in general, with the morphology of the fungus, with the method of control, might be listed separately under one of the above heads. It is important for the student to get acquainted with the literature of a subject; otherwise he cannot appreciate what has been done in his particular field of scientific endeavor. A bibliography should be made.

CHAPTER XXXVIII—LABORATORY AND TEACHING METHODS (CONTINUED)

LESSON 30

Inoculation Experiments.—The experiments recorded below need not be rigidly followed by the mycologic teacher. Other organisms and other hosts can be used just as satisfactorily. The types used must be determined by locality and by other considerations of cultural methods and laboratory facilities. The directions below may be taken as samples.

Potato Rot (Fusarium trichothecoides).—Take Green Mountain potato tubers and sterilize surface by soaking in 2 per cent. formalin for two hours. The tubers are then held with towels that have been boiled in water, and are wrapped in these sterilized wet towels after having been inoculated with *Fusarium trichothecoides* by pricking the surface of the tubers and dipping them in distilled water which holds the spores of the fungus in suspension. The potato tubers wrapped with wet towels are then surrounded with oiled paper and kept at a temperature not lower than 10° to 12°C. Tubers of several varieties can be used, such as Up-to-date, Early Rose, Irish Cobbler. If the inoculation has been successful, results will be noted in ten to fifteen days. A transfer to potato slant test-tubes will result in a fungus which has powdery-rosy appearance. Consult JAMISON, C. O., and WOLLENWEBER, H. W.: An External Dry-rot of Potato Tubers caused by *Fusarium trichothecoides*. Journal of the Washington Academy of Science, II, No. 6, March 19, 1912.

After the normal lesions have been obtained and the fungus studied morphologically under the microscope, take small slices of potato tuber showing healthy and diseased tissues in proximity and fix in chromacetic acid. Wash off the fixative in running water, and carry through the alcohol, etc., to paraffin. After imbedding in paraffin, section and mount as usual (see Lesson 42).

Crown-gall (Pseudomonas tumefaciens) (Fig. 227).—Inoculate the stem of a geranium (*Pelargonium zonale*) with the organism in pure culture by first washing the stem at the intended point of infection with 1 per cent. formalin and then with distilled water. Place some of the pure culture on the stem by means of a platinum needle and prick the organism into the stem with a sterile needle mounted in a wooden handle. The part of the geranium stem selected should be a young actively growing leader (consult the Bulletin of ERWIN F. SMITH, and the book of DUGGAR, Diseases of Plants, pp. 114-118).

This organism can be successfully grown on *beef agar* which is made as follows. To 1000 c.c. of peptonized beef bouillon add 1 per cent. of agar flour, steam three-quarters of an hour and cool down below 60°C. Then add neutralized white of two eggs to clarify. Made to + 15 Fuller's scale by adding 4NaOH. The test-tubes are autoclaved fifteen minutes at 110°C.

For this and other experiments consult MELNUS, T. E.: Culture of Parasitic Fungi on Living Hosts. *Phytopathology*, 11: 197-203, October, 1912.

Pear Blight (*Bacillus amylovorus*, Burrill) (Fig. 228).—Take some pear twigs long enough to be accommodated easily under an ordinary bell jar. Cut off these stems under water and transfer to a jar under water, so that the cut ends are not exposed to the air. Then make slanting cuts at the upper end of the twigs with a sterile knife and inoculate the cut ends with the organism. Cover the twigs and jar in which they are placed with a bell jar, as shown in the accompanying



FIG. 227.—Crown gall artificially produced in greenhouse of University of Pennsylvania by inoculation of *Pelargonium zonale* with *Pseudomonas tumefaciens*. (Photo by Charles S. Palmer.)

illustration. Note the result of the inoculation on the tissue of the twigs and on the health of the leaves. Consult DUGGAR, B. M.: *Fungous Diseases of Plants*, pp. 121-129.

Lettuce Drop (*Sclerotinia Libertiana*, Fuckel).—Lettuce leaves may be inoculated by means of the sclerotia of fungus, or by the mycelium laid upon the surface of scarified areas of the leaf. As inoculation produces a virulent form of the disease *control*, plants of lettuce should be kept for comparison (DUGGAR, pp. 190-200).

Wilt of Sweet Corn (*Bacterium (Pseudomonas) Stewarti* E. F. SM. (Fig. 229).—This organism was furnished on beef agar and is best inoculated by applying small

quantities of a pure culture to a stem of young sweet corn and then pricking it in by means of a sterile needle. Some have inoculated the young sweet corn plants by placing the organism in the drops of water which exude from the tips of the corn leaves early in the morning, but the inoculation by means of needle pricks is more certain. Sections should be made of the stem at various stages of growth after inoculation. This is done by using a number of plants. Free-hand sections, or paraffin sections, will show the presence of the organism in the vascular bundles. Stain with carbol fuchsin (DUGGAR, pp. 111-113).

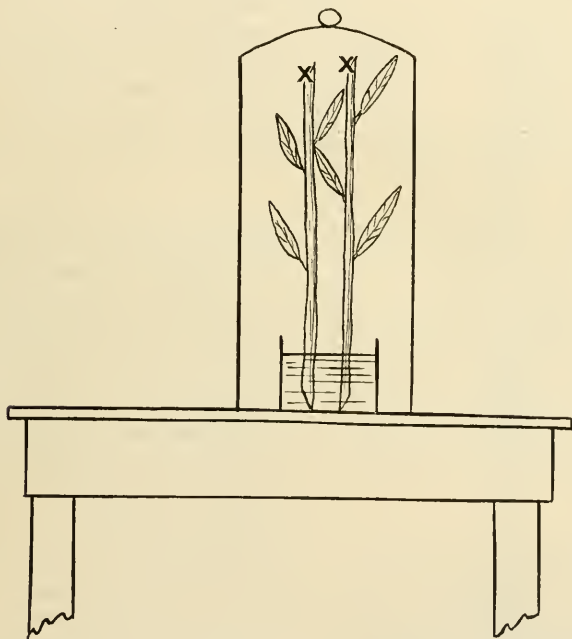

FIG. 228.—Arrangement of experiment for inoculation of pear twigs with blight organism, *Bacillus amylovorus*.

LESSON 31

Black-rot of Cruciferous Plants (Bacterium (Pseudomonas) campestris, Pammel) (see SMITH, ERW. F.: *Bacteria in Relation to Plant Diseases*, pp. 300-334; DUGGAR, B. M.: pp. 107-111).—This organism is best inoculated into the stem of young cabbage plants below the upper last three leaves, because of the tendency of these leaves to drop off before the disease has progressed to its fullest extent. The stem is first washed, the organism is smeared on at the point of inoculation and pricked by a sterile cambric needle into place. It is recommended that several sections be made, and that to secure the several stages, a number of different inoculations be made.

Chestnut Blight (*Endothia* (*Diaporthe*) *parasitica* (Murrill) Anderson).—Inoculation into the chestnut tree should be made into scarifications of the bark made by means of a sterile scalpel. The bark should be washed before inoculation by means of a weak formalin solution followed by distilled water. The summer spores can be rubbed into place by means of a sterile platinum needle.

Appel's Potato Rot (*Bacillus phytophthorus*, Appel).—This organism readily grows on beef agar. It is inoculated into washed parts of the potato stem by smearing some of the culture on the stem and pricking into place by means of a sterile cambric needle into the young growing tissue.

LESSON 32

Sleepy Disease of Tomatoes (*Fusarium lycopersici* Sacc.).—This organism can be cultivated on steamed rice, or on potato slants. Inoculate just above the lower leaves of the young stem by first washing the stem with distilled water. Place some of the culture on the part of the stem to be inoculated and prick the fungus into the stem with a sterile needle. In ten to fifteen days, the tomato plants begin to wilt and in three weeks the diseased conditions are unusually good for study. The culture growths show pale orange spore masses and a whitish mycelium. The tomato variety Consate is not susceptible. Wollenweber used the variety Stone and found it satisfactory.

Egg Plant Wilt (*Verticillium albo-atrum*).—Inoculate the hypocotyl near or below the soil level with spores suspended in water of a ten days old culture.

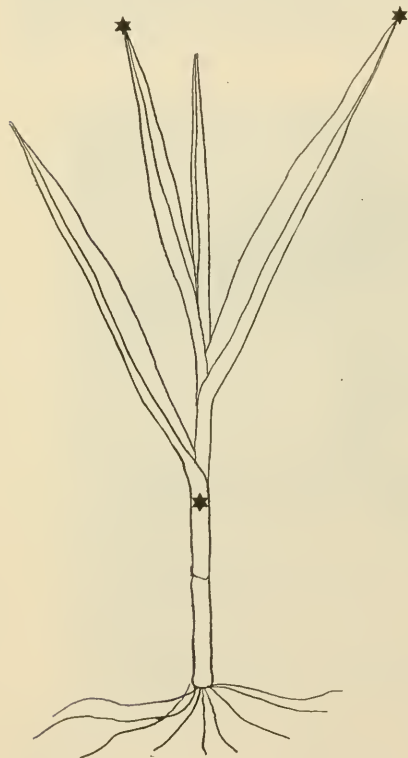

FIG. 229.—Young corn plant showing places for inoculation with *Pseudomonas Stewarti*.

ture. Egg plants of any age may be inoculated. Black sclerotia are found in from ten to fourteen days after the inoculation. This organism is readily grown on potato slants.

Wilt Disease of the Cotton Cowpeas and Watermelon (*Neocosmospora vasinfecta* (Atkinson) E. F. Sm.).—See DUGGAR, B. M.: *Fungous Diseases of Plants*, pp. 233–239; also SMITH, ERW. F.: *Wilt Disease of Cotton, Watermelon and Cowpeas*. Bull. 17, U. S. Division of Vegetable Physiology and Pathology, 1899.

As plants of cowpea, cotton and watermelon have been grown in the greenhouse

and are ready for inoculation, experiments may be tried on all three of these plants. Inoculation with this fungus should be made into the roots of these plants, just below the soil of the experimental pots. The soil should be removed and the tops of the roots laid bare. Inoculation can be made by incisions into the root into which the mycelium or spores of the fungus are rubbed. After inoculation the soil can be returned to its place.

LESSON 33

Knot of Citrus Trees (Sphæropsis tumefaciens).—Successful inoculations have been made on lime, pomelo, lemon, tangerine and hardy orange (*Citrus trifoliata*).

First Method.—Make a small T-shaped cut in the back of a lemon or orange tree with a sterile knife and insert some mycelium. Smooth the bark down and bind the stem with raffia to cover the wound completely.

Second Method.—Inoculate by pricking the stem three times with a sterile cambric needle fixed in a wooden handle, then place a little mycelium over these punctures and bind with raffia.

Third Method.—Inoculate by cutting off a very small amount (2 or 3 sq. mm.) of the outer bark, then spread the mycelium over this injury and bind it with raffia. A year may elapse before the galls are fully formed.

Consult HEDGES, FLORENCE, and TENNY, S. S.: A Knot of Citrus Trees Caused by *Sphæropsis tumefaciens*. Bull. 247, Bureau of Plant Industry, 1912.

Clover Disease.—Select either red, white, or alsike clover plants somewhere in a protected place in the garden, or as potted plants in the greenhouse, and inoculate with *Bacillus lathyri*. The inoculation may be made by an atomizer. Make a suspension of the organism in distilled water by means of several loopfuls stirred in the water. Spray the clover plants with the water and cover with a bell jar for a few days (J. J. Taubenhau).s).

LESSON 34

Sweet Pea Diseases (J. J. Taubenhau).—Take several potted sweet pea plants and spray the leaves by means of an atomizer, which has been sterilized previously by boiling in water. Make a suspension of the spores of *Glomerella rufomaculans* in water and spray this water upon the sweet pea plants which should then be covered with a bell jar. Study the stages of spore germination and spore inoculation by sacrificing daily one of the sprayed plants.

Inoculate the seeds of sweet pea varieties with cultures of *Fusarium sp.* and *Corticium vagum* by immersing the seeds in water containing a suspension of fungous spores. To get this suspension stir up the separate cultures in a sterile watch glass in distilled water. Then dip the seeds in this water and plant the seeds in loamy soil in pots for greenhouse culture. Follow the germination of the peas and the progress of the disease, thus communicated to the plants.

Inoculate the sweet pea by placing a pure culture of root-rot, *Thielavia basicola* on the roots of sweet pea plants. Another method adapted to prove the pathogenicity of the fungus is to sow pure cultures of it on sterilized seeds (seeds treated with 5 per cent. formalin for one-half hour) in sterile pots and soils.

Inoculate seedlings of sweet pea with *Chætomium crispatum* by soaking the seeds

in distilled water containing the spores of the fungus. The seeds should be previously sterilized, as described above, and the suspension of spores made as above directed. Healthy plants should be raised from uninoculated seeds as checks on the progress of the disease in inoculated plants.

Inoculate sweet pea plants with *Sclerotinia libertiana* by introducing pieces of the fungus into pots in which sweet peas are growing. Have a potted plant as a check and cover both plants with a bell jar in order to imitate the moisture conditions of the greenhouse. After four to six days, wilting of the inoculated plants will be noted, while the check remains in a perfectly healthy state.

LESSON 35

Experiments with Artificial Wounding of Plants.

1. Take any herbaceous plant such as hyacinth, snowflake, daffodil, and by means of a pair of scissors make a short cut into the tissues of the leaves of these plants, into enough of leaves, so that a serial study can be made of the formation of healing tissue. Pieces of the leaf are taken from time to time and sectioned by any of the methods described in Lesson 42.

2. Take any living shrub or tree and make the following cuts:

(a) With a knife cut out a thin longitudinal piece of bark down to the cambium.

(b) Make an irregular tear in the bark by removing a small piece down to the wood.

(c) Cut out a ring of bark half way around the stem.

(d) Make incisions into a pine tree and by means of sections study the flow of resin and the healing operation.

(e) Make incisions into the ordinary rubber plant *Ficus elastica*, and study with sections the effect of the injury on the cells affected.

(f) Make incisions into any of the woody euphorbiaceous plants of the greenhouse and study the injuries produced in a similar analytic manner.

3. Cut out larger pieces of bark from deciduous trees and shrubs and by sections study the formation of cells. By several trips to the fields much of the material illustrating the healing of wounds can be obtained for the making of sections and in all stages of development without waiting for the slow development of new tissue in the experimental plants. Cut with sliding microtome.

Note the formation of tyloses in many of the woody stems studied. Linden is an especially good tree to show their formation.

Study callus formation of various cuttings, for example, *Ficus*, *Geranium*, *Ostrya*, *Populus*, *Quercus* and *Ulmus*. Place the ends of these cuttings in different media, as follows:

1. One end in water, the other end in dry air.
2. One end in water, the other end in moist air.
3. Both ends in moist air.
4. Both ends in water.
5. One end in moist air, the other in dry air.
6. One end in water, the other in moist sand.

7. One end in moist air, the other in sand.
8. Two ends in wet sphagnum.
9. One end in wet sphagnum, the other in moist air.
10. One end in wet sphagnum, the other in wet sand, etc.

Try wounding the cotyledons of *Phaseolus*, *Vicia*, etc.; also young seedling plants. Use plaster casts to envelope the cut ends. Cf. TITTMAN: Physiologische Untersuchungen über Callusbildung an stecklinger holziger Gewächse. Pringsheim Jahrb. für wissenschaft. Bot., xxvii: 164, 1895.

After securing callus under experimental treatment, then cut, stain and mount for microscopic study. See KÜSTER, ERNST: Pathologische Pflanzenanatomie, 2d. Edition.

LESSON 36

Gas Injuries.—See Exper. Sta. Rec., xxx, 131, February, 1914.

Take a series of potted plants and introduce into the soil by means of the hole in the pot bottom different quantities of illuminating gas by means of a rubber tube connected with the gas pipe. Note the effect of the illuminating gas on the health of the plants. Set willow cuttings in water treated and untreated with gas; note the effect.

Take another set of potted plants and place them beneath bell jars, as follows:

Plant *A* beneath a bell jar with a beaker of water containing illuminating gas introduced into the water from the gas pipe.

Plant *B* beneath a bell jar into which free gas is conducted by a rubber pipe from the gas jet. Cf. STONE, G. E.: Effects of Illuminating Gas on Vegetation. 25th Annual Report Mass. Agric. Exper. Sta., 1913: 13-28; The Effect on Plant Growth of Saturating a Soil with Carbon Dioxide. Science, new ser. xl: 792, Nov. 27, 1914.

Smoke Injuries.—See CLEVINGER, J. F.: Mellon Instit. Bull. No. 7.

Take a series of potted plants of different species and expose them to smoke conducted to them by means of glass tubes or rubber tubes from the receptacle where the smoke is generated. Study sections of the smoke-injured tissues.

Tobacco smoke may be tried on tender plants likewise. Consult BAKKE, A. L.: The Effect of Smoke and Gases on Vegetation. Iowa Academy Sciences, 1913 (xx): 169-188.

As to smoke injuries, consult also BAKKE, A. L.: The Effect of City Smoke on Vegetation. Bull. 145, Agric. Exper. Sta. Iowa State Coll. of Agric. and Mech. Arts, October, 1913. See also KNIGHT, H. I. and CROCKER, WM.: Smoke and Gas Poisoning. Bot. Gaz., May, 1913: 337-371.

Acid Injuries.—Treat plants with dilute solutions of various acids and note their effect on the leaves and flowers. The common morning glories, *Ipomœa purpurea*, are useful for this purpose.

Raise some morning-glory plants to flower and treat with dilute acids by spraying with an atomizer. Cf. STONE, GEORGE E.: The Influence of Various Light Intensities and Soil Moisture on the Growth of Cucumbers and their Susceptibility to Burning from Hydrocyanic Acid Gas. 25th Annual Report. Mass. Agric. Exper. Sta., 1913: 29-40.

LESSON 37

Enzyme Diseases.—Study these diseases of green plants by taking a series of leaves of various variegated Anthuriums and other greenhouse species and treat them as follows: The leaves to be tested are to be boiled for about one minute in water, when they should be flaccid and free from intercellular air. They are then placed in methylated spirit warmed to 50° to 60°C.: cold spirit will remove the chlorophyll, but not so quickly. To produce the iodine reaction, place the decolorized leaves in alcoholic tincture of iodine, dilute with water to the color of dark beer. In a few minutes they will be stained, and after washing in fresh water, they should be spread out on a white plate so that their tint may be well seen. When full of starch they are almost black, and with less amount of starch, the color sinks through purple, gray and greenish-gray to the yellow tint of starchless leaves (Sach's method).

In Schimper's method prepare strong chloral hydrate by dissolving the crystals in as much distilled water as will just cover them. The solution is now colored by the addition of a little tincture of iodine and is ready for use.

Discoloration of Cut Pieces of Plants.—Cut slices of fresh potatoes and expose them to the action of the air. Also grate some of the material and test the rapidity of discoloration.

Take similar pieces and place them in distilled water for twelve hours. Then expose the cut pieces to the air, and note the result.

These same experiments can be performed with various toadstools and fleshy fungi, when these are in season.

Bibliography.—ALLARD, H. A.: The Mosaic Disease of the Tobacco. Bull. U. S. Dept. Agr., No. 40, pp. 33, Jan. 15, 1914.

LOEW, O.: Catalase. U. S. Dept. Agr., Report 68.

STONE, GEO. E.: Mosaic and Allied Diseases with Especial Reference to Tobacco and Tomatoes. 25th Annual Report Mass. Agric. Exper. Sta., 1913: 94-104.

WOODS, A. F.: Mosaic Disease of Tobacco. U. S. Dept. Agr., Bureau of Plant Industry, Bull. 18.

Chlorosis.—Grow vetches and peas in nutrient solution; add 2 per cent. calcium carbonate, when chlorosis immediately appears, even if iron sulphate is present in the solutions. A few days in iron nitrate will cause the return of the green color. In treating plants for chlorosis, a 0.2 per cent. solution of iron nitrate sprayed on the leaves gives good results.

Where pineapples can be grown in the greenhouse or the open the following facts will suggest a line of experiments with them and their chlorosis.

Chlorotic pineapples in Hawaii occur on acid or neutral soils that average 5.0 per cent. Mn_3O_4 and 0.5 per cent. CaO. Chlorotic pineapples in Porto Rico occur on soils containing from 2 to 80 per cent. carbonate of lime and no manganese. That the chlorosis in Porto Rico is induced by the carbonate of lime was proved by direct experiment. Soils which normally produced healthy pineapples were made to produce chlorotic plants by the admixture of carbonate of lime from different sources. We may thus speak of one as a manganese-induced chlorosis and the other as a lime-induced chlorosis. The lime chlorosis has been shown to be due to a lack of iron in the plant, caused by the carbonate of lime diminishing the availability

of iron in the soil. M. O. Johnson at the Hawaiian Experiment Station has shown that the chlorosis of pineapples occurring on highly manganese soils can be cured by spraying the leaves with ferrous sulphate, similarly in Porto Rico the disease due to calcareous soils can be cured by the application of iron salts.¹

LESSON 38

Study of Mistletoe.—Procure living material of the American mistletoe (*Phoradendron flavescens*) or European mistletoe (*Viscum album*) and make sections with the sliding microtome of the stem of host and the parasitic roots of the parasite and study in detail the association of host and parasite (Figs. 119, 120, 121).

This method of study can be used with *Loranthus Sadebeckii* on *Citrus medica*. See KLEBAHN, DR. H.: Grundzüge der allgemeinen Phytopathologie, 1912: 110. Cf. TUBEUF, C. VON: Infektionversuche mit der rotfrüchtigen Mistel. Naturw. Jahrb. Forst. und Landw., xi: 51; Bot-Centralblatt, 123: 293.

Dodder.—Gather material of *Cuscuta*, *Orobanche*, *Gerardia*, *Lathræa* and other parasites, and study their anatomy as connected with the anatomy of the hosts on which they occur (Figs. 117, 122, 123).

The writer has frequently made sections of the stems of the Jo-Pye weed, *Eupatorium purpureum*, parasitized by *Cuscuta Gronovii*. These sections were made with the sliding microtome and have been kept in 50 per cent. alcohol until ready for use. As class exercises they have been double-stained with safranin and methyl green, which brings out the relationship of host and parasite very nicely. Finally the sections have been mounted in balsam and drawn by each member of the class.

LESSON 39

Wire Worms in Plants.—As the subject of the injurious effects of animals on plants is a large one and belongs rather to entomology and other departments of Zoology only one case will be studied here.

Nematode Infection of Plants.—Secure material showing the root infection of horticultural plants by the nematode worm, *Heterodera radicum*. Make sections showing relation of parasite to host.

Take healthy plants and infect them by transplanting into a soil containing the eggs or the live round worm. Study entry of the parasite into the hosts and by paraffin, celloidin or sliding microtome sections, study the relation of the parasite and host plants.

Similarly, a study of insect galls can be made and their anatomy studied according to the description of galls previously given in the second part of this book. Such a study of galls should be encouraged by the teacher, wherever time and the arrangement of the courses makes it practicable to do so.

¹ GILE, P. L.: Chlorosis of Pineapples Induced by Manganese and Carbonate of Lime. Science, new ser., 44: 856, Dec. 15, 1916. MAZE, P., RUOT, M. and LEMOIGNE, M.: Calcareous Chlorosis of Green Plants: The Rôle of Root Excretions in the Absorption of Iron in Calcareous Soils. Compt. Rend. Acad. Sci. (Paris), 157 (1913), No. 12, pp. 495-498 (Exper. Sta. Rec. xxix: 826).

LESSON 40

Relation of Light to Pathologic Conditions.—While light plays an important part in the development of normal tissue, a lack of it is responsible for many abnormal conditions, and there are a number of diseases common to plants under glass which are traceable to insufficient light. Plants, such as cucumber, grown under the poor light common to November and December, have leaves of poor color, slender and elongated petioles, and little mechanic or resistant tissue, and when subjected to the bright sun in the early spring every plant in the house will wilt. Poor light also renders cucumber plants more susceptible to powdery mildew and often causes the tender edges of the leaves to wilt, turn brown and die. The larger number of leaves produced in lettuce plants prevent light from reaching the stem, and stem-rot (*Sclerotinia*) or "drop" could undoubtedly be prevented, if the stem were continually exposed to sunlight. The leaf blights of chrysanthemum and tomato, caused by *Cylindrosporium*, are associated with insufficient light and circulation of air at the base of the stem. Cf. STONE, GEORGE E.: *The Relation of Light to Greenhouse-Culture*. Bull. 144 (July, 1913), Mass. Agric. Exper. Sta.

Experimental Work.—Grow cucumbers and lettuce plants from seed and expose the potted plants to various light intensities in the greenhouse by shading with several thicknesses of glass, by placing in shaded places in the greenhouse, by growing next to the glass in the best lighted places. Note the effect on the growth and general health of the plants. Grow morning glories in pots during winter and study growth.

Etiolation and the Health or Vigor of Plants.—In order to study the tonic influence of light upon a plant, we must study its growth in darkness. We find that a plant grown in the dark is modified both in form and structure. The woody and sclerenchymatous elements are much reduced, and the parenchyma of the cortex is increased in bulk. The stem becomes very much elongated and remains slender. It is more succulent than a normal stem, and bears extremely small leaves which grow out from it at a more acute angle than those which rise upon a normally illuminated stem. The reaction of its sap is much more acid. The chloroplasts do not become green, the pigment, which they contain, known as etiolin, being a pale yellow. In the leaves, the differentiation of the mesophyll into palisade and spongy parenchyma does not take place. Plants thus affected by darkness are said to be etiolated.

Experimental Work.—Grow the following plants in light and in total darkness: *Arisæma triphyllum*, *Asparagus officinalis*, *Caladium esculentum*, *Castanea dentata*, *Aesculus hippocastanum*, *Hyacinthus*, *Onoclea sensibilis*, *Osmunda cinnamomea*, *Polystichum acrostichoides*, *Quercus rubra*, *Sarracenia purpurea*, etc. Contrast influence of etiolation by a determination of water content, dried material, ash, starch (by iodine method) duration of etiolated organs and plants, structure of leaves, development of emergences, stomata, lenticels, collenchyma, schlerenchymatous and other histologic structures. Sections can be made by paraffin and celloidin methods, etc.

LESSON 41

Withering, or Wilting of Plants.—When the amount of water given off by plants in transpiration is excessive, the leaves and branches lose their turgescence, become

flaccid and droop, in other words they wilt, or wither. This withering may be due to the lack of water in sufficient quantities, in the soil, or it may be due to the presence of salts of high osmotic equivalent in the soil, which render the absorption of water difficult, or impossible. Plasmolysis may induce wilting.

Experimental Study.—Take two potted plants and wrap the pot in rubber dam, or oiled paper, so as to cover the pot and soil to prevent evaporation from their surfaces. Weigh both potted plants carefully. Water one each day with a measured quantity of water and let the other remain unwatered until the plant begins to wilt, then weigh it carefully to determine the amount of available water transpired. Then knock out the plant and weigh the soil after drying in an oven to determine the amount of hygroscopic water present.

We now make the following very instructive experiment with *Helianthus tuberosus*. We bend down a long shoot without separating it from the plant, and without cracking it, so that a portion 20 cm. from the summit dips into water contained in a vessel placed below it, the summit of the stem and the leaves not being wetted. We cut through the stem with a sharp knife under water, so that the cut surface remains under water. Our shoot keeps fresh for days, while other *Helianthus* shoots cut off in the air, and then at once placed in water, rapidly wither. We may make them turgescient again by placing a withered shoot in the shorter limb of a U-shaped glass tube containing water fixed in place in the tube by a rubber cork fitted air-tight about the stem. Mercury is now poured into the longer limb of the tube and its pressure is sufficient to revive the withered shoot. Consult SHIVE, JOHN W. and LIVINGSTON, B. E.: *The Relation of Wilting Plants*. *The Plant World*, No. 4, April, 1914: 81-129.

Plasmolysis and Wilting.—Prepare 250 c.c. of 0.5 gram-molecular (M) solutions of potassium nitrate and of sodium chlorid as stock solutions. From these solutions make dilutions in small vials, capacity about 25 c.c. to contain the following strengths of each of the above solutions, namely 0.10, 0.20, 0.30, and 0.40 molecular (M); also one vial with distilled water as a control. In each of the dilutions place a seedling of some plant (root as nearly entire as possible) with delicate stem or leaf stalks, such as lettuce, radish or mustard. Water plants can also be used, such as *Elodea gigantea*, *Vallisneria spiralis*, *Trianca bogotensis* and the staminal hairs of *Tradescantea* and the filaments of *Spirogyra nitida*. Observe the dilutions in which wilting occurs and note the time required in the solutions in which it occurs. Compare the equivalent strengths of the two salts (*The Country Gentleman*, Dec. 6, 1913: 1781).

LESSON 42

Methods of Sectioning.—By the time that this lesson is reached some of the plants which have been wounded or have been inoculated with the various bacterial and fungous organisms, or have been treated in various ways experimentally, will begin to show growth reactions. Such material can be studied by the making and mounting of sections. The sections can be made in one of three ways: (1) By free-hand sectioning, the razor ground flat on one side being held in the hand; (2) by the slid-

ing microtome (Fig. 230); (3) by the rotary microtome, the material having been imbedded in paraffin. If desirable, the material to be cut on the sliding microtome

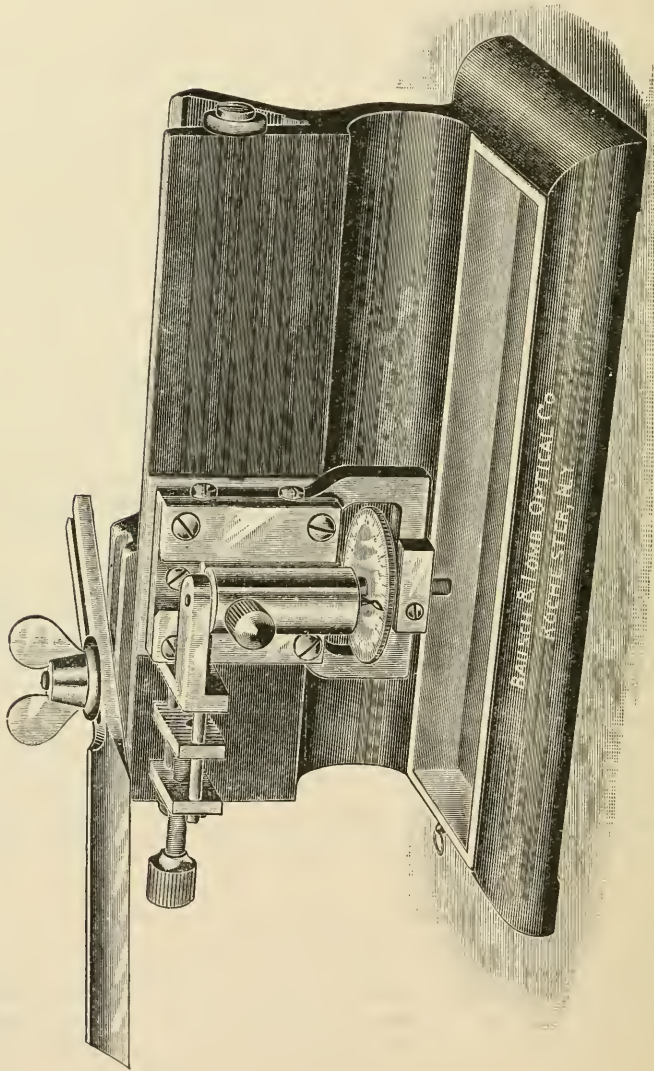

FIG. 230.—Type of automatic sliding microtome used for cutting all kinds of sections.

can be prepared by the celloidin method. Where the sections to be made are of woody material they can be cut directly on the sliding microtome, and the sections,

as fast, as they are cut, should be placed in 50 per cent. alcohol. Where free-hand sections are used they should be placed immediately in 50 per cent. alcohol.

Celloidin Method.—It is customary to use two solutions of celloidin, a “thick” and a “thin.” The thick solution (about 10 or 12 per cent.) should have the consistency of thick syrup. The thin may be made by mixing equal parts of thick and ether alcohol. The material inoculated as described in the preceding lessons is fixed in chrom-acetic acid solution prepared as follows.

Chrom-acetic Acid Fixative.

Chromic acid, 1 gram
Glacial acetic acid, 1 c.c.
Water, 98 c.c.

Flemming's Fluid (Weaker solution).

	{	1 per cent. chromic acid, 25 c.c.
A.		1 per cent. acetic acid, 10 c.c.
		Water, 55 c.c.
B.		1 per cent. osmic acid, 10 c.c.

Keep the mixture *A* made up, and add *B* as the reagent is needed for use, since it does not keep well.

Wash the fixed material carefully in running water for several hours and put into 30 per cent. alcohol, then by successive steps into 50 per cent., 75 per cent., 95 per cent. and absolute alcohol. After dehydrating in absolute alcohol, the succeeding steps are taken.

1. Ether alcohol, 1 to 2 days.
2. Thin celloidin, 2 to 6 days.
3. Thick celloidin, 3 to 10 days.

Use of Alcohols and Celloidin.—The celloidin is dissolved in equal parts of ether and absolute alcohol about 1 part by weight of celloidin to 15 parts of the solvent. After the material is thoroughly penetrated by this solution, it is passed to a stronger solution, containing 1 part of celloidin to 11 parts of the solvent and finally to a solution containing 1 part of celloidin to 8 parts of the solvent. After remaining a suitable time in the last solution, the object is ready for imbedding. For this purpose, a paper strip may be wound tightly about the end of a small block of suitable size and material, so as to form the sides of a box open above, with a bottom the end of the block of wood. This box is now filled with the thickest celloidin solution, and in it the object is placed and oriented carefully by needles wet with the ether-alcohol mixture. As soon as a strong film has developed over the surface of the celloidin, the whole block of material is plunged into 80 per cent. After the celloidin has hardened in the alcohol, the paper ring is removed and the mass is trimmed to the desired size.

In cutting, the block is clamped in the sliding microtome, where the knife is set obliquely, so that the celloidin sections may be cut with a long drawing stroke. The knife and top of the block should be kept wet with 80 per cent. alcohol, and as rapidly as the sections are cut, they should be placed in the alcohol (Fig. 230).

The sections are attached to the slide by placing the slide in a closed chamber

over ether. The ether vapor quickly dissolves the celloidin to cause the sections to adhere firmly to the slide on removal from the chamber. After the removal of the celloidin, the sections can be stained with appropriate stains. For mounting in Canada balsam, celloidin sections may be cleared with a mixture of 3 parts xylol and 1 part phenol.

Paraffin Method.—The fixing and dehydrating of material for imbedding in paraffin is performed in a manner similar to that for work with celloidin up to the dehydration in absolute alcohol. The following schedule should be followed subsequently.

Transfer from absolute alcohol to pure xylol, allowing at least two hours in each of the following three mixtures. $\frac{3}{4}$ alcohol + $\frac{1}{4}$ xylol; $\frac{1}{2}$ alcohol + $\frac{1}{2}$ xylol; $\frac{3}{4}$ xylol + $\frac{1}{4}$ alcohol, xylol. Add to the mixture of paraffin dissolved cold in xylol. Place in melted paraffin in the bath, kept at 55°C ., two to twenty-four hours as convenient. Imbed in paper capsules, or in small shallow glass dishes. Section with rotary microtome; about 6 to 10μ is a good thickness.

See Lesson 43 for details of cutting frozen section by the microtome and the method of freezing each section. Lesson 43 may be introduced here.

Fastening of Sections to Slide.—After cutting, fasten section to slide by using Meyer's albumen, or by the process of drying on the slide after treatment with tepid water to remove the wrinkles.

Dissolve off paraffin in xylol.

Pass down through 100 per cent., 95 per cent., 85 per cent., 70 per cent., 50 per cent., 30 per cent., alcohol, thirty seconds each.

Delafield's hæmatoxylin, fifteen minutes.

Rinse in water five minutes.

Pass up through 30 per cent., 50 per cent., 70 per cent., 95 per cent., and absolute alcohol.

Put in xylol at least one minute.

Mount in balsam.

NOTE.—All of the material obtained in the inoculation experiments should be studied microscopically. The above methods of fixing, imbedding, sectioning and staining are applicable in all of this work.

If time permits, all of the organisms inoculated in the plants should be recovered and in pure culture by the methods outlined in Lesson 22. Direct inoculation of media in plugged test-tubes can be used. A reinoculation of the recovered organisms is desirable, if time permits the class to undertake such additional work.

LESSON 43

Freezing of Material and Cutting.—*Freezing Microtome.*—The material may be imbedded in a thick solution of gum arabic which is frozen on a metal plate cooled to the freezing temperature by conducting under the plate a mixture of ice water and salt. This is accomplished by filling a glass vessel full of a mixture of ice and salt and conducting the water from the jar by a tube (A) through metal a box (B) on which the sections are placed in the mucilage.

The circulation of the ice-salt water is accomplished by allowing it to drip from a small orifice at the end of the glass tube *C*.

The block of frozen mucilage with the contained substance held on the freezing plate is then cut with the hand microtome or with the design of microtome shown on the next page.

Or the material may be frozen in the design of freezing chamber shown on page 659 and sectioned by Spencer automatic laboratory microtome No. 880, as indicated in the accompanying figures. If mucilage is used it can be removed by placing the sections as rapidly as cut in warm water.

CO₂ Freezing Attachment.—The freezing device in this attachment consists of a small metal cylinder. The object is placed on the flat disk top of the cylinder,

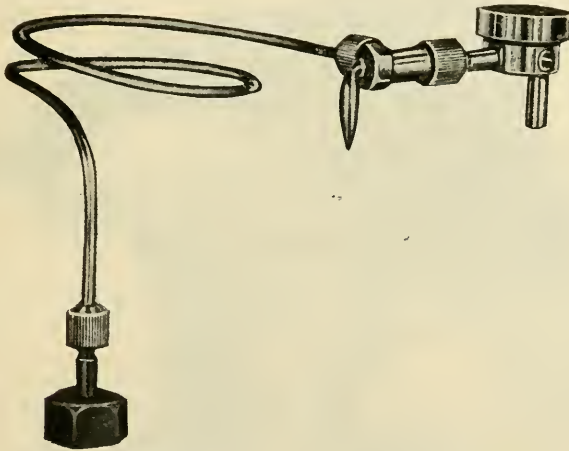

FIG. 231.—Freezing attachment for use of CO₂ in freezing microtome.

which measures 36 mm. in diameter, and is frozen by the expansion of the CO₂. This device is connected with the gas cylinder by a flexible copper tube, provided with a connecting nut for joining to the cylinder and the necessary adapter for fitting to the microtome. It is furnished also with an extra valve, which can be placed at either end of the tube.

CO₂ gas furnishes the most rapid and convenient medium for freezing specimens and can be used in this attachment with either the table or physician's microtome (Figs. 231, 232). An ether attachment is also used (Fig. 233).

LESSON 44

Use of Drawing and Projection Apparatus.—The author has found it an excellent training for students to learn the use of the drawing apparatus designed by Edinger, as well as the new Spencer photomicrographic camera. These pieces of apparatus can be used for drawing, for projection and for photomicrography.

The Edinger drawing and projection apparatus¹ (Figs. 234, 235) projects microscopic objects even under a high magnification directly upon the drawing board so that the outline can be traced in pencil. The image thus projected can be used for demonstrating to a small audience and also for photomicrography. For such work a powerful illuminant is used with a hand-fed electric arc taking 4 amperes. It may be used with a suitable plug connected with the direct-current house supply (alternating current may be used by special arrangement). The crater in the positive

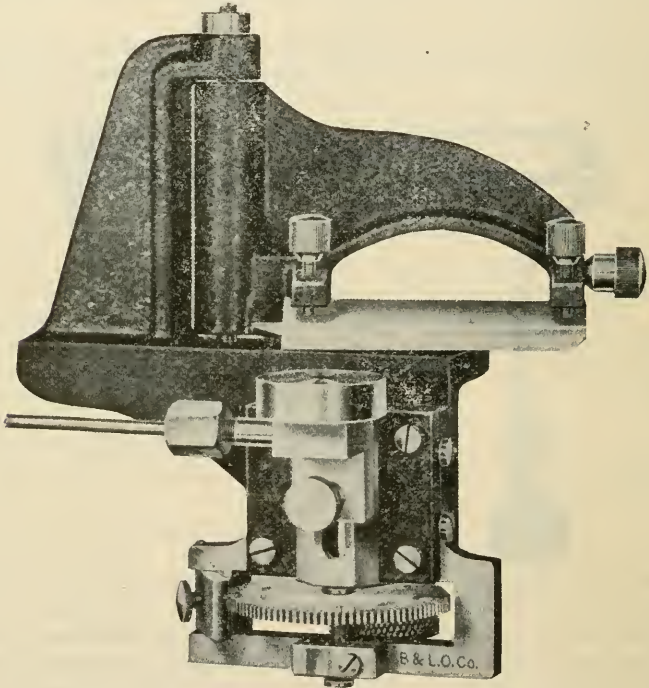

FIG. 232.—Clinic microtome with freezing attachment.

carbon from which light emanates is brought to coincide with the optic axis of the apparatus by means of the two screws (*a*) as in Fig. 234, and the lamp with the condensing system *K* can be moved along the optic axis by the lever *G*. The distance between the carbons is regulated by the milled head (*b*) which if out of reach of the operator can be turned by the long handle connected to (*c*). The smaller carbon which is placed horizontally should not project into the optical axis, or crater area of the larger vertical carbon.

The apparatus proper consists of a cast-iron pillar *S*, Fig. 234, mounted upon a

¹ May be had of E. Leitz, 30 East 18th Street, New York City.

rectangular frame into which a drawing board is fitted. The fitting is grooved to allow the adjustment of the illuminant *L* by the lever *G*, the stage *O*, and the objective holder *H*, the face being graduated to $\frac{1}{2}$ cm. in order that the correct position of the stage *O*, which varies according to the objective in use (see Table A), can be determined. The same table gives the correct size of diaphragm, five accompanying each outfit, viz.: 12, 18, 24, 32 and 46 mm. diameter. The cover-glass faces the objective when the slide with object is placed in position. The objective carrier *H* which has a rack and pinion for coarse adjustment and a micrometer screw for fine adjustment occupies a constant position on the fitting *B*, viz., 1 cm. from the lower

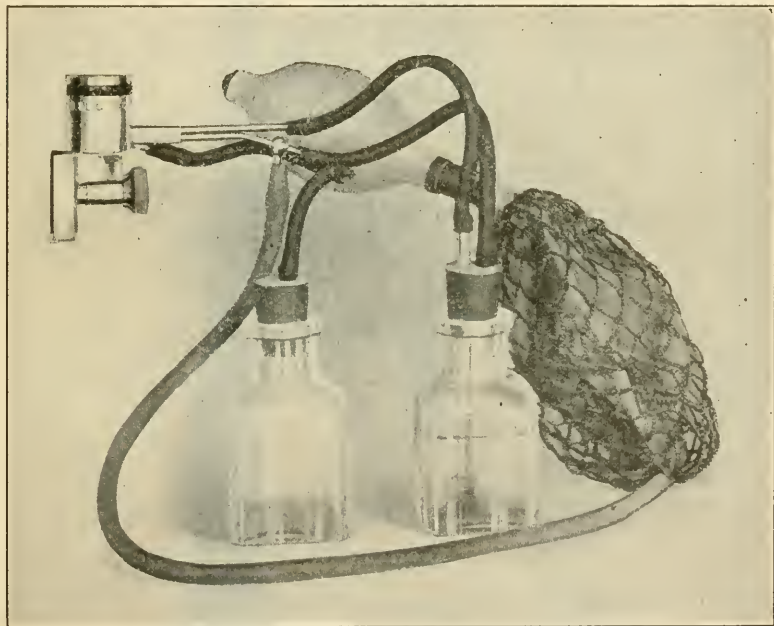

FIG. 233.—Ether or rhigoline freezing attachment for freezing microtome.

end, but can be removed if necessary. The fine adjustment can be controlled by a long rod similar to that used for the setting of the arc.

Above the stage two lenses of different foci are mounted in a swing-out (*K*₂, Fig. 234) which has a sliding focussing adjustment and iris diaphragm, and is so contrived that either of the condensers or the diaphragm only can be interposed in the optic axis. The microscope body *T* can be removed from the fitting *M*, into which it pushes, and the triple nosepiece is mounted on a sliding attachment, so that it can be interchanged from a similar slide carrying the microsummar lenses. The draw tube should always be set at 152 mm. when working with the nosepiece; otherwise, at 170 mm. Should the apparatus be required for projection the whole optical

system can be rotated from the vertical to the horizontal position by pulling out the spring catch *E*, Fig. 234.

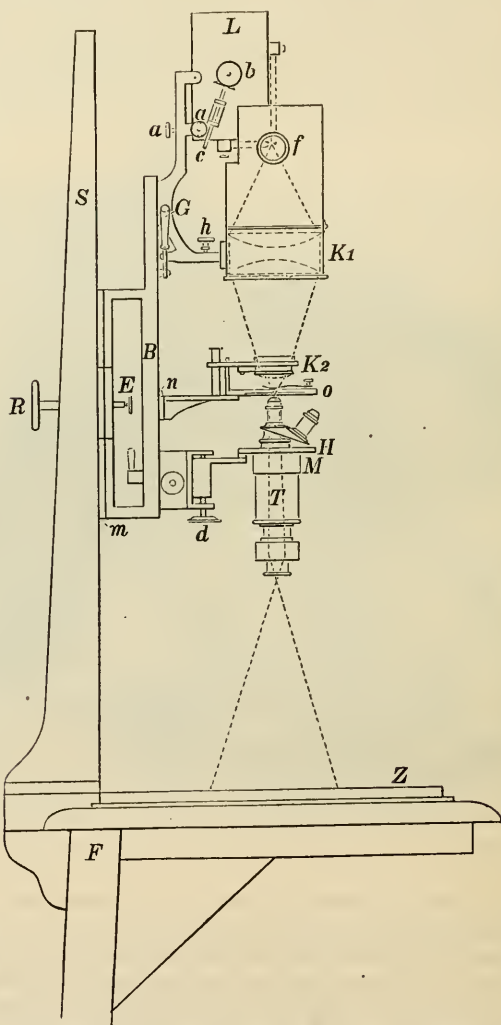

FIG. 234.—Details of Edinger's drawing apparatus. *Z*, Drawing board; *T*, microscopic attachment; *K*₁ and *K*₂ condensers; *L*, electric lamp attachment.

For photomicrographic work a camera is clamped to the pillar *S*, Fig. 234, the plate holder, which will take plates of any size up to 24 by 30 cm., resting on the

drawing board *Z* (Fig. 234). Having determined the camera extension required by means of a special set screw provided, an allowance of 2.8 cm. is made for the height of the plate above the drawing board. The arm clamping the camera to

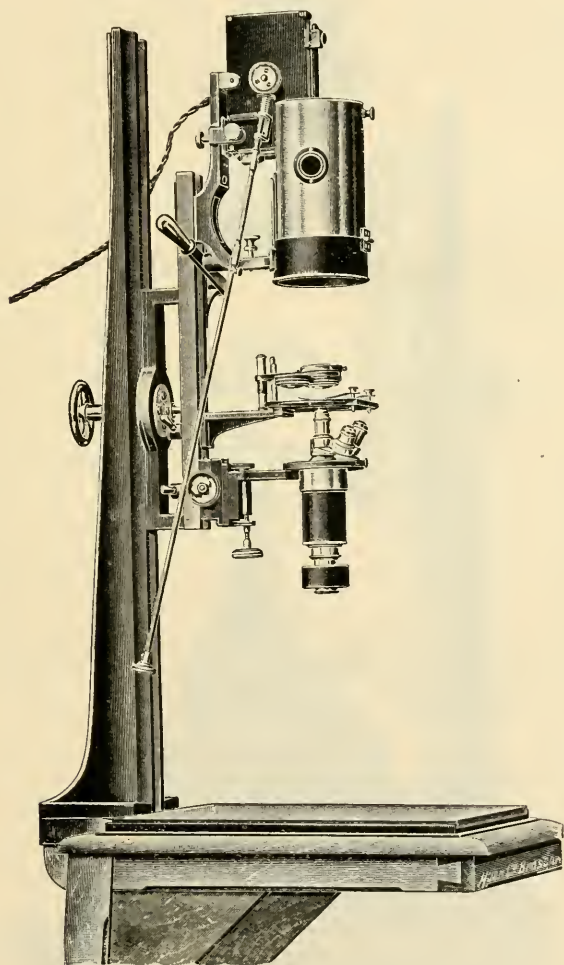

FIG. 235.—Edinger's drawing apparatus arranged for microscopic drawing.

the pillar is then raised until the collar fits over the draw tube of the microscope body *T*, or over *M*, when working with the microsummars, thus ensuring a light-tight connection. It is advisable to support the bellows by the strap pieces shown in

Fig. 236, when extended. Correct focus is determined by the observation of the image upon a paper surface in place of the usual ground glass.

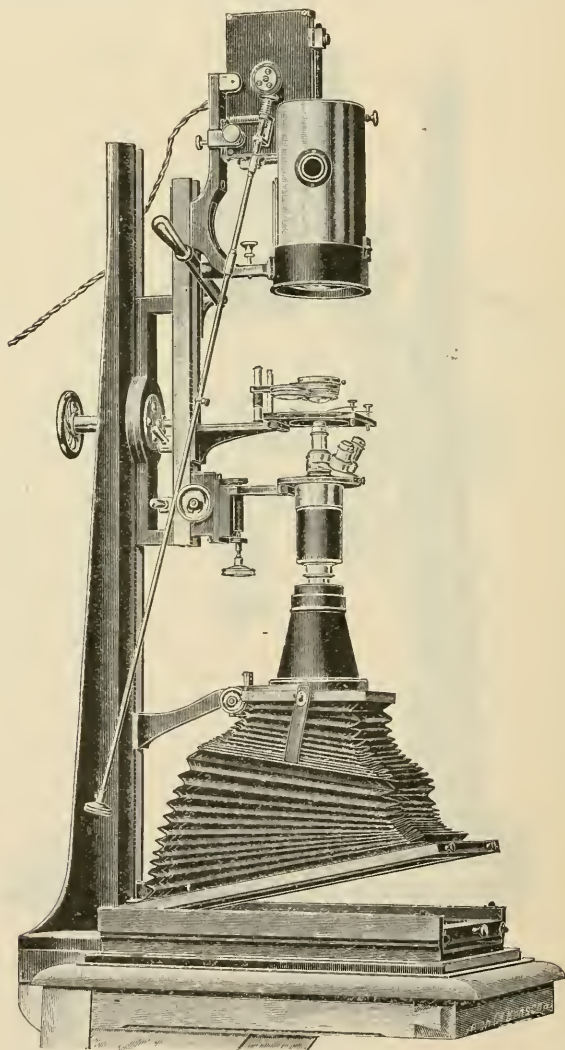

FIG. 236.—Edinger's drawing apparatus with attachment for photomicrography.

The following tables have been prepared with the view of simplifying the use of the apparatus as much as possible, and the best results can only be obtained when

the instructions given for the height of the stage and lamp, and the use of condenser and diaphragm for each objective, are strictly adhered to:

TABLE A

Objective	Height of stage	Position of lamp with condensing lens system	Condenser	Diameter of stage diaphragm	
Microsummar					
80 mm.	18 cm.	As low as possible	Swung-out	46 mm.	
64 mm.	18 cm.		Swung-out	32 mm.	
42 mm.	15 cm.	Midway	Low power	18 mm.	
35 mm.	15 cm.		Low power	18 mm.	
24 mm.	15 cm.		Low power	12 mm.	
Achromatic					
No. 1	17 cm.		Swung-out	12 mm.	
No. 2	15 cm.		Low power	12 mm.	
No. 3	15 cm.	As high as possible	Low power	12 mm.	
No. 4	15 cm.		Low power	12 mm.	
No. 5	15 cm.		High power	12 mm.	
No. 6	15 cm.		High power	12 mm.	

TABLE B.—MAGNIFICATIONS

Of the Microsummars at Definite Distances from the Drawing Board

Microsummar	Distance from drawing board	Magnification
24 mm.	37.5 cm.	20
	13.5 cm.	10
35 mm.	46.0 cm.	15
	21.0 cm.	8
42 mm.	38.0 cm.	10
	16.5 cm.	5
64 mm.	45.0 cm.	8
	21.5 cm.	4
80 mm.	46.0 cm.	6
	24.0 cm.	3

TABLE C

Of the Achromatic Objectives with the Huyghenian Eyepieces at 250 mm. distance from the Drawing Board

Objective	Eyepiece			
	0	I	II	III
1	13	16	19	26
2	23	29	35	46
3	41	51	62	82
4	73	91	109	146
5	133	167	200	267
6	180	230	280	360

If the distance between eyepiece and drawing board = 250 mm. be altered, the magnification of each combination will increase or decrease in proportion. The distance should be read off the scale on the pillar by the aid of the special set square supplied.

Beside the Edinger apparatus there are a good many styles of photomicrographic cameras, but the most recent type is an instrument known as the new Spencer photomicrographic camera, which may be attached to the microscope without disturbing the adjustments. It may be used on its tripod in any position from horizontal to vertical which makes it available for carrying in any ordinary photography. This camera may be used with any microscope, or it may be removed from its support and used for hand-camera purposes.

LESSON 45

TO THE INSTRUCTOR

In connection with the use of the Edinger apparatus the following suggestions as to drawing may be apropos.

The experience of most science teachers has revealed the fact that as a rule beginners in attempting to give an accurate account of their own observations in writing or drawing are in a large measure helpless for want of a definite aim or an understanding of what is required of them and how to do it.

While it is recognized that science teachers naturally differ in the method of carrying out the details of their work, yet it is believed that it will be helpful to the pupil—an economy of his time and effort—if the features which characterize scientific description and drawing in general, be clearly pointed out and impressed at the beginning. It is believed that the following suggestions to pupils can be indorsed by most teachers of Biology and that these suggestions will aid the inexperienced science pupil.

SUGGESTIONS TO STUDENTS

Concerning Notes.

1. The laboratory notes or descriptions should embody only such facts as have been gathered from your own observation and study of the object. Any collateral notes written up from lectures or reading should not be mingled with those of your own observation, but should be kept distinct and under separate headings.

2. The facts observed in the laboratory or field may be gathered first on "scratch paper" as temporary notes and subsequently be written on the note tablet in permanent form; but such temporary notes should be promptly written up and not be allowed to accumulate.

3. The permanent notes or descriptions should be an original account of your own observation. The statements should be scrupulously accurate and free from figurative expression and rhetoric embellishment; the style should be simple, clear and concise.

4. Frequent reference should be made to the drawings and diagrams which accompany the study so that these and the notes may be mutually helpful.

5. The ability to give a clear and accurate account of one's own observations and conclusions is an essential in scientific work, and is also of much value in practical life.

Concerning Drawings and Diagrams.

1. A drawing is intended to show the size and shape of the object, and the proportions and relations of its parts. In case the drawing is to be smaller or larger than the object, the size of the object may be indicated by symbols, as for example: " $\times \frac{1}{4}$ " or " $\times 4$," the former signifying that the drawing is reduced to one-fourth and the latter that it is enlarged to four times the actual size of the object.

2. A diagram is intended to show only the relation of the parts of the object and does not pretend to represent their size, shape or structure.

3. In making either drawing or diagram, do not aim at anything ornamental, or artistic in effect. Let your aim be to represent clearly and distinctly certain facts of your observation.

4. First, carefully examine the object and have definitely in mind what you wish to show in your diagram or drawing and omit everything else.

5. Decide in advance what view of the object you wish to represent and the size of your drawing. If the object be an animal or a plant, represent it whenever practicable in its most natural position.

6. With a fine-pointed hard pencil, make a very faint outline of the object, step by step comparing the drawing with the object, and omitting at first all details. See that the proportions are correct, revising your drawing, if necessary, by substituting new lines and ignoring or erasing old ones.

7. The details may now be worked. Avoid much shading and omit it altogether whenever possible. If the drawing is merely an outline it may be improved by tracing its lines, and the effect of shading may be produced by tracing more heavily those lines which are opposite the direction of the light.

8. In diagrams no shading is needed, but in many cases the use of flat tints, produced with colored pencils or preferably water colors is very helpful.

9. All drawings and diagrams should be accurately and intelligibly labeled. Generally it is also desirable that the parts of the drawing, especially the parts of a diagram, be designated in a way that is convenient for reference.

10. Drawings should be made either entirely in ink, or entirely in pencil, and the lettering also, which should be uniform, not one style, then another.

11. Large headings should be more especially emphasized by larger letters, and the lettering of the larger and smaller headings should be of the same style.

12. All drawings presented to the teacher for examination should be placed between the two sides of a folder of stiff manila paper.

13. The grade of pencil should be determined by the kind of finish or surface of the drawing paper, but in general for science work, the harder grades of lead, say from 4H to 6H, are preferable.

14. The name of the student, the number and the subject, as well as the year, should in all cases be placed on the outside of the manila cover.

Method and Materials of Photomicrography (Fig. 236).—The photographic plates which best meet the requirements in photomicrographic work with the Edinger apparatus are Lumier Sigma 9 by 12 cm. plates, or the ordinary 4 by 5 plates. Another good plate is known to the trade as Seed Special 27.

Whatever plate is used, it is placed in the plate holder of the photomicrographic camera in a dark room, the dull side of the plate being outermost. The holder is then placed in its proper position in the photographic camera. Before the insertion of the holder, however, the object to be photographed must be focussed on the ground-glass plate of the camera until a sharp image is obtained, then the focussing screw should be moved a trifle, say one of the divisions of the screw, so that the object is focussed up a slight amount. The light being regulated properly, the exposure is made by withdrawing the shutter of the plate holder. The length of time to expose the plate can be determined only by several trials until the operator learns the length of time by the experience thus gained.

The most satisfactory developer is made as follows:

Rodinol, 1 part.

Water, 12 parts.

Potassium bromide, 10 drops of 10 per cent. solution.

The advantage of this developer is that the process is sufficiently slow, so that the operator may be able to study the photograph, as it makes itself evident.

After washing in water, the negative is placed in a rather strong hyposulphite solution as a fixing bath. The advantage of rodinol over metol is that the development is more even and sure. Where the photomicrographs have been made obscure, or where it is desirable to convert them into outline drawings for diagrammatic purposes the following method can be used.

Drawings on Photographic Prints.—All pen-and-ink drawings of photographic prints must be made with water-proof India ink after which the photographic part is bleached out by exposure for a few minutes in water containing cyanide of potash (1 : 500, more or less). The drawings should be exposed in this bath as long as necessary. If any part of the print refuses to bleach, it should be moistened with

iodine-potassium iodide and returned to the cyanide bath. It is then passed through pure water and dried face up on blotting paper in a place free from dust.

Bibliography.—For details the student is referred to a book by W. H. WALMSLEY, entitled, *The A B C of Photomicrography. A Practical Handbook for Beginner*. New York, Tennent and Ward, 1902.

Complete details will be found in ERW. F. SMITH'S *Bacteria in Relation to Plant Diseases*, Vol. i: 130-151; BARNARD, J. EDWIN: *Practical Photomicrography*, 1911: xii + 322, London, Edward Arnold; HIND, H. LLOYD and RANGLES, W. BROUGH: *Handbook of Photomicrography*, 1913: xii + 292 with 44 plates, New York, E. P. Dutton & Co.

LESSON 46

The course in mycology will not be complete without the introduction of field trips and excursions which supplement in an important way the laboratory and lecture work, and which will show the student how mycology touches practically the sciences of bacteriology, chemistry, engineering, and the other technologic sciences. Besides the trips into the woods and fields for various kinds of fungi and to the market houses to collect the fungous diseases of the food plants sold there, trips can be planned to include slaughter houses, cold storage plants, meat extract factories and dairies where the cooling, filtration, Pasteurization, and bottling of milk can be demonstrated. Mushroom farms should not be omitted, nor should the farms where vaccine and other biologic products are made be overlooked. Cheese, butter, oleomargarine and soap factories should be included in the schedule, as well as the sugar refineries. The industrial plants where yeasts are employed should be investigated, such as bread bakeries, beer breweries, wine and pressed yeast factories. The establishments where pickles, sour kroust and vinegar are made should not be omitted. The disposal of the sewage of our large cities will pay inspection. The conservation of manure in the city and on the farm, the general problems of soil mycology and the preparation of silage ought to be introduced by the field trips. The health laboratories of our large cities should be included in the itinerary. These are only a few of the places that might be visited profitably near such large cities as Boston, New York, Philadelphia, Baltimore, Chicago, St. Louis, New Orleans, Denver, and San Francisco, and smaller places where manufacturing is important.

References

- BERGEY, D. H.: *The Principles of Hygiene*, Philadelphia, 1914.
COUN, H. W.: *Bacteria, Yeasts and Molds in the Home*, New York, 1903.
FUHRMANN, DR. FRANZ: *Vorlesungen über technische Mykologie*, Jena, 1913.
GILTNER, WARD: *Laboratory Manual in General Microbiology*, New York, 1916.
KOSSOWICZ, DR. ALEXANDER: *Einführung in die Mykologie der Gebrauchs- und Abwässer*, Berlin, 1913.
KOSSOWICZ, DR. ALEXANDER: *Einführung in die Agriculturmykologie*, Berlin.

- KOSSOWICZ, DR. ALEXANDER: Lehrbuch der Chemie Bakteriologie und Technologie der Nahrungs-und Genussmittel, Berlin, 1914.
- LIPMAN, JACOB G.: Bacteria in Relation to Country Life, New York, 1908.
- LÖHNIS, DR. F.: Handbuch der landwirthschaftlichen Bakteriologie, Berlin.
- LAFAR, DR. FRANZ: Technical Mycology, Landon, 1898-1910.
- MARSHALL, CHARLES E.: Microbiology, Philadelphia, 1911.
- PRESCOTT, SAMUEL C. and WINSLOW, CHARLES-EDWARD A.: Elements of Water Bacteriology, New York, 3 edit., 1913.
- ROSEMAN, MILTON J.: Preventive Medicine and Hygiene, New York, 1914.
- WHIPPLE, GEORGE C.: The Microscopy of Drinking Water, New York, 3 edit., 1914.

APPENDIX I

Perhaps what follows may be looked upon by some teachers as hardly forming appropriate laboratory exercises, and, therefore, should be treated as in the nature of appendices. In agricultural and horticultural schools, the manufacture and use of fungicides and sprays may very well form a part of the curriculum designed for laboratory, and especially for field purposes, where in the experimental farm, or garden, the spraying apparatus and its construction can well be experimented with as a regular part of the instruction. Hence the making of sprays is given prominence.

FUNGICIDES.—DEFINITION OF TERMS.—Fungicides are substances which are capable of destroying, or preventing, the growth of spores, or the mycelia of fungi. Germicides are those substances used for a similar purpose with germs, or bacteria. Such materials may be used as a spray, in the form of a powder dusted on the plant, or in the form of a steep into which the plant, or plant part, is dipped. A substance to be useful as a fungicide must not only not injure the plant, but must at the same time destroy or hold in check the parasite. Usually the material is most effective when the fungous parasites can be reached directly by the spray. If the fungus works internally, as the chestnut blight fungus, such fungicides usually do harm to the host without touching the parasite and are, therefore, ineffectual.

The chemic substances used are naturally of a poisonous character and should be used with precautions taken to prevent their injurious effects upon human beings. An up-to-date agriculturist, horticulturist, or orchardist considers the use of fungicides, germicides, or insecticides, as essential, as any of the other major operations on the farm.

For convenience of treatment and ease of reference the following fungicides and insecticides are arranged alphabetically. The formulæ have been taken from a number of reliable sources and they may be considered as dependable in ordinary work.

Ammoniacal Copper Carbonate.—This is not as good for general purposes as Bordeaux mixture. It is used instead of Bordeaux when it is desirable to avoid the spotting of leaves or fruit. It is prepared as follows:

Copper carbonate, 5 ounces.

Strong ammonia (26° Baumé), 2 to 3 pints.

Water to make 50 gallons.

Dilute the ammonia with about 2 gallons of water, as it has been found that ammonia diluted seven or eight times is a greater solvent for copper carbonate than the concentrated liquid. Add water to the carbonate to make a thin paste, pour on about half of the diluted ammonia and stir vigorously for several minutes: allow it to settle and pour off the solution leaving the undisturbed salt behind. Repeat this operation, using small portions of the remaining ammonia water until all the

carbonate is dissolved, being careful to use no more ammonia than is necessary to complete the solution. Then, after adding the remainder of the required quantity of water, the solution is ready for application.

Caution.—Plants likely to be injured by Bordeaux mixture are more susceptible to the clear light-blue solution of ammoniacal copper carbonate, which upon drying leaves little or no stain.

Arsenate of lead is one of the best arsenical insecticides. It has in many cases entirely displaced Paris green orchard spraying, and there are at least three good reasons for its use.

First.—The arsenate of lead has great adhesive qualities. It will not wash off even in heavy showers of rain. Some of the experiments at the Minnesota Experiment Station showed the presence of this arsenate on the leaf in sufficient quantity to kill insects, ten weeks after spraying.

Second.—It can be used in any strength without burning the foliage of the plant sprayed, except peach leaves which are burned, if it is too strong.

Third.—It has some fungicidal properties that are increased when added to lime sulphur. The home-made preparation is made as follows:

22 ounces acetate of lead (sugar of lead) dissolved in 2 gallons of warm water in a wooden pail.

8 ounces arsenate of soda dissolved in 1 gallon water in another wooden pail. These two solutions are poured together and make sufficient quantity of poison for 50 gallons of spray.

Arsenite of Lime.—A home-made preparation much cheaper than Paris green and just as good. It is prepared as follows:

White arsenic, 1 pound	}	Stock solution
Crystal sal soda, 4 pounds		
Water, 1 gallon		

Boil these in an iron kettle for twenty minutes until thoroughly dissolved. The kettle must be kept exclusively for this purpose. The soluble material obtained is arsenite of soda and can be stored away in jugs or bottles, labeled poison, for future use. For 40 or 50 gallons of spray, take $1\frac{1}{2}$ to 2 pints of this solution, and 4 pounds of freshly slaked lime. Dilute the lime and stain; then add the stock solution. Pour into the spray barrel, and it is ready for use.

Bordeaux Mixture.—This is the most valuable fungicide in use for combating plant diseases and consists of a mixture of copper sulphate (blue stone) and stone lime slaked in water. It is used in various strengths.

Standard Bordeaux Mixtures (Fig. 237) (6-4-50 formula).

Copper sulphate, 6 pounds.
Lime, 4 pounds.
Water to make 50 gallons.

This mixture can be used successfully on many plants, but on others like the peach and Japanese plum, it injures the foliage. It also sometimes russets the fruit of apples and pears. It can be increased in strength for certain purposes by reducing

the proportion of water, but the formula given above has been regarded as the standard with which all others should be compared, at least in experimental work.

The 5-5-50 Formula.—Here the preparation consists of

Copper sulphate, 5 pounds.
Lime, 5 pounds.
Water to make 50 gallons.

The use of this formula is desirable where the purity of the lime is in doubt, as it makes certain, with lime of any reasonable quality, that all of the copper is properly neutralized. The danger of scorching, or russetting fruit is, therefore, less. Withholding 1 pound of the copper sulphate also cheapens the mixture by a few cents. For these reasons the 5-5-50 formula has come to be quite generally used in orchard spraying. In fact, it has almost replaced the old standard Bordeaux mixture in spraying for the apple scab, bitter-rot, pear and cherry leaf-blight and similar diseases.

The 4-4-50 and Other Formulas.—The strength of the mixture is often further reduced by using the 4-4-50 formula, but it is questionable whether it pays to reduce the strength. For use as a whitewash, a very concentrated mixture, 6-4-20, may be desirable and for certain diseases Bordeaux mixture can be diluted so as to be equivalent to 6-4-100.

The form of Bordeaux mixture most harmless to foliage is 3-9-50, having a considerable excess of lime. This may be known as the "peach Bordeaux mixture."

Various modifications of the original Bordeaux mixture have been suggested and tried. The principal ones, however, are the "soda Bordeaux mixture" and the "potash Bordeaux mixture." The former consists of 6 pounds of copper sulphate, 2 pounds of caustic soda and 50 gallons of water. The latter is the same except an equal quantity of caustic potash is substituted for the soda. Other materials are sometimes added to Bordeaux mixture to increase its spreading power. The most successful is ordinary hard soap, dissolved in hot water and added at the rate of 4 pounds to the barrel, and this modified Bordeaux mixture is known as "soap Bordeaux."

Bordeaux Resin Mixture (N. Y. (Geneva) Bull. No. 188, 1900).

Resin, 5 pounds.
Potash lime, 1 pound.
Fish oil, 1 pint.
Water, 5 gallons.

Add to Bordeaux as directed below. To prepare a stock resin solution proceed as follows: "Place the oil and resin in the kettle, heating them until the resin is dissolved, then remove the kettle from the fire and allow the mass to cool slightly, after which the solution of lye is added slowly, the whole being stirred while adding the lye. After adding the lye the kettle should be again placed over the fire and the required amount of water added. The whole should be boiled until the solution will mix with cold water forming an amber-colored solution. Care should always be taken to have the resin and oil cool enough, so that when the solution of lye or the water is added the whole mass will not boil over and catch fire.

"Dilute this stock resin solution with 8 parts of water before adding to the Bordeaux mixture, that is in preparing a 50-gallon barrel of the mixture, the copper sulphate and lime are diluted enough to make 40 gallons after which 2 gallons of stock resin solution are diluted to 10 gallons, then added to the Bordeaux."

This solution exceeds ordinary Bordeaux in adhesive properties and has been highly recommended for asparagus rust.

Method of Making Small Quantities of Bordeaux Mixture.—Two half-barrel tubs are made by sawing a barrel through the middle. One tub is used for the blue-stone solution and the other for the milk of lime, and each tub should contain 25 gallons. One man dips the blue-stone solution with a bucket and pours it into a barrel and another man simultaneously dips up and pours in bucketfuls of the milk of lime.

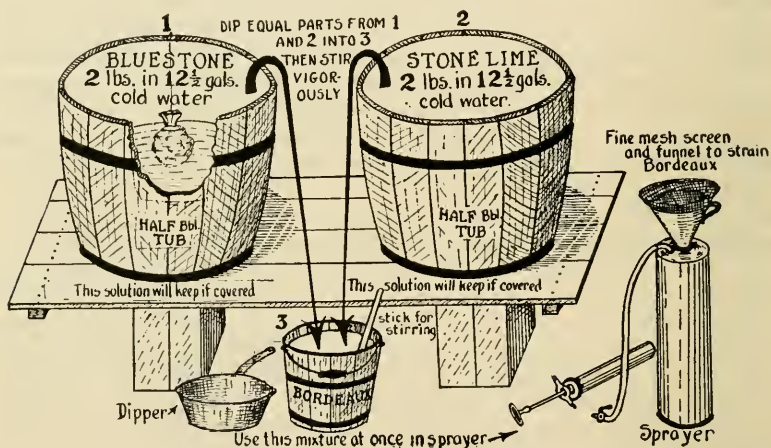

FIG. 237.—Diagram showing easy method of making small quantities of Bordeaux mixture. (After Coons, G. H., and Levin, Ezra, *Spec. Bull.* 77, *Mich. Agric. Coll. Exper. Stat.*, March, 1916.)

The lime solution should be kept well stirred. If only a single barrel is to be made, the materials may be dissolved in the dilution tubs, but if a number of lots are required the materials can be kept in stock solutions and simply transferred by dipping. No matter what quantity of mixture is to be made up, it is necessary to strain the materials through a wire strainer. The best type is made of brass wire with 18 to 20 meshes to the inch (Fig. 237). For details see WAITE, M. B.: Fungicides. *U. S. Farmers' Bull.* 243 (1906).

In large operations stock solutions should always be used, as the time required to dissolve the material is saved. These can be prepared of both copper sulphate and the lime. Dissolve copper sulphate in water at the rate of 1 pound per gallon and lime in the same ratio. Then measure off the required quantity of each and dilute with water before mixing. If possible the dilution tanks should be raised so high on an elevated platform that the mixture can be conducted by gravity into the spray tank on wheels or in a wagon beneath. An available water supply is necessary.

Testing Bordeaux Mixture.—When Bordeaux mixture is properly prepared it is of a brilliant sky-blue color. If the lime is air-slaked, or otherwise inferior in quality, resulting in a bad mixture, the preparation will have a greenish cast, and if this is very pronounced the mixture will injure the foliage. In order to make certain that the copper sulphate is properly neutralized by the lime, the yellow prussiate of potash test may be used. A small bottle containing a 10 per cent. solution of yellow prussiate of potash can be secured from a druggist. After stirring the Bordeaux mixture a drop of this solution is allowed to fall on the surface of the preparation. If free copper is present, the drop will turn reddish brown in color immediately. Lime should then be added until the brown color fails to appear. If the reaction is complete, the yellow prussiate of potash solution will remain a clear yellow until it disappears in the mixture.

Bordeaux Mixture and Insecticides.—One advantage of Bordeaux mixture is the possibility of adding arsenical insecticides to the preparation and thus of spraying at the same time for fungous diseases and for the codling-moth and leaf-eating insects. Paris green at the rate of $\frac{1}{4}$ pound to 50 gallons of Bordeaux mixture, may be considered as the standard formula for this purpose. London purple, arsenate of lead and other arsenicals may be used in the same way. Bordeaux mixture may be considered as so much water in the formulas for this class of insecticides. As a matter of fact, the slight excess of lime in the standard mixture renders it an especially suitable medium for distributing these insecticides.

Dust Bordeaux Mixture.—This mixture is prepared as follows:

- 4 pounds of copper sulphate in 4 gallons of water.
- 4 pounds of lime in 4 gallons of water.
- 60 pounds of slaked lime dust.

Dissolve the 4 pounds of copper sulphate in 4 gallons of water and slake 4 pounds of lime in 4 gallons of water, when cold pour the two solutions together simultaneously into a tub. Allow the resulting precipitant to settle, decant off the liquid, pour the wet mass of material into a double flour bag, and squeeze out as much water as possible. Then spread the dough-like mass in the sun to dry. After a day's drying it can be crumbled easily into an impalpable powder by crushing with a block of wood. This powder should be screened through a brass wire sieve having at least 80 meshes to the inch and should be mixed thoroughly with 60 pounds of slaked lime dust. The lime dust is best prepared by slowly sprinkling a small quantity of water over a heap of quick lime, using barely enough water to cause the lime to crumble into a dust. The heat generated will soon drive off the excess of moisture, and the dust should be passed through a screen of 80 meshes to the inch. This powder is applied by means of a blower. If desired 4 pounds of sulphate and 1 pound of Paris green may be added to each 60 pounds of Bordeaux mixture dust. For details, consult WAITE M. B.: Fungicides. U. S. Farmers' Bull. No. 243 (1906).

Copper Sulphate Wash.

- Copper sulphate, 3 pounds.
- Water, 50 gallons.

This is used as a wash on dormant trees, for the prevention of such diseases as apple scab. It must never be used on trees after the buds have burst.

Copper Acetate.

Copper acetate (dibasic acetate), 6 ounces.

Water, 50 gallons.

First make a paste of the copper acetate by adding water to it, then dilute to the required strength. Use finely powdered acetate of copper, not the crystalline form. It may be used as a substitute for copper carbonate mixtures.

Copper Saccharate.—Consult FREEMAN, E. M.: Minnesota Plant Diseases, p. 220.

Corrosive Sublimate.

Mercury bichloride (corrosive sublimate), 2 ounces.

Water, 15 gallons.

This is an extremely poisonous mixture and should be handled with great care. It is very effective against potato scab. It should not be made in tin vessels, as it corrodes them.

Formalin.

Formalin (40 per cent. formaldehyd), $\frac{1}{2}$ pound.

Water, 15 gallons.

This is used in treating seed for prevention of such diseases as potato scab.

Iron Sulphide Mixture.—This is a new, but very promising fungicide. It was tried on apples, and gave splendid results in preventing fungous diseases, being non-injurious to the fruit. In preparing this fungicide, it is recommended that a self-boiled lime-sulphur mixture be prepared, as later described, except that 10 pounds of lime and 10 pounds of sulphur are used. The mixture is diluted to 40 gallons, and then 3 pounds of iron sulphate (copperas) dissolved in about 8 gallons of water, is added.

Potassium Sulphide (Liver of Sulphur).

Potassium sulphide, 3 to 5 ounces.

Water, 10 gallons.

This is used in place of Bordeaux mixture to avoid spotting of foliage and fruit. It is considered to be especially effective against powdery mildews. It is quite extensively used in greenhouses and on shrubbery.

Sulphur.—Is used as a fungicide in a pure state. The flowers of sulphur is the highest and usually the purest chemically. It is dusted on plants as a remedy for mildew, especially the rose mildew and the powdery grape mildew.

Sulphur and Resin Solution.—It is made up as follows:

Sulphur (flowers, or flour), 16 pounds.

Resin (finely powdered), $\frac{1}{2}$ pound.

Caustic soda (powdered), 10 pounds.

Water to make 6 gallons.

Place the sulphur and resin, thoroughly mixed, in a barrel or smaller vessel,

and make a thick paste by the addition of about 3 quarts of water. Then stir in the caustic soda. After several minutes, the mass will boil violently, turning a reddish-brown, and should be stirred thoroughly. After boiling has ceased, add about 2 gallons of water and pour off the liquid into another vessel, and add to it sufficient water to make 6 gallons. This form of stock solution may be used at the rate of 1 gallon to 50 of water for spraying most plants and for soaking seeds.

Eau Celeste (Modified).—It is made as follows:

Copper sulphate,	4 pounds.
Ammonia,	3 pints.
Sal soda,	5 pounds.
Water to make	45 gallons.

Dissolve the copper sulphate in 10 or 12 gallons of water, add the ammonia, and dilute to 45 gallons; then add the sal soda and stir until dissolved. Eau celeste is an effective dormant spray for the peach leaf-curl and other similar diseases, but it is unsafe to use on the foliage of most plants.

Potassium Permanganate. (Not used in the United States.)

Potassium permanganate,	1 part.
Soap,	2 parts.
Water,	100 parts.

Recommended in France for black-rot and mildew of grape, etc.

Iron Sulphate and Sulphuric Acid.

Water (hot),	100 parts.
Iron sulphate, as much as will dissolve.	
Sulphuric acid,	1 pint.

Prepare the solution just before using. Add the acid to the crystals and then pour on the water. Valuable for treatment of dormant grape vines affected with anthracnose, applications being made with sponge or brush from wooden vessels in which it is made. The solution will destroy the foliage, so it must be used in late fall, or early spring, or applied only to tree trunks.

Lime-sulphur.—Within the last few years this wash has come into prominence as one of the best scale insecticides discovered. Several forms of it are excellent fungicides. Three formulæ are here given.

The Boiled Mixture (home-made).

Best stone lime,	15 pounds.
Flowers of sulphur,	15 pounds.
Water,	15 gallons.

Slake the lime in a small quantity of hot water, add the sulphur gradually and stir thoroughly. Dilute the mixture to 15 gallons with water, and boil in an iron kettle, or cook by steam in a barrel for forty-five minutes. Fill the vessel with water to the required 50 gallons; strain the wash through a fine-mesh strainer and apply

hot. This wash should be applied in the fall after the leaves have dropped, or in the spring before the buds open. Spray thoroughly, covering all parts of the tree.

Concentrated Mixture.

Sulphur,	80 pounds.
Best stone lime (95 per cent. calcium oxide),	40 pounds.
Water,	50 gallons.

Live steam run in a barrel, or fire under an iron kettle may be used in boiling. Place 5 gallons of water and 40 pounds of the sulphur in the vessel, and apply heat until the sulphur becomes a smooth paste, stirring constantly. Now add 10 gallons of water and 20 pounds of lime and boil for forty-five minutes. Add water to make 25 gallons. When cooled to 35°F. test with Baumé scale; the reading should be about 33°F. As a scalecide to use in the dormant season, this should be diluted 1 to 10 (*i.e.* 1 part of the above formula diluted with 9 parts of water) and 6 to 10 pounds of stone lime added to every 50 gallons of the spray. As a fungicide for summer use, dilute 1 to 30 (1 part of stock solution to 29 parts of water). When stored away it is best to cover the solution with a layer of oil about an eighth of an inch thick. This will prevent evaporation and the forming of a crust on the material. The material should not be stored where the temperature will go very low.

Self-boiled Lime Sulphur.

Lime,	8 pounds.
Sulphur,	8 pounds.
Water,	50 gallons.

This spray is valuable in cases where Bordeaux is injurious to foliage or fruit. The stone fruits, such as plums, are particularly susceptible to Bordeaux injury, while some varieties of apples are badly russeted by it. There is slight danger of injury by the self-boiled lime-sulphur preparation, and it is an efficient fungicide when properly made. It stains the fruit as does Bordeaux. In making it 8 pounds of lime of good quality should be placed in a barrel, and enough water to nearly cover it should be added. While the lime is slaking, add sulphur which has run through a sieve to break up the lumps. The sulphur should be stirred thoroughly into the slaking lime, enough water being added to make a pasty mass. The barrel should now be covered, in order to retain its heat, and the contents should be occasionally stirred. The time required varies with the quality of the lime; if the lime acts quickly, five to ten minutes would be sufficient, while if it acts slowly, fifteen minutes may be necessary. It should not be allowed to stand too long, because it may in that case be injurious to foliage. Now add water, stirring the mixture while it is being poured in. Then add enough water to bring the total up to 50 gallons. In applying the spray, it is necessary to have a good agitator in the sprayer. Consult RUGGLES, A. G., and STAKMAN, E. C.: Orchard and Garden Spraying. Bull. No. 121, Agric. Exper. Sta. Univ. Minn., March, 1911. Also DUGGAR, B. M., and COOLEY, J. S.: The Effect of Surface Films and Dusts on the Rate of Transpiration. Ann. Mo. Bot. Gard., I: pp. 1-22, March, 1914.

Lime-sulphur Salt Wash.—This wash, although rarely used, is made as follows:

Lime, unslaked,	20 pounds.
Sulphur (flour, or flowers),	15 pounds.
Salt,	10 pounds.
Water to make	50 gallons.

Many different formulas are used in making up this wash but the above formula seems to be the best, and has been extensively used. If the lime is high-grade stone lime, 15 pounds will be sufficient to dissolve all the sulphur. With average lime 20 pounds is the better quantity, but with poor or partly air-slaked lime 25 to 30 pounds are necessary. Lime absorbs an equal weight of water in becoming air-slaked.

To prepare small quantities of this wash proceed as follows: Place about 10 gallons of water in an iron kettle over a fire, make the sulphur into a paste with a little water, and when the boiling point is nearly reached add the fresh lime and the sulphur together. The mixture should be constantly stirred, and the boiling continued for forty to sixty minutes. The object of the cooking is to dissolve the sulphur and when this is accomplished further boiling is useless, but not harmful. The salt may be added at any time during the process of boiling, or entirely omitted. It is generally conceded, however, that salt increases the adhesiveness of the wash, as it does ordinary lime whitewash, and for this reason, it is perhaps advisable to use it, although it is not supposed to strengthen the fungicidal property of the mixture. Possibly also the salt hastens the solution of the sulphur by raising the boiling point, or by its solvent action.

It has been found that the sulphur dissolves more readily in a concentrated mixture with lime, and the quantity of water used during the process of boiling should, therefore, be reduced to a minimum. The mixture should not be allowed to become pasty, however, and water, preferably hot, should generally be added until the barrel is nearly full when finished. When the cooking is completed, pass the mixture through an iron wire strainer (not brass or copper), and dilute with the required amount of water. For details, see WAITE, M. B.: *Fungicides and Their Use in Preventing Diseases of Fruits*. U. S. Farmers' Bull. No. 243 (1906).

The wash may be applied either hot or cold with practically the same results, though the warm mixture is less likely to clog the nozzles. If allowed to stand over night, sulphur crystals will form on the bottom and sides of the containing vessel. It is difficult to dissolve the lime-sulphur crystals after they have once formed. For this reason, it is better not to prepare more than can be used the same day.

STEPS.—Solutions in use for dipping seeds, fruits and the like in order to control, or check fungous diseases.

Formalin.—(A) For oat smut and stinking smut of wheat. Add $\frac{1}{2}$ pound of formalin to 30 gallons of water and immerse the seed grain for two hours, then spread out and dry: or sprinkle the grain with the formalin solution until thoroughly wet, shoveling over rapidly to distribute the moisture evenly, then place in a pile (covered with sacking) for two hours and finally spread out to dry as in the first method.

(B) For potato scab. The formalin treatment of seed potatoes practically frees

the seed from scab with slight expense and trouble. Add $\frac{1}{2}$ pound of formalin to 15 gallons of water and immerse the seed tubers for two hours. The seed tubers are then spread in thin layers to dry promptly. After removing from the solution, cut and plant as usual.

Hot Water Method for Smuts (Jensen) (consult Freeman, E. M.: Minnesota Plant Diseases, p. 225).—Provide two large vessels, preferably holding at least 20 gallons. Two wash kettles, soap kettles, wash boilers, tubs or even barrels, will do. One of the vessels should contain warm water, say at 110° to 120° F. and the other scalding water, at 132° to 133° F. The first is for the purpose of warming the seed preparatory to dipping it into the second. Unless this precaution is taken, it will be difficult to keep the water in the second vessel at the proper temperature. A pail of cold water should be at hand, and it is also necessary to have a kettle filled with boiling water from which to add from time to time to keep the temperature right. Where kettles are used, a small fire should be kept under the kettle of scalding water. The seed which is to be treated must be placed, half a bushel or more at a time, in a closed vessel that will allow free entrance and exit of water on all sides. Hence a gunny bag, or sac, can be used for this purpose. Now dip the basket, or bag, of seeds into the water at 110° to 120° F. and lifting it out plunge it into the second vessel containing water at 132° to 133° F. After removing the grain from the scalding water, spread it on a clean floor, or piece of canvas to dry.

Corrosive Sublimate.

Corrosive sublimate, 2 ounces.

Water, 15 gallons.

Dissolve the corrosive sublimate in 2 gallons of hot water, then dilute to 15 gallons, allowing the same to stand five or six hours, during which time thoroughly agitate the solution several times. Place the seed potatoes in a sack and immerse in the solution for one and a half hours, and then spread to dry.

INSECTICIDES USED TO KILL INSECTS

Carbon Bisulphid.—This inflammable and volatile liquid is used against grain weevils and against the insects that are destructive to herbarium specimens.

Crude Petroleum.—This is an oily inflammable liquid used against scale insects.

Hellebore.—This is a stomach or internal insecticide. It is not poisonous to man as are the arsenical insecticides, and is used where there is danger of poison remaining on parts to be eaten. It is often used on currants and gooseberries when the berries are beginning to ripen. It is used in the dry form, and must be fresh when used.

Hydrocyanic Gas.—This gas is made by dropping potassium cyanide into sulphuric acid and water. The fumes are deadly to all kinds of animal life, and the gas is used only in special cases.

Kerosene.—This is an excellent contact insecticide. Pure kerosene, however, will ordinarily burn the leaves of plants, consequently it is used in pure form when trees are dormant, or against insects off of plants as grasshoppers, household insects, etc.

Kerosene Emulsion.—This is probably the best form in which kerosene can be used. A stock emulsion is made as follows:

Hard laundry soap (shaved fine),	$\frac{1}{2}$ pound.
Water,	1 gallon.
Kerosene,	2 gallons.

Dissolve the soap in boiling water, remove from the stove, and immediately add the kerosene; churn with a bucket pump until a soft, butter-like, clabbered mass is obtained. One part of this stock is added to 10 to 12 of soft water. If the stock solution is properly made this can be used on tender foliage of plants for such insects as plant-lice, etc.

Lime Sulphur.—See ante.

Miscible oils are those that will mix with water. There are several oils on the market that are miscible in water. These make a good winter spray for scales and are also excellent summer sprays against the same insects. Great care, however, must be taken to get the right dilution, or burning of the leaves will result.

Paris Green is used by many where an arsenical insecticide is necessary. It is generally used at the rate of 1 pound to 50 gallons of spray. In using, always first make a paste of the Paris green and water, and then add to the spray material.

Pyrethrum, or *Insect Powder* (Persian insect powder, Dalmatian powder, or Buhach).—This is a powder from the ground-up flowers of the pyrethrum plant. It is a contact insecticide and is used against fleas, cockroaches, etc. If the powder is burned in a room the fumes will destroy mosquitoes and flies.

Resin Lime Mixture.—Used with a fungicide, or insecticide, to insure sticking of poisonous material to smooth, glossy leaves.

Pulverized resin,	5 pounds.
Concentrated lye,	1 pound.
Fish, or other animal oil,	1 pint.
Water,	5 gallons.

Place the oil, the resin and 1 gallon of water in an iron kettle and heat until the resin softens; then add the lye and stir thoroughly. Add to this 4 gallons of hot water, and boil until a little mixed with cold water gives a clear, amber-colored liquid. Add water to make up to 5 gallons. This is a stock solution. In spraying with Paris Green, or Bordeaux mixture, take 2 gallons of this mixture, dilute it to 10 gallons, and add 40 gallons of spray.

Scap.—Ordinary soap is a valuable contact insecticide.

Ivory soap,	1 pound.
Water,	14 gallons.

Boil the soap in 5 to 6 gallons of water until dissolved, dilute with water to 14 gallons and spray while still warm. It is recommended for plant-lice, red spiders, etc.

Sulphur.—Flowers of sulphur is often dusted on ornamental plants to prevent such diseases, as powdery mildews, and spots, 2 parts of sulphur and 1 part of air-slaked lime.

Tobacco is a very important contact insecticide. As a powder it is one of the best remedies for root-lice on trees. As a decoction it may be used as a spray against plant-lice. Tobacco smoke kills soft-bodied insects.

Whale Oil Soap (Fish-oil Soap).—This is a commercial product, and is a good contact insecticide, particularly for soft-bodied insects, like plant-lice.

APPENDIX II

SPRAY CALENDAR (OHIO AGRICULTURAL EXPERIMENT STATION, BULL, 232)

What to spray	For what to spray	With what to spray	When to spray				Remarks and cautions
			First spraying	Second spraying	Third spraying	Fourth spraying	
Alfalfa.....	Leaf spot.....	Possibly Bordeaux on seed crop.	Bordeaux spraying at intervals of 2 or 3 weeks.	Can be used only on seed crop.
	Sclerotium wilt	Remove and burn infected stools.	Remove on sight, roots and all.	
Apple.....	Canker.....	Prune, remove diseased parts, dress with asphaltum 300° M.P.	Cut out and burn cankers or diseased branches. Treat wounds with asphaltum melting point 300° F.	Blister Canker is a wound parasite. Wound dressings of all but very smallest pruning wounds with asphaltum required when active.
	Bitter rot.....	Bordeaux II or No. 7½ and Ammoniacal Cop. Carbonate.	With first appearance of rot about July 1st Bord. II or No. 7½.	One to two weeks after first Ammoniacal Cop. Carbonate.	Two weeks later.	Not required if Bordeaux precedes.	These follow sprays for scab; danger on fair-skinned apples.
	Blotch.....	Bordeaux II or No. 7½ and Ammoniacal Cop. Carbonate.	July 1st Bordeaux II or No. 7½.	Two weeks later Ammoniacal Cop. Carb.	Two to three weeks later.	These sprays follow spraying for scab.
	Black rot.....	Probably 7½ on red apples.	Same as bitter rot.	For black rot follow scab sprays closely, using Bordeaux and Iron Sticker as long as safe.
	Frog eye.....	Same as bitter rot and blotch.	See bitter rot.	
	Rust.....	Same as scab and bitter rot.	Same as scab and bitter rot.	
	Scab.....	Bordeaux I or lime-sulphur.	Just before blossoms open, Bordeaux I.	Just after blossoms drop, I. No. 7 or lime-sulphur.	Same 7 to 10 days later.	Rarely needed.	The spray just before the blossoms open is very essential for scab. Bordeaux advised for first application on varieties susceptible to scab. On Ben Davis and Baldwin lime-sulphur good for second and third.
	Sooty fungus.....	No. 7½ or Bord. II....	After blossoms drop (see scab).	Two weeks later.	Same as Bordeaux for scab.	Bordeaux II or No. 7.	Mildewer copper sprays needed where lime sulphur is used early in season (see blotch).

What to spray	For what to spray	With what to spray	When to spray				Remarks and cautions
			First spraying	Second spraying	Third spraying	Fourth spraying	
Apple continued.	Twig blight....	Cut out and burn on appearance.	Cut out and burn on appearance.	Bacterium lives over in blight cankers.
	Bud moth.....	Arsenicals in Bord. or lime-sulphur solution...	With opening of buds...	
	Canker worm...	Arsenate of lead alone.	With first young worms.	2 or 3 days later if worms remain	Same as second.	20. 21. or 22 in Bordeaux are not quite as efficient as arsenate of lead alone.
	Blister mite (see pear).	Band with tree tangle-foot.	Bands should be in place by Feb. 15th.
	Codling moth...	Arsenites or arsenates in Bordeaux I or 7 or lime-sulphur solution with arsenate of lead 3 lbs. to 50 gallons Same as above.....	As soon as blossoms appear.	7 to 10 days later.	Second week in July.	Last week in July. Arsenate of lead alone on light colored apples. Same as above.	In case of bad infestation spray in fall and repeat in spring.
	Curculio.....	Same as above.....	Late in winter, early spring or late in fall.	{ Don't use strong emulsion or oil when trees are in full leaf.
	San José scale...	Lime-sulphur or 19.....	
	Oyster shell scale.....	{ Lime sulphur } { Kerosene emulsion } { or 19.	{ Early spring with 14. } { }	June 1 to 15 with lime sulphur or 13 or 19.	Foroystershell scale Aug. 1 to 15 with 13 or 19.	
	Woolly aphid...	Kerosene emulsion...	When trees are in full leaf.	In fall.	
Aster.....	Fusarium wilt...	See seed and soil treatment.	Use 1 pound soap to 6 gallons water.
	Blister beetle...	Whale oil soap, or dilute chloro-naphtholeum.	When beetles appear.	Do not use arsenicals, except in late summer.
Asparagus . . .	Asparagus beetle	Air-slaked lime or pyrethrum as a powder.	When larvæ appear.	Same as first.	Repeat 3 or 4 times. Burn rusted brush in fall.
	Asparagus rust.	Bordeaux I.....	After cutting crop....	Ten days later.	Ten days later.	Ten days later.	Repeat if needed.
Bean.....	Anthraxnose....	Bordeaux I.....	Soak seed one to two hours in am. cop. carb. 5 times strength of 3.	Bordeaux on 2 or 3 in. plants	Bordeaux 10 days later.	After blossoms.	

SPRAY CALENDAR—(Continued)

What to spray	For what to spray	With what to spray	When to spray				Remarks and cautions
			First spraying	Second spraying	Third spraying	Fourth spraying	
Bean continued.	Rust.....	Burn old plants.....	Destroy diseased pods.	Select resistant varieties.
Beet.....	Leaf-spot.....	Bordeaux I.....	When plants are 5 to 6 inches high.	Two weeks after first.	Two weeks later.
	Damping-off....	See soil treatment.
Cabbage and cauliflower.	Black-leg.....	See soil treatment.	With first appearance of worms.	Whenever worms are observed.	Same as second.	Same as second.	1 oz. to 30 gallons water or dust 1 to 10 of flour.
	Cabbage worm.	Pyrethrum.....
	Club-root.....	See soil treatment.
	Yellows.....	See soil treatment.
	Maggot.....	See soil treatment.
	Downy-mildew.	Bordeaux mixture.
Carnation....	Leaf or calyx mold.	Bordeaux I or ½ or 6.	Upon appearance of fungus.	Two weeks later.	Two weeks later.	Repeat if needed.	Begin early before the calyces are ruined.
	Leaf-spot.....	Bordeaux I or ½ or 6.	Upon appearance of fungus.	Two weeks later.	Two weeks later.	Cover foliage well.
Catalpa.....	Leaf-spot.....	Bordeaux I.....	Upon appearance of fungus.	2 or 3 weeks later.	Repeat if necessary.	Cover foliage well.
	Leaf-spot or leaf-blight.	Bordeaux I.....	On young seedlings...	Repeat on seedlings.	Keep leaves well covered in plant bed.
Celery.....	Root-rot.....	Drain soil.
Chard.....	Leaf-spot.....	See beet leaf-spot.
Cherry stocks.	Leaf-spot.....	Bordeaux II or No. 10.	When leaves are half grown.	Two weeks later.	Two weeks later.	About two weeks later.
Cherry.....	{ Leaf-spot .. } { Mildew .. }	Bordeaux II or No. 10.	When leaves are unfolding.	Two weeks later.	2 or 3 weeks after second.	First after blossoming. Often necessary to treat repeatedly after crop is gathered.
	Rot.....	Bordeaux I and II....	Before blossoming I...	After blossoms drop, II on fruit.	Two weeks later.	2 weeks later.	Use 3 or 4 when fruit is large, No. 10 on sweet cherries.
	Aphis.....	Soap solution.....	On first appearance of aphids.	Difficult to reach aphids. Use 1 lb. of soap to 4 gallons of water.
	Cherry slug....	Arsenate of lead in Bordeaux I or self-bottled lime-sulphur.	After fruit harvest when slugs appear.	Repeat if slugs remain.	Air-slaked lime may be used when trees are carrying fruit.

SPRAY CALENDAR—(Continued)

What to spray	For what to spray	With what to spray	When to spray			Remarks and cautions	
			First spraying	Second spraying	Third spraying		Fourth spraying
Cherry continued.	Curculio.....	Arsenate of lead in Bordeaux I and II or in self-boiled lime-sulphur.	Before blossoming in I.	As blossoms dry up in II.	One week later in II	Avoid strong solutions. Do not use other arsenicals than arsenate of lead.
Chestnut....	San Jose scale..	I 4 or I 9.....	Before buds open.				
	Bark disease..	Cut out and burn diseased parts.					
	Leaf-spot.....	Bordeaux I.....	When leaves are half grown.	Three weeks later.			Disease not yet known in Ohio. This is for warning.
	Weevil.....	Roast nuts in fall.....					Heat nuts in fall to 135°F. for 1 to 2 hours.
Cineraria....	Mildew.....	Bordeaux I or ½ or 6.	When mildew appears in spring.	Two weeks later.	Repeat if necessary.		
Chrysanthemum.	Leaf-spot.....	Bordeaux II or ½ of 6.		Two weeks later.	Repeat if necessary.		
Cottonwood..	Beetle.....	See poplar.	When plants begin to vine.	Two weeks later.	Two weeks later.		
Cucumber....	Anthraxnose..	Bordeaux I.....	July 25 to August 1... later.	Eight to ten days later.	Eight to nine days later.		Repeat at weekly intervals.
	Downy mildew.	Bordeaux I.....		Two weeks later.	Two weeks later second.		Apply to fruit carefully.
	Root-rot.....	(See soil treatment)...	After first blossoms....	Ten days later..			
	Spot of fruit..	Bordeaux I.....					
	Nematodes.....	(See soil treatment)	Pull out and burn infected plants.				Rotate crops.
	Wilts.....	(See soil treatment)...	Soon as plants appear.	Week later....	Week after second.		Week after fourth.
	Cucumber beetle.	Arsenate of lead in Bordeaux I. Or sprinkle and mulch freely with tobacco dust.	As leaves are unfolding.	Two weeks later.	Two weeks later.		Fourth necessitates washing fruit.
Currant....	Leaf-spot.....	Bordeaux I.....					
	Plant bug.....	Kerosene emulsion or I 9.	May.....	Early in June if necessary.			
	San Jose scale..	Lime-sulphur or I 9....	As with the apple....	In spring as with apple.			
	Worm.....	White hellebore arsenate of lead.	When worms first appear. In 3 or 4 days re-lead when in bloom.	In 3 or 4 days repeat.	Repeat as second.		Look for worms on under side of leaves first.
Egg plant....	Bacterial-blight	Remove and burn.					

SPRAY CALENDAR—(Continued)

What to spray	For what to spray	With what to spray	When to spray			Remarks and cautions
			First spraying	Second spraying	Third spraying	
Elm.....	Leaf-spot.....	Bordeaux I.....	When leaves are half grown.	Three weeks later.		
	Powdery mildew.	Lime-sulphur or Bordeaux.	With first appearance of mildew in mid-summer.	Three weeks later.		
	Flea beetle.....	See potato.				
	Lecanium scale.	As maple for terrapin scale.				
	Leaf beetle.....	Ars. of lead 1 lb. to 10-15 gals., also bands of burlap and tanglefoot; band below.	When larvæ appear...			
Ginseng.....	Alternaria blight.	Bordeaux I.....	As new stools appear..	Two to 3 weeks later.	Repeat second.	Repeat if necessary.
Gooseberry..	Leaf-spot.....	Bordeaux I.....	As currants with leaf-spot.	As currants with leaf-spot.	As currants with leaf-spot.	As currants with leaf-spot.
	Mildew.....	Bordeaux I or 8.....	Before leaves open I...	After blossoming I.	Potassium sulphide two weeks later.	Bordeaux coats fruits if used for 3rd. Sodium sulphide may be substituted for 8.
	Worm.....	White hellebore or arsenate of lead.	As on currants.			
Grape.....	Anthracnose.....	Bordeaux I.....	Just before buds open.	Just before blossoming.	Just after fruit has set.	Just after fruit to days later Bordeaux.
	Berry moth.....	Arsenate of lead with Bordeaux I or 7.	Before bloom.....	After fruit has set.	July 1 to July 15.	
	Downy & powdery mildew.	Bordeaux I or 7.....	Just before blossoming.	After fruit has set.	10 to 15 days later.	
	Rot.....	Bordeaux I.....	In early spring coat vines and trunks well.	Repeat with next rot spray.		
	Leaf hopper.....	Bordeaux I or 7 and 3 or 4.	Just before blossoming Bordeaux I or 7.	Just after fruit has set I or 7.	7 or 8 days later.	7 or 8 days later. Bordeaux I or 7.
		Kerosene emulsion, 19 or strong tobacco decoction.	Before young can fly.			Repeat treatments at short intervals until insects are exterminated.

SPRAY CALENDAR—(Continued)

What to spray	For what to spray	With what to spray	When to spray				Remarks and cautions
			First spraying	Second spraying	Third spraying	Fourth spraying	
Grape continued.	Rose bug.....	Arsenate of lead and glucose in water.	Soon as bugs appear.	2 or three days later.	1 week later.	1 week later.	Continue at intervals of 1 week or oftener as long as necessary.
Horse Chestnut.	Leaf-spot or blight.....	Bordeaux I.	When leaves are half grown.	Two weeks later.	Two weeks after second.	2 or 3 weeks later.	
	Leaf hopper.....	Tobacco decoction or dilute kerosene emulsion.	As soon as noticed, before insect acquires wings.	Repeat first 10 days later.			
Juniper or Cedar.	Rust.....	Cut out rust apples.	As soon as seen, better in fall.				Warmth and moisture are dangerous. Sub-irrigation gives ideal conditions.
Lettuce.....	Downy mildew.	Keep houses cool and avoid water on leaves.					
	Rosette.....	See soil treatment.....	Gather diseased leaves.				
	Rot or drop.....						
Maple.....	Caterpillars.....	Arsenicals.....	When seen.				Keep trunks white-washed from early summer till fall, 2 or 3 applications.
	Borers.....	Whitewash trunks.....					
	Terrapin scale..	Kerosene emulsion 1 part to 6 or 8 parts water or miscible oils 1 part to 12 parts water.	When buds are swelling.				
Muskmelon..	Anthraco-nose....	Bordeaux I and II.....	In seed bed or when plants begin to vine	2 weeks later	Two weeks later.	Two weeks later.	Repeat as necessary; use II very early.
	Cucumber beetle.	Same as for cucumbers.					
	Downy mildew.	Bordeaux I.....	July 25 to August 1....	8 to 10 days later.	8 or 9 days later.	Eight days later.	
	Leaf-blight.....	Bordeaux I.....	When plants begin to vine.	Three weeks later.	Three weeks after second.	Two weeks after third.	
	Wilts.....	See soil treatment.....	Pull out and burn wilted plants.				
Oak.....	Anthraco-nose....	Bordeaux I or 14.....	Just as buds are opening I or 14.	Two weeks later if necessary.			
	Caterpillars.....	(See maple).					
	Anthraco-nose....	(See seed treatment).					
	Blade blight....	Soap solution or kerosene emulsion.					
	Smut.....	(See seed treatment).	When green fly appears.	Two weeks later.			

SPRAY CALENDAR—(Continued)

What to spray	For what to spray	With what to spray	When to spray				Remarks and cautions
			First spraying	Second spraying	Third spraying	Fourth spraying	
Onion.....	{ Smut..... } { Storage rots. }	(See seed treatment).					
Pea.....	{ Blight..... } { Mildew..... }	Bordeaux I.....	Just before bloom.....	Two weeks later.	Repeat if needed.		
Pine.....	Blister-rust.....	Remove and burn.....					Remove and burn infested seedlings, etc.
	Damping-off..... Bark louse..... (woolly).	See tree seedlings. Kerosene emulsion 1 to 8.	On trunk and larger limbs.				
	Leaf scale.....	Kerosene emulsion 1 to 10 or 12.					
Peach.....	Leaf-curl.....	Bordeaux I, 6 or 14.....	In fall, or March, Bordeaux I, 6 or 14.	As buds are opening, I, 6 or 14.	Just after calyx drops. Bordeaux I.	Not required, ditto 3rd, if others are well done.	Lime-sulphur for first instead of Bordeaux I when scale is present.
	Little-peach.....	Prune severely or dig out.					
	Pustular-spot.....	Bordeaux II or 10.....	Just after calyx drops.	Two weeks after first.	Two weeks later.		Cover fruit well.
	Rot.....	Bordeaux I, 14 and 10 or Bordeaux II.	As buds are swelling, I or 14.	As buds are swelling, I or 14.	Just after calyx 3 or 4 weeks later, 10.	As fruit begins to color 10.	Every 7-10 days repeat. Destroy all mummies. 3 may be used 4th.
	Scab.....	Bordeaux I, 6, 10 or 14.	As buds are swelling, Bordeaux I, 6, 8 or 14.	As buds are swelling, Bordeaux I, 6, 8 or 14.	Just after calyx 2 weeks later, 10 or Bordeaux II, 8 or 9.	Repeat third.	10 is safest remedy in foliage.
	Yellows.....	Cut out and burn.					
	Bud moth.....	Arsenicals in Bord. I.	With opening of buds.				
	Curculios.....	Arsenate of lead and self-boiled lime-sulphur.	Arsenate of lead 10 days after bloom falls.				
	Terrapin scale.....	As on maple.					
	San Jose scale.....	Lime-sulphur.....	In late fall or early spring.				
Pear stocks..	Leaf-spot or blight.	Bordeaux I.....	When leaves are half grown.	Two weeks later.	Two weeks later.	Two weeks later.	5 to 7 sprayings are needed.

Use only half usual amount of poison.

SPRAY CALENDAR—(Continued.)

What to spray	For what to spray	With what to spray	When to spray				Remarks and cautions
			First spraying	Second spraying	Third spraying	Fourth spraying	
Pear.....	Leaf-blight.....	Bordeaux I or 7 and 3 or 4.	Before blossoms open.	Two weeks later, 1 or 7.	2 weeks after second 3.	Bordeaux may make russet fruit.	Use 3 for 3rd, not Bordeaux after 2nd. Bordeaux after second may injure the fruit.
	Scab.....	Bordeaux I.....	When leaves are half grown.	After blossoms drop.			
	Blister mite....	Kerosene emulsion, miscible oil or lime-sulphur.	When buds begin to swell in spring.	When leaves have fallen in autumn.			
	Bud moth.....	Arsenites in Bord. I....	With opening of buds.				See apple.
	Canker worm..	Arsenate of lead.....	As with the apple....				See apple.
	Codling moth..	Arsenicals in Bord. I....	In winter or early spring.	Same as first.....			
	San Jose scale..	Lime-sulphur or 19.....	When slugs appear....	Repeat if slugs remain.			
	Slug.....	Arsenicals in Bord. I or dust with staked lime.	When slugs appear....				
Plum.....	Pockets or bladders.	Bordeaux I or lime-sulphur.	In March, I or 14....				Treat as for leaf curl of peach.
	Rot.....	Bordeaux I, also 3 or 4 No. 10 on Am. and Jap. varieties.	As buds are swelling, I or 14.	Just after calyx drops I or 7.	Three or four weeks later, I or 7.	As fruit begins to color use 3 or 4.	Every 7-10 days repeat 4th, useless to spray for rot, unless mummies are destroyed.
	Shot-hole fungus.	Bordeaux I or 7, also No. 10.	When leaves are half grown.	Three weeks later.	3 weeks later if needed.	No. 10 on Am. and Japanese varieties.	Protect to end of season.
	Curculio.....	Arsenate of lead in Bordeaux I or self-boiled lime-sulphur..	With starting of buds.	Just after calyx drops.	Five days later.		Jar, gather and destroy curculios and stung plums in addition.
	Aphis.....	Soap solution.....	On appearance of aphids.				Use 1 lb. soap to 6 gal. water.
	San Jose scale..	Lime-sulphur or 19....	In late fall or early spring.				
Poplar or cottonwood.	Cotton wood leaf beetle.	Arsenate of lead 1 lb. to 10 gallons water.	Spray at intervals of 10 days until danger is checked.				
Potatoes.....	Black-leg.....	See seed treatment....					

SPRAY CALENDAR—(Continued.)

What to spray	For what to spray	With what to spray	When to spray				Remarks and cautions
			First spraying	Second spraying	Third spraying	Fourth spraying	
Potatoes continued.	Early-blight..... Fusarium-blight Late-blight.....	Bordeaux I or 7..... (See seed treatment). Chloro-naphtholeum. Arsenicals alone or in Bordeaux I.	When plants are 6 in. high. July 15-20.....	Two weeks later. Two weeks later.	Two weeks later if needed. Two weeks later.	Seed selection desirable. Repeat at two-week intervals until crop is mature.	
	Rosette..... Blister beetle. Colorado beetle.	(See seed treatment). Whale oil soap or dilute Chloro-naphtholeum. Arsenicals alone or in Bordeaux I.	When beetles appear. When beetles or young appear.	Repeat if necessary. As for first. As for first.	Use 1 lb. soap to 6 gal. of water. Arsenate of lead, 3 lbs. to 5 gallons of water, for Colorado beetle alone.	
Quince	Flea beetle..... Leaf-spot.	Bordeaux I or 7 combined with 21. Bordeaux I	When beetles appear. When leaves are half grown.	Repeat if necessary. About two weeks later.	As for first and second. Two weeks later.	Perhaps 5th spraying will be needed. First should come before blossoms open.	
Quince.....	Leaf-spot..... Fruit and leaf spot. San José scale.	Bordeaux I and 7..... Bordeaux I..... Lime-sulphur or 19.	When leaves are half grown. Just before blossoms open. In late fall or early spring.	After blossoms drop.	Two weeks later. Two weeks later. Two weeks after second.		
Radish.....	Club-root..... Maggot..... Anthracnose.....	See soil treatment. See soil treatment. Bordeaux I and II.....	Before leaves open use I.	II on canes 6 in. high.	Repeat one week later. Three weeks after 2nd.	Keep spray from leaves of bearing canes.	
Raspberry and Blackberry.	Cane-blight..... Leaf-spot..... Rust..... Rasp..... Saw fly.....	Bordeaux II..... Bordeaux I..... Remove diseased stools and burn. Arsenate of lead..... Pyrethrum, hellebore or arsenate of lead.	On young canes just before blooming of old. When leaves are half grown. Before beetles appear about May 1st. As for currant worm. Arsenate of lead as soon as leaves are out.	Immediately after fruit is gathered. Two weeks later.	Remove old canes at once after picking and spray new canes very thoroughly. Be prompt in destroying diseased stools. Cultivate thoroughly in fall to destroy and expose pupæ.	
Rose.....	Leaf-spot.....	Bordeaux I or ½ of 6.	With first appearance of fungus.	2 or 3 weeks later.	Repeat if necessary.	Bordeaux shows on plants.	

What to spray	For what to spray	With what to spray	When to spray				Remarks and cautions
			First spraying	Second spraying	Third spraying	Fourth spraying	
Rose continued.	Mildew.....	Lime-sulphur as for apple or No. 10.	With first appearance of mildew.	2 to 3 weeks later.	Three weeks later if needed.	When Bordeaux is used for leaf-spot, other spray may not be needed.
	Nematodes.....	See soil treatment.					
	Slug.....	Arsenicals in Bord. II or hellebore.	On appearance of slugs.	Repeat if needed.			
	Rye.....	Anthracnose.....	See seed treatment.				
		Ergot.....	Remove ergotized grain before seeding.				
	Salsify.....	Cystopus.....	Remove and burn diseased parts.				
		Cucumber beetle.....	Same as for cucumber.				
		Squash bug.....	Hand picking.....				
	Strawberry..	Leaf-spot.....	Bordeaux I, 7 or 10....	On new growth after 2 or 3 weeks later.			
		Root-spot.....					
	Sugar Beets.	Damping-off... Leaf-spot.....	See soil treatment. Bordeaux I.....	With first appearance 2 or 3 weeks later.	2 or 3 weeks later if needed.		
		Blister beetle...	Whale oil soap or dilute Chloro-naphtholeum.	When beetles appear..			Use 1 lb. to 6 gallons of water.
	Sycamore....	Anthracnose... Powdery mil-dew.	As for oak..... Lime-sulphur or No. 10.	With first appearance, about July 15.	Three weeks later on new growth.	Repeat second.....	Most troublesome on oriental variety.
		Root-rot bed-rot.	See soil treatment.				
	Tobacco.....	Mosaic disease.	Handle separately from healthy plants.....				Communicated by touching. See Bulletin 156.
		Tobacco worm.	Paris green or arsenate of lead.	When worms appear.	2 weeks later.	2 or 3 weeks later if necessary.	Powdered arsenites applied with powder gun are most satisfactory.
	Tomato.....	Anthracnose....	Bordeaux I.....	Soon after fruit begins to set.	3 weeks later.		

SPRAY CALENDAR—(Continued.)

What to spray	For what to spray	With what to spray	When to spray			Remarks and cautions
			First spraying	Second spraying	Third spraying	
Tomato continued.	Fusarium-wilt...	See soil treatment. Rotate crop.....
	Leaf-blight.....	Bordeaux I.....	3 weeks after transplanting.	3 weeks after first.	3 weeks later.	3 weeks later. Rotate crop.
	Mosaic disease (in greenhouse).	Avoid too high temperatures at night.	Watch carefully and ventilate fully.
	Point-rot.....	See soil treatment.
	Sclerotium-wilt.	Remove and burn diseased plants.	Watch carefully.....
	Tomato worm..	Hand picking.
Tree Seedlings (Comifers).	Damping-off...	Slaked lime dust 10 parts, powdered copper sulphate 1 part, thoroughly mixed and screened.	Repeat first.....	Repeat first.....	Repeat first.....
Turnip.....	Downy-mildew.	Spray with Bordeaux mixture.	Upon appearance of disease.
Watermelon..	Anthracnose...	Bordeaux II.....	When plants begin to vine.	Three weeks after first.	3 weeks later.	Bordeaux I, some danger.
	Cucumber beetle	Same as for cucumber.
	Downy mildew.	Bordeaux II.....	July 25 to Aug. 1.....	8 to 10 days later.	8 to 9 days later.
	Leaf-blight.....	Bordeaux II.....	As disease appears on muskmelons.	Repeat as on muskmelons.	As for cucumbers.
Wheat.....	Anthracnose, scab, smut, etc.	See seed and soil treatment.
	Insects in stored grain.	See seed treatment, page 31.

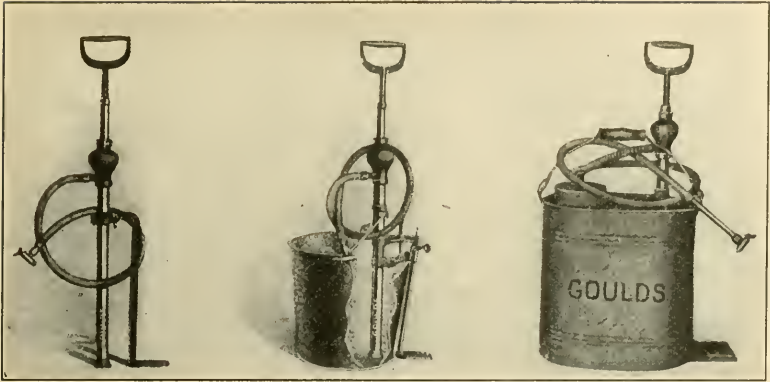

FIG. 238.—Spray pumps isolated and with bucket attachments.

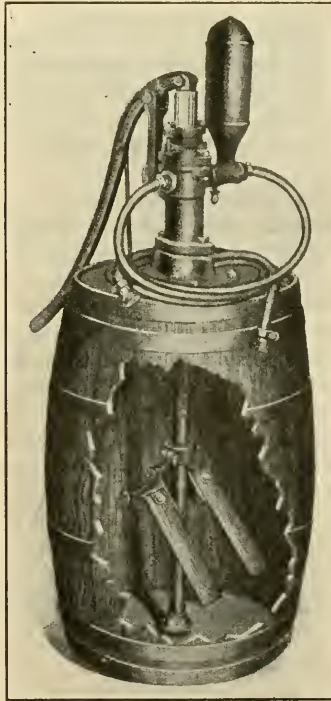

FIG. 239.—Spray barrel with pump.

Spraying Apparatus.—Various forms of spraying apparatus are upon the market for use in the different operations of spraying. The student is directed to trade catalogs and to special treatises on the subject for details.

We may, as an introduction to this subject, classify the types of spraying outfits into: Bucket pumps (Fig. 238), knapsack sprayers (Fig. 238), barrel pumps (Fig. 239), the tank outfit, geared sprayers, steam and gasoline outfits, etc.

The question of details resolves itself into a consideration of hose, extension rods, nozzles, force pumps, wagons, push carts and receptacles for the spray materials (for outfit see page 672). For these details and a list of firms dealing in spraying apparatus, consult a bulletin by C. A. McCue entitled Plant Protection, Bull. No. 97, Del. Col. Agric., Exper. Sta., June 15, 1912.

APPENDIX III

Antisepsis and Disinfection.—An antiseptic is a substance which acts to the exclusion from wounds of living organisms that cause putrefaction, or decay.

Liquor Antisepticus.—155 grains of boric acid should be dissolved in 11½ ounces of water, and 7 grains of benzoic acid in 2½ ounces of alcohol, and the two liquids then mixed. After dissolving 7 grains of thymol in a mixture of 8 drops of oil of peppermint 4 drops each of eucalyptol and oil of gaultheria and 1 drop of oil of thyme, triturate with 155 grains of purified talc and add the solution of benzoic and boric acids. Shake occasionally during forty-eight hours, filter and add to the clear filtrate first 1½ ounces of alcohol, and then sufficient water to bring the volume up to 1 pint.

Formalin.—Has powerful antiseptic properties. It is sold in 40 per cent. solution and can be distilled with water to the required strength.

Corrosive Sublimate (Bichlorid of mercury).—It is used in solution in water in a strength of 1:1000.

Definition of Disinfectant.—A disinfectant is a substance used to destroy the germs of infectious diseases. The common disinfectants are formaldehyd (liquid, gaseous), carbolic and (phenol) cresol, chlorinated lime (chlorid of lime), corrosive sublimate. See DORSET, M.: Some Common Disinfectants. U. S. Farmers' Bull. No. 345 (1908).

Preservation of Wood by Impregnation.—Impregnation tends to increase the durability of wood by injecting an antiseptic liquid and may mean a desirable, or undesirable, change of color, and in some cases fire-proofing. Little is known about he latter. Four principles may be applied.

A. Immersion.

I. Immersion in a salt. Corrosive sublimate (kyanizing).

II. Metalized wood by dipping in a solution of iron sulphate.

B. Boiling.

I. In salt water or solution of borax.

II. Frank's mixture, 95 per cent. liquid manure and 5 per cent. of lime.

III. Injection of copperas (siderizing).

IV. With exhaust steam.

C. *Use of Hydrostatic Pressure*.—Boucherie method with sulphate of copper.

D. *Use of Air Pressure* (Open-tank treatment).

E. *Use of Steam Pressure*.—The liquids commonly used are chloride of zinc, coal-tar creosote, mixture of chloride of zinc and of creosote, gases of tar oils (thermo-carbolization), heavy petroleum.

Preservation of Wood by Air Drying or Kiln Drying. Bibliography.—SCHENCK, C. A.: Logging, Lumbering or Forest Utilization, 1913, and the following bulletins: Bureau of Forestry and late Forest Service, U. S. Dept. Agr.: No. 41, Seasoning of Timber; No. 50, Cross Tie Forms, Etc. with Reference to Treated Timbers; No. 51, Condition of Treated Timbers Laid in Texas, February, 1902; No. 78, Wood Preservation in the United States; No. 84, Preservative Treatment of Poles; No. 107, Preservation of Mine Timbers; No. 118, Prolonging Life of Crossties; No. 126, Preservative Treatment of Red Oak and Hard Maple Cross Ties, etc.

APPENDIX IV

CULTURE OF MUSHROOMS

Tissue Culture of Fleishy Fungi.—Consult DUGGAR, B. M.: The Principles of Mushroom Growing and Mushroom Spawn Making. Bull. No. 85, Bureau of Plant Industry, 1905: 18.

This method is applicable to the mushroom and to 68 other species of fleshy fungi listed by Duggar.

A young sporophore of *Agaricus campestris* is taken and broken open longitudinally. A number of pieces are carefully removed with a sterile scalpel to a sterile Petri dish on a number of nutrient media such as bean pods, manure and leaf mould. From this and numerous other similar tests it was ascertained that when the mushrooms, from which the pieces of tissue are taken, are young and healthy, there is seldom an instance in which growth does not result. It was easily shown that failure to grow was generally due to advanced age of the mushroom used, to an unfavorable medium, or to bacterial contamination.

APPENDIX V

SYNOPSIS OF THE FAMILIES AND PRINCIPAL GENERA OF THE MYXOGASTRALES

Suborder I. Exosporeæ.—Spores developed outside of the sporophore.

FAMILY I. CERATIOMYXACEÆ.—Sporophores membranous, branched; spores white, borne singly on filiform stalks arising from the areolated sporophore.

Suborder II. Endosporeæ.—Spores developed inside the sporangium, æthaliium or plasmodiocarp.

A. Spores violet-brown, or purplish gray (ferruginous in *Stemonitis ferruginea* and *S. flavogenita*, colorless in *Echinostelium*).

(a) Sporangium provided with lime (Calcium carbonate).

FAMILY 2. PHYSARACEÆ.—Lime in the form of minute round granules, innate in the sporangium wall.

Capillitium charged with lime throughout. *Badhamia*.

Capillitium of hyaline threads with lime knots.

Sporangia single, subglobose, or plasmodiocarps; capillitium without free, hooked branches. *Physarum*.

Sporangia forming an æthaliium. *Fuligo*.

Plasmodiocarps; capillitium with free, hooked branches. *Cienkowskaia*.

Sporangia goblet-shaped or ovoid; stalks cartilaginous. *Craterium*.

Sporangia ovoid, shining, clustered; stalks membranous. *Leocarpus*.

Capillitium without lime.

Sporangial wall opaque. (*Chondrioderma* (= *Diderma*).

Sporangial wall hyaline. *Diachæa*.

FAMILY 3. DIDYMIACEÆ.—Lime in superficial crystals deposited outside the sporangial wall.

Crystals stellate, sporangia single. *Didymium*.

Crystals stellate, sporangia forming an æthaliium. *Spumaria* (= *Mucilago*).

Crystals lenticular. *Lepidoderma*.

(b) Sporangia without lime.

FAMILY 4. STEMONITACEÆ.—Sporangia single, provided with a stalk and columella.

*Sporangial wall evanescent.

Capillitium spreading from the column and forming a superficial net. *Stemonitis*.

Capillitium as above, but not forming a superficial net. *Comatricha*.

Capillitium spreading from the apex of the sporangium. *Enerthenema*.

**Sporangial wall more or less persistent.

Capillitium radiating from the columella. *Lamprodema*.

Capillitium scanty, colorless, branching from a short columella, sporangia very minute. *Echinostelium*.

FAMILY 5. BREFELDIACEÆ.—Sporangia combined into an æthaliium.

Capillitium irregularly branched. *Amaurochæta*.

Capillitium with chambered vesicles. *Brefeldia*.

B. Spores variously colored, not violet (except *Cribraria violacea*).

(a) Capillitium wanting, or not forming a system of uniform threads.

FAMILY 6. CRIBRARIACEÆ.—Sporangial wall membranous, beset with microscopic round plasmodic granules.

Sporangia æthalioid, the wall not forming a persistent net. *Lindbladia*.

Sporangial wall forming persistent net. *Cribraria*.

Sporangial wall forming numerous parallel ribs. *Dictydium*.

FAMILY 7. LICEACEÆ.—Sporangial wall cartilaginous.

Sporangia solitary, sessile. *Licca*.

FAMILY 8. TUBIFERACEÆ.—Sporangial wall membranous, without round plasmodic granules.

Sporangia tubular compacted. (*Tuberifera* (= *Tubulina*).

FAMILY 9. RETICULARIACEÆ.—Sporangia closely compacted and usually forming an æthaliium, true capillitium none.

Sporangia columnar, inner walls reduced to straight slender threads.

Dictydæthaliium.

Sporangia interwoven, inner wall reduced to broad bands. *Enteridium*.

Sporangia interwoven, inner walls lacinated. *Reticularia*.

(b) Capillitium present; a system of uniform threads.

FAMILY 10. TRICHIACEÆ.—Sporangia single, rarely in an æthaliium. Peridium without thickenings, without lime. Capillitium of tubular simple, or branched, free threads. Spore mass as capillitium, yellow or red, rarely white or brown, never violet.

*Capillitium of free elaters, or an elastic network of spiral thickenings.

Elaters free, spirals distinct. *Trichia*.

Elaters free, scanty, spirals obscure. *Oligonema*.

Elaters combined into a web or network. (*Hemitrichia* (= *Hemiarcyria*).

**Capillitium a profuse network of threads (usually scanty and free in *Perichæna populina*), thickened with cogs, half rings, spines or warts.

Sporangia stalked, sporangial wall evanescent above. *Arcyria*.

Sporangia sessile, clustered, the walls single, persistent. *Lachnobolus*.

Sporangia sessile, the walls usually double. *Perichæna*.

***Capillitium coiled and hairlike, or straight, and attached to the sporangial wall.

Capillitium straight. *Dianema*.

Capillitium penicillate, spirally banded. *Prototrichia*.

****Sporangia forming an æthaliium; capillitium consisting of branched colorless tubes.

Capillitial tubes, thick-walled where they traverse the cortex, thin-walled among the spores. *Lycogala*.

APPENDIX VI

KEY FOR THE DETERMINATION OF SPECIES OF MUCOR

LABORATORY WORK.—The teacher will find it good educational practice to supply the class with material of the commoner moulds in order that they may become familiar with the general morphology of the ZYGOMYCETALES.

From the standpoint of taxonomy the columella is an organ of the first importance. The position of the columella in relation to the wall of the sporangium has been described as "free," "subjacent," "infundibuliform."

Terms which have been applied in systematic works to the different shapes of the columella¹ are illustrated in Fig. 240, *a* to *l*, inclusive.

The spores, whether sporangiospores, conidiospores, chlamydo-spores, oidiospores or stylospores (as in *Mortierella*), have been described by special names, as spheric, ellipsoidal, oval, dumbbell-shaped, spindle-shaped, bottle-shaped, bead-shaped, etc.

¹ LENDER, DR. ALF.: Les Mucorinées de la Suisse, 1908: 29.

Several solid culture media recommended by Lindner can be used in the growth of various moulds in test-tubes and in Petri dishes for class use. Such is grape juice exactly neutralized and combined with 10 per cent. gelatin. Another medium is prepared by taking 1 liter of white wine, heating it over a flame for one-half hour to drive off completely the alcohol. The liquid lost by evaporation is replaced to bring the volume up to 1 liter. It is neutralized exactly and 10 per cent. gelatin is added. On this medium moulds grow luxuriantly. The gelatin can be replaced by agar-agar, using 1.5 per cent., and the advantage of this medium is that it does not liquefy. The writer has found baker's bread a useful medium for the growth of moulds under bell jars, the air of which is kept moist by filter paper. If the bread is used in Petri dishes, it can be sliced, cut into a circular form, soaked in water, or beerwort, placed under cover in the Petri dish, which should then be sterilized one or two times. He has found beerwort agar extremely useful in raising moulds and other filamentous fungi. A supply of the + and - races of heterothallic moulds

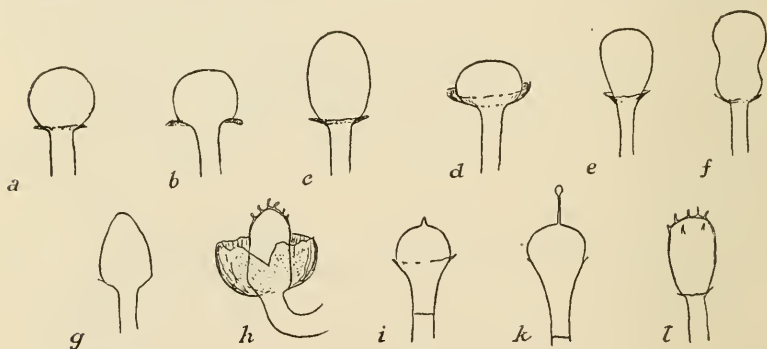

FIG. 240.—Forms of columella. *a*, Spheric; *b*, spheric with collarette; *c*, oval; *d*, depressed oval; *e*, piriform; *f*, panduriform; *g*, conic; *h*, cylindro-conic; *i*, mammiform; *k*, *l*, spinescent. (After Lendner.)

should be kept in culture, so that the students may experiment with the formation of the gametes and zygospores. These can be mounted in acetic acid with a ring of asphalt about the cover-glass, or they can be fixed and carried up through the alcohols to such materials as Venetian red in which they are not only beautifully stained, but also keep indefinitely. The Venetian red can be softened in a water bath and a little placed in the center of a slide with the addition of a little balsam to fill out the space beneath the cover.

The systematic study of the moulds should begin after their general morphology and physiology have been considered. Cultures, the names of which are known to the teacher, should be then given to the members of the class in mycology, as unknown moulds, which the members of the class should mount and determine. Such mounts may be made in 2 per cent. acetic acid after treating first with a weak alcohol (10 per cent.) to wet the mycelium, so that the acetic acid will cover the specimen without air bubbles and without the hyphæ massing together, as happens frequently

when acetic acid is applied without the preceding application of the alcohol. The identification of the "unknown" moulds can be made by the use of the following key, which is a translation of the one given by Lindner in his work on the Swiss moulds, and which includes most of the important moulds of the world. Pure cultures of various moulds can be obtained from Johanna Westerdijk, Director of the Phytopathological Laboratory, Amsterdam, Holland; from Kral's Bacteriologisches Laboratorium, Prague, Bohemia, 1., Kleiner Ring, 11; and from Mrs. Flora W. Patterson, Bureau of Plant Industry, Washington, D. C. Some of them can be obtained by exposing various articles to the air under a bell jar with filter paper. Transfers of these moulds to fresh culture media should be made every two or three months. During the summer and even during the winter the cultures can be kept on ice in a refrigerator, so that the transfers need not be made so frequently during the hot weather of the summer, or while the teacher is off on his vacation. The janitor should be instructed to look after the ice supply during the year. Cf. ПОВАН, A. H. W.: A Critical Study of certain Species of *Mucor*. Bull. Torr. Bot. Club, 44: 241-259, May, 1917, continued.

Key for the Determination of Species of *Mucor*

Sporangiophores not branched. 1 Group *Mono-mucor*.

Sporangiophores branched.

(a) Branches rare, or more numerous and indefinite, in racemes, or corymbs.
2 group *Racemo-mucor*.

(b) Branches definite in sympodia. 3 Group *Cymo-mucor*.

1 Group **Mono-Mucor**

Sporangiophores unbranched. (Exceptionally unless the conditions of nutrition are unfavorable, they form branches. These are anomalous cases.)

1. Sporangiohores at first erect, afterwards weak, finally drooping and transformed into a woolly felt of a rusty color. 1 *M. rufescens* Fischer.
Sporangiophores always erect and forming a matted growth. (2)
2. Sporangiohores never exceeding 2 cm. (3)
Sporangiophores longer than 2 cm. (7)
3. Sporangiohores never exceeding 300 μ . (4)
Sporangiophores exceeding 0.5 cm. (maximum 2 cm.). (5)
4. On solid media matted growth very short, velvety, color at first brownish red-carminé then grayish, sporangia small (20 μ maximum). 2 *M. Ramaniamus* Möller.
Matted growth scarcely visible, sporangiophores 210 μ , colorless, septate; sporangia 40 to 45 μ diameter. 3 *M. subtilissimus* Oudemans.
5. Wall of sporangium not diffluent; on breaking it leaves an irregular, ragged collarette, sporangia 36 to 42 μ diameter, spores elliptic 6 μ by 8 μ . Matted growth 1.5 tall. 4 *M. hygrophilus* Oudemans.
Wall of sporangium not diffluent, sporangia large, 80 to 98 μ in diameter, spores elliptic 5 μ by 8 μ .

- Matted growth 2 cm. high. 5 *M. adventitius* Oudemans.
 Columella with orange-red contents; variety *aurantiaca* Lendner.
6. Spores mixed with oil drops and intersporal granular protoplasm. 6 *M. plasmaticus* van Tieghem.
 Without drops of oil in the sporangium. (7)
 7. Sporangioophores 2 to 3 cm. long. (8)
 Sporangioophores more than 3 cm. (9)
 8. Sporangia 80μ diameter, columella oval, spores 8μ by 10μ (except 8 by 14μ).
 7 *M. himmalis* Wehmer.
 Sporangia larger than 250 to 350μ , columella pyriform, large, spores 4 to 8μ by 5 to 13μ . 8 *M. piriformis* Fischer.
 9. Wall of sporangium ruptured rapidly, columella frequently with yellow contents, spores 3 to 6μ by 6 to 12μ . 9 *M. mucedo* Linn. (Fig. 13).
 Wall of sporangium ruptured slowly, columella colorless, spores very large, 15μ by 30 to 33μ . 10 *M. mucilagineus* Brefeld.

2 Group **Racemo-Mucor**

Branching indefinite, in racemes or in corymbs.

1. Branching secondary verticillate, these last have at their nodes the verticillate branches. 11 *M. glomerula* Lendner (Bainier).
 Branching open in racemes, or in corymbs.
2. Columella hemispheric, covered with colorless threads resembling the capillitium of certain MYXOMYCETES. 12 *M. comatus* Bainier.
 Columella round or oval, never presenting capillitial character. (3)
3. Sporangioophore at first erect, then curved toward the substratum, and then fading. 13 *M. de Baryanus* Schostakowitsch.
 Sporangioophores always erect and forming a matted growth. (4)
4. Species parasitic on other MUCORACEÆ. 14 *M. parasiticus* Bainier.
 Species not parasitic. (5)
5. Sporangioophores of two kinds, one with a terminal large sporangium with diffluent wall, the others lateral, bearing sporangioles with persistent walls. 15 *M. agglomeratus* Schostakowitsch.
 Species not possessing the above characters. (6)
6. Sporangioophores bearing laterally the branches with normal sporangia (or abortive), or with zygospores.
 Suspensors unequal. (7)
 Sporangioophores normally laterally (*i.e.* all terminated by sporangia).
 Zygospores with suspensors approximately equal. (8)
7. Sporangioophores straight, simple or branched bearing one or two opposite branches terminated by sporangia. Columella depressed, spores elliptic 2 to 3μ by 4 to 5μ . 16 *M. Moelleri* Vuillemin (Fig. 241).
 Sporangioophores straight, branched, bearing verticillately two to four sporangia, columella roundish, spores spheric 2 to 3μ diameter. 17 *M. heterogamus* Vuillemin.

8. Spores unequal (mixture of numerous small spores with others twice as large). (9)

Spores approximately equal in size. (10)

9. Sporangiohores 0.5 to 1.5 cm., straight. Sporangia 80 to 125 μ diameter, spores spheric or angular of diverse forms, 4 to 15 μ diameter. 18 *M. heterosporus* Fischer.

Sporangiophores ordinarily 3 to 4 mm. (1 cm. maximum), sporangia 70 μ diameter as maximum. Spores oval or subcylindric 2 to 6 μ by 6 to 8 μ . Chlamydospores along the course of the sporangiferous hyphæ. 19 *M. sylvaticus* Hagem.

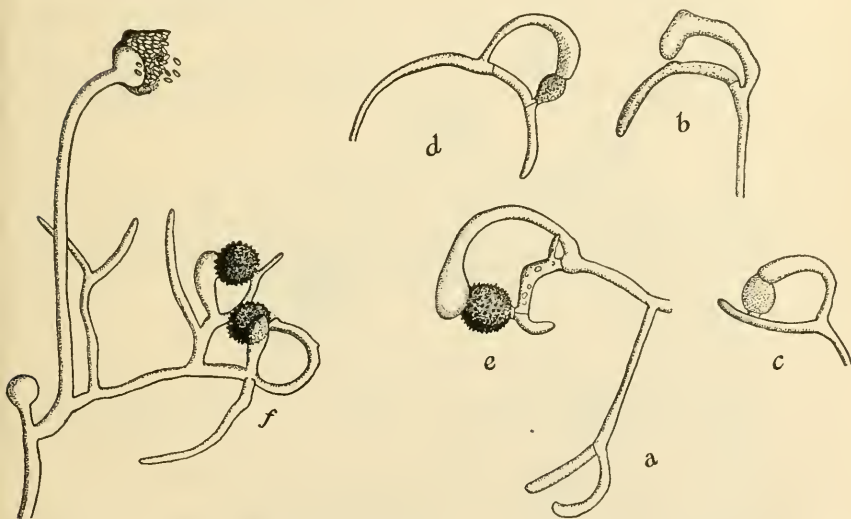

FIG. 241.—*Mucor Moelleri*. Stages in zygospore formation. (After Lendner.)

Sporangiophores 1 cm. Sporangia 40 to 54 μ , wall dehiscent. 20 *M. lausannensis* Lendner.

10. Wall of sporangium not diffluent, but breaking into pieces. (11)

Wall diffluent. (13)

11. Spores spheric 7 μ diameter. 21 *M. corymbosus* Harz.

Spores oval. (12)

12. Sporangiohores frequently unbranched, chlamydospores provided with very fine points; azygospore formation the normal process. 22 *M. tenuis* Bainier.

Sporangiophores branched, chlamydospores with smooth walls, zygospores and azygospores. 23 *M. racemosus* Fresenius (Fig. 30).

13. Spores spheric, 3 to 3.5 μ . 24 *M. pusillus* Lindt,

Spores oval or elongated. (14)

14. Large species 6 to 8 cm. tall (exceeding in all cases 2 cm.). (15)
Small species never exceeding 2 cm. in height. (16)
15. Sporangiophores 6 to 7 cm. in height, sporangia 300 to 400 μ (exceptionally 500 μ), spores 7.5 by 17.5 μ . 25 *M. proliferus* Schostakowitsch.
Sporangiophores 6 to 8 cm. in height, sporangia 140 to 150 μ diameter, spores 4.2 μ by 9 to 12 μ . 26 *M. flavus* Bainier.
16. Columella largely subjacent and concrescent with the wall of the sporangium, diameter 100 μ , spores 2 to 4 μ . 27 *M. mollis* Bainier.
Columella free and slightly flattened at base. (17)
17. Spores oval, small 2.1 μ by 4.2 μ , a grayish-blue. 28 *M. fragilis* Bainier.
Spores elongated plano-convex, unequal, 2 to 5 μ by 5 to 10 μ . (18)
18. Sporangia never exceeding 80 μ , zygospores frequent, forming (on bread) special branches. 29 *M. genevensis* Lendner.
Sporangia a mean of 80 μ frequently 120 μ diameter, suspensors bearing the sporangiophores as with *M. racemosus* (Fig. 30). 30 *M. erectus* Bainier.

3 Group—Cymo-Mucor

Sporangiophores branched in sympodial cymes.

1. Sporangiophores of two kinds, the one straight and bearing the normal spheric Sporangia, the other creeping, circinate branches sympodial, bearing piriform sporangia. 31 *M. pirelloides* Lendner.
Sporangiophores of a single kind. (2)
2. Sporangiophores circinate. (3)
Sporangiophores straight not circinate. (6)
3. Sporangiophores never exceeding 1 cm., spores oval, maximum length 6 μ . (4)
Sporangiophores exceeding 1 cm. sometimes 3 cm., spores spheric, 10 μ or more. (5)
4. Wall of sporangium brown, sporangium frequently subsessile, spores 3 to 4 μ by 5 to 6 μ long. 32 *M. circinelloides* van Tieghem.
Sporangia wall bluish-black, sporangia carried on long pedicels, frequently circinate, spores 4 μ by 5 to 6 μ . 33 *M. griseo-cyanus* Hagem.
5. Sporangiophores creeping, $\frac{1}{2}$ to 2 cm., sporangia black 120 to 200 μ , spores 10.5 μ to 14 μ in diameter. 34 *M. angariensis* Schostakowitsch.
Sporangiophores straight not circinate, the others short, freely branched and circinate, sporangia small 60 μ (mean), 12 μ (maximum). 41 *M. lamprosporus* Lendner (Fig. 242).
6. Spores spheric or very unequal of diverse forms. 35 *M. heterosporus sibiricus* Schostakowitsch.
Spores spheric appreciably equal. (7)
Spores oval. (12)
7. Species poorly cultivated on grape-juice gelatin, forming on bread a short mat of 2 to 3 mm., sporangia 50 to 70 μ , spores spheric, 5 to 6 μ . 36 *M. Jansseni* Lendner.
Species readily cultivated on grape-juice gelatin, forming a taller matted surface (1 to 3 cm.). (8)

8. *Columella* spinescent. (9)

Columella smooth. (10)

9. Sporangiophores never exceeding 2 mm., sporangia 60 to 80 μ , spores smooth 7 to 8 μ . 37 *M. spinescens* Lendner.

Sporangiophores over 1 cm. and more tall, spores frequently punctate, 5 to 8 μ . 38 *M. plumbeus* Bonorden.

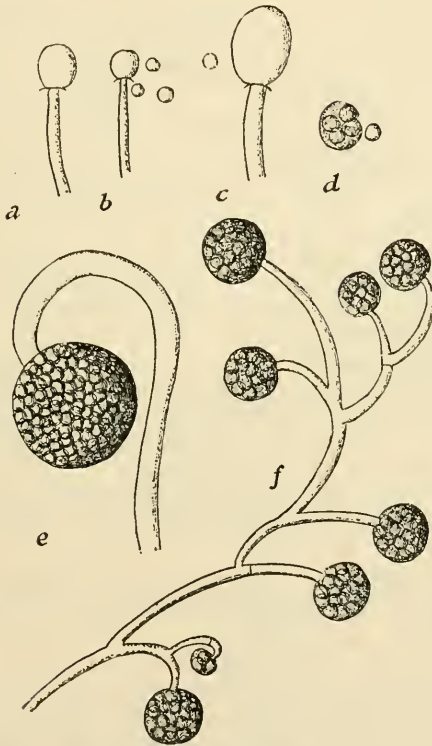

FIG. 242.—*Mucor lamprosporus*. a, b, c, *Columella*; d, sporangiole; e, sporangium; f, branched sporangiophore. (After Lendner.)

10. Sporangia 75 to 120 μ , columella piriform or campanulate, spores 4 to 8 μ diameter. 39 *M. globosus* Fischer.

Sporangia ordinarily smaller (110 μ maximum), columella spheric, oval or campanulate. Spores larger 10 μ (mean). Species with sporangioles near the substratum. (11)

11. Sporangia 70 to 110 μ diameter, sporangioles not caducous, spores spheric, shining, 10 μ . 40 *M. sphaerosporus* Hagem.

Sporangia never exceeding 80 to 90 μ , spores 10 μ .

- Sporangioles circinate, caducous, sporangiophores more elevated than in preceding species. 41 *M. lamprosporus* Lendner (Fig. 242).
Sporangia 60 to 80 μ , spores normally 8 to 10, spheric or accompanied by abnormal spores, oval 8 to 10 μ by 30 μ long, without sporangioles. 42 *M. dimorphosporus* Lendner.
12. Large species 9 to 12 cm. high. (13)
Small species. (14)
13. Sporangiophores 9 to 10 cm., sporangia up to 1 mm. diameter, spores 10.5 by 28 μ . 43 *M. irkutensis* Schostakowitsch.
Sporangiophores 10 to 12 cm., sporangia 500 μ , spores 5 μ by 8.6. 44 *M. Wasnessenskii* Schostakowitsch.
14. Wall of sporangia not diffluent, breaking into pieces. 45 *M. brevipes* Riess.
Wall of first sporangia diffluent. (15)
15. Spores elongate with punctate spore walls, sporangia blackish, 100 μ diameter. 46 *M. ambiguus* Vuillemin.
Spores subspheric with smooth walls. (16)
16. Species forming on bread or grape-juice gelatin a mycelium somewhat raised and of a yellow color. 47 *M. Rouxianus* Wehmer.
Species forming a matted growth of 1 to 3 cm. tall. (17)
17. Species branched but little. (18)
Species copiously branched. (19)
18. Sporangia 50 to 350 μ , columella spheric, spores spheric or elliptic or angular, 4.2 by 6.5 μ with chlamydo-spores. 48 *M. geophilus* Oudemans.
Sporangia 90 μ to 170 μ diameter, columella ovoid, spores subspheric 5 to 6 μ by 6 to 8 μ rarely 10 μ . 49 *M. strictus* Hagem.
19. Sporangia 35 to 70 μ (90 μ diameter), spores 6 μ by 8 μ or 8 to 10 μ diameter, yellow pigment in hyphæ weakly developed. 50 *M. Prainii* Chodat & Nechitch.
Sporangia 50 μ , wall more diffluent, spores more frequently oval and very small, 4 to 5 μ by 5 to 7 μ , also 4 to 7 μ diameter. 51 *M. javanicus*¹ Wehmer.

APPENDIX VII

KEYS FOR THE DETERMINATION OF SPECIES OF ASPERGILLUS AND PENICILLIUM

For student use in systematic study, or identification of the green moulds belonging to the genus *Aspergillus*, the teacher will find the following key, adopted from "Household Bacteriology" by the Buchanans, pages 76 and 77, of great value. Lafar in his "Technical Mycology," Vol. II, Part 2, also gives on page 308 a useful specific summary. The different species may be kept in culture for distribution as unknown to the members of the class.

KEY TO COMMON SPECIES OF ASPERGILLUS

- I. White spores, or nearly white.
A. Sterigmata unbranched. *Aspergillus candidus*.
¹ *M. dubius* is a variety of *M. javanicus*.

B. Sterigmata branched. *Aspergillus albus*.

II. Colored spores.

A. Spores yellowish-green, bluish-green, grayish-green, green.

1. Sterigmata unbranched.

(a) Perithecia produced readily.

1. Perithecia not imbedded, naked. *A. herbariorum*.

2. Imbedded perithecia.

With slightly swollen conidiophore tips, sterigmata club-shaped, laterally placed. *A. clavatus*.

With hemispheric conidiophore tips, sterigmata terminal. *A. fumigatus*.

(b) Perithecia unknown.

1. With large conidiophore tip, elongate 80 to 100 μ by 500 to 800 μ . *A. giganteus*.

2. With smaller conidiophore, end spheric, or hemispheric.

With rough warty conidiophore. *A. flavus*.

With smoother conidiophore. *A. oryzae*.

2. Sterigmata branched.

(a) With rusty-brown mycelium. *A. versicolor*.

(b) Mycelium not rusty-brown.

End of conidiophore, club-shaped with lateral and terminal sterigmata.

A. pseudoclavatus.

End of conidiophore hemispheric with terminal sterigmata. *A. nidulans*.

B. With black, or dark-brown conidiospores.

1. Sterigmata unbranched. *A. calypratus*.

2. Sterigmata branched. *A. niger*.

C. With reddish-brown, yellowish-brown, or yellow conidiospores.

Sterigmata unbranched, spores coffee-brown. *A. Wentii*.

Sterigmata branched, spores yellow-brown. *A. ochraceus*.

The genus *Penicillium* is closely related to the genus *Citromyces*, which includes fungi causing citric acid fermentation in sugar media and which has a single whorl of conidia-bearing cells (sterigmata) at the tip of the conidiophore. All of the fungi with the penicillate type of fructification are grouped together in the form—genus *Penicillium*. The small and delicate conidiophore differs from that of *Aspergillus* in being divided into a row of short cells by transverse septæ. The conidiophores are branched and the upright branches bear the sterigmata as tufts of terminally disposed secondary branches. The conidiospores are pinched off from the sterigma and are arranged in chains. The whole inflorescence suggests a whisk, or a broom. The spores are of various shapes and sizes from spheric to ellipsoidal. Some have smooth walls, others are roughened. Several species show the tendency to form coremia (coremium), which are tufted forms of inflorescence. Four, or five, species are known to produce perithecia and ascospores, so that no satisfactory key can be based on perithecial and ascospore characters. The number of species which are associated with the ripening of cheeses, or which produce decay in fruits of various kinds is about six or seven. The species usually designated as *Penicillium glaucum* and *P. crustaceum* are included in the most recent paper by Thom under

Penicillium expansum (Fig. 243) which can always be obtained from apples decaying in storage. Colonies of this mould upon gelatin and potato, or bean agar, are green, becoming gray-green and later brown. The conidiophores are tufted into coremium-like clusters.

The conidia fructifications consist of one to three main branches bearing verticils of branchlets supporting crowded whorls of sterigmata. Conidiospores are elliptic 2 by 3.3μ , green, persisting in chains, when mounted.

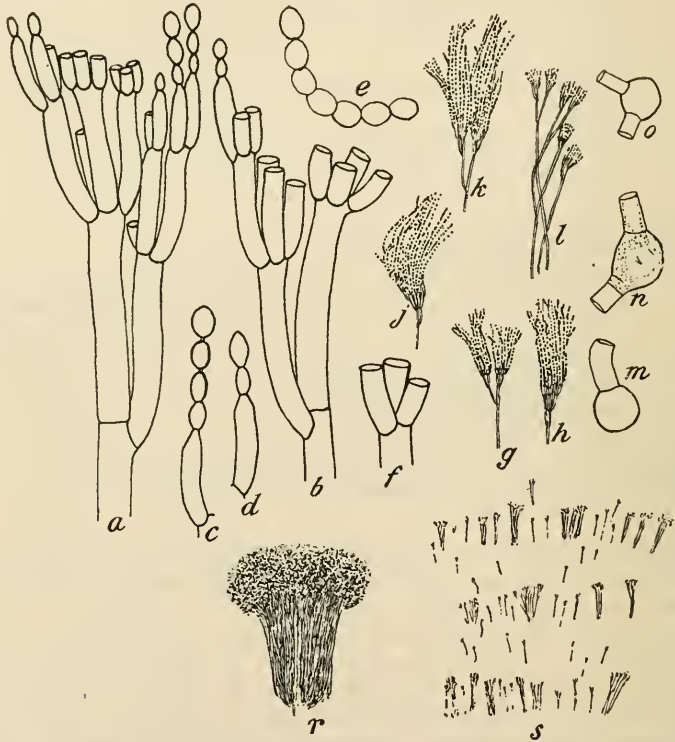

FIG. 243.—*Penicillium expansum*. *a, b, f*, Arrangement of branches of conidial fructification; *c, d, e*, conidiiferous cells and chains of conidiospores; *g, h, j, k, l*, sketches of fructification; *m, n, o*, germination of conidiospores; *r, s*, sketches showing in *s* loose aggregations of conidiophores, *r* coremium. (After Thom.)

Penicillium Roqueforti (Fig. 244) is the agent in the ripening of Roquefort, Gorgonzola and Stilton cheeses. Colonies on potato agar quickly become green, becoming a dirty brown when old. The velvety mycelium consists of radiating branching hyphæ giving an indefinite margin. The conidiophores arise separately and in acropetal succession from the growing parts of submerged hyphæ, 200 to 300μ

long and septate. The conidiospores are bluish-green, globose-cylindric, 4 to 5μ in diameter. Roquefort cheese is a hard rennet cheese made from the milk of sheep. Some imitations are made from cow's milk. The most striking characteristic of this cheese is the mottled, or marbled appearance of the interior due to the development of this fungus, which is the principal ripening agent. The manufacture of Roquefort cheese has been carried on for at least two centuries in the southeastern part of France, in the Department of Aveyron and the village of Roquefort. The curd is put into hoops, which are filled in three layers, a layer of bread crumbs penetrated with the hyphæ of *Penicillium Roqueforti* being placed between the first

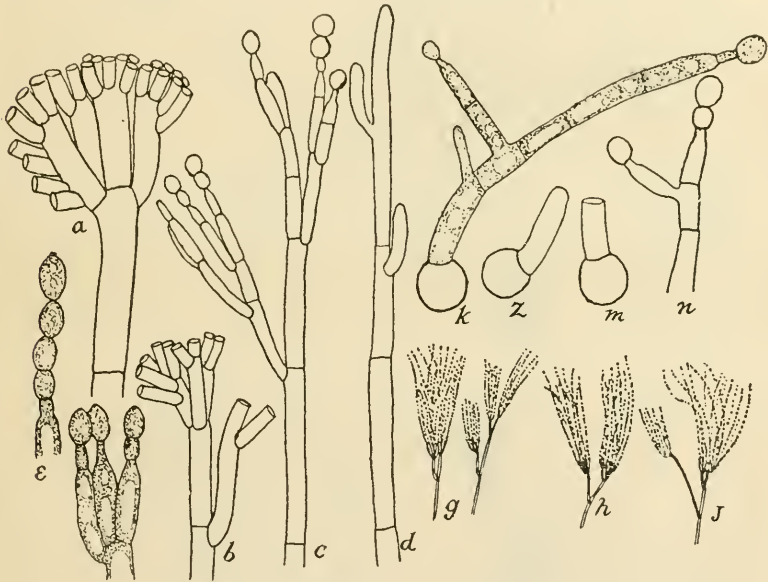

FIG. 244.—*Penicillium Roqueforti*. *a*, part of a conidiophore; *b*, *c*, other types of branching; *d*, young conidiophore, just branching; *e*, *f*, conidiiferous cells; *g*, *h*, *j*, diagrams of types of fructifications; *k*, *l*, *m*, *n*, germinating spores. (After Thom.)

and second and the second and third layers. The bread is prepared from wheat and barley flour, with the addition of whey and a trace of vinegar. It is baked and kept moist from a month to six weeks during which time it is penetrated by the green mould above mentioned. For use the bread is crumbled and sifted. The cheese is subjected to pressure, which is gradually increased for ten to twelve hours. It is turned usually one hour after putting into hoops. It is wrapped in cloth at the end of twelve hours and taken to the first curing room. The cloths are frequently changed during ten to twelve days. Formerly, the manufacture was carried on by shepherds but now as the industry is commercialized, the ripening is carried on in caves in the Roquefort region in which the air circulates freely and the

temperature is 40° to 45°C. When ripe, the cheeses are prepared for shipment by a covering of tin-foil properly inscribed with the manufacturer's name.

Penicillium Camemberti (Fig. 245).—The colonies of this important fungus on potato agar are at first effused and white changing in five to eight days to gray-

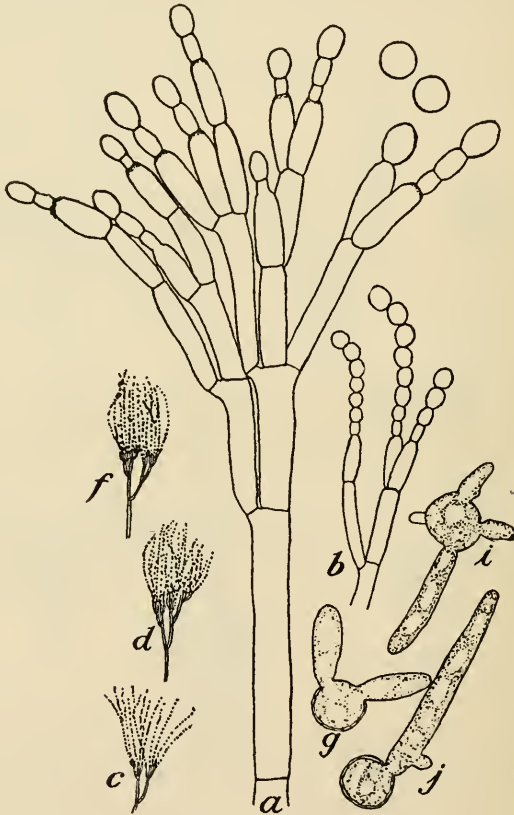

FIG. 245.—*Penicillium Camemberti*. a, Conidiophore with common type of branching with conidiospores; b, a common less-branched form; c, d, f, diagrams of large fructifications; g, i, j, germinating conidiospores. (From Bull. 82, Bureau of Animal Industry, also After Thom.)

green. The hyphæ are loosely felted, about 5 μ in diameter. The septate conidiophores are 300 to 800 μ in length and 3 to 4 μ in diameter, thin-walled often collapsing with age. Fructification about 175 μ tall, consisting of one main branch and one lateral branch, sparingly branched to produce the sterigmata which abstrict off ellipsoidal conidiospores, smooth and bluish-green by transmitted light, thin-

walled and commonly guttulate, 4.5 to 5.5μ in diameter. The growing and fruiting period is about two weeks. This green mould grows in Camembert and other soft cheeses, where it causes a breaking down of the casein. Camembert cheese is a soft rennet cheese made from cow's milk. A typical cheese is about four and a half inches in diameter and one and a quarter inches thick, and is sold in this country wrapped in paper and inclosed in a wooden box of the same shape. The cheese has a rind of

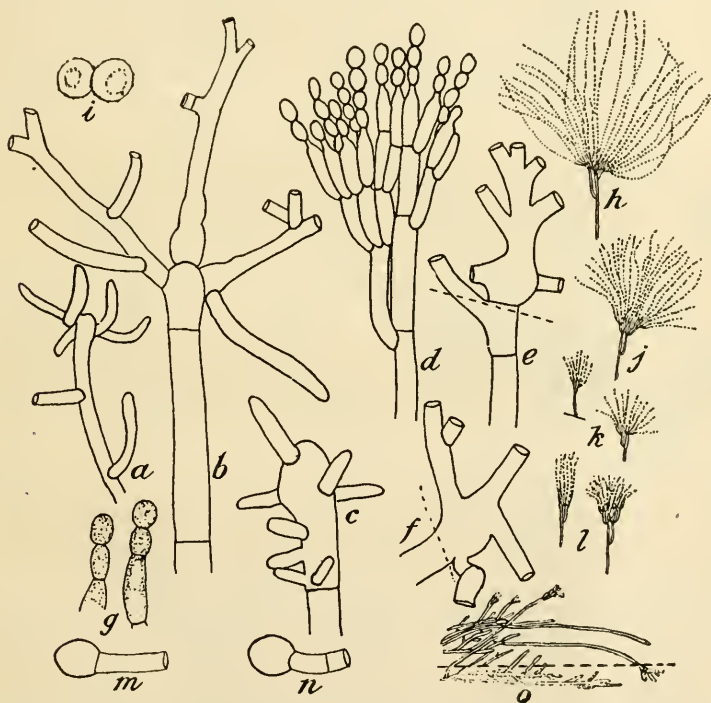

FIG. 246.—*Penicillium stoloniferum*. *a, b, c, e, f*, the types of branching at the tips of the "stolons" by which the species spread in substrata; *d*, conidial fructification; *h, j, k, l*, sketches of conidial fructifications of various ages; *g*, formation of conidial spores; *i*, ripe conidiospores; *m, n*, germination of conidiospores; *o*, rough diagram of habit. (After Thom.)

considerable thickness, which consists of moulds and dried cheese surrounding a yellowish, waxy, creamy, or almost fluid interior depending upon the ripeness of the cheese. Probably originated about 1791 in the Department of Orne in north-western France, the industry has extended into other departments of the French Republic. It is made from whole fresh milk, or from milk which has been skimmed in part. The curd which forms at about 80° to 85° is transferred to perforated tin forms, or hoops. These rest upon rush mats, which permit free drainage. After

draining, the cheese is frequently turned and in two or three days, it is carried to a well-ventilated room where the ripening process begins. Here it remains fifteen to twenty days when the surface becomes covered with *Penicillium Camemberti*, which gradually breaks down the casein.

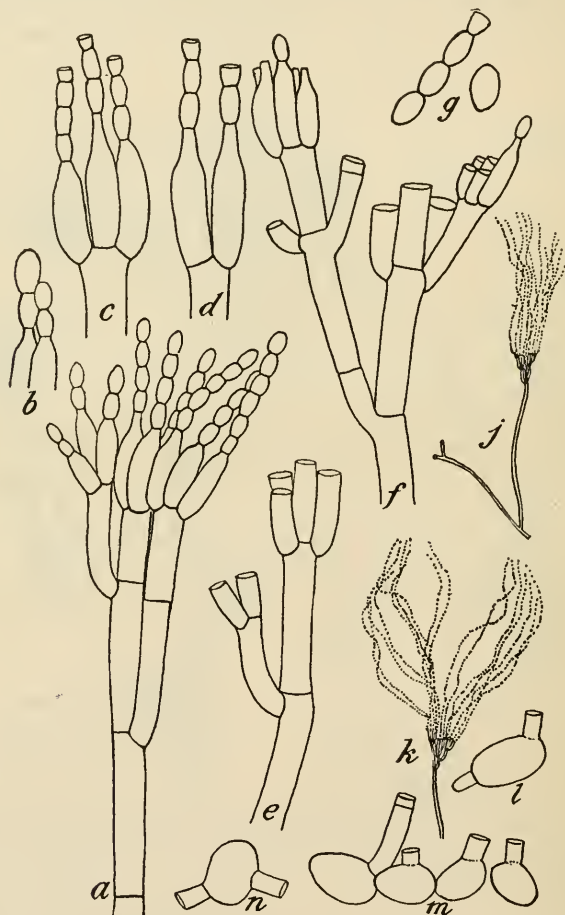

FIG. 247.—*Penicillium italicum*. a, b, c, d, e, f, g, types of branching in verticils and chains of conidiospores; j, k, sketches of conidial fructifications; l, m, n, swelling and germination of conidiospores. (After Thom.)

Penicillium stoloniferum (Fig. 246) grows on decaying fungi, Boleti, Polypori and in cultures from milk and ensilage. It has been collected repeatedly at Storrs, Conn., and once upon decaying *Boletus scaber* at the Jardin des Plantes in Paris, and

hence, it is probably widely distributed. Its stolon-producing character is very characteristic and diagnostic.

Penicillium italicum (Fig. 247) and *P. olivaceum* occur on tropic fruits, including pineapples, lemons, oranges, etc. The fungus causes extensive putrefaction in such fleshy fruits as the pineapple.

Penicillium brevicaulis (Fig. 248) grows on decayed paper and it has been recommended by Gosio for the detection of arsenic, since when grown in media with traces of arsenic, it forms the pungent compound diethylarsine. None of the species of *Penicillium* are pathogenic. About six to seven species of this genus are connected with the ripening of cheeses. For example, a little-known Norwegian cheese "Gammelost" has associated with its ripening, according to Johann Olsen, a green mould, *Penicillium aromaticum*, and so showing the unsatisfactory state of our

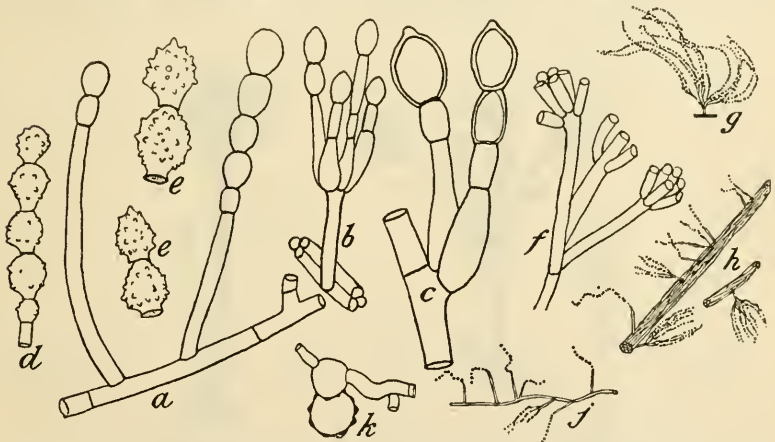

FIG. 248.—*Penicillium brevicaulis*. a, Conidiophores and simple chains of conidiospores; b, f, more complex conidial fructifications; c, two young chains of conidiospores; d, e, echinulate conidiospores; g, h, j, sketches of forms and habits of conidial fructifications; k, germinated conidiospores. (After Thom.)

knowledge about these fungi, this fungus may prove on close investigation to be identical with the one which works in Roquefort cheese.

As all of the species of *Penicillium* are readily cultivated and kept for some time in a satisfactory condition for study, they are especially useful in the systematic exercises which are essential in the training of competent mycologists. As the time which can be devoted to such a study is limited, the work can be varied by assigning, as unknowns, cultures of the different species of the genus *Aspergillus* to certain members of the class and cultures of *Penicillium* as "unknowns" to other members, and it may be advisable to interchange the material, so that all of the students in the class in mycology become acquainted with the similarities, as well as the differences displayed by fungi of the genera *Aspergillus* and *Penicillium*. It is better to distribute these moulds to the class in culture media in Petri dishes than in test-tubes, because

the removal of the material for study is more easily accomplished, and because the whole growth can be examined readily by placing the Petri dish on the stage of the microscope and examining with the low power. In mounting such fungi for study beneath a cover-glass 10 per cent. alcohol should be used to wet the spores and hyphæ, otherwise difficulty will be encountered with spores flowing together in mass and the hyphæ becoming knotted together. Thom, in his paper on the "Cultural Studies of Species of *Penicillium*," published as Bull. 118 of the U. S. Bureau of Animal Industry in 1910, recommends that the following media be prepared for the study of the species as his key for the identification of the species given below is based on their behavior upon the recommended culture media. For this purpose prepare the following media: (1) 15 per cent. gelatin ("gold label") in distilled water; (2) 15 per cent. gelatin in distilled water plus 3 per cent. cane sugar; (3) either bean or potato decoction plus 1.5 per cent. cane sugar; (4) bean or potato agar plus 3 per cent. cane sugar. Litmus solution may be added, if desired, when cultures are

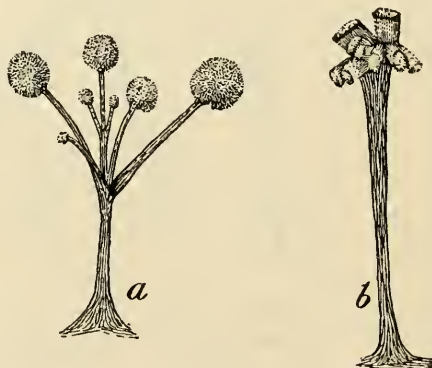

FIG. 249.—*Penicillium claviforme*. *a*, Coremium grown upon sugar media; *b*, coremium on gelatin free from sugar. (After Thom.)

made. Prepare Petri dishes with 10 c.c. of each of the media used and allow them to cool. Inoculate two or more Petri dishes of each medium with spores of the species to be distributed to the class. Incubate at 20°C. (the laboratory temperature is usually satisfactory). Have the members of the class examine at intervals of three days, or less, making naked-eye observations from above and below also with a hand lens and with the low power of the compound microscope. A drop of litmus solution at the margin of a colony can be used to test acidity, or alkalinity.

Have the class examine 1 and 2 for liquefaction; 2 and 4 for coremium and sclerotium formation which will call for continued examination for at least two weeks.

Below will be found two separate keys. One, after Thom, is a general key of species of *Penicillium* grown upon the above-recommended agar and gelatin media. The second key, after Buchanan, which includes the species of most economic importance, is based on the character of the substratum on which the fungi are found growing in a state of nature.

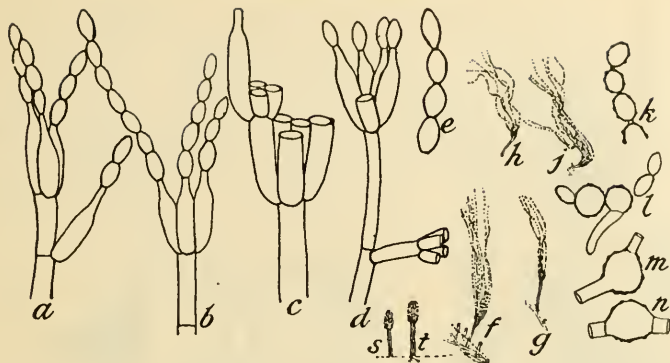

FIG. 250.—*Penicillium Duclauxii*. *a, b*, Conidial fructifications with young smooth conidiospores; *c, d, e*, conidial fructifications from potato-agar plate culture, more complex types; *f, g, h, j*, sketches of habit upon potato agar; *k*, ripe spores highly magnified to show delicate markings; *l, m, n*, germination of spores; *st*, coremium. (After Thom.)

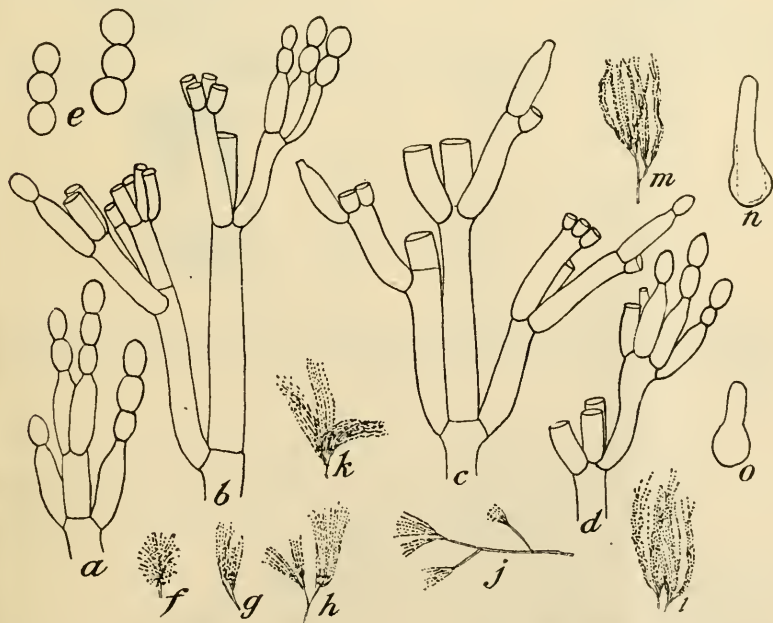

FIG. 251.—*Penicillium chrysogenum*: *a, b, c, d, e*, branching of conidial fructification from gelatin plates; *f, g, h, j, l, m*, sketches of conidial fructifications from potato-agar plates; *n, o*, germination of conidiospores. (After Thom.)

1. Key of Species Grown on Agar and Gelatin Media

A. Species fruiting typically by coremia (vertical and definite).

a. Coremia long (3 to 15 mm.).

1. Conidial masses strictly terminal, olive-green, fragrant. *P. claviforme* (Fig. 249).

2. Upper third of coremia fertile, conidia green. *P. Duclauxii* (Fig. 250).

aa. Coremia small.

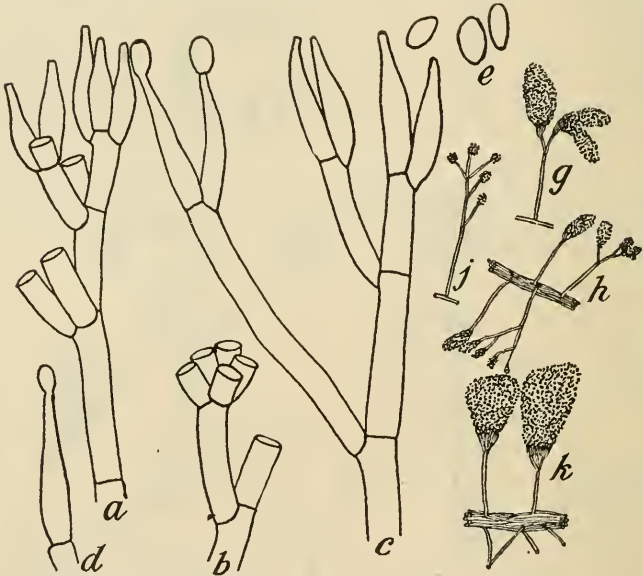

FIG. 252.—*Penicillium roseum*. a, b, c, Branching of conidial fructification, showing few cells of each verticil; d, e, conidiiferous cell and conidiospores; g, h, j, k, sketches of ripe fructification showing agglutination of conidiospores into slimy masses. (After Thom.)

1. Coremia definite, densely crowded, colony orange below. *P. granulatum*.

2. Coremiform character indicated in cultures by clustering of conidiophores, definite coremia only in old cultures, becoming large and definite upon apples. *P. expansum* (Fig. 243).

AA. Species not (or rarely) producing coremia in culture.

B. Species constantly producing sclerotia, or ascigerous masses.

b. Producing ascigerous masses, yellow, or reddish. *P. luteum*.

bb. Sclerotia appearing as white masses in old cultures. *P. italicum* (Fig. 247).

bbb. Sclerotia reddish or pink, globose or elliptic, 500 μ or less in diameter.

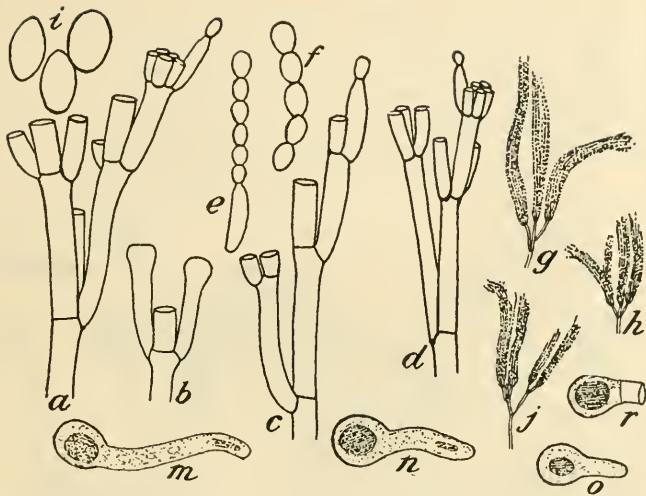

FIG. 253.—*Penicillium atramentosum*. a, b, c, d, branching of conidial fructifications showing unequal length of branching; e, f, conidiiferous cell and chain of conidiospores; g, h, j, sketches of conidial fructifications; i, conidiospores; m, n, o, r, germination of spores. (After Thom.)

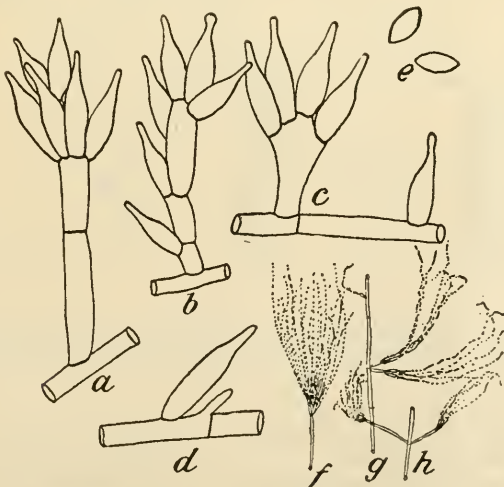

FIG. 254.—*Penicillium lilacinum*. a, b, c, Short conidiophores and verticils of conidiiferous cells; d, conidiiferous cell, solitary and sessile; e, conidia; f, g, h, sketches of conidial fructifications. (After Thom.)

- BB. Sclerotia not (or rarely) produced (under special conditions). Use gelatin cultures (1) and (2), compare agar cultures.
- C. Rapid liquefiers (abundant liquid in five to twelve days).
- D. With definite, strong ammoniacal odor.
1. Yellowish brown. spores rough. *P. brevicaule* (Fig. 248).
 2. White or cream, spores rough. *P. brevicaule* var. *album*.

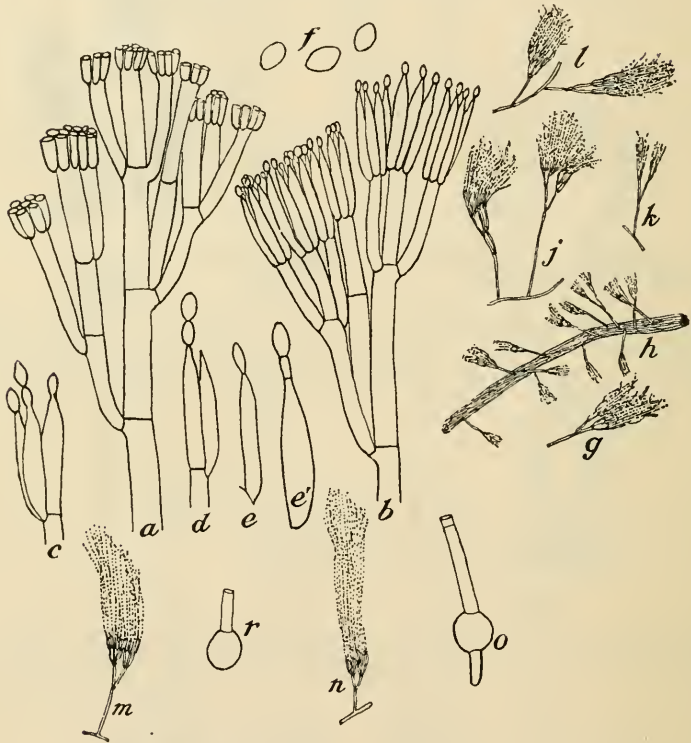

FIG. 255.—*Penicillium funiculosum*. a, b, c, d, e, f, conidial fructifications with conidiiferous cells and conidiospores; g, h, k, l, m, n, fructifications separate and borne upon hyphae and ropes of hyphae; o, r, germination of conidiospores. (After Thom.)

3. White or cream, spores smooth. *P. brevicaule* var. *glabrum*.
- DD. Without ammoniacal odor.
- E. With yellow coloration of liquefied gelatin (not of mycelium in reverse).
1. Colonies small, conidiophores 100 to 150 μ in length. *P. citrinum*.
 2. Colonies broadly spreading, conidiophores 250 to 300 μ . *P. chrysogenum* (Fig. 251).

EE. Without yellow color in liquefied gelatin (or slight traces only).

c. Colonies white to pink or salmon. *P. roseum* (Fig. 252).

cc. Colonies some shade of green.

f. Colonies floccose, margin spreading by stolons. *P. stoloniferum* (Fig. 246).

ff. Colonies velvety; surface growth of fruiting hyphæ only; conidiophores 200 to 400 μ long, with a verticil of branches; reverse and medium darkened in sugar media. *P. atramentosum* (Fig. 253).

CC. Liquefaction of gelatin none or slower than ten to twelve days, or only partial.

G. Colonies never green.

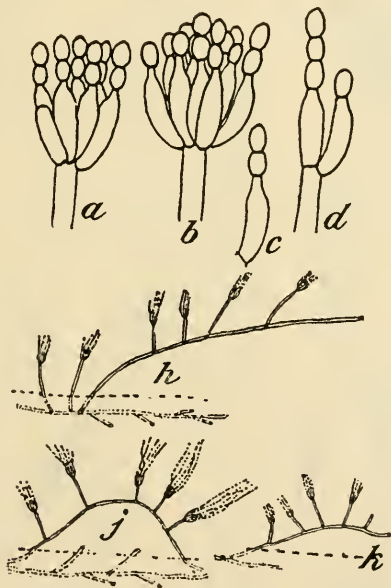

FIG. 256.—*Penicillium decumbens*. a, b, c, d, Conidial fructification with a single verticil of conidiiferous cells; h, j, k, sketches of conidial fructifications. (After Thom.)

g. Colonies yellowish-brown, spores elliptic. *P. divaricatum*.

gg. Colonies white to lilac, slow liquefier, fourteen to sixteen days. *P. lilacinum* (Fig. 254).

ggg. Colonies floccose white or creamy; conidiophores long, typically penicillate. *P. Camemberti* var. *Rogeri*.

GG. Colonies some shade of green.

H. Surface with hyphæ definitely in ropes or trailing, bearing numerous conidiophores, as short branches, distinctly traceable to their origin in such hyphæ.

h. Colonies usually red below and reddening the substratum.

1. Fruiting areas dark green. *P. funiculosum* (Fig. 255).
 2. Fruiting areas mixed yellow and green. *P. pinophilum*.
 hh. Colonies not producing red color.



FIG. 257.—*Penicillium bifforme*. *a*, *b*, *g*, Branching of conidial fructification; *c*, *d*, *e*, *f*, conidiiferous cells and conidiospores; *h*, *j*, *k*, sketches of conidial fructifications on potato agar; *l*, *m*, sketches of conidial fructifications on sugar gelatin; *o*, *r*, germination of conidiospores. (After Thom.)

1. Colonies gray, rarely greenish, very-loose floccose. *P. intricatum*.
 2. Colonies gray to green, hyphæ scattered, creeping. *P. decumbens* (Fig. 256).

HH. Surface hyphæ not in well-defined ropes, nor trailing.

i. Surface hyphæ woven floccose, course of hyphæ not traceable.

1. Gray-green, long conidiophores, no odor. *P. Camemberli* (Fig. 245).

2. Gray-green, shorter conidiophores, strong odor. *P. biforme* (Fig. 257).

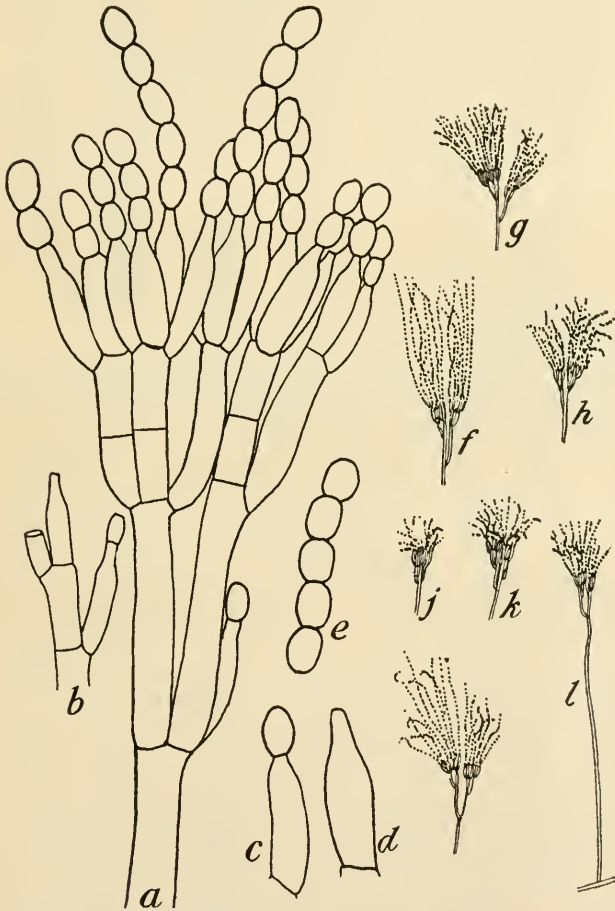

FIG. 258.—*Penicillium commune*. a, b, c, d, e, Conidial fructification with conidiospores; f, g, h, j, k, l, sketches of fructifications in various stages. (After Thom.)

ii. Surface growth at margin simple conidiophores, in older parts both floccose hyphæ and conidiophores.

1. Gray-greenish, branching of conidiophore rather loose, odor none or slight. *P. No. 22*.

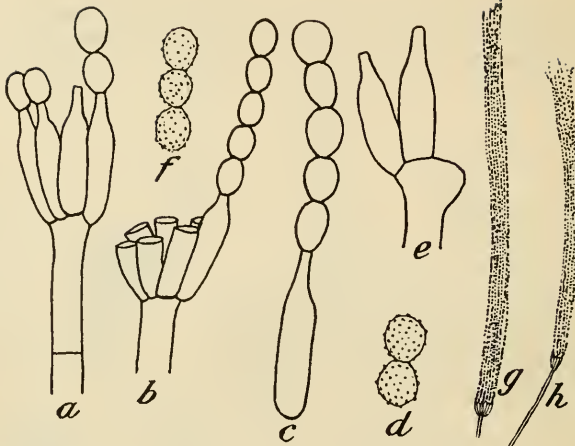

FIG. 259.—*Penicillium spinulosum*. *a, b*, Conidial fructifications, consisting of single verticils of conidiiferous cells; *c*, conidiiferous cell with chain of conidiospores (smooth); *d, f*, ripe echinulate conidiospores; *e*, swollen end of conidiophore; *g, h*, sketches of conidial fructifications. (After Thom.)

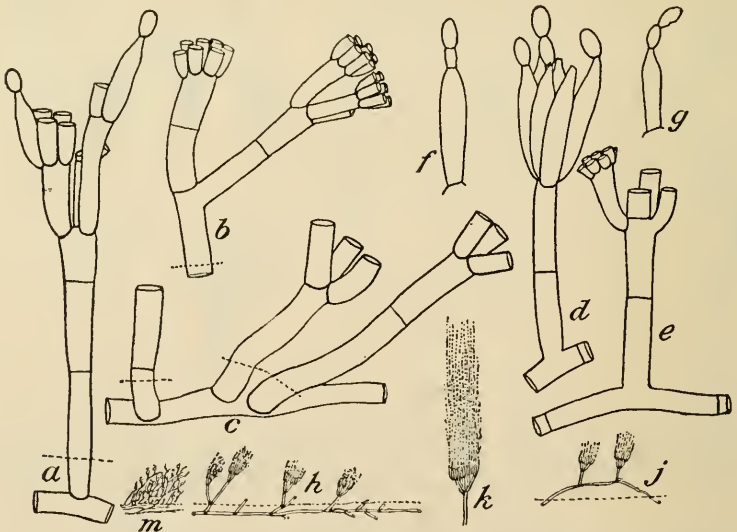

FIG. 260.—*Penicillium rubrum*. *a, b, c, d, e*, Whole conidiophores and the branching of conidial fructifications; *f, g*, conidiiferous cells and conidiospore formation; *h, j*, sketch of habit of growth; *m*, diagrammatic figure of a series of conidial fructifications. (After Thom.)

2. Green, conidial fructifications rather compact, odor definite, "mouldy."
P. commune (Fig. 258).
- iii. Fruiting surface velvety of simple conidiophores, or conidiophores borne so close to surface of substratum as to appear simple.
- j. Conidial mass a dense column of conidial chains.
 1. Column from a single verticil of sterigmata. *P. spinulosum* (Fig. 259).
 2. Column from a verticil of branchlets with verticillate cells and chains. *P. rubrum* (Fig. 260).
- jj. Elements of conidial fructifications not in a column.
 - k. Conidiospores smooth.
 1. Green, broadly spreading, ripe conidia globose, 4 to 5 μ . *P. Roqueforti* (Fig. 244).

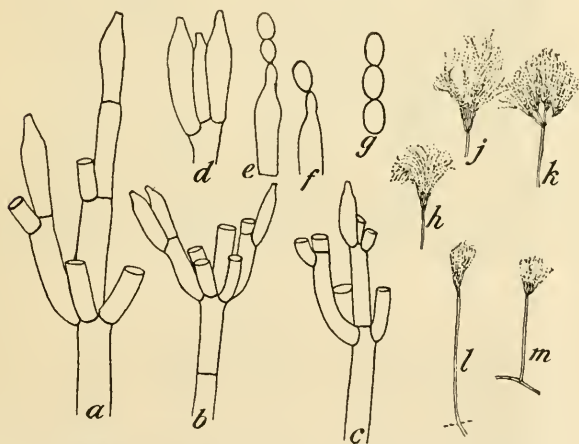

FIG. 261.—*Penicillium purpurogenum*. a, b, c, Conidial fructifications; d, e, f, g, conidiiferous cells and conidiospores; h, j, k, l, m, sketches of whole fructifications. (After Thom.)

2. Green, less spreading, conidiospores elliptic, uredium commonly purpled. *P. purpurogenum* (Fig. 261).
3. Gray or olive-green, conidiospores 5 to 7 by 3 to 5 μ . *P. digitatum* (Fig. 262).
- kk. Conidiospores delicately rugulose. *P. rugulosum* (Fig. 263).

2. Key of Species Determinable from Substrata. (After Buchanan.)

Cheese (Camembert and Brie).

1. Floccose, white unchangeable, no odor. *P. Camemberti* var. *Rogeri*.
2. Floccose, white to gray-green, no odor. *P. Camemberti* (Fig. 245).
3. Powdery, yellowish-white, spores smooth, ammoniacal odor. *P. brevicaulis* var. *glabrum*.

4. Powdery, yellowish-white, spores tuberculate, ammoniacal odor. *P. brevicaulis* var. *album*.
5. Forming yellowish-brown areas, spores rough, ammoniacal odor. *P. brevicaulis* (Fig. 248).

Cheese (Roquefort).

1. Green streaks inside the cheese. *P. Roqueforti* (Fig. 244).

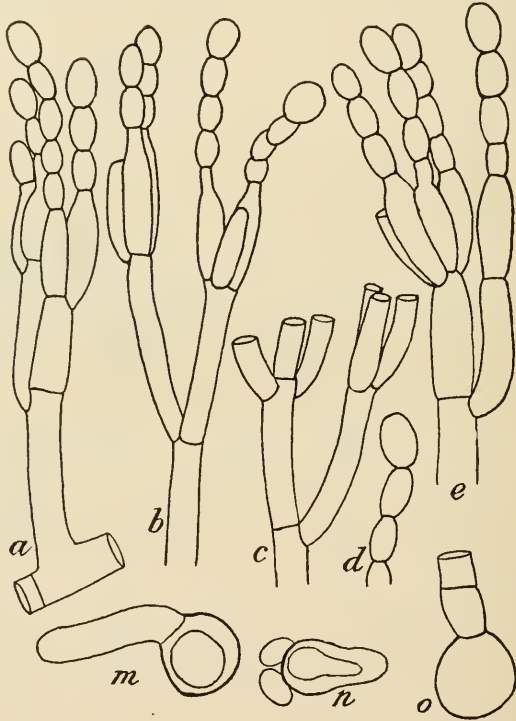

FIG. 262.—*Penicillium digitatum*. a, Whole conidiophore and fructification; b, c, d, e, types of branching and formation of conidiospores; m, n, o, germination of conidiospores. (After Thom.)

Citrus fruits.

1. Colonies of mould, blue-green. *P. italicum* (Fig. 247).
2. Colonies of mould, olive-green. *P. digitatum-olivaceum*.

Pomaceous fruits (apples, pears, etc.).

1. Blue-green colonies finally producing coremia. *P. expansum* (Fig. 243).

Polyporaceæ (Boleti, Polypori, etc.).

1. Colonies green (yellowish-green), spreading by stolons. *P. stoloniferum* (Fig. 246).

Wood (pine).

1. Producing orange to red stains in pine wood. *P. pinophilum*.

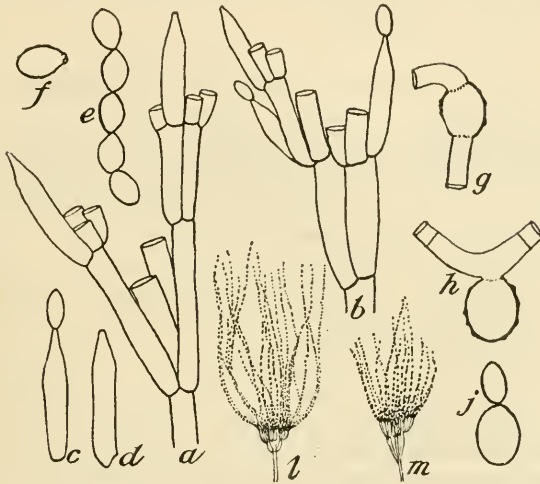

FIG. 263.—*Penicillium rugulosum*. *a*, *b*, Branching of conidiophore; *c*, *d*, *e*, conidiiferous cells and conidiospores; *f* fully ripe conidiospore; *g*, *h*, *j*, swelling and germination of conidiospore; *l*, *m*, diagram of conidial fructifications. (After Thom.)

APPENDIX VIII

KEYS TO THE GENERA OF THE ERYSIHACEÆ

(See Salmon, Ernest S.: A Monograph of the Erysiphaceæ Mem. Ton. Bot. Club IX, 1900.)

A. Perithecium inclosing only a single ascus.

(a) Appendage simple, filamentous, unbranched. 1 *Sphaerotheca*.

(b) Appendage dichotomously branched at end. 2 *Podosphæra*.

B. Perithecium containing many asci.

(a) Spores unicellular.

1. Perithecia with appendages.

* Appendages often basally swollen, never enlarged into a plate.

† Appendage unrolled at the end, or only slightly and irregularly curled.

‡ Appendages simple, or only irregularly branched.

§ Appendages mycelium-like, unbranched, or slightly irregularly branched. 3 *Erysiphe*.

§§ Appendages stiff, bristly, radially arranged, numerous. 4 *Pleochæta*.

‡‡ Appendages frequently dichotomously branched at apex. 5 *Microsphæra*.

†† Appendages more or less spirally coiled at the apex. 6 *Uncinula*.

** Appendages united at the base into a plate. 7 *Phyllactinia*.

2. Perithecia without appendages, sessile or mycelium. 8 *Erysibella*.

(b) Spores divided. 9 *Saccardia*.

KEY TO THE SPECIES OF SPHEROTHECA (After Salmon)

Brief Characterization.—Perithecia subglobose, ascus solitary, eight-spored. Appendages floccose, brown or colorless, spreading horizontally and often interwoven with the mycelium, simple or vaguely branched, frequently obsolete.

1. Mycelium persistent, thick, pannose, forming dense patches of special hyphæ in which the perithecia are more or less immersed. (2)
Mycelium without these characters. (4)
2. Persistent mycelium usually satiny and shining, white, sometimes becoming gray, or pale brown. 2 *pannosa*.
Persistent mycelium dark brown. (3)
3. Inner wall of perithecium separating from the outer, hyphæ of persistent mycelium very tortuous. 4 *lanestræ*.
Inner wall not separating, hyphæ straighter. 3 *mors-uvæ*.
4. Perithecia 60 to 78 μ in diameter, ascus 60 to 75 by 42 to 50 μ , inner wall of perithecium separating from the outer. 5 *phytoptophila*.
Perithecia 50 to 120 μ in diameter, ascus 45 to 90 by 50 to 72 μ ; inner wall scarcely separating. (5)
5. Cells of outer wall of perithecium 10 to 20 μ wide, averaging 15 μ . 1 *humuli*.
Cells 20 to 30 (rarely 40) μ wide, averaging 25 μ . 1 *humuli* var. *fuliginea*.

KEY TO SPECIES OF PODOSPHÆRA (After Salmon)

Brief Characterization.—Perithecia globose, or globose-depressed; ascus solitary, subglobose; spores eight. Appendages equatorial or apical, branches simple and straight, or swollen and knob-shaped; very rarely of two kinds: one set apical, brown, rigid, unbranched or rarely one to two times dichotomous at the apex; the other set basal, short, flexuous, simple, or vaguely branched, frequently obsolete.

1. Basal appendages present, apical appendages usually unbranched. 4 *leucotricha*.
Basal appendages absent. (2)
2. Appendages erecto-fasciculate, springing from near the apex of the perithecium. (3)
Appendages more or less spreading and equatorially inserted. (4)
3. Appendages six to twelve and one-half times the diameter of the perithecium, colorless, or occasionally pale brown toward the base. 2. *Schlectendalii*.
Appendages one to eight times the diameter of the perithecium, dark brown for more than half their length. 1 *oxyacanthæ* var. *tridactyla*.
4. Appendages colorless, or faintly tinged with brown at the base, branches of apex not swollen. 3 *biuncinata*.

Appendages dark brown for more than half their length, ultimate branches of the apex knob-shaped. 1 *oxyacanthæ*.

KEY TO SPECIES OF ERYSIPIHE (After Salmon)

Brief Characterization.—Perithecia globose, or globose-depressed, sometimes becoming concave; asci several, two- to eight-spored. Appendages floccose, simple or irregularly branched (never with a definite apical branching) sometimes obsolete, usually more or less similar to the mycelium and interwoven with it, very rarely (*E. tortilis*) brown, assurgent and fasciculate.

1. Asci (of mature perithecia) not containing spores on living host plant. (2)
Asci (of mature perithecia) containing spores.
2. Perithecia large, 135 to 280 μ in diameter, averaging 200 μ , more or less immersed in the lanuginose persistent mycelium. 4 *graminis*.
Perithecia smaller, 80 to 140 μ , not immersed in the lanuginose mycelium. (3)
3. Haustoria lobed. 3 *galeopsidis*.
Haustoria not lobed. 2 *cichoracearum*.
4. Asci two-spored, rarely (and never uniformly) three-spored. (5)
Asci three- to eight-spored, rarely (and never uniformly) two-spored. (8)
5. Perithecia 52 to 60 μ in diameter; asci three, 48 to 50 by 28 to 36 μ . 8 *trina*.
Perithecia 80 to 240 μ in diameter; asci more than three, larger. (6)
6. Perithecia large, becoming pezizoid, 135 to 240 μ in diameter, usually about 200 μ ; asci seven to thirty-eight, usually about twenty, 75 to 110 μ long, averaging 90 μ , spores 28 to 40 μ long, averaging 32 by 18 μ long. 6 *taurica*.
Perithecia 80 to 140 μ (very rarely 100 to 175); asci four to twenty-five (very rarely as many as thirty-six), usually ten to fifteen, 58 to 90 μ long; spores 20 to 28 μ long, averaging 34 by 14 μ . (7)
7. Haustoria lobed. 3 *galeopsidis*.
Haustoria not lobed. 2 *cichoracearum*.
8. Perithecia 65 to 180 μ in diameter, usually about 90 μ ; asci usually few, two to eight, rarely as many as twenty-two, 46 to 72 (rarely 80) μ long. (9)
Perithecia larger, 130 to 280 μ in diameter, averaging 180 to 200 μ ; asci, nine to forty-two, 70 to 115 μ long.
9. Appendages very long, ten to twenty times the diameter of the perithecium, assurgent and fasciculate. 5 *tortilis*.
Appendages long or short, spreading horizontally, often interwoven with the mycelium. 1 *polygani*.
10. Perithecia more or less immersed in the lanuginose persistent mycelium. 4 *graminis*.
Perithecia not immersed in a lanuginose persistent mycelium. (11)
11. Spores four to six, 20 to 22 by 10 to 12 μ . 1 *polygani* var. *sepulta*.
Spores eight, rarely six or seven, somewhat roundish, 16 to 20 by 10 to 15 μ . 7 *aggregata*.

KEY TO SPECIES OF *MICROSPHÆRA* (After Salmon)

Brief Characterization.—Perithecia globose to globose-depressed; asci several, two- to eight-spored. Appendages not interwoven with the mycelium, branched in a definite manner at the apex, which is usually several times dichotomously divided, and often very ornate, rarely (*M. astragali*) undivided, or once dichotomous.

1. Asci two-spored, appendages densely crowded, flaccid, about equalling the diameter of the perithecium. 6 *Mougeotii*.
Asci more than two-spored. (2)
2. Appendages two and one-half to seven times the diameter of the perithecium, usually much contorted and angularly bent, apical branching very irregular and lax, with the branches very flexuous and more or less curled. 9 *euphorbiæ*.
Appendages long or short without the above characters. (3)
3. Tips of some or all of the ultimate branches of the appendages recurved. (4)
Tips not recurved. (11)
4. Appendages eight to twelve times the diameter of the perithecium. 10 *Guarinonii*.
Appendages less than eight times the diameter of the perithecium. (5)
5. Appendages long and flaccid. (6)
Appendages short, not exceeding two and one-half times the diameter of the perithecium, not flaccid. (8)
6. Apex of appendages much branched, branching ornate, more or less close spores 22 to 26 by 12 to 15 μ . 4 *alni* var. *extensa*.
Apex less branched, more or less widely forked, or branching close and simple, spores 18 to 23 by 9 to 13 μ . (7)
7. Appendages usually three and one-half, not exceeding five and one-half times the diameter of the perithecium, asci three to seven, ovate-globose, 38 to 48 μ long. 4 *alni* var. *divaricata*.
Appendages two and one-half to eight times the diameter of the perithecium, asci two to sixteen, ovate-oblong, 45 to 72 μ long. 4 *alni* var. *vaccinii*.
8. Appendages more or less contorted, apical branching very lax and irregular. 4 *alni* var. *ludens*.
Appendages not contorted, apical branching closer and regular. (9)
9. Tips of the ultimate branches of the appendages not all regularly and distinctly recurved. 4 *alni* var. *loniceræ*.
Tips all regularly and distinctly recurved. (10)
10. Axis of some of the appendages not dividing dichotomously at the apex, but bearing sets of opposite branches. 4 *alni* var. *calocladophora*.
Appendages regularly dichotomous at apex. 4 *alni*.
11. Appendages three to seven times the diameter of the perithecium, colored nearly to apex. 8 *Russellii*.
Appendages colorless. (12)
12. Appendages long and penicillate. (13)
Appendages not penicillate. (15)

13. Apex of appendages often undivided, or irregularly one to two times dichotomous. 3 *astragali*.
Apex more divided. (14)
14. Appendages four to six times the diameter of the perithecium, branching diffuse and irregular. 13 *Bäumleri*.
Appendages two and one-half to five and one-half times the diameter of the perithecium, apex more divided, branching closer. 2 *euonymi*.
15. Branching of the appendages lax, irregular. (16)
Branching closer and regular. (17)
16. Appendages two to four times the diameter of the perithecium, not contorted, ultimate branches long, forming a narrow fork. 7 *diffusa*.
Appendages one to two times the diameter of the perithecium, more or less contorted, branching more irregular, with short ultimate branches. 4 *alni* var. *ludens*.
17. Apex of appendages with very short primary and secondary branches more or less digitate. 5 *grossulariæ*.
18. Apex with short, widely spreading, usually curved ultimate branches. 4 *alni* var. *loniceræ*.
Apex with long, straight ultimate branches, not widely spreading. 1 *berberidis*.

KEY TO THE SPECIES OF UNCINULA

Brief Characterization.—Perithecia globose to globose-depressed; asci several, two- to eight-spored; appendages simple, or rarely (*U. aceris*) once or twice dichotomously forked, uncinata at the apex, usually colorless, rarely dark brown at base or throughout.

1. Appendages colored. (2)
Appendages colorless. (3)
2. Appendages colored for half their length or more. 5 *necator*.
Appendages colored only at base (up to first septum). 16 *australiana*.
3. Asci two- to three-spored. (4)
Asci four- to eight-spored. (6)
4. Asci more than thirty, perithecia very large, 215 to 320 μ in diameter. 12. *polychata*.
Asci four to twenty, perithecia 85 to 165 μ in diameter. (5)
5. Appendages, nine to twenty-five, perithecia average 95 μ in diameter, asci three to six. 4 *clandestina*.
Appendages fifty to one hundred and thirty, perithecia average 130 μ , asci eight to twenty. 8 *macrospora*.
6. Appendages all simple. (7)
Appendages some or all branched. (20)
7. Appendages delicate, narrow, 3 to 4 μ wide, asci four- to seven-spored. (8)
Appendages stouter, wider, or if narrow with asci eight-spored. (10)
8. Asci about twenty-five, perithecia 150 to 200 μ diameter. 13 *confusa*.
Asci five to eight, perithecia 86 to 122 μ in diameter. (9)

9. Appendages fifty to one hundred and sixty, one-half to three-fourths diameter of perithecium. 7 *parvula*.
Appendages twenty-four to forty-six, one and one-fourth to two times, diameter of perithecium, often geniculate. 11 *geniculata*.
10. Appendages stout, 7 to 8 μ wide near the base. (11)
Appendages narrower near the base. (12)
11. Appendages very few, six to twelve, enlarged upward. 15 *Delavay's*.
Appendages crowded, twenty to thirty-six, scarcely or not at all enlarged upward. 18 *Sengokui*.
12. Appendages abruptly flexuose, or angularly bent. (13)
Appendages straight. (14)
13. Appendages about equalling diameter of perithecium, flexuose above, not angularly bent, spores usually eight. 9 *flexuosa*.
Appendages one to two, usually one and one-half to two times diameter of perithecium, more or less angularly bent, spores four to six, rarely seven. 1 *salicis* var. *Miyabei*.
14. Appendages thick-walled, refractive, or rough at base. (15)
Appendages thin-walled throughout. (17)
15. Mycelium persistent, densely compacted, perithecia 158 to 268 μ in diameter. 2 *aceris* var. *Tulasnei*.
Mycelium evanescent, or subsistent, perithecia 64 to 146 μ in diameter. (16)
16. Asci ovate or elliptic-oblong, 24 to 30 μ wide, spores 16 to 20 by 8 to 10 μ . 3 *prunastri*.
Asci broadly ovate to subglobose, 34 to 40 μ wide, spores 20 to 25 μ by 10 to 13 μ . 10 *Clintonii*.
17. Asci four- to six-spored. 1 *salicis*.
Asci seven- to eight-spored. (18)
18. Perithecia 168 to 224 μ in diameter, appendages not exceeding diameter of perithecium. 6 *circinata*.
Perithecia 76 to 138 μ in diameter, appendages one and one-fourth to two and one-half times diameter of perithecium. (19)
19. Perithecium 120 to 138 μ in diameter, appendages thirty-five to sixty, mycelium persistent, more or less densely compacted. 14 *australis*.
Perithecia 76 to 105 μ in diameter, appendages ten to twenty-eight, mycelium evanescent. 17 *fraxinis*.
20. Mycelium densely compacted, appendages mostly simple. 2 *aceris* var. *Tulasnei*.
Mycelium not densely compacted, appendages all or nearly all branched. 2 *aceris*.

APPENDIX IX

Collection and Preservation of the Fleishy Fungi.—In the collection of the higher fungi, it is of the utmost importance that certain precautions be employed in obtaining all parts of the plant, and furthermore that care be exercised in handling in order not to remove or efface delicate characters. Not only is it important for the

beginner, but in many instances an expert may not be able to determine a specimen which may have lost what undoubtedly seems to some, trivial marks. The suggestions given here should enable one to collect specimens in such a way as to protect these characters while fresh, to make notes of the important evanescent characters and to dry and preserve them properly for future study. For collecting a number of specimens under a variety of conditions the following list of things is recommended.

Implements.—One or two oblong or rectangular hand baskets, capacity 8 to 12 quarts.

One rectangular zinc case with a closely fitting top (not the ordinary botanic case).

Half a dozen or so tall pasteboard boxes, or tins, 3 by 3, or 4 by 4, by 5 inches deep, to hold certain species in an upright position.

A quantity of tissue paper cut 8 by 10, or 6 by 8 inches. - Small quantity of waxed tissue paper for wrapping viscid or sticky plants.

Trowel, a stout knife, a memorandum pad and pencil.

In gathering specimens, care should be taken to avoid leaving finger marks where the surface of the stem, or cap, is covered with a soft and delicate outer coat. Also a little careless handling will remove such important characters as a frail volva, or annulus, which are absolutely necessary to recognize in a species. Having collected the plants they should be placed properly in the basket, or collection case. Those which are quite firm, and not long and slender can be wrapped with tissue paper (waxed if the specimen is sticky), and placed directly in the basket with some note or number to indicate habitat, or other peculiarity, which it is desirable to make at the time of collection. The smaller, more slender and fragile specimens can be wrapped in tissue paper made in the form of a narrow funnel and the ends then twisted. The specimens should be placed in the basket, or case, in such a way as to prevent jostling with the gill surfaces downward so that any loose sand, or other material shall not fall between the gills where it is difficult to remove such gritty substances.

Field Notes.—The field notes should include data on the place where the fleshy fungi grew, the kind and character of the soil, in open field, roadside, grove, woods, on ground, leaves, sticks, stumps, trunks, rotting wood, or on living trees, etc.

Sorting.—This should be done in a room with plenty of table room. This sorting should be done at once as some forms deliquesce rapidly, others are attacked by insects, while others dry rapidly, so as to lose their shape and evanescent characters. Specimens to be photographed should be attended to at once. Some of the specimens can be kept for spore prints, others must be preserved for the herbarium.

Drying Method.—Frequently the smaller specimens will dry well when left in the room, especially in dry weather, or better, if they are placed where there is a draft of air. Some dry them in the sun. The most approved method is by artificial heat. Two methods are applicable.

1. A tin oven 2 by 2 feet and 2 to several feet high with one side hinged as a door,

¹ Consult ATKINSON, GEORGE F.: *Mushrooms, Edible and Poisonous, Etc.*, Chapter XVII.

and with several movable shelves of perforated tin, or of wire netting; a vent at the top and perforations around the sides at the bottom to admit air. The object of such an oven is to provide for a constant current of air from below upward between the specimens. This may be heated, if not too large, with a lamp, though an oil stove, gas jet, or heater, is better. The specimens are placed on the shelves with the accompanying notes or numbers.

2. An old cook stove can be used with wire screens 3 by 4 feet, one above the other, placed over it. Large numbers of fleshy toadstools can be dried on such frames. A more approved drying oven would be the revolving gas oven manufactured by G. S. Blodgett, Burlington, Vermont.

When the plants are dried, they become brittle but if exposed to the air a good many kinds absorb moisture from the air so that they become pliant and can be pressed flat, so as not to crush the gills and placed in paper envelopes for mounting on the herbarium sheets.

When placed in herbarium they should be poisoned with a saturated solution of alcohol and corrosive sublimate to which a spoonful of liquid carbolic acid is added. They should then be air-dried.

Some of the specimens when there are a number of duplicates can be placed in museum jars in 75 per cent. alcohol.

A solution of strychnine can be used for poisoning fleshy fungi.

Sulfate of strychnine,	$\frac{1}{8}$ ounce.
Warm water,	4 or 5 ounces.
Alcohol,	2 ounces.

Paper for Spore Prints.—For the identification of many species of fleshy fungi it is necessary to make spore prints. This is best done by breaking off the stipe, if present, close to the under surface of the cap, or pileus, and then placing the cap gills down on black and white paper placed side by side. Half of the gill surface should rest on the black paper and half on the white paper, so that if the spores are white, they will make an impression on the black paper, and if dark-colored, they will leave an imprint on the white paper.

In all cases where a spore print is made the plant should be covered with a bell glass to exclude currents of air. Such unprepared paper will save time in the identification. Where, however, it is desired to obtain fancy spore prints, perfect caps must be cut from the stipe and placed gill downward on paper prepared with some gum arabic, or similar adhesive substance, while the paper is still moist with the fixative, so as to glue the spores as they fall to the surface of the paper. The specimens should then be covered by a bell jar as previously directed.

Good spore prints, thus obtained, can be used for class demonstrations by mounting between a piece of heavy photographic cardboard and a piece of glass. It is easy to passepartout the glass and the paper as a museum specimen.

Blank for Note-taking.

No. _____ Locality _____
 Date _____ Name of collector _____
 Weather _____

Habitat.—If on ground, low or high, wet or dry; kind of soil; on fallen leaves, twigs, branches, logs, stumps, roots, whether dead or living. Kind of tree; in open fields, pastures, etc., woods, groves, etc. Mixed woods or evergreen, oak, chestnut, etc.

Plants.—Whether solitary, clustered, tufted, whether rooting or not, taste, odor, color when bruised or cut, and if change in color takes place after exposure to air.

Cap.—Whether dry, moist, watery in appearance (hygrophanous) slimy, viscid, glutinous; color when young, when old; whether free from the cuticle and easily rubbed off. Shape of cap.

Margin of Cap.—Whether straight or incurved when young; whether striate, or not, when moist.

Stem.—Whether slimy, viscid, glutinous, kind of scales, if not smooth, whether striate, dotted, granular color; when there are several specimens test one to see if it is easily broken out from the cap, also to see if it is fibrous, or fleshy, or cartilaginous (firm on the outside, partly snapping and partly tough). Shape of the stem.

Gills or Tubes.—Color when young, old, color when bruised, and if color changes whether soft, waxy, brittle, or tough; sharp or blunt, plane or serrate edge.

Milk.—Color if present, changing after exposure, taste.

Veil (Inner veil).—Whether present or not, character, whether arachnoid, and if so whether free from cuticle of pileus or attached only to the edge; whether fragile, persistent, disappearing, slimy, etc., movable, etc.

Volvæ.—Present or absent, persistent or disappearing, whether it splits at apex or is circumscribed, or all crumbly and granular or floccose, whether the part on the pileus forms warts, and then the kind, distribution, shape, persistence, etc.

Ring.—Present or absent, fragile, or persistent, whether movable, viscid, etc.

Spores.—Color when caught on paper.

Estimation of Spore Numbers.—Paper containing spores is placed in distilled water. The whole is stirred vigorously until the spores have been washed off the paper. A Leitz counting apparatus is then employed and the number of spores per square is counted. Another method is to count spores of *Coprinus comatus*, for example *in situ*. For details see BULLER, *Researches on Fungi*, p. 82.

APPENDIX X

LIST OF KEYS TO FLESHY FUNGI AND SELECTED KEYS OF FLESHY FUNGI

This list includes the common accessible keys which beginners, amateurs and students will find useful in the determination of all the conspicuous fungi. The list is taken from the *Mycological Bulletin*, Vol. III: 174; 178-179; 182-183; 185-186, edited by W. A. KELLERMAN.

Amanita. LLOYD: *Volvæ of U. S.*, 3, 4, 5, 6, 1898.

McILVAINE: *One Thousand American Fungi*, 6, 1900.

MORGAN: *Journ. Mycol.*, 3: 25, March, 1887.

PECK: *Rep. N. Y. State Mus.*, 23: 68, 1873; 33: 40, 1880; 48: 310, 1895.

Amanitopsis. BEARDSLEE: *Notes on the Amanitas of So. Appalachians*, Part I, Lloyd Library, September, 1902.

- LLOYD: *Volvæ* of the U. S., 8, 9, 1895.
- Agaricus. McILVAINE: *One Thousand American Fungi*, 332, 1900.
- PECK: *Rep. N. Y. State Mus.*, 48: 231, 1895.
- Armillaria. PECK: *Rep. N. Y. State Mus.*, 43: 41, 44, 1890.
- Boletinus. NINA L. MARSHALL: *Mushroom Book*, 44, 102, 1901.
- Boletus. McILVAINE: *One Thousand American Fungi*, 406, 421, 423, 430, 436, 438, 444, 453, 459, 471, 1900.
- PECK: *Rep. N. Y. State Mus.*, 23: 127, 1873; 37: 58, 1884; 48: 292, 1895.
- Bull. N. Y. State Mus.*, 1: 58, May, 1887; 2: 82, 83, 106, 114, 123, 131, 138, 145, 151, September, 1889.
- Bovista. LLOYD: *Myc. Notes*, 12: 114, December, 1902.
- Bovistella. LLOYD: *Myc. Notes*, 23, 1906.
- Catostoma. KELLERMAN: *Journ. Mycol.*, 9: 239.
- LLOYD: *Myc. Notes*, (214), 13: 121, February, 1903.
- Cantharellus. PECK: *Rep. N. Y. State Mus.*, 23: 121, 1873; 37: 35, 1884. *Bull. N. Y. State Mus.*, 1: 35, May, 1887.
- Claudopus. McILVAINE: *One Thousand American Fungi*, 266, 1900.
- PECK: *Rep. N. Y. State Mus.*, 39: 67, 1886.
- Clavaria. McILVAINE: *One Thousand American Fungi*, 513, 1900.
- PECK: *Rep. N. Y. State Mus.*, 24: 104, 1873.
- Clitocybe. MORGAN: *Journ. Cin. Soc. Nat. Hist.*, 6: 67, 1883.
- PECK: *Rep. N. Y. State Mus.*, 23: 76, 1873; 48: 270, 1895.
- Clitopilus. BEARDSLEE: *Journ. Mycol.*, 11: 109, May, 1905. *Mycol. Bull.*, 3: 146, 1905.
- PECK: *Rep. N. Y. State Mus.*, 42: 40, 1889.
- Collybia. LLOYD: *Mycol. Notes*, 34, 37, 41, December, 1900.
- MORGAN: *Journ. Cin. Soc. Nat. Hist.*, 6: 70, 1883.
- PECK: *Rep. N. Y. State Mus.*, 23: 78, 1873.
- Coprinus. PECK: *Rep. N. Y. State Mus.*, 23: 103, 1873; 48: 241, 1895.
- MASSE, G.: *Annals of Botany*, X: 123-184, 1896.
- Cortinarius. EARLE: *Torreya*, 2: 169-172; 180-3, November, December, 1902.
- KAUFFMAN: *Bull. Torr. Bot. Club*, 32: 333, 318, June, 1905.
- PECK: *Rep. N. Y. State Mus.*, 23: 105, 107, 108, 110, 112, 1873; 48: 245, 1895.
- Craterellus. PECK: *Rep. N. Y. State Mus.*, 37: 45, 1884. *Bull. N. Y. State Mus.*, 1: 45, May, 1887.
- Crepidotus. PECK: *Rep. N. Y. State Mus.*, 39.
- Entoloma. MORGAN: *Journ. Cin. Soc. Nat. Hist.*, 6: 99, 1883.
- PECK: *Rep. N. Y. State Mus.*, 62.
- Fomes. MURRILL: *Bull. Torr. Bot. Club*, 30: 225-6, April, 1903.
- Galera. PECK: *Rep. N. Y. State Mus.*, 23: 92, 1873; 46: 62, 1893.
- Ganoderma. MURRILL: *Bull. Torr. Bot. Club*, 29: 599-608, 1902.
- Geaster. LLOYD: 1902: 1-44.
- Hebeloma. PECK: *Rep. N. Y. State Mus.*, 23: 95, 1873; 63.
- Hydnum. McILVAINE: *One Thousand American Fungi*, 494, 1900.
- Hygrophorus. PECK: *Rep. N. Y. State Mus.*, 23: 112, 1873; 60.

- Hypholoma*. McILVAINE: One Thousand American Fungi, 353, 355, 1900.
PECK: Rep. N. Y. State Mus., 23: 98, 1873; 64.
- Inocybe*. EARLE: *Torreya*, 3: 168-170, 183-4, November, December, 1903.
- Lactarius*. EARLE: *Torreya*, 2: 139-41, 152-4, October, 1902.
PECK: Rep. N. Y. State Mus., 23: 114, 1873; 38-113, 1885.
- Lepiota*. MORGAN: *Journ. Cin. Soc. Nat. Hist.*, 6: 60, 1883.
PECK: Rep. N. Y. State Mus., 20: 70, 1873, 35.
- Lentinus*. EARLE: *Torreya*, 3: 35-8, March, 1903.
PECK: Rep. N. Y. State Mus., 23: 126, 1873; 62.
- Lycoperdaceæ*. McILVAINE: One Thousand American Fungi, 577, 1900.
MORGAN: *Cin. Soc. Nat. Hist.*, 12: 9, April, 1889.
UNDERWOOD: *Moulds, Mildews and Mushrooms*, 138, 1899.
LLOYD: *Of Australia, New Zealand and Neighboring Islands*, 1905: 1-42;
Of the U. S. *Mycol. Notes*, 20, June, 1905.
- Lycoperdon*. McILVAINE: One Thousand American Fungi, 590, 1900.
MORGAN: *Journ. Cin. Soc. Nat. Hist.*, 13: 6, April, 1891.
LLOYD: *In Europe*, *Mycol. Notes*, 19, May, 1905.
- Marasmius*. PECK: Rep. N. Y. State Mus., 23: 124, 1873 (Fig. 264).
- Mitremyces*. LLOYD: *Mycol. Notes*, (218), 13: 125, February, 1903.
- Mycena*. MORGAN: *Journ. Cin. Soc. Nat. Hist.*, 6: 73, 1883.
PECK: Rep. N. Y. State Mus., 23: 80, 1873.
- Naucoria*. PECK: Rep. N. Y. State Mus., 23: 91, 1873.
- Nidulariaceæ*. UNDERWOOD: *Moulds, Mildews and Mushrooms*, 142, 1899.
WHITE: *Bull. Torr. Bot. Club*, 29: 254, May, 1912.
LLOYD: 1906: 1-32.
- Omphalia*. MORGAN: *Journ. Cin. Soc. Nat. Hist.*, 6: 75, 1883.
PECK: Rep. N. Y. State Mus., 23: 84, 1873; 45: 33, 1893.
- Panaeolus*. PECK: Rep. N. Y. State Mus., 23: 100, 1873.
- Panus*. EARLE: *Torreya*, 3: 86-7, June, 1903.
- Paxillus*. PECK: Rep. N. Y. State Mus., 37: 30, 1884. *Bull. N. Y. State Mus.*
1: 30, May, 1887.
- Phallus*. McILVAINE: One Thousand American Fungi, 571, 1900.
- Pholiota*. MORGAN: *Journ. Cin. Soc. Nat. Hist.*, 6: 101, 1883.
PECK: Rep. N. Y. State Mus., 61.
- Pleurotus*. MORGAN: *Jour. Cin. Soc. Nat. Hist.*, 6: 77, 1883.
PECK: Rep. N. Y. State Mus., 39: 59, 1886; 48: 275, 1895.
- Pluteolus*. EARLE: *Torreya*, 3: 124-5, August, 1903.
PECK: Rep. N. Y. State Mus., 46: 59, 1893.
- Pluteus*. McILVAINE: One Thousand American Fungi, 243, 1900.
Morgan: *Journ. Cin. Soc. Nat. Hist.*, 6: 97, 1883.
PECK: Rep. N. Y. State Mus., 23: 61, 86, 1873; 38: 134, 1885.
- Polyporaceæ*. See MURRILL's bibliography.
- Polystictus*. LLOYD: *Mycol. Notes, Polyporoid Issue*, 1, February, 1908.
- Psalliota (Agaricus)*. PECK: Rep. N. Y. State Mus., 23: 97, 1893; 36: 42, 1883.
LLOYD: *Mycol. Notes*, 4, November, 1899.

- Psathyra. PECK: Rep. N. Y. State Mus., 64.
 Psathyrella. PECK: Rep. N. Y. State Mus., 23: 102, 1873.
 Psilocybe. PECK: Rep. N. Y. State Mus., 23: 99, 1873; 64.
 Russula. EARLE: Torreya, 2: 101-3, 117-19, July, August, 1902.
 PECK: Rep. N. Y. State Mus., 23: 120, 1873; 60.
 Stropharia. EARLE: Torreya, 3: 24, February, 1903.
 Tricholoma. MORGAN: Journ. Cin. Soc. Nat. Hist., 6: 65, 1883.
 PECK: Rep. N. Y. State Mus., 23: 73, 1873; 44: 39, 40, 44, 52, 56, 61, 1891;
 48: 266, 1895.
 Volvaria. LLOYD: *Volvæ of U. S.*, 10, 1898. McILVAINE: *One Thousand American Fungi*, 239, 1900.

APPENDIX XI

KEY TO AGARICACEÆ

The following key to the AGARICACEÆ is taken from Bulletin No. 175, U. S. Department of Agriculture, 1915, entitled "Mushrooms and other Common Fungi" by FLORA W. PATTERSON and VERA K. CHARLES, as well as the descriptions of a few of the more common forms selected by way of illustration.

The classification of the genera of Agaricaceæ is based upon the color of the spores. It is generally a comparatively easy matter to form an opinion regarding the color of the spores, but if any difficulty is experienced a spore print may be made. The process is very simple, and the results are quite satisfactory. The stem is removed from the specimen from which a print is desired and the cap placed face down on pieces of black and white paper placed side by side and covered with a tumbler. When the spores are mature they will fall in radiating lines on the pieces of paper. If a permanent spore print is desired, an alcoholic spray of white shellac may be employed. This is prepared by making a saturated solution of white shellac and then diluting it 50 per cent. with alcohol.

White-spored Agarics

Plants soft or more or less fleshy, soon decaying, not reviving well when moistened:

Ring or volva or both present—

- Volva and ring both present..... AMANITA.
 Volva present, ring absent..... AMANITOPSIS.
 Volva absent, ring present—

- Gills free from stem..... LEPIOTA.
 Gills attached to the stem..... ARMILLARIA.

Ring and volva both absent—

- Stem excentric or lateral..... PLEUROTUS.

Stem central—

Gills decurrent—

- Edge blunt, fold-like, forked..... CANTHARELLUS.
 Edge thin, stem fibrous outside..... CLITOCYBE.

- Edge thin, stem cartilaginous outside..... OMPHALIA.
 Gills sinuate, general structure fleshy..... TRICHOLOMA.
 Gills adnate or adnexed—
 Cap rather fleshy, margin incurved when young..... COLLYBIA.

Plants soft or more or less fleshy, etc.—Continued.

Ring and volva both absent—Continued.

Stem central—Continued.

Gills adnate or adnexed—Continued.

Cap thin, margin of the cap at first straight, mostly
 bell-shaped..... MYCENA.

Cap fleshy, gills very rigid and brittle, stem stout—

Milk present..... LACTARIUS.

Milk absent..... RUSSULA.

Gills various, often decurrent, adnate or only adnexed,
 edge thin, thick at junction of cap, usually distant,
 waxy..... HYGROPHORUS.

Plants coriaceous, tough, fleshy or membranaceous, reviving
 when moistened:

Stem generally central, substance of the cap noncontinuous
 with that of the stem, gills thin, often connected by veins
 or ridges (Fig. 264)..... MARASMIUS.

Stem central, excentric, lateral, or absent, substance of the cap
 continuous with that of the stem—

Edge of gills toothed or serrate..... LENTINUS.

Edge of gills not toothed or serrate..... PANUS.

Edge of gills split into two laminae and revolute..... SCHIZOPHYLLUM.

Plants corky or woody, gills inatradig..... LENZITES.

Rosy-spored Agarics

Stem excentric or absent and pileus lateral..... CLAUDOPUS.

Stem central:

Volva present, annulus wanting..... VOLVARIA.

Volva and annulus absent—

Cap easily separating from the stem, gills free..... PLUTEUS.

Cap confluent with the stem, gills sinuate..... ENTOLOMA.

Ochre-spored Agarics (Spores Yellow or Brown)

Gills easily separable from the flesh of the cap:

Margin of the cap incurved, gills more or less decurrent forked
 or connected with veinlike reticulations..... PAXILLUS.

Gills not easily separable from the flesh of the cap:

Universal veil present, arachnoid..... CORTINARIUS.

Universal veil absent—	
Ring present.....	PHOLIOTA.
Ring absent—	
Stem central—	
Cap turned in.....	NAUCORIA.
Cap not turned in.....	GALERA.
Stem excentric or none.....	CREPIDOTUS.

Brown-spored Agarics

Cap easily separating from the stem, gills usually free.....	AGARICUS.
Cap not easily separating from the stem, gills attached:	
Ring present.....	STROPHARIA.
Ring absent, veil remaining attached to the margin of the cap..	HYPHOLOMA.

Black-spored Agarics

Gills deliquescing, cap thin, ring present in some species.....	COPRINUS.
Gills not deliquescing:	
Margin of cap striate, gills not variegated.....	PSATHYRELLA.
Margin of cap not striate, gills variegated.....	PANÆOLUS.

The genus *Amanita* is easily recognized among the white-spored agarics in typical species, or early stages, by the presence of a volva and a veil. Young plants are completely enveloped by the volva, and the manner in which it ruptures varies according to the species. The volva may persist in the form of a basal cup, as rings, or scales, on a bulb-like base, or it may be friable and evanescent. The cap is fleshy, convex, then expanded. The gills are free from the stem, which is different in substance from the cap and readily separable from it.

This is a most interesting genus, on account of the great beauty of color and texture of many of its species and the fact that it contains the most poisonous of all mushrooms. While there are some edible species in the genus, the safest policy for the amateur is to avoid all mushrooms of the genus *Amanita*.

Amanita caesarea. Cæsar's Mushroom

Cap ovate to hemispherical, smooth, with prominently striate margin, reddish or orange becoming yellow; **gills** free, yellow; **stem** cylindrical, only slightly enlarged at the base, attenuated upward, flocculose, scaly below the annulus, smooth above; **ring** membranaceous, large, attached from its upper margin; **stem** and **ring** normally orange or yellowish, in small or depauperate specimens sometimes white; **flesh** white, yellow under the skin, and usually yellow next to the gills; **volva** large, distinct, white, sac-like.

Cap $2\frac{1}{2}$ to 4 or more inches broad; stem 3 to 5 inches long.

This species is variously known as Cæsar's agaric, royal agaric, orange Amanita,

etc. It has been highly esteemed as an article of diet since the time of the early Greeks. It is particularly abundant during rainy weather and may occur solitary, several together, or in definite rings. Although this species is edible, great caution should always be used in order not to confound it with *Amanita Frostiana*, which is poisonous. The points of difference of these two species are conveniently compared as follows:



FIG. 264.—Fruit bodies of fairy-ring toadstool (*Marasmius oreades*). (After Patterson, *Flora W.*, and Charles, Vera K., *Bull.* 175, U. S. Dept. Agric., pl. xix, Apr. 29, 1915.)

Species	Cap	Gills	Stem	Volva
<i>Amanita caesarea</i> .	Orange, smooth, occasionally with a few fragments of volva as patches.	Yellow	Yellow	White, sometimes breaking up into soft, fluffy masses.
<i>Amanita Frostiana</i>	Yellow, smooth or with yellowish scales.	Yellow or tinged with yellow.	White or yellow.	Yellow, sometimes breaking up into fluffy, yellow fragments.

Amanita muscaria. The Fly Amanita (Very Poisonous)

Cap globose, convex, and at length flattened, at maturity margin sometimes slightly striate; flesh white, sometimes yellow under the pellicle; remnants of the

volva persisting as scattered, floccose, or rather compact scales, color subject to great variation, ranging from yellow to orange, or blood red, **gills** white or yellowish, free but reaching the stem; **stem** cylindrical, at first stuffed, later hollow, upper part torn into loose scales, bulb prominent, generally marked by concentric scales forming irregular ridges; **ring** typically apical, lacerated, lax, large.

Cap $3\frac{1}{2}$ to $5\frac{1}{2}$ inches broad, stem 4 to 6 inches long.

Amanita muscaria may be found during the summer and fall, occurring singly, or in small associations, or in patches of considerable size. It grows in cultivated soil, partially cleared land, and in woods or roadsides. It does not demand a rich soil, but rather exhibits a preference for poor ground. The color is an exceedingly variable character, the plants being brighter colored when young, and fading as they mature. The European plant possesses more gorgeous colors than the American form.

This is a very poisonous species, and it has been the subject of many pharmacological and chemical investigations. Its chief poisonous principle is muscarine, although a second poisonous element is believed to be present, as atropine does not entirely neutralize the effect of injections of *Amanita muscaria* in animals.

This species has been responsible for many deaths, and numerous cases of severe illness have been caused by persons mistaking *Amanita muscaria*, the poisonous species, for *Amanita caesarea*, the edible species. The most satisfactory treatment is to administer hypodermic injections of atropine beginning with a dosage of $\frac{1}{60}$ grain after the giving of a strong emetic. While typical specimens of these two species possess distinguishing characters, as already shown, it is again recommended to shun all Amanitæ.

In Siberian Russia the natives make several uses of *Amanita muscaria*. Preserved in salt it is eaten, though probably more as a condiment than as a main article of diet; a decoction is popular as an intoxicant, and deaths are reported upon good authority as resulting from a "muscaria orgy."

Amanita phalloides. Death Cup (Deadly Poisonous)

Cap white, lemon, or olive to umber, fleshy, viscid when moist, smooth or with patches or scales, broadly oval, bell-shaped, convex, and finally expanded, old specimens sometimes depressed by the elevation of the margin; **gills** free, white; **stem** generally smooth and white, in dark varieties colored like the cap but lighter, solid downward, bulbous, hollow, and attenuated upward; **ring** superior, reflexed, generally entire, white.

The large, free **volva**, its lower portion closely adherent to the bulb, and the large ring are of assistance in distinguishing this species.

Cap 3 to 4 inches broad; stem 3 to 5 inches long.

This species and its forms are subject to great variation in color, ranging from white, pale yellow, and olive to brown. *Amanita phalloides* is a very cosmopolitan plant and one of very common occurrence. It is the most dangerous of all mushrooms, for no antidote to overcome its deadly effect is known. It exhibits no special preference as regards habitat and is found growing in woods or cultivated land from

summer to late autumn. When fresh it is without scent, but a peculiarly sickening odor is present in drying plants.

ARMILLARIA

The genus *Armillaria* is another white-spored agaric having a ring and no volva. The gills are attached to the stem and are sinuate or more or less decurrent. The substance of the stem and cap is continuous and firm. This genus may be distinguished from *Amanita* and *Lepiota* by the continuity of the substance of the stem and cap, and it is further differentiated from *Amanita* by the absence of a volva. It contains several edible species.

Armillaria mellea. Honey-colored Mushroom (Edible)

Cap oval to convex and expanded, sometimes with a slight elevation, smooth, or adorned with pointed dark-brown or blackish scales, especially in the center, honey color to dull reddish-brown, margin even or somewhat striate when old; **gills** adnate or decurrent, white or whitish, sometimes with reddish-brown spots; **stem** elastic, spongy, sometimes hollow, smooth or scaly, generally whitish, sometimes gray or yellow above the ring, below reddish-brown.

Cap $1\frac{1}{2}$ to 6 inches broad; stem 2 to 6 inches long, $\frac{1}{2}$ to $\frac{3}{4}$ inch thick.

This species is extremely common and variable. It generally occurs in clusters about the base of rotten stumps and is often a serious parasite of fruit trees and destructive to props in coal mines. The fruit bodies are attached to the strands of hyphæ known as *Rhizomorpha subterranea*, which form a network under the bark of the tree and out into the soil. Both ring and stem are subject to marked variations. The former may be thick, or thin, or entirely absent, and the latter uniform in diameter or bulbous. The species is edible, though not especially tender or highly flavored (Fig. 15).

On account of the great variation in color, surface of the cap, and shape of the stem, several forms of *Armillaria mellea* have been given varietal distinction. The following varieties as distinguished by Prof. Peck may be of assistance to the amateur:

Armillaria mellea var. *flava*, with yellow or reddish-yellow cap.

Armillaria mellea var. *radicata*, with a tapering root.

Armillaria mellea var. *albida*, with white or whitish cap.

PLEUROTUS

The genus *Pleurotus* is chiefly distinguished among the white-spored agarics by the excentric stem or resupinate cap. The stem is fleshy and continuous with the substance of the cap, but it is subject to great variation in the different species and may be excentric, lateral, or entirely absent. The gills are decurrent or sometimes adnate, edge acute. Most of the species grow on wood, buried roots, or decayed stumps. This genus corresponds to *Claudopus* of the pink-spored and *Crepidotus* of the brown-spored forms.

Pleurotus ostreatus. Oyster Mushroom (Edible)

Cap either sessile or stipitate, shell-shaped or dimidiate, ascending, fleshy, soft, smooth, moist, in color white, cream, grayish to brownish ash; **stem** present or absent (if present, short, firm, elastic, ascending, base hairy); **gills** white, decurrent, somewhat distant, anastomosing behind to form an irregular network.

Cap 3 to 5 inches broad; mostly cespitose imbricated (Fig. 265).

A very fine edible species, growing on limbs or trunks of living or dead trees, of cosmopolitan distribution, appearing from early summer until late fall.



FIG. 265.—Sporophores of oyster toadstool (*Pleurotus ostreatus*). (After Patterson, Flora W., and Charles, Vera K., Bull. 175, U. S. Dept. Agric. pl. vii, Apr. 29, 1915.)

Pleurotus sapidus (Edible)

This species very closely resembles *Pleurotus ostreatus* and is distinguished from it by the lilac-tinged spores, a character difficult or impossible for the amateur to detect. From the mycophagist's point of view, these two species are equally attractive.

Pleurotus serotinus (Edible)

Cap fleshy, compact, convex or nearly plane, dimidiate reniform, suborbicular, edge involute, finally wavy, smooth, yellowish-green, sooty olive, or reddish-brown, in wet weather with a viscid pellicle; **gills** close, distinct, whitish or yellowish, minutely tomentose or squamulose with blackish points.

Cap 1 to 3 inches broad.

In general appearance this fungus resembles *Claudopus nidulans*, but is separated from it by the color of the spores, *Pleurotus* belonging to the section of white-spored agarics and *Claudopus* to the rosy-spored species. The plants grow on dead branches or trunks and are gregarious or imbricate.

Pleurotus serotinus is edible but not particularly good, its chief recommendation being the lateness of its occurrence in the fall, when other more tempting species have disappeared.

Pleurotus ulmarius (Edible)

Cap fairly regular, although inclined to excentricity, convex, margin incurved, later plane, horizontal, even, smooth, white or whitish, at disk shades of tan or brown; **flesh** white, tough; **gills** broad, rather distant or rounded behind; **stem** more or less excentric, curved, ascending, firm, solid, elastic, thickened, and tomentose at the base.

Cap 3 to 5 inches broad, stem 2 to 3 inches long.

This species occurs abundantly on dead elm branches or trunks or growing from wounds of living trees. Though exhibiting a special fondness for this host, it is not confined to elm trees. It is readily distinguished from *Pleurotus ostreatus* by the long stem and by the emarginate or rounded gills. It is considered an excellent edible species and occurs abundantly in the fall.

CANTHARELLUS

In the genus *Cantharellus* the cap is fleshy or 'submembranaceous, continuous with the stem, and has the margin entire, wavy, or lobed. The gills are decurrent, thick, narrow, blunt, fold-like, irregularly forked, and connected by net-like veins.

Cantharellus aurantiacus. False Chanterelle

Cap fleshy, soft, somewhat silky, shape variable, convex, plane or infundibuliform, margin wavy or lobed, inrolled when young, later simply incurved, dull orange or brownish, especially in the center; **flesh** yellowish; **gills** rather thin, decurrent, forked, dark orange; **stem** spongy, fibrous, colored like the cap, larger at the base than at the apex.

Plant 1 to 3 inches in height; cap 1 to 3 inches broad.

This plant is more slender and the gills are thinner than those of *Cantharellus cibarius*, from which it can be readily distinguished. The taste is generally mild, but sometimes slightly bitter. Foreign and American mycophagists do not agree in regard to the edibility of the species. It is common on the ground or on very rotten logs.

Cantharellus cibarius. The Chanterelle (Edible)

Cap fleshy, thick, smooth, irregularly expanded, sometimes deeply depressed, opaque egg yellow, margin sometimes wavy; **flesh** white; **gills** decurrent, thick narrow, branching or irregularly connected, same color as cap; **stem** short, solid expanding into a cap of the same color.

Plant 2 to 4 inches in height; cap 2 to 3 inches broad.

An agreeable odor of apricots may be observed, especially in the dried plants of this species, but its absence need not be construed as affecting the validity of an identification established by other characters. The chanterelle has long been considered one of the most highly prized edible mushrooms. The remark of a foreign mycologist is recalled that "The chanterelle is included when the most costly dainties are sought for state dinners." It is a common summer species found in open woods and grassy places.

LACTARIUS

The distinguishing feature of the genus *Lactarius* is the presence of a white or colored milk, especially in the gills. The entire plant is brittle and inclined to rigidity. The fleshy cap is more or less depressed and frequently marked with concentric zones. The gills are often somewhat decurrent, but in certain species are adnate or adnexed, unequal in length, and often forked. The stem is stout, rigid, central, or slightly excentric.

Lactarius chelidonium (Edible)

Cap firm, convex and depressed in the center, glabrous, slightly viscid when moist, grayish-yellow or tawny, at length stained bluish or greenish, generally zonate, margin involute at first and naked; **gills** narrow, crowded, sometimes forked, and sometimes joining to form reticulations, adnate or slightly decurrent, saffron yellow to salmon; **stem** short, nearly equal, hollow, colored like the cap.

Cap 2 to 2½ inches broad; stem 1 to 1½ inches long, about ½ inch thick.

This species is closely related to *Lactarius deliciosus*, to which in flavor and substance it is scarcely inferior. It is paler than that species and the milk is saffron yellow rather than orange. The plants are fragile and when wounded turn blue, and later green. They are to be found especially in dry localities in the vicinity of pine woods in September and October.

Lactarius deceptivus (Edible)

Cap fleshy, convex umbilicate, then expanded and centrally depressed, somewhat infundibuliform, white or whitish, margin at first involute, covered with a dense soft cottony tomentum, filling the space between the margin and the stem, finally spreading or elevated and more or less fibrillose; **gills** whitish or cream-colored, rather broad, distant or subdistant, adnate or decurrent, forking; **stem** solid, nearly equal, pruinose-pubescent.

Cap 2½ to 5½ inches broad; stem ¾ inch to 3 inches long.

Lactarius deceptivus is found in woods and open places from July to September. It is coarse, but fairly good after its peppery taste is lost by cooking.

Lactarius deliciosus (Edible)

Cap convex, but depressed in the center when quite young, finally funnel-shaped, smooth, slightly viscid, deep orange, yellowish or grayish-orange, generally zoned,

margin naked, at first involute, unfolding as the plant becomes infundibuliform; **flesh** soft, pallid; **gills** crowded, narrow, often branched, yellowish-orange; **stem** equal or attenuated at the base, stuffed, then hollow, of the same color as the cap except that it is paler and sometimes has dark spots.

Cap 2 to 5 inches broad; stem 1 to 2 inches long, 1 inch thick.

This fungus is distinctive, on account of its orange color and the concentric zones of light and dark orange on the cap and because of the saffron red or orange milk. A peculiarity of the plant is that it turns green upon bruising and in age changes from the original color to greenish. *Lactarius deliciosus* is widely distributed and of common occurrence, appearing on the ground in woods, solitary or in patches, from June or July to October. As the name indicates, it is considered a delicious species, and that it has a preëminent claim to the name is unchallenged. Even by the ancients it was considered "food for the gods."

Lactarius fumosus (*Suspicious*)

Cap convex, plane or slightly depressed, snuff brown or coffee-colored, dry glabrous or pruinose, very smooth, margin entire or sometimes wavy; **flesh** white, changing to reddish when wounded; **gills** subdistant, adnate, or slightly decurrent, white then yellow, becoming pinkish or salmon where bruised; **stem** nearly equal or slightly tapering downward, stuffed, then hollow, colored like the cap.

Cap 2 to 3 inches broad; stem $1\frac{1}{2}$ to $2\frac{1}{2}$ inches long, about 6 lines thick.

This species varies considerably in size, color, and closeness of the gills. The distinguishing features for field identification are the coffee-colored cap and the changeable color of the flesh and gills. Its use should be strictly avoided, as it closely resembles *Lactarius fuliginosus*, a poisonous species. These two species, *L. fumosus* and *L. fuliginosus*, are sometimes considered identical.¹

Lactarius indigo (*Edible*)

Cap at first umbilicate and the margin involute, later cap depressed or infundibuliform and margin elevated, indigo blue with a silvery-gray luster, zonate, fading in age, becoming greenish and less distinctly zoned, milk abundant and dark blue; **gills** crowded, indigo blue, changing to greenish in age; **stem** short, nearly equal, hollow.

Cap 2 to 5 inches broad; stem 1 to 2 inches long.

Lactarius indigo is easily recognized by its striking blue color. It occurs in mixed or coniferous woods in summer and autumn. Though not particularly abundant, several plants are generally found in fairly close range of one another.

Lactarius piperatus. *Pepper Cap* (*Edible*)

Cap fleshy, thick, convex, umbilicate, when mature funnel-shaped, even, smooth, zoneless, margin involute when young; **flesh** white; **gills** narrow, crowded, edge

¹ BURLINGHAM, GERTRUDE S.: Study of the Lactariæ of the United States. Memoirs, Torr. Bot. Club, Vol. 14, No. 1, p. 84, 1908.

obtuse, in some forms arcuate, and then extended upward, white, reported with occasional yellow spots; **stem** equal or tapering below, thick, white, sometimes pruinose.

Cap $3\frac{1}{2}$ to 5 inches broad, sometimes reported considerably larger; stem 1 to inches long.

The milk in the "pepper cap" is abundant, white, unchangeable, and extremely acrid, to which character is due the specific name. This species is very common and abundant from June to October.

Lactarius torminosus (Poisonous)

Cap convex then depressed, surface viscid when young or moist, yellowish-red or ochraceous with pink shades, margin involute when young, persistently tomentose hairy; **gills** crowded, narrow, often tinged with yellow or flesh color; **stem** cylindrical or slightly tapering at the base, hollow, whitish.

Cap 2 to $3\frac{1}{2}$ inches broad; stem $1\frac{1}{2}$ to 3 inches long, 4 to 8 lines thick.

According to some authors this species is injurious only when raw. It is cooked and eaten in Sweden. In Russia it is enjoyed dressed with oil and vinegar or it is preserved by drying.

Lactarius volemus (Edible)

Cap convex, nearly plane or slightly depressed, glabrous, dry, azonate, brownish terra cotta, somewhat wrinkled when old; **gills** adnate or slightly decurrent, close, whitish, becoming sordid or brownish when bruised; **stem** more or less equal, firm, solid, glabrous, colored like the cap or paler; milk white, abundant, and mild, becoming thick when exposed to the air.

Cap 2 to 5 inches broad; stem 1 to 4 inches long, 4 to 10 lines thick.

This species is considered delicious, and is quite common from midsummer to frost on semicleared or sprout land.

RUSSULA

The genus *Russula* is similar in form, brittleness, and general appearance to *Lactarius*, from which it differs only in the absence of milk. The species are very abundant in the summer, extending into the fall months.

Most species of *Russula* are regarded as edible, but several are known to be poisonous. It is advisable to abstain from eating any red forms until perfectly familiar with the different species.

Russula emetica (Poisonous)

Cap oval to bell-shaped, becoming flattened or depressed, smooth, shining, rosy to dark red when old, fading to tawny, sometimes becoming yellow, margin finally furrowed and tuberculate; **flesh** white, but reddish under the separable pellicle; **gills** nearly free, somewhat distant, shining white; taste very acrid; **stem** stout, spongy-stuffed, fragile when old, white or reddish.

Cap 3 to 4 inches broad; stem $2\frac{1}{2}$ to 4 inches long.

Russula emetica is a handsome plant of wide distribution found during summer and autumn on the ground in woods or open places. Although some enthusiastic mycophagists testify to its edibility, it is best to consider the species poisonous.

Russula ochrophylla

Cap convex, becoming nearly plane or very slightly depressed in the center, when old purple or purplish red, margin even, sometimes faintly striate when old; **flesh** white, purplish under the cuticle; **gills** adnate, entire, a few forked at the base, interspaces somewhat venose, at first yellowish, ochraceous buff when mature, powdery from the spores; **stem** mostly equal, solid or spongy within, rosy or red, paler than the cap.

Cap 2 to 4 inches broad; stem $2\frac{1}{2}$ to 3 inches long.

Russula ochrophylla may be found growing singly, or in small patches on the ground in woods, mostly under trees, according to Prof. Peck, especially under oak trees. In Virginia, Maryland, and the District of Columbia it is abundant in July and August and is to be found less frequently in September and the first part of October.

Russula roseipes (Edible)

Cap convex, sometimes plane or slightly depressed, at first viscid, then dry and faintly striate on the margin, rosy red, frequently modified by pink or ochraceous shades; **gills** moderately close, ventricose, more or less adnate, whitish becoming yellow; **stem** stout, stuffed or somewhat hollow, white tinged with red.

Cap 1 to 2 inches broad; stem $1\frac{1}{2}$ to 3 inches long.

This species grows on the ground in mixed, but generally coniferous, woods. It appears in the late summer and autumn and is reported excellent, though, as already stated, the amateur should be cautious and avoid all red species of this genus.

Russula rubra

Cap convex, flattened, finally depressed, dry; pellicle absent, polished, cinnabar red, becoming tan when old; **flesh** white, reddish under the cuticle; **gills** adnate, somewhat crowded, whitish then yellowish, often red on the edge; **stem** stout, solid, varying white or red.

Cap $2\frac{1}{2}$ to 4 inches broad; stem 2 to 3 inches long, about 1 inch thick.

This species is extremely acrid, and, as there are conflicting opinions concerning its edibility, it is best for the amateur to refrain from collecting it. It is found in woods on the ground in summer and autumn.

Russula virescens (Edible)

Cap at first rounded, then expanded, when old somewhat depressed in the center, dry, green, the surface broken up into quite regular, more or less angular areas of deeper color, margin straight, obtuse, even; **gills** adnate, somewhat crowded, equal or forked; **stem** equal, thick, solid or spongy rivulose, white.

Cap $3\frac{1}{2}$ to 5 inches broad; stem about 2 inches long.

This fungus is noticeable on account of the color and areolate character of the cap. In Virginia, Maryland, and the District of Columbia it occurs commonly either solitary or in small patches, but not in very great abundance, from July to September, but it has been found from June through the entire summer and into October. The species is edible and of good flavor.

CORTINARIUS

The genus *Cortinarius* is easily recognized when young among the ocher-spored agarics by the powdery gills and by the cobwebby veil, which is separable from the cuticle of the cap. In mature plants the remains of the veil may often be observed adhering to the margin of the cap and forming a silky zone on the stem. *Cortinarius* contains many forms which are difficult of specific determination. Many species are edible, some indifferent or unpleasant, and others positively injurious. The colors are generally conspicuous and often very beautiful. Most of the species occur in the autumn.

Cortinarius cinnamomeus (Edible)

Cap rather thin, conic campanulate, when expanded almost plane, but sometimes umbonate, yellow to bright cinnamon-colored, with perhaps red stains, smooth, silky from innate, yellowish fibrils, sometimes concentric rows of scales near the margin; **flesh** yellowish; **gills** yellow, tawny, or red, adnate, slightly sinuate and decurrent by a tooth, crowded, thin, broad; **stem** equal, stuffed then hollow, yellowish, fibrillose.

Cap 1 to $2\frac{1}{2}$ inches broad; stem 2 to 4 inches long, 3 to 4 lines thick.

This is a very common and widely distributed species, particularly abundant in mossy coniferous woods from summer until fall. The color of the gills is an extremely variable character, ranging from brown or cinnamon to blood red. A form possessing gills of the latter color is known as *Cortinarius cinnamomeus* var. *semisanguineus*. This species and variety are edible and considered extremely good.

Cortinarius lilacinus (Edible)

Cap firm, hemispherical, then convex, minutely silky, lilac-colored; **gills** close, violaceous changing to cinnamon; **stem** solid, stout, distinctly bulbous, silky fibrillose, whitish with a lilac tinge.

Cap 2 to 3 inches broad; stem 2 to 4 inches long.

This is a comparatively rare but very beautiful mushroom and an excellent edible species.

Cortinarius sanguineus (Edible)

Cap convex, then plane, or perhaps slightly umbonate or depressed, blood red, silky or squamulose; **flesh** paler reddish; **gills** crowded, entire, adnate, dark blood red; **stem** stuffed or hollow, sometimes attenuated at the base, dark as the cap and fibrillose, containing a red juice.

Cap. 1 to 1½ inches broad; stem 2 to 3 inches long.

This species is much less common in its occurrence than *Cortinarius cinnamomeus*, but is distinctive because of its entire blood-red color.

Cortinarius violaceus (Edible)

Cap convex, when expanded almost plane, dry with hairy tufts or scales, dark violet; **flesh** somewhat violaceous; **gills** distant, rather thick and broad, rounded or deeply notched at apex of stem, narrowed at margin of cap, at first violaceous, later brownish-cinnamon; **stem** fibrillose, solid, bulbous, colored like cap.

Cap 2 to 4 inches broad; stem 3 to 5 inches long.

This very attractive species is at first a uniform violet, but with age the gills assume a cinnamon hue. The plants appear in woods and open places during the summer and fall, generally solitary, but often in considerable numbers. It is esteemed as one of the best edible species.

AGARICUS

The genus *Agaricus* is characterized by brown or blackish spores with a purplish tinge and by the presence of a ring. The cap is mostly fleshy and the gills are free from the stem. The genus is closely related by *Stropharia*, but separated from it by the free gills and the noncontinuity of the stem and the cap. The species of *Agaricus* occur in pastures, meadows, woods, and manured ground. All are edible, but certain forms are of especially good flavor. Bright colors are mostly absent and white or dingy brown shades predominate.

Agaricus arvensis. Horse or Field Mushroom (Edible)

Cap convex, bell-shaped, then expanded, when young floccose or mealy, later smooth, white or yellowish; **flesh** white; **gills** white to pink, at length blackish-brown, free, close, may be broader toward the stem; **stem** stout, hollow or stuffed, may be slightly bulbous, smooth; **ring** rather large, thick, the upper part white, membranaceous, the lower yellowish and radially split.

Cap 3 to 5 inches broad; stem 2 to 5 inches high, 4 to 10 lines thick.

Agaricus arvensis is to be found in fields, pastures, and waste places. It is closely related to the ordinary cultivated mushroom, but differs in its larger size and double ring. It is an excellent edible species, the delicacy of flavor and texture largely depending, like other mushrooms, upon its age.

Agaricus campestris. Common or Cultivated Mushroom (Edible)

Cap rounded, convex, when expanded nearly plane, smooth, silky floccose or squamulose, white or light brown, squamules brown, margin incurved; **flesh** white, firm; **gills** white in the button stage, then pink, soon becoming purplish-brown, dark brown, or nearly black, free from the stem, rounded behind, subdeliquescent; **stem** white, subequal, smooth or nearly so; **veil** sometimes remaining as fragments on the margin of cap; **ring** frail, sometimes soon disappearing.

Cap $1\frac{1}{2}$ to 4 inches broad; stem 2 to 3 inches long, 4 to 8 lines thick. (Fig. 266.)

This is the most common and best known of all the edible mushrooms. It is a species of high commercial value, lending itself to very successful and profitable artificial cultivation. It is cosmopolitan in its geographic distribution, being as universally known abroad as in America. It is cultivated in caves, cellars, and in especially constructed houses; but it also occurs abundantly in the wild state, appearing in pastures, grassy places, and richly manured ground. The only danger in collecting it in the wild form is in mistaking an *Amanita* for an *Agaricus*; however, this danger may be obviated by waiting until the gills are decidedly pink before collecting the mushrooms.



FIG. 266.—Meadow mushroom, *Agaricus campestris* var. *Columbia*, showing all stages in development of young mushrooms (fruit bodies). (From Gager, after G. F. Atkinson.)

Agaricus placomyces. Flat-cap Mushroom (Edible)

Cap thin, at first broadly ovate, convex or expanded and flat in age, whitish, adorned with numerous minute, brown scales, which become crowded in the center, forming a large brown patch; gills close, white, then pinkish, finally blackish-brown; veil broad; ring large. In the early stages, according to Prof. Atkinson, a portion of the veil frequently encircles the stipe like a tube, while a part remains still stretched over the gills.

Stem smooth, stuffed or hollow, bulbous, white or whitish, the bulb often stained with yellow.

Cap 2 to 4 inches broad; stem 3 to 5 inches long, $\frac{1}{4}$ to $\frac{1}{2}$ inch thick.

This species frequents hemlock woods, occurring from July to September.

Agaricus Rodmani (Edible)

Cap firm, rounded, convex, then nearly plane, white, becoming subochraceous, smooth or cracked into scales on the disk, margin decurved; **flesh** white; **gills** narrow, close, white, changing to pink and blackish-brown; **stem** solid, short, whitish, smooth, or perhaps mealy, squamulose above the ring; **ring** double, sometimes appearing as two collars with space between.

Cap 2 to 4 inches broad; stem 2 to 3 inches long, 6 to 10 lines thick.

Agaricus Rodmani may easily be mistaken for *Agaricus campestris*, but can be distinguished by the thicker, firmer flesh, narrower gills, which are nearly white when young, and peculiar collar, which appears double. This species grows on grassy ground, often springing from crevices of unused pavements or between the curbing and the walk. It is to be found principally from May to July.

Agaricus silvicola (Edible)

Cap convex, expanded to almost plane, sometimes umbonate, smooth, shining, white, often tinged with yellow, sometimes with pink, especially in the center; **flesh** white or pinkish; **gills** thin, crowded, white, then pink, later dark brown, distant from stem, generally narrowed toward each end; **stem** long, bulbous, stuffed or hollow, whitish, sometimes yellowish below; **ring** membranaceous, sometimes with broad floccose patches on the under side.

Cap 3 to 6 inches broad; stem 4 to 6 inches long, 4 to 8 lines thick.

Agaricus silvicola has been known under various names, at one time being considered merely a variety of *Agaricus arvensis*. By Peck¹ it has been recognized as a distinct species, *A. abruptibulbus*. A discussion of the nomenclature of this species may be found in McIlvaine and Macadam.²

Agaricus subrufescens (Edible)

Cap at first deeply hemispherical, becoming convex or broadly expanded, silky, fibrillose, and minutely or obscurely squamulose, whitish, grayish, or dull reddish-brown, usually smooth and darker on the disk; **flesh** white, unchangeable; **gills** at first white or whitish, then pinkish, finally blackish-brown; **stem** rather long, often somewhat thickened or bulbous at the base, at first stuffed, then hollow, white; the annulus flocculose or floccose squamose on the lower surface. Two additional

¹ PECK, C. H.: Report of the State Botanist, 1904. N. Y. State Mus. Bull. 94, p. 36, 1905.

² McILVAINE, CHARLES, and MACADAM, R. K.: Toadstools, Mushrooms, Fungi, Edible and Poisonous; One Thousand American Fungi, rev. ed., Indianapolis (1912), p. 728.

characters of assistance in identification are the mycelium, which forms slender branching root-like strings, and the almond-like flavor of the flesh.

Cap 3 to 4 inches broad; stem $2\frac{1}{2}$ to 4 inches long.

The plants often grow in large clusters of twenty to thirty or even forty individuals. They occur in the wild state and have also been reported as a volunteer crop in especially prepared soil. Specimens collected in the vicinity of Washington,



FIG. 267.—Fruit bodies of *Coprinus atramentarius* (edible). (After Patterson, *Flora W.*, and Charles, Vera K., *Bull. 175, U. S. Dept. Agric., pl. xxviii, A pr. 25, 1915.*)

D. C., were found growing near the river on a rocky slope rich in leaf mould. *Agaricus subrufescens* is considered a very excellent edible species.

COPRINUS

The genus *Coprinus* is easily recognized by the black spores and the close gills, which at maturity dissolve into an inky fluid. The stem is hollow, smooth, or fibrillose. The volva and ring are not generic characters, but are sometimes present. The plants are more or less fragile and occur on richly manured ground, dung, or rotten tree trunks. The genus contains species of excellent flavor and delicate consistency. Autodigestion (page 65) is shown by them.

Coprinus atramentarius. *Inky Cap (Edible)* (Fig. 267).

Cap ovate, slightly expanding, silvery to dark gray or brownish, smooth, silky or with small scales, especially at the center, often plicate and lobed with notched margin; **gills** broad, ventricose, crowded, free, white, soon changing to pinkish-gray, then becoming black and deliquescent; **stem** smooth, shining, whitish, hollow,

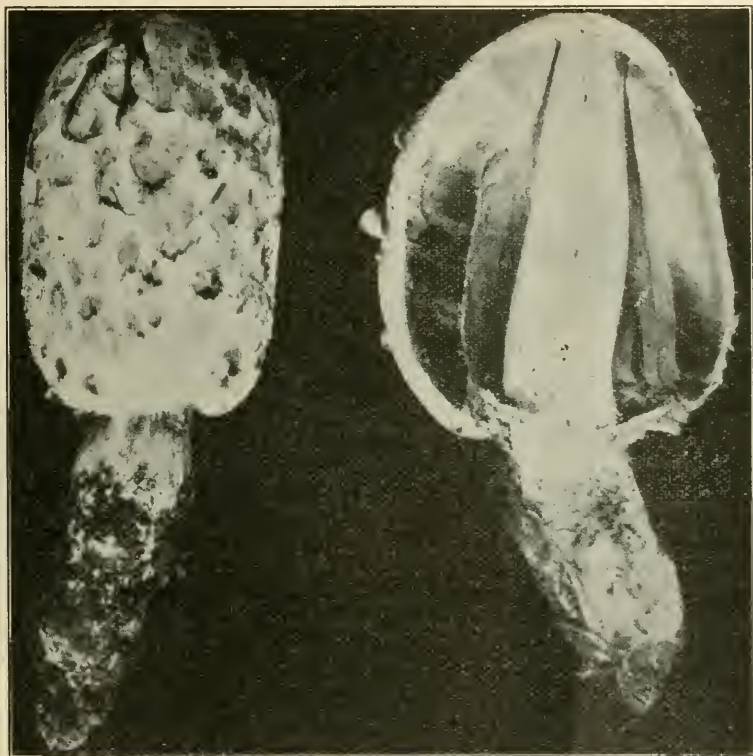

FIG. 268.—Edible shaggymane, *Coprinus comatus*. (After Patterson, *Flora W.*, and Charles, Vera K., *Bull.* 175, *U. S. Dept. Agric.*, pl. xxii, Apr. 29, 1915.)

attenuated upward, readily separating from the cap; **ring** near the base of stem, evanescent.

Cap $1\frac{1}{2}$ to 4 inches broad; stem 2 to 4 inches long, 4 to 6 lines thick.

This species appears from spring to autumn, particularly after rains. It grows singly or in dense clusters on rich ground, lawns, gardens, or waste places. It has long been esteemed as an edible species. *Coprinus atramentarius* differs from *C. comatus* in the more or less smooth, oval cap and the imperfect, basal, evanescent ring.

Coprinus comatus. Shaggy Mane (Edible) (Figs. 268 and 270).

Cap oblong, bell-shaped, not fully expanding, fleshy at center, moist, cuticle separating into scales that are sometimes white, sometimes yellowish or darker, and show the white flesh beneath, splitting from the margin along the lines of the gills; gills broad, crowded, free, white, soon becoming pink or salmon-colored and changing to purplish-black just previous to deliquescence; stem brittle, smooth or fibril-



FIG. 269.—Glistening inky cap, *Coprinus micaceus*. (Photo by W. H. Walmsley.)

lose, hollow, thick, attenuated upward, sometimes slightly bulbous at base, easily separating from the cap; ring thin, movable.

Cap usually $1\frac{1}{2}$ to 3 inches long; stem 2 to 4 inches long, 4 to 6 lines thick.

This species has a wide geographic distribution and is universally enjoyed by mycophagists. The fungus is very attractive when young, often white, again showing gray, tawny, or pinkish tints. It appears in the spring and fall, sometimes solitary, sometimes in groups, on lawns, in rich soil, or in gardens.

Coprinus fimetarius

Cap at first cylindrical, later conical to expanded, margin splitting, revolute or upturned, grayish to bluish-black, surface at first covered with white scales, finally smooth; **gills** black, narrow; **stem** fragile, white, squamulose, hollow, but solid and bulbous at the base.

Cap 1 inch or more across, stem 3 or more inches high.

This is a very common and abundant species on manure or rich soil and occurs from spring to winter. It is edible and considered excellent.



FIG. 270.—Shaggymane toadstool (*Coprinus comatus*) growing in open fields and on lawns. Edible before it begins to deliquesce. (After Gager, C. S.: *Fundamentals of Botany*, 1916: 289.)

Coprinus micaceus. Mica Inky Cap (Fig. 269).

Cap ovate, bell-shaped, light tan to brown, darker when moist or old, often glistening from minute, mica-like scales, margin closely striate, splitting, and revolute; **gills** narrow, crowded, white, then pink before becoming black; **stem** slender, white, hollow, fragile, often twisted.

Cap 1 to 2 inches broad; stem 2 to 4 inches long and 2 to 3 lines thick.

This glistening little species occurs very commonly at the base of trees or springing from dead roots along pavements, or more uncommonly on prostrate logs in shady woods. The plants appear in great profusion in the spring and early summer, and more sparingly during the fall. *Coprinus micaceus* is a very delicious mushroom and lends itself to various methods of preparation.

INDEX

A list of the common and important diseases of economic plants in the United States and Canada will be found on pages 414 to 474. The scientific names of the various disease-producing organisms and their common names will be found there, arranged alphabetically according to the host plants on which they grow. These names have been omitted from this index.

- Abnormalities, classification of, 331
Abortion, 331
Abrasion, 294
Acaulosity, 331
Account of specific plant diseases,
 475 et. seq.
Acetic acid fermentation, 32
Acheilary, 332
Achlya, figures of species, 112
Achlya polyandra on water plants, 111
Achlya prolifera, zoospores of, 67
Acid injuries, 649
Acid spotting of morning glories, 293
Acrasiales, 8
Acrasis granulata, 8
Actinomyces bovis, 39
Actinomyces chromogenes, 39, 266, 544
Actinomyces myricarum, 39
Actinomycetaceæ, 39
Activators, 57
Adenopetaly, 332
Adesmy, 332
Adherence, 332
Adhesion, 332
Æcidium, 188
Æciospores, 188
Æcium, 188
Aerobic cultivation, 625
Aerobic organisms, 27
Æthodium, 13
Agalinis as root parasite, 299
Agaricaceæ, characters of family, 231,
 232
Agaricaceæ, Key to, 732, 733, 734
Agaricus arvensis, description of, 745
Agaricus campestris, analysis of, 55;
 fat content, 56; fed to plasmodium,
 12; figure of, 234, 746; description
 of, 745, 746; number of spores, 234,
Agaricus, description of genus, 745
Agaricus placomyces, description of, 746
Agaricus Rodmani, description of, 747
Agaricus silvicola, description of, 747
Agaricus spectabilis, resin in, 56
Agaricus subrufescens, description of,
 747
Agar-agar, 605
Agars, various, 606, 611
Air content of tissues and disease, 280
Albinism, 343
Albumen of egg, 603
Alcoholic fermentation 59; in yeasts, 138
Alfalfa, leaf spot of, 476, 477; leaf rust,
 477
Algæ in lichens 78; parasitic, 391
Alteration of position, 347
Alteration of generations in rusts,
 diagram of, 194
Alternaria citri, 533; dianthi on carna-
 tions, 488, 489, 490; violæ, 558;
 figure of, 559
Alternariose of carnation, 488, 489, 490;
 figure of, 489
Amanita cæsarea, description of, 734,
 735, muscaria, description of, 735,
 736; at edge of woods, 83; figure of,
 233; phalloidea, description of, 736;
 figure of, 238; in woods, 83.

- Amanitopsis vaginata*, speed of spore fall, 64
Amaurochaete, spores of, 16
 American Phytopathological Society, status of, 411
 Amidase, 58
Amcebobacter, 39
Amphibolips ilicifolia, gall producing on *Quercus nana*, 399
Amphisporae, 188
Amphitrichous, 23
Amygdalin, 59
 Amylase, 58
 Anæretic, 332
 Anaerobic cultivation, 625; organisms, 27
 Analysis of water, 626
 Anatomy, pathologic plant, 354
 Anbury, 487
 Ancylistaceæ, characters of, 118
 Animals as cause of disease, 275
 Animal galls, 296; injuries, 295, 309
 Animate agents of disease, 295
Annulus superus, 233
 Anther smuts, 72
 Antherophylly, 332
 Anthesmolysis, 332
 Anthocyanin, 360
 Antholysis, 329, 332
 Anthracnose of cotton 508; of melons, 525; of raspberry, 544
 Anthrax, 35
Anthurus borealis, 252
 Anti-enzymes, 58
 Antisepsis, 692
 Aphyllly, 332
 Apilary, 332
Aplanobacter, 35
 Apogamy, 332
 Apophysis, 332
 Apostasis, 333
 Apothecium, structure of, 121
 Apple, black-rot of, 478, 479; bitter-rot of, 477, 478; fruit spots 570; scab, 478, 480, 481; figures of, 480; tumor on stem, figure of, 390
 Appel, O., work of, 272, 273
 Appel's potato scab, 646
 Appressoria, 308
 Arcyria, 15
Armillaria mellea, 62, 83, 530; color of, 53; described, 46, 737; figure of, 47
 Arrestment of cell wall development, 359
 Arthrospores in bacteria, 25
 Artificial wounds, 295
 Asci of chestnut blight, figure of, 500
 Ascobolaceæ, characters of, 166
Ascobolus immersus, special methods of spore discharge, 66
Ascobolus, spore colors of, 54
Ascochyta pisi, 534
 Ascogenous hyphal system, figures of, 125, 127
 Ascoideaceæ, 120
 Ascomycetales, bibliography of, 174, 175, 176; general characters of, 121, 122; phylogeny of, 173, 174; sexuality of, 122
 Ascospores 50; germination in chestnut blight, figure of, 501; representation by figures of development, 128
 Ascus 50; diagrams of, by Claussen, 124
 Ash, heart rot of, 481, 483
 Ashlock, J. L., quoted, 182
 Ash of fungi, analysis of, 54
 Asiatic cholera, 37
Asparagus rust, 191, 483, 484
 Aspergillaceæ, characters of, 143
Aspergillus, characters of the genus, 144
Aspergillus fumigatus as pathogenic, 147; flavus, 147; giganteus, 147; Key to species of, 702-703; nidulans, figure of, 148; niger with lipase, 59; with raffinase 58; luchuensis, 147; oryzeæ, 146; figure of, 145; with diastase 58; tokelau, 147; Wentii, 146
 Asphyxiation of roots, 565
 Assimilation tissues of galls, 400
 Astræus, 244
 Atkinson, Geo. F., book quoted, 91; quoted, 235, 236; work of, 248, 249
 Atrichous, 23
 Atrophy, 333, 342

- Auerbach's stain, 591
 Auriculariaceæ, characters of family, 216
 Auricularia Auricula-Judæ, 216
 Autodigestion of *Coprinus comatus*, 65;
 of fungi, 54
 Autophyllogeny, 333
 Awamori, a beverage, 147
- B
- Bacillus amylobacter, 36; spores in, 25;
 amylovorus 36, 536, 644; aroideæ,
 36; Bütschli, spores in, 25; butyricus,
 36; calfactor, 36; carotovorus, 36;
 caucasicus in Kefir, 141; coli, 36;
 inflatus, spores in, 25; influenzæ,
 length and breadth of, 22; lathyri,
 547; loxosporus, spores in, 25;
 loxosus, spores in, 25; megatherium,
 nuclear material in, 24; mesentericus
 vulgatus as a milk curdler, 59;
 musæ, 36, 484; nitri, length and
 breadth of, 22; nuclear material in,
 24; phytophthorus 313, 646; prodi-
 giosus, 36; and high temperatures, 360;
 putrificus, 36; radicola, 29, 36, 612;
 involution forms, 30; subtilis, 36;
 rapidity of cell division, 24; spores in,
 25; tetani, 36; tracheiphilus, 36, 313,
 525
- Bacteria, fermentation, 32; as disease
 producers, 275; bibliography, 40;
 characterization, 638; classification of,
 28; in general, 21; kinds of spores in,
 25; of root tubercles, figures of, 31;
 systematic account, 34
- Bacteriaceæ, 35
- Bacteriology emphasized, 271; systema-
 tic, 630, 631
- Bacteriopurpurin, 38
- Bacterium, 35; aceticum, 36; fermenta-
 tion by, 32; acidi-lactici, 36; fermenta-
 tion by, 32; in Matzoon, 141;
 anthracis, 35; campestris, 485, 486,
 487; diptheridis, 35; gammari, nuclear
 material in, 24; influenzæ, 35; Kütz-
 ingianus, fermentation by, 320; lepræ
 35; Pasturianus, fermentation by,
 32; mallei, 35; michiganense, 35;
 pestis, 35; phosphorcum, 36; pneu-
 moniæ, 35; Rathayi, 35; tuberculosis,
 35; vermiforme in ginger beer, 140
- Balance, organic, 333
- Balanophoraceæ, parasites of, 299
- Banana bud-rot, 484
- Bark-boring beetles, 294
- Basidiobolus ranarum on frog drug, 85
- Basidiolichenes, 81
- Basidiomycetales, characters of, 177;
 Key to suborders, 177
- Basidiospores, 49, 187
- Basidium, 187
- Bastard toad-flax, 298
- Beam of light method of studying spore
 discharge, 64
- Bean mosaic, 577
- Beefsteak fungus, 230
- Beet leaf-spot, 484, 485
- Beet rust, 485
- Beetles, bark boring, 294
- Beggiatoa, 38; alba, 38; length and
 breadth of, 22; mirabilis, 38; length
 and breadth of, 22
- Beggiatoaceæ, 38
- Benecke, W., mentioned, 54
- Benzaldehyde, 59
- Biastrepis, 333
- Bibliography of Ascomycetales, 174,
 175, 176; of bacteria, 40; of disease
 prevention, 318; of galls, 401, 402;
 of non-parasitic diseases, 580; of
 Oomycetales, 118, 119; of plant
 diseases in general, 353; of rusts, 214,
 215, 216; of slime moulds, 18, 19, 20;
 of smuts, 185, 186; of works on plant
 diseases, 412; of Zygomycetales, 105
- Biciliate zoospores, escape of, 67
- Binucleate hyphal cells of Gasteromy-
 cetes, 218; of Hymenomycetes, 218
- Biochemic features of bacteria, 636
- Biting insects, 296
- Bitter-pit of apples, 570

- Bitter-rot of apple, 477, 478
 Birds as spore carriers, 67
 Black ball, 178
 Black Death, 35
 Blackman, O. H., work on rusts, 191
 Black-knot of plum 74, 540
 Black-rot of apple, 478, 479; of cabbage 485, 486, 487; of cruciferous plants, experiments with, 645; of grape, 512; figures of, 513, 514; of orange, 533, of sweet potato, 548
 Black-rust of wheat, 560
 Blakeslee, A. F., work on moulds, 93
 Blanched plants, 277
 Blastomany, 333
 Blight of chestnut 491; of sycamore, 549
 Blister-rust of white pine, 537; figure of, 538
 Blood serum, 604
 Boletoidæ, 234
 Boletus, change of color in, 53; felleus, 230; figure of, 228; manual of, 227
 Books on chlorosis, 328; on economic entomology, 296
 Bordeaux mixture, figure of apparatus for making, 672; formulæ for, 670-674
 Botrytis cinerea, chitin in sclerotia of, 52
 Bouillon, 601
 Bourquelat mentioned, 53
 Breeding for disease resistance, 325
 Brefeld, Dr. O., cited, 89
 Bronzing, 282
 Broom-rape as a parasite, 299; figure of, 300
 Brown-rot of cacao, 490; of lemon, 520; of turnip, figure of, 486
 Brown rust of rye, 202
 Buchner discovery of zymase, 56
 Bud-rot of banana, 484
 Bulboceras gallicus and underground truffles, 71
 Buller, A. H. F. book of, 233
 Bunt ear, 178
 Burgeff, H., work cited, 100
 Burl on oak trees, figure of, 350
 Burrs, 348
 Burt, E. A., work of, 248
 Butyric fermentation, 33, 59
- C
- Cabbage black-rot, 485, 486, 487
 Cabbage leaf, figure of hypertrophied mesophyll, 368
 Cacao brown-rot, 490
 Cacao pink disease, 490
 Cæoma, 188; nitens, binucleate æcio-spores of, 196
 Calciphile plants, 277
 Calciphobe plants, 277
 Calcium, influence of, 277
 Calcium oxalate in sporangial walls of *Mucor mucedo*, 53
 Calendar for spraying, 680-690
 Calico, description of, 327
 Callous formation, conditions of, 380, 381; experiments with, 648; hypertrophies, 368, 369
 Callus, 377 et seq.; definition of, 377; histology of, 379
 Calvatia cyathiformis, figure of, 242
 Calvatia, species of, 242
 Calycanthemy, 333
 Calyphemy, 333
 Calyptospora species of, 199
 Cancer in plants, 34
 Cancer-root, figure of, 301
 Canker lesion of chestnut, figure of, 492
 Canker of larch, 519
 Cankers, 342, 348
 Cantharellus aurantiacus, description of, 739; cibarius, description of, 739, 740
 Capillitium, formation of, 13; in slime moulds, 15
 Carbohydrates, 58
 Carbol fuchsin, 589
 Carbon circulation, 33
 Carnation alternariose, 488, 489, 490; figure of, 489
 Carrion fungi, development of, 248
 Cassytha filiformis, 306

- Catalase, 58, 59
 Catalyst, 56
 Cataplasms, 376, 385; histology of, 391
 Cataplastic hypertrophy, 364
 Catastome, 243, 244
 Cavities covered with metal, 323
 Cavity treatment, 321
 Cecidial tissue forms, 397 et. seq.
 Cecidium, 384
 Cecidologists, 385
 Cedar apple, figure of, 206, 394; on
 small twig, figure of section of, 395
 Cedar rust on apple, 209
 Celidiaceæ, 169
 Cell division in bacteria, 24
 Celloidin method, 655
Celtis occidentalis, witches' broom on,
 351
 Cement cavity fillings, figure of, 322;
 mixing and placing, 321
 Cenangiaceæ, 169
 Cenanthy, 333
Cerastium viscosum, anther smut of, 72
Ceratiomyxa, spores of, 16
 Ceratomyx, 333
Cercospora beticola, 267; on beet, 484,
 485; *coffeicola*, 503
Cetraria islandica on ground, 83
 Chætocladiaceæ, characters of, 103
Chætocladium Jonesii, 101
Chætocladium parasitic on *Mucor*, 83
 Chætomiaceæ, characters of, 163
 Characterization of bacteria, 638
 Charles, Vera K., bulletin of, 244
 Cheilomany, 333
 Chemic character of soil cause of disease,
 276
 Chemic elements in fungi, 54
 Chemic work on fungi, 55
 Chemistry emphasized, 271; of fungi,
 52; of mushrooms, 237
 Chemomorphosis, 404
 Chemotaxis, 60
 Chemotropism, 60
 Cherry leaf-curl, 491
 Cherry, powdery mildew of, 491
 Chestnut blight, 491; distribution of,
 84; spread of, 316; gelatinous threads,
 figure of, 494; perithecial pustules,
 493
 Chestnut killed by blight, figure of, 313
 Chestnut leaf mildew, 502
 Chestnut, V. K., bulletin of, 238
 Chimæras, 329, 330; periclinal, 330;
 sectorial, 330; spontaneous, 330
 Chimney sweeper, 178
 Chinese yeast, 99
 Chitin in bacterial cell wall, 22
 Chlamydoacteriaceæ, 37
Chlamydomucor racemosus, figure of,
 98, 99
 Chlamydospores, 50; of corn smut, ger-
 mination of, 507; of smuts, 179; of
 Tilletia foetans, figure of, 561
 Chlamydothrix, 37
 Chloranthy, 37, 329, 333
 Chlorophylless plants, 1
 Chlorosis, 327, 343, 650; books on, 328
 Choanephoraceæ, brief characterization
 of, 103
 Chondromyces, 39
 Cholesterin, 56
 Cholin, 56
 Chorusis, 333
 Christman, A. H., work on rusts, 191
 Chromatin in bacteria, 23; in fungi, 53
 Chromatium, 39; Okeni, length and
 breadth of, 22
 Chromogenic bacteria, 25, 26
 Chromoparous, 26
 Chromoporous, 26
 Chromosomes in fungi, 53; reduction, 53
 Chymosin, 59
 Chytridiaceæ, characters of, 116, 117,
 118
Circæa lutetiana, giant cells, figure of
 372
 Cladochytriæ, 116, 117
 Cladomany, 333
Cladonia cristatella on dead wood, 83;
 pyxidata on stumps, 83; *rangiferina*
 on ground, 83

- Cladotrix, 38; *dichotoma*, 38; *fungiformis*, 38; *intestinalis*, 38; *intrica*, 38; *profundus*, 38; *rufula*, 38
 Classification, 1; of bacteria, 28; of enzymes, 58; of fungi, 2-6
 Clathraceæ, characters of family, 251; distribution of genera and species of, 87, 88
 Clathrus *cancellatus*, figure of, 247; *columnatus*, development of, 248
 Claussen, P., reinvestigation of *Pyronema confluens*, 123; work cited, 108
 Clavaria, species of, 223
 Clavariaceæ, characters of family, 222
 Claviceps *purpurea*, 546; chitin in sclerotia of, 52; described, 162; fat content, 56; figures of, 160, 161; sclerotia of, 69
 Cleanliness to prevent disease, 367
 Cleavage blocks in formation of spores in slime moulds, 14
 Climatic factors of disease, 281
 Clostridium *butyricum*, 36
 Clotting enzymes, 59
 Clouds, influence of, 284
 Clover rust, 502
 Club-root, 487, 488; figure of on cabbage roots, 488; of cabbage, figure of, 10
 Coagulation, 59
 Cobb's disease of sugar cane, 37
 Coccaceæ, 34
 Coconut water, 599
 Cocoon disease of silkworms, 147
 Cœlonemata, 15
 Cœnobia, 21
 Coffee leaf-spot, 503
 Coffee rust, 503
 Cohesion, 333
 Collection of fungi, 726, 727
 Coleosporiaceæ, characters of family, 199
 Coleosporium *solidaginis* and sickness of horses, 200
 Colletotrichum *gossypii*, 508; *lagenarium*, 525; *Lindemuthianum*, 264; figures of, 265; species of, 266
 Collybia *dryophila*, fall of spores of, 64; *platyphylla* on decaying logs, 74
 Colonies, types of, 626, 627
 Colors of bacteria, 26; in fungi, 53; of plasmodia, 12
 Columella in slime moulds, 15
 Comandra *umbellata*, 298
 Comatricha *nigra*, figure of, 14; *obtusata*, 13
 Conchs, 342
 Conidiophore, 46
 Conidiospore, 46, 49
 Coniferin, 56, 59
 Coniothyrium *Fuckelii*, 262
 Conopholis *americana*, 299; figure of, 301; *mexicana*, 299
 Connold, Edward T., work of on galls, 384
 Cook, Mel. T., work of, 274
 Coprinus, deliquescence of, 53; description of genus, 748; *atramentarius*, 749; figure of, 748; *comatus*, 850; figure of, 749, 751; fed to plasmodium, 12; liberation of spores, 65; number of spores in, 234; *fimetarius*, 751; *micaceus*, 751; figure of, 750; *stercorarius*, 61; occurrence of, 83
 Coprophilous fungi and their spores, 68
 Cora, a lichen, 81
 Cordyceps *Hügelii*, figure of, 70; *militaris*, figure of, 70; on larvæ of insects, 69; *ophioglossoides*, figure of, 70; parasitic on *Elaphomyces*, 69; several species described, 162; *sphærocephala*, figure of, 70
 Coremium, 50
 Coriolus *versicolor*, occurrence of, 229
 Cork as a protective layer, 308
 Corn dry-rot, 504
 Corn smut on tassels, figure of, 506; smut, 504, 505, 506; wilt, 507
 Correlation, 404
 Corticium *lilaco-fuscum*, 490; *vagum-solani*, 221, 269
 Cortinarius *cinnamomeus*, description of, 744; description of genus, 744;

- lilacinus, description of, 744; sanguineus, 744; violaceus, color of, 53; description of, 745
 Coryphyly, 333
 Cotton, 508; boll anthracnose, 508; rust, 508; wilt, 646
 Cottony cushion scale, ravage of, 316
 Counter, plate, 628
 Counting methods, 620, 621
 Counting plate, Jeffer's, 628
 Cover-glasses, squared, 616
 Cow wheat as a root parasite, 299
 Cowpea wilt, 646
 Cracks, frost, 294
 Cranberry, 509; gall, 509; scald, 509; detailed figures of, 510, 511
 Crateria, 334
 Craterium leucocephalum, figure of, 17
 Crenothrix, 38; polyspora, 38
 Cribraria argillacea, lead-colored plasmodium of, 12; purpurea, scarlet plasmodium of, 12; violacea, violet plasmodium of, 12
 Cronartium ribicola, 313, 537; figure of, 538
 Crown-gall experiments with, 643; figure of an apple with, 352; nuclear division, figure of, 373; on geranium, figure of, 644; on raspberry, figure of, 391
 Crucibulum, 245, 246
 Crustaceous lichens, 79
 Cryptogamic parasites, 298
 Cultivation of bacteria and fungi, rough method, 587; of mushroom, 236, 237, 693
 Cultural features of bacteria, descriptive terms of, 633
 Culture media, standardization of, 613
 Cultures of de Vries, 328
 Curdling, 59
 Curly-dwarf of potato, 576
 Curly-top of beets, 573
 Curricula and plant pathology, 410
 Cuscuta, description of, 305; figure of, 305
 Cutting, calloused end of, figure of, 377
 Cutting frozen material, 656
 Cuttings of *Populus pyramidalis*, 379
 Cyathus, 245
 Cyclochorisis, 334
Cylindrosporium padi, 266
 Cystobacter, 40
 Cystopus condidus, 74
 Cytase, 58
Cytinus hypocistis as a parasite, 301
Cytisus Adami, a graft hybrid, 329, 330
 Cytology, emphasized, 271; of fleshy fungi, 218; of rusts, 191
 Cytoplasm in bacteria, 23
Cyttaria Berterii in Patagonia, 85; *Darwinii* in Patagonia, 85; *Gunnii* in Tasmania, 85; *Harioti* in Terra del Fuego, 85; in southern Patagonia, 74; on *Nothofagus*, 171
Cyttariaceæ, characters of, 171
- D
- Dacryomycetaceæ*, characters of, 219
Dædalea quercina, 558; absorption of phosphorus by, 54; figure of, 558; occurrence of, 230
 Damping-off, 342; distribution of fungus, 84
 Danilov, work on lichens mentioned, 78
Dasyscypha Willkommii, 519
 Death of hosts, 314
 Decapitation experiments, 376
 De Bary, Anton, work of, 189; mentioned, 7
 Decay, 33; of maple, 523; of oak, 526; of timber, 553
 Decoctions, plant, 600
 Dedoublement, 334
 Deformation, 334
 Degeneration, 334
 Delafield's hæmatoxylin, 590
 Deliquescence of *Coprinus comatus*, 65
 Destruction of organs, 348
 Description of methods of bacterial study, 631, 639

- Desiccation, 566
 Determining cause of disease, 274
 Detailed account of specific plant diseases, 475 et seq.
 Deuteromycetes, 258-269
 Developmental mechanics of pathologic tissues, bibliography of, 405, 406, 407
 Development of carrion fungi, 248; of fruit bodies in mushrooms, 235, 236
 De Vries, Hugo, work of, 331
 Dextrose, 58
 Diachæna strumosa, 74
 Diagram of rust spore relations, 190
 Dialysis, 334; of enzymes, 57
 Diaphysis, 334
 Diastase, 58
 Dictyidin granules, 15
 Dictydium, 15
 Dictyophora duplicata, figure of, 249; origin of veil, 249, 250; phalloidea, figure of, 250; figure of structure, 251
 Dictyostelium mucoroides, 8
 Dictyonema, a lichen, 81
 Didymium melanospermum, spore formation in, 13, 14
 Die-back of citrus fruits, 572
 Dilution methods, 616
 Diplasy, 335
 Diplodia zeæ, 504
 Diploid chromosomes in slime moulds, 16
 Diremption, 335
 Diruption, 335
 Discentration, 335
 Discharge of spores, 233, 234; figure of, 63; in mushroom, figure of, 64
 Discoloration, 342, 343
 Discomycetiineæ, characters of, 164, 165
 Diseases, list of common plant, 414-473
 Diseases, non-parasitic, 564
 Diseases of plants, bibliography of specific, 473-474
 Diseases of plants in general, 271; two groups of, 413
 Diseases of sweet pea, 647
 Disease prevention, bibliography of, 318; resistance, 325
 Disinfection, 692
 Displacement, 335
 Dissemination of fungi, 314, 315
 Distribution of slime moulds, 18
 Distrophy, 335
 Dittschlag, work of, on rusts, 191
 Divulsion, 335
 Dodder, figure of, 305; figure of section of, 306; study of, 651
 Dodge, B. O., cited, 13, 15
 Dormant fungus in seeds, 308
 Dorrance, Frances, translations by, 413, 564
 Dothideaceæ, characters of, 162
 Downy mildew of grape, 513
 Downy woodpecker and spores of *Endothia parasitica*, 67
 Drawing apparatus, 657
 Drawing suggestions, 664-668
 Drop of lettuce, 522
 Dropsy, 352
 Dry rot, 343; of corn, 504; of larch, 519; of potato, 543
 Dry-rot fungus, 225; in timber, 553
 Duggar, B. M., book on mushroom growing, 237
 Duration of disease, 313
 Dust brand, 178
 Dwarfing, 342, 346

E

- Earth-star, 239, 244
 Ecblastesis, 335, 338
 Ecology of fungi, 69
 Economic entomology, field of, 296
 Ectotrophic mycorrhiza, figure of, 49
 Edinger's drawing apparatus, figure of details, 660, 661; description of, 657-664
 Egg albumen, 603; yolk, 603
 Egg plant wilt, 646
 Elaphomycetaceæ, character of, 150
 Elaphomyces, character of various species, 150
 Elaters in slime moulds, 15

- Eleagnus, 9
 Electric arc and fungi, 62
 Elenkin work on lichens mentioned, 78
 Embryology emphasized, 271
 Empusa muscæ, description of, 104;
 figure of, 104; as fly cholera, 85
 Emulsin, 58, 59
 Enation, 335
 Eneverthema papillatum, figure of, 14
 Endocellular enzymes, 56
 Endomycetaceæ, characters of, 131
 Endomyces decipiens, parasitic on Armil-
 laria mellea, 131
 Endophyllaceæ, characters of, 198
 Endophyllum sempervivi, described, 196,
 198; on house leek, 348
 Endophytic mycelium, 48
 Endospores in bacteria, 25
 Endothia parasitica, 491; and downy
 woodpecker, 67; description of, 164;
 distribution of, 83, 84; figure of peri-
 thecial pustules, 493, 495; mycelium of,
 496; spread of, 316
 Engelmann experiment with bacteria
 and oxygen, 27
 Engler cited, 2
 Enteridium splendens, pink plasmo-
 dium of, 12
 Entomology emphasized, 271
 Entomophthoraceæ, characters of, 103
 Entomosporium maculatum, 264
 Entyloma, description of several species,
 185
 Enumeration of means of fungous
 entry into plants, 312
 Enzymes, 56; and heat 57; and liquid
 air, 57; and plant diseases, 326; carbo-
 hydrate splitting, 58; classification of,
 58; clotting, 59; definition of word,
 56; detection of, 59; diseases, 650;
 distribution in fungi, 58; fat splitting,
 59; fermenting, 59; glucoside split-
 ting, 59; oxidizing, 59; protein-split-
 ting, 59; solubility of, 57; urea-split-
 ting, 59
 Epanody, 335
 Epipedochorisis, 335
 Epidemics, 315
 Epiphytic mycelium, 48
 Epiphytotisms, 298, 315
 Epistrophy, 335
 Ergotin, 56
 Ergot of rye, 546
 Eriksson's mycoplasm, 190
 Erysiphaceæ, characters of family, 154;
 Key to genera of, 721, 722
 Erysiphe, Key to species of, 723
 Escape of swarm spores, 67
 Esterases, 59
 Ether freezing attachment, figure of, 659
 Etiolated, 335; plants, 277; plants
 hypertrophied, 366
 Etiolation, 360; experiments with, 652
 Etiology, 272; description of, 641, of
 galls, 385
 Eubacteriales, 34
 Eubasidii, 218; bibliography of, 252-257
 Eumycetes, 1, 42, 45, 46
 Euphrasia as a root parasite, 299
 Exanthema of citrus fruits, 572
 Excrescences, 342, 348; of bark, 366
 Excursions suggested, 667
 Exoascus and witches' brooms, 72; de-
 scription of species, 133, 134, figures
 of, 132
 Exoascus cerasi, 491; deformans, 534;
 pruni, 74, 541
 Exoascaceæ, characters of, 131
 Exobasidiaceæ, characters of, 220
 Exobasidium, distribution of species and
 their hosts, 86, 87; vaccinii, figure of,
 220; various species described, 220
 Expansivity, 335
 Explosions of smut, 182
 Extracellular enzymes, 56
 Exudations, 343, 350
 Eyebright as root parasite, 299
 Eyepiece micrometer, 582

F

- Fabre, J. H., cited, 71
 Facultative parasite, 42; saprophyte, 42

- Fairy ring, figure of, 75, 735; fungus, 74; toadstool, 735
- Fasciation, 329, 335
- Fats in fungi, 53, 56
- Fat-splitting enzymes, 59
- Faull, J., work of, 172
- Fermenting power of yeasts, 595; enzymes, 59
- Ferments, 56
- Fermentation, acetic acid, 32; alcoholic in yeasts, 138; butyric, 32, 59; by bacteria, 32; by mould, 96; in yeasts, 137; in fungi, 307; lactic acid, 32, 59
- Ferrobacteria, 28
- Field of economic entomology, 296
- Field trip suggestions, 667
- Figure of rod-shaped bacteria, 22
- Filar micrometer; figure of, 583
- Film formation in yeasts, 137
- Final outcome of disease, 314
- Fingers and toes, 487
- Fink, Bruce, quoted, 78
- Fire-blight of pear, 536
- Fission, 336
- Fistulina hepatica, 230; on tree trunks, 83
- Fistulinoideæ, 230
- Fixatives, 655
- Flagella of slime moulds, 16
- Flecks of pith, 294
- Fleshy fungi, 218 et seq.
- Flies and spore distribution, 67
- Flowers of tan, 17
- Flowering plants as cause of disease, 275
- Flückiger mentioned, 56
- Fogs, influence of, 284
- Foliose lichens, 79
- Fomes applanatus, 313; fomentarius, 523; figure of, 229; fraxinophilus, figures of, 481, 482; on beech, figure of, 524; igniarius, figure of, 554; of rot by, 555, 556
- Forms of rust life cycles, 189
- Fossil fungi, 82
- Fraser, Miss H. C., work on rusts, 191
- Free, E. E., work of, 407
- Freezing attachment for microtome. figure of, 657
- Freezing material, 656, 657; microtome, figure of, 658
- Fries mentioned, 7
- FronDESCENCE, 336
- Frost cracks, 294; influence of, 283; necrosis of, 569
- Fruit-pit of apples, 570
- Fruit-rot of orange, 533
- Fruticose lichens, 79
- Fuhrmann, F., cited, 22, 24
- Fuligo septica, as flowers of tan, 17; yellow plasmodium, 12
- Fuligo, spore formation in, 14
- Fungi as cause of disease, 306, 307; as disease producers, 275
- Fungicides, definition of terms, 669
- Fungi imperfecti, characters of, 258-269
- Fusarium batatatis, figure of, 267; heterosporium, 61; hyperoxysporum, figure of, 267; lycopersici, 646; putrefaciens, infection by, 273; species of, 267, 269; trichothecoides, 543, 643; violæ, figure of, 268

G

- Galactose, 58
- Gallionella, 37
- Galls, 342, 348, 384 et seq.; aeration tissues, 400; animal, 296; and insect producers, 396; assimilation tissues of, 400; bibliography of, 401, 402; cataplasmic, 385; formation, 72; histology of, 396, 397; hyperplasia, 384; hypertrophy, 370, 371, 384; mechanic tissue of, 398; nutritive tissue of, 398; of cranberry, 509; protective tissues, 398; secretory reservoirs of, 400; vascular tissues of, 400
- Gamomery, 336
- Gangrene, 343, 352
- Gas injuries, 649

- Gases, effect of, 289
 Gasteromycetes, character of, 239, 240
 Geaster, 239, 244
 Geaster fornicatus, figure of, 243;
 hygrometricus in sandy soil, 83
 Gelatin, nutrient, 604
 Gelatin, sugar, 604
 Gelatinous threads of chestnut blight,
 figure of, 494
 Gemmiparity, 336
 Genera of smuts, 182
 Genetics emphasized, 271; nature of, 271
 Gentian violet, Ehrlich's anilin-water,
 589
 Geoglossaceæ, description of, 169
 Geoglossum glutinosum, 170; hirsutum,
 169; figure of, 170; range of, 85
 Geographic distribution of fungi, 82
 Gerardia as a root parasite, 299
 Germination of smut chlamydo-spores,
 507; of smut spores, 181; of spores,
 61; of spores and bacteria, 25; of
 spores of slime moulds, 16
 Germination studies, 615
 Gerry, Eloise, work on tyloses, 370
 Giant cells, 371
 Gilg cited, 2
 Gilson, research of, 52
 Ginger beer, 140
 Girdling of trees, 295
 Glanders, 35
 Glæosporium venetum, 544
 Glomerella cingulata, 477, 478; gossypii,
 508; rufomaculans, 264, 477, 478
 Glucose, 53, 59
 Glucoside-splitting enzyme, 59
 Glycine hispida, figure of nodules on
 roots, 29
 Glycocol, 33
 Glycogen in fungi, 53
 Gnomonia veneta, 163, 264, 549; on
 plane, 85
 Graft hybrids, 329
 Grape, 512
 Graphis scripta on bark, 83
 Gram's stain, 590
 Gray mould, figure of, 42
 Green mould described, 45
 Griffiths, David, work cited, 163
 Grove, W. B., book of, 189
 Guenther mentioned, 54
 Guignardia Bidwellii, 512; of grape, 163;
 vaccinii, 509; figure of, 510
 Guillermond, M. A., work cited, 142
 Gummosis, 343, 350
 Guttulina rosea, 8
 Guying, 323
 Gymnaxyony, 336
 Gymnoascaceæ, characters of, 143
 Gymnoconia interstitialis, figure of, 202
 Gymnosporangium bisepatum, figure
 of swelling caused by, 347; clavariæ-
 forme, mycocecidia of, 393; Ellisii
 73, 210; figure of, 205; globosum, 210;
 Gymnosporangium juniperi-virginianæ,
 74, 211-214; mycocecidia, 393; species
 of, 208-210
 Gynophyly, 336
 Gypsum blocks and yeast spores, 622
 Gyromitra, 171

H

- Hackberry, witches' broom, 73, 351
 Haas, Paul, book of, 57
 Hæckel, Ernst, cited, 7
 Hæmatimeter, Thoma's, 617; details
 of, 619
 Hail and plants, 286
 Hailstones, bruises by, 294
 Hanbury, 487
 Hanging-drop preparations, 587
 Hansen, E. Chr., work of mentioned, 32,
 141
 Haploid chromosomes in slime moulds,
 16
 Happy white elm, figure of, 286
 Hard pan, influence of, 281
 Harper, R. A., cited, 13, 15, 112, 165
 Harshberger, John W., observations on
 acid spotting of morning-glories, 293;
 work of, 308; on pine-barrens, 281; on
 white cedar fungi, 394

- Haustoria, 48; of Erysiphaceæ, 155
 Hay bacillus, 36
 Heald, F. D., work of, 342
 Heart-rot of ash, 481, 483; of hemlock, 517
 Heat as factor in plant disease, 282
 Helotiaceæ, characters of, 168
 Helvellaceæ, characters of, 170
Helvella crispa, 171; *esculenta*, fat content, 56
Helvelliinæ, a suborder, 169
 Hemibasidii, 178
Hemileia vastatrix, 503
 Hemlock, 517
 Hemisyncotylous races, 329
 Hemitery, 336
Hemitrichia vesparum, plasmodium of, 12
Hepatica triloba attacked by *Tranzschelia punctata*, 348; figure of, 349
 Hepburn's definition of enzyme, 56
 Herbivores and spore distribution, 66
Heterodera radicolica, 391, 651
 Heterogamy, 336
 Heteromorphy, 336
 Heteroplasia, 374, 375
 Heteroplasm, correlation, 376
 Heterotaxy, 336
 Heterothallic moulds, 93
 Hill, T. G., book of, 57
 Histology emphasized, 271
 Histology of callus, 379; of cataplasms, 391; of fungi, 52; of galls, 396, 397
 Histozyeme, 58
 Hollyhock, 517; rust, 203, 206, 517; figure of, 518
 Homoplasia, 374, 375
 Homothallic moulds, 93
 Homotypy, 336
 Horses, injury by, 310
 Host list of oomycetous fungi, 115
 Humphrey, C. T., mentioned, 75
 Humus, influence on plants of, 281
 Hydneeæ, characters of family, 223
Hydnocystis arenaria and black beetle, 71
 Hydnoraceæ, parasites of, 299
Hydnum erinaceus, figure of, 224, 556
Hydnum, species of, 223
 Hydrocyanic acid, 59
 Hymenium, 232
 Hymenogastraceæ, character of family, 240
 Hymenomycetes, characters of, 219
 Hyperchimæras, 330
 Hyperhydric tissues, 366
 Hyperplasia, 355, 373
 Hypertrophy, 337, 347, 354, 364 et seq.; kinds of, 364
 Hyphæ, 42
 Hyphomycetales, characters of, 266
 Hypochnaceæ, characters of, 220
 Hypocreaceæ, characters of, 160
 Hypomyces, range of species of, 85; lactifluorum parasitic on *Lactarius*, 160
 Hypoplasia, 354, 357; and cell contents, 359, and tissue differentiation, 360; number of cells, 357; size of cells, 358
 Hypothallus, 13
 Hypoxylon, 164
 Hysteriaceæ, characters of, 165

I

- Ice action, 295
 Ice fringes, their formation, 283, 284
 Ice load of, figured, 285
 Ice storm and trees, 284, 285, 286
 Iceland moss on ground, 83
 Icterus, 343
 Idiotery, 337
 Illuminating gas, effect of, 291, 292
 Immunity, 272, 325; to plant disease, 274
 Impregnation of wood with preservatives, 692
 Indol, 33
 Incubation, 312
 Incubator, copper, 612
 Infection by fungi, 307
 Infusions of plants, 600
 Injured tree, figure of, 309

Injuries by acid, 649; by gas, 649; by smoke, 649
 Inoculation experiments, 643 et seq.
 Inorganic elements in fungi, 55
 Insecticides, 678, 679
 Insects as cause of disease, 275; as gall producers, 396; biting, 296; sucking, 296; wood-boring, 310
 Intercellular hyphæ, 48
 Internal causes of disease, 326
 Intucellular hyphæ, 48
 Intumescences, 366
 Inulin, 58
 Inulase, 58
 Invertase, 58
 Involution forms of *Bacillus radicolica*, 30; of bacteria, 364; of *Pseudomonas tumefaciens*, 365
 Iron indispensable to fungi, 54; influence of, 277
Irpex, species of, 223, 224
 Isolation of fungi in pure culture, 624
Ithyphallus impudicus, 252; and flies, 67

J

Jahn, E., cited, 13
 Jeffer's counting plate, 628; figure of, 629
 Jew's ear fungus, 216
 Jones, L. R., work on cabbage immunity, 274
Juniperus virginiana, cedar apples on, 394

K

Kapoustnaja kila, 487
 Karyokinesis, in fungi, 53
 Kephir, 58, 140
 Kerner, Anton, work of, 385
 Key to determine species of *Mucor*, 695-702
 Keys to Erysiphaceæ, mentioned, 157
 Key to families of Oomycetales, 109; to families of Perisporiineæ, 154; to families of Zygomycetales, 97; to

fleshy fungi, list of, 729-732; to genera of family Exoascaceæ, 133; to genera of Peronosporaceæ, 114; to Myxogastriales, 693-695; to Nidulariaceæ, 244, 245; to species of *Penicillium* on agar and gelatin, 712-719; to suborders of Basidiomycetales, 177
 Kiln-drying, 693
 Kinase, 57
 Kinds of lichen thalli, 79
 Koernicke, Max, experiments with Roentgen rays, 62
 Kohlhernie, 487
 Koji fungus, 58
 Kolkwitz, experiments of, 62
 Knauers, 348
 Knife punch, figure of, 597
 Knot of citrus trees, experiments with, 647
Kuehneola gossypii, 508
 Kühne, mentioned with enzymes, 56
 Kurssanow, work on rusts, 191

L

Laboratory exercises, 581; with slime moulds, 18
 Laboulbeniaceæ, 172; hosts of, 86; work of Faull on, 173
 Laboulbeniineæ, 171
Labyrinthula Cienkowskii, 11
Lachnea description of several species, 169; *scutellata*, figure of, 166
Lactarius, 731; *chelidonium*, description of, 740; *deceptivus*, description of, 740; *deliciosus*, description of, 740; description of genus, 740; *fumosus*, description of, 741; *piperatus*, description of, 741; *indigo*, description of, 741; *volemus*, description of, 742
 Lactic acid fermentation, 32, 59
 Lactase, 58
 Lactose, 58, 59
Lamium orvala, figure of, callus, 378
Lamprocystis, 39
 Lantz, Cyrus W., bibliography by, 564

- Larch, 519; canker, 168, 519; dry-rot, 519
 Late-blight of potato, 542
 Lathræa squamaria as a root parasite, 299
 Lathrop, Elbert C., work of, 33
 Laticiferous hyphæ, 48
 Laudatea, a lichen, 81
 Leaf-blotch of maple, 523
 Leaf-casting, 575
 Leaf-curl of cherry, 491; of peach, 534
 Leaf-mildew of chestnut, 502
 Leaf-spot of alfalfa, 476, 477; of apple, figure of, 344; of beet, 484, 485; of coffee, 503; of violet, figure of, 559
 Leaves, skeleton, 294
 Leguminous tubercles, 387
 Leocarpus fragilis, figure of, 17
 Leotia chlorocephala, 170; lubrica, 170
 Lepidophyton, 147
 Lepidosaphes ulmi, figure of, 276
 Leptothrix, 37; ochracea, 29
 Lepyrophyly, 337
 Lemon, 520
 Lenticels, hypertrophied, 366
 Lenzites betulina, 64; occurrence of, 230; sepiaria and rotting of slash, 75
 Lettuce, 522; drop, 522; experiments with, 644
 Leucin, 33
 Leuconostoc mesenterioides, 34
 Levulose, 58, 59
 Liberation of spores, 62; in Coprinus comatus, 65
 Lichen thalli, 79; algæ, 78; as fungi, 79; parasitism of fungi, 79; nature of, 78; structure of thallus, 81
 Life cycle of Oomycetales, diagram of, 108; of Pyronema contrasted with fern, 126
 Life histories, description of, 641
 Light and pathologic conditions, experiments, 652
 Light and red pigment, 360; influence of, 61, 281; action of, 288, 289
 Lightning, injury by, 311
 Lilac, 522; mildew, 522
 Lime-sulphur, 675-677
 Linaria vulgaris, peloria of, 329
 Lindau, G., mentioned, 171
 Lipase, 58, 59
 Liquid nutrient solutions, 592-595
 List of common plant diseases, 414-473; of keys to fleshy fungi, 729-732
 Lister, A., work of mentioned, 18
 Literature of plant diseases, exercises in compiling, 642; on tree surgery, 324
 Litmus milk, 600; whey, 600
 Living organisms as cause of disease, 275
 Locomotion of bacteria, 23
 Lohdenwedge, 379
 Long, W. H., mentioned, 75
 Lophotrichous, 23
 Loranthaceæ, parasites of, 301
 Lotsy, P., work on sexuality of Ascomycetales, 122
 Luminosity of fungi, 62
 Lumpjaw of cattle, 39
 Lupinus angustifolius, figure of cross-section of tubercle, 30, 387, 388
 Lycogala epidendrum, plasmodium of, 17
 Lycoperdaceæ, character of family, 241
 Lycoperdon, species of, 241, 242

M

- MacBride, Thomas H., work of mentioned, 18
 MacDougal, D. T., experiments with fungi in dark, 61
 Macroductylis subspinosus, figure of, 275
 Macrosporium solani, 266, 267
 Magnesium, influence of, 277
 Magnification values, tables of, 663
 Maladie digitorie, 487
 Malaria, 18
 Malformations, 329, 342, 348
 Malpighi, 385
 Maltase, 58
 Maltose, 58
 Manihot, œdema of, 567
 Mannite, 53

- Mannose, 58, 59
 Manual of American boletes, 227; of polypores, 227
 Maple, 523; decay, 523; leaf-blotch, 523
 Map of chestnut blight fungus, 84
 Marasmius oreades, 74; figures of, 75, 735
 Massee, George A., book of, 91; mentioned, 169
 Masters, Maxwell T., 331, 340
 Matzoon, 141
 Mazum, 141
 McAlpine, D., work of, 570, 571
 Mechanic development of pathologic tissues, 403, 404, 405
 Mechanic injury, 294
 Mechanic tissue in galls, 398
 Mechanics of pathologic tissues, bibliography of, 405, 406, 407
 Meiophylly, 337
 Meiotaxy, 337
 Melampsoraceæ, characters of family, 198
 Melampsora, species of, 199
 Melampsoropsis, species of, 199
 Melampyrum as a root parasite, 299
 Melanconiales, characters of, 264
 Meliola camelliæ, 54; distribution of, 85; Penzigi, 521
 Melitiose, 58
 Melogrammataceæ, characters of, 164
 Melon anthracnose, 525; wilt, 525
 Merulius lactymans, 553; description of, 224, 225, 226; figure of, 225, 226
 Meruloideæ, 224
 Meschinelli, L., work on fossil fungi, 82
 Mesospores, 188
 Mespilodaphne sassafras, section of old-wood, figure of, 369
 Metal-covered cavities, 323
 Metamorphosis, 337
 Metaphery, 337
 Metaplasia, 354, 362 et seq.; and cell contents, 362; and cell membranes, 363
 Metastasis, 337
 Metatrophic bacteria, 31; organisms, 28
 Meteorologic factors of disease, 281
 Methods of teaching, 407-410
 Methylene blue, alkaline, 589
 Meyer, mentioned, 54
 Micrococcus, 34; aurantiacus, 34; cinnabareus, 34; gonorrhœæ, 34; luteus, 34; progrediens, diameter of, 21, 22; pyogenes aureus, 34; ureæ, diameter of, 22; with urease, 59
 Micrometer, eyepiece, 582; filar, 583; figure of, 583; stage, 582; step, 585; figure of, 586; tables of values, 584, 585
 Micrometry, 582
 Microsphaera alni, 522; figure of, 157; key to species of, 724, 725
 Microspira, 37
 Microtome, figure of sliding, 654; with freezing attachment, figure of, 658
 Microthyriaceæ, characters of family, 158
 Mildew of grape, figure of, 515
 Milk, 600; litmus, 600
 Mischomany, 337
 Miso sauce, 146
 Mistletoe diagram of habit, 304; figure of, 302, 303; references to literature, 304; study of, 651
 Mites, 296
 Mixing of cement, 321
 Miyoshi, M., experiments with chemotaxis, 60
 Mniun hornum and underground truffles, 71
 Molisch, Hans, experiments of, 62; mentioned, 54
 Mollisiaceæ, characters of, 169
 Monoblepharidaceæ, characters of, 109
 Monoblepharis sphaerica, structure of, 109
 Monospora, 141
 Monosy, 337
 Monotrichous, 23
 Monstrosities, 329
 Moore, Geo. T., work of, 31

- Morchella, 170, 171; *esculenta*, analysis of, 55
 Morel, 170, 171
 Morphology emphasized, 271; of bacteria, descriptive terms, 633; of chestnut blight fungus, 497
 Mortierellaceæ, characters of family, 103
 Mortification of tissues, 346
 Mosaic diseases, 327
 Mosaic of bean, 577; of tobacco, 578
 Mottle-leaf, 573
 Mould fungi, 92; sexual reproduction, 93
 Mounting bacteria, 588
 Movement of plasmodium, 12
 Mucoraceæ, character of, 97
 Mucor, figure of, 42; key to species, 695-702; *mucedo*, chitin in, 52; described, 45; figure of, 44; occurrence of, 83; sporangia of, 96; structure of, 98; *racemosus*, chitin in, 52; *Rouxii* as Chinese yeast, 99; various species of, 98
 Multinucleate cells, 372; giant cells, 371; spores of *Rhizopus nigricans*, 96
 Multiplication, 337
 Mummification, 342, 347
 Münch, E., experiments on water and air content of tissues, 280
 Murrill's arrangement of fleshy fungi, 228
 Muscaria, 56, 238
 Mushrooms, 231; chemistry of, 237; cultivation of, 236, 237, 693; development, 235, 236; figures of, 234, 746; toxicology, 237, 238, 239
 Mutations, 328
 Mutinus caninus, development of, 248, 249; and flies, 67
 Mycelium, 42; of *Endothia parasitica*, figure of, 496
 Mycetozoa, 7
 Mycocecidia, 393
 Mycodendron paradoxum, 226
 Mycoderma aceti, 59; nature of, 142
 Mycomycetes, 46, 120
 Mycoplast, 49; Eriksson's, 190
 Mycorrhiza, 49
 Mylitta australis, sclerotium of, 71
 Myriangiaceæ, 153
 Myrica carolinensis, tubercles on roots, 39
 Myxamœbæ, 15
 Myxobacter, 40
 Myxobacteriaceæ, 21, 39
 Myxococcus, 40
 Myxogastrales, characters of, 11; key to, 693-695
 Myxogastres, 7
 Myxomycetes, 1, 7
- N
- Nanism, 346
 Nature of tree surgery, 320
 Necrosis, 342, 346; frost, of potato tubers, 569
 Nectria cinnabarina, description of, 160
 Nectria, figures of various species, 159
 Neisser's counting apparatus, 629
 Nematode infection, 651; worms as gall formers, 391
 Neocosmospora vasinfecta, 646
 Neopigenesis, 404
 Neoevolution, 404
 Nidularia, 244
 Nidulariaceæ, character of family, 244; key to, 244, 245
 Nitric organism, isolation of, 611
 Nitrifying bacteria, 29
 Nitrobacter, 29
 Nitrogen cycle, 33; deficiency, influence of, 278; fixation, 612; influence of, 278; source of in fungi, 55
 Nitrococcus, 29
 Nitrosomonas, 29; *javanensis*, 29
 Nodule-forming bacteria, 29
 Nodules of roots, 387
 Non-parasitic diseases, 564; bibliography of, 580
 Normal solutions, 613
 Nothofagus with *Cyttaria*, 74

Nuclear apparatus of yeasts, 135; division in yeasts, 136; phenomena in fleshy fungi, 218; in rusts, 192, 193; phenomena of fleshy fungi, students of problems, 218, 219

Nuclease, 58, 59

Nuclei in fungous cells, 53

Nucleus in bacteria, 23

Number of spores produced, 63

Nummularia Bullardi on beech branches, 164

Nutrient solutions, 592-595

Nutrition of bacteria, classification according to, 28

Nutritive disturbance as cause of disease, 328; tissues in galls, 398

Nyctalis asterophora, parasitic, on *Russula nigricans*, figure of, 43

O

Oak, 526; decay, 526; root-rot, 530

Oat, 531; rust, 531; crown rust of, 202

Obligate parasite, 42; saprophyte, 42

Edema, 352; of manihot, 567; figure of, 568

Oenothera Lamarckiana, 328

Oidiospores, 50

Oidium lactis in Matzoon, 141

Oils in fungi, 53, 56

Olive, Edgar W., work on rusts, 191; cited, 13

Onion, 531; smut, 531

Oochytriae, 117

Oolysis, 337

Oomycetales, 43, 50; bibliography of, 118, 119; characters of, 107; key to families, 109; motile cells in, 52; occurrence of, 108; sexual reproduction in, 107

Oomycetous fungi, host list, 115

Oospora scabies, occurrence of, 83

Oospores, 50

Orange, 533; black-rot, 533; fruit-rot, 533; juice, 598

Orobanchaceae, parasites of, 299

Orobanche, as a parasite, 299; minor, figure of, 300

Organized ferments, 56

Orton, W. A., on quarantine, 317

Osmomorphosis, 404

Ostwald, mentioned, 57

Oyster mushroom, 738

Oyster-shell scale, figure of, 276

Oxidizing enzymes, 59

P

Pachyma cocos, 72; *malacense*, sclerotium of, 72

Pallor, 342

Panaschiering, 326

Parachromatophorous, 26

Paraffin method, 656

Paralyzers, 57

Parasite, 42; chlorophylless, 298; green, 298; on roots, 299

Parasitic algæ, 391

Parasitism of lichen fungi, 79

Paratrophic bacteria, 33; organisms, 28

Parmelia perlata, figure of, 80; on trunks of trees, 83

Pasteurization, 625

Pasteur mentioned, 56

Patellariaceae, 160

Pathogenic fungi, study of, 639

Pathologic plant anatomy, 354; tissues, mechanic development of, 403, 404, 405

Pathologist, character of work of, 341

Pathology, special plant, 411 et seq.

Patterson, Flora W., bulletin of, 244

Pea, 534; pod-spot, 534

Peach leaf cure, 534; yellows, 315, 573

Pear, 536; blight, experiments with, 644, figure of experiment, 645

Peloria, 329, 337

Peltigera canina on ground, 83

Penicillium atramentosum, figure of, 713; *biforme*, figure of, 716; *brevicaule*, description of, 709; figure of, 709; *Camemberti*, description of, 706, 707; figure of, 706; *chrysogenum*, 711;

- claviforme, figure of, 710; commune, figure of, 717; decumbens, figure of, 715; digitatum, figure of, 720; Duclauxii, figure of, 711; expansum, figure of, 704; funiculosum, figure of, 714; general characters of, 703; glaucum, 61; chitin in, 52; described, 45; figure of, 46; with lipase, 59; italicum, 533; figure of, 708; key for species on various substrata, 719, 720; key to species grown on agar and gelatin, 712, 719; lilacinum, figure of, 713; purpurogenum, figure of, 719; Roqueforti, description of, 704; figure of, 705; roseum, figure of, 712; rubrum, figure of, 718; rugulosum, figure of, 721; spinulosum, figure of, 718; stoloniferum, description of, 708; figure of, 707
- Penzig, O., work of, 331
- Pepsin, 59
- Periclinal chimæras, 330
- Peridermium, 188; species of, 201; strobi, 537
- Periphylogeny, 337
- Perisporiaceæ, characters of family, 158
- Perisporiineæ, characters of, 154; key to families, 154
- Perithecium, structure of, 121
- Peritrichous, 23
- Permutation, 337
- Peronosporaceæ, cellulose in, 52; characters of family, 111; generic key, 114
- Peroxidase, 59
- Pestalozzia Guepini var. vaccinii, 266
- Petalody, 329, 337
- Petalomania, 337
- Petersen, Henning E., work of, 111
- Petri dish, figure of, 622
- Peyritsch, J., mentioned, 171
- Peziza æruginosa, uses, 168; aurantiaca, color of, 53; described, 167; badia, occurrence of, 167; coccinea, color of, 53, on dead twigs, 83; described, 67; Fuckeliana, 61; repanda, figure of, 167; Willkommii or larch canker, 168
- Phacidiaceæ, characters of, 165
- Pholiota adiposa, figure of, 76; on living trees, 74
- Phallaceæ, character of family, 252
- Phallin, 56, 238, 239
- Phallomycetes, 246-252
- Phanerogamic parasites, 298
- Phoma, 'species of, 262
- Phoradendron flavescens, as a parasite, 303; figure of, 302
- Phosphorescent fungi, 62
- Phosphorus, influence of, 278
- Photogens, 25
- Photographic prints, drawings of, 666
- Photomicrographic attachment to Edinger's apparatus, figure of, 662
- Photomicrography, method of, 666
- Phototropism, 61
- Phragmidiothrix, 38; multisepta, 38
- Phragmidium violaceum, fusion of adjoining cell nuclei, 191, 192
- Phycobacteriaceæ, 37
- Phycomyces nitens, 61; structure of, 100
- Phycomycetes, 45, 46, 50, 92
- Phyllactinia corylei, figure of, 53
- Phylloclady, 337
- Phyllody, 337
- Phyllomania, 338
- Phyllosticta paviae, figure of, 259; solitaria, figure of section, 262; on apples, figure of, 261; species of, 261 et seq.
- Phylloxera mentioned, 295; vastatrix, 391
- Phylogeny of Ascomycetales, 173, 174; of fungi, 89, 90, 01; of Uredinales, 197
- Physarum sinuosum, figure of, 17; ellipsoideum, plasmodium of, 12; psittacinum, 13
- Physcia parietina on rocks, 53
- Physical character of soil as determining cause of disease, 279
- Physical features of bacteria, 636
- Physics emphasized, 271
- Physiologic diseases, 564
- Physiology emphasized, 271
- Physiology of fungi, 54, 61

- Phytase, 58
 Phytocecidia, 385
 Phytomyxa, 9; leguminosarum, 11
 Phytomyxales, 8
 Phytopathological Society, American, 411
 Phytopathology, 411; definition of, 272
 Phytophthora infestans, 315, 542; escape of zoospores, 67; infection by, 273
 Pichia, 141
 Pilacaraceæ, characters of family, 217
 Pilobolus, figures of species, 102; crystallinus and horses, 68; occurrence of, 83
 Pineapple chlorosis, 650
 Pink disease of cacao, 490
 Piptocephalidaceæ, characters of, 103
 Piptocephalis parasitic on Mucor, 83
 Pistillody, 338
 Pith flecks, 294
 Placing of cement, 321
 Plague, 35
 Planococcus, 35; citreus, 35
 Planosarcina, 35
 Plant juices, 598
 Plant pathology, growth of, 410; special, 411 et seq.
 Plants as disease producers, 298
 Plasmodiocarps, 13
 Plasmodiophora, 9; alni, 9; brassicæ, 9, 387, 487, 488; on cabbage roots, figure of, 488; figure of, 10; eleagni, 9
 Plasmodium, aggregate, 8; colors of, 12; malaricæ, 18; movement of, 12
 Plasmopara viticola, 513; distribution of, 84; figure of, 113
 Plasmolysis, experiments with, 653
 Plate counter, 628
 Plectenchymatous, 258
 Plectasciineæ, characters of, 143
 Plectridium, 25
 Pleiomorphy, 338
 Pleiophylly, 329, 338
 Pleiotaxy, 338
 Plesiasmy, 338
 Pleurotus, description of genus, 737; olearius, 62; ostreatus, description of, 738; figure of, 738; serotinus, description of, 738, 739; sapidus, description of, 738; ulmarius, description of, 739
 Plowrightia, description of several species, 162; morbosa, 74, 540; distribution of, 84; figure of, 73
 Plugging test-tubes, 586
 Plum, black-knot of, 540; pockets, 74, 541
 Pod-spot of pea, 534
 Podosphæra, key to species, 722
 Poisoning by fungi, symptoms, 238, 239
 Poisonous substances in fungi, 238
 Pollaplasty, 338
 Polyangium, 40
 Polychrome methylene blue, 591
 Polyclady, 338
 Polyphagus euglenæ, occurrence of, 117
 Polyphyly, 338
 Polyporaceæ, characters of family, 224
 Polypores, manual of, 227
 Polyporoideæ, characters of, 226
 Polyporus borealis, 517; mylittæ, sclerotium of, 71; officinalis, analysis of, 55; ponderosus, 539; sapurema, sclerotium of, 71; sulphureus, 526; figure of fruit, 527; figure of decaying oak, 528; on trees, 83; with trehalase, 58; tuberaster, sclerotium of, 71
 Polysphondylium violaceum, 8
 Polystictus abietinus and rotting of slash, 75; socer, sclerotium of, 72; versicolor, 64, 545
 Poppy, fasciated, figure of, 336
 Poplar cutting, figure of, 378
 Populin, 59
 Populus pyramidalis, cuttings of, 379
 Potassium hunger, 277
 Potato, 542; as medium, 596; broth, 597; curly-dwarf of, 576; glycerinated, 596; juice, 596; late-blight, 542; rot, experiments with, 643; scab, 544
 Pouring plates, figure of, 622; method of, 622, 623

- Powdery dry-rot of potato, 543
 Powdery mildew of cherry, 491; of lilac, 522
 Predisposing causes of disease, 272
 Preservation of wood, 692; of fungi, 726, 727
 Prevention of disease, bibliography of, 318
 Preventive measures, 319
 Prints of spores, 728
 Production of spores, 63
 Prolifcation, 338
 Projection apparatus, 657
 Prophylaxis, 298, 317
 Prosoplasms, 376, 395
 Prosoplastic hypertrophy, 364
 Protease, 58, 59
 Protective tissues in galls, 308
 Proteins, splitting of, 33, 59
 Protista, 7
 Protoasciineæ, 131
 Protomyces, occurrence of species, 121
 Protomycetaceæ, 121
 Protophyta, 7
 Protoplasm of fungi, 53
 Prototrophic organisms, 28
 Protozoa, 7
 Pruning careless, 310; unskillful, figure of, 310
 Pseudomonas, 35, 36; brassicæ, 485, 486, 487; campestris, 36, 645; europæus 37; hyacinthi, 36; indigofera, length and breadth of, 22; putida, 37; pyocyanea, 37; Stewarti, 644; syncyanea, 37; tumefaciens, 34, 388, 643; involution forms of, 365; vascularum, 36
 Pseudopeziza medicaginis, 169; on alfalfa, 476, 477
 Ptomaines, 33
 Pucciniaceæ, characters of family, 201
 Puccinia asparagi, 483, 484; character of, 191; coronifera, 531; forms of, 202; coronata, forms of, 202, 203; glumarum, forms of, 203; graminis, 560; distribution of, 84; figure of, 188; forms; of, 191, 201, 202; malvacearum, 206, 517; figure of, 518; species of, 203, 204, 205, 206
 Puff-balls, 239, 240
 Puffing of spores, 66
 Pumps for spraying, figures of, 691
 Punks, 342
 Pustules, 342
 Putrefaction, 33
 Pycnidial pustules of chestnut blight, 499
 Pycnidiospores, 50
 Pycnidium, 50
 Pycnium, 188
 Pycnoconidia, 50
 Pycnospores, 50; 188; germination of chestnut blight, figures of, 501
 Pyrenomyctiineæ, characters of, 159, 160
 Pyronemaceæ, characters of, 165
 Pyronema, life cycle contrasted with fern, 126; confluens and sexuality, 165; reinvestigation of, by P. Claussen, 123; work on by R. A. Harper, 122
 Pythiacystis citriophora, 520; on lemon, 85
 Pythium de Baryanum, distribution of, 84
- Q
- Quarantine to prevent disease, 317
 Quercus reticulata parasitized by Conopholia mexicana, 299
 Quercus Wislizeni, figure of section of gall, 399; gall on, 398
 Quick-drying varieties of plants, 273
- R
- Races of moulds, 95
 Rachitism, 338
 Raffinase, 58
 Raffinose, 58
 Rafflesiaceæ, parasites of, 301
 Raspberry anthracnose, 544
 Rate of spore fall, 64

- Razoumofskya Douglasii laricis as a parasite, 304
- Recrudescence, 338
- Red clover, figure of tubercle section, 389
- Red gum, 545
- Red-rot of pine, 539
- Red spider, 296
- Reduction in size, 342
- Regeneration, 355
- Reindeer lichen on ground, 83
- Rennin, 59
- Replacement, 342, 347
- Reproduction in bacteria, 24
- Resin in fungi, 56
- Resinosis, 343, 350
- Resin wash, 521
- Resistance to disease, 325
- Restitution, 355, 356, 357; meaning of word, 355; process of, 355
- Reticularia lycoperdon with æthaliium, 17
- Reticularia, spores of, 16
- Retting of fibers, 33
- Reynolds, Ernest Shaw, mentioned, 271
- Rhabdochromatium, 39
- Rhizinaceæ, 171
- Rhizobium leguminosarum, 29, 36
- Rhizocallesy, 338
- Rhizoctonia solani, 269
- Rhizomorph, figure of, 47
- Rhizomorpha subterranea, figure of, 47
- Rhizopus nigricans, chitin in, 52; conjugation of, 94; figure of, 100; occurrence of, 82; structure of, 99
- Rhodobacteriaceæ, 38
- Rhodomycetes Kochii, 61
- Rhytisma acerinum, 523; on maple, 165
- Ribes aureum, figure of hypertrophied bark, 367
- Ringling of trees, 295
- Roentgen rays and fungi, 62
- Rœstelia, 188; aurantiaca, figure of, 204; on apple, diagram of, 212; on apple leaf, figure of, 210; on apple, magnified view, 211
- Rodents and truffles, 68; injury by, 294
- Root asphyxiation, 565; parasites, 299
- Root-rot of oak, 530; of tobacco, 550; figure of, 551
- Roquefort cheese, 704, 705
- Rose chafer, figure of, 275
- Rosellinia quercina on oak seedlings, 163
- Rosettes, 342
- Rostafinski mentioned, 7
- Rotation of crops to prevent disease, 317
- Rottenness, 352
- Rotten wood, 307
- Rotting, 343, 352; of brush, 75
- Rozites gongylophora and the tugging-ant, 365; as food for tropic ants, 71
- Ruppia rostellata, 11
- Russula, 48; description of genus, 742; emetica, 742; in forest litter, 83; nigricans parasitized by Nyctalis asterophora, figure of, 43, with tyrosinase; ochrophylla, description of, 743; roseipes, description of, 743; rubra, description of, 743; virescens, color of, 53; description of, 743; in forest litter, 83
- Rust fungi, 187; occurrence of, 86; lesion on apple leaf, section of, 213; life cycles, forms of, 189; of alfalfa, 477; of asparagus, 191, 483, 484; of beet, 485; of clover, 502; of coffee, 503; of cotton, 508; of hollyhocks, 203, 517; of oat, 531
- Rust, spore relations, diagram of, 190
- Rusts, bibliography of, 214, 215, 216; cytology of, 191; life cycle, 195
- Rye, 546

S

- Saccharomyces anomalous, 40; aquifolii, 140; cartilaginosus in Kefir, 104; cerevisiæ, 52; description of, 138; figure of, 135; ellipsoideus, description of, 139, 140; figure of, 139; of nuclei and division, 136; exiguus, 140; fragilis in Kefir, 140; illicis, 140; Ludwigi, 141; octosporus with maltase, 58; Pastorianus I, 140; pyri-formis, 150; Vordemanni, 140

- Saccharomycetaceæ, characters of, 134
 Saccharomycetiineæ, 134
 Saccharomycodes, 141
 Saccharomycopsis, 141
 Saké, 146
 Salicin, 59
 Salmon, Ernest S., monograph of, 157
 Salpinganthy, 338
 Sandalwood, parasitism of, 298
 Santalum album, parasitic on *Acacia leucophæa*, 298; on roots of *Melia azidarachta*, 298
 Saponaria officinalis, anther smut of, 72
 Saprogenic organism, 33
 Saprogens, 25
 Saprolegnia, 44; ferax on fishes 110, 111; structure of various species, 110; escape of zoospores, 67
 Saprolegniaceæ, cellulose in, 52; character of family, 110
 Saprophyte, 42
 Sap-rot of red gum, 545; of timber, 558
 Sarcina, 35; aurantiaca, 35; flava, 35; lutea, 35; maxima, diameter of, 22; rosea, 35; ventriculi, 35
 Sarcosphæra, figures of several species, 166
 Scab of apple, 479, 480, 481; figures of, 480; of potatoes, 544
 Scald of cranberry, 509
 Scarification of trees, 295
 Schizomycetes, 1; origin of name, 21
 Schizonema imbricator, a scale insect and *Scorias spongiosa*, 72
 Schizophyllum commune, 64; figure of, 77; xerophytic habits of, 78
 Schizosaccharomyces, 141
 Schmitz, J., mentioned, 61
 Sclerodermaceæ, characters of family, 246
 Scleroderma vulgare on old stumps, 83
 Sclerotia, 69; fungi bearing, 71
 Sclerotinia libertiana, 522, 644; description of several species, 168; sclerotia of, 69; figure of, 168
 Sclerotium, 48
 Scorias spongiosa, 158; life history of, 72
 Scrophulariaceæ, parasites of family, 299
 Scyphogeny, 338
 Sectioning methods, 633, 654
 Sectorial chimæras, 330
 Sepalody, 338
 Septoria leaf-spot, figures of, 263; species of, 264
 Sequoia gigantea, annual rings of, 358
 Serum of blood, 604
 Sexual act in slime moulds, 16
 Sexual reproduction in Oomycetales, 107; in *Sphærotheca Castagnei*, 155; in moulds, 93; in Ascomycetales, bibliography of, 129, 130; of Ascomycetales, 122, 123
 Shaggymane, figure of, 749
 Shot-holes, 342, 345; of plum leaves, figure of, 345
 Silene inflata, anther smut of, 72
 Silverberry, 9
 Size of bacterial cells, 21, 22
 Skatol, 33
 Skeleton leaves, 294
 Slant of vegetables, figure of, 597
 Sleeping disease of tomatoes, 646
 Sliding microtome, figure of, 654
 Slime flux, 343
 Slime moulds, bibliography of, 18, 19, 20; distribution of, 18; laboratory exercises with; in general, 7
 Smelter fumes, effect of, 289, 290, 291
 Smith, Erwin F., quoted on peach yellows, 315; work of, 34, 387
 Smoke, effect of, 289, 649
 Smut boil of corn, figure of, 504, 505, 506
 Smut explosions, 182
 Smut of oats, figures of, 532; of onion, 531; spores, germination of, 181
 Smuts, 178-186; bibliography of, 185, 186; genera of, 182; of anthers, 72; modes of infection, 181
 Snow action, 295; influence of, 284
 Soft rot, 343
 Soja sauce, 146
 Solenoidy, 338

- Solid vegetable substance, 598
 Solution 338; normal, 613
 Soot, effect of, 289
 Sooty mould of orange, 521
 Sorauer, P., book of, 564
 Sortariaceæ, characters of, 162, 163
 Sorosphæra, 9; veronica, 11
 Soy bean, figure of nodules on roots, 29
 Sparassis crispa, 223
 Special plant pathology, 411 et seq.
 Speiranthus, 339
 Spermogonium, 187
 Sphæria carpophila, 61
 Sphæriaceæ, characters of, 163
 Sphærobolaceæ, characters of family, 246
 Sphærochorisis, 339
 Sphæronema fimbriata, 548
 Sphæroopsidales, 260
 Sphæroopsis malorum, 262; figures of spots due to, 344; on apple, 478, 479; tumefaciens, 647
 Sphærotheca Castagnei, sexual reproduction in, 155; key to species of, 722
 Sphærotilus, 38
 Spirillaceæ, 37
 Spirillum, 37; berolinense, 37; comma, 37; danubicum, 37; parvum, thickness of, 21; rufum, 37
 Spirochæta, 37; dentium, 37; Obermeieri, 37; pallida, 37
 Spiroism, 339
 Spirosoma, 37
 Spontaneous chimæras, 330
 Sporabola, 234
 Sporangiospores, 50
 Spore discharge in mushrooms, 233, 234; figure of, 64
 Spore fall in Amanitopsis vaginata, figure of, 65; rate of, 64
 Spore formation in moulds, 96; germination, 61; prints, 728; production, 63
 Spores of yeasts, 622; of rusts, nuclear phenomena in, 192
 Sporodinia grandis, conjugation of, 94; occurrence of, 101
 Sporulation in yeasts, 137
 Spot disease of violet, 558
 Spots, colored, 342
 Spray calendar, 680-690
 Spray pumps, figures of, 691
 Spraying for plant protection, 318
 Sprays, 669 et seq.
 Spruce gum, collection of, 352
 Squared cover-glasses, 616; figures of, 617
 Squashes, 525
 Stab cultures, types of, 627; in figure, 627
 Stage micrometer, 582
 Stag-head, 395, 565
 Staining bacteria, 588
 Stains, 589-592
 Staminody, 339
 Standardization of culture media, 613
 Stasimorphy, 339
 Statement, general, 1
 Steeps, 677-678
 Stemonitis ferruginea, spores of, 16; flaccida, spores of, 16; fusca, figure of, 14
 Step micrometer, 585; figure of, 586
 Stereonemata, 15
 Stereum, 221, 222; fasciatum, and rotting of slash, 75; frustulosum, 553; rameale and rotting of slash, 75; umbrinum and rotting of slash, 75; versiforme and rotting of slash, 75
 Sterigmatocystis niger, character of, 147; figure of, 149
 Sterilization, 625
 Stesomy, 339
 Stevens, Neil E., mentioned, 84
 Stigmatomyces Bæri, structure of, 172
 Stippen, 570
 Strains of moulds, 95
 Strangulation, 294
 Strasburger, Ed., cited, 15
 Streak cultures, types of in fungi, 634
 Streak method of Bergey, 623
 Streak of sweet pea, 547
 Streptococcus, 34; erysipelatos, 34; mesenterioides, 34; pyogenes, 34

- Streptothrix, 37; fluitans, 37
 Strobilomyces strobilaceus, 230
 Strophomany, 339
 Structure of lichen thallus, 81
 Stub, figure of, 311
 Students of nuclear phenomena in
 fleshy fungi, 218, 219
 Students, suggestions to, 407
 Sturgis, W. C., literature of plant
 diseases, 411
 Stylospores, 50
 Succulence, abnormal, 368
 Sucrose, 58
 Sucking insects, 565
 Suffocation, 565
 Suffulcra of Erysiphaceæ, 155
 Sugar beets, curly-top of, 573
 Suggestions to teachers and students,
 407-410
 Sulphur bacteria, 28; influence of, 278
 Sunscald, 282
 Sunscorch, 282
 Suppression, 339
 Surgery of trees, 319 et seq.; figures of,
 320
 Susceptibility to disease, 325; to infec-
 tion, 273
 Sweet pea diseases, experiments with,
 647; streak, 547
 Sweet potato black-rot, 548
 Swingle, Dean B., studies on columella
 formation, 96
 Sycamore, 549; blight, 549
 Symbiotic, 49
 Symptomatology, 341
 Symptoms, description of, 640; of
 disease, 341; of poisoning, 238, 239
 Synandry, 339
 Synanthody, 339
 Synanthy, 339
 Syncarpy, 339
 Synchytriæ, 117
 Synchytrium, parasitism of various
 species, 117; vacciniï, 509
 Syncotylous races, 329
 Synophthy, 339
 Synspermy, 339
 Syphilis, 37
 Systematic account of bacteria, 34
 Systematic bacteriology, 630, 631;
 botany emphasized, 271; position of
 fungi imperfecti, 260
- T
- Taka-diastrase, 58, 146
 Tannin as a protective substance, 274
 Taphrina cærulescens on oaks, 85
 Taphrina, description of various species,
 134; of figures of, 132
 Tas Gu of Java, 146
 Taubenhaus, J. J., work of, 274
 Taxitery, 339
 Teachers, suggestions to, 407
 Teaching methods, 407-410
 Telegraph wires, injury by, 310
 Teliosorus of cedar apple, figures of
 section, 193, 194, 207
 Teliospores, 187; of cedar apple rust,
 figures of, 208
 Telium, 187
 Teleutospore, 187
 Teratology, 331; book on, 340
 Terfas as food of Arabs, 151
 Terfeziaceæ, character of, 151
 Terfezia, character and occurrence of
 various species, 151
 Test-tube plugging, 586
 Tetramyxa, 9; parasitica, 11
 Tetranychus mytilaspidis, 296
 Thalloid shoot of Lunularia, figures of,
 361
 Thallophytes, 1
 Thamnidium chætocladioides, 101, char-
 acter of species of, 102; elegans,
 figure of, 101
 Thaxter, Roland, work of, 172
 Theleporaceæ, characters of family,
 221
 Thermogens, 25
 Thesium alpinum, 298
 Thielavia basicola, 550; figures of, 551,
 552; pathogenicity, 149, 150

- Thiobacteriaceæ, 38
 Thiocapsa, 39
 Thiocystis, 39
 Thiodictyon, 39
 Thiogens, 25
 Thiopedia, 39
 Thiophysa volutans, diameter of, 22
 Thiopolyccoccus, 39
 Thiosarcina, 39
 Thiospirillum, 39
 Thiothece, 39
 Thiothrix, 38; nivea, 38
 Thoma's hæmatimeter, 617; details of, 618, 620
 Threshing machine active in spread of smuts, 179
 Thyridaria tarda, 490
 Tillet, Matthieu, mentioned, 182
 Tilletiaceæ, characters of, 182
 Tilletia, descriptions of various species, 184, 185
 Tilletia foetans, chlamydospores of, 561; tritici, description of, 184; figure of, 183
 Tilmadoche mutabilis, figure of, 17
 Timber decay, 553
 Timber sap-rot, 558
 Tip-burn of potato, 575
 Tissue forms of cecidia, 397
 Toodstools, 231 et seq.; guide to description of, 728, 729
 Tobacco, 550; mosaic disease of, 578; root-rot, 550; section of tumor, 392
 Toothwort as a root parasite, 299
 Top-dry, 565
 Tornadoes, injury by, 311
 Torsion, 339
 Toxicology of mushrooms, 237, 238, 239
 Trama, 232
 Trametes pini, 519; radiciperda, injury by, 311; robiniophila, occurrence of, 228; species of, 229; suaveolens, occurrence of, 228
 Transfer of fungi, 624
 Tranzschelia punctata attack on Hepatica triloba, 348
 Traumatism, 294
 Treatment of cavities, 321
 Tree surgery, figures of, 320; literature on, 324; in general, 319
 Trehalase, 58
 Trehalose, 53, 58
 Trembling fungi, 217
 Tremellaceæ, characters of family, 217; mucilage in, 52
 Trichia, 15; chrysoesperma with yellow elaters, 17; fallax, 15; scabra, plasmodium of, 12; varia with yellow sporangia, 17
 Trichothecium roseum, 61; chitin in, 52
 Tricotylous races, 329
 Trimethylamin in spores of Tilletia caries, 56
 Tripe de roche, 83
 Triplasy, 339
 Trophic correlation, 404
 Trophomorphosis, 404
 Tropisms of plasmodia, 12
 Trommelschlägel, 25
 Truffles and rodents, 68
 Truffles, occurrence, 151, 153
 Trypsin, 58, 59
 Tubercaceæ, characters of, 151
 Tubercles of velvet bean, figure of, 386
 Tuber, characters of various species, 153; figures of, 152; Requenii and black beetles, 71
 Tubeuf, Carl von, quoted, 553
 Tubifera Casparyi, plasmodium of, 12; ferruginea red plasmodium of, 12
 Tuckahoe, 72
 Tugging-ant and Rozites gongylophora, 365
 Tumescence, 352
 Tumor on apple stem, figure of, 390
 Tumor, figure of section of tobacco, 392
 Tumors in plants, 34, 342
 Turnips, brown-rot, figure of, 486
 Tyloses, 370; figure of, 369
 Tylostomacæe, 241
 Types of colonies, 626, 627; of stab cultures, 627

Tyrosin, 33
 Tyrosinase, 58, 59
 Twin cherries, figures of, 334

U

Ultramicroscopic organisms, 21
 Umbilicaria on *Octorara schist*, 83
Uncinula, key to species of, 725, 726
 Unhappy white elm, figure of, 287
 Unorganized ferments, 56
 Urease, 59
 Urea-splitting enzymes, 59
 Uredinales, 187; phylogeny of, 197
 Uredinæ, 187; characters of, 187
 Uredinospores, 188
 Uredinium, 188
Uredo gossypii, 508
 Uredospores, 49, 188
Urobacillus Duclauxii, length and breadth of, 22
Urocystis cepulæ, 531; several species, 185
Uromyces betæ on beets, 485; figure of species, 200; species of, 201; striatus on alfalfa, 477; trifolii, 502
Usnea barbata, mechanic tissues of, 81; the beard lichen, 83
 Ustilaginaceæ, characters of family, 178
Ustilago avenæ, figures of, 532; of several species, 180; *levis*, figures of, 532; *maydis* on maize and teosinte, 86; origin of name, 178; *zeæ*, 504, 505, 506; figure of, 505; *tritici*, figures of, 562

V

Vaccination, 314
Vaccinium vitis-idaea, gall on, 389
 Valsaceæ, characters of, 163
 Van Wisselingh, C., work of, 52
 Variegation, 343
Vaucheria, 44
 Vegetable slant, figure of, 597
Velum partiale, 232
Velum universale, 232

Velvet bean tubercles, figure of, 386
Venturia inequalis, 479, 480, 481; figures of, 480; *pomi*, 163
Verpa digitaliformis, 171
Verticillium albo-atrum, 646
Vibrio cholera, rapidity of cell division, 24
Villia, 141
 Violet leaf-spot, figure of, 559
 Violet spot diseases, 558
 Virescence, 339
 Volutin in fungi, 53
 Volva, 232
 Von Tavel, Dr. F., cited, 89
 Von Wettstein, R., mentioned, 61

W

Wager, Harold, work of, 135
 Wallroth mentioned, 7
 Walter, H., work of, 271
 Ward, H. M., and ginger beer organisms, 140
 Water analysis, 626
 Water content of tissues and disease, 280
 Water-core of apple, 571
 Water, influence of, 279
 Water-logging, 567
 Watermelons, 525; wilt of, 646
 Water requirements of plants, 279, 280
 Wettstein, R. von, 2
 Wheat, 560; broth, 599; rust, 188; forms of, 201, 202; smut, figures of, 562
 White pine blister-rust, 537
 White rust of cruciferous plants, 74
 Whey, litmus, 600
 Will, Dr. H., 142
 Wilt, 342
 Wilting, 342, 345, 346; experiments with, 652, 653
 Wilt of corn, 507; figure of experiment with, 646; of cotton, experiments with, 646; of cowpeas, 646; of egg plant, 646; of melons, 525; of sweet corn, 644; of watermelon, 646
 Wilson, Lucy L. W. on *Conopholis americana*, 301

Wind action, 295; dissemination of smut spores, 179; distribution of spores, 66; its influence on plants, 286

Wind-swept white poplar, figure of, 287

Winkler, H., work of on graft hybrids, 330

Winogradsky, mentioned, 54

Winter, G., mentioned, 61

Winterstein, research of, 52

Wire basket, figure of, 624

Wire worms, 651

Witches' brooms, 72, 342, 348, 395; on hackberry, figure of, 351

Withering, 652

Wood-boring insects, 310

Woody fungi, 218 et seq.

Worsdell, W. C., book of, 340

Wound-cork, 376; description of, 383

Wounding of plants, artificial, 648

Wound-wood, 376, 381, 382

X

Xylaria Cookei, 62; digitata on old wood, 164; hypoxylon, 62; polymorpha on old tree stumps, 164

Xylariaceæ, characters of family, 164

Y

Yeasts, 52; 134 et seq.; counting cells of, 617; character of fermentation, 137, 595; film formation, 137; on gypsum blocks, 622; spores, 622; sporulation, 137, with zymase, 59

Yellow rust of wheat, 203

Yellows of peach, 573

Yolk of eggs, 603

Youngken, H. W., 39

Z

Zeiller, work on fossil fungi, 82

Zoocecidia, 385

Zoogloea, 23

Zoology emphasized, 271

Zopf, W., cited, 7, 53, 56; handbook of, 55

Zygomycetales, 50; absence of cellulose, 52; bibliography of, 105; character of order, 92, 93; key to families, 97

Zygosaccharomyces, 141

Zygosporos, 50

Zymase, 56, 59

Zymogen, 57

Zymogens. 25



LIBRARY OF CONGRESS



0 002 811 246 4