

FIRST LESSONS

WILD WIKING

COMPTON

HIVISON • BLAKEMAN • & COMPANY  
NEW YORK • & CHICAGO

TT  
185

67

LIBRARY OF CONGRESS.

Chap. <sup>T. T185</sup> Copyright No. ....  
Shelf .C7

UNITED STATES OF AMERICA.









**MANUAL TRAINING**

---

# FIRST LESSONS

IN

# WOOD-WORKING

BY

✓  
ALFRED G. COMPTON

PROFESSOR OF APPLIED MATHEMATICS IN THE COLLEGE OF THE CITY  
OF NEW YORK, INSTRUCTOR IN CHARGE OF THE WORKSHOPS  
OF THE COLLEGE, AND AUTHOR OF A MANUAL OF  
LOGARITHMIC COMPUTATION



IVISON, BLAKEMAN, AND COMPANY

Publishers

NEW YORK AND CHICAGO

(1888)

TT 185  
.C7

COPYRIGHT,  
1888,  
By IVISON, BLAKEMAN & CO.

8-31408



## P R E F A C E.

---

THE series of lessons in wood-working here presented is intended, principally, for use in schools in which hand-work is pursued as a part of general training. The order of sequence is designed to lead the pupil from one tool to another of larger capabilities, and from one operation to another requiring a higher degree of skill.

In writing the descriptions of operations the aim has been to make them so full as to enable an intelligent pupil to perform the operations tolerably well, even without the help of an instructor, and at the same time to direct the attention of the instructor to the principal points that he ought to insist on, and the principal errors that are found to occur. The work being designed for young pupils, say between the ages of eleven and fourteen, it is not intended to go over much ground, nor to impart great skill, but only to open the way, reserving for another volume a more extended course. For the same reason, a thorough analysis of the mode of action of each tool is not attempted: this belongs rather to the teaching in a technical school, and

should have its place in a more advanced work for higher classes. Nevertheless, it is intended, not merely to teach the pupil how to handle the tool, but also to form in him the habit of considering how the tool operates, and what modifications it requires to adapt it to different uses, affording thus training not only for the hand and the eye, but for the attention and judgment as well,—an end to which hand-work, properly conducted, is at least as well adapted as many of the other studies that have heretofore monopolized the attention of our schools.

With the exercises in the use of tools have been interwoven observations on the properties of the materials used, and elementary principles of mechanical drawing, with the idea that the three studies, thus blended together, would lend help and stimulus to each other, and thus be pursued with more zest than if taught separately.

The division into lessons is necessarily, to some extent, arbitrary. The lessons may be found too long or too short, according to the time which the school may be able to allow. An intelligent instructor will easily combine them or subdivide them as occasion may require.

I am indebted to Messrs. Fairbanks & Co. for the design for a small testing-machine, Fig. 8, and to my colleague, Professor William Stratford, for the micro-photograph of a section of the wood of *Pinus Sylvestris*, Fig. 6.

## TABLE OF CONTENTS.

---

	PAGE
PREFACE . . . . .	iii
MATERIALS AND TOOLS NEEDED . . . . .	vii
LESSON	
I. Cutting tools—knife and hatchet; cross-cutting . . . . .	1
II. Knife and hatchet continued; splitting whittling, and hewing . . . . .	8
III. Strength of wood . . . . .	14
IV. The Cross-cut-saw . . . . .	21
V. Shrinking, cracking and warping of timber . . . . .	28
VI. Working-sketches . . . . .	32
VII. Working-drawings . . . . .	38
VIII. Making a nailed box; laying out the work . . . . .	44
IX. Hammer and nails; putting a box together . . . . .	49
X. The same, continued; taking apart . . . . .	54
XI. The Jack-plane . . . . .	58
XII. The Smoothing-plane . . . . .	68
XIII. Back-saw and bench-dog . . . . .	78
XIV. The Chisel; paring and chamfering; characters of different woods . . . . .	85

	PAGE
XV. The Chisel, continued; through mortise; brace and bit . . . . .	99
XVI. The Chisel, continued; end dove-tail . . . . .	111
XVII. Dove-tailed box; laying out the work; cutting the dove-tails . . . . .	119
XVIII. Gluing; hand-screws; putting the box to- gether . . . . .	128
XIX. Finishing a dove-tailed box; planing end- wood . . . . .	136
XX. Fitting hinges . . . . .	140
XXI. Making a paneled door; isometric drawing . . . . .	146
XXII. Paneled door, continued; mortise . . . . .	160
XXIII. Fitting a panel; the plow . . . . .	167
XXIV. Chamfering a frame; finishing with sand- paper and shellac . . . . .	172
ALPHABETICAL INDEX . . . . .	183

## Tools and Materials required for the Course of Lessons in Wood-Working.

### I.—TOOLS, ONE FOR EACH PUPIL.

Pocket-knife, two blades.

Lead pencil, No. 2.

Marking-gauge.

Cross-cut-saw, 22 inches long, 8 teeth to the inch.

Rip-saw,	22	“	4½	“	“
----------	----	---	----	---	---

Tenon-saw,	14	“	12	“	“
------------	----	---	----	---	---

Dove-tail-saw,	8	“	15	“	“
----------------	---	---	----	---	---

Try square, steel blade, 6 inches long.

Hammer, weight 1 lb., handled.

Mallet, “ 1 lb., handled.

Two-foot folding rule, metric and English on opposite sides.

Jack-plane, double-ironed.

Smoothing-plane, double-ironed.

Firmer chisel, one inch, pear-tree handle.

“	“	half-inch	“	“
---	---	-----------	---	---

“	“	quarter-inch	“	“
---	---	--------------	---	---

### II.—TOOLS, ONE FOR EACH BENCH (TWO PUPILS).

Double bench, with closets.

Bevel, blade 12 inches long.

Oil-stone, in box.

Oil-can, filled.

Bench-dog, 6 inches by 12.

Brace.

Center-bit,  $\frac{1}{2}$  inch.

Screw-driver,  $\frac{1}{2}$  inch.

Brad-awls,  $\frac{1}{8}$ " and  $\frac{1}{32}$ ".

### III. — TOOLS FOR EACH CLASS.

One chopping-block, 12 to 15 inches in diameter, 20 inches high.

One dozen straight-edges,  $\frac{1}{2}$ "  $\times$  2" — 24", pine.

Three glue-pots, 1 quart.

Three glue-brushes.

Two dozen hand-screws, 14 inches.

" " " " 9 "

Twenty pounds glue.

Can of sperm-oil, 1 gallon.

" white shellac varnish, 1 gallon.

One fore-plane.

Three plows, with bits.

One draw-knife.

### IV. — MATERIALS FOR EACH PUPIL.

LESSON I. — Stick of white pine,  $\frac{1}{2}$ " square, 10" long.

Stick of pine or hemlock fire-wood, 2 feet long, 2 inches thick.

LESSON II. — Two pieces of pine, each  $\frac{1}{4}$ "  $\times$  2" — 6", one straight-grained the other crooked.

Piece of pine or hemlock fire-wood, six or eight inches

long, about three inches square, with square ends, without knots.

LESSON III.—Two strips of pine,  $\frac{1}{8}'' \times \frac{1}{4}'' - 3''$ , one cut length-ways of the grain, the other cross-ways.

LESSON IV.—Piece of mill-dressed pine,  $1'' \times 4'' - 12''$ , to try tools on.

Piece of straight-grained clear pine,  $\frac{3}{4}'' \times 6'' - 4' 6''$ , mill-dressed, cut from the end of the board, showing the rough end and the cracks or checks.

LESSON V.—Half dozen  $\frac{1}{2}$  inch dowels, about 4 inches long, with a piece of maple, cherry, or other hardwood,  $1'' \times 3'' - 8''$ , bored with holes of the same size as the dowel.

LESSON IX.—Two dozen four-penny nails.

LESSON XI.—Piece of clear pine, about  $\frac{3}{4}'' \times 6'' - 12''$ , for practice with plane.

LESSON XIII.—Clear pine board,  $\frac{3}{4}'' \times 8'' - 26''$ , for top and bottom of box.

LESSON XIV.—Pine plank,  $1\frac{1}{2}''$  thick, not very straight-grained, to be cut to lengths of  $9''$ , and split to width of  $1\frac{1}{2}''$ , and similar plank of white-wood, furnishing one stick of one kind,  $1\frac{1}{2}'' \times 1\frac{1}{2}'' - 9''$  to each pupil.

LESSON XV.—Two pieces of clear pine,  $4^{\text{cm.}} \times 5^{\text{cm.}} - 15^{\text{cm.}}$

LESSON XVI.—Two pieces of clear white-wood,  $1\frac{1}{2}'' \times 2'' - 8''$ .

LESSON XX.—1 pair brass hinges,  $\frac{1}{2}'' \times 1\frac{1}{2}''$ , with screws. 1 brass hook,  $1''$ , with staple or screw-eye.

LESSON XXI.—Clear pine or white-wood plank,  $1\frac{1}{2}'' \times 12'' - 3' 6''$  for frame.

Ditto  $\frac{1}{2}'' \times 11\frac{1}{2}'' - 16\frac{1}{2}''$  for panel.

LESSON XXIV. — Half sheet sand-paper, number 0.

V. — MATERIALS OF ILLUSTRATION FOR EACH CLASS.

Specimen of fiber of hemp and flax for Lesson III., p. 14.

Piece of round pine or spruce, about six inches long, with bark on, for Lesson III., p. 16.

Small testing-machine (desirable but not indispensable) for Lesson III., p. 18.

Piece or pieces of round timber, about 10 or 12 inches in diameter and 2 feet long, stripped of bark, showing character and direction of cracks (or checks) for Lesson V., p. 31.

Similar pieces cut into boards, which are numbered and tied together, slabs included, in their proper places, for same.

Block of walnut  $5'' \times 3\frac{1}{2}'' - 9''$ , with hole in one end as in description, p. 34, 35.

Nailed box,  $9\frac{1}{2}'' \times 8'' - 12''$ , as figured on p. 38.



## LESSON I.

### Cutting Tools.—Knife and Hatchet.

EVERY cutting tool is a wedge, which is pressed or driven between the particles of the wood, pushing them apart as it advances. You have a stick of white pine half an inch square and about ten inches long. Lay it down on your bench, holding it in your left hand, and try to cut it across with your knife, about an inch from the end. Pressing down on the knife pretty hard, you force the blade in a short distance, pushing the wood right and left, and making a small notch. You soon find, however, that you cannot force the knife forward any farther; the sides of the notch resist the advance of the knife, and stop it when you have pushed it in perhaps an eighth of an inch. If you could remove the wood that presses against the sides of the knife-blade you might be able to drive it farther forward and

#### EXERCISE I.

**Cross-cutting  
with knife.**

cut deeper. You can do this if you proceed a little differently. Begin again on the opposite face of the stick, at the same distance from the end; but this time, instead of pressing squarely against the side of the piece, press obliquely in the direction of the line *ab*, Fig. 1.\*

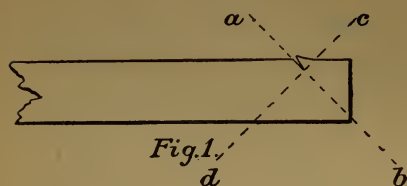

The knife moves forward more easily, because it lifts up the fibers on one side and pushes them

away, bending them as in the figure. Even now, however, the wood ceases to yield after a while, and the blade advances no farther. If you now place your knife just to the right of the former cut and cut down towards the left, in the direction of the line *cd*, you will cut off the ends of the fibers that are bent up, and leave a notch, as in Fig. 2.



\* The crooked lines at the end of the drawing in Figs. 1, 2, 3 mean that the portion of the object to the left of such lines is left out as unnecessary. Similar lines are shown in Figs. 32, 45, and others.

Next place the knife a little to the left of the notch, and cut in the same direction as at first. You will turn up another chip, as in Fig. 3. You easily cut off this chip by cutting in the second direction (*c* *d*, Fig. 1), and can even, at the same time, by making this cut a little to the right, widen and deepen the notch. Repeating these operations, you may cut half-way through the stick.

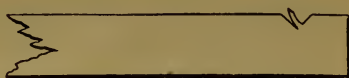
*Fig.3.*

In this exercise, as in every other operation with cutting tools, make it an invariable rule, *never to cut towards your own hand*. Then if your tool slips it may perhaps cut your bench, but *it cannot cut you*. Furthermore, it may be observed here, that in moving about the shop, you should *never carry any cutting tool* in your hand, unless it is absolutely necessary to do so. In such cases it must be carried with extreme care, so as not to wound yourself or any one else. Strict attention to these rules is absolutely necessary.

You have now cut half-way through your

stick. Beginning on the other side, you may now make another cut to meet the first one, thus cutting the stick quite in two. Having done this once, you may cut off another piece an inch long, this time paying particular attention to the following principle. The knife, or any other tool for cutting wood, works best when, instead of pushing directly down on the tool, you at the same time draw it along. This is more important the softer the material is, and is well illustrated in cutting or carving meat, where, if we press on the knife without drawing it along we only bend the fibers instead of cutting them. You will therefore this time, as always hereafter, in using a knife or other cutting tool, particularly on soft wood, try to give it a sliding motion along with the pressure. Bearing this in mind, try now to cut off the second inch of your stick clean and smooth.

After this, cut off a third piece, working this time with the stick firmly held in the left hand instead of resting on the bench. Holding the stick thus you will have a better command of the knife, and will more readily

give it the proper sliding motion; but, unless you are very careful you will run some risk of cutting yourself in making the second or backward cut. If you do not feel safe in making this cut, you may again rest the stick on the bench. To vary the exercise, you may cut the stick from all the four sides successively, leaving it nicely pointed in the form of a square pyramid.

After every exercise try to judge the quality of your work. In this last, for instance, see whether all four of the faces of the pyramid are perfectly smooth and alike, whether they meet exactly in a point, and whether the edges are straight and sharp.

If the piece of wood to be cut were three or four inches thick instead of half an inch, it might be cut off in exactly the same way with the hatchet or ax, which is only a short, heavy knife driven forward by blows instead of pressure, and without the sliding motion just described. With the hatchet or ax, just as with the knife, a blow square across the fibers will make the tool penetrate but a short distance, and to make it cut to any consider-

able depth the blows must be directed right and left alternately, gradually widening the cut, exactly as in the exercise with the knife, leaving the piece beveled or obliquely cut on the end. This is exactly the kind of cut that the woodman makes with his heavy ax in felling a tree, and afterwards in cutting it up into logs. You may try it with a light hatchet on a stick of pine or hemlock firewood, two or three feet long and about two inches thick. Lay it on the chopping-block, holding the end in the left hand. First strike

**EXERCISE 2.** a square blow with the hatchet, observing how little it penetrates. **Cross-cutting with hatchet.** Next strike obliquely, right and left alternately. Be very careful not to strike very hard, nor to let the hatchet glance, lest you cut yourself. When you have cut about half through you may turn the stick over and cut from the other side; but if you do this you must work rather carefully when you have nearly cut through, for if the last stroke, which cuts through, should be delivered too squarely, or with too much force, the end piece would fly up, and might strike you in the face.

---

You have now learned that such cutting tools as the knife and the hatchet are not adapted for cutting square across the grain of wood, though they cut very well obliquely. We shall learn by and by what instrument to use when it is necessary to cut square across the grain.

## LESSON II.

### Knife and Hatchet Continued.

THE knife, the hatchet, and similar tools are used for other purposes besides cross-cutting or chopping: they are used for splitting and for hewing or paring.

You have two pieces of pine  $\frac{1}{4}$  of an inch thick, 2 inches wide, and about 6 inches long, marked *A* and *B*. Try to split from one edge a piece half an inch wide. The pieces have been selected by inspecting the grain of the wood, so that in one case this task shall be easy, and in the other case impossible. Take

**EXERCISE 3.** the piece marked *A*. Set it up  
**Splitting with** endwise on your bench. Place  
**knife.** your knife on the end, about an  
inch from the edge, and press down hard  
with the right hand. You find that the  
knife runs out, cutting off too narrow a piece,  
or runs in, cutting too wide a piece. Take  
the piece marked *B* and try the same experi-



ment, and you find no difficulty in splitting off the piece required. Now, looking at the sides of the pieces, you find that your knife in both cases followed the grain of the wood, indicated by lines that you see on the face if you examine with care. Your experience, then, shows you that when you wish to split wood in a given direction you must pay attention to the grain, and when the grain is not favorable, if you wish to cut along a given line you will have to use some other method than that of splitting. We shall learn, in a few lessons, what this method is, and what tool must be used.

As thin and soft wood is split with the knife, so heavier and harder wood may be split with the hatchet or the ax. Try the hatchet on a piece of fire-wood, about six or eight inches long, taking first a piece of soft wood, such as pine or hemlock, without knots, and with square ends, so that it will stand upright on the block without being held. At first, to get control of the movement of the hatchet, you may strike a light blow, caus-

**EXERCISE 4.****Splitting with  
hatchet.**

ing the hatchet to stick in the wood, and then, lifting hatchet and stick together, strike a harder blow, driving the hatchet through. Afterwards, but not till you are quite sure of your ability to strike just where you wish to, even when hitting hard, you may hold the piece steady with the left hand, snatching the hand away just as you strike with the right. This must be practiced with extreme care, and only by one pupil at a time, and under the eye of the instructor. Last of all, when you are quite sure of your stroke, you may venture to strike with the right hand while holding the piece with the left, but use a pretty large piece, and do not try to split off much at once.

From short pieces and soft wood, such as you have just used, it requires only practice to enable you to work up gradually to longer pieces and harder wood, requiring stronger blows and heavier tools.

Besides cutting across the grain and splitting along the grain, we may *cut* along the grain instead of splitting, for the purpose of trimming the piece down to a given mark.

This operation performed on a small piece with a knife or a chisel, is called paring; on a larger scale, with the hatchet or ax it is hewing. Since, in this case, the cutting is mostly in the direction of the grain, or nearly so, we have to be careful not to let the tool *split* the wood, so as to run inside of the proposed mark.

Take the piece *A* again, which has now a crooked edge, and draw a straight line on the side of it with your lead-pencil, **EXERCISE 5.** about half an inch from the former edge. To prevent the wood from splitting within this mark, the first precaution to be taken is to cut in such a direction that the knife, following the grain, will run outward rather than inward. Thus, if the

**Paring or whittling with knife.**

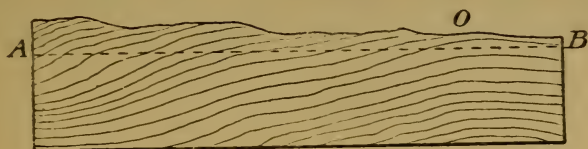

*Fig. 4.*

grain runs as in Fig. 4, in which *A B* is the line to which the piece is to be pared down,

the part from *A* to *O*, must be pared from left to right, and the part from *O* to *B* from right to left. A second precaution that may be observed, particularly when much wood is to be removed, and when the grain is very irregular, or when it is difficult to see which way it runs, is to "score" the edge with several oblique cuts, as in Fig. 5, after which the pieces be-

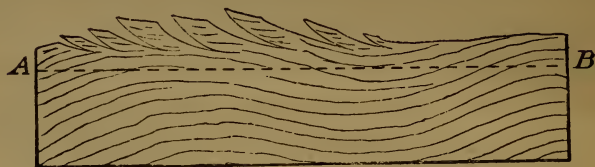

*Fig. 5.*

tween these cuts can be cut off, working in the opposite direction, or from *B* to *A*. New scores are then made and new pieces split off. As soon as you begin to approach the line *A B*, special care must be taken to cut so that the knife shall run out rather than in.

The operation of hewing, with hatchet or ax, is just the same as this. The stick must be turned with alternately one and the other

end up, according to the grain, and when much wood is to be taken off, it must be scored and split as in the last exercise. The operation may be tried on one of the sticks of fire-wood used in Exercise 2. Holding the stick upright on the block with the left hand, turn one of the faces towards the right. Score obliquely into the more prominent parts, and then split them off. When the face has been made pretty nearly plane, smooth it off with light strokes of the hatchet, turning up now one end and now the other, so as to cut with the grain. Examine your work critically to see whether the face you have been working on is straight and smooth.

**EXERCISE 6.****Hewing with  
hatchet.**

### LESSON III.

#### Strength of Wood.

WE have seen, in our previous exercises, that it is much easier to cut and split wood lengthwise than crosswise. We will now look into this matter more closely.

If we examine with a microscope the structure of the trunk of a tree, we find that the wood consists of fibers or threads running lengthwise of the trunk and adhering to each other more or less strongly. In many plants these fibers are longer and more easily separated than in trees, and they are used for twisting into ropes and into threads to be used in weaving. By examining specimens of hemp and of flax, you will learn something of the length and strength of such fibers. In some kinds of wood these fibers adhere so loosely that they can be separated by heat, moisture, and bruising. The fibers of basswood and some others are thus separated, to

be used in making paper. Fig. 6 shows the appearance of the fibers of Scotch Fir, a species of Pine, under the microscope. Now, while these threads have singly considerable strength,



*Fig. 6.*

and still more, of course, when a number of them are taken together, their adhesion to each other is not so great. On the next page

is shown a round pine stick, six inches thick, with the bark on, just as it grows in the tree, and we will cut off some pieces to illustrate what has been said. The stick is cut square across at the ends, and you can see the rings which mark how much the trunk grows each year. First I cut off a cylindrical piece six inches long, Fig. 7. Next, from this, I split off with an ax or a draw-knife some pieces a quarter of an inch thick, beginning at the outside, and splitting wider and wider pieces,

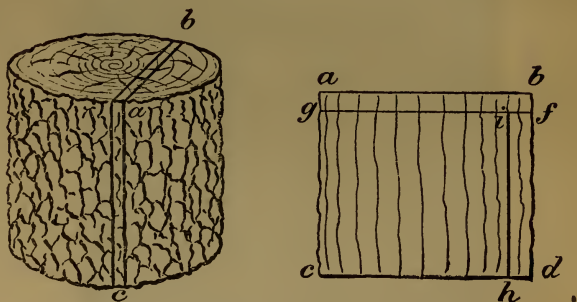

*Fig. 7.*

till I get one four or five inches wide, by splitting along the lines  $a b$ ,  $a c$ . In the piece  $a b d c$  thus cut off you can see the edges of the layers of fibers of which the *ends*



were seen in the cylindrical block, and, comparing carefully the end of the thin board with the face, you see that these edges constitute the "grain" of the wood, and can also see why they are closer together near the edge of the board and farther apart near the middle, or why the board is fine-grained near the edge and coarse-grained at the middle.

I will now cut off from  $a b d c$  a strip  $a b f g$ , half an inch wide, with a fine saw. In this strip, which I will mark  $A$ , the grain runs crosswise. Next, with a knife or hatchet, I will split off another strip,  $f d h i$ , also half an inch wide, in which the grain runs lengthwise, and which I will mark  $B$ . Now taking the first piece by the ends and pulling it, I can break it in two; but no pull that I can give is strong enough to break the other. (I am careful not to bend either of the sticks, because I want to consider now only the question of breaking by a direct pull; breaking by bending is something more complicated, and cannot be considered till later.) I hand you all now a number of such strips, of both kinds, and you readily satisfy yourselves that

it is much easier to separate the fibers from each other than to break them.

After we have thus found out that wood is stronger lengthwise than crosswise, we may go a step further, and inquire *how much* stronger. We may put one of the pieces of each kind in a small "testing-machine," and apply an increasing force to it till it breaks. With such a machine we find that the piece *A* is broken by a pull of 65 pounds, while it takes 700 pounds to break *B*, and, as the two pieces are of the same size, we conclude that this kind of wood is about eleven times as strong lengthwise as it is crosswise. The operation of "testing," and the machine used for the purpose, are of the greatest importance. The architect and the engineer make use of powerful machines, in which large bars and columns can be strained till they break, and the breaking force measured. At the proper time you will find no difficulty in understanding these larger machines and operations, if you have understood the smaller ones. In the machine shown in Fig. 8, the piece to be broken is held by the clamps *A* and *B*. The wheel *C*

being turned the screw *D* is drawn down, which raises the other end, *E*, of the lever, *E F*, and stretches the piece till it breaks. The index, *G*, on the spring-balance shows how great is the force applied at *F*; and the

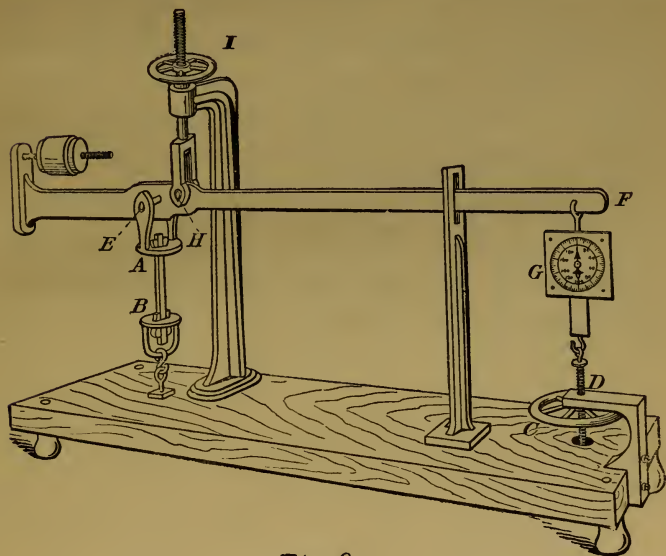

*Fig 8*

force applied at *E* is as many times greater than this as the length of *H F* is greater than that of *E H*. As the piece stretches before breaking, the pull is applied at first by means of the screw *I*, and afterwards by *C*.

Our experiments with these pieces of wood agree with our observations on the action of cutting-tools. The knife and the hatchet, when cutting square across the fibers, penetrate but a short distance, unless a very great force is applied, but when cutting between the fibers they are much more easily pressed forward. With such tools, therefore, we were obliged to cut lengthwise or obliquely, and found it nearly impossible to cut a thick piece square across. If we wish to do this we must use another tool. The tool specially designed for this work is the cross-cut-saw, which we will study in our next lesson.

## LESSON IV.

### The Cross-cut-saw.

**E**XAMINE your saw carefully. You find that it consists of a number of triangular teeth, each of which acts as a sort of knife. Count the number of teeth to the inch. You will find this different in saws that are intended for different purposes. The one that you have is a "cross-cut" saw for moderately soft wood. If you now examine one of these teeth, you will find that it is pointed, and the front edge is sharp. It would be a useful exercise, and would help you to understand the mode of action of the saw, if you would cut out with your knife from a piece of thin wood (say  $\frac{1}{8}$  of an inch thick) a model of half a dozen teeth of each of your various saws as you become acquainted with them. When you push the saw across the grain, each of these teeth makes a cut across the fibers, just such as you can make by hold-

ing your knife upright and drawing it across the grain. Next, examining the successive teeth, you find the alternate ones sharpened in different ways. While one has its sharp edge towards the left, the next has its edge towards the right. Thus the two sets of teeth make two different cuts across the grain, and these cuts are at a distance apart equal to the thickness of the saw, or a little more, inasmuch as the teeth are spread apart, or "set." All this you will easily make out if you study attentively the saw itself, and not merely this description.

Now, try to make with your knife just such a cut across the grain as one of these teeth makes. You have a piece of waste wood which you will keep by you for this and similar experiments. Hold your knife upright on the piece and draw it along, across the grain. You find, as you have found before, that you cannot cut very deep, because the wood at the side of the knife is not removed, and thus the cut is not wide enough to let the knife enter; but with the saw it is different. When one knife or tooth has made its cut, the next

knife not only makes another cut very near and parallel to the first, but it also tears off the little piece of wood between the cuts. The third tooth, therefore, is able to cut a little deeper, and the fourth tooth tears off a little more, and so on. Thus the saw makes a clean cut with parallel sides, and wastes only a small amount of wood.

We can now go on to the use of the cross-cut saw. On your bench is a piece of pine board about 4 feet 6 inches long, 6 inches wide, and  $\frac{3}{4}$  of an inch thick. (Hereafter we will indicate dimensions like this in the following way:  $6'' \times \frac{3}{4}'' - 4' 6''$ , which will be read, "Six inches by three-quarters of an inch, by four feet six inches). The board is what is called "mill-dressed," that is, the roughness that is always found on boards that have been sawn from the log has been planed off by a planing-machine, leaving a tolerably smooth surface. The piece on your bench has been cut from the end of the board, and you will very likely observe that in the first place it is not square on the end, and in the next place that it is cracked or "checked" at the end. The first

is owing to the fact that the log was cut with the ax, as already explained. In many cases the logs are cross-cut with a saw, and then the ends of the boards are square. The cracks or "checks" we will explain in our next lesson.

Now lay the board on the bench, with the checked end to the right, and we will proceed to first mark it square, and then cut it square. For the first purpose we will use the try-square. Place the edge of the wooden part of the square against the edge of the board, letting the steel blade lie flat on the board and square across it. Then, using the edge of the blade as a ruler, draw a pencil-mark; this will run square across the board. You must be careful in drawing this line not to vary the inclination of your pencil, or you will make a line which is not parallel to the edge of the square, and therefore not perpendicular to the edge of the board. Draw such a line just far enough from the imperfect end to leave out all the worst checks. We will then cut off with the saw the imperfect piece thus marked.

There are several ways in which the board



may be held while we are making this cut. For this exercise you may hold it in the bench-vise. Observe how the vise works. Open it to the width of your board, lay the board in it, with the imperfect end to the left and the marked face up, and screw the vise up so as to hold the board firmly, the marked piece projecting beyond the end of the bench.

**EXERCISE 7.****Cross-cutting  
with saw.**

Take the saw in your right hand. (If you are left-handed you will do well, nevertheless, to learn to work with the right hand, or, better still, to work equally well with both hands. It is sometimes a great advantage to be able to use either hand; and there are some things which can only be done with the right.) Set the saw to the left of the mark, just so far that when you cut you will cut exactly up to the mark, but not beyond it. Rest the fingers of the left hand on the wood outside of the mark, holding the thumb up for a guide to steady the saw. Draw the saw backward, letting it rest very lightly on the wood, till you have made sure that the cut will be in the right place; then push it forward, still

bearing lightly on the wood. Having started the cut thus with a few gentle strokes, continue it with long strokes, the full length of the saw. Avoid short, jerky strokes. Draw the saw back at each stroke till the hand nearly touches the shoulder, and push it forward till the handle nearly reaches the board. A long, steady stroke cuts smoother as well as faster, is a more agreeable movement, and affords a pleasant exercise.

Be careful not to bear too hard on the saw; if you do, you will bend the saw, and it will make a crooked cut. While working, watch the saw, to see that you keep it perpendicular to the surface of the board. When the cut is nearly finished bear still more lightly, and work with gentler strokes, at the same time holding up with the left hand the piece that you are cutting off, to prevent splintering when the saw comes through.

Having cut off one piece under the supervision of your instructor, you may mark and cut off two or three more, each exactly an inch wide, till you find you can make a smooth and square cut. If you need more

---

practice you must use a piece of waste wood for the purpose, not reducing the length of your board to less than 45". The squareness of the cut should be tested by applying the try-square, with the wooden part first against the edge of the board, and then against the face. The former test will show whether you have cut square *across* the board, and the latter whether you have cut square *through*.

## LESSON V.

### Shrinking, Checking, and Warping of Timber.

WE have already observed that our board was cracked at the end. We can understand this if we consider what happens to timber after it is cut down. While the tree is growing its pores are full of sap, which is mostly water. After the tree is cut, the sap begins to evaporate, and the wood shrinks. You will have no difficulty in finding, all around you, proofs of this shrinking. Flooring-boards, panels of doors, bottoms of drawers, which fit well when first put in place, all leave openings after a while by shrinking. Here are several "dowels," which were all cut from the same stick, and yesterday they all fitted well in the corresponding holes; but half of them have been soaked in water over night, and now they will not go into the holes at all.

The shrinking of timber, you will find,

---

takes place only in the width, not in the length. Examine the floor, and you will find that it is only the joints between the edges of the boards that have opened. When two boards have been put together end to end, the joint is as close as in the beginning. This fact is very striking, and should be remembered. The shrinking of wood causes endless trouble in carpentry, cabinet-work, and building, and it cannot be entirely prevented; but, by taking advantage of the fact just mentioned, it can often be prevented from doing mischief. We shall study some of these methods in Lesson 21.

When the drying of timber goes on at all parts with equal rapidity, the piece shrinks equally in all parts, and keeps its shape; but in large pieces the drying goes on more rapidly on the outside than on the inside, and this causes important changes in the shape and condition of the wood. We shall look at these changes in detail by and by, but for the present it will be sufficient to note the following facts.

First, as the outside shrinks faster than the

inside, cracks are formed, which begin on the outside and gradually extend inward. These cracks are largest and most numerous at the ends of the log, where the drying is most rapid, and they are the cracks which we have already noticed in our boards.

Secondly, when timber has been cut up, if by any means one side of a piece is prevented from drying as fast as another, the side which dries most rapidly, and therefore shrinks most rapidly, becomes hollow, or the piece "warps." Or, if one side of a piece of wood which has been dried or "seasoned" is exposed to moisture, that side swells and becomes convex, and again the piece warps. Verify these statements by experiment, laying several pieces of board six or eight inches wide and of about the same length on the ground for some hours, or even on your bench if they have not been very well seasoned, setting up others on their edge so that both sides may be equally exposed to the air, and noting carefully the results after several hours. In the same manner, if wood has been already warped, it may be straightened by exposing it in the proper way.

---

(Samples of round timber stripped of the bark should be exhibited, showing the checks on the surface, and particularly at the ends, as well as one sample of a short log, cut up into boards, showing the cracks in the *ends*, and the *edges* of the boards, and in the *faces* of the outside boards or "slabs." The pupils should be made to observe for themselves the position and direction of these cracks in boards cut from different parts of the log. They should be made to observe how checking and warping continue after wood has been made up, if it is exposed, and how they are prevented by painting or varnishing).

## LESSON VI.

### Working Sketches.

IT is proposed to make a box from the piece of board used in your seventh exercise. The box is to be made, not of any size and shape that you may happen to give it, but exactly according to given dimensions. This is extremely important, for, when an object is wanted for a given purpose, it is often worthless if not of just the right size and shape.

The shape and dimensions of this box, as of any other piece of work, can be shown in a working drawing or a working sketch. The former name is given to a drawing carefully made "to scale," and the latter to a drawing made with less care, and which may be drawn freehand, and only approximately to scale. In the latter case the dimensions are marked on the corresponding parts of the drawing, and can be read off; in the former they are ascertained by measuring carefully the dimen-



sions of the drawing, and making the proper allowance for the "scale," as will be understood presently.

Here is a block of wood, of which we will make a sketch first and a drawing afterwards. Measuring the block with the rule, we find it is 9 inches long, 5 inches wide, and  $3\frac{1}{2}$  inches thick, or as we have agreed to represent it,  $5'' \times 3\frac{1}{2}'' - 9''$ . If we look directly at the front of the block, we see a rectangle  $9'' \times 3\frac{1}{2}''$ , which we indicate by drawing, freehand, a rectangle whose long side is nearly three times as great as its short side, and writing on these sides their dimensions, as in Fig. 9.

This figure we call the Elevation, or the Front Elevation. If we look straight down on the

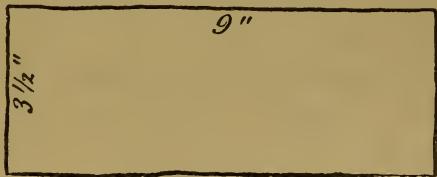
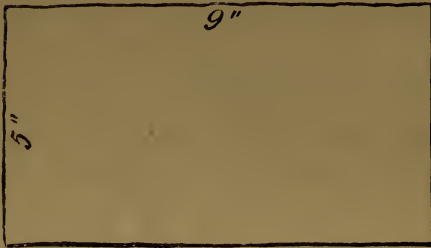

*Fig. 9.*

block, we see a rectangle  $9'' \times 5''$ . This we represent in a similar way, Fig. 10, and call the representation the Plan.

From these two, even if we had never seen

the block, we should be able to form a correct picture in the mind of its size and shape,



*Fig. 10.*

and a workman would be able to make one just like it. Sometimes, however, there are details in the figure of the object

which these two drawings fail to show. Thus, if there were a round hole in the right-hand end, neither of these would show it. In such case a third figure is added, called the End Elevation. This is the view that we get if we look directly at the end of the object: in the case of this block it would be another rectangle,  $3\frac{1}{2}'' \times 5''$ , Fig. 11. If we wish to show the hole, we must ascertain exactly its size and position, and show them properly in the drawing. If the hole is 1" in diameter, and

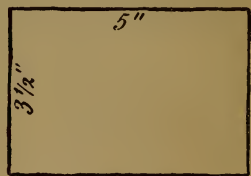

*Fig. 11.*

placed 3'' from one of the narrow faces and 1'' from one of the wide faces, we indicate this as in Fig. 12, making the drawing perhaps a little larger than before, so as to be able to write all the necessary dimensions. This, however, does not show how deep the hole is. Suppose we find it to be 2'' deep.

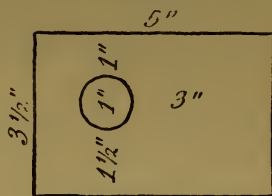

Fig. 12,

Looking at the front of the block again, you will understand that, if we could look into the block, the hole would appear as at *a b*, Fig. 13. As the lines at *a b* are, however, hidden

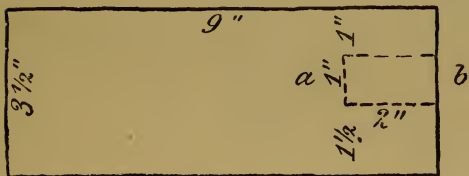

Fig. 13.

by the material of the block, we will indicate them by dotted lines. In

the same manner the hole may be shown in the plan. The three figures being now brought together as in Fig. 14, they give complete information as to the size and shape

of the block. This group of drawings thus marked, with the dimensions of all the parts, we will call a "Figured Sketch" or "Working Sketch." It is not necessary that the lines be ruled, provided they are drawn toler-

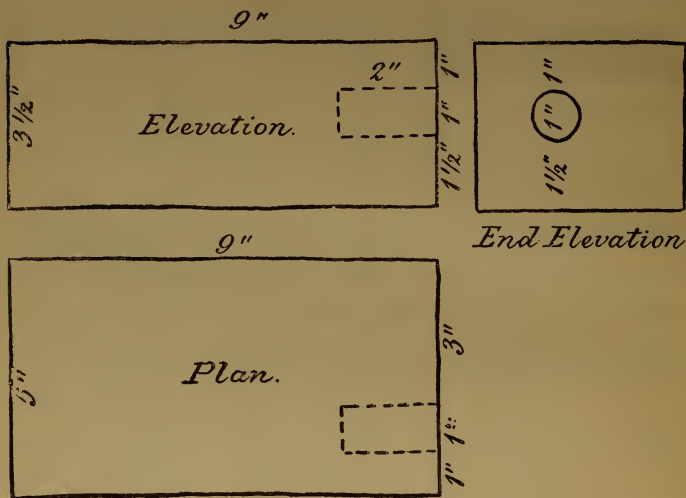

Fig.14.

ably straight, and it is not necessary that they be exactly in true proportion to each other, though it is best to have them nearly so. Every dimension must be given in at least one of the drawings. If, for instance, the fig-

---

ure 3'' in the plan were left out, the workman who should try to make the block from this sketch would not know where to bore the hole, unless this figure were given in the End Elevation. A dimension, however, which is given in one drawing need not be repeated in another. Thus the figure 9'' in the Elevation need not be repeated in the Plan, though the repetition does no harm, unless the figures are too crowded.

Having made figured sketches of the block, you may now, for exercise, make similar sketches of a large nail or spike, a bolt with a nut, a six-sided lead-pencil, a try-square, or other simple object. In our next lesson we will undertake a working drawing.

## LESSON VII.

### Working Drawings.

IF, instead of drawing the lines of our last lesson freehand, and writing the dimensions of the object on the drawing, we rule the lines with care, and make them all bear exactly the same ratio to the lines they repre-

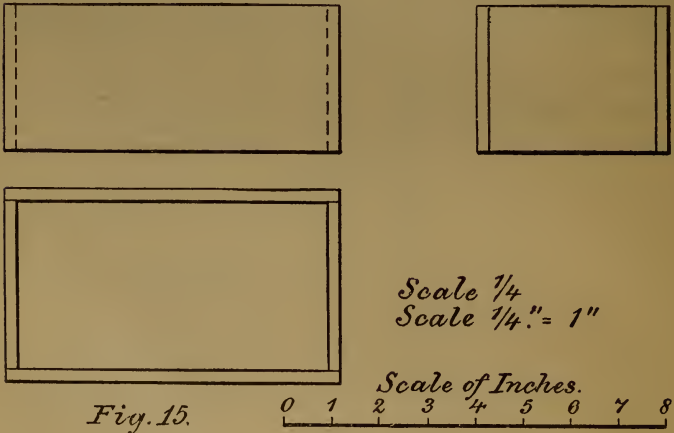

*Fig. 15.*

sent, we have a "Drawing to Scale," or "Working Drawing," as in Fig. 15, which

shows the plan, elevation, and side-elevation of a box.

The scale, or ratio of the dimensions in the drawing to the corresponding dimensions of the object must be indicated on the drawing. This may be done in either of three ways. Suppose, for instance, the lines of the drawing to be one quarter as long as the corresponding lines of the object. First, we may write on the drawing "Scale  $\frac{1}{4}$ ". Or, secondly, we may write "Scale  $\frac{1}{4}'' = 1''$ ", or "Scale  $3'' = 1'$ ". Or thirdly, we may draw a straight line of any convenient length, divide it into parts, of which each represents one inch on the object (or one foot, or one meter), and number these parts 1, 2, 3, etc. In the case in question where the scale is  $\frac{1}{4}$ , each of the parts must be actually one quarter of an inch long. If the drawing had been made to a smaller scale, as  $\frac{1}{12}$  for instance, which might be written "Scale  $\frac{1}{12}$ ", or " $1'' = 12''$ ", or " $1'' = 1'$ " the spaces would have been each one inch long, and would have represented each one foot in the object. In Fig. 15 all three of the modes of representing the scale are shown,

The scale must be large enough to enable the workman to determine from the drawing the dimensions of every part of the object. Thus, in the last figure, to determine the size of the hole in the block, the workman would measure with the compasses its diameter on the drawing. Finding this to be one quarter of an inch, he would know that the diameter of the hole was to be one inch. Next, to determine where to place the hole, he would measure the distances on the drawing from two sides of the end elevation, and finding these distances to be each one quarter of an inch, he would know that the hole was to be one inch from each of the corresponding faces of the block, and therefore the *center* of the hole one inch and a half from each of these faces. If the scale had been much smaller, say  $\frac{1}{1\frac{1}{2}}'' = 1''$ , it would have been difficult to measure exactly the dimensions on the drawing, and therefore difficult to determine exactly the dimensions of the object.

When an object is large, or contains many details, it may be impossible to make the scale large enough to show all the details in



such a way that the workman can get their true dimensions from the drawing. It is then necessary to add separate drawings of some of the details. These are only working drawings on a larger scale. Of course the scale of these drawings must be indicated also.

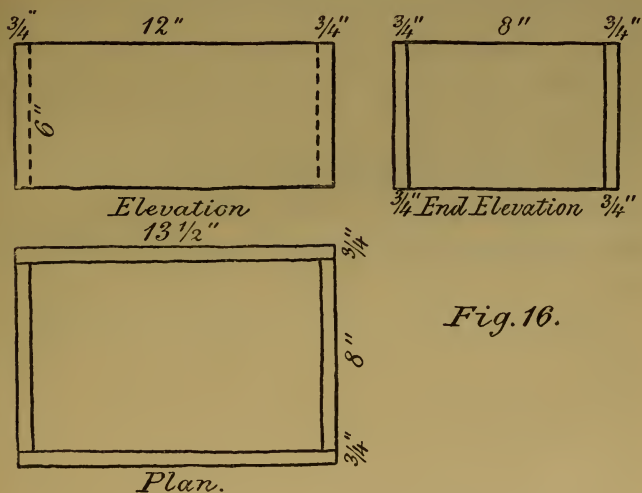
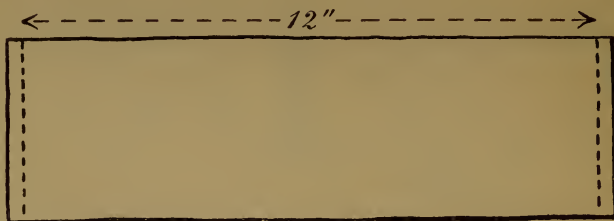

*Fig. 16.*

In addition to the two elevations, plan, and drawings of details, there are sometimes needed other drawings, called "sections," which will be explained hereafter, when they come to be needed.

You will now be able to understand the

working sketch, Fig. 16, of the box which we propose to make. The front elevation shows that the box is  $13\frac{1}{2}$ " long and 6" high, and the end elevation, or the plan, shows that it is  $9\frac{1}{2}$ " wide. The dotted lines in the front elevation show that the front and back pieces are fastened on over the ends of the end pieces. The same fact may be learned from an inspection of the end elevation and plan. The figure  $\frac{3}{4}$ " shows that the wood used is  $\frac{3}{4}$ " thick. As there may be a doubt whether the figures 12" and 8" in the two elevations are the inside or the outside measurements of



*Fig. 17.*

the box, it is best to remove this ambiguity in the following way. Let the figure which indicates any dimension be written in the middle of a line drawn parallel to the line

to which it belongs, and terminated by arrow-heads exactly opposite the ends of the line. Thus, Fig. 17, means that the inside length of the box is 12 inches, and Fig. 18, means

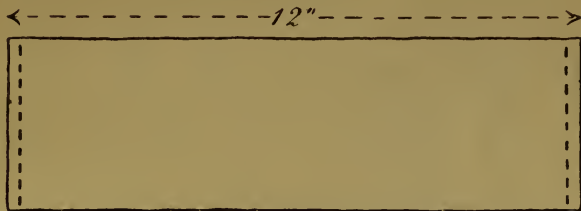

*Fig. 18.*

that the outside length is 12 inches. In a working *drawing* there would be no such ambiguity as this.

## LESSON VIII.

Making a Nailed Box.—Laying out the Work.

TAKING dimensions from Fig. 16, we see that we shall need for our box two pieces of  $\frac{3}{4}$  inch stuff  $6'' \times 8''$  for the ends, and two pieces  $6'' \times 13\frac{1}{2}''$  for the front and back. Later we shall need two pieces each  $9\frac{1}{2}'' \times 13\frac{1}{2}''$  for the top and bottom, but for the present we will leave them out of consideration, to simplify the drawings and the laying out of our work.

Take the piece of board used in Lesson IV. If the work of that lesson was well done, the piece is now square on one end, and a little longer than is necessary for the four pieces. Furthermore, if it has been properly exposed to the air, it has dried well without warping.

If it is not square on one end, make it so with the least possible waste of material, remembering that, if you get it less than about 44 inches long it will be spoiled. 44

Now, with your rule, lay off 8 inches from the squared end, *along the best edge* of the board. Mark this edge with your lead-pencil, with a cross or other mark, to distinguish it as the edge from which you will work. Place the wooden handle of your square against this edge, and draw a pencil-mark square across the board, exactly 8 inches from the squared end. You have now marked off one of the ends of the box, and might proceed to cut it off; but it is best to perform all operations of one kind at once, and we will therefore "lay out" all the pieces before commencing to cut them off.

If you should draw another pencil-line just 8 inches from the first, and then proceed to cut out the pieces, they would turn out too short by the amount of the thickness of the saw; and though in comparison with some dimensions this thickness is very small, in comparison with some others it is very considerable, and it should, therefore, never be neglected. Allowance must always be made for the "waste" of a saw in cutting to a mark. As

**EXERCISE 8.**

**Laying out a  
box.**

you do not know yet how much this waste is, you may, after having marked off your first piece 8 inches long, begin a cut with the saw just outside of the mark, but quite close to it, so as to leave the piece exactly 8 inches long.

**EXERCISE 9.** As soon as you have cut a little

**Cross-cutting  
with saw.**

way into the piece, say an inch, make another mark with pencil and square, parallel to the first, and so near to it that the two marks just contain the cut between them, and no more, as in Fig. 19.



*Fig. 19.*

From these you can learn, by measuring the distance between them,

or by observing carefully and remembering, how much the saw wastes. You will soon be able to make the proper allowance for this waste by the eye without measuring.

Now lay off 8 inches from the second mark, draw a third mark and a fourth parallel to it for the waste. Then lay off  $13\frac{1}{2}$  inches, mark off the waste again, lay off  $13\frac{1}{2}$  inches again and mark off the waste again, and

the work is completely laid out. Your piece of wood will now be marked as in Fig. 20, in which 1 and 2 are the ends, 3 and 4 are the front and back, and 5 is the waste.

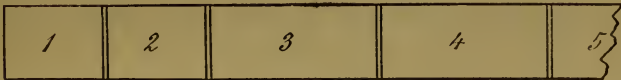

*Fig. 20.*

After this lesson you will not make double marks for your saw-cuts, but will make the necessary allowance for the waste by the eye.

In making pencil-marks, as in this exercise you must be careful to apply the square always to the same edge of your board, distinguishing this edge, as already pointed out, by a cross or other mark. Indeed, this is an important principle in all laying out of work. The reason of it is that, unless the opposite edges are parallel, lines drawn perpendicular to them with the square will not be parallel; but lines drawn perpendicular to the same edge, provided that edge is straight, will always be parallel. Try this

with your waste-piece, whose opposite sides are not quite parallel, drawing your two perpendiculars pretty close together.

In laying out your work you must see that each piece is, if possible, free from knots and cracks, particularly at the ends, where the nails will have to be driven. If there should be a knot at any one of these places, at the boundary between 3 and 4 for instance, you must try to throw the knot out, by shifting 4 to the right, and making the waste piece fall in the middle, where the knot is.

Now place the board in the *vise*, as in Exercise 7, and cut off the four pieces, being very careful to keep the saw between the double marks, to cut square, and to go gently towards the end of the cut, so as to avoid splintering. When the four pieces are cut off they should be compared with each other two and two, measured, and tested with the square.



## LESSON IX.

Hammer and Nails. — Putting a Box Together.

**I**N using the hammer, the first thing to learn is to swing it with a free movement of the arm from the elbow rather than from the wrist, and the second is to strike squarely with the whole face of the hammer rather than with one edge. Begin by striking a moderately hard blow on your piece of waste wood, in one corner of the piece. Examine the mark made. You will probably find it deeper on one side than on the other, showing that you have not struck squarely. Strike again, by the side of the first mark, and examine the result, and so on, over the whole face of your piece of wood, or until you can strike hard and square.

**EXERCISE 10.**

**Striking with  
hammer.**

Take a dozen four-penny nails and examine them. (Note that "four-penny" probably

meant, originally, weighing four pounds to the hundred, and thus four-penny, six-penny, etc. give some indication of the size of the nails.) Observe that the nails have two sides parallel, as shown in the side-elevation, Fig. 21, *b*,

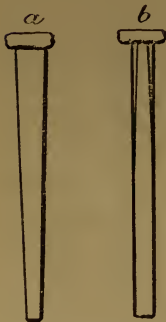

*Fig. 21.*

while the other two sides, as shown in *a*, act as a wedge, and will split the wood if it is weak. The wedge, therefore, must be made to act in the direction in which the wood is strongest, that is, as we learned in Lesson III., in the direction of the length of the fibers.

Now, holding a nail between the fingers and thumb of the left hand, in the proper position to enter the wood without splitting, drive it into your piece of waste wood  $\frac{3}{8}$ " from the end, till the point

**EXERCISE II.** just shows through on the other side. Now draw it out with **Driving and drawing a nail.** the claw of the hammer. To do this place a block of wood under the head of the hammer to lift it up to the height of the head of the nail; catch the head

of the nail with the claw, and while the hammer rests on the block with the handle up, swing the end of the handle over so as to raise the claw, and the nail will come out. If the block is not used to raise the hammer, the nail will be bent. Drive the nail in the same way and draw it several times, always  $\frac{3}{8}$ " from the end of the piece, but always in the first position, or so as not to split the piece. Afterwards, drive it several times in the second position, at the same distance from the end, and observe that you will nearly always split the piece. Note well these two positions. Observe that you can distinguish the one from the other by the shape of the head or by the way the nail feels between the fingers, and you should never hereafter split a piece of wood by carelessly driving a nail in the wrong way.

Now, taking the long sides of your box, draw a light pencil-mark across each end,  $\frac{3}{8}$ " from the edge, and make on this **EXERCISE 12.** line two dots, each an inch from **Nailing a box.** the end of the line, and a third half-way between them, for the places where the nails

are to be driven, as in Fig. 22. Drive six nails nearly through at these places. Then, setting one of the short sides upright in the vise, lay the end of the long piece on it, exactly



*Fig. 22.*

as it is to go when the box is put together, being careful, while

holding the long piece in the left hand, to let the fore-finger reach round the edge, so as to feel whether the edge of the upper piece and the face of the lower piece are exactly even. Drive the middle nail through into the end piece, but do not drive its head quite down. This will now hold the piece firmly enough, while allowing you to adjust it and drive the other two nails down to the same distance. The heads of the nails are left projecting a little, so that it may be easy to draw them if necessary. The second corner may be nailed in the same way, and the six nails driven "home," that is, till the heads are even with the surface of the wood, taking care not to bruise the wood with the

---

hammer. For the third and fourth corners lay the nailed piece down on the bench, with the short pieces standing up, lay the fourth side in place, holding it as you did the first, and drive the other nails with the same precautions as before.

If the pieces have been properly cut and properly nailed, the box will now be square at all its corners, the diagonals will be of equal lengths, and when it is set on the bench all the corners will rest on the bench and the sides will be perpendicular to it. You should test your work as to these particulars with rule and square.

## LESSON X.

The same Continued.

THERE will now no doubt be two classes of boxes in the class, as the result of the last exercise. The first will be smaller or larger than they were intended to be, or they will be not quite square at the corners, or they will be "winding," that is, when set on a flat surface like that of the bench they will touch at three corners only. The second will be true to dimensions and shape, and will be "out of winding."

The test for "winding" is important, and may be made in several ways. We cannot always depend on the test by laying on the bench as already described, since the bench itself may be in winding, or the object may be too large to be tested in this way, or too small to show the defect. A second, and more common way of testing an object of moderate size, such as one of your boxes, is

to hold it up before one eye, keeping the other closed, and look across one of the edges at the other edge. If the front edge exactly covers the hind edge, there is no winding; but if one end of the hind edge stands up above the front edge when the other end is exactly covered, the object is winding. When the object is very small it is sometimes hard to detect the fault in this way. In this case the error may be exaggerated and made perceptible by means of "winding sticks." These are two "straight edges" or strips of wood with **EXERCISE 13.** straight *and parallel* edges. **Test for winding.** Suppose two such strips, say  $2'' \times \frac{1}{2}'' - 24$ ; to be laid across your box at opposite ends. If the winding be too small to be noticed when you look across the box itself, you may yet be able to detect it when it is exaggerated by these long sticks. In this way, even the winding in the edge of a board may be detected.

This and the other tests being applied, we will suppose your boxes divided into two classes, as already described. Those of the

second class, being perfect, or nearly so, we might finish up, by furnishing them with bottoms of the same material, fastened, like the sides, with nails. These boxes, being all of the same size, might be piled up in a set or "nest," and used for the stowing of nails, screws, glue, and other materials used in the shop. Instead of doing this, however, we will take the boxes of both classes apart, and use the material in making another set of boxes of better finish than these, and requiring the use of other tools and more practiced hands.

To knock your box apart without splitting it, hold it by one of the long sides and

**EXERCISE 14.** strike the other long side, inside

**Taking apart** of the corner, with a hammer.

**nailed work.** Do not strike directly on the

wood, in which case you will probably split it, and certainly bruise it, but on a strip laid in the corner to receive the blow. If there is not room to strike with the face of the hammer, strike with the side. Striking in one corner and the other alternately, you will probably separate the box at two corners, and



---

so take off one of the long sides, after which, holding the short sides and repeating the operation with the same care as before, you will take off the other side. Drive out the nails by striking them on the points, and straighten them by striking them gently with the hammer on the convex side while holding them on a block of wood,—not on the bench, as you would thus mar the bench.

For the new box that we propose to make, we will reduce a little the thickness of our pieces of wood, and give them a finer surface than the mill-dressed surface that they received from the planing-machine. Your exercises with the hatchet and the knife have shown you the difficulty, if not the impossibility, of finishing a piece smooth with either of these tools. You will be ready, therefore, to appreciate the value of the plane.

## LESSON XI.

### The Jack-Plane.

YOU have seen how the knife or the hatchet tends to follow the grain of the wood, and, if the grain happens to run inward rather than outward, splits off large pieces, thus making fine work impossible. The knife or "iron" of the plane is prevented from doing this, and so, with this tool, work may be finished up very smooth. The plane-iron, as you see, is set in a block of wood through which it projects only a short distance, and as the block rests on the surface of the wood, the iron cannot penetrate beyond this distance. If you set the plane down on the surface of a board, and press down on it, the iron will cut into the wood until the block comes in contact with the board, and then it can go no further. If now we push the plane forward, the edge of the iron moves say from *a* to *b*, Fig. 23; but, instead of following

the grain, and cutting deeper and deeper, it is forced to remain at the same distance below the surface. It thus lifts up the thin layer or "shaving," bending it upwards as it

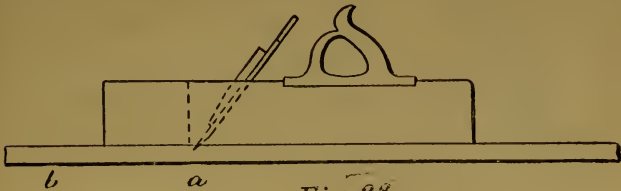

*Fig. 23.*

advances, and delivering it out of the "mouth" of the plane. The tool thus described is the plane with a single iron.

When we use this tool, however, although the iron itself cannot penetrate far into the wood, it is still possible that, while the end of the shaving slides up the surface of the iron, the split, once commenced, may run some distance into the wood. In this case, the strong splinter torn up may stop the plane, or, breaking off, may leave a rough surface. To prevent this a second iron or "cap" is introduced, thus making the plane with double iron. The cap is secured to

the cutting iron by a screw as in Fig. 24, and the two are put together into the block,

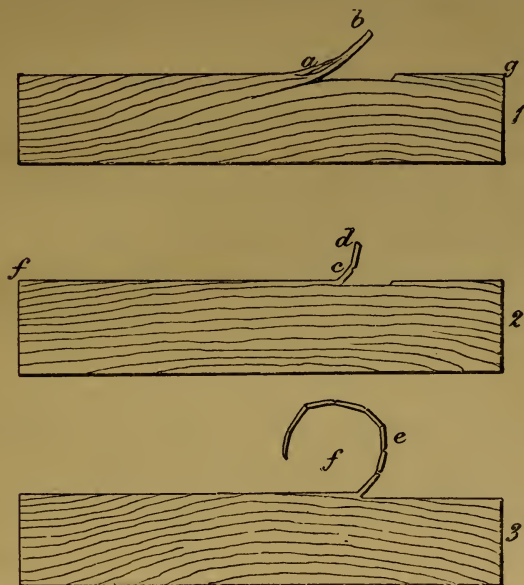

*Fig. 24.*

and held in place by a wedge, as you will readily understand on examining the plane on your bench. Figures 23 and 24 should be carefully compared with your plane, by way of further illustration of the principles of mechanical drawing explained in Lesson VI.

With this instrument it is impossible for the end of the shaving to slide far up the iron, and cause a deep split in the wood, because the shaving is caught by the back iron or cap and bent forward. If the cap is thick enough, and set near enough to the edge of the cutting-iron, it will bend the shaving so abruptly as to break it. As long as the shaving was a strong stick or splinter, as at *a b*, Fig. 25, the forward movement of the cutting-iron tended to lift this stick up without breaking it, and extend the split

down into the wood; but when the end of the splinter is turned up and broken off, as at *c d*, the cutting-iron cuts partly through the base of the remaining short piece, turning



*Fig. 25.*

up a longer splinter, which is again broken off, and so on, till the splinter curls up as a thin "shaving," as at *e f*.

When you examine one of the thin shav-

ings taken off by such a plane, you find that it is cracked or broken across at equal short distances. Thus it is so much weakened that the cutting-iron cannot lift it up by the end and continue the split down into the wood.

With this partial view of the mode of action of the plane we can now go on to consider the way of using it. The discussion of the several kinds of planes, and of the methods of sharpening them and of adjusting them for different kinds of work, will come later.

For your first exercise in planing, the tool called a "jack-plane" will be used. It is designed for coarse work, such as removing the rough outside of a plank, or cutting off considerable quantities of material. As it is intended to cut pretty thick shavings, the cap is set well back from the edge of the cutting-iron ( $\frac{1}{8}$ " to  $\frac{3}{16}$ "), the cutting-iron is allowed to project considerably from the block, and its edge is curved, as you will notice, so that the middle of it projects farther, and therefore cuts deeper than the corners. Your jack-plane has been already

---

sharpened and adjusted for the kind of work you are going to do. It is intended to plane up the sides of your box ; but it will be well, before undertaking this, to try your hand on another piece of wood of about the same size. To make the exercise as simple as possible, pick out a piece which is not winding.

You find at the left end of your bench a stop or "bench-hook," to prevent the piece that you are planing from sliding forward. Examine the construction of this bench-hook. Observe how it is raised and lowered, and fastened in any desired position. Set it so that it shall stand up above your bench a little less than the thickness of the piece that you are going to plane. If your bench has a wooden "bench-pin" instead of the bench-hook the mode of adjusting this is obvious. Lay your piece of wood on the bench, with the end against the bench-hook. Hold the plane by the handle with the right hand. Take hold of the front of the plane with the left hand, the thumb being on the side nearest your body, and the fingers on the other side. This throws the

left elbow up, and enables you to press down on the front of the plane. It is not, however, generally necessary to press down very hard: if the plane is sharp and properly adjusted

**EXERCISE 15.** it will take hold without this,

**Use of the Jack-plane.** just as the saw does. In this position, push the plane forward from end to end of the piece, trying to take off a shaving the whole length. If the first shaving is taken from the left-hand edge, let the next be just to the right of this, and so on, till you have gone over the entire breadth of the piece, not missing any portion of the surface. You will of course have to change the position of the piece from time to time, so that the portion on which the plane is working shall be opposite the bench-hook.

In the management of the jack-plane the chief points to be attended to are these:

1. During the first part of the stroke press down most with the left hand, to prevent the rear end of the plane from dropping, and so cutting off too much of the rear end of the piece.

2. In the same manner, bear down, during



the last part of the stroke, on the handle of the plane, to prevent the front from falling. If these two points be neglected, the piece will present, when planed, the appearance

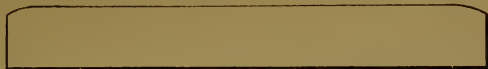

*Fig. 26.*

shown in Fig. 26: a straight-edge laid upon the surface will not touch at the ends.

3. Do not continue to plane any particular spot merely because it happens to work easily: you will thus get the surface uneven, and be obliged, after all, to plane away the rest of the piece to the same level with the soft part on which you have been working.

4. Do not, as a general rule, work "against the grain," that is, in such a direction as from *a* to *g*, Fig. 25, or from *c* to *f* in the same figure. When you work thus, each fiber is torn some little distance down into the wood before it is cut off, and the result is a number of small shallow pits, deeper at one end than at the other, leaving the surface rough, as in Fig. 27, in which the appearance

is exaggerated, to show the character of the effect. Planing with the grain, the tool, as it cuts off each fiber and bends it up, makes a split which runs outward, across the shaving, instead of inward into the piece, and thus



*Fig. 27.*

leaves the surface smooth. As the grain often runs differently in different parts of the piece (as it does, for example, in Fig. 25) it will be necessary, in such cases, to turn the piece from time to time, as you work on different parts. While it is not best in general to work against the grain, it is often allowable, and even preferable, to do so when a considerable thickness of wood is to be removed, as the plane, if not set too coarse, works freer and more rapidly against the grain than with it. In this case also, however, it will be necessary, when nearly the desired amount of wood has been taken off, to turn the piece, and finish with the grain.

5. Work, whenever you can, with the

plane as with other tools, with long, steady strokes. When you are obliged to turn the piece frequently, because of the crookedness of the grain, this is of course impracticable.

Bearing these points in mind, and having first practiced on the extra piece of wood, you may now plane up one surface of each of your pieces with the jack-plane, provided the surface is not winding: if any surface is winding we will reserve its treatment for another exercise. When you have done this, you will find that the marks made by the saw ("saw-kerfs" they are called), as well as any stains or rough spots, have been removed; but the general surface, though clean, is now marked with a series of broad and shallow furrows or valleys separated by low ridges which are due to the curved form of the iron, and which will appear very conspicuous if you lay a straight-edge crosswise on your piece. In our next lesson we will endeavor to remove these furrows and make the surface smooth.

## LESSON XII.

### The Smoothing-Plane.

TO cut the ridges left by the jack-plane down to the level of the valleys is the next operation. It may be performed, imperfectly, with the jack-plane. To do this the cutting-iron must be drawn back so that it shall not project so far through the block, and as this adjustment is frequently needed for the purpose of adapting the jack-plane, or any other plane, to hard or crooked-grained wood, it may be learned and

**EXERCISE 16.**

—  
**Adjustment  
of cutting-  
iron.**

practiced here. If you strike the upper surface of the plane near the front, two or three moderately hard blows with the hammer, the wedge will be loosened and the iron will move up out of the block. You must be careful not to strike too hard, or you will, in the first place bruise the plane-block, and in the second place loosen the wedge

and iron too much. By turning the plane up and looking down the "sole" from front to rear you can see how much the iron projects, and judge whether you have it right. If you get it back too far, you can drive it forward again to the right amount by gentle blows of the hammer on its upper edge. When you have it just right, you must drive the wedge tight again.

For the purpose for which you are now going to use the plane the iron should project very little, and the cap should come very close to the edge of the iron. As the edge of the iron is curved, it will not be

**EXERCISE 17.**

**Smoothing  
with jack-  
plane.**

possible to make the surface of the wood plane: you can only replace the deep valleys by shallower ones, and to make them as shallow as possible the iron must project as little as possible. With this precaution, go over again the sides that you have already planed and make them as smooth as you can, remembering the warning concerning planing against the grain. The operation you have just performed can be better done, par-

ticularly on large surfaces, with another plane, called the fore-plane. This is longer and heavier than the jack-plane, and has an iron which, as shown in Fig. 28, *b*, is broader than that of the jack-plane, Fig. 28, *a*, and has an edge which is straight, except just at the corner.

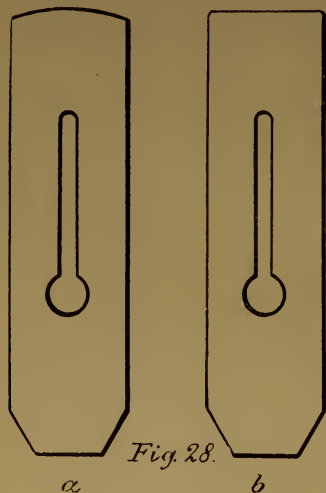

It is easy to see that this plane, if properly used, is capable of making a large surface even, or "plane." It is managed in the same way as the jack-plane, only requiring a little more care to prevent either end from dropping at beginning or end of the stroke. It will not be necessary to

use this tool on the small pieces of this exercise, but we will finish up these pieces with the smoothing-plane. This plane is usually employed after the fore-plane. It is short and light, and specially adapted for

making short and quick strokes. It is therefore exactly fitted for following the fore-plane (or the jack-plane when used as in this exercise) to remove the small pits which result from the former plane's having worked, in some places, against the grain. Observing the same precautions as with the jack-plane, and in particular reversing the direction of your work as often as the grain of the wood requires it, go over your pieces with the smoothing-plane till the ridges left by the jack-plane are all cut down, and the first surface of each piece is made quite straight and smooth. Test this with the straight-edge.

**EXERCISE 18.**

Use of the  
smoothing-  
plane.

We supposed, a little while ago, that the surface of one of your pieces was winding. If it was not so, it is very likely that one of the surfaces may have become so during the operation of planing it. Test these pieces and pick out any that are winding, or make one so by planing off a little from one corner. Suppose  $A B C D$ , Fig. 29, to be the piece, and

**EXERCISE 19.**

Removing  
winding.

suppose that, when you hold it up, with the edge  $D C$  towards you, so that the end  $C$  just hides  $B$ , the end  $A$  stands above  $D$ . This

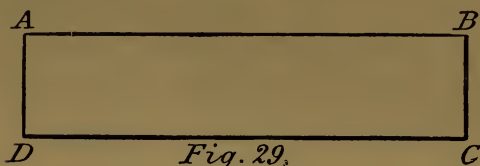

*Fig. 29.*

indicates that something has to be taken off from

either  $A$  or  $C$ . Place a bit of shaving under the corner  $A$  to support it. Then, applying the jack-plane near  $D C$ , take first a short stroke at  $C$ , then a little longer one, and so on, ending with a stroke nearly but not quite the whole length of  $C D$ . The portion of the board near  $C$  is now lower, and when tested as before the piece will be less winding. If you have taken off too much, the winding will even be reversed, and  $C$  and  $A$  will appear too low instead of too high. You must avoid this result by testing the piece frequently while working, otherwise you will get first one winding and then the other, and will plane your piece too thin before you get it true. Having at length made one surface of each of your pieces quite free from



winding and perfectly straight and smooth, mark this with your pencil as the standard surface from which all the others are to be formed.

Having now finished the first faces of all your pieces, these pieces must be reduced to the proper thickness, and the second surfaces must be made parallel to the first, and smooth. The proper thickness is first to be marked round the edge of each piece with the gauge. If you have not wasted material in making the first surface true, you ought to be able to finish up the pieces of your last exercise to a thickness of half an inch.

Loosen the screw of your gauge, and, holding your rule in the left hand, set the gauge by it to half an inch, and tighten the screw moderately.

**EXERCISE 20.****Gauging.**

Try, with the rule, whether the gauge is set exactly right. If not, move it the necessary amount by striking one end or the other of the handle a few times on the bench, and when it is exactly right fasten the head in position with the screw,

but not so tightly as to bruise the handle with the point of the screw.

To mark a piece, hold it in the left hand with the edge up and resting on the bench, the finished side towards the right. Place the head of the gauge against the finished side, and push it from you along the edge of the piece from end to end, not with a series of short jerks, but with one long, steady stroke. The point, resting lightly on the edge of the piece, will make a straight mark parallel to the face of the piece. The commonest fault in the use of the gauge is to bear too heavily on the marking-point, causing it to sink too deeply into the wood. It then moves along, not smoothly, but with a series of jumps, marking deeply in some places and in others not at all, and sometimes following the grain of the wood, and thus making a crooked mark, instead of being directed by the face of the piece and making a straight mark. To avoid this fault proceed as follows: When you set the head of the gauge against the side of the board, if you hold it so that the marking-point shall stand

perpendicular to the edge of the board, as in Fig. 30, *a*, it can penetrate the wood to its full length. If you incline the top of the marking-point forward, as in Fig. 30, *b*, the

corner of the handle will bear upon the board and lift the point up so that it will penetrate to a less depth or

not at all. Now, hold it at first so that the point shall only just touch, and in this position

make a very light mark the whole length of the piece. Then returning to the beginning, hold the gauge so that the point may penetrate a little deeper, and again mark the whole length of the piece, and so on until a sufficiently plain mark has been made. It is seldom necessary to make a deep mark. All that is required is a mark that can be

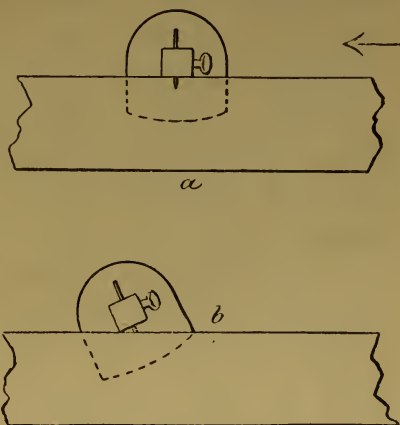

*Fig.30.*

readily seen, and the lightest mark that will serve this purpose is best.

Mark in this way the four edges of all your pieces. Then, with the jack-plane, plane them down just to the marks, being very

**EXERCISE 21.** careful not to go even a little  
 —————  
**Planing to** too far. If you go beyond the  
**thickness.** mark the piece is spoiled.

Finish up with the smoothing-plane. If the work has been well done, each of the faces should be perfectly plane, free from winding, and quite smooth, and the pieces should be everywhere exactly half an inch thick.

After planing the sides of your pieces, plane one edge, holding the piece in the vise,

**EXERCISE 22.** and being very careful not to  
 —————  
**Squaring the** cut off too much at either end,  
**edge of a** and not to let the plane tip over  
**board.** either to the right or the left.

Test for the first fault with the corner of the jack-plane used as a straight-edge, and for the second with the try-square. In applying the square always apply it to the side first finished and marked. One edge being finished straight and square, set the gauge to  $5\frac{3}{4}$

inches, and mark the pieces to this width from the finished edge. When the gauge is set so wide as this, it is even more necessary than before to bear lightly on it. It is more difficult to control the gauge when so wide open, and if the point enters too deep it will jump and make a crooked mark. Having marked all the pieces to the proper width, plane the second edges down to the mark, but not beyond it.

**EXERCISE 23.**

**Gauging and  
planing to  
width.**

## LESSON XIII.

### Back-saw and Bench-dog.

THE pieces you have been working on are now of the uniform thickness of half an inch and of the breadth of  $5\frac{3}{4}$  inches. They are still marred, however, by the nail-holes made in them in a former exercise. They are now to be cut off square, a little shorter than before, and smoother at the ends than we were able to make them with the ordinary cross-cut-saw. For this work we will use the "back-saw" or "tenon-saw." This saw is shorter and thinner than the one you have used before, and has more teeth to the inch. Its teeth also are not bent sideways or "set" as much as those of the cross-cut-saw. Examine the two saws carefully, and compare them in these particulars. The back-saw being thinner than other saws is more likely to bend. To prevent bending it is provided with a stiff back, which gives it its name.

While this allows the saw to be made thinner, and therefore fits it for finer work, it limits, of course, the depth of the cut that can be made with it. A back-saw still smaller, thinner, and finer than the tenon-saw that you have, and with no set to its teeth, is called a "dove-tail" saw.

In working with small back-saws, it is generally the case that a number of pieces are to be cut in quick succession. Too much time would be wasted if these were all to be fastened in the vise before cutting them, and besides, the firm grip of the vise is not necessary. Small pieces are most conveniently cut on the "bench-dog" which you find on your bench, and which is shown, in elevation and plan, in Fig. 31. Lay the dog on your bench, one of the cross-strips being downward and resting against the front of the bench. Laying the piece that is to be cross-cut on the dog and resting against the other cross-strip, with the end that is to be cut off projecting a little beyond the right-hand edge of the dog, you can easily hold it with the left hand, and cut off the piece required. In the case of

the pieces you have been using we will cut off enough to remove the nail-holes. Half an inch at each end of the long pieces will suffice for this. This will reduce the long pieces to

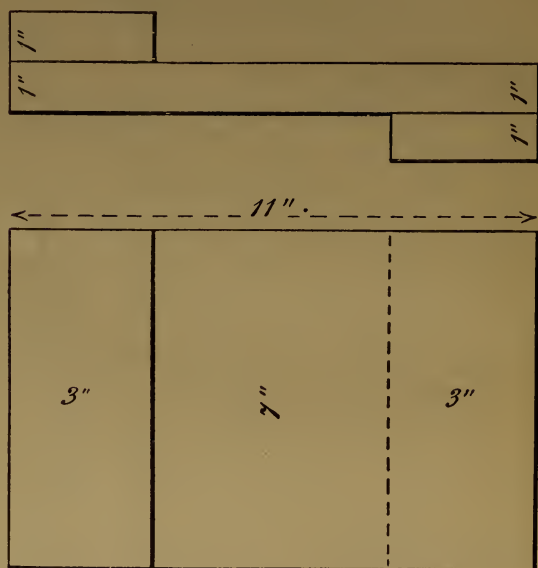

*Fig. 31.*

$11\frac{1}{2}$  inches, and, to keep nearly the same proportion of length to breadth as before, we will take off  $\frac{3}{8}$  of an inch from each end of the short pieces, reducing them to  $7\frac{1}{4}$  inches.



Having made the necessary pencil-marks with the square, as in Lesson VIII., remembering all the cautions there given as to working with your square always from the same edge and side, allowing for the waste of the saw, and so on, you will proceed to cut off the narrow pieces from the ends, making first a few trial cuts on another piece, to get the necessary steadiness of hand. In cutting with the back-saw, hold the saw with **EXERCISE 24.** its edge nearly parallel to the **Cross-cutting** surface of the piece, but let the **with back-saw.** tip of the saw drop a little at first, so as to begin the cut at the farther edge of the board. Remember the injunctions to cut slowly at first, to keep the saw upright, not to force it, and to cut gently when the saw is nearly through. If you have carried the pencil-marks all round the pieces, there will always be one of the marks on the faces and one of those on the edges in view to guide you.

The pieces being now, if your work has been well done, exactly alike in pairs, are ready to be formed into a box of much better finish than the one first made with nails. We will

put it together with "dove-tail" joints; but before this can be done it will be necessary to acquire some skill in the use of the chisel. Two other pieces may be cut out and planed up for the top and bottom. You may determine the proper size for these, and lay them out and get them ready yourself.

In cutting out these pieces you will have to saw lengthwise of the grain, and will use the "rip-saw" for this purpose. You will observe that this has larger teeth than the cross-cut-saw, that the front faces of the teeth are square instead of having sharp edges, and that the angle of the tooth is smaller.

On considering a little you will see that these differences are in accordance with what we have learned about the different strength of wood in different directions. The lower edge of the tooth of



*Fig. 32.*

the rip-saw, at *a*, Fig. 32, has to cut *across* the fibers, and must therefore be sharp. The

front  $a b$  has only to push the pieces out, and is therefore blunt. In the case of the cross-cut saw, it is the front edge  $c d$  that cuts across the grain, and is therefore filed sharp, and the pieces are pushed out by the point  $c$ . Furthermore, as the edge  $c d$  is to cut the fibers, it will work best when it falls on them not quite perpendicularly, but obliquely, which is the reason why  $c d$  is not perpendicular to the edge of the saw, as  $a b$  is.

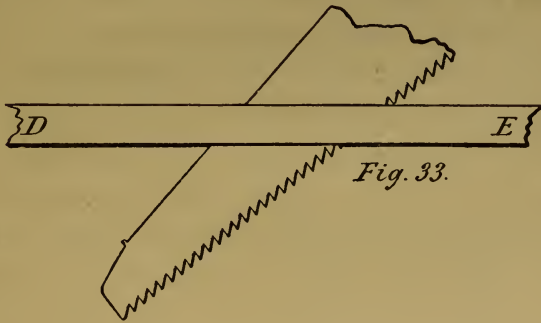

On the other hand, the corner  $a$  of the tooth of the rip-saw, being a sort of chisel, works best when driven obliquely across the fibres. In ripping the piece  $D E$ , therefore, Fig. 33, the saw should be held as shown, rather than perpendicular to the length of the board,

In making a long cut with the rip-saw, you will sometimes be hindered by the springing together of the parts that are already cut, causing them to "pinch" the saw and resist its motion. The remedy for this is to insert a wedge, such as a chisel, a screw-driver, or a piece of wood, in the cut near the saw. Towards the end of the cut care must be taken that this wedge does not split the board.

The six pieces are now to be put away while the use of the chisel is being learned, by which time they will be thoroughly seasoned. They must be set up on edge with a space of at least an inch between them for circulation of air, so that they may not warp. You may mark on each piece its exact dimensions, and note, when you take it up again, how much it has shrunk in each direction.

## LESSON XIV.

### The Chisel.

**O**BSERVE the form of the inch chisel on your bench. Its back is perfectly straight and flat. Its face makes with its back an angle of twenty-five degrees, and just at the edge is a short face which makes with the back a somewhat larger angle, namely,  $35^{\circ}$ . This form is given to the chisel in the following way: First, it is held on the grindstone till the face  $A B$ , Fig. 34, is formed, making with the

back the angle  $25^{\circ}$ .

Then the part near  $A$  is rubbed on the oil-

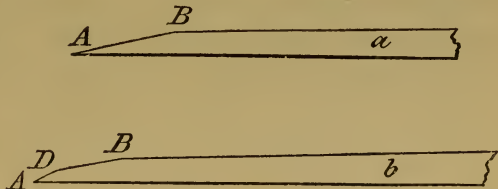

*Fig. 34.*

stone, in a manner which will be explained presently, making the narrow face  $A D$ . This face is exaggerated in the figure, to make it

clear; it should be less than half as wide as it is there shown. If you examine the chisel on your bench, which is in good condition, you easily detect on *D B* the scratches made by the grindstone, while *A D*, which was finished on the fine-grained oil-stone, is smooth and bright, and the edge at *A* is very keen. This is the condition in which the chisel and all similar cutting tools should be constantly kept. When the tool is dull you cannot do fine work with it; and, moreover, in trying to force it you are very apt to make it slip and cut yourself, so that a dull tool is really more dangerous than a sharp one.

The chisel and the plane have the same form of cutting edge and require the same treatment. Other cutting tools resemble these in general, but differ in respect to the size of the cutting angle, and some other particulars. It will be readily understood that if the tool is to be used on hard material, it must be stronger, to prevent its breaking or "nicking" on the edge, and therefore the angle must be larger. As we become acquainted with various tools for cutting wood and metals

we shall find that this angle has very different values, reaching even to  $90^\circ$  in some lathe-tools for cutting metals.

There are several different ways of holding the chisel, according to the kind of work to be done and the force required.

1. In paring off thin shavings the chisel is intermediate, as to the quality of the work it can do, between the knife and the plane. We will take, for an exercise of this kind, a piece of pine or of whitewood with a rough or crooked edge, which we will make straight and smooth as in Exercise 4, but with the chisel instead of the knife. We will cut from a  $1\frac{1}{4}$ " or  $1\frac{1}{2}$ " plank a piece 9 inches long, and will split from this, with the hatchet, pieces about 2" wide. We will select for the purpose a plank which, though of good quality, is not very straight-grained, so as to give us some little difficulty in dealing with the grain.

Holding one of these pieces in the vise, with one of the crooked edges upward, take the end of the handle of the chisel in the hollow of the right hand, the thumb and first

finger lying forward on the handle, and the other fingers curved under and grasping it.

**EXERCISE 25.** Lay the back of the chisel (not the beveled side) flat on the surface of the wood, and hold it down with two or three fingers of the left hand lying on the blade, a little way back from the edge. Pushing the chisel forward it will now cut off projecting masses very much as the plane does. (If the edge of the piece is very crooked, so that much wood has to be removed, as in Fig. 4, p. 10, it may be scored and split, exactly, as in the exercise with the knife or the hatchet.) This operation of paring is very simple so long as the grain is quite straight, or even when it is moderately crooked, provided you can work with the grain: it is only necessary to push the chisel with a steady movement lengthwise along the piece, and the back of the chisel, like the sole of the plane, prevents its entering too deep. But when the grain is very irregular, so that as the tool advances you find it working now with the grain and now against it in quick succession, it will be found best to work with



a sliding rather than a pushing movement, obliquely, across the grain rather than along it. Thus, if the grain runs as shown in the elevation *A*, Fig. 35, then, in paring the upper

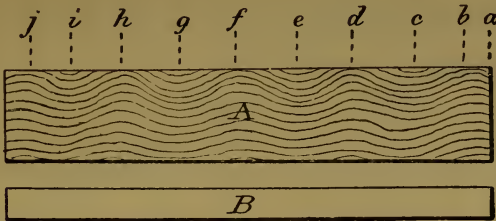

*Fig. 35.*

edge, shown in plan at *B*, if the chisel moves from right to left, it will work against the grain in going over the spaces *b c*, *d e*, *f g*, etc., and with the grain over the spaces *a b*, *c d*, *e f*, etc. It will be found best, then, as it is not practicable to reverse the direction of the work so often, to lay the chisel on the work,



*Fig. 36.*

not as shown in Fig. 36, but obliquely, as in Fig. 37, and in moving the chisel, not only

to push it in the direction of the arrow *a*, but to give it, at the same time, a sliding motion towards the right or left. The first movement alone would make the chisel come out

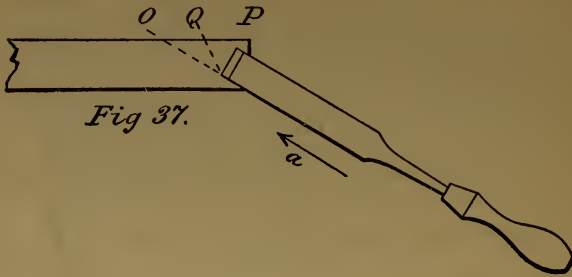

at *O*; the second would bring it out at *P*; the two movements together make it come out at *Q*. This sliding movement of the chisel, like that of the knife already spoken of (see p. 4) is very important, and you should take pains to get command of it. With it wood can be pared smooth which would be quite unmanageable without it. The reason of this can now be easily understood. The edge of a knife, chisel, or plane, however keenly it is sharpened, is always more or less jagged like a saw. On some tools you can *feel* the inequalities or teeth with the finger, and even

when, as in a well-sharpened razor, you cannot feel them, you can *see* them under a microscope. When the tool has the sliding movement that has been described, these teeth catch the fibers crosswise and cut them off, while, if it is pushed straight forward, it forces itself between the fibers, as a wedge, and splits them apart along the grain.

Paying attention to the points just mentioned, you may now, drawing a straight line on your piece of wood about a quarter of an inch back from the edge, pare the edge down to the mark, making it straight, square, and smooth. Test your work carefully with respect to all these requirements, and do not be satisfied till you have produced a really good result.

When you have worked with the chisel or other cutting tool some time, it becomes dull, and does not cut well. If you examine its cutting edge you will find that instead of being quite invisible, as it was at first, it is visible as a bright shining edge, and instead of feeling very keen to the end of the finger, it is smooth and rounded. Under a glass it

would appear as at *a*, Fig. 38, rather than as at *b*. The keen edge must be restored by sharpening on the oil-stone.

**EXERCISE 26.** A plane-iron and a chisel are

**Sharpening** sharpened in the same way, and  
**a chisel.** it is of the utmost importance

that this should be done properly. Having

put a few drops

of oil on the

stone, take the

chisel in the right

hand, place the

beveled face on

the stone and

press it down



*Fig. 38.*

with two or three fingers of the left hand held near the edge of the blade. At first place the tool on the stone so that the beveled face touches all over, Fig. 39, *a*. Then raise the right hand a little, so that only the small bevel shall touch, as at *b*. Be careful not to raise the hand too high: it is only necessary to just miss rubbing the large bevel. If the hand is raised too high, the edge will be worn away too much, and the angle of the

chisel will be too large. Until the right way of holding has become habitual, it may be

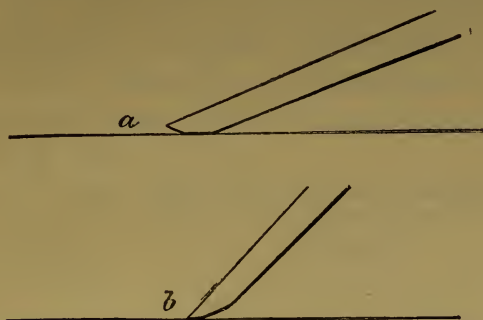
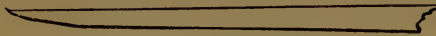

*Fig.39.*

noted that the height of the end of the handle above the surface of the stone should be about six-tenths of the length of the tool and handle. Thus, if the entire length of the chisel is 10 inches, the middle of the circular end of the handle should be 6 inches above the stone. In rubbing the tool on the stone, the hand must be pushed to and fro *parallel to the stone*, not rising and falling a little, which would make the edge of the tool round.

If the chisel has not been neglected too long it will not be necessary to rub it much

It is only necessary to remove the roundness just described. When this is done, the metal will begin to turn up a little on the back, making a roughness called a "wire-edge," as shown, exaggerated, in Fig. 40. This wire-edge is removed by laying the flat side on



*Fig. 40.*

the stone and giving the tool a few light strokes. It

must not be at all tipped up during this operation, nor the operation continued long, or the back will be rounded and the tool spoiled. The operations being repeated once or twice, more and more lightly, a fine keen edge will appear.

In using any cutting tool, it will be found much the best plan to sharpen it *frequently*. If this is done, it will require only a slight rubbing each time, and the best quality of work can be done with a tool thus kept in order.

When the tool has been sharpened very often the short bevel near the edge becomes wide, and much work is then

required to sharpen it on the oil-stone. It must then be ground on the grind-stone. The *long* bevel, which makes the smaller angle with the back (*D B*, Fig. 34) is to be held on the stone, until it is ground away so far that it runs quite out to the edge at *A*. In doing this take care.

1. To hold the tool steady at the proper inclination.

2. To keep plenty of water on the stone, so as not to heat the tool. Heat would soften and spoil it.

3. To turn the stone *towards* the chisel, particularly near the end of the grinding. Turning it from the chisel will turn up a "wire-edge," as in Fig. 40.

4. Never to let the stone touch the back of the tool.

When the bevel *A B*, Fig. 34, has been carried out to the edge, which will make the latter rough, a moderate rubbing on the oil-stone will give it a smooth, keen edge.

Having now pared one edge of your piece of wood straight and smooth, each of you may exchange pieces with his next

neighbor, and repeat the operation on the opposite edge. This exchange is made for the purpose of giving you an opportunity to examine and become acquainted with the two kinds of wood that have been distributed through the class. The pine is of the kind called white-pine. It is soft and straight-grained, and planes to a smooth, glossy surface if the piece is a good one. The tree is a fine evergreen which grows to a height of one hundred to one hundred and fifty feet in the woods of the Northern States and Canada, and sometimes has a trunk six feet in diameter. Its leaves are long slender needles (Fig. 41), growing



*Fig. 41.*

in groups of five, each group making, if the several parts are pressed together, a complete cylinder. You can find small specimens of the tree in woods and parks



---

almost everywhere, but the large ones are to be seen only in the wild Northern woods, and even there are getting scarce. It is very different in its mode of growth, the shape and grouping of its leaves, and the character of its wood from the yellow-pine and the pitch-pine, and you ought to endeavor, as opportunity offers in the workshop and elsewhere, to make yourself acquainted with these different species and their uses. The white-wood is the wood of the tulip-tree, which is also a large, handsome tree, with fine straight trunk, and with curious, square-cut leaves, as in Fig. 42. It is not an evergreen, but a deciduous tree; that is, it loses its leaves in the fall. It bears, in June, a coarse, tulip-shaped, yellow flower, from which it is named. Its wood, as you see, is not white, but greenish-yellow. It is very straight-grained, free from knots, soft and easily worked, and is much used in house-carpentry, and in furniture and pattern-making.

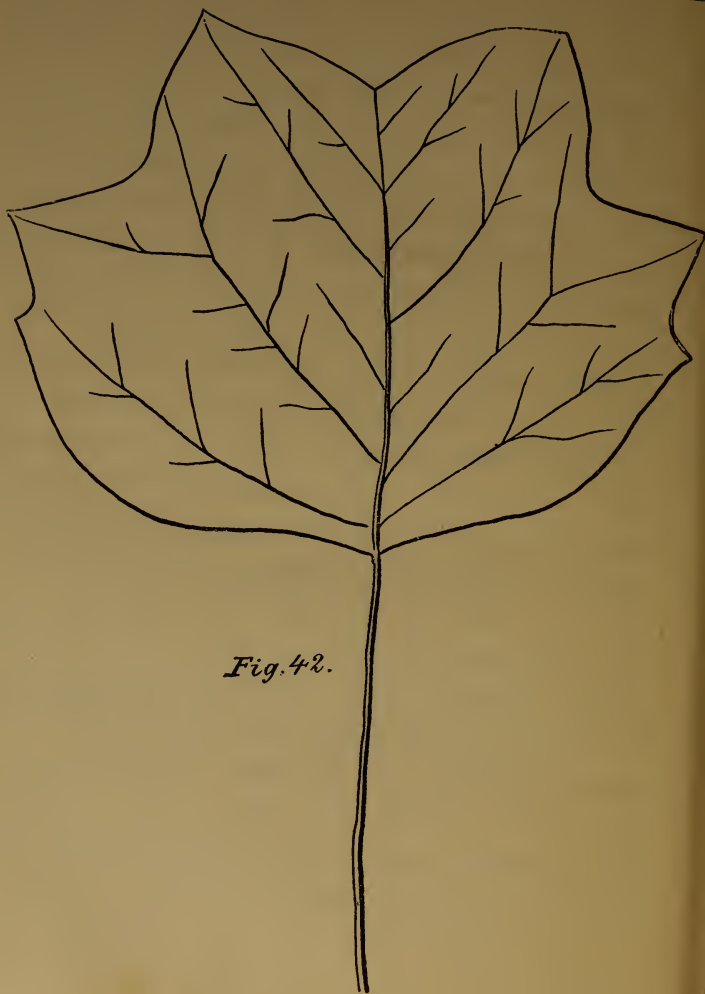
*Fig. 42.*

## LESSON XV.

### The Chisel Continued.

WHEN greater force has to be applied to the chisel, as in paring across the grain, the handle is held in the closed right hand, the end of it standing out a little on the upper or thumb side, and the flat side of the chisel being turned towards the body. Leaning over the work and bringing the shoulder against the handle of the chisel, the tool is forced downward by the pressure of the hand and the shoulder together. In this case, also, the oblique or sliding movement makes the tool cut easier.

As an exercise in this method of using the chisel, one end of the piece used in the last

**EXERCISE 27.** exercise may be "chamfered" or

**Chamfering** "beveled" on the edge. The

**end-wood.** work must be first marked

out, as in Fig. 43 which shows elevation, plan, and end elevation of the piece. The

line  $F E$  is to be drawn lightly, on one end, with the gauge, in the middle of the thickness of the piece;  $C D$  is to be drawn on one face, with lead-pencil and square, at the same

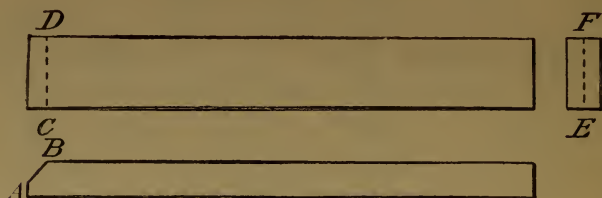
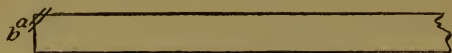

*Fig. 43*

distance from the corner that  $E F$  is;  $A B$  may be ruled with the lead-pencil and the edge of the square. The line  $A B$ , being on the top of the piece, is visible in the plan;  $C D$ , being on the back, is dotted on the elevation, and for a like reason,  $E$  is dotted in the right-hand end elevation. Holding the piece in the left-hand, by one end, rest the edge, at the other end, on a clean piece of wood,—not on the bench. The bench may have dust on it, which would dull the chisel; and besides, chiseling on the bench destroys the smooth surface that it ought always to

have. The piece should be held with the side that is to be beveled turned from you; leaning over, you will then have a good view of the part you are cutting. Setting the edge of the chisel near the corner, as at *a*, Fig. 44, press it down

and cut off a small chip.



*Fig. 44.*

Then setting

it back a little, as at *b*, cut off another, and so on. As the cuts become wider it will be harder to drive the chisel down, and you will have to take thinner shavings. Do not forget, particularly when making the last cuts, that it will work easier if, while *pushing* the chisel in the direction *D C*, you also *slide* it in the direction *B A*. The last cut should be a very light one, and made very carefully and with a keen chisel, so as to leave the surface quite plane and smooth.

After chamfering one side of the end *A*, mark and chamfer the other side of the same end, working the end to a sharp edge. Then chamfer the other two edges of the same end, working it to a point. As the

quantity of wood to be removed in this part of the exercise is less, the chisel will work easier, and the pressure of the shoulder will not be needed. You may hold the piece in your vise, the end that is to be beveled projecting only a little above the bench, so as to be firm, and the chisel being managed as in Exercise 25. Finally, make a drawing in plan, elevation, and end elevation of the finished piece, to a scale of  $\frac{1}{2}$ .

3. In the exercise just finished, the cut was made obliquely across the grain. When it is made square across it is more difficult. In this case, and particularly when the piece to be cut off is so situated that the sliding movement cannot well be used, a mallet is used to drive the chisel. In this case the chisel is held in the left hand, nearly or quite perpendicular to the surface of the wood, and with the same grip as in the last exercise, but not bearing against the shoulder. The hammer must not be used instead of the mallet, as this will deface the handle of the chisel, and after a while split it. When the position of the cut will allow it, some of the wood

may be removed by the brace and bit, or a portion of the cut may be made with the saw, before beginning to use the chisel. The next exercise, a "through-mortise," will illustrate the first plan, and the following exercise, an "end dove-tail," the second.

**EXERCISE 28.**  
**Mortising.**

Figure 45 is a working sketch of one form of a "mortise and tenon" joint. *A* and *B* are

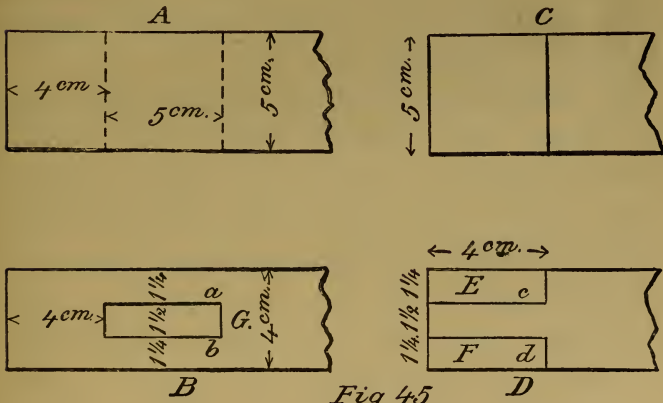

Fig 45

elevation and plan of the mortise and *C* and *D* of the tenon. No end elevations are needed.

The dimensions are given in centimeters,

that is, hundredths of a meter, that the eye may become accustomed to Metric measures as well as English measures. A centimeter is a little less than half an inch ( $0^{\text{in}}.39$ ), a meter being a little more than a yard (39 inches, or 3.28 feet). An examination of the drawing will show that, when the two pieces *E* and *F* are cut out, the remaining piece, or "tenon," will, if properly cut, fit closely in the hole or mortise *G*, and the pieces will be firmly joined together perpendicular to each other.

To make this joint, the pieces must first be planed up exactly square and to the true dimensions. Sharpen the plane if necessary. First plane one surface of each piece true and mark it thus  $\times$ . Next plane one adjacent surface on each piece true, and perpendicular to the first surface, testing with the square. Next, mark the pieces to the proper breadth and thickness with the gauge, measuring from these finished surfaces, and plane to the marks. All four surfaces of each piece should now be of the proper dimensions, and the pieces square. Set the smoothing-



plane fine and finish the surfaces, taking off only enough wood to make the surfaces smooth.

Now mark out the joint, drawing the lines *a*, *b*, *c*, *d* with the gauge, being careful not to mark them too deep nor to extend them too far, and draw the other lines with the square and a sharp lead-pencil. Both sides of the pieces must be marked, and also the end of the tenon-piece, *C D*.

To cut out the wood from the mortise, first use the brace, with a center-bit three or four millimeters smaller than the width of the mortise (a millimeter is a tenth of a centimeter, or a thousandth of a meter, and is the smallest division on your metric rule).

Notice the way in which the center-bit works. The revolving knife-point or "cutter" first makes a circular cut, **EXERCISE 29.** and then the revolving chisel, **Boring with center-bit.** following the knife, removes a chip. If the cutter is not sharp on the front edge it will not make a clean cut.

If it is too short, the chisel will cut before the cutter has prepared the way for it, and will tear out the wood beyond the intended circle. Hence, though the cutter must be sharpened with a file when necessary, the sharpening must be done only on the inside edge, and very carefully, for if the outside edge is filed the circle cut will be too small, and if the cutter is made too short the bit is spoiled.

With the center-bit a hole is to be bored through the piece near each end of the mortise. It is necessary that this hole should go through quite squarely, or it will cut away wood which ought not to be cut. A few experiments may be made first on the other end of the piece, or on a piece of waste wood. Mark a point near

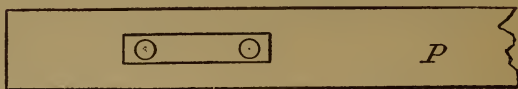

*Fig. 46.*

the end, as at *P*, Fig. 46, and then with the gauge and square find the point exactly

opposite *P*. Hold the piece in the vise, the end *P* standing up above the bench. Place the handle of the brace against the breast, set the point of the bit on *P*, hold the bit perpendicular to the surface, and begin to bore without altering the position of the brace. No hard pressure on the brace will be needed, if the wood is soft, as pine or white-wood, and the bit in order. When you have bored about 1<sup>cm</sup>, stand aside, holding the end of the brace in the hand without altering its position, and examine, both from above and from the side, whether it is perpendicular to the surface of the block. If it is not, make it so and go on. Examine again once or twice before boring through. As soon as the point of the bit begins to show, if it comes out at the marked point, or within one or two millimeters, you have bored pretty well and may venture to bore the holes for the mortise. As soon as the point makes its appearance reverse the block and bore from the other side, or clamp another piece tightly against your piece in the vise,

and bore through against that. Unless you take one or the other of these precautions the bit will splinter the wood when it comes through. The first two holes having been bored, as in the Figure, a series of holes may be made between them, touching each other, and removing most of the wood from the mortise.

The mortise is now to be trimmed to its exact size and shape with the chisel. To do this, lay the block on a piece of clean wood on the bench, set the chisel (which must be a little narrower than the mortise) upright on it about  $\frac{1}{8}$  inch inside of the *end* mark, the flat side towards the mark, and drive it in by a smart stroke of the mallet. Pare away the wood at the *sides* of the mortise with a wide chisel; drive the narrow chisel in again, and so on till the mortise is cut about half-way through. Then turn the piece over and cut in the same way from the other side. A little wood has been left, which is now to be very carefully pared off, holding the chisel against the shoulder as explained in

the previous lesson, and taking especial pains not to cut beyond the marks. This paring also should be continued half-way through from opposite sides in succession. The four sides of the mortise, if properly finished, will now be smooth, perpendicular to the faces, and parallel, in pairs, to each other.

The tenon is to be cut with the "back-saw." This is, as you have seen, finer than the cross-cut-saw heretofore used, and if skillfully handled will leave the surfaces smooth enough without the use of the chisel. To avoid the risk, however, of cutting the tenon too small, it will be best, until you have acquired considerable skill, to saw not quite up to the marks, leaving a very small amount to be pared off with the chisel.<sup>1</sup>

If the mortise and tenon have been properly cut, they will now fit closely together. The tenon must not go in too tight. If it does, particularly sideways, it will split the mortise-piece. If it does not enter when driven with

<sup>1</sup> Some particulars in the management of this saw when cutting lengthwise of the grain are given in the next lesson (page 115), and may be noticed here.

gentle blows of the mallet, it must be withdrawn. The bruises on the surfaces will show where it fits too tight, and either it or the mortise must be pared down carefully till a good fit is obtained.

## LESSON XVI.

The Chisel Continued. — End Dove-Tail.

THE two pieces that were put together in your last lesson can be pulled apart in one direction. The piece *A*, Fig. 47, can be drawn out from *B* towards the right, but the part of *B* which projects above *A* in the figure prevents the tenon from being removed by a pull upward, or in the direction of the arrow. If we wished, however, to get

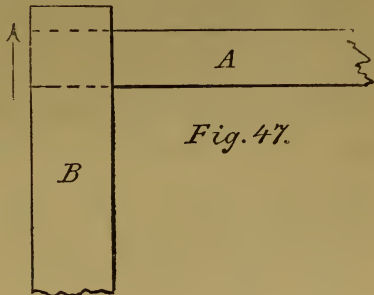

rid of the projecting piece above the tenon, so as to have a smooth corner, we should lose this advantage, and unless the tenon were narrowed, *A* would not be able to resist either a force toward the right or an upward force, but would yield in either direction. If we

wish, in this case, to have *A* held fast so that there shall be one direction in which it can be pulled without being withdrawn, we must give the joint another shape. This shape is called the "dove-tail," from its resemblance to the spreading tail of a dove, Fig. 48. It

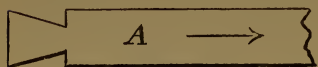

*Fig. 48.*

is evident that if the dove-tailed piece *A* is fitted into a hole of the same shape, it cannot

be withdrawn by pulling in the direction of the arrow. With this explanation you will now be able to understand the sketches in Fig. 49, in which *A* and *B* represent the plan and elevation of the mortise-piece, *C* and *D* those of the tenon-piece, and *E* and *F* those of the two pieces put together.

The two pieces are to be first carefully planed true and smooth as in the last **EXERCISE 30.** exercise. The work is then to **End dove-tail.** be laid out. The thickness of *A B* ( $1\frac{1}{2}$ " ) is to be marked with a sharp pencil on *C D*, first on the upper side shown at *C*, then, by means of the square, on the front side *D*, and then, from these



two sides, with the square, on the other two sides. In the same manner, the thickness of *C D* is to be marked, first on the right-hand face of *A B*, then on the front

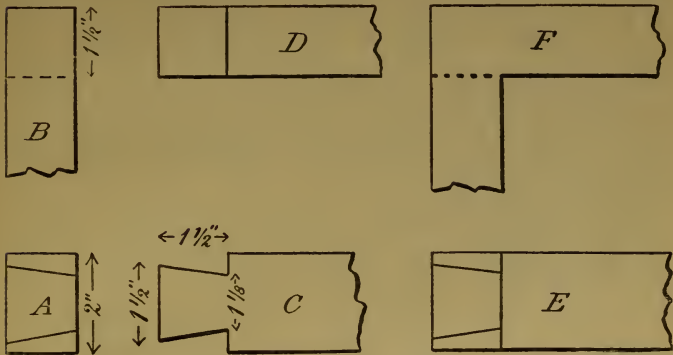

*Fig. 49.*

face shown at *B*, and then from these on the other two. Next the two inclined lines marking out the dove-tail are to be drawn on the upper face of *C*, then on the lower face, and then their ends are to be joined by lines drawn across the end of the piece. Lastly, similar inclined lines are to be drawn on the end of *A*, and from their extremities lines are to be drawn down the right and left faces of *A B* to the cross-

mark. Mark with a cross  $\times$ , as in Fig. 54, to prevent mistakes, the pieces of wood that are to be cut away, and before beginning to cut, put the pieces together and make sure that your marks are right. The lines are all to be drawn with a very sharp pencil, so that if you cut exactly up to the center of each line, but not beyond, the dove-tail or tenon and the hollow or mortise shall fit perfectly together.

The cutting of the marked portions from the tenon-piece *C* is very simple. It is all done with the back-saw, and if the tool is handled with skill, nothing will remain for the chisel. To do this, however, would require more skill than you can be expected to possess as yet, and you may therefore cut not quite up to the marks with the saw, leaving a little wood to be trimmed off with the chisel. Be very careful, when trimming this off, to have your chisel as keen as possible, and to use the sliding movement already described.

In removing the wood from the mortise-piece also, the first part of the work is

done with the saw. Hold the piece upright in the vise, place the saw just within the inclined marks on the end of *A*, but very near them, and cut down to the cross-mark. In making these cuts on *A*, as well as the corresponding cuts on *C*, and any others which go lengthwise of the grain, be careful not to hold the saw quite horizontally, or with the tip inclining downward, as in cross-cutting, but with the handle downward as in ripping, as in Fig. 50. Otherwise the

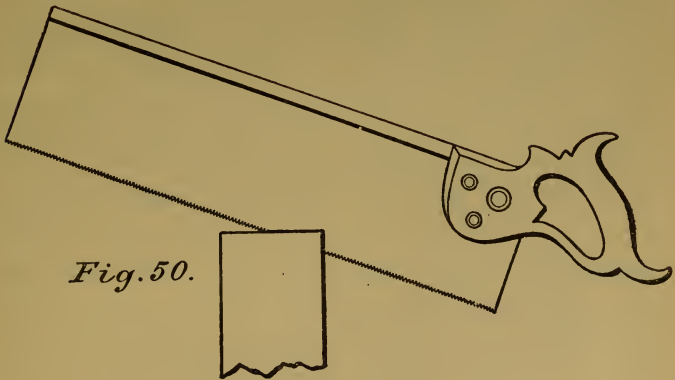

teeth will stick too firmly in the wood, and the saw will jump, or "chatter." In making cross-cuts, as the two short cuts in *C*, this precaution is not necessary.

When the two saw-cuts in the mortise-piece have been made, the next operation is to cut out the piece of wood between them down to the cross-mark. Here, as in the last exercise, the work of cutting with the chisel may be lessened by the use of the

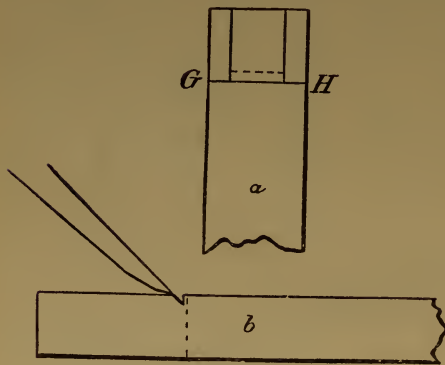

*Fig. 51*

brace and bit; but we will, for the sake of variety in exercise, use a different method, cutting the mortise with the chisel alone. Lay the piece

on the bench, with the dove-tail end from you and the right side (Fig. 49, *B*) up: this is the side on which the two cuts come nearest together ( $1\frac{1}{8}$ "'). Set the edge of your one-inch chisel at the dotted line, Fig. 51, about  $\frac{1}{8}$ " inside of *G H*, the flat side of the chisel being towards you. Strike a smart blow with the mallet, driving

---

the chisel in about a quarter of an inch. Do not strike a series of feeble, uncertain blows, but one vigorous one. You may, if you choose, after placing the chisel, give it one gentle tap to make sure of starting it right (though this is not necessary), but when you are sure that it is right, strike it boldly. Having driven the chisel in about a quarter of an inch, you have now compressed the wood so that it is difficult to penetrate any farther. Set the chisel about a quarter of an inch nearer to the end, but tipped forward, as at *b* in the Figure, so that it shall work towards the cut you have already made. It will thus throw out the little triangular chip shown in the Figure. Set the chisel upright again at the same point as at first, and drive it in farther. Move it nearer to the end, tipped forward again, and cut out another chip. Advance thus, till you have got half-way through the piece; then turn it over and proceed in the same way from the other side. Be careful not to let the chisel go through and strike the bench. If you cannot check it, place a piece of clean board under your work. As

the piece to be cut out is wider on the second face than on the first, you must incline your chisel right and left, so as to cut under a little while working from the first face and to avoid cutting into the sides of the mortise when working from the second.

When the piece is cut out, the three sides of the mortise are to be carefully pared so that the tenon will go in, fitting closely, but not so tightly as to split the mortise-piece.

## LESSON XVII.

The Chisel Continued. — Dove-Tailing.

WE will now return to the box which we left unfinished in our thirteenth Lesson. We had got out the required material, cut it to the proper shape, and put it away to dry thoroughly. Examine the pieces carefully for shrinking, warping, and winding, and if necessary reduce them to their proper shape and dimensions. If they have shrunk or twisted much, it may be necessary to make them somewhat smaller than originally proposed, say  $\frac{7}{16}'' \times 5\frac{11}{16}'' \times 12\frac{1}{2}''$  for the long pieces, and  $\frac{7}{16}'' \times 5\frac{11}{16}'' \times 7\frac{3}{4}''$  for the short pieces; but it is to be hoped that this will not be necessary.

The four pieces for the sides are now to be put together with dove-tail joints as in Fig. 52, which is a working drawing showing five dove-tailed tenons on each end of the long pieces *A*, which fit into five corresponding mortises in the ends of the short pieces *B*. The pieces

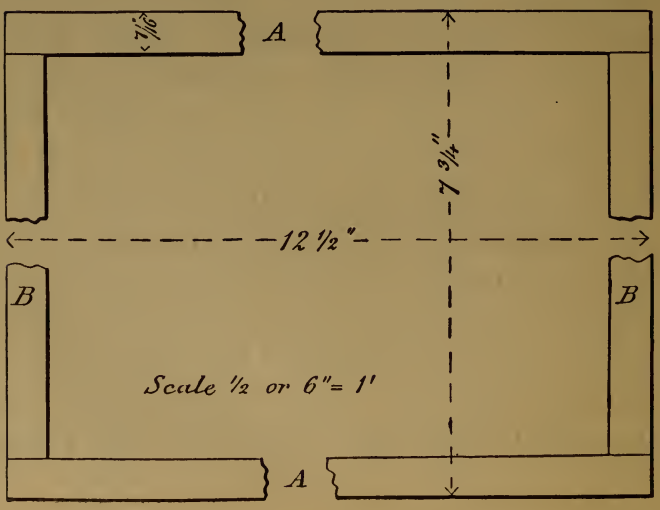
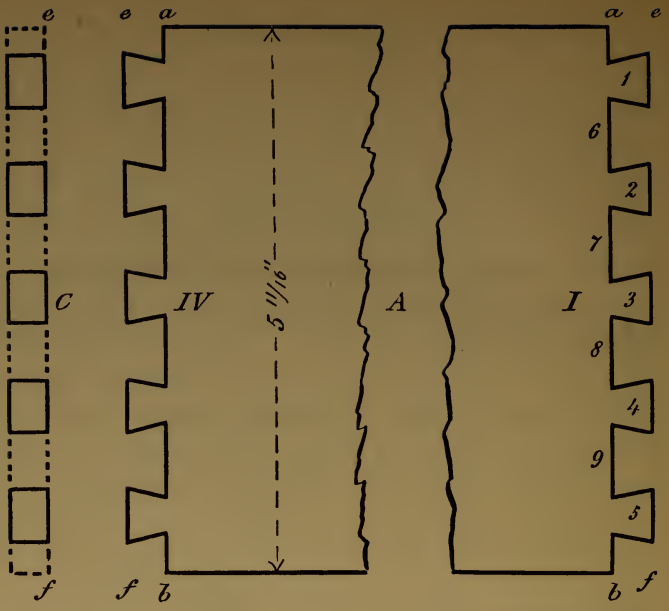



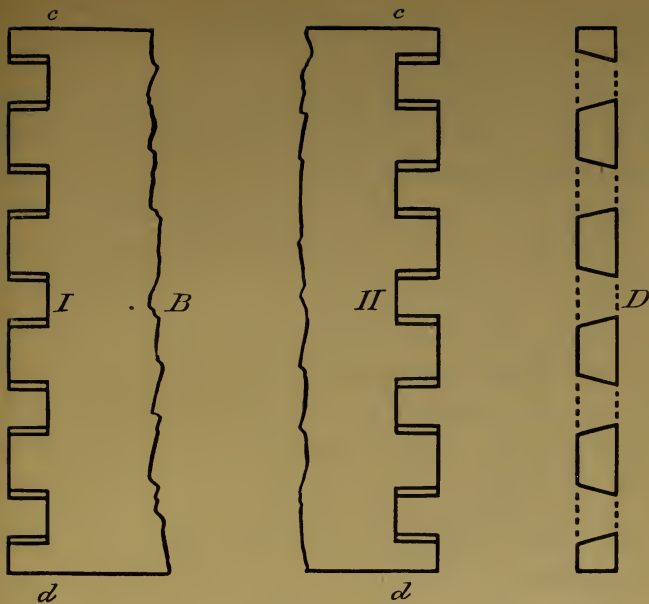

*Fig. 52.*

which stand out between the mortises in *B*, and which might themselves be regarded as tenons fitting into mortises in *A*, are called "pins." The figures *C* and *D* show end-views of the pieces *A* and *B* respectively. The interrupted lines at *A* and *B* have the meaning already explained on page 2.

These drawings should be carefully studied till they are thoroughly understood. If they cannot be understood otherwise, you may

examine a finished box and compare them with it. After this the work is to be laid out in the following way:

First, the lines  $a b$  are to be drawn with square and pencil on both sides of  $A$ , being careful, as before explained in similar cases, to work from one edge and one face of the piece. Then the lines  $c d$  are to be drawn on the pieces  $B$ . Next set out on  $a b$  the eleven distances, of which those numbered 1, 2, 3, 4, 5 are equal, those numbered 6, 7, 8, 9 are also equal, and the two end spaces are half as long as 6 and 7.

When these spaces have been laid out exactly, the oblique lines from  $a b$  to  $e f$  can be drawn with the "bevel," provided  $e f$  is quite straight and square. The bevel must be first set to the proper angle. Take a smooth piece of board five or six inches wide, with one straight edge and one smooth face. The piece that you have used in previous exercises to place under your work to protect your bench will do very well. Near one end draw a fine pencil-line across it with your square. Measure from this line an inch along the

edge of the board, and four inches along the line. Place your bevel with the handle against the edge of the board, set the blade so that the edge of it shall pass exactly through the two points thus determined, and clamp it. With the bevel thus set, placing it against the end of the piece *A*, you can mark first all the lines which slope in one direction, and then, turning it over, all those that slope in the other direction. They will appear as in Fig. 52 *A*. The dove-tails will be a little wider at the ends and will hold a little tighter, if the bevel is set with a slope of  $3\frac{1}{2}$  to 1, or even of 3 to 1, instead of 4 to 1. This, however, will make the acute angles of the dove-tails and pins weaker, and if the wood is soft they may break off at the edges. The work is sometimes laid out with smaller pins and wider dove-tails, as in Fig. 53 *A*. This lessens the amount of work to be done, but leaves the pins rather weak. If both the pins and the dove-tails are widened, as in Fig. 53 *B*, the work has the appearance of too much sparing of labor. You may lay out, on

**EXERCISE 31.**

—  
Laying out  
dove-tails.

the edges and ends of your piece of board sets of dove-tails with different angles and

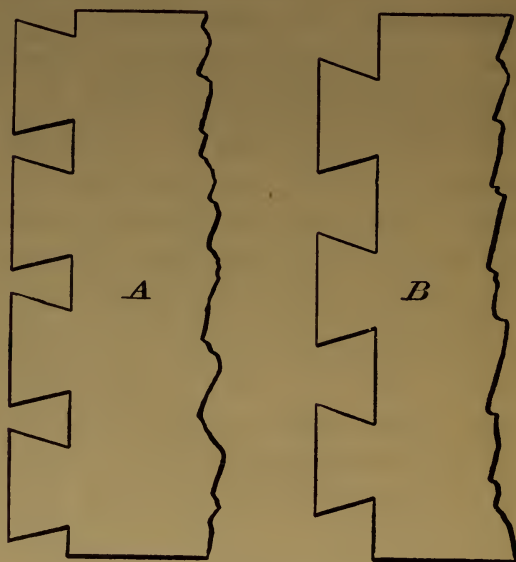

*Fig. 53.*

spaces, and compare them as to appearance and strength, and may select one for your work if you prefer to do so.

Having marked out the dove-tails on one of the faces of *A*, set the piece upright in the vise, and from the ends of the oblique lines

draw fine lines with your square across the ends of the pieces. If the end is rough, you can make these lines clearer by first rubbing some chalk into the end-wood. After these lines are made, draw with the bevel, dovetails on the other face, to correspond with those already drawn on the first.

Next mark out the pin-pieces *B*. The drawing, Fig. 52 *B*, shows that side of *B* on which the pins are narrowest, which is the outside when the piece is in its place in the box. Lay the ends *B* on your bench with the other side, or inside, up, and lay out on *c d* the same distances that you have already marked on *a b*. Be very careful to have these distances exactly equal to those on *a b*. Applying the square to the end of *B*, draw lines through the points thus found, perpendicular to the end. Holding the piece upright in the vise, draw, with the bevel, lines on the end of *B*, corresponding exactly with those on the face of *A*, as in Fig. 52 *D*. Lastly, with the square, draw on the opposite face of *B* the lines perpendicular to the ends as in 52 *B*.

When you have marked out all the pieces,

hold the end-piece *B* upright in the vise, the face *B* being turned towards you. Set *A*

**EXERCISE 32.** on *B*, the end *IV* turned from

**Dove-tailed box.** you, and assure yourself, by careful inspection, that the lines on

the one piece correspond exactly with those on the other, so that there shall be no mistake when you begin to cut the pieces. Inspect the other corners in the same way. Mark the corners that are to go together, I, I; II, II; III, III; IV, IV. Mark the parts that are to be cut out as in Fig. 54. This

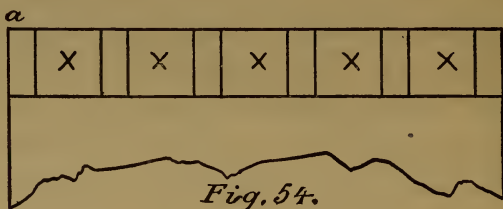

will prevent the mistake, very common with beginners, of cutting out the wrong pieces.

With the fine back-saw, called "dove-tail saw," make all the cuts on the pin pieces, and then all the cuts on the dove-tail pieces, being careful in both cases to cut close up

to the mark, but not beyond it. If this is skillfully done the pieces will fit together without paring. Then, laying the pieces on a clean board on your bench, cut out the waste-pieces as in the last exercise.

The points to be specially attended to are:

Not to cut a wrong piece.

Not to cut beyond the mark.

Not to drive the chisel too far perpendicularly before making an oblique cut (Fig. 51)

Not to cut quite through from one side, but to work from both alternately.

Not to let the corners of the chisel cut into the sides of the pins.

Not to drive the pieces violently together if they fit tight.

When the pieces are put together, every joint should be perfectly close, the ends of each piece should come just even or "flush" with the surface of the next, and the box should be perfectly square at all its corners, perfectly free from winding, and exactly of the proposed dimensions.

[The glue required for the next lesson should be partly prepared during this lesson.]

## LESSON XVIII.

### Gluing.

A BOX properly dove-tailed together would preserve its shape without glue or any other joining material, unless subjected to considerable strain. To hold it in proper shape in spite of strains it must be fastened with glue; and when properly glued it is impossible to get it apart without breaking, except by soaking it in water.

To prepare glue, soak it over-night in enough cold water to cover it, and in the morning cook it gently for an hour or two in the inner bowl of the glue-pot, stirring it from time to time, and taking care that the water in the outer pot does not boil away and allow the glue to burn. When ready for use, the glue, if thoroughly hot, will flow from a stick or brush in a smooth thread, running off pretty freely, but not in drops. It is very important that it should be of



just the right consistency. If too thin, it will soak into the wood without acting as a cement. If too thick, and especially if cold, it will make a jelly-like layer over the wood, preventing the pieces from coming in contact. It is not easy to describe the proper condition of the glue, but when you have seen it a few times you will have no difficulty in recognizing it. It may be remarked that the beginner is in general disposed to use it too thick rather than too thin; at the same time it is unmistakably too thin, if it falls from the brush in drops with the sound of dripping water.

After getting the glue of the proper consistency it is equally important to have it thoroughly hot when used. It is worse than useless to allow yourself to be led by impatience into using the glue before it is just right. Not only must the glue be hot, but the pieces to which it is to be applied must be heated till they are hot to the touch; and the room in which the gluing is done must be warm and free from draughts. No open window must be allowed near work

that is being glued (except in the case of veneering, when heat is supplied in another way). Lastly, the work of gluing must be done quickly, so that the wood and the glue shall have no time to chill, and as much of the glue as possible must be driven out from between the pieces by forcing them close together.

Bearing these particulars in mind you may now proceed to glue your box together. First put it together without glue. Set two hand-

**EXERCISE 33.** screws to a width equal to the  
**Setting** width of the box. The proper  
**hand-screws.** way to open or close a hand-screw, when it requires much change, is to take one of the screw-handles in each hand, hold it with the open jaws towards your face, and then revolve one hand round the other, making the jaws turn quickly between your arms, and being careful of course that they do not hit your face as they turn. After a little practice this becomes very easy, even with rather large screws. After you have thus turned the screw to about the right width, place it, points downward, on the box, which

is resting on the bench, move it along near to one end, but not so near as to rest on the dove-tails, and turn the front screw *A*, Fig. 55,

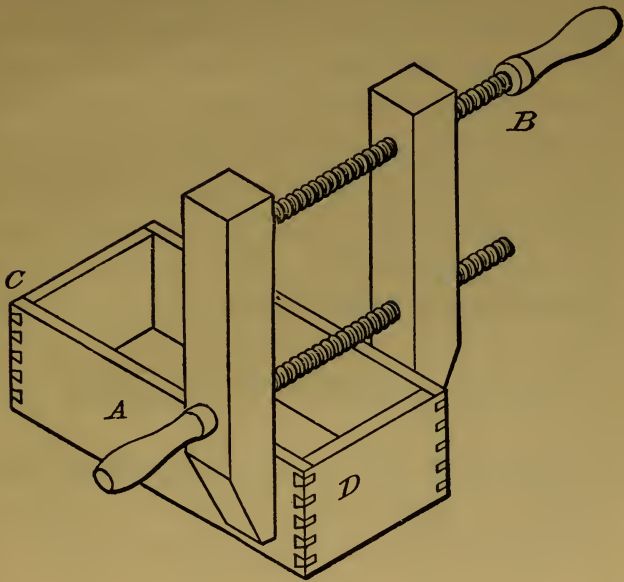

*Fig. 55*

till the jaws touch at the edge *C D*. Then turn the back screw *B*, till they take a firm hold at both edges. Considerable care is required in this operation, to avoid putting too much press-

ure on one part and too little on another. If you tighten the front screw *A* too much, the pressure on the back edge will be excessive when you come to screw up the hinder one. If you do not tighten it enough, the screw will bite at the point and not at the back. If you find your first attempt unsuccessful, you must always loosen the back screw before trying to readjust the front one. When the adjustment is right, the jaws should appear exactly parallel when the screws are well tightened, and should press equally on point

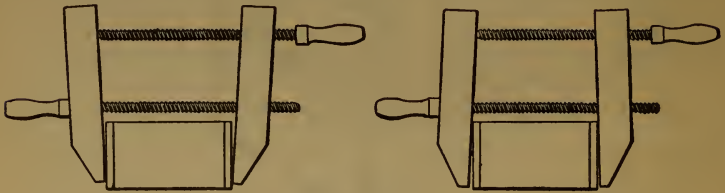
*Fig 56.*

and heel. Either of the positions in Fig. 56 is faulty, and tends to break some of the dove-tails, while leaving others open at the joints.

Having set one screw at each end so that it shall press properly, closing all the joints and leaving the box in good shape, loosen

---

the back screws a little and the front screws still less, only just enough to allow the hand-screws to be taken off easily, and lay them on the bench ready for use. See that the corners of the box are conspicuously numbered so that you can quickly place them together again in their proper order. Place them in front of a fire, or in an oven, or on top of a stove. If the last, they must, if the stove is very hot, be raised a little from the top on small pieces of wood, to prevent them from burning, and in either case should be turned from time to time. When they are well warmed, lay them one on top of another on your bench, in the order in which they are numbered, and, with the least possible loss of time apply the glue. This may be applied with a brush of suitable size, in the following way. First pass the brush crosswise over the wide sides of the pins, not letting the glue run over the ends or backs; enough glue will run in on the inclined faces of the pins, or a little may be rubbed in there with the end of the brush. Next pass the brush crosswise over the

*inside* faces of the dove-tails, allowing a little to run inside, but none on the ends or the

**EXERCISE 34.**

—  
**Gluing.**

out side faces. When the two pieces are driven together, every surface of contact will have glue on it, and all the outside surfaces will be clean. Put them together quickly, driving them close with the mallet or hammer (striking on a strip of wood so as not to bruise them), apply the hand-screws, and tighten them up as they were before. A good deal of glue will be forced out of the joints. This must not be allowed to dry on the wood, as it is very hard to get it off when it is dry. Scrape off most of it with a chisel, without scratching the wood, and wash off the rest with a piece of clean rag or a bunch of shavings wet with hot water.

As success in this, as in all gluing operations, depends greatly on quickness, it will be well, the first time, to rehearse all the movements with a dry brush without glue, and not apply the glue till you are sure you can perform all the movements rapidly and without confusion.

---

If the joints are good and the screws properly applied, the box will preserve its shape. As there is always, however, some risk of distorting it, it is best to examine it carefully as soon as it is screwed up. The hand-screws will prevent you from applying a square, outside, and you will only be able to apply a small one inside, or to test the squareness by the eye, or by measuring the two diagonals, which ought to be equal. The winding may be tested by setting the box on your bench. Any error in squareness or winding must be corrected by loosening the screws, and applying a suitable pressure at once, before the glue sets. After this the screws are to be carefully tightened again, and must not be disturbed for three or four hours, when the glue will be quite dry.

## LESSON XIX.

### Finishing a Dove-Tailed Box.

THE box being glued together is now to have the bottom glued on, the top fastened on with hinges, and the surfaces all finished up true and smooth.

To put on the bottom you must plane up the bottom edges square, smooth, and free from winding. Use the square and the smoothing-plane, and be very careful not to splinter the edges. There is much danger of doing this at the corners. The front and back overlap the ends, so that, while in running the plane along the edge of the front or back you will be planing lengthwise of the grain, at the beginning and end of the stroke you will run crosswise over the end-pieces, and will be very likely to splinter them at the edge. In the same way, in planing along the end-pieces you will be likely to splinter the front and back. The



way to avoid this is, in the first place, to have the plane set fine, and in the next, to change the course of the plane at the corners, so as to work obliquely instead of going square across the grain of either piece.

When you have planed the lower edges true you may glue the bottom on, taking the same precautions as in the last exercise as to the condition of the glue, the heating of the surfaces, the proper manner of applying the hand-screw, and the cleaning off of the glue that flows out. In cases like this, where it is not easy to get at the glue to clean it off, it may be prevented from sticking by rubbing the surface with soap or wax, being very careful to get none on the surfaces which are to be glued together. Moreover, as you cannot easily get at the inside of the box to finish it up after it is put together, all the surfaces must be made smooth and clean before it is glued.

When the glue is dry you may finish the upper edges as you have already finished the lower ones, and make the box of the same height all round, if it is not exactly so already.

Next, finish up the sides, using as before a sharp smoothing-plane. Hold the box in the vise, with one end up, and plane off first the ends of the bottom. In doing this you are planing "end-wood," or cutting across the ends of the fibers, and must be very careful not to splinter the wood at the end of the stroke. To avoid this you must let

**EXERCISE 35.** the stroke extend only half-  
 way across the end, and when  
 Planing  
 end-wood. you have thus cut down one corner of the bottom nearly enough, turn the box round in the vise and plane the other corner, never letting your plane run clear out to the edge. Plane down the other end of the bottom in the same way. As this work is rather hard, you had better, if there is much more than about an eighth of an inch to take off, cut off most of it with the back-saw. After planing off the *ends* of the bottom, plane off the *sides* of the same. The reason for not planing the sides first is, that if you should, in spite of your care, splinter them a little while planing the ends, the defects thus caused could be planed

---

out. If there is much wood to be taken off here, use the jack-plane first, and finish with the smoothing-plane. Here also you must be careful to avoid splintering, not the bottom, but the pins of the end-pieces. Lastly, plane up the four sides with the smoothing-plane, working from the corners *inwards*, and never letting the plane run out. Test for squareness, straightness, and winding as you work, and set the plane very sharp and fine for the finishing strokes.

If there is any glue on the inside, it can be best removed with a chisel when it has got quite hard, provided you have soaped or waxed the surface so that it cannot stick.

## LESSON XX.

### Fitting Hinges.

YOU are now ready to put hinges on your box. Fig. 57 shows a plan and an end elevation of a hinge. When applied to the

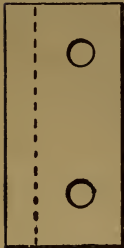
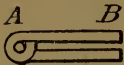

*Fig. 57.*

box the upper half of the hinge is to be sunk into the top, and the lower half into the edge of the back, and both are to be fastened on with screws. Lay the two hinges on the edge of the box where you intend to fasten them, as in Fig. 58, not at the ends, nor yet too near the middle. Mark the length of the hinges on the edge, and with the square draw fine pencil-lines across. Next mark on the edge the width the hinges are to occupy. This is not the full width of the hinges, but only the distance from the center of the pin to the edge of the hinge, because, when the

hinge is fastened on, it and the box should appear as in Fig. 59, the center of the pin falling exactly at the corners of the two pieces. With the gauge set to this width, mark the width of the hinge, making only a light scratch, and extending it only the length of the hinge. Hold the top against the

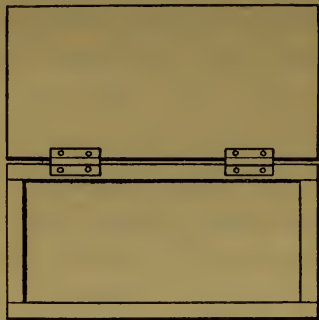

*Fig. 58.*

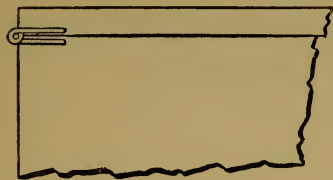

*Fig. 59.*

back, as in Fig. 58, without the hinges, and transfer the four cross-marks to the top, and then, with the square, mark the length of the hinges, and with the gauge mark their width, just as on the edge.

Next, mark the depth to which the hinges are to be sunk. In order that they may let the top close properly, they must be let in exactly half

their thickness into each part of the box. If you place your gauge, therefore, against the face *A B*, Fig. 57, and set it so that the point reaches exactly to the middle of the pin, this will show how deep the hinge is to be let in. With the gauge thus set mark the back, and the edge of the top.

All being properly marked out, lay the top on your bench, and cut out the pieces to

**EXERCISE 36.** make room for the hinges. This

**Fitting hinges.** operation is exactly the same as that of cutting a mortise, except that the cut is a very shallow one, and you will have to be careful not to go too deep.

Place the chisel near one end of the cut and drive it in, nearly to the depth marked. Make a series of similar cuts about  $\frac{1}{8}$ " apart along the length of the hinge. This breaks up the wood so that, holding the box in the vise, you can easily, by cutting across the grain, pare away the wood down to the mark. Then, laying the piece on the bench again, finish cutting away the little that has been left on the three sides of the spaces, till the

hinges exactly fit. Fit them into the top in the same way.

Now put the hinges in place, without screws, lay the top on, and see whether they are let in deep enough. If not, carefully cut away enough wood to let them into their proper places. If you should happen to cut away too much (which you ought not to do) you must glue a piece of card-board or shaving under the hinge to bring it up. Also, open the top, put the hinges in place, as in Fig. 58, and see whether the back edge of the top just touches the edge of the back all along. If all these adjustments are correctly made, you may make a small hole with an awl exactly in the middle of each of the holes in the hinges, and put in the screws with your small screw-driver, being careful, before using any screw on the top, to assure yourself that it is not so long as to go through.

With all the care you can take in putting on hinges, several faults are likely to occur.

1. If the hinges are not let in deep enough the top will not shut close at the back.

2. If they are let in too deep, the top will

not close at the front, or, if it is forced shut, a strain will be thrown on the hinges, and the screws will be pulled out.

3. If the space cut out is too narrow, the hinges will stand out too far, giving an ugly appearance, and leaving an unnecessary gap between the top and the back when the box is opened.

4. If too wide a space is cut out, letting the hinges in beyond the center of the pin, the corner of the top will press against the corner of the back as soon as the top begins to rise, and opening the top will force off the hinges.

5. If the width allowed for one hinge is greater than that allowed for the other, the top will not shut down square over the box, but will stand out, at the front, more on one side than on the other.

The cause of any of these faults being understood, it is easy to apply the remedy. Taking out the screws, you must set the hinges deeper, or put something under them, or set one or both farther in or farther out. Either of the above changes will oblige you



to make new holes for the screws, so that they may push the hinges in the proper direction. Before doing this, the old holes must be plugged up with small sticks whittled to the proper size and fastened in with glue.

After the top is hinged at one edge, the other three edges are to be finished, the ends first and then the front, with the same precautions that were used in finishing the bottom.

A small brass hook-and-eye may be put on, to keep the box shut. This operation will need no explanation.

## LESSON XXI.

Making a paneled Door. — Isometric  
Drawing.

IN Lesson XIII you planed up the sides of your box and put them away; and when you took them out again you found that they had shrunk in width though not in length, and you measured the amount of the shrinkage. You found also that some of the pieces had checked, and some had warped. When large pieces of wood are used, shrinkage, warping, and checking give rise to serious trouble. Thus, in a door 30 inches wide shrinkage may amount to half an inch or more, and warping to an inch, and long and wide cracks are almost sure to appear. Moreover, the shrinking does not take place once for all, and then come to an end, but the wood having once shrunk may swell again, and shrink again, and so on repeatedly. Doors that are exposed to the dry air of

houses which are heated in winter become very loose, but sometimes swell up in summer so much as to stick. The shrinkage will be less if the wood has been thoroughly seasoned, but the swelling in damp weather can hardly be prevented.

Doors are therefore never made in one piece, but are always constructed of parts, so arranged as to reduce as much as possible the bad effects of these changes. There are two principal methods of construction by which this is accomplished. The first is the battened door and the second the paneled door. The battened door is made of strips, Fig. 60,

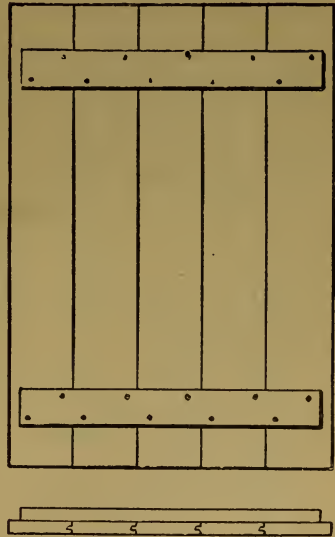

*Fig. 60.*

running lengthwise of the door and held together by cross-strips or battens, fastened

on with screws or nails. As the wood shrinks only in width and not in length, the shrinking of the strips will only cause the edges to

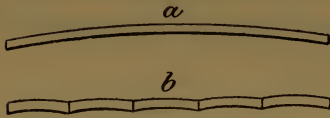

*Fig. 61.*

separate a little, and will produce scarcely any change in the width of the door. The warping, also, in this case, will be

small in amount. While a piece the whole width of the door might warp, as at *a*, Fig. 61, a battened door would appear as at *b*. The separating of the strips, leaving cracks in the door, is prevented by using "matched" boards, or "tongue and groove" joints, as shown in the plan Fig. 60, or on a larger scale in Fig.

62. In this case the tongues slip partly out



*Fig. 62.*

of the grooves when the wood shrinks, but do not leave the joints open. This construction is simple and effective, and is much used where fine workmanship and

handsome appearance are not important, as in the doors of barns and outhouses. For dwelling-houses and in cabinet-work the paneled door is used. This is a frame-work mortised together at the corners, and grooved all round on the inner edge to receive a thin piece called the panel, as shown in Fig. 63. The shrinking of the panel only causes it to slip in the groove.

As the cross-pieces at the top and bottom undergo no change in length, the only alteration in width that the door will suffer is the slight one due to the shrinking in the

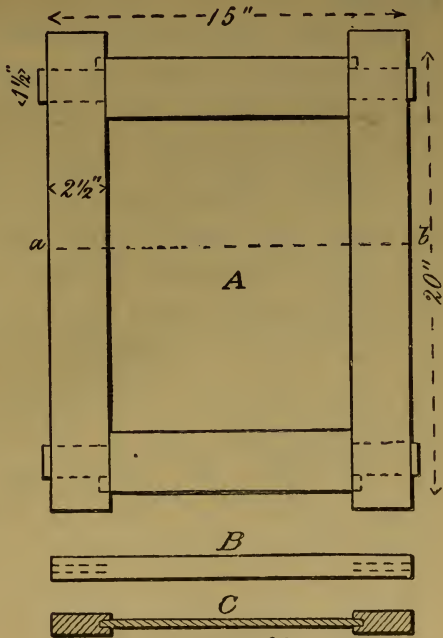
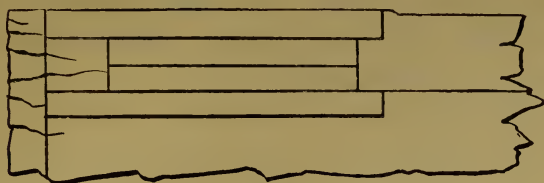

Fig. 63.

width of the two upright pieces. We will proceed to make such a door from the figured sketch, in which *A* shows the elevation, *B* the plan, and *C* a section on the line *ab*.

The first step is to get out the material. This consists of the top and bottom pieces, called the rails, the upright sides, called stiles, and the thin central piece or panel. Take the dimensions of these from the drawing, and mark them out on boards of the proper thickness, being careful to allow for the saw-kerf and for the material which will be wasted in planing up the pieces to the true shape and dimensions. Furthermore, as the mortises will be very near the ends of the stiles, the latter may be cut  $1\frac{1}{2}$ " longer than the door, so that they may project  $\frac{3}{4}$ " at each end, as in the Figure, and the tenon-pieces, or rails, may be made 1" longer than the width of the door, so that the tenons may project  $\frac{1}{2}$ " beyond the stiles till all is finished, after which the projecting parts can be cut off. The rails, therefore, will be cut out 16" long and the stiles  $21\frac{1}{2}$ " long.

In laying out the frame, try, as in Lesson VIII. to avoid knots and cracks, and at the same time to waste as little wood as possible. The four pieces may be laid out in one way or another, according to the character of the wood from which they are to be cut. If the board were much checked at the end, as in Fig. 64, you should cut off



*Fig. 64.*

just enough to remove the short cracks, and might then lay out the work so that the long cracks which remain should lie in



*Fig. 65.*

the waste-wood left at the ends of the short pieces. If there were a bad knot at *a*, Fig. 65, this might be made to fall in the waste-

wood between the rails and the stiles; and so on, according to the position and character of the defects.

The frame-pieces being cut out, they are to be finished to exact dimensions and true surfaces as in previous lessons. The joints are then to be marked out with gauge, square, and pencil, making all gauge and square marks from the front surface and inner edge of the pieces, which must be marked to distinguish them.

The laying out of the joint in this exercise is complicated by two circumstances. The first of these is that the tenon must be made of less width than the full width of the rail, in order that the mortise may not run out quite to the end of the stile. The second is, that a groove is to be cut in the inner edge of the four pieces, and this groove, unless a special arrangement is made to prevent it, will leave a hole between the end of the stile and the shoulder of the mortise, as shown in the sketch of one joint at *a*, Fig. 66. To prevent this, a projecting stud, or tooth, is left on the



tenon-piece, as shown in plan and elevation at *a* and *b*, Fig. 67.

This construction, and the method of laying it out, may be better understood by the help of another kind of drawing called Isometric Projection, the elements of which can be easily understood.



*Fig. 66.*

The elevations and plans that we have hitherto used are projections on planes parallel to the front, bottom, and sides of the object; that is to say, they are views taken from a point at a great distance in front of the object, above it, or to one side of it.

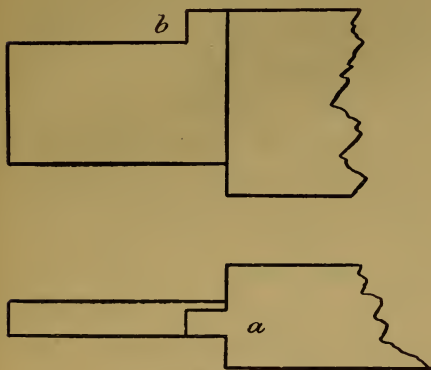

*Fig. 67.*

The eye being at a very great distance from the object, if a plane be placed parallel to

the face of the object, the lines drawn from all points of the object to the eye are perpendicular to the plane. If lines are thus drawn from all points on the edges and other lines of the object, they cut the plane in a number of lines which make up what is called the projection of the object. The elevations and plan already drawn are such

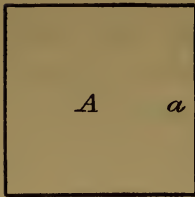

*Fig. 68.*

projections, and are called right projections. If we take our point of view not exactly in front of the object, but a little to one side, or if, which is the same thing, we turn the object so that its front is not parallel to the plane of projection, the appearance of the object is changed, and the projection is called an oblique projection. The front of the object appears narrower, and the side, which was invisible before, comes into view. Suppose, for instance, the object were a cube, of which the plan is *A*, Fig. 68. Then, on the plane

of projection, the front of it appears as a square, in the elevation *B*, and the side *a* is not seen at all in this elevation. But, if the cube be turned round to the position *C*, Fig. 69,

the front face will appear narrowed, or "foreshortened" to the width *bc*, and the right-hand face will come into view and will have the apparent breadth *cd*.

The elevation, therefore, will now present the appearance shown in *D*, Fig. 69, where *bcfg* represents one of the visible faces of the cube, *cdhf* another, and *edhi* and *beig* the two invisible or rear faces.

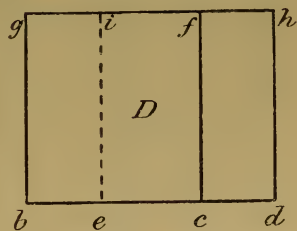
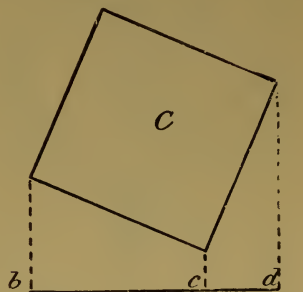
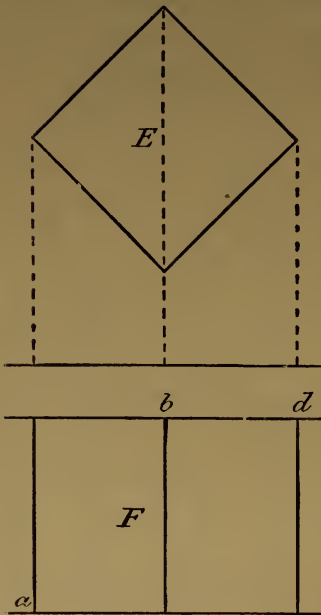

Fig. 69.

If we take the point of view still farther to the right, or turn the object farther round, the front becomes apparently narrower, the right face wider, and the two appear presently of equal width.

This happens when the square  $C$ , Fig. 69, has been turned so that its diagonal is perpendicular to the plane of projection, as at  $E$ , Fig.

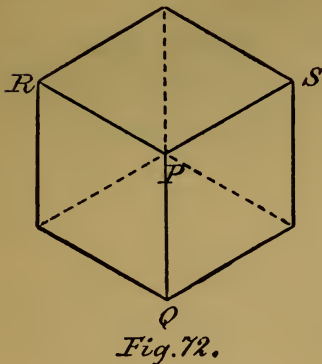
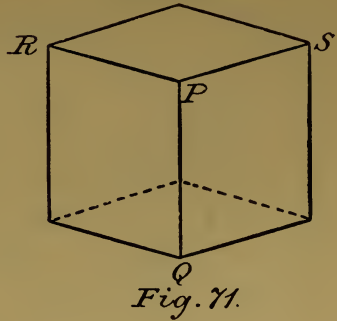

*Fig. 70.*

70. The elevation then appears as at  $F$ , in which  $a b$  and  $c d$  represent the faces of the cube, and appear of equal width. If, now, we take our point of view not only to the right of the object, but also higher, the vertical lines will be foreshortened also, the upper surface will come into view, and the cube will appear as in Fig. 71. If the point of view be taken still higher, the edge  $P Q$

will be made to appear of the same length as  $P R$  and  $P S$ , Fig. 72. All dimensions which are parallel to either edge are then equally foreshortened, and the drawing is

called an isometric drawing or isometric projection. The dotted lines in Fig. 72 show the edges of the cube that are concealed. The drawing of a cube on this system is thus seen to be extremely simple: that of a body with unequal dimensions is not difficult, provided its faces are perpendicular to each other. Thus, if it is required to represent



a body of this shape whose length, breadth, and thickness are respectively 3", 2", and 1", we have only to draw three lines  $PQ$ ,  $PR$ , and  $PS$ , Fig. 73, making equal angles with each other, and to lay off on the one three units of length,

on the second two equal units, and on the third one of the same units, and complete

the drawing as in the figure. The drawing of the three lines, or "axes"  $PQ$ ,  $PR$ , and  $PS$  is easily accomplished, as in Fig. 74.

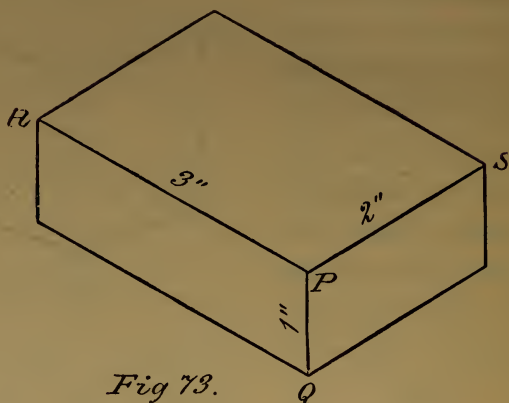
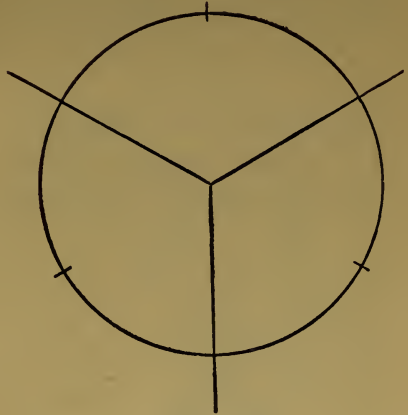

*Fig 73.*

Draw a circle with any radius. From the highest point on the circumference lay off the radius six times, and through the alternate points draw the three axes. To secure accuracy the radius should be taken at least as long as the longest line in the drawing.

It will be well, now, to make a few isometric drawings of simple objects, such as the box of Lesson XX., the through mortise of Lesson XV, and the end dove-tail of Lesson XVI., to accustom the eye to the "reading" of

such drawings. It will be readily seen by those who understand ordinary perspective drawings, that isometric drawings differ from these only in giving the true dimensions of the remote as well as of those of the near parts, while perspective drawings make the parts that are farther away appear smaller, and therefore a scale cannot be applied to them.

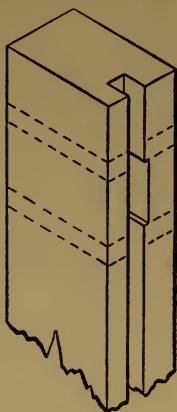

*Fig. 74.*

## LESSON XXII.

### Paneled Door Continued.

FIG. 75 is an isometric drawing of a part of one of the stiles of the door, showing the mortise and the groove, and Fig. 76 is a



*Fig. 75.*

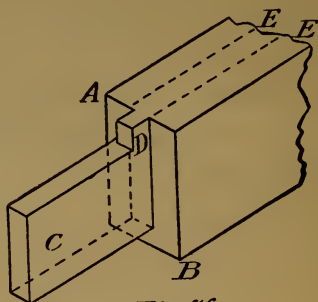

*Fig. 76.*

similar drawing of the end of the rail or tenon-piece, turned round so that the shoulder *A B* is towards you, and the tenon *C* and the stud *D* are visible. From these drawings you will



be able to understand the way of marking out this joint.

As the tenons are to project half an inch beyond the stiles, and as these are  $2\frac{1}{2}$ " wide,

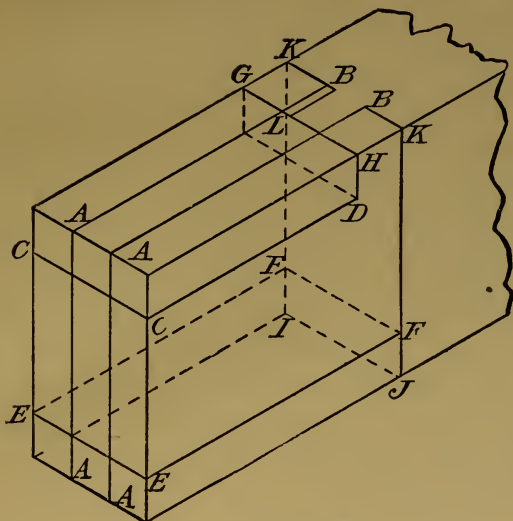

*Fig. 77.*

a mark is to be made first, all around each rail 3" from the end, and a second mark 10" from this, which will be 3" from the other end. These are the marks at *A B*, Fig. 76, which show the shoulder of the tenon.

They should be interrupted on the outer edge at the middle, as at *D*, so as to prevent the

**EXERCISE 37.** mistake of cutting across the

**The paneled** stud when you begin to saw.

**Door.**

Next the thickness of the tenon is to be marked with the gauge on the edges and ends of the rails as at *E*, always working from the front face. Then the breadth of the tenon is to be marked by drawing, with the gauge, lines  $\frac{1}{2}$ " and 2" from the inner edge, being careful not to extend them beyond the cross lines at *D* and *F*. Lastly, the length of the stud *D* is to be marked with the square, and its breadth with the gauge. The marking will then appear as in Fig. 77. The marking out of the mortise is simpler, and is shown in Fig. 78. Light marks *P Q* may be made  $3\frac{1}{4}$ " from the ends of the stiles, which will be 15" apart, and will indicate the positions of the inner edges of the rails, or the inside length of the frame. Marks *R S*  $2\frac{1}{2}$ " from these will indicate the outside length of the frame. These should both be drawn light, as no cutting is to be done on either of them. They may indeed be omitted,

though they serve as a useful check to prevent mistakes in laying out the rest. Marks on the inner and outer edges,  $\frac{1}{2}$ " and 2" from  $PQ$  will show the length of the mortise; and gauge marks with the gauge set exactly as in drawing  $A B$ , Fig. 77, and measured from the front face, will show the width of the mortise.

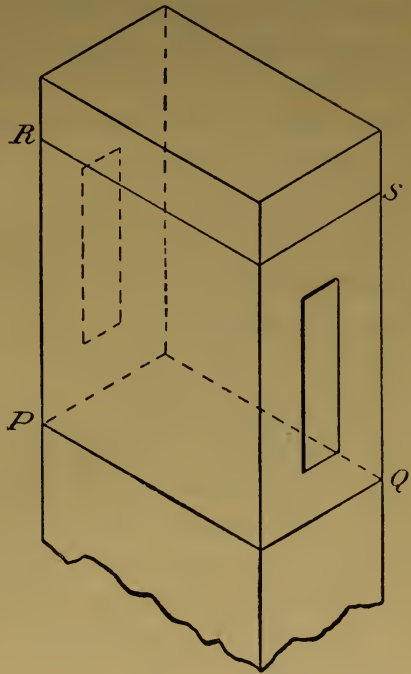

*Fig. 78.*

The marking will appear as in Fig. 78, in which the dotted lines are on the rear faces. The groove for the panel is not shown in these figures. It appears in Fig. 75; and the method of marking it out and cutting it will be shown in the next Lesson.

The marking being now finished, the cutting out proceeds as follows: With the back-saw cut first the lines *A B*, Fig. 77, then the lines *C D* and *E F*, observing that *C D* must not be cut so deep as *E F*, in order to leave the stud *L B* uninjured. Next make the cross-cuts *G H*, *I J*, *I K*, and *J K*, being careful not to cut too deep. The side pieces will then fall off, leaving the tenon complete, except the stud *L B*. The stud is still of the same thickness as the tenon, and must be pared down to the proper thickness with the chisel, by taking off  $\frac{1}{8}$ " from its back face, as shown in Fig. 77 and in Fig. 67 *a*. The tenon, also, will need some paring, if you have not cut exactly to the marks with the saw; but you must not in any case cut beyond the middle of the mark.

The mortise may be cut with the center-bit and chisel in the same way as in Lesson XV., page 89, or with the chisel alone. The breadth of the mortise being small and its depth considerable, the bit will be apt to mar the sides of the cut, unless it is held exactly perpendicular to the face of the piece and

kept very steady. For this reason, and for the sake of practicing the other method, we will cut out this mortise with the chisel alone.

Lay the piece on your bench, with the edge up. To steady it, you may first lay a

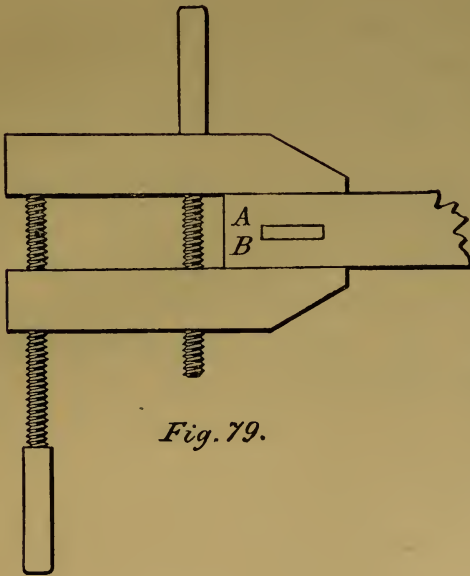

*Fig. 79.*

hand-screw on the bench, then set the piece in it and tighten the screw, as in Fig. 79. With alternate perpendicular and oblique

cuts, as described on page 116, cut the mortise half-way through the piece. Then turn the piece over and cut in the same way from the other side. When the two cuts meet, the four surfaces are to be pared to the marks, using a wide chisel for the sides, and being careful not to cut away anywhere more than half the width of each mark. If the paring of both pieces has been properly done, the tenon will fit closely in the mortise. If it fits so tightly that there is danger of splitting the mortise-piece, it must be carefully pared away a little more. The tenon cannot be driven quite "home," being stopped by the stud. Room will be made for this by cutting the groove, which is the next operation.

## LESSON XXIII.

### The Plow.—Fitting a Panel.

THE tool used for this purpose is a kind of plane called a plow. Its mode of action will be understood after an examination of the accompanying Figure and of the tool itself.

The iron *d*, Fig. 80, cuts the groove. The "fence" *b* determines the distance of the groove from the face of the piece. It can be set at any distance from the iron by means of the screws *c*. The stop *a*, which can be raised or lowered by the screw *e*, regulates the depth of the cut. For this exercise it must be set at  $\frac{1}{2}$ " , and the fence must be set so that the groove shall be  $\frac{1}{2}$ " from the face of the frame. Before venturing to use the plow on your frame, you should try it on a waste-piece, and assure yourself that you can cut a smooth, clean groove at the proper distance from the face of the

frame and to the required depth. The plow has an assortment of irons, or "bits," of

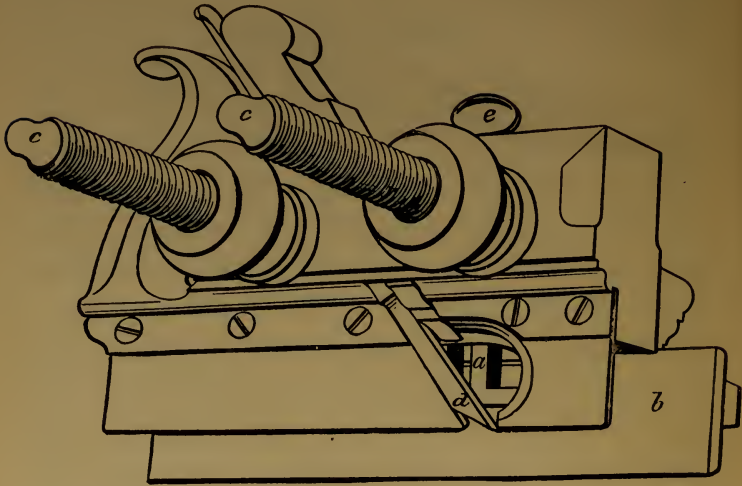

*Fig. 80.*

different sizes for cutting grooves of different widths. For this exercise the  $\frac{3}{8}$ " iron will be

**EXERCISE 38.** used. Remember that the plow

**Grooving.** is to be placed against the *front* surface of each piece. If this precaution is neglected, the grooves in the several pieces will probably not match at the corners, and the panel cannot be got in. The grooves must not be planed beyond the depth indicated,



for if cut too deep they will weaken the pieces too much. The grooves being cut, the studs which have been left to fill them will go into their places, and all the joints should fit quite close. If too much wood has been left anywhere it may be carefully pared away; if too much has been cut off there is no remedy.

To prepare the panel, first plane it to the proper thickness, and finish it with the smoothing-plane. Then plane two edges straight and perpendicular to each other, being careful, in planing the end, to avoid splintering, as directed in Lesson XIX., page 138. Then cut the piece to the proper length and breadth, remembering that these are not the length and breadth of the inside of the panel, but 1" more, on account of the depth of the groove.

The panel is next to be fitted to the groove by chamfering. Mark the width of the chamfer (1") all round the face with a lead-pencil, or *very lightly* with the gauge, and the depth ( $\frac{1}{4}$ ") on the edge in the same way. Lay the piece on the bench, its edge

being just even with the edge of the bench, fasten it down with a hand-screw, and plane the chamfer carefully to the mark all round,

**EXERCISE 39.** again being careful to avoid **Fitting a panel.** splintering. If this is properly done, the panel will have a thickness of  $\frac{3}{8}$ " at a distance of half an inch from the edge, and will just fit in the groove as shown in Fig. 81.

In this Figure, the shading, which has been introduced once



*Fig. 81.*

before in Fig. 63, *c*, indicates a cross-section, fine ruled lines being generally used for metal, and somewhat coarser free-hand lines for wood. Do not drive the panel in if it fits tight, but ease it carefully till it enters freely without looseness. The flat side is to be turned towards the front of the frame.

The frame of the door has been made thicker than it ought to be, in order to lessen the risk of splitting the stiles while making the mortises. It may now be taken apart and

finished to a proper thickness. This is not the course that a skilled workman would take, nor that which you will follow hereafter in such cases. Setting your gauge at  $\frac{1}{4}$ " , make a mark on both edges of each piece at that distance from the front. Then, setting it at  $1\frac{5}{16}$ " , make a second mark at this distance from the front. Plane the faces exactly to these marks. The thickness of the frame will then be reduced to  $1\frac{1}{16}$ " , and the groove will be  $\frac{1}{4}$ " , from the front, and  $\frac{5}{16}$ " from the back, the latter distance being left larger because the chamfer brings the back surface of the panel nearer to the surface of the frame than the front, as shown in Fig. 81.

## LESSON XXIV.

Chamfering. — Sand-Paper. — Shellac.

THE door may now be glued together and afterwards finished up with the smoothing-plane, or the front inner edges of the frame may be chamfered first. Fig. 82 shows how the chamfer is to be laid out. The line  $AB$  is drawn with a sharp pencil on the front of each piece, at a distance of  $\frac{3}{16}$ " from the inner edge, and the line  $CD$  on this inner edge at the same distance from the front. The pencil is used in preference to the gauge, because, unless the latter is used very lightly and skillfully, its mark is apt to show on the finished work.

The chamfer may be terminated at each end by a simple inclined cut, as at  $A$  and  $C$ , Fig. 82, or by an ogee, as at  $B$  and  $D$ . For the former, mark the point  $a$   $\frac{3}{4}$ " from  $O$  the inner corner of the frame,  $A$  and  $C$  one inch from  $O$ , and corresponding points at the

other end of the piece. For the latter, mark  $a$  as before, and  $B$  and  $D$   $1\frac{1}{2}$ " from  $O$ .

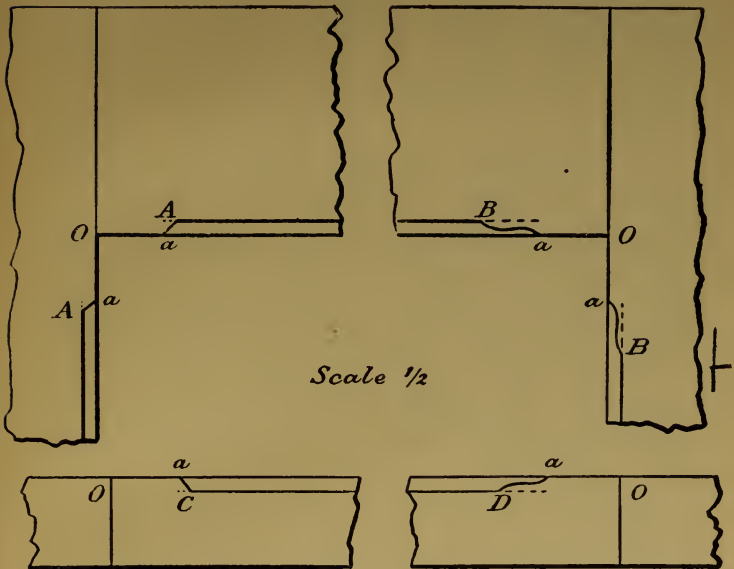

*Fig. 82.*

To cut the chamfer. First with the beveled end. Hold the piece in your vice; set the chisel near  $a$ , the flat side towards  $O$ , and make an inclined cut extending nearly down to the ruled line, and throwing up a chip. Turning the chisel round, set it about  $\frac{1}{8}$ " be-

**EXERCISE 40.**

**Chamfering a frame.**

yond *A* or *C*, and cut out the chip, leaving a notch. Cut again, with the chisel close to *a*, making as clean a cut as you can, and being very careful not to let the chisel go even a little beyond the ruled line *A B*, because, if it does so, a mark will be left on the chamfered surface which you cannot remove. Having made such a notch at each end of the chamfer, you may score the edge not quite down to the two marks, and pare it down, making a plane surface inclined to the face. You will find that it is not easy to make this surface perfectly true. The points to be attended to in order to secure good results are:

1. To keep the chisel very sharp, and in particular, not to let it get in the least degree round on the back.

2. To give it constantly the sliding movement which prevents it from following the grain of the wood.

3. As you get nearly down to the required depth of the chamfer, to keep the back of the chisel lying quite flat on the surface, so that it shall act as a plane, removing all irregularities.

4. To take care, while cutting either the inclined end of the chamfer, or the long plane surface, to make no mark on the other surface, but to make the two surfaces meet in a perfectly sharp and smooth line, perpendicular to the edge.

You see that it is impossible from the nature of the chamfer, to finish it up with the plane, and that it requires, therefore, excellent work with the chisel. If the chamfer is several feet long, the smoothing-plane can be used in the middle of it, but even then the ends have to be finished with the chisel. Fine sand-paper is sometimes used in finishing up such a surface, a **EXERCISE 41.** piece of it being held on a block **Sand-papering.** of wood and rubbed to and fro, taking great care not to allow any rocking motion of the block, as this would give a rounded surface instead of a plane one, nor to leave the paper loose on the block, in which case it will wrap round the corner of the work and produce the same result. Even with the utmost care that can be taken, the sand-paper is almost certain to take off the sharp corners

that characterize good work, and should not be used, unless, as in this case, a very fine shaving can afterwards be taken off with the smoothing-plane from the adjacent face, to restore the sharpness of the edge.

The ogee end of the chamfer is more difficult than the plane end. The curved surface to be formed is concave at *a*, Fig. 83, and convex

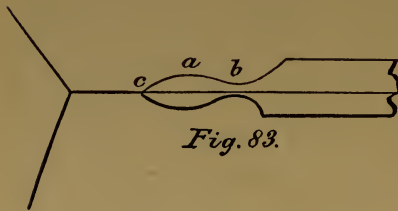

Fig. 83.

at *b*. The part *a* should be cut first. The chisel is set with the handle towards the left in the Figure, and the

*bevel* side towards the wood, a little to the left of *a*, and a small cut made. Then it is turned with the handle towards the right, the *bevel* still towards the wood, and the chip cut out. These operations are repeated, gradually widening the cut, till the hollow has the proper size. As the cut is most inclined at the beginning of the hollow and level at the bottom, the handle of the chisel must be depressed as you approach the bot-



---

tom, and care must be taken to prevent the tool from making a mark on the opposite side of the hollow. The convex surface *b* is cut with the back of the chisel towards the wood, as in cutting the plane surface, and is comparatively easy to form. The entire curved surface, like the plane surface of the chamfer, ought to be formed with the chisel alone. If you fail to get it smooth with the chisel, you may use a piece of very fine sand-paper (No. 0) in the following way: Prepare a stick,  $\frac{1}{2}'' \times \frac{1}{4}'' - 5''$ . Cut one of the flat faces with your knife or your chisel, to such a curvature that it will nearly fit the hollow, touching at the bottom, but not at the sides. Glue a piece of sand-paper on this, and use it as a file to smooth the hollow. Even with this there is danger of your rounding the surface, and particularly of spoiling the sharp point of junction at *c*, between the ogee and the straight edge of your piece. You will do best, therefore, to endeavor to avoid the use of sand-paper in such cases as this, regarding it as the resource of an unskillful

workman. This, however, is not to be understood as condemning the proper use of it on broad surfaces to give a smooth finish, when there are no corners that are likely to be injured by it.

The chamfered edges being now finished, you may pass the smoothing-plane, set very fine, once over the inner edge of the pieces of the frame, and over the surfaces of the panel, before gluing them together. The other surfaces can be finished afterwards.

The panel is not to be glued into its groove, but left free, so that it can shrink without splitting. It will even be best to rub some soap or wax on the corners, to prevent its being accidentally stuck by the glue which will squeeze out of the joints.

If you have no hand-screws large enough to span the width of the frame, you may proceed, in this and similar cases, as follows: Provide two strips of board, *A* and *B*, Fig. 84, three or four inches wide, and as long as the inside of your frame. Fasten them down on your bench parallel to each other with hand-screws, so that the door will lie

between them, with about an inch to spare. Lay two pairs of wedges in the open space, as at *c* and *d*. By driving the inner wedges outward you can force the stiles up close against the shoulders of the tenons. In putting the frame together, insert first two tenons into one stile

**EXERCISE 42.**

Gluing up a panel frame.

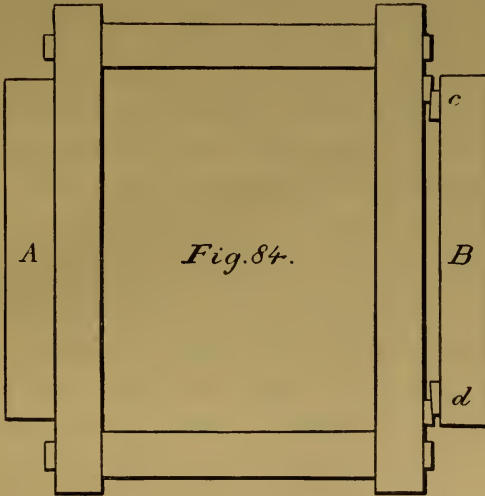

and drive them home; then put in the panel, and lastly put on the other stile and drive it up tight. Put no glue on the inner edge of the tenon, as whatever is put on here will be

driven out into the grooves and will tend to fasten the panel. Test the frame for squareness, and correct any error, before allowing the glue to set, by gentle strokes of the hammer on the proper corners, protecting the edge with a block of wood when you strike it.

When all is dry, cut off the projecting ends with the back-saw, being careful not to cut too close, or you will deface the outer edge of the frame. Finish up with the smoothing-plane, observing the precautions indicated in Lesson XIX., page 138, to avoid splintering.

The surfaces of the door may be finished with shellac varnish, which consists of white shellac dissolved in alcohol. This will protect it in part from the effects of moisture,

**EXERCISE 43.** and will allow it to be cleaned  
 from time to time. Sand-paper  
**Finishing with** all broad surfaces and wipe them  
**shellac.** clear of dust with a clean rag. Then, in  
 a warm room, free from dust, apply with a  
 flat brush, one coat of varnish, and let it  
 dry. Do not pass the brush over the varnish  
 oftener than is necessary to spread it smooth.  
 Passing the brush over it when it is begin-

---

ing to "set," or dry, breaks up the smooth surface that it would form if left to itself. Do not put on too much at a time; it will flow down the sides and form "runs," which it is hard to remove. When the first coat is thoroughly dry, which should be in a quarter of an hour, it may be rubbed down with fine sand-paper, on a block, taking great care to do no injury to the corners, and a second coat applied.

If you have determined in advance to finish the work with shellac, it will be best to finish the panel and the inner edges of the frame before gluing. In this case, however, you must be careful to clean off with warm water any glue that may get on the finished surfaces, before it hardens, as, after it is hard it will take off the varnish with it. All the other surfaces should be finished after gluing.



## ALPHABETICAL INDEX.

---

	PAGE
Accidents with tools, prevention of . . . . .	3
Ax ; <i>See</i> Hatchet	
Awl . . . . .	143
Back-saw, use of in cross-cutting and ripping . . . . .	115
Battened door . . . . .	147
Bench-dog . . . . .	79
Bench-hook . . . . .	63
Bevel . . . . .	123
Boring . . . . .	105
Box, nailing together . . . . .	52
Box, dove-tailed . . . . .	119
Brace . . . . .	105
Brad-awl . . . . .	143
Broken lines in drawings, meaning of . . . . .	2
Cap of plane . . . . .	60
Center-bit . . . . .	105
Chamfering . . . . .	101, 169, 172
Checks ; <i>See</i> Cracking	
Chisel, form of . . . . .	85
"    grinding . . . . .	94
"    paring with . . . . .	88

	PAGE
Chisel, manner of holding . . . . .	87, 88, 92, 95
“ sliding movement of . . . . .	90
“ sharpening . . . . .	92
Cracking of timber . . . . .	29, 31
Cross-cutting with hatchet . . . . .	6
“ “ “ knife . . . . .	2
“ “ “ saw . . . . .	23
Door, battened . . . . .	147
“ paneled . . . . .	149
“ prevention of effect of shrinkage . . . . .	146
Dove-tail, end . . . . .	111
Dove-tailed box . . . . .	119
Dove-tailing, points to be attended to in . . . . .	127
Dowels . . . . .	28
Drawings, scale of; working . . . . .	38
“ details . . . . .	34, 41
“ isometric projection . . . . .	153
“ meaning of broken lines . . . . .	2
“ working sketches . . . . .	36
“ sections . . . . .	41, 150
“ shading to indicate sections . . . . .	170
End-wood, planing . . . . .	138
Fibers of wood . . . . .	15
Gauge, use of . . . . .	74
Glue, cleaning off . . . . .	134, 135
“ preparation of . . . . .	128
“ to prevent from sticking . . . . .	137
Gluing . . . . .	128
Gluing, warming the work for . . . . .	133



	PAGE
Grain of wood, working against the . . . . .	66
Grinding chisels and planes . . . . .	95
Hammer, striking with . . . . .	49
Hand-screws, adjustment and use of . . . . .	130, 132
Hatchet or ax, cross-cutting with . . . . .	6
"    "    hewing with . . . . .	13
"    "    splitting with . . . . .	8
Hewing with hatchet . . . . .	13
Hinges, fitting of . . . . .	140
"    points to be attended to in . . . . .	143
Hook and screw-eye for box . . . . .	145
Isometric drawing . . . . .	153
Knife, cross-cutting with . . . . .	1
"    splitting with . . . . .	7
"    whittling or paring with . . . . .	11
Laying out dove-tails . . . . .	123
"    "    end dove-tails . . . . .	112
"    "    mortise and tenon . . . . .	105
"    "    paneled door . . . . .	162
"    "    work; avoiding knots and cracks . . . . .	48, 151
Mallet . . . . .	102
Marking with square . . . . .	24
"    "    gauge . . . . .	74
Materials required . . . . .	vii
Metric measures . . . . .	104
Mortise-cutting with center-bit . . . . .	106
"    "    without center-bit . . . . .	116, 164
"    and tenon . . . . .	103, 160
Nailed box . . . . .	52

	PAGE
Nails, drawing . . . . .	56
“ form of . . . . .	50
Nails, four-penny, etc. . . . .	49
“ right and wrong driving of . . . . .	51
Ogee end of chamfer . . . . .	176
Oil-stone . . . . .	86, 92
Paneled door . . . . .	146
Paneled door, chamfering the frame of . . . . .	172
“ “ “ panel of . . . . .	169
“ cutting mortises and tenons for . . . . .	164
“ finishing up . . . . .	178
“ gluing . . . . .	177
“ grooving for . . . . .	168
“ laying out . . . . .	162
Paring with chisel across the grain . . . . .	101
“ “ “ with the grain . . . . .	87
“ “ knife . . . . .	11
Pine-wood . . . . .	96
Plane, fore . . . . .	70
“ jack . . . . .	58
“ manner of holding . . . . .	63
“ mode of action of . . . . .	59, 61
“ principal points in using . . . . .	64
“ smoothing . . . . .	69
Planing an edge . . . . .	76
Planing end-wood . . . . .	138, 139
“ to thickness . . . . .	76
Plane-irons . . . . .	59
Plane-iron, adjustment of . . . . .	60

	PAGE
Plow . . . . .	167
Sand-paper . . . . .	175, 177
Saw, back . . . . .	78, 115
Saw, cross-cut . . . . .	21
"    dove-tail . . . . .	79, 126
Saw-kerf, allowance for . . . . .	45
Saw, rip . . . . .	83
"    tenon . . . . .	78
Scale of drawings . . . . .	38
Scoring with knife or hatchet . . . . .	11
Screw-driver . . . . .	143
Sharpening tools . . . . .	92
Shellac varnish . . . . .	180
Shrinkage and warping, effect of, on doors . . . . .	146
Shrinkage of wood . . . . .	28
Sliding movements of cutting tools . . . . .	4
Splitting with hatchet . . . . .	8
"    "    knife . . . . .	7
Square . . . . .	24
Standard edge or surface . . . . .	45, 72
Straight-edge . . . . .	55
Testing-machine . . . . .	18
Timber; <i>See</i> Wood	
Tools required, list of . . . . .	vii
Warping of wood . . . . .	30
White-wood . . . . .	69
Whittling; <i>See</i> Paring	
Winding . . . . .	55
Winding, removal of . . . . .	71

	PAGE
Winding-sticks . . . . .	55
Wood, fibers of . . . . .	15
" shrinking, cracking and warping of . . .	29, 30
" strength of . . . . .	18
Wood, structure of . . . . .	15, 16
Working drawings . . . . .	38
" sketches . . . . .	36

















LIBRARY OF CONGRESS



0 013 824 699 1 ●